

The influence of fatigue on kinematic parameters of basketball fundamental skills - passing, shooting and dribbling

Li, Feng

Doctoral thesis / Disertacija

2022

Degree Grantor / Ustanova koja je dodijelila akademski / stručni stupanj: **University of Zagreb, Faculty of Kinesiology / Sveučilište u Zagrebu, Kineziološki fakultet**

Permanent link / Trajna poveznica: <https://um.nsk.hr/um:nbn:hr:117:839717>

Rights / Prava: [Attribution-NonCommercial-NoDerivatives 4.0 International/Imenovanje-Nekomercijalno-Bez prerada 4.0 međunarodna](#)

Download date / Datum preuzimanja: **2025-02-05**



Repository / Repozitorij:

[Repository of Faculty of Kinesiology, University of Zagreb - KIFoREP](#)





University of Zagreb

FACULTY OF KINESIOLOGY

CROATIA

Feng Li

**THE INFLUENCE OF FATIGUE ON
KINEMATIC PARAMETERS OF
BASKETBALL FUNDAMENTAL SKILLS
– PASSING, SHOOTING AND
DRIBBLING**

DOCTORAL THESIS

Zagreb, 2022



Sveučilište u Zagrebu

KINEZIOLOŠKI FAKULTET

HRVATSKA

Feng Li

**UTJECAJ UMORA NA KINEMATIČKE
PARAMETRE OSNOVNIH
KOŠARKAŠKIH VJEŠTINA –
DODAVANJE, ŠUTIRANJE I VOĐENJE
LOPTE**

DOKTORSKI RAD

Zagreb, 2022



University of Zagreb

FACULTY OF KINESIOLOGY

CROATIA

Feng Li

**THE INFLUENCE OF FATIGUE ON
KINEMATIC PARAMETERS OF
BASKETBALL FUNDAMENTAL SKILLS
– PASSING, SHOOTING AND
DRIBBLING**

DOCTORAL THESIS

Supervisor:

Full Professor Damir Knjaz, PhD

Zagreb, 2022



Sveučilište u Zagrebu

KINEZIOLOŠKI FAKULTET

HRVATSKA

Feng Li

**UTJECAJ UMORA NA KINEMATIČKE
PARAMETRE OSNOVNIH
KOŠARKAŠKIH VJEŠTINA –
DODAVANJE, ŠUTIRANJE I VOĐENJE
LOPTE**

DOKTORSKI RAD

Mentor:

Prof. dr. sc. Damir Knjaz

Zagreb, 2022

SUPERVISOR INFORMATION

Damir Knjaz was born in Zagreb, Croatia, where he graduated from the Faculty of Kinesiology University of Zagreb in 1996 and where he also received his PhD in 2005. He is a Full Professor on the course *Basketball* and head of the Laboratory for Sports Games at the Faculty of Kinesiology, University of Zagreb. His research fields and primary interests include diagnostics of basic and specific motor skills in all age groups and research on the effects of physiological load on the quality of specific motor performances of various basketball skills, as well as combining science, technology and education, creating and completing projects and innovative systems in sports diagnostics, health-oriented physical activity and biogenetics.

He has great experience and is a recognized expert in terms of managing scientific and professional international collaboration and sports projects. In 2009, he was the course teacher of Men's Basketball at Penn State University (the USA). He was also a guest lecturer at the Beijing Sport University in China and at the Masaryk University in Brno (the Czech Republic). In addition, Professor Damir Knjaz is the project leader of the study "Impact of physiological load on the changes in certain kinematic parameters while performing specific motor skills in the field of basketball", as well as has previously participated in several other scientific and research projects, such as: "Mini Basketball", "Health-related habits of sports coaches" and "Creating the Locomotion study Centre for excellence". He was the co-founder of the Croatian Basketball Academy, as well as its president between 1999 and 2003.

Professor Damir Knjaz, PhD is the author of more than one hundred fifty scientific and expert papers and the participant and invited speaker at numerous scientific and professional conferences in Europe, Asia and USA. During his years of successful academic, scientific and professional work in sports, he has also administered many demanding and high-ranked functions, as well as headed several multidisciplinary scientific and infrastructural projects. He was Dean of the Faculty of Kinesiology University of Zagreb for two consecutive terms and is currently a member of the Council of the Croatian Olympic Committee and the Rector's special advisor for social communications and sports at the University of Zagreb. As part of his professional work, Professor Damir Knjaz actively participated in the process of identifying and developing many top-level athletes, among which some are presently playing for national teams and/or in the best leagues in the world, such as the NBA.

During his professional and scientific career, Professor Damir Knjaz has received numerous acknowledgements and rewards for his dedicated work, among which also the Franjo Bučar State Award for Sport, as the highest level of Croatian national sports award.

SPONSORSHIP

This doctoral thesis is supported by the China Scholarship Council (CSC) from the Ministry of Education of the People's Republic of China under Grant [(2019) 110].



ACKNOWLEDGMENT

As words of acknowledgment flow at my fingertips, I know the end of my student life is finally approaching. During my 24 years of school education, I have experienced ups and downs, having tasted both excitement and bitterness. Yet, as I look back on that journey, only gratitude remains. I am grateful for having so many supportive teachers and friends who have accompanied me along the way.

First and foremost, I would like to extend sincere gratitude to my PhD mentor Professor Damir Knjaz. In the past three years, Mr. Knjaz has not only devoted much of his time to my overall academic work, but also offered care and support in my daily life. If not for his generous guidance and support, I would not have completed my studies in Croatia successfully, let alone finish my doctoral thesis.

Next, I would like to thank Professor Tomislav Rupčić for his insightful suggestions with the selection of my research topic, the design of experiments and the writing of the thesis.

What is more, I am grateful to the Dean of the Faculty of Kinesiology of University of Zagreb, Professor Tomislav Krističević, for his tender care during my PhD studies.

There are many more to be thanked at this moment. I would like to express my gratitude to China Scholarship Council for the sponsorship, which enabled me to focus on my PhD research and to get my PhD without financial burdens.

I would also like to express my heartfelt gratitude to my Masters mentor Professor Bi Zhongchun from whom I learnt not only knowledge and expertise in the field of basketball, but also life principles and values and it is such great pleasure to be his student. To me, he was a father-like figure who offered patient guidance and thorough care to his students. It was him who raised my awareness of the importance of the English language and broadened my horizons, paving ways for my future studies overseas. If I manage to become a teacher in the future, I will follow his example and dedicate myself to inspiring and tutoring my students.

I want to thank my dearest alma mater Beijing Sport University, which witnessed my great improvements in both academic abilities and visions. During my postgraduate studies, BSU offered me full scholarship in an Erasmus exchange program in Croatia. This golden learning opportunity overseas further strengthened my determination to pursue PhD studies abroad.

I shall thank my colleagues at the Laboratory for Sports Games, Vedran Dukarić, Ivan Bon, Mateja Očić, and Stipe Čubrić for their generous assistance. As a basketball major student, when I first came to Croatia, I was overwhelmed by the variety of research equipment and testing methods, harboring deep concerns about my PhD studies. It was this supportive team

that guided me patiently along the way and helped me become a competent researcher like them. I shall also credit Nina Miočević for her language assistance with the English grammar and expressions in my doctoral thesis. With her help, I have improved my English language proficiency a lot and I hope that I will have a chance to return the favor if we meet again in China one day.

“Everything will be fine in the end. If it is not fine, it is not the end.” I was empowered by this saying whenever I experienced self-doubts during my PhD studies. My Croatian friends told me that I have lived through all major events here, which took them decades to experience. Indeed, we have gone through two major earthquakes, a global pandemic and many more challenges together, and yet they have all ended well. “What’s past is prologue.” I was so grateful for my academic and living experience here in Croatia, for bringing a stronger self out of me and leaving memories that are worth cherishing for good. Croatia, we shall meet again soon.

Last but not the least, I would like to thank my family for their unfailing love and unconditional support. It is them who always offer me courage and faith in life, encourage me to overcome difficulties, motivate me to move on confidently and inspire me to realize my full potential in the fields I love.

致谢

行文至此，百感交集！毕业论文进行到这一步，意味着我的学生生涯即将结束。24 年求学生涯，酸甜苦辣，高低起伏，现在回头看，剩下的只有感恩。我很幸运，在求学路上遇到了很多良师益友。

首先，我要感谢我的博士生导师 Damir Knjaz。在克罗地亚的三年，他不仅为我的学业付出了大量的心血，还在生活上无微不至地关心照顾我。没有他的指导和帮助，我无法顺利完成我的博士论文，甚至无法在克罗地亚顺利完成学业。

其次，我要感谢 Tomislav Rupčić 教授，他对我论文的选题、实验设计和论文写作提供了大量的帮助和指导。

此外，我要感谢萨格勒布大学体育学院院长 Tomislav Krističević 在我读博期间给予的悉心照顾。

需要感谢的人还有很多。感谢国家留学基金委的资助，使我能在国外心无旁骛地进行博士研究，顺利地拿到博士学位。

我要特别感谢我的硕士生导师毕仲春教授。在北体与您有缘结为师徒，是我求学生涯的幸运。您像一位父亲一样耐心教导我们，始终把学生的事情挂在心上。从您的身上我不仅学到了很多专业知识，也学到了很多做人的道理和为人处世的原则。是您让我意识到学习英语的重要性，打开了我的国际视野，因此才有我硕士出国交换和出国读博的可能性。如果今后能够成为一名教师，我一定会以您为榜样，尽全力培养学生。

我还要感谢我的母校北京体育大学。在北京体育大学学习期间，我的专业知识和眼界都得到了巨大的提升。在硕士期间，母校就给我提供了全额奖学金出国交换的机会，正因为这次出国学习，才使我回国之后更加坚定了出国读博的决心。

感谢我的实验室同事—Vedran Dukarić, Ivan Bon, Mateja Očić, Stipe Čubrić. 记得刚来到克罗地亚时，我作为一个篮球术科出生的学生，看到实验室各种各样的仪器设备和多种多样的测试方法，曾对未来的博士学习充满了担忧。是你们不厌其烦手把手指导我，是你们的热情和无私，帮助我成为了更好的自己。我还要感谢 Nina Miočević 对我英文论文的语法和表达进行细致修改。在你的帮助下，我的英语规范性得到了很大的提升。希望有一天我们能在中国相遇，让我有机会帮助到你们。

“Everything will be fine in the end. If it is not fine, it is not the end.” 每当我挣扎在博士研究中自我怀疑时，是这句话一直给我力量。我的克罗地亚朋友说，我经历了他们在克罗地亚生活几十年才经历的事情。读博期间，我们共同经历了两次大地震、一次全球疫情，所幸最后结果都很好。过往皆序章，感恩这段在克罗地亚的学习和生活经历，它让我成为更坚强的自己，也给予我一生珍藏的回忆。克罗地亚，我们一定会在不远的未来重逢！

最后，我要感谢我的家人一直以来对我学业的支持。他们用爱陪伴我度过困难，自信前行，激励我在热爱的领域实现自我价值。

LIST OF ABBREVIATIONS

ACCURACY – the passing and shooting accuracy

AM ± SD – arithmetic mean ± standard deviation

ANKLE_AVmax – maximum angular velocity of ankle joint during jump shot

BALL_S – the speed of the ball approaching to the target

BL_non_F – the players' blood lactate concentration in non-fatigue condition

BL_F – The players' blood lactate concentration in fatigue condition

CI – 95% confidence intervals

COD – change of direction

EA – entry angle of the ball formed by the downward line of the ball in relation to the basket

ELBOW_AVmax – maximum angular velocity of elbow joint

HD – horizontal displacement from the moment a player jumps until landing

HIP_AVmax – maximum angular velocity of hip joint during jump shot

HR_non_F – the players' heart rate in non-fatigue condition

HR_F – the players' heart rate in fatigue condition

KNEE_AVmax – maximum angular velocity of knee joint during jump shot

M – mean

Max_HR_non_F – the players' maximum heart rate in non-fatigue condition

Max_HR_F – the players' maximum heart rate in fatigue condition

MD – mean difference

PELVIS_P – the position of player's pelvis from the point the player caught the ball until release

PELVIS_X axis – the velocity of player's pelvis in X-axis from the point the player caught the ball until release

PELVIS_Y axis – the velocity of player's pelvis in Y-axis from the point the player caught the ball until release

RH – release height when the ball left from a player's dominant hand

RPE – rating of perceive exertion

SD – standard deviation

SHOULDER_AVmax – maximum angular velocity of shoulder joint

SS – shooting speed from the moment player catches the ball until release

U16M – male under 16

U18M – male under 18

U16F – female under 16

U18F – female under 18

WRIST_AVmax – maximum angular velocity of wrist joint

2-pt – 2-point

3-pt – 3-point

η^2_p – partial eta squared

Table of contents

ABSTRACT

SAŽETAK

THESIS OUTLINE

CHAPTER 1: INTRODUCTION	1
Research background	1
Research gap	3
Research aims and questions.....	4
List of research studies	6
CHAPTER 2: LITERATURE REVIEW	7
Basketball fundamental skills	7
The concept and definition	7
Basketball passing	8
The concept and definition	8
Types of passing	8
The role of passing in basketball.....	8
Relevant literature	9
Basketball shooting	10
The concept and definition	10
Types of shooting	10
The role of shooting in basketball	10
Relevant literature	11
Basketball dribbling	13
The concept and definition	13
Types of dribbling	13
The role of dribbling in basketball	13
Relevant literature	14
Fatigue	16
The concept and definition	16

The role of fatigue in basketball players' performance.....	16
The relevant literature in basketball	17
Kinematic parameter	18
The concept and definition	18
The role of kinematic analysis in basketball	19
The relevant literature in basketball fundamental skills.....	19
CHAPTER 3: ORIGINAL STUDIES	21
Study 1: Influence of Fatigue on Some Kinematic Parameters of Basketball Passing	21
Study 2: Does fatigue affect the kinematics of shooting in female basketball?	39
Study 3: The Impact of Progressive Physiological Loads on Angular Velocities during Shooting in Basketball-Case Study	57
Study 4: Kinematic Analysis of 2-Point and 3-Point Jump Shot of Elite Young Male and Female Basketball Players.....	71
Study 5: The Effect of Fatigue on Kinematics and Kinetics in Basketball Dribbling with Changes of Direction.....	92
CHAPTER 4: GENERAL CONCLUSION	116
Strengths and limitations.....	118
Perspectives for future research	120
REFERENCES.....	121

ABSTRACT

Purpose: The main aim of this doctoral thesis was to determine the influence of fatigue on kinematic parameters in basketball fundamental skills. Within this doctoral thesis, five independent studies (Study 1-passing, Study 2, Study 3, and Study 4-shooting, Study 5-dribbling) were investigated. Study 1 set out to exam the influence of fatigue on kinematic parameters and accuracy in basketball passing. Study 2 aimed to assess the influence of fatigue on kinematic parameters and accuracy in female basketball shooting. Study 3 set out to determine the influence of progressive physiological load on kinematic parameters and accuracy in young male basketball shooting. Study 4 aimed to compare the kinematic parameters of 2-point and 3-point jump shots and ascertain the differences between elite male under 16 and 18 and female under 16 and 18 basketball players. Study 5 set out to investigate the influence of fatigue on kinematic parameters and the speed in basketball dribbling.

Methods: In study 1, Eleven Croatian basketball players who are members of the youth national program (age: 18.36 ± 0.67 years; height: 192.32 ± 9.98 cm; weight: 83.35 ± 11.19 kg; body fat: $15.00 \pm 4.40\%$, arm span: 194.34 ± 10.39 cm) participated in the study. 3D motion analysis using inertial sensor technology (Xsens suit) was used to analyze the kinematic parameters of push passing; a radar gun was used to determine ball speed; heart rate and blood lactate concentration were used to identify fatigue and non-fatigue condition. In study 2, thirty-two professional female basketball players volunteered to take part in the study (age: 22.11 ± 4.92 years; height: 173.99 ± 7.06 cm; weight: 67.89 ± 5.65 kg). The Xsens suit and smart ball were used for measuring the kinematic parameters. A shooting machine was used to standardize each pass, directly influencing the shooting efficiency, and to minimize the interference from external factors. To monitor the fatigue level, the blood lactate concentration and rating of perceived exertion were conducted during the testing. In study 3, one player (age: 17.36 years) who is a member of the Croatian U18 Men's National Team was evaluated as a case study. To measure kinematic parameters during the jump shot, the SIMI Motion system with eight cameras and a smart ball were used. The progressive physiological loads were determined by blood lactate concentration. Forty-eight young male and female basketball players participated in study 4. To assess the kinematic parameters of 2-point and 3-point shooting, Xsens suit was used with the addition of a smart ball. In study 5, fourteen Croatian senior basketball players excluding power forwards and centers (age: 21.16 ± 3.43 years; height: 188.81 ± 6.88 cm; weight: 87.81 ± 6.06 kg; body fat: 13.34 ± 3.52 %) participated in the study. Each player performed two types of change of direction with dribbling: front change of direction and spin

move. Xsens suit and Novel pressure insoles were used to measure the kinematic and kinetic parameters respectively. Heart rate and blood lactate concentration were employed to monitor players' fatigue level.

Results: In study 1, there was significant difference in angular velocities of shoulder ($p = 0.01$), elbow ($p = 0.04$), and wrist ($p = 0.01$), ball speed ($p = 0.00$), pelvis position ($p = 0.00$), and velocity of the pelvis in X-axis ($p = 0.00$) between fatigue and non-fatigue condition. Additionally, the passing accuracy significantly decreased when players were under the influence of fatigue ($p = 0.01$). In study 2, the results demonstrated that there were no significant differences in angular velocities of ankle, knee, and hip joints between fatigue and non-fatigue condition. Conversely, differences in angular velocities of elbow ($p = 0.036$) and wrist ($p = 0.002$) were detected. Furthermore, the results showed that the release height and entry angle of the ball significantly decreased under the influence of fatigue. Moreover, the shooting accuracy did not noticeably decrease when players were under the influence of fatigue. In study 3, the obtained results indicated certain differences in angular velocities of the upper and lower extremities regarding different fatigue levels, as well as in the height at the moment of releasing the ball under the influence of progressive fatigue. In study 4, players in male categories shot for 2-point with a higher center of mass difference in the vertical direction, with higher release shoulder angle, and with a higher entry angle of the ball when compared to female categories ($p < 0.001$). In the 3-point shooting, there were differences between male and female categories in the shoulder angle when releasing the ball ($p < 0.001$). In the players' shooting speed, there were differences between U16 male vs U18 female and U16 female vs U18 female ($p = 0.02$) players. Male categories shot 3-point shots with a smaller center of mass difference in the horizontal direction when compared to 2-point shots ($p < 0.001$). The entry angle was higher in successful shooting attempts compared to unsuccessful shooting attempts when shooting for 3-point ($p = 0.02$). Player shooting speed was higher in all categories (except U18 female) when shooting for 3-point ($p < 0.001$). In study 5, in terms of the front change of direction, the results demonstrated that the maximum angular velocities in knee joint ($p=0.028$), wrist joint ($p=0.007$), and maximum force ($p=0.004$) significantly decreased under the influence of fatigue; the pelvis position and minimum angle in knee joint were higher under the influence of fatigue compared to the non-fatigue condition, but there was no significant difference. In terms of the spin move, the results showed that there were significant differences in pelvis velocity ($p=0.000$), maximum angular velocity in knee joint ($p=0.020$), and first step velocity ($p=0.010$); however, no significant difference was detected in the pelvis position, minimum angle in the knee joint

and maximum force. Importantly, the dribbling speed significantly decreased in the fatigue condition ($p=0.002$).

Conclusions: In general, fatigue has negative influence on kinematic parameters and players performance in basketball fundamental skills. To be specific, (1) The major conclusion drawn from study 1 showed that fatigue affects the kinematic parameters and accuracy in basketball passing. The findings of this study suggest that players need to adopt the correct motor structure of passing to create an automatism during the training process of learning. Additionally, coaches need to conduct as many drills as possible in situational conditions that are similar to the conditions during the basketball game. As a result, the players' passing performance will ultimately not change even under the influence of fatigue. (2) The results of study 2 indicated that elite female basketball players can maintain the efficiency through readjusting the neuromuscular system to make a successful jump shot when they were under the influence of fatigue. Furthermore, the results of current study showed that the release height and entry angle of the ball significantly decreased under the influence of fatigue, suggesting that coaches need to include in the training process exercises that are similar in terms of fatigue and performance to the situational conditions during the game as these two variables play an important role in determination of the shooting accuracy. (3) The major conclusion drawn from study 3 was that fatigue impacts certain changes in the kinematic parameters of the jump shot in terms of young male players. The angular velocities of joints in the lower extremities noticeably increased, while the mentioned parameters in the upper extremities decreased when physiological load increased. Additionally, the height of releasing the ball decreased. Despite the changes in the above-mentioned parameters, the action performed on the ball remained unchanged, considering that the shooting speed, as well as the angle at which the ball entered the basket, demonstrated no changes. Even though the action performed on the ball did not alter from the biomechanical standpoint, the reduction of shooting accuracy under the influence of a higher level of fatigue still suggests that certain deviations occurred in the overall pattern of performing the examined motor skill. Therefore, coaches are required to design appropriate training sessions to resist the influence of fatigue on jump shot performance. (4) The results of study 4 showed that female and male basketball players used different shooting techniques. Additionally, players in male categories shot with a higher center of mass difference in the vertical direction, with a higher release shoulder angle, and with a higher entry angle of the ball. Moreover, the entry angle of the ball increases in all categories when shooting for 3-point, which means that players need more time for 3-point shots after receiving a pass when compared to 2-point shots. Therefore, the players are using excessive movements to optimize

the shooting technique when shooting for 3-point. Basketball coaches and players should work to minimize the kinematic differences between 2-point and 3-point shots to increase the successfulness of shooting from longer distances. (5) The major conclusion drawn from study 5 is that fatigue affects the kinematics and kinetics of basketball dribbling. Additionally, the dribbling speed significantly decreased when the players were under the influence of fatigue. From the result point of view, the higher pelvis position, the lower angular velocity in knee and wrist joint, and the lower force when the players are under the influence of fatigue may induce that they are not able to take advantage of the defender successfully. Additionally, the decrease of the dribbling speed under the influence of fatigue will cause the players' inability to pass by the defender quickly during the fast break and transition period, which consequently makes them lose the opportunity of scoring. Therefore, the findings of this study suggest that coaching staff is required to design appropriate training sessions to optimize players' ability to resist fatigue when dribbling in real game speed conditions.

Key words: accuracy, efficiency, angular velocity, pelvis velocity, ball speed, female basketball, youth basketball, kinematic analysis, kinetic analysis, Xsens, change of direction, spin move, joint angle, center of mass, pass, jump shot, dribble

SAŽETAK

Svrha: Glavni cilj ovog doktorskog rada bio je utvrditi utjecaj umora na kinematičke parametre u temeljnim košarkaškim vještinama. Unutar ovog doktorskog rada izvedeno je pet neovisnih istraživanja (Istraživanje 1 – dodavanje lopte, Istraživanje 2, Istraživanje 3 i Istraživanje 4 – šutiranje i Istraživanje 5 – vođenje lopte). Istraživanje 1 je imalo za cilj ispitati utjecaj umora na kinematičke parametre i točnost dodavanja u košarci. Istraživanje 2 imalo je za cilj procijeniti utjecaj umora na kinematičke parametre i točnost šutiranja u ženskoj košarci. Istraživanje 3 imalo je za cilj utvrditi utjecaj progresivnog fiziološkog opterećenja na kinematičke parametre mladih košarkaša i njihovu točnost u šutiranju. Istraživanje 4 imalo je za cilj usporediti kinematičke parametre skok šutova za 2 i 3 poena i utvrditi razlike između elitnih košarkaša do 16 i 18 godina i košarkašica do 16 i 18 godina. Istraživanje 5 je imalo za cilj istražiti utjecaj umora na kinematičke parametre i brzinu košarkaškog driblinga.

Metode: U istraživanju 1, jedanaest hrvatskih košarkaša koji su članovi nacionalnog programa za mlade (dob: $18,36 \pm 0,67$ godina; visina: $192,32 \pm 9,98$ cm; težina: $83,35 \pm 11,19$ kg; postotak potkožnog masnog tkiva: $15,00 \pm 4,40\%$, raspon ruku: $194,34 \pm 10,39$ cm) sudjelovali su u istraživanju. Za analizu kinematičkih parametara dodavanja lopte jednom rukom guranjem korištena je 3D analiza kretanja pomoću inercijske senzorske tehnologije (Xsens odijelo); za određivanje brzine lopte korišten je radarski pištolj; otkucaji srca i koncentracija laktata u krvi korišteni su za identifikaciju stanja nakon opterećenja (umor) i stanja prije opterećenja (bez umora). U istraživanju 2 su dobrovoljno sudjelovale trideset i dvije profesionalne košarkašice (dob: $22,11 \pm 4,92$ godina; visina: $173,99 \pm 7,06$ cm; težina: $67,89 \pm 5,65$ kg). Za mjerenje kinematičkih parametara korišteni su Xsens odijelo i pametna lopta. Košarkaški top korišten je za standardiziranje svakog dodavanja, kao izravan utjecaj na učinkovitost šutiranja, i za minimiziranje smetnji od strane vanjskih čimbenika. Kako bi se pratila razina umora, tijekom ispitivanja mjerena je koncentracija laktata u krvi i subjektivna procjena opterećenja. U istraživanju 3, jedan igrač (dob: 17,36 godina) koji je član hrvatske U18 muške reprezentacije promatran je kao studija slučaja. Za mjerenje kinematičkih parametara tijekom skok šuta korišten je SIMI Motion sustav s osam kamera i pametnom loptom. Progresivna fiziološka opterećenja određena su koncentracijom laktata u krvi. Četrdeset i osam mladih košarkaša i košarkašica sudjelovalo je u istraživanju 4. Za procjenu kinematičkih parametara šutiranja za 2 i 3 poena korišteno je Xsens odijelo s dodatkom korištenja pametne lopte. Četrnaest hrvatskih košarkaša seniora, isključujući krilne centre i centre (starost: $21,16 \pm 3,43$ godine; visina: $188,81 \pm 6,88$ cm; težina: $87,81 \pm 6,06$ kg; postotak potkožnog masnog tkiva: $13,34 \pm 3,52\%$)

sudjelovalo je u istraživanju 5. Svaki je igrač izveo dvije vrste promjene smjera s vođenjem lopte: prednju promjenu smjera i promjena s okretom. Za mjerenje kinematičkih i kinetičkih parametara korišteni su odijelo Xsens i ulošci za mjerenje sile pritiska Novel. Otkucaji srca i koncentracija laktata u krvi korišteni su za praćenje razine umora igrača.

Rezultati: U istraživanju 1 postojala je značajna razlika u kutnim brzinama ramena ($p = 0,01$), lakta ($p = 0,04$) i zgloba šake ($p = 0,01$), točnosti ($p = 0,01$), brzine lopte ($p = 0,00$), položaja zdjelice ($p = 0,00$) i brzine zdjelice na X-osi ($p = 0,00$) između stanja prije i nakon opterećenja. Osim toga, smanjila se točnost dodavanja kada su igrači bili pod utjecajem umora. U istraživanju 2, rezultati su pokazali da nema značajnih razlika u kutnim brzinama skočnog zgloba, koljena i kuka. Suprotno tome, otkrivene su razlike u kutnim brzinama lakta ($p = 0,036$) i zgloba šake ($p = 0,002$). Nadalje, rezultati su pokazali da se visina izbačaja i kut upada lopte značajno smanjuju pod utjecajem umora. Štoviše, preciznost šutiranja nije se naočigled smanjivala kada su igrači bili pod utjecajem umora. U istraživanju 3, dobiveni rezultati ukazuju na određene razlike u kutnim brzinama gornjih i donjih ekstremiteta s obzirom na različite razine umora, kao i u visini u trenutku puštanja lopte pod utjecajem progresivnog umora. U studiji 4, igrači u muškim kategorijama šutirali su za 2 poena s višom razlikom centra težišta tijela u okomitom smjeru, s većim kutom izbačaja u ramenu i s većim kutom ulaska lopte u usporedbi sa ženskim kategorijama ($p < 0,001$). U šutiranju za 3 poena uočene su razlike između muške i ženske kategorije u kutu ramena pri izbačaju lopte ($p < 0,001$). U brzini šutiranja postojale su razlike između košarkaša U16 i košarkašica U18 te između košarkašica U16 i U18 ($p = 0,02$). Muške kategorije šutirale su za 3 poena s manjom razlikom centra težišta tijela u horizontalnom smjeru u usporedbi s šutovima za 2 poena ($p < 0,001$). Ulazni kut bio je veći u uspješnim pokušajima šutiranja u usporedbi s neuspješnim pokušajima šutiranja za 3 poena ($p = 0,02$). Brzina šutiranja bila je veća u svim kategorijama (osim košarkašica U18) pri šutiranju za 3 poena ($p < 0,001$). U istraživanju 5, u kontekstu prednje promjene smjera, rezultati su pokazali da su se maksimalne kutne brzine u zglobu koljena ($p=0,028$), zglobu šake ($p=0,007$) i maksimalne sile ($p=0,004$) značajno smanjile pod utjecajem umora; položaj zdjelice i minimalni kut u zglobu koljena bili su veći nakon opterećenja (pod utjecajem umora) u odnosu na stanje prije opterećenja, ali nije bilo značajne razlike. Što se tiče promjene s okretom, rezultati su pokazali da postoje značajne razlike u brzini zdjelice ($p=0,000$), maksimalnoj kutnoj brzini u zglobu koljena ($p=0,020$) i brzini prvog koraka ($p=0,010$); međutim, nije otkrivena značajna razlika u položaju zdjelice, minimalnom kutu u zglobu koljena i maksimalnoj sili. Važno je da se brzina vođenja lopte značajno smanjila u stanju pod utjecajem umora ($p=0,002$).

Zaključci: Općenito, umor negativno utječe na kinematičke parametre i performanse igrača u osnovnim košarkaškim vještinama. Konkretno, (1) Rezultat istraživanja 1 pokazao je da umor utječe na kinematičke parametre i točnost dodavanja lopte jednom rukom guranjem u košarci. Rezultati ovog istraživanja pokazuju da igrači trebaju usvojiti ispravnu motoričku strukturu dodavanja kako bi se tijekom trenažnog procesa učenja stvorio automatizam. Nadalje, treneri trebaju provesti što više vježbi u situacijskim uvjetima koji su slični uvjetima tijekom košarkaške utakmice. Kao rezultat toga, učinak dodavanja igrača u konačnici se neće promijeniti čak ni pod utjecajem umora. (2) Rezultati istraživanja 2 pokazali su da vrhunske košarkašice mogu održati učinkovitost kroz prilagodbu neuromišićnog sustava kako bi izvele uspješan skok kada su bile pod utjecajem umora. Nadalje, rezultati trenutne studije pokazali su da su se visina izbačaja i kut upada lopte značajno smanjili pod utjecajem umora. Navedeno sugerira da treneri u trenažni proces trebaju uključiti vježbe koje su prema razini umoru i izvedbi slične situacijskim uvjetima tijekom igre jer ove dvije varijable igraju važnu ulogu u određivanju točnosti šutiranja. (3) Glavni zaključak koji je izveden iz rezultata istraživanja 3 bio je da umor utječe na određene promjene kinematičkih parametara skok šuta kod mladih igrača. Kutne brzine zglobova u donjim ekstremitetima primjetno su se povećale, dok su se navedeni parametri u gornjim ekstremitetima smanjili s povećanjem fizioloških opterećenja. Dodatno se smanjila visina izbačaja lopte. Unatoč promjenama u gore navedenim parametrima, radnja izvedena na lopti ostala je nepromijenjena s obzirom na to da brzina šutiranja, kao i kut ulaska lopte u koš, nisu pokazivali promjene. Iako se djelovanje na loptu nije promijenilo s biomehaničkog stajališta, smanjenje točnosti šutiranja pod utjecajem više razine umora i dalje sugerira da je došlo do određenih odstupanja u ukupnom obrascu izvođenja ispitivane motoričke sposobnosti. Stoga je potrebno da treneri osmisle odgovarajuće treninge kako bi se igrači oduprli utjecaju umora na izvedbu skok šutova. (4) Rezultati istraživanja 4 pokazali su da su košarkašice i košarkaši koristili različite tehnike šutiranja. Dodatno, igrači su šutirali s većom razlikom središta mase u okomitom smjeru, s većim kutom izbačaja u ramenu i s većim kutom ulaska lopte. Štoviše, kut ulaska lopte povećava se u svim kategorijama kada se šutira za 3 poena, što znači da igračima treba više vremena za šutove za 3 poena nakon primljenog dodavanja u odnosu na šutove za 2 poena. Stoga igrači koriste pretjerane pokrete kako bi optimizirali tehniku šutiranja za 3 poena. Košarkaški treneri i igrači trebali bi raditi na smanjenju kinematičkih razlika između šutiranja za 2 i 3 poena kako bi se povećala uspješnost šutiranja s većih udaljenosti. (5) Glavni zaključak koji je izveden iz studije 5 bio je da umor utječe na kinematiku i kinetiku košarkaškog vođenja lopte. Dodatno, brzina vođenja lopte značajno se smanjila kada su igrači bili pod utjecajem umora. S točke gledišta rezultata, viši

položaj zdjelice, niža kutna brzina u zglobu koljena i zglobu šake, te niža sila pod utjecajem umora mogu dovesti do toga da igrači ne mogu uspješno iskoristiti prednost nad obrambenim igračem. Dodatno, smanjenje brzine vođenja lopte pod utjecajem umora dovest će do toga da igrači tijekom faza protunapada i tranzicije neće moći brzo proći pored obrambenog igrača, što posljedično dovodi do toga da gube priliku za postizanje pogotka. Stoga, rezultati ovog istraživanja sugeriraju da treneri trebaju osmisliti odgovarajuće treninge kako bi optimizirali sposobnost igrača da izdrže utjecaj umora pri vođenju lopte u realnim uvjetima igre.

Ključne riječi: preciznost, učinkovitost, kutna brzina, brzina zdjelice, brzina lopte, ženska košarka, košarka u mlađim dobnim selekcijama, kinematička analiza, kinetička analiza, Xsens, promjena smjera, promjena s okretom, kut zgloba, centar težišta tijela, dodavanje, skok šut, vođenje lopte

THESIS OUTLINE

The structure of the thesis is divided into four chapters.

Chapter one introduces the research background and research purpose of this doctoral thesis.

Chapter two provides the literature review consisting of the concepts and definitions and the relevant research.

Chapter three presents the published research related to the thesis. The first study aims to determine if the kinematic parameters and accuracy of basketball passing changed when players were under the influence of fatigue. The second study aims to assess if the kinematic parameters and accuracy of basketball shooting changed when elite female players were under the influence of fatigue. The third study aims to observe if the kinematic parameters and the accuracy of basketball jump shot changed when young male basketball players were under the influence of different stages of fatigue. The fourth study aims to compare the kinematic parameters of basketball jump shot (separately for 2-point and 3-point shots) after receiving the ball (catch-and-shoot situation after a cut) and ascertain the differences between the elite U16 and U18 male and female basketball players, and between successful and unsuccessful shots. The fifth study aims to investigate if the kinematic parameters and the speed of basketball dribbling changed when players were under the influence of fatigue.

Chapter four presents the general conclusion and discusses the strengths and limitations of the research, as well as provides the potential directions for future research.

CHAPTER 1: INTRODUCTION

Research background

Basketball is the world's second most popular sport, with over 450 million players in 213 countries participating on a competitive or recreational level (Ziv and Lidor, 2009). Given its popularity and commerciality (Drinkwater et al., 2008), the team's success is critical regardless of the country, the nation, the fans, or the club.

Some previous studies have reported that the fundamental skills play an important role in winning the game at all levels of basketball and all players must learn to execute them properly and quickly to be successful (Kioumourtzoglou et al., 1998, Krause and Nelson, 2018). Additionally, the scientific literature relating to basketball has highlighted that the techniques of passing, shooting, and dribbling are the most basic and frequently used skills in basketball competition (Ibáñez et al., 2008, Fujii et al., 2010, Wang et al., 2009). Furthermore, these three technical skills have been continuously used in the NBA all-star skills challenge each season, implying that passing, shooting, and dribbling techniques are essential even for elite basketball players.

Traditionally, the players' techniques were subjectively evaluated by coaches' experience. However, it is possible that even coaches with rich knowledge in practice can occasionally ignore some details in players techniques. Nowadays, with the rapid development of technology, there have been many studies observing players' techniques by using kinematic analysis (Struzik et al., 2014, Rojas et al., 2000, Nakano et al., 2020), which may help the one in teaching, learning to have better understanding in the movement pattern of basketball techniques and to further perfect players' techniques. Similarly, some studies have concluded that basketball coaches and teachers should integrate ideas from practical experience and scientific research in order to elicit the best training system for producing top basketball players (Knudson, 1993, Trninić et al., 2002).

With respect to basketball fundamental skills, numerous studies have demonstrated the importance of the techniques of basketball passing, shooting, and dribbling.

For basketball passing, researchers noticed that players are required to keep possession of the ball and to cooperate in order to create optimal shooting options during the offense of basketball competitions (García et al., 2013). García et al. further stated that teams that assist more are more likely to win the game. Furthermore, a study reported that reductions in turnovers (i.e., lost possession) increase the winning odds, particularly in games where opponents have similar

chances of winning (Gómez et al., 2015). Another study highlighted that the passing technique is the main distinguishing factor between starters and non-starters in elite competitions. Therefore, players' performance and season-long success in basketball are particularly based on passing skills (Gómez et al., 2009).

For basketball shooting, many studies have proved that shooting is the main and most effective means of scoring in basketball games, and it has previously been recognized as the most frequently used and the most important technique in the competitions (Denisa Zambová, 2012, Boddington et al., 2019). In the study of game-related statistics, it was identified that particularly effective field goals (together with defensive rebounds, free throw percentages, and assists) were attributed to win/loss in elite basketball competitions (Angel Gómez et al., 2008, Ibáñez et al., 2009, Lorenzo et al., 2010). Particularly, the importance of jump shot was highlighted frequently according to the literature regarding basketball shooting (Knudson, 1993, Zwierko et al., 2018, Boddington et al., 2019). Previous studies mentioned that there are different types of scoring during a basketball game, while jump shot has been reported to be the most common and efficient shooting technique (Knudson, 1993, Zwierko et al., 2018), accounting for more than 60% of field goal attempts in the Women's National basketball Association (WNBA) in the 2010 season (Oudejans et al., 2012) and 67% of field goal attempts in the National Basketball Association (NBA) 2014 season (Boddington et al., 2019). As a proposal based on the above, coaches and basketball teachers should place a greater emphasis on jump shots during training sessions.

For basketball dribbling, according to game statistics, semi-professional players spend 9–11 percent of their playing time in dribbling during a basketball game (Scanlan et al., 2015) and dribbling to maintain ball control is essential during later periods of a professional game (Scanlan et al., 2015). In set offense, a player with proficient dribbling technique is able to break the opponent's intensive defense (e.g., crossover, penetration, and spin move), which creates free space to pass the ball to his teammates following an open shot (Arias-Estero, 2013, Arias et al., 2012). Additionally, it has been previously observed that fast break (Christmann et al., 2018, Evangelos et al., 2005, Conte et al., 2017, Matulaitis and Bietkis, 2021) and transition (i.e., from defense to offense) (Milanović et al., 2014, Matulaitis and Bietkis, 2021) are most efficient for scoring, which requires high-speed dribbling to provide an advantage over the defender while driving to the basket (Conte et al., 2017). Moreover, Conte et al. pointed out that the proper technique of passing and dribbling reduces the number of turnovers (Conte et al., 2016) and induces more assists (Arias et al., 2012). As a result, it can be concluded that the effective dribbling technique plays an important role in determining the outcome of a game.

According to the scientific literature, basketball is distinguished by high intermittent sports, such as sprints, shuffles, jumps (Meckel et al., 2009, Caprino et al., 2012), which demands both aerobic and anaerobic capacities (McInnes et al., 1995). Previous studies using time-motion analysis have demonstrated that players cover about 4500–5000 m during a game (Taylor, 2003), sprint every 21 s on average and make about 100 high intensity actions of short duration (e.g., jumping or sprinting) for about 34% of the game time (Narazaki et al., 2009). Additionally, at the elite level, researchers have identified intermittent high-intensity exercise as predominant to basketball competition (Pate, 2000, Trninic et al., 2001). Therefore, although elite players have highly developed skills, their performance may be impaired when they are under the influence of fatigue. As a result, fatigue becomes an unavoidable part of the game, affecting a player's performance, coordination, and skills (Forestier and Nougier, 1998). Similarly, previous studies have shown that fatigue is known to negatively affect technical skills, and thus the ability to maintain the required high-intensity activities for the entire duration of the game is a crucial determinant of performance in basketball. (Castagna et al., 2007, Erculj and Supej, 2009).

Research gap

As explained earlier, it is possible that even coaches with rich knowledge in practice can occasionally ignore some details in the players' techniques. Therefore, an objective method is needed to evaluate players' skills and further optimize their techniques. On the other hand, basketball is a high-intensity team sport which may impair players' fundamental skills when they are under the influence of fatigue. Therefore, it is necessary to assess the differences in players' performance between fatigue and non-fatigue condition.

With the development of technology, coaches and basketball teachers can use kinematic analysis to compare the kinematic differences in players' skills between fatigue and non-fatigue condition, which could help coaches design appropriate training sessions to minimize the influence of fatigue and to further improve players' fundamental skills. Furthermore, it can also help coaches in selecting top-level players. However, according to the literature, little is known about the influence of fatigue on kinematic parameters in basketball fundamental skills.

Specifically, for study 1, there were only a few studies investigating the difference of players' passing accuracy between fatigue and non-fatigue condition (Ahmed, 2013, Lyons et al., 2006). However, these studies mainly focused on passing accuracy or ability, while no kinematic parameters were observed. Thereby, certain movement patterns of passing in different

conditions remain mostly unexplored. According to Theoharopoulos et al, chest pass, overhead pass, and push pass were most commonly used in basketball games, with the latter having importance when the players face defense pressure (Theoharopoulos et al., 2010). In light of this, push passing was selected as the research object in study 1.

For study 2, numerous studies have examined basketball jump shots using kinematic analysis. However, little is known about the influence of fatigue on kinematic parameters of jump shots regarding female basketball players. It is therefore essential to add some new knowledge to this area. Additionally, another novelty of study 2 was that the shooting machine was used to standardize each pass, which ultimately allowed for the exclusion of negative external factors (inaccurate passes) on the performance of the jump shot technique.

For study 3, unlike the aforementioned studies which have observed basketball jump shot using kinematic analysis, this study additionally investigates the influence of progressive physiological loads (i.e., different fatigue stages) on kinematic parameters in junior basketball players.

For study 4, scientific literature assessing the kinematic and physical parameters of a jump shot presents only shots taken without any action before shooting (dribbling or cutting—no pull-up jumps shots or catch-and-shoot jump shots). Measuring kinematic and physical parameters of a jump shot that are more similar to real game conditions is absent (e.g., catch-and-shoot situation after a cut). Moreover, comparing these parameters between gender is even less studied, having in mind the differences between males and females in physical performance. Another novelty and uniqueness of study 4 is in the documented kinematic parameters of the jump shot after making a cut and receiving the ball.

For study 5, there is little research involving basketball dribbling from the literature review. Most previous studies only focused on assessing players' speed of dribbling or the level of dribbling by experts' evaluation. To the best of our knowledge, there is no research investigating the effect of fatigue on kinematic parameters regarding basketball dribbling.

Research aims and questions

As explained in the introduction, it is clear that previous studies show little knowledge about the influence of fatigue on the kinematic parameters regarding basketball passing, shooting, and dribbling. Based on this background, the main aim of the doctoral thesis is fivefold:

- 1) to determine if the kinematic parameters of basketball passing change when players are under the influence of fatigue as well as to identify if the fatigue affects the passing accuracy.

- 2) to examine if the kinematic parameters of basketball shooting in female players change when they are under the influence of fatigue as well as to investigate if the fatigue affects shooting accuracy.
- 3) to determine if the kinematic parameters of basketball jump shot in young male players change when they are under the influence of different fatigue stages as well as to assess if the different fatigue stages affect the shooting accuracy.
- 4) to compare the kinematic parameters of basketball jump shot (separately for 2-point and 3-point shots) after receiving the ball (catch-and-shoot situation after a cut) and ascertain the differences between the elite U16 and U18 male and female basketball players, and between successful and unsuccessful shots.
- 5) to assess if the kinematic parameters of basketball dribbling change when players are under the influence of fatigue as well as to determine if the fatigue affects the dribbling speed.

List of research studies

To answer the aforementioned questions, this doctoral thesis includes five studies that have been published:

1. **Li, F.**, Knjaz, D., & Rupčić, T. (2021). Influence of Fatigue on Some Kinematic Parameters of Basketball Passing. *International Journal of Environmental Research and Public Health*, 18(2), 700. DOI: 10.3390/ijerph18020700
2. **Li, F.**, Li, Z., Borović I., Rupčić, T., & Knjaz, D. (2021). Does Fatigue Affect the Kinematics of Shooting in Female Basketball? *International Journal of Performance Analysis in Sport*, 21(5), 754-766. DOI: 10.1080/24748668.2021.1945878
3. Rupčić, T., **Li, F.**, Matković, B. R., Knjaz, D., Dukarić, V., Baković, M., Matković, A., Svoboda, I., Vavaček, M., & Garafolić, H. (2020). The Impact of Progressive Physiological Loads on Angular Velocities during Shooting in Basketball-Case Study. *Acta Kinesiologica*, 14(2), 102–109.
4. Vencúrik, T., Knjaz, D., Rupčić, T., Sporiš, G., & **Li, F.** Kinematic Analysis of 2-Point and 3-Point Jump Shot of Elite Young Male and Female Basketball Players. *International Journal of Environmental Research and Public Health*, 2021, 18, 934. DOI: 10.3390/ijerph18030934
5. **Li, F.**, Rupčić, T., & Knjaz, D. (2021). The Effect of Fatigue on Kinematics and Kinetics in Basketball Dribbling with Changes of Direction. *Kinesiology*, 53(2), 296-308. DOI: 10.26582/k.53.2.12

CHAPTER 2: LITERATURE REVIEW

Basketball fundamental skills

The concept and definition

The fundamental skill is the ability that is necessary in order to perform a task or understand an idea because it is a foundation for other skills or ideas. It is also defined as a basic ability usually considered necessary for competent functioning in society (Dictionary, 2021)

The fundamental skill in basketball is classified as different elements from different articles, such as passing, shooting, dribbling, rebounding, footwork, blocking, and screening. Cooper and Siedentop noticed in their book that it is a moot point as to what is the rank or order of importance of the various categories of fundamentals. However, dribbling is most likely the first skill that should be learned. The reason is because offensive skill is more difficult to learn than defensive skills and take a great deal longer to perfect. They further reported that passing and shooting should be learned next and may be the best learned together. Moreover, the authors concluded that offensive basketball is based upon the player being able to dribble, pass, and shoot at the basket and these three main offensive skills must be learned properly (Cooper John Miller, 1975). According to the literature, passing, shooting, and dribbling are, when compared to others, also mainly considered the most important fundamental skills. (Rose, 2012, Maimón et al., 2020, Montesano et al., 2013, Li et al., 2021, Arias-Estero, 2013). Considering the importance of passing, shooting, and dribbling in basketball fundamentals, therefore, these three techniques were investigated in this doctoral thesis.

Basketball passing

The concept and definition

In basketball, passing is a technique for passing the ball from one player to another and it is the fastest way to move the ball around the court. (Road, 2021). Another study defined passing as the act of throwing a basketball from one player to another and it refers to the purposeful movement of the ball to, between or among teammates (Cooper John Miller, 1975). Authors further stated the ball may be thrown from as short a distance as the hand-off and as far a distance as the full-court length pass, yet the central purpose of passing remains the same. It is to transfer possession of the ball to, between or among teammates (Cooper John Miller, 1975). Furthermore, Trninić defined passing skills as the fundamental ability to choose and execute (from the spot or moving) well-timed and accurate passes to an open teammate to create a good scoring opportunity (Trninić, 2000).

Types of passing

There are a number of different types of passing. World-famous basketball coach John Wooden categorized passing into following types according to importance: main categories - strait pass, bounce pass, lob pass, and subcategories - handoff, push pass, overhead pass, shoulder pass, hip pass, baseball pass, hook pass, tip pass, roll pass, behind-the-back pass, and post-man passes (Wooden, 1966). Unlike Wooden, Wissel stated, in his book "Basketball steps to success", that the basic passes include chest pass, bounce pass, overhead pass, push pass, baseball pass, and behind-the back pass (Wissel, 1994). According to literature, different coaches and scholars categorized passing into different types based on the importance.

The role of passing in basketball

Coach John R. Wooden mentioned in his book "Practice Modern Basketball" that "passing is the most important part of all the individual offensive fundamentals. Some will say that shooting is the most important, but I consider shooting as a pass to the basket. Without passing, there would not be very many good shots as a great percentage of the good shots are set up by a succession of passes (Wooden, 1966)."

In the literature there are many examples in literature of stating the importance of passing in basketball (Ibáñez et al., 2008, Knjaz, 2000). For instance, Sergio J et al. investigated the game-related statistics in terms of team season-long success, reporting that passing is one of the most

frequently used techniques during a competitive game (Ibáñez et al., 2008). Furthermore, Sampaio et al. observed the differences in game performances between all-star and non-all-star basketball players from the National Basketball Association and they highlighted that passing technique is even the optimal factor to determine all-star and non-all-star NBA players (Sampaio et al., 2015). Moreover, studies showed that teams that assist more are more likely to win the game and players are required to keep possession of the ball to create optimal shooting options during the offense (García et al., 2013, Gómez et al., 2015). In summary, passing is an indispensable technique in basketball.

Relevant literature

More attention has been focused on the provision of basketball passing in recent years. Maimón et al. investigated a system review regarding basketball passing and they categorized previous studies relating to passing into five areas: performance analysis, biomechanics, physical conditioning, mental factors, and motor skills. Authors further concluded that research related to game situations were match, analytical situations, and small sided games. Moreover, the bulk of research examined on male samples or both sexes, with only three focusing solely on female outcomes (Maimón et al., 2020). To date, there is more passing research focusing on the technical learning (Kazem et al., 2021, Dania et al., 2020, Calábria-Lopes et al., 2019), technical evaluation (Sufyandi et al., 2019, Quílez-Maimón et al., 2021, Zhang and Zhang, 2018), reliability and validity of testing protocols (Conte et al., 2019, Aryanto et al., 2020). However, although extensive research has been done on basketball passing, little is known about the influence of fatigue on kinematic parameters regarding passing.

Basketball shooting

The concept and definition

Cooper and Siedentop stated in the book “The Theory and Science of Basketball” that shooting may be defined as the act of propelling the ball toward the goal in a type of throwing motion with the use of one or two hands. They further mentioned that shooting is the most important and most difficult skill to master in the game of basketball (Cooper John Miller, 1975).

Types of shooting

It has been previously suggested by various research that there are many types of shooting. John R. Wooden categorizes shooting into five main categories that are set shot, jump shot, under the basket or close-in shots, offensive rebounding and tipping, and free throws. He further classified set shot into two-handed set shot from chest, two-handed set for overhead, and one-handed set. Furthermore, he categorizes under the basket or close-in shots into ordinary layup, close-in shot following quick stop, short hook, lay-back, and reach back (Wooden, 1966). Unlike Wooden, Cooper and Siedentop classified shooting as set shot, hook shot, jump shot, layup (Cooper John Miller, 1975). Although different researchers divided shooting into different types, jump shots are defined by all studies as the most commonly used and most effective skills regarding shooting technique according to the literature.

The role of shooting in basketball

John R. Wooden noticed that “regardless of how well you do everything else, if you cannot put the ball through the hoop, you are not going to win games against the teams that can” (Wooden, 1966). Additionally, Wissel in his book presented that the initial skill players must develop is an accurate shot, which forces a defender to play the offense tight and allows the ball holder to pass and dribble as well as shoot easily (Wissel, 1994). In basketball, the fundamental skills of passing, dribbling is used during the game for open shooting that directly make a score. As a result, shooting plays an important role directly influencing the team's success. When it comes to shooting, the jump shot has been previously proved as the most efficient and important shooting technique. Studies have reported that jump shot accounts for more than 60% of field goal attempts in the Women’s National basketball Association (WNBA) in the 2010 season (Oudejans et al., 2012) and 67% of field goal attempts in the National Basketball Association (NBA) 2014 season (Boddington et al., 2019). The aforementioned game statistics is in line

with Wooden's perspective showing that it is advisable that a high percentage of the shooting practice should be spent on the development and improvement of the jump shot (Wooden, 1966).

Relevant literature

Given the importance of shooting in offence, it has prompted researchers to explore factors associated with its successful performance. Okazaki et al. in their review article investigated movement variables that contribute to shooting success (Okazaki and Rodacki, 2012). The review article demonstrated that a player's ability to make a successful jump shot gives him the following scoring advantages: (a) accuracy, (b) speed, (c) defense against an opponent, and (d) the ability to release the ball from a variety of distances away from the basket. Furthermore, Okazaki et al. reported several factors that influence shooting performance under a variety of conditions. They concluded that the following segmental movement variables are connected with greater release height: (a) reduced backward inclination of the trunk, (b) greater shoulder flexion and elbow extension at release, and (c) synchronizing ball release with the peak of the jump. Other factors influencing the performance of expert basketball jump shots include: (a) aligning the trunk close to vertical at release, (b) aligning the shoulder, elbow, and wrist in the same plane of motion, (c) releasing the ball at the highest point of the jump, (d) reducing horizontal displacement of the center of gravity during the shooting motion, (e) increasing movement time used by the shooter to select the control parameters used in the shooting motion, (e) keeping the ball close to the body during the preparation phase, and (f) generating less velocity by the lower limbs, upper limbs, and trunk to release the ball. Another review article investigated the jump performance in youth basketball. Authors reported that jump shot performance of youth basketball players is influenced by (a) distance to the basket, (b) fatigue, (c) presence of a defender and (d) visual information available. They further highlighted the importance of players and coaches optimizing training sessions that are similar to the real game situation in order to improve successful shooting performance in young basketball players (França et al., 2021). By searching from database, to date, the articles focusing on basketball shooting mainly related to technique evaluation (Zwierko et al., 2018, Pojskic et al., 2018, Verhoeven and Newell, 2016), biomechanics (Lam et al., 2009, Vencúrik et al., 2021, Okubo and Hubbard, 2015, Rojas et al., 2000, Li et al., 2021), factors influencing on shooting accuracy (Okazaki and Rodacki, 2012, Podmenik et al., 2012, Rupčić et al., 2020, Erculj and Supej, 2009), training effect on accuracy (Delextrat and Martinez, 2014, Chen et al., 2018, Bogdanis et al., 2007), learning methods (Porter et al., 2020, Chase et al., 1994, Arias, 2012, Silva et al.,

2017). However, although extensive research has been carried out on basketball shooting, little is known about the influence of fatigue on kinematics regarding female basketball players. Additionally, little is known about the influence of progressive physiological loads on kinematic parameters in junior basketball players. Furthermore, scientific literature assessing the kinematic and physical parameters of a jump shot presents only shots taken without any action before shooting (dribbling or cutting—no pull-up jump shots or catch-and-shoot jump shots). Measuring kinematic and physical parameters of a jump shot that are more similar to real game conditions is absent (e.g., catch-and-shoot situation after a cut). Moreover, comparing these parameters between gender is even less studied, having in mind the differences between males and females in physical performance.

Basketball dribbling

The concept and definition

Dribbling refers to the usually oft repeated, one-handed bouncing of the ball against the floor done by an offensive player. It is one of the many fundamental basketball skills that a player must master (Cooper John Miller, 1975). Additionally, Lehane defined dribbling as a technique used to advance in the court (towards the adversary court) possessing the ball by running and repeatedly bouncing the ball on the floor with one hand (Lehane, 1981). When the player wants to move rapidly on the court, with no defender between him and the basket, the speed dribble is used (Lehane, 1981, Summit PH, 1996)

Types of dribbling

Likewise, different basketball coaches and researchers divided dribbling into different elements. Wissel categorizes dribbling into nine main categories that are control dribble, speed dribble, foot fire dribble, change-of-pace dribble, retreat dribble, crossover dribble, inside-out dribble, reverse dribble, and behind back dribble (Wissel, 1994). John R. Wooden classified dribbling into low or control dribble, high or speed dribble, cross-over dribble, behind the back dribble, off-hand dribble (Wooden, 1966). Cooper John Miller in his book stated that the types of the dribbling are crossover dribble, single reverse dribble, spin dribble, behind the back dribble (Cooper John Miller, 1975). Unlike aforementioned studies, Krause & Nelson divided dribbling into in place, in a straight line, change-of-pace, and change of direction (Krause and Nelson, 2018).

The role of dribbling in basketball

Previous research reported that correct dribbling technique allows for more effective dribbling direction changes and reduces the number of turnovers (Conte et al., 2016, Andrić, 2011, Trninić et al., 2010), which benefit in acquiring an advantage during offensive actions (Arias-Estero, 2013). On the other hand, authors stated that an increasing number of errors increases the odds of defeat, while improved technique of dribbling reduces the number of errors, which leads to assists and the scoring of points (Ángel et al., 2006, Csataljay et al., 2009, Ibáñez et al., 2008). Additionally, Cooper and Siedentop in their book noticed that dribbling is considered by many not to be the most important offensive skill, but it should, perhaps, be the first skill that the young player learns to do (Cooper John Miller, 1975). If a player is unable to dribble

adequately, he will not be able to be offensively as effective as he could be. Furthermore, dribbling is employed in advancing the ball into the offensive court, in executing offensive maneuvers, in driving to the basket, in stalling, in fast breaking, and in almost all offensive situations that a player might encounter during a game. Thus, dribbling is significant in its direct contribution to offensive play (Cooper John Miller, 1975).

Relevant literature

Given the importance of the dribbling technique, various aspects have been investigated by previous studies (Robalo et al., 2020, Guimarães et al., 2019, Dos Santos et al., 2020). In the past, research relating to basketball dribbling mainly focused on four areas: game-related statistics (Scanlan et al., 2011, Scanlan et al., 2015, Andrić, 2011), technique improvement (Fujii et al., 2010), technique diagnosis (Robalo et al., 2020, Conte et al., 2020, Jakovljević et al., 2017), and the effect of supplement on dribbling performance (Scanlan et al., 2019). A number of studies investigated the frequency and efficiency of dribbling according to game-related statistics, reporting that dribbling skills are constantly used during basketball games with elite players dribbling during ~10% of the live time (Scanlan et al., 2011, Scanlan et al., 2015, Andrić, 2011). In terms of technique improvement, for example, Fujii et al. observed the differences of running velocity and trunk rotation during running while dribbling between competitive basketball players and non-professional players. They reported that basketball players rotated their shoulders significantly more while dribbling than running, suggesting basketball players' greater shoulder rotation during dribbling helps in decreasing their sprinting velocity (Fujii et al., 2010). In terms of technique diagnosis, many studies conduct testing to diagnose players' dribbling technique (Robalo et al., 2020, Conte et al., 2020, Jakovljević et al., 2017). For instance, Robalo et al. analyzed how professional and amateur players were affected by perceptual impairment within a dribbling task. The result demonstrated that when participants downwards peripheral vision was affected, professionals had much lower variability in wrist movements but significantly increased variability in shoulder horizontal movements (anterior-posterior and lateral), as well as lateral elbow motions (Robalo et al., 2020). There were a few studies investigating the effect of supplementary supply on dribbling performance. For example, Scanlan et al. investigated the effect of caffeine supplementation on dribbling speed in elite basketball players, reporting that caffeine has no ergogenic benefit to elite basketball players' dribbling speed. Their results even presented negative response to caffeine in one athlete, suggesting that caffeine supplementation may be deleterious to dribbling

speed in specific situations, emphasizing the importance of individualized investigations in nutrition-based sport-science research (Scanlan et al., 2019). Although previous studies have been carried out on basketball dribbling, the literature revealed few studies detecting the influence of fatigue on basketball dribbling.

Fatigue

The concept and definition

Fatigue can refer to a subjective symptom of malaise and aversion to activity or to objectively impaired performance and it has both physical and mental aspects. (Sharpe and Wilks, 2002). Enoka and Duchateau stated that fatigue is a disabling symptom in which physical and cognitive function is limited by interactions between performance fatigability and perceived fatigability. As a symptom, fatigue can only be measured by self-report, quantified as either a trait characteristic or a state variable (Enoka and Duchateau, 2016). Another study relating to sports noticed that fatigue can be defined as the reeducation in muscular capacity to generate force (Zagatto et al., 2017). To date, various studies have assessed the effect of fatigue on athletes' performance (Reilly et al., 2008, Peralta-Geis et al., 2021, Davey et al., 2002, Thorlund et al., 2008). Specific to this doctoral thesis, the details of the role of fatigue on basketball players' performance are presented below.

The role of fatigue in basketball players' performance

Studies related to game statistics reported that a basketball game lasts about 75 minutes and covers a total distance of 6.4 to 7.6 km, with 1.7 km, 1.6 km, and 2.5 km of high, moderate, and low intensity activities, respectively (Seitz et al., 2014, Ben Abdelkrim et al., 2010). Authors further stated that players sprint every 21 seconds on average and perform roughly 100 high-intensity, short-duration movements (e.g., jumping or sprinting) for about 34% of the game time (Narazaki et al., 2009).

Many studies have investigated the influence of fatigue on players' performance. Enoka reported that one factor that may interfere with the performance of a motor task is fatigue (Enoka, 1995). Another study stated that fatigue is known to negatively affect technical skills, and thus the ability to maintain the required high-intensity activities for the entire duration of the match is a crucial determinant of performance in basketball and other intermittent sports (Castagna et al., 2007, Erculj and Supej, 2009). Similarly, some studies observed the effect of different physiological load on shooting performance, reporting that the shooting accuracy significantly decreased when the physiological load was progressing (Rupčić et al., 2020, Erculj and Supej, 2009). Likewise, researchers investigated the influence of fatigue on basketball passing, showing that the passing accuracy decreased in fatigue condition compared to non-fatigue condition (Li et al., 2021, Lyons et al., 2006). Consequently, authors recommended that

it is specifically important that players are required to maintain a high level of technique under the influence of fatigue in order to win a game (Conte et al., 2017).

The relevant literature in basketball

To date, according to literature, the research relating to fatigue in basketball mainly focused on several areas that are monitoring the physiological load during the practice and game (Edwards et al., 2018, Clemente et al., 2019, Bonfanti and Lorenzo, 2015), the influence of fatigue on players' performance (Alarcon et al., 2017, Rashid et al., 2020, Lyons et al., 2006), the recovery strategy after training or game (Wang, 2015, Montgomery et al., 2008, Kaesaman and Eungpinichpong, 2019, Madueno et al., 2018). For instance, Stojanović investigated the physiological demands of basketball competitions with a system review, reporting that during live playing time across 40-minute games, female and male players covered an average distance of 5–6 km (Stojanović et al., 2018). Physiological traits such as blood lactate and heart rate responses to competition demands reveal that athletes are competing at an average physiological intensity above lactate threshold and 85% maximum heart rate (Stojanović et al., 2018). Madueno et al. observed the difference between passive and active recovery strategy for reduced fatigue in terms of repeated-change-of-direction sprints in basketball players, demonstrating that the passive recovery involving repeated-change-of-direction sprints may reduce physiological stress and fatigue in basketball players when compared to active recovery (Madueno et al., 2018).

Kinematic parameter

The concept and definition

Kinematic parameters represent the time-dependent geometric changes associated with movement, independent of the forces that cause movement (Elvan and Ozyurek, 2020). Another study demonstrated that kinematics describes the movement of body segments neglecting the masses (Raghu et al., 2021). Additionally, they stated kinematic parameters can be a combination of linear and angular components (position, linear velocity, and linear acceleration; orientation, angular velocity, and angular acceleration).

In order to further understand its concept, authors stated that kinematics research investigates the change of body position through time as joints, bones, and segments in the characterization of human movements (Patrona et al., 2018). Movement changes can be identified in the segment or in a segment apart from the segment connected to the overall evaluation of the body (Raghu et al., 2021). When evaluating the kinematic data, it is possible to believe that the movement of the associated segment has risen or reduced, or that there are early or late joint movement angles in a given movement pattern. Additionally, kinematics is uninvolved in the magnitude of force necessary for these motions, or the amount of force generated during these movements (Dicharry, 2010). Authors further stated that kinematics is the branch of classical mechanics that describes the motion of points, objects, and systems of groups of objects without considering the mass of each or the forces that caused the motion. However, from kinesiological perspective, kinematics is explored as the motions of human body properties (Elvan and Ozyurek, 2020). On the other hand, some studies stated that kinematics is a further subdivision of biomechanics (Hall, 2015, Nordin and Frankel, 2001, Neumann, 2016). Kinematics can be seen as the cinematic of a movement, or as the similarity between the words and it is concerned with the appearance of a body's motion. Timing and sequencing are two aspects of movement in which kinematics is engaged (Hall, 2015, Nordin and Frankel, 2001, Neumann, 2016). When it comes to biomechanics, it is a way of understanding how internal and external forces interact with human body structures using physical rules and it relates mechanics disciplines such as statics, dynamic, solid, and fluid mechanics to the human body (McGinnis, 2013).

The role of kinematic analysis in basketball

Kinematic analysis of movement involves the measurement of position, velocity, and acceleration of one or more body parts (Singer et al., 2016). It is used to determine the time course of changes in position and orientation of body segments, as well as the geometry of motion in terms of displacements, velocities, and accelerations, without considering the kinetics of motion generation (Arslan et al., 2019). Previous studies have reported that kinematic analysis may be conducted on fundamental movements or sport-specific tasks to identify the differences of movement parameters and identify injury risks (Pappas and Carpes, 2012, Zifchock et al., 2008, Gundersen et al., 1989). Furthermore, Hu et al. and Arslan et al. stated that kinematic analysis enables research to quantitatively evaluate, identify, and interpret the movement, as well as to identify sports injury risks in a reliable and quantitative manner (Arslan et al., 2019, Hu et al., 2020).

The relevant literature in basketball fundamental skills

With the development of technology, more and more advanced equipment is used to evaluate basketball players' technique (e.g., 3D motions capture system, smart sensor ball, witty timing system). According to literature, kinematic analysis regarding basketball fundamental skills was mainly applied in shooting (Miller and Bartlett, 1993, Rupčić et al., 2020, Li et al., 2021). For example, Miller and Bartlett investigated the kinematic parameters of basketball shooting performed from different distances, reporting that the kinematics of the joints in the player's shooting arm and the body center-of-mass were the parameters that primarily affect the shooting distance. They further stated that greater shoulder flexion, elbow extension angular velocities and center-of-mass speed increased the release speed at all shooting distances (Miller and Bartlett, 1993). Additionally, a study observed the effect of increased shooting distance (free throw, perimeter, and three points shots) on energy flow in basketball jump shot, showing that the joint work was not significantly different for free throw and perimeter shots. However, the amount of energy transferred from the torso to the shooting arm by the shoulder joint force increased significantly for the perimeter shots. Furthermore, it was found that the joint work in the lower limbs increased significantly between the perimeter and three points shots (Nakano et al., 2020). Therefore, they concluded that sufficient energy transfer from the lower limbs to the upper arms is required to keep the shooting arms' motions nearly constant when shooting from varying distances. Moreover, some studies noticed that greater ball release velocity (Satern, 1993, Miller and Bartlett, 1993), greater shoulder flexion, greater elbow extension, and

increased center of mass displacement towards the basket were considered as compensatory strategies when shooting distance was increased (Okazaki and Rodacki, 2012). On the other hand, there are some studies investigating the influence of fatigue on shooting performance using kinematic analysis. Erculj and Supej observed the influence of fatigue on kinematic parameters in shooting, revealing that the position of the release arm and shoulder statistically significant changed when players were under the moderate and high-intensity fatigue level (Erculj and Supej, 2009). Unlike Erculj and Supej, Uygur et al. investigate the influence of fatigue on kinematic parameters in free throw shooting, showing that fatigue did not affect selected kinematic variables in free throw shooting (Uygur et al., 2010). As previously stated, many research has been conducted to investigate shooting technique using kinematic analysis. However, little research has been conducted on basketball passing and dribbling adopting kinematic analysis according to literature.

CHAPTER 3: ORIGINAL STUDIES

Study 1: Influence of Fatigue on Some Kinematic Parameters of Basketball Passing

Li, F., Knjaz, D., & Rupčić, T. (2021). Influence of Fatigue on Some Kinematic Parameters of Basketball Passing. *International Journal of Environmental Research and Public Health*, 18(2), 700. <http://dx.doi.org/10.3390/ijerph18020700>



International Journal of Environmental Research and Public Health, 18(2), 700.

doi: 10.3390/ijerph18020700.

Manuscript submitted for publication: 9 December 2020

Manuscript accepted for publication: 14 January 2021

Journal impact factor: 3.390

Indexed/Abstracted in: MEDLINE and Web of Science (WoS).

ISSN: 1661-7827 (Print); 1660-4601 (Online)



Article

Influence of Fatigue on Some Kinematic Parameters of Basketball Passing

Feng Li *, Damir Knjaz and Tomislav Rupčić

Laboratory for Sports Games, Faculty of Kinesiology, University of Zagreb, 10000 Zagreb, Croatia; damir.knjaz@kif.unizg.hr (D.K.); tomislav.rupcic@kif.unizg.hr (T.R.)

* Correspondence: li.feng@kif.unizg.hr

Abstract: Kinematic analysis is an objective method for examining basketball technique. However, there are just a few studies featuring a kinematic analysis of passing. The purpose of this study was to determine whether the kinematic parameters and accuracy of passing changed when players were under the influence of fatigue. Eleven Croatian basketball players who are members of the youth national program (age: 18.36 ± 0.67 years; height: 192.32 ± 9.98 cm; weight: 83.35 ± 11.19 kg; body fat: $15.00 \pm 4.40\%$, arm span: 194.34 ± 10.39 cm) participated in fatigue and non-fatigue repetitive tests. A Xsens suit was used to analyze the kinematic parameters of push passing; a radar gun was used to determine ball speed; heart rate and blood lactate were used to identify fatigue and non-fatigue state. There was a significant difference in angular velocities of shoulder ($p = 0.01$), elbow ($p = 0.04$), and wrist ($p = 0.01$), accuracy ($p = 0.01$), ball speed ($p = 0.00$), pelvis position ($p = 0.00$), and velocity of the pelvis in X-axis ($p = 0.00$) between fatigue and non-fatigue state. Fatigue influences some kinematic parameters and accuracy of passing. The findings of this study suggest that coaches conduct as many drills as possible in situational conditions that are similar to the conditions during the basketball game itself.

Keywords: angular velocity; accuracy; pelvis; ball speed



check for
updates

1. Introduction

The fundamental skills are the foundation for success at all levels of basketball, and all players must learn to execute them properly and quickly in order to be successful [1,2]. In basketball, passing is one of the most frequently used techniques during a competitive game [3,4]. There was a study reporting that passing technique is even the optimal factor to determine all-star and non-all-star NBA players [5]. During the offense, players are required to keep possession of the ball and cooperate to create optimal shooting options. Teams that assist more are more likely to win the game [6]. On the other hand, reducing the number of turnovers (i.e., lost possession of the ball) increases the chances of winning, especially in games where opponents have similar chances of winning [7]. Another aspect stated that players can have at least 50% efficiency in shooting but must have 100% in passing the ball [8].

Therefore, given the importance of passing in basketball skills, coaches should be persistent in developing passing skill.

From a physiological point of view, basketball is an intermittent sport that involves both intensive brief movements (e.g., jumping, sliding, and sprinting) and less intensive long-lasting activities (e.g., walking and running). Thus, the players' physiological demands of a basketball game, which require both aerobic and anaerobic energy systems, are claimed to be high [9]. Some studies found that the blood lactate levels, mean heart rates, and VO₂ max of the players during a competitive game were close to their maximal values [10–12].

Fatigue becomes an unavoidable part of the game that may deteriorate performance, coordination, and the players' technique [13]. Some players have highly developed skills, but their quality of performance can be impaired under the influence of fatigue, which will consequently impair their efficiency in the game. The changes of kinematic parameters under the influence of fatigue in basketball (e.g., trajectory of ball flight, joint angles in upper and lower extremity, and center of mass) have generally been investigated when shooting, where authors proved that fatigue can affect changes in some kinematic parameters when shooting from different playing positions [14–16].

On the other hand, there are only a few studies that investigated the change of passing accuracy under fatigue [17,18]. However, these studies mainly focused on passing accuracy or ability, while no kinematic parameters were observed. Thereby, certain movement patterns of passing in different conditions still remain mostly unexplored.

The kinematic analysis represents an objective method to observe basketball players' passing skills [19], which can provide a scientific explanation for mistakes in passing performance,

especially under fatigue. In a study by Theoharopoulos et al [20], chest pass, overhead, and push pass were the most commonly used in basketball games, with the latter having importance when the players face defense pressure. However, there is no research focusing on the push passing in terms of passing accuracy and kinematic analysis under fatigue. Therefore, the aim of this study is twofold: (i) to examine whether the kinematic parameters of push passing changed when a player is under the influence of fatigue; (ii) to identify if the fatigue affects the passing accuracy. It was hypothesized that the kinematic parameters would be changed, and the passing accuracy would be decreased when a player is under the influence of fatigue.

2. Materials and Methods

2.1. Participants

The sample consisted of 11 Croatian basketball players (age: 18.36 ± 0.67 years; height: 192.32 ± 9.98 cm; weight: 83.35 ± 11.19 kg; body fat: 15.00 ± 4.40 %, arm span: 194.34 ± 10.39 cm) who are members of the Croatian youth national program. Players had no health nor injury issues. In order to avoid the interference of fatigue on testing, players were asked to restrain from training sessions one day before testing. All participants were provided with a detailed explanation of the study procedures and gave written informed consent prior to the measuring procedure. The Faculty of Kinesiology, University of Zagreb (Croatia) Ethics Committee approved the study, which was performed following the ethical standards of the Declaration of Helsinki.

2.2. Experimental Procedures

Each player was tested in one day, but the overall testing was conducted during three days in the following manner: three players were tested on the first day, and the other eight participants were tested on the following two days (i.e., four players on each day). All players underwent the same protocol: before testing, they had one day of rest, while the testing performed the next day consisted of warm up, non-fatigue passing testing, fatigue protocol, and fatigue passing testing. Basic anthropometric characteristics were measured on each day of the testing and used for system calibration performed according to the instruction of the manufacturer (Xsens technologies B.V., Netherlands). In order to identify the level of players' fatigue, their Heart Rate (HR) and Blood Lactate (BL) were measured by heart rate sensors (Polar H10, manufacturer: Polar, Kempele, Finland) and a portable lactate analyzer (Lactate Scout 3, manufacturer: SensLab GmbH, Leipzig, Germany) respectively before starting the test. In addition, the participants' HR and BL were measured once more immediately after conducting

the fatigue protocol. Then, the same passing test was conducted again in order to observe the change of passing accuracy and kinematic parameters under the influence of fatigue.

The following variables were observed: pelvis position from the point the player caught the ball until release (PELVIS_P) (cm); pelvis velocity in X-axis from the point the player caught the ball until release (PELVIS_Xaxis) (m/s); pelvis velocity in Y-axis from the point the player caught the ball until release (PELVIS_Yaxis) (m/s); maximum angular velocities in shoulder from the point the player started to pass the ball until release (SHOULDER_AVmax) ($^{\circ}$ /s), maximum angular velocities in elbow from the point the player started to pass the ball until release (ELBOW_AVmax) ($^{\circ}$ /s), and maximum angular velocities in wrist from the point the player started to pass the ball until release (WRIST_AVmax) ($^{\circ}$ /s); the speed of ball approaching the target (BALL_S) (km/h); and the passing accuracy (ACCURACY) (points).

To measure kinematic variables, the Xsens MVN inertial suit system was used with 17 three dimensional accelerometers/gyroscopes/magnetometers. The kinematic parameters of push passing were derived from the corresponding MVN BIOMECH software (MVN Studio 4.4, firmware version 4.3.1). Previous study has confirmed the reliability and validity of Xsens kinematic suit for analyzing angular velocity and other kinematic parameters in different basketball techniques [21]. In addition, it was used in previous study for measuring similar data in the field of basketball [22]. The ball speed was measured by a radar gun (Stalker ATS 2, manufacturer: Stalker Sport, Texas, USA) with its reliability being previously proved in the sport field [23,24].

2.3. Test Protocol

As shown in Figures 1 and 2, two hoops were placed vertically near the left and the right court corner 1.30 m above the ground. The distance between the hoops and the basket was 6.20 m, and the distance between the hoops and the top of the three-point line was 9 m. Participants were standing in the middle of the free throw line with their back to the basket. Two basketball players were standing on the wing of both the left and the right side, passing the ball to the participant. The participant ran to the top of the three-point line and received the ball; then, they did a crossover with one dribble and passed the ball with the right hand toward the right target (hoop). After passing to the right target, the player ran to the left side and repeated the same task. Players executed six passes to the right and left sides, respectively. Due to some technical issues with equipment and motor movement, there were several passes that were not taken for further analysis. Prior to the test, the players had three trial passes. The warmup consisted of 5 min of jogging and 5 min of specific stretching. According to a previous study [18], the test scoring was as follows:

Eight points were awarded for each pass that hit the target without touching the hoop.
 Six points were awarded for each pass that hit the target but touched the hoop once.
 Four points were awarded for each pass that hit the target but touched the hoop more than once.
 Two points were awarded for each pass that did not hit the target but touched the hoop.
 No points were awarded if the ball did not hit the target nor touch the hoop, or if a pass other than a push pass was used.

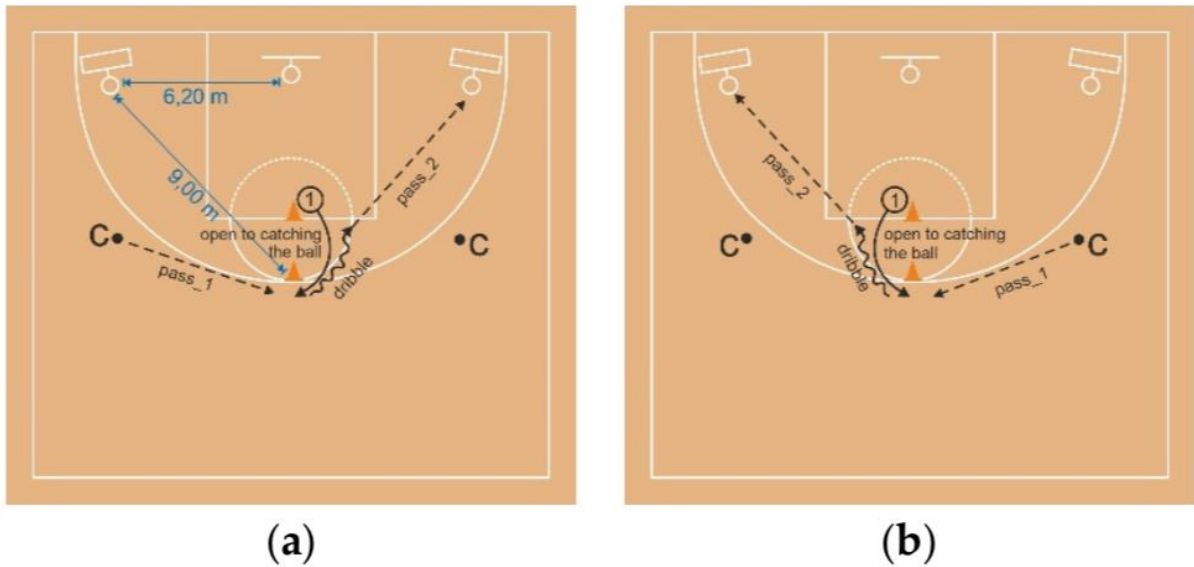

Figure 1. (a) Push pass on the right side

(b) push pass on the left side

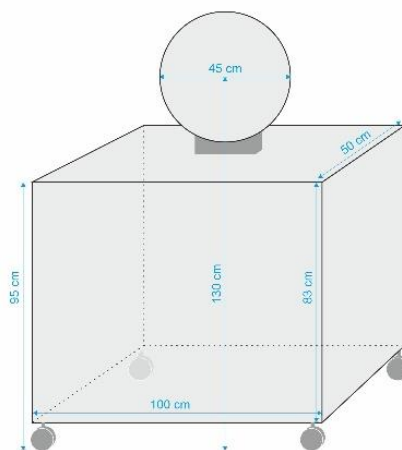

Figure 2. Sketch of the target

2.4. Fatigue Protocol

The 300-meter shuttle run (15×20m with the change of direction of 180°) was used as fatigue protocol due to similarities with game situations in which a player runs forward and backwards

consecutively. The reliability of this fatigue protocol was previously verified [25–26]. Players were instructed to sprint as fast as possible during the fatigue protocol, and the running time was recorded by photocells (WittyGate, manufacturer: Microgate, Bolzano, Italy).

2.5. Data Analysis

“Statistica” version 13.5.0.17 (manufacturer: TIBCO Software Inc, Palo Alto, CA; release date: November 2018) was used for the statistical analysis. Basic descriptive parameters were calculated for all measured variables. The normality of the data distribution was evaluated using Kolmogorov–Smirnov test. To verify the differences of the kinematic parameters between fatigue and non-fatigue, analysis of variance (ANOVA) for repeated measures was applied. With the use of the G*power program, the sample size (number of passes) was calculated ($n = 98$) that was needed for measurement procedure with statistical significance $p < 0.05$; statistical power 0.8; effect size 0.25 and groups.

3. Results

As shown in Table 1, the mean value of passing accuracy (ACCURACY) when players were under the influence of fatigue was decreased compared to non-fatigue condition (fatigue = 1.93; non-fatigue = 2.81); the mean value of maximum angular velocity in non-fatigue condition was higher than fatigue condition, regardless of shoulder (SHOULDER_AVmax) (non-fatigue = 731.39; fatigue = 662.73), elbow (ELBOW_AVmax) (non-fatigue = 1264.64; fatigue = 1212.35), and wrist joint (WRIST_AVmax) (non-fatigue = 1531.42; fatigue = 1306.75). The mean value of maximum angular velocity in wrist joint (WRIST_AVmax) was obviously higher than in elbow (ELBOW_AVmax) and shoulder (SHOULDER_AVmax) both in fatigue and non-fatigue conditions (Figure 4); the mean value of pelvis position (PELVIS_P) when players were under fatigue was increased compared to the non-fatigue condition (fatigue = 0.93; non-fatigue = 0.89); the pelvis velocity in X-axis (PELVIS_Xaxis) and Y-axis (PELVIS_Yaxis) when players were under fatigue was lower than in non-fatigue condition; the ball speed (BALL_S) when players were under fatigue was decreased compared to non-fatigue condition (fatigue = 39.96; non-fatigue = 42.38).

In addition, the results in Table 1 indicated that there was a significant difference between fatigue and non-fatigue conditions in angular velocities in terms of shoulder (SHOULDER_AVmax; $p = 0.01$), elbow (ELBOW_AVmax; $p = 0.04$) and wrist (WRIST_AVmax; $p = 0.01$). In addition, there were significant differences in passing accuracy (ACCURACY; $p = 0.01$) and ball speed (BALL_S; $p = 0.00$) between fatigue and non-fatigue conditions; there were significant differences in the pelvis position (PELVIS_P; $p = 0.00$) and

the pelvis velocity X-axis (PELVIS_Xaxis; $p = 0.00$) between fatigue and non-fatigue conditions. However, there was no significant difference in the pelvis Y-axis (PELVIS_Yaxis; $p = 0.12$).

Table 1. Descriptive parameters and result of ANOVA for repeated measures of the fatigue and non-fatigue conditions.

Variable	Group	N	Mean	Min	Max	Std.Dev.	F	<i>p</i>
SHOULDER_AV _{max} (°/s)	Non-fatigue	114	731.39	398.63	1313.97	192.23	6.59	0.01 *
	Fatigue	114	662.73	261.04	1375.02	211.27		
ELBOW_AV _{max} (°/s)	Non-fatigue	114	1264.64	884.77	1811.54	183.12	4.31	0.04 *
	Fatigue	114	1212.35	454.63	1674.74	196.87		
WRIST_AV _{max} (°/s)	Non-fatigue	114	1531.42	436.90	4476.40	766.39	6.91	0.01 *
	Fatigue	114	1306.75	390.11	3010.93	495.51		
PELVIS_P (cm)	Non-fatigue	114	0.89	0.73	1.00	0.068	18.02	0.00 *
	Fatigue	114	0.93	0.79	1.17	0.09		
PELVIS_X _{axis} (m/s)	Non-fatigue	114	2.96	0.47	4.32	0.76	13.05	0.00 *
	Fatigue	114	2.54	0.10	4.10	0.96		
PELVIS_Y _{axis} (m/s)	Non-fatigue	114	2.12	0.20	3.87	0.72	2.50	0.12
	Fatigue	114	1.98	0.40	3.44	0.62		
BALL_S (km/h)	Non-fatigue	114	42.38	33.70	56.00	4.25	15.04	0.00 *
	Fatigue	114	39.96	24.00	58.00	5.15		
ACCURACY (points)	Non-fatigue	114	2.81	0.00	8.00	2.80	6.71	0.01 *
	Fatigue	114	1.93	0.00	8.00	2.29		

* Marked values were significant when $p < 0.05$. Legend: SHOULDER_AV_{max}: maximum angular velocity of shoulder joint from the point the player started to pass the ball until release; ELBOW_AV_{max}: maximum angular velocity of elbow joint from the point the player started to pass the ball until release; WRIST_AV_{max}: maximum angular velocity of wrist joint from the point the player started to pass the ball until release; PELVIS_P: the position of player's pelvis from the point the player caught the ball until release; PELVIS_X_{axis}: the velocity of pelvis in X-axis from the point the player caught the ball until release; PELVIS_Y_{axis}: the velocity of pelvis in Y-axis from the point the player caught the ball until release; BALL_S: the speed of the ball approaching to the target; ACCURACY: the passing accuracy.

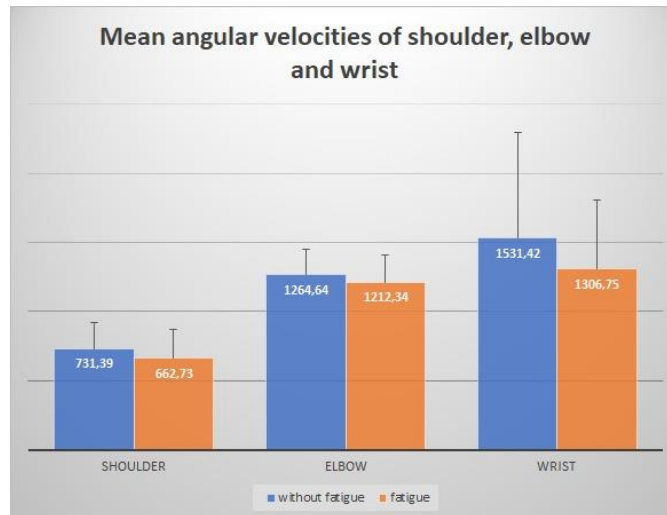

Figure 4. Comparison of angular velocities between fatigue and non-fatigue.

As presented in Table 2, the mean values of players' HR and BL under the influence of fatigue were obviously higher than in non-fatigue condition (fatigue: HR = 186.82; BL = 10.35; non-fatigue: HR = 87.82; BL = 1.45).

Table 2. Descriptive statistics of Heart Rate (HR) and Blood Lactate (BL) when players were under different physio-logical load.

Variable	N	Mean	Minimum	Maximum	Std.Dev.
HR_non_F (beats/min)	11	87.82	68.00	106.00	11.05
Max_HR_non_F (beats/min)	11	179.55	165.00	200.00	11.12
HR_F (beats/min)	11	186.82	170.00	201.00	9.04
Max_HR_F (beats/min)	11	182.18	169.00	196.00	8.22
BL_non_F (mmol/l)	11	1.45	0.80	1.90	0.36
BL_F (mmol/l)	11	10.35	7.10	13.30	2.18
300 m shuttle run (s)	11	74.87	68.36	84.27	5.13

Legend: HR_non_F: The players' heart rate in non-fatigue condition; Max_HR_non_F: The players' maximum heart rate in non-fatigue condition during passing; HR_F: The players' heart rate under the influence of fatigue; Max_HR_F: The players' maximum heart rate under the influence of fatigue during passing; BL_non_F: The players' blood lactate in non-fatigue condition; BL_F: The players' blood lactate after the fatigue protocol.

Table 3 shows that there was significant difference in push passing between the fatigue and non-fatigue conditions ($F = 9.65$, $p = 0.00$).

Table 3. Result of ANOVA for repeated measures (for groups).

Test	Value	F	p
Wilks	0.74	9.65	0.00 *

*Marked values were significant when $p < 0.05$.

4. Discussion

There were few studies observing the change of kinematic parameters and accuracy of basketball passing under physiological load. The present study aimed to identify whether some kinematic parameters of push passing changed when players were under the influence of fatigue and to examine if fatigue affected the passing accuracy. The main findings from this study showed that there were significant differences between non-fatigue and fatigue conditions in kinematic parameters and passing accuracy, which is in line with our previously formulated hypotheses.

Physiological variables such as HR and BL can be measured not only in sterile laboratory conditions but also on field and in more authentic conditions [27]. HR and BL have been used in many studies to monitor the level of athletes' fatigue [28–31]. In this study, the mean value of HR was 186.82 beats/min, and the BL was 10.35 mmol/l during the testing. McInnes et al. [11] investigated the intensities of a real basketball competition by using a heart rate monitor. The results showed that the highest value of HR during the game was 188 beats/min. Another research by Abdelkrim et al. [10] reported that the highest BL concentration in a basketball game was 13.2 mmol/l varying from the player's position and the level of competition. Consequently, it can be concluded that the level of players' fatigue in this study was at the level of players' fatigue in the actual situational conditions during the game.

The results from this study showed that there were significant differences between non-fatigue and fatigue conditions in kinematic parameters. Slawinski et al. [16] investigated the influence of fatigue on the change of kinematics and accuracy in basketball shooting. They reported that the fatigue decreased hip joint angle and increased shoulder joint angle. Another two studies focused on the effect of progressive fatigue on the kinematic change of the longer shooting distance [14–15]. Their results showed that fatigue had a great influence on all kinematic parameters measured in their study. Therefore, the results of this study were similar to their results, which means that fatigue had a great influence on important kinematic parameters in performing basic elements of basketball technique.

There was also a significant difference in passing accuracy and the speed of the ball approaching the target. A few studies investigated the change of passing accuracy related to fatigue. There were two studies investigating the impact of fatigue on the accuracy of basketball chest passing, and their results showed that there was a significant difference in passing accuracy when players were under the influence of fatigue [17,18]. The result of the present study is consistent with previous studies.

In this study, the PELVIS_P in fatigue condition was significantly higher than in non-fatigue condition. Some previous studies have stated that decreases of lower limb muscle activation due to fatigue could result in changes in PELVIS_P, and the reduction of strength tended to increase the player's center of mass [32–33]. Lafond et al. [34] pointed out that the higher center of mass may reduce the ability of balance, and Boccolini et al. [35] reported that the role of postural balance appeared to be important in shooting performance. Given that, it could be assumed that higher PELVIS_P implied a lower level of balance during passing performance, and the poor balance could consequently lead to a decrease of the passing accuracy.

Fatigue can cause the reduction in the capacity of the muscle to generate force, which results in a player who is unable to continue moving at the same level of performance [15,36–37]. In addition, Kauranen et al. [38] reported that the increase in the strength of the upper extremities improved the coordination and velocity of movement. In this study, the value of upper extremity angular velocity, accuracy, and speed of the ball approaching the target in fatigue condition were greatly decreased compared to non-fatigue. This can be explained by the fact that fatigue affected the reduction of muscle strength and coordination, which ultimately reduced angular velocities in individual joint systems, the accuracy of the pass, and the speed of the ball during the pass.

It was clear that the mean value of WRIST_AVmax was higher than ELBOW_AVmax, and that of ELBOW_AVmax was higher than SHOULDER_AVmax both in fatigue and non-fatigue conditions (Figure 4). The body segments move in a certain sequence for multiple joint movements—the force is transmitted from the proximal to the distal body parts [39,40]. In addition, there were some studies that stated that greater velocities during shooting were associated with the strategies of the reuse of the energy transferred from the lower extremity to upper extremity [41–44]. Similarly, in the technique of push passing, the sequence of movement of the upper extremity is shoulder, elbow, and wrist (Figure 4), and the force of wrist joint is transferred from elbow and shoulder. The previously mentioned sequence of movement is constant regardless of players' physiological condition. Components that can vary depending on influence of fatigue are values of forces and angular velocities.

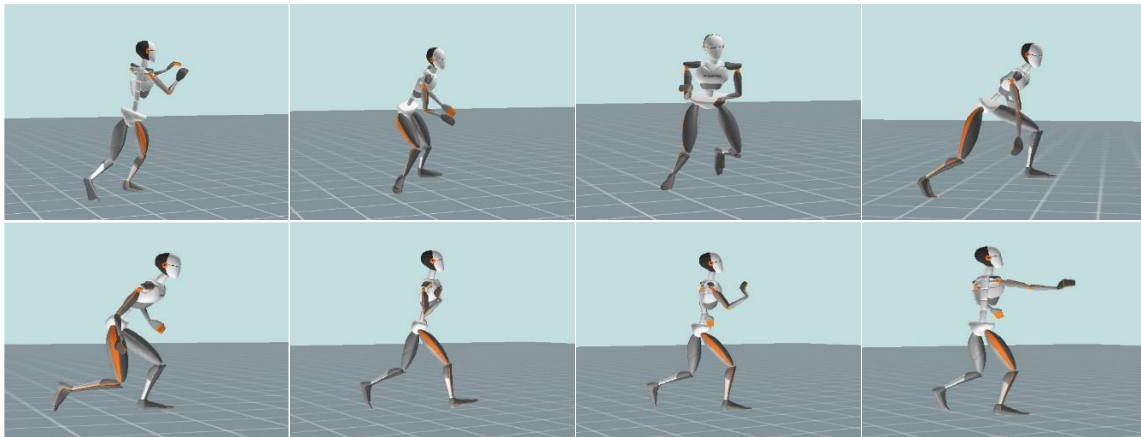

Figure 4. Kinogram from the point of catching the ball until releasing it from the wrist.

The PELVIS_Xaxis was higher than in PELVIS_Yaxis both in fatigue and non-fatigue conditions, which reflected that the players were using correct technique during the testing. In order to pass by the defender, the drive needs to be performed in the direction of the basket [45]. Thus, the velocity in the direction of forward (X) should be higher than the direction of side (Y) that is mainly for creating space for drive toward the basket. The results in this study showed that there was a significant difference in PELVIS_Xaxis ($p = 0.00$) between fatigue and non-fatigue conditions. It is very important to perform crossover with a quick first step after receiving the ball so that the offensive player can take an advantage over the defensive player. In that situation, another defensive player on the helping side tries to stop the player's drive to the basket. That movement creates a situation for passing to an open offensive player who stays at the corner and waits for the pass and open shot or drive. In this study, the PELVIS_Xaxis was decreased after fatigue protocol, which means that the player did not have enough velocity to pass by the defender to the basket and probably would not attract the help of the defender. As a result of that, the offensive player who stayed at the corner lost the opportunity to catch the ball and shoot.

Limitations

The presented study focused on the technique of push passing, but different kinds of passing can be used in a game as well. Thus, it is worth exploring the change of kinematic parameters on other passing techniques such as chest or overhead passing. In addition, the limitation of this study was the situation that the testing was performed without defensive players who can be included in some future research.

Therefore, these factors are worth analyzing in the future studies related to passing technique.

5. Conclusions

There were significant differences in maximum angular velocity of shoulder, elbow, and wrist between fatigue and non-fatigue. The passing accuracy and ball speed when players were under the influence of fatigue were significantly decreased compared to non-fatigue condition. The players' pelvis position was obviously increased when they were under fatigue. There was a significant difference in pelvis velocity related to X-axis between fatigue and non-fatigue; however, there was no significant difference in Y-axis. The findings of this study could also help coaches better understand the pattern of movement of push passing and correct players' technique.

It is extremely important that players adopt the correct motor structure of passing to create an automatism during the training process of learning, which will ultimately not change even under the influence of fatigue. Only this can ensure the situational efficiency of the player, because any deviation from the ideal biomechanical structure also affects the occurrence of a larger number of motor errors, and consequently reduced efficiency.

From the aspect of cooperation between two players in offense, in addition to the correctly adopted movement structure, it is also necessary to perfect spatial–temporal relations in passing and catching the ball, which is possible if the conditions of the players' training process are similar to the conditions of the game.

Author Contributions: Conceptualization and methodology, F.L., D.K., T.R.; formal analysis, F.L. and T.R.; investigation, F.L., T.R.; resources, D.K. and T.R.; data curation, F.L.; writing—original draft preparation, F.L.; writing—review and editing, T.R., D.K. and F.L. All authors have read and agreed to the published version of the manuscript.

Funding: This research received no external funding.

Institutional Review Board Statement: The study was conducted according to the guidelines of the Declaration of Helsinki and approved by the Ethics Committee of Faculty of Kinesiology of University of Zagreb (ethical code 108/2020, 27 November 2020).

Informed Consent Statement: Informed consent was obtained from all subjects involved in the study.

Data Availability Statement: The data presented in this study are available on request from the corresponding author. The data are not publicly available due to its huge size and participants' privacy protection.

Acknowledgments: The support provided by China Scholarship Council (CSC) during studying of Feng Li at University of Zagreb is acknowledged. The authors would also like to acknowledge with considerable gratitude all those who volunteered to take part in this study.

Conflicts of Interest: The authors declare no conflict of interest.

References

1. KRAUSE, J.V., NELSON, C. 2018. Basketball skills & drills; Human Kinetics.
2. KRAUSE, J., MEYER, D., MEYER, J. 2008. Basketball skills and drills; Human Kinetics.
3. NUNES, H., IGLESIAS, X., DAZA, G., IRURTIA, A., CAPARRÓS, T., ANGUERA, M. 2016. The influence of pick and roll in attacking play in top-level basketball. *Cuadernos de Psicología Del Deporte*, 16, 129-142.
4. IBÁÑEZ, S.J., SAMPAIO, J., FEU, S., LORENZO, A., GÓMEZ, M.A., ORTEGA, E. 2008. Basketball game-related statistics that discriminate between teams' season-long success. *European Journal of Sport Science*, 8, 369-372.
5. SAMPAIO, J., MCGARRY, T., CALLEJA-GONZÁLEZ, J., JIMÉNEZ SÁIZ, S., SCHELLING, I.D.A.X., BALCIUNAS, M. 2015. Exploring game performance in the national basketball association using player tracking data. *PloS one*, 10, e0132894, doi: 10.1371/journal.pone.0132894.
6. GARCÍA, J., IBÁÑEZ, S.J., DE SANTOS, R.M., LEITE, N., SAMPAIO, J. 2013. Identifying basketball performance indicators in regular season and playoff games. *Journal of Human Kinetics*, 36, 161-168.
7. GÓMEZ, M.Á., LORENZO, A., JIMÉNEZ, S., NAVARRO, R.M., SAMPAIO, J. 2015. Examining choking in basketball: effects of game outcome and situational variables during last 5 minutes and overtimes. *Perceptual and Motor Skills*, 120, 111-124.
8. LEONOV, A., MALVIZ, A.A. 1990. Basketball for children; Salto publ: Thessaloniki.
9. EDWARDS, T., SPITERI, T., PIGGOTT, B., BONHOTAL, J., HAFF, G.G., JOYCE, C. 2018. Monitoring and Managing Fatigue in Basketball. *Sports*, 6(1), 19.

10. ABDELKRIM, N.B., EL FAZAA, S., EL ATI, J. 2007. Time–motion analysis and physiological data of elite under-19-year-old basketball players during competition. *British Journal of Sports Medicine*, 41, 69-75.
11. MCINNES, S., CARLSON, J., JONES, C., MCKENNA, M. 1995. The physiological load imposed on basketball players during competition. *Journal of Sports Sciences*, 13, 387-397.
12. MONTGOMERY, P.G., PYNE, D.B., MINAHAN, C.L. 2010. The physical and physiological demands of basketball training and competition. *Human kinetics journals*, 5, 75-86.
13. FORESTIER, N., NOUGIER, V. 1998. The effects of muscular fatigue on the coordination of a multijoint movement in human. *Neuroscience Letters*, 252, 187-190.
14. ERČULJ, F., SUPEJ, M. 2006. The impact of fatigue on jump shot height and accuracy over a longer shooting distance in basketball. *Baltic Journal of Sport and Health Sciences*, 4(63), 35-41.
15. ERCULJ, F., SUPEJ, M. 2009. Impact of fatigue on the position of the release arm and shoulder girdle over a longer shooting distance for an elite basketball player. *The Journal of Strength and Conditioning Research*, 23, 1029-1036, doi:10.1519/JSC.0b013e3181a07a27.
16. SLAWINSKI, J., POLI, J., KARGANOVIC, S., KHAZOOM, C., DINU, D. 2015. Effect of fatigue on basketball three points shot kinematics. In *Proceedings of 33 International Conference of Biomechanics in Sports*.
17. AHMED, T. 2013. The effect of upper extremity fatigue on grip strength and passing accuracy in junior basketball players. *Journal of Human Kinetics*, 37, 71-79.
18. LYONS, M., AL-NAKEEB, Y., NEVILL, A. 2006. The impact of moderate and high intensity total body fatigue on passing accuracy in expert and novice basketball players. *Journal of Sports Science & Medicine*, 5, 215.
19. HU, X., MO, S., QU, X. 2020. Basketball Activity Classification Based on Upper Body Kinematics and Dynamic Time Warping. *International Journal of Sports Medicine*, 41, 255-263, doi:10.1055/a-1065-2044.
20. THEOHAROPOULOS, A., LAPARIDIS, K.K., GALAZOULAS, C., TSITSKARIS, G. 2010. A comparative study relating pass between male and female basketball players. *Journal of Physical Education & Sport*, 26.
21. ROBERT-LACHAINE, X., MECHERI, H., LARUE, C., PLAMONDON, A. 2017. Validation of inertial measurement units with an optoelectronic system for whole-body motion analysis. *Medical & Biological Engineering & Computing*, 55, 609-619.

22. SLAWINSKI, J.P., LOUIS, J., POLI, J., TIOLLIER, E., KHAZOOM, C., DINU, D. 2018. The effects of repeated sprints on the kinematics of 3-point shooting in basketball. *Journal of Human Kinetics*, 62, 5-14, doi:10.1515/hukin-2017-0156.
23. OKOROHA, K.R., LIZZIO, V.A., META, F., AHMAD, C.S., MOUTZOUROS, V., MAKHNI, E.C. 2018. Predictors of elbow torque among youth and adolescent baseball pitchers. *American Journal of Sports Medicine*, 46, 2148-2153, doi:10.1177/0363546518770619.
24. MARKOVIC G, DIZDAR D, JARIC S. 2006. Evaluation of tests of maximum kicking performance. *Journal of sports medicine and physical fitness*, 46(2), 215-20.
25. CALLISTER, R., MILLER, A., AGUIAR, E., DASCOMBE, B., SMITH, C., CLARK, L., ROGERS, T. 2010. Blood lactate levels support classification of the 300 m shuttle run as an anaerobic capacity field test. *Journal of Science Medicine in Sport*, 13, e30-e31.
26. SPORIŠ, G., VUČETIĆ, V., MILANOVIĆ, L., MILANOVIĆ, Z., KRESPI, M., KRAKAN, I. 2014. Anaerobic endurance capacity in elite soccer, handball and basketball players. *Kinesiology*, 46, 52-59.
27. ZIV, G., LIDOR, R. 2009. Physical attributes, physiological characteristics, on-court performances and nutritional strategies of female and male basketball players. *Sports medicine (Auckland, N.Z.)*, 39, 547-568, doi:10.2165/00007256-200939070-00003.
28. NARAZAKI, K., BERG, K.; STERGIYOU, N., CHEN, B. 2009. Physiological demands of competitive basketball. *Scandinavian journal of medicine & science in sports*, 19, 425-432, doi:10.1111/j.1600-0838.2008.00789. x.
29. SUPEJ, M. 2009. Impact of fatigue on the position of the release arm and shoulder girdle over a longer shooting distance for an elite basketball player. *Journal of Strength Conditioning Research*, 23, 1029-1036.
30. MATTHEW, D., DELESTRAT, A. 2009. Heart rate, blood lactate concentration, and time-motion analysis of female basketball players during competition. *Journal of sports sciences*, 27, 813-821.
31. BRINI, S., ABDERRAHMAN, A.B., BOULLOSA, D., HACKNEY, A.C., ZAGATTO, A.M., CASTAGNA, C., BOUASSIDA, A., GRANACHER, U., ZOUHAL, H. 2020. Effects of a 12-week change-of-direction sprints training program on selected physical and physiological parameters in professional basketball male players. *International Journal of Environmental Research and Public Health*, 17, 8214.
32. LESSI, G.C., DOS SANTOS, A.F., BATISTA, L.F., DE OLIVEIRA, G.C., SERRÃO, F.V. 2017. Effects of fatigue on lower limb, pelvis and trunk kinematics and muscle activation: gender differences. *Journal of Electromyography Kinesiology*, 32, 9-14.

33. LESSI, G.C., SERRÃO, F.V. 2017. Effects of fatigue on lower limb, pelvis and trunk kinematics and lower limb muscle activity during single-leg landing after anterior cruciate ligament reconstruction. *Knee Surgery, Sports Traumatology, Arthroscopy*, 25, 2550-2558.
34. LAFOND, D., DUARTE, M., PRINCE, F. 2004. Comparison of three methods to estimate the center of mass during balance assessment. *Journal of biomechanics*, 37, 1421-1426, doi:10.1016/s0021-9290(03)00251-3.
35. BOCCOLINI, G., BRAZZIT, A., BONFANTI, L., ALBERTI, G. 2013. Using balance training to improve the performance of youth basketball players. *Sport sciences for health* 9(2), 37–42.
36. SHERWOOD, D.E., SCHMIDT, R.A., WALTER, C.B. 1988. The force/force-variability relationship under controlled temporal conditions. *Journal of motor behavior*, 20, 106-116, doi:10.1080/00222895.1988.10735436.
37. JARIĆ, S., RADOVANOVIĆ, S., MILANOVIĆ, S., LJUBISAVLJEVIĆ, M., ANASTASIJEVIĆ, R. 1997. A comparison of the effects of agonist and antagonist muscle fatigue on performance of rapid movements. *European journal of applied physiology and occupational physiology*, 76, 41-47, doi:10.1007/s004210050210.
38. KAURANEN, K.J., SIIRA, P.T., VANHARANTA, H.V. 1998. A 10-week strength training program: effect on the motor performance of an unimpaired upper extremity. *Archives of physical medicine and rehabilitation*, 79, 925-930, doi:10.1016/s0003-9993(98)90089-2.
39. HUDSON, J.L. 1986. Coordination of segments in the vertical jump. *Medicine & Science in Sports & Exercise*.
40. UEBERSCHÄR, O., FLECKENSTEIN, D., WARSCHUN, F., KRÄNZLER, S., WALTER, N., HOPPE, M.W. 2019. Measuring biomechanical loads and asymmetries in junior elite long-distance runners through triaxial inertial sensors. *Sports Orthopedics Traumatology*, 35, 296-308.
41. OKUBO, H., HUBBARD, M. 2015. Kinematics of arm joint motions in basketball shooting. *Procedia Engineering*, 112, 443-448, doi: 10.1016/j.proeng.2015.07.222.
42. ELLIOTT, B. 1992. A kinematic comparison of the male and female two-point and three-point jump shots in basketball. *The Australian Journal of Science Medicine in Sport*, 24, 111-118.
43. KNUDSON, D. 1993. Biomechanics of the basketball jump shot—Six key teaching points. *Journal of Physical Education, Recreation, and Dance*, 64, 67-73.
44. OKAZAKI, V.H.A., RODACKI, A.L.F. 2018. Basketball jump shot performed by adults and children. *Human movement*, 19, 71-79.

45. WISSEL, H. Basketball: Steps to success; Human Kinetics: 2011.

Study 2: Does fatigue affect the kinematics of shooting in female basketball?

Li, F., Li, Z., Borović I., Rupčić, T., & Knjaz, D. (2021). Does Fatigue Affect the Kinematics of Shooting in Female Basketball? *International Journal of Performance Analysis in Sport*, 21(5), 754-766. DOI: 10.1080/24748668.2021.1945878



International Journal of Performance Analysis in Sport

doi: 10.1080/24748668.2021.1945878

Manuscript submitted for publication: 8 April 2021

Manuscript accepted for publication: 17 June 2021

Journal impact factor: 1.950

Indexed/Abstracted in: MEDLINE and Web of Science (WoS).

ISSN: 2474-8668 (Print); ISSN: 1474-8185 (Online)

Does fatigue affect the kinematics of shooting in female basketball?

Feng Li^a, Zheng Li^b, Iva Borović^c, Tomislav Rupčić^a and Damir Knjaz^a

^aLaboratory for Sports Games, Faculty of Kinesiology, University of Zagreb, Zagreb, Croatia; ^bChina Basketball College, Beijing Sport University, Beijing, China; ^cWomen's Basketball Club Medveščak, Croatian National Basketball Federation, Zagreb, Croatia

ABSTRACT

Few studies investigated the influence of fatigue on the change of kinematic parameters in basketball shooting regarding female players. This study aimed to determine the difference of kinematics in basketball jump shot between non-fatigue and fatigue conditions. Thirty-two professional female basketball players volunteered to take part in the study (age: 22.11 ± 4.92 years; height: 173.99 ± 7.06 cm; weight: 67.89 ± 5.65 kg). 3D motion analysis using an inertial suit and a smart ball were performed for measuring the kinematic parameters. The results demonstrated that there were no significant differences in angular velocity of ankle, knee and hip joints. Conversely, differences in angular velocity of elbow ($p = 0.036$) and wrist ($p = 0.002$) were detected. In addition, the results showed that the release height and entry angle of the ball significantly decreased in fatigue condition, suggesting that coaches need to include in the training process exercise that is similar in terms of fatigue and performance to the situational condition during the game as these two variables play an important role in the determination of shooting efficiency.

ARTICLE HISTORY

Received 8 April 2021
Accepted 17 June 2021

KEYWORDS

Female basketball; angular velocity; kinematic analysis; Xsens; accuracy

1. Introduction

Basketball shooting has been previously recognized as the most frequently used and the most important technique in the game. Likewise, it has been stated by many researchers that shooting accuracy strongly determines the outcome of a basketball game (Erčulj and Supej, 2006, Boddington *et al.*, 2019, Angel Gómez *et al.*, 2008).

There are different types of scoring in a basketball game. However, the jump shot has been reported to be the most common and efficient shooting technique (Knudson, 1993, Zwierko *et al.*, 2018), accounting for more than 60% of a field goal attempts in the Women's National Basketball Association (WNBA) in the 2010 season (Oudejans *et al.*, 2012) and 67% of a field goal attempts in the National Basketball Association (NBA) in the 2014 season (Boddington *et al.*, 2019). Consequently, many basketball coaches and scientists are focusing on how to diagnose players techniques during the jump shot and help them optimize their technique.

Traditionally, the players' techniques were subjectively evaluated by coaches' experience. However, it is possible that coaches even with rich knowledge in practice can occasionally ignore some details in the players' techniques. With the rapid development of technology, there have been some studies observing players' jump shot by using kinematic analysis (Struzik *et al.*, 2014, Rojas *et al.*, 2000, Nakano *et al.*, 2020), which may help the one in teaching, learning to have a better understanding in the movement pattern of basketball techniques and to further perfect players' techniques. Similarly, some studies have concluded that basketball coaches and teachers should integrated ideas from practical experience and scientific research in order to elicit the best training system for producing top basketball players (Knudson, 1993, Trninić *et al.*, 2002).

Basketball is an intermittent, high-intensity sport with the movements such as sprinting, shuffling and jumping (Ben Abdelkrim *et al.*, 2007, Stojanovic *et al.*, 2012). There were a number of studies investigating the influence of fatigue in basketball jump shot (Erčulj and Supej, 2009, Uygur *et al.*, 2010, Pojskic *et al.*, 2018). Erčulj & Supej observed the influence of fatigue on kinematics in shooting, and their findings revealed that the position of the release arm and shoulder statistically significant changed when players were under the moderate-and high-intensity fatigue level (Erčulj and Supej, 2009). Another study by Uygur *et al.* found that fatigue did not affect selected kinematic variables in free throw shooting (Uygur *et al.*, 2010). In terms of the influence of fatigue on accuracy of jump shot, Marcolin *et al.* investigated the change of jump shot accuracy when players were under progressive physiological load condition, reporting that the jump shot accuracy was significantly decreased with increasing intensity drills (Marcolin *et al.*, 2018). Thereby, it can be concluded that the ability to maintain

the required high intensity during a game is critical for winning a game (Erculj and Supej, 2009).

As explained earlier, numerous studies have examined the kinematic analysis related to jump shot in basketball. However, little is known about the influence of fatigue on the kinematics of jump shot regarding female basketball players. It is therefore essential to add some new knowledge to this area. In addition, another novelty of this study was that the shooting machine was used to standardize each pass, which ultimately allowed for the exclusion of negative external factors (inaccurate passes) on the performance of the jump shot technique. Therefore, the present study aimed to observe the change of kinematic parameters, as well as the jump shot efficiency between fatigue and non-fatigue condition regarding female basketball players.

2. Materials and methods

2.1. Participants

Thirty-two professional female basketball players (point and shooting guards) were volunteered to take part in the study (age: 22.11 ± 4.92 years; height: 173.99 ± 7.06 cm; weight: 67.89 ± 5.65 ; body fat: 25.20 ± 4.34 %). Players who had injury or health issues were excluded. In order to avoid the interference of fatigue on testing, players were asked to restrain from training sessions at least one day before testing. Prior to testing, all players were fully informed about all procedures and provided written informed consent.

2.2. Experimental Procedures

The study was conducted in a repeated measures study design: non-fatigue and fatigue groups. Each player was tested in one day, and they underwent the same protocol: before testing, they had at least one day of rest, while the testing consisted of warm-up, non-fatigue jump shots testing, fatigue protocol, and fatigue jump shots testing. The warm-up consisted of 5 minutes jogging, 5 minutes dynamic stretching and 5 minutes ball handling. In order to observe the players' fatigue level, the blood lactate (BL) was measured after warm-up and after fatigue protocol immediately by a portable lactate analyzer (Lactate Scout 3, manufacturer: SensLab GmbH, Leipzig, Germany). In addition, the rating of perceive exertion (RPE) using the CR-10 sliding scale was examined after the testing. Players were allowed to take 5 trial jump shots before the testing, following the start of jump shot testing.

The testing protocol was presented in figure 1, each player stood at the distance of 5-meter from basket. When the testing started, they received the ball from shooting machine, performing four jump shots from aforementioned spot. In order to standardize each pass that directly connect shooting efficiency, a shooting machine (Dr. Dish, Airborne Athletics, Inc. Minneapolis, MN,

USA) was placed under the basket and programmed to pass the ball towards the players. The ball speed was set to 8 m/s and the interval time was 5 seconds between each pass. The net for gathering balls was not placed on the shooting machine in order to avoid the interference on kinematic parameters of shooting. After the first testing, players were asked to perform fatigue protocol: 300-meter shuttle run (15×20 m with the change of direction of 180°). The mentioned fatigue protocol was used due to similarities with game situations in which a player runs forward and backwards consecutively, and its reliability has been previously verified by previous studies (Sporiš *et al.*, 2014, Callister *et al.*, 2010). During the 300-meter shuttle run, players were instructed to sprint as fast as possible and the sprint time was recorded by photocells (WittyGate, Microgate, Bolzano, Italy). Afterwards, players performed four jump shots once more for observing the difference between non-fatigue and fatigue group.

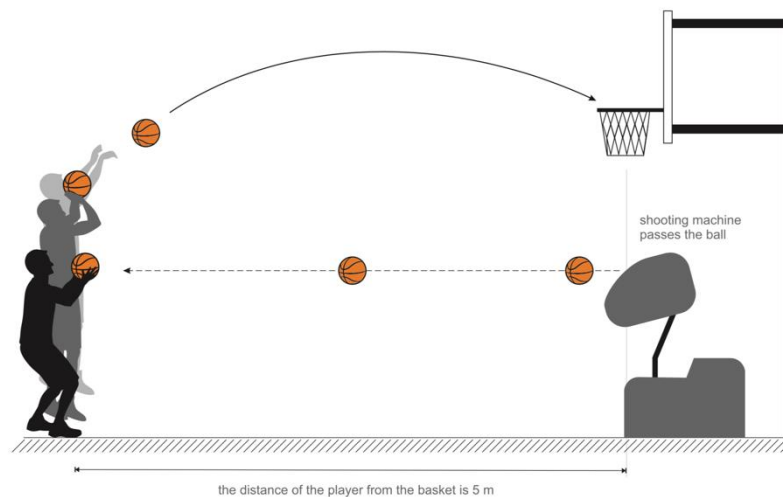

Figure 1. The illustration of jump shot testing

2.3. Variables

During the testing, the following variables were observed: horizontal displacement from the moment players jumps to the landing (HD) (cm); release height when the ball left from players dominant hand (RH) (cm); shooting speed from the moment players touched the ball from pass until release (SS) (s); entry angle of the ball formed by the downward line of the ball in relation to the basket (EA) ($^\circ$); maximum angular velocity of ankle joint during jump shot (ANKLE_AVmax) ($^\circ$ /s); maximum angular velocity of knee joint during jump shot (KNEE_AVmax) ($^\circ$ /s); maximum angular velocity of hip joint during jump shot (HIP_AVmax) ($^\circ$ /s); maximum angular velocity of shoulder joint during jump shot (SHOULDER_AVmax) ($^\circ$ /s); maximum angular velocity of elbow joint during jump shot (ELBOW_AVmax) ($^\circ$ /s);

maximum angular velocity of wrist joint during jump shot (WRIST_AVmax) ($^{\circ}/s$); efficiency of shooting (%).

The kinematic variables were measured by Xsens MVN inertial suit system (Xsens technologies B.V., Netherlands). The player wore a full-body suit equipped with 17 three dimensional accelerometers/gyroscopes/magnetometers (sampling frequency 60 Hz) to ensure full 3D motion capture analysis. The movement pattern of jump shots during testing was presented in figure 2. Prior to the start of testing, basic anthropometric characteristics were measured for system calibration performed according to the instruction of the manufacturer. The calibration of sensors was set in N-pose and the kinematic parameters were derived from the corresponding MVN BIOMECH software (MVN Studio 4.4, firmware version 4.3.1). Previous study has verified the reliability and validity of Xsens kinematic suit for kinematic analysis of basketball techniques (Robert-Lachaine *et al.*, 2017). In addition, it was used in previous studies for measuring similar data in the basketball field (Slawinski *et al.*, 2018, Li *et al.*, 2021). To measure other kinematic variables (i.e., shooting speed, entry angle of the ball), a Smart Ball (94fifty ball, InfoMotion Sports Technologies Inc., Dublin, Ohio, USA) was used. The Smart Ball contains nine accelerometers inside which can measure three variables—shot speed, ball rotation and ball arc. The mentioned ball is of the normal size and weight corresponding to the official proposals proscribed by FIBA and its reliability and validity have been previously proved (Abdelrasoul *et al.*, 2015, Rupčić *et al.*, 2016).

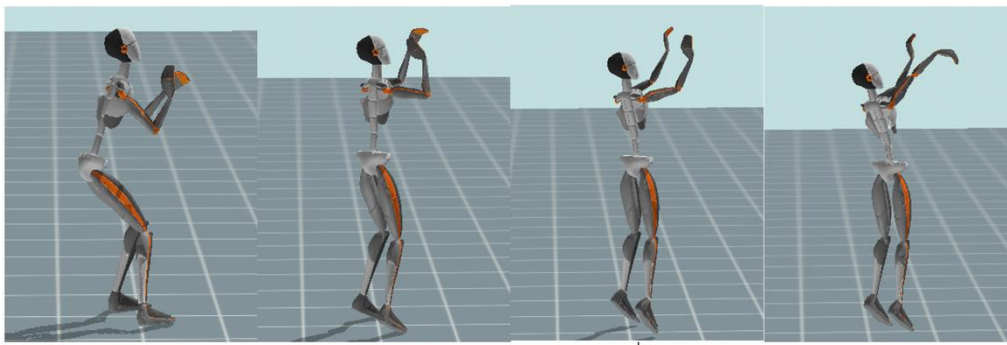

Figure 2. Layout from the ready position until releasing the ball

2.4. Statistical Analysis

With the use of the G*power program, the sample size (number of shots) was recommended (n=98) that was needed for measurement procedure with statistical significance $p < 0.05$; statistical power 0.8; effect size 0.25 and groups. Eight jump shots were excluded from the final analysis due to some technical issues with equipment and motor movement. Overall, 120 jump shots were analyzed in this study.

“Statistica” version 13.5.0.17 (TIBCO Software Inc, Palo Alto, CA) was used for the statistical analysis. Basic descriptive parameters were calculated for all measured variables. The normality of the data distribution was evaluated by using Kolmogorov–Smirnov test. To verify the differences of the kinematic variables between fatigue and non-fatigue group, analysis of variance (ANOVA) for repeated measures was applied.

3. Results

Table 1 presents the results of ANOVA for repeated measures. The statistical analysis demonstrated significant difference between non-fatigue and fatigue group in selected kinematic parameters ($p=0.002$).

Table 1. The results of ANOVA for repeated measures (for groups).

Test	Value	F	<i>p</i>
Wilks	0.89	2.92	0.002*

*Marked values were significant when $p < 0.05$.

Table 2 provides the descriptive parameters and ANOVA for variables between non-fatigue and fatigue group. The mean value of horizontal displacement (HD) during jump shots were relatively similar (non-fatigue=13.30; fatigue=13.31) and there was no significant difference between non-fatigue and fatigue group ($p=0.992$). The mean value of release height (RH) during jump shots were higher in non-fatigue compared to fatigue group (non-fatigue=201.54; fatigue=198.48) and there was significant difference ($p=0.048$). Likewise, the mean value of shot speed (SS) was similar (non-fatigue=0.86; fatigue=0.85) and there was insignificant difference between two groups ($p=0.657$). The mean value of entry angle (EA) of the ball in non-fatigue was higher than fatigue group and there was statistically difference between two groups ($p=0.037$). In terms of the angular velocity of players’ lower extremity during jump shots, the mean value of maximum angular velocity of ankle joint (ANKLE_AVmax) was lower in non-fatigue compared to fatigue group (non-fatigue=636.22; fatigue=649.96), but there was no statistically significant difference between two groups ($p=0.372$). Similarly, the mean value of maximum angular velocity of knee joint (KNEE_AVmax) was lower in non-fatigue compared to fatigue group (non-fatigue=362.42; fatigue=366.63), but there was no significant difference between two groups ($p=0.688$). Moreover, the mean value of maximum angular velocity of hip joint (HIP_AVmax) was lower in non-fatigue compared to fatigue group (non-fatigue=239.72; fatigue=245.68), but there was no significant difference between two groups ($p=0.346$). Conversely, in terms of the angular velocity of players’ upper extremity during jump shots, the mean value of maximum angular velocity of wrist joint (WRIST_AVmax) was higher

in non-fatigue compared to fatigue group (non-fatigue=1134.44; fatigue=989.49) and there was significant difference between two groups ($p=0.002$). Equally, the mean value of maximum angular velocity of elbow joint (ELBOW_AVmax) was higher in non-fatigue compared to fatigue group (non-fatigue=1128.28; fatigue=1090.83) and there was significant difference between two groups ($p=0.036$). Last, the mean value of maximum angular velocity of shoulder joint (SHOULDER_AVmax) was higher in non-fatigue compared to fatigue group (non-fatigue=560.88; fatigue=512.71), but there was no significant difference between two groups ($p=0.082$).

Table 2 Descriptive parameters and result of ANOVA for repeated measures of the fatigue and non-fatigue conditions.

Variable	Group	N	Mean	Min	Max	Std. dev.	F	p
HD (cm)	Non-fatigue	120	13.30	0.00	36.00	7.29	0.00	0.992
	Fatigue	120	13.31	1.00	27.00	5.94		
RH (cm)	Non-fatigue	120	201.54	181.70	232.30	11.96	3.96	0.048*
	Fatigue	120	198.48	178.30	228.70	11.83		
SS (s)	Non-fatigue	120	0.86	0.50	1.10	0.11	0.20	0.657
	Fatigue	120	0.85	0.48	1.13	0.11		
EA (°)	Non-fatigue	120	33.41	24.00	44.00	4.08	4.42	0.037*
	Fatigue	120	32.27	23.00	41.00	4.32		
ANKLE_AV _{max} (°/s)	Non-fatigue	120	636.22	321.26	968.86	121.61	0.80	0.372
	Fatigue	120	649.96	436.89	960.16	116.22		
KNEE_AV _{max} (°/s)	Non-fatigue	120	362.42	192.08	609.77	77.56	0.16	0.688
	Fatigue	120	366.63	36.96	565.82	84.45		
HIP_AV _{max} (°/s)	Non-fatigue	120	239.72	104.36	373.16	45.61	0.89	0.346
	Fatigue	120	245.68	116.23	391.94	51.99		
WRIST_AV _{max} (°/s)	Non-fatigue	120	1134.44	312.76	1763.93	363.50	9.46	0.002*
	Fatigue	120	989.49	118.92	1724.10	366.66		
ELBOW_AV _{max} (°/s)	Non-fatigue	120	1128.28	790.74	1518.07	144.99	4.46	0.036*
	Fatigue	120	1090.83	790.53	1366.41	129.41		
SHOULDER_AV _{max} (°/s)	Non-fatigue	120	560.88	154.76	1430.17	220.69	3.05	0.082
	Fatigue	120	512.71	184.04	1109.02	206.75		

* Marked values were significant when $p < 0.05$.

Figure 3 illustrates the angular velocity of lower and upper extremities between non-fatigue and fatigue group. It reveals that the mean value of maximum angular velocity of lower extremity was lower in non-fatigue compared to fatigue group. Conversely, the mean value of maximum angular velocity of upper extremity was higher in non-fatigue compared to fatigue group.

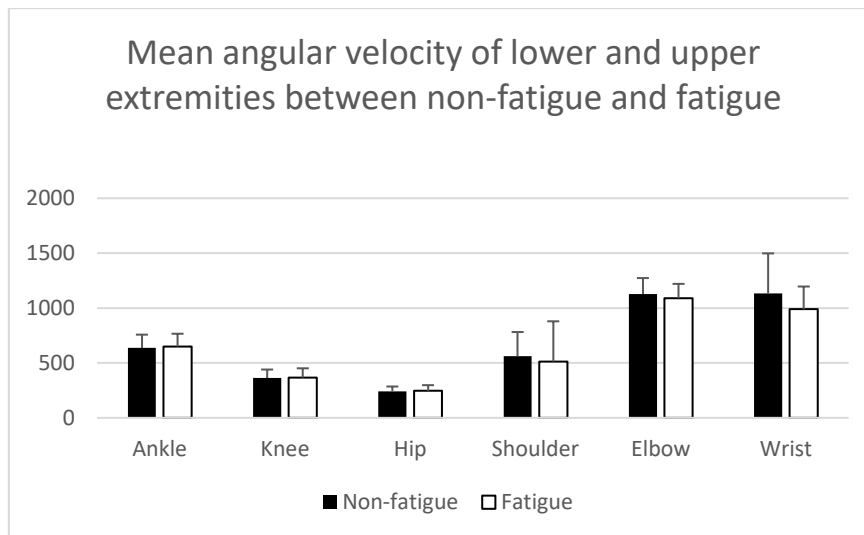

Figure 3 Comparison of angular velocity in different joints between non-fatigue and fatigue. The table 3 below presents that the efficiency of jump shots was almost identical between non-fatigue and fatigue group (non-fatigue=54.167%; fatigue=53.333%).

Table 3 The results of jump shots efficiency

Group	Variable	N	Efficiency (%)
Non-fatigue	Successful	65	54.167
	Unsuccessful	55	
Fatigue	Successful	64	53.333
	Unsuccessful	56	

As shown in table 4, the mean value of BL was obviously higher in fatigue than non-fatigue group. Additionally, the mean value of RPE scale was 8.59.

Table 4 Descriptive statistics of Blood Lactate (BL) and Rating of Perceive Exertion (RPE) between non-fatigue and fatigue group

Variable	N	Mean	Minimum	Maximum	Std. dev.
BL_non_F (mmol/l)	32	1.77	0.50	4.20	1.05
BL_F (mmol/l)	32	10.02	5.00	16.70	3.03
RPE scale	32	8.59	7.00	10.00	0.95
300- m shuttle run (s)	32	74.87	68.36	84.27	5.13

Note: BL_non_F: The players' blood lactate after warm-up (non-fatigue group); BL_F: The players' blood lactate after the fatigue protocol (fatigue group); RPE Scale: the players' rating of perceive exertion after the testing of fatigue group.

4. Discussion

The present study was conducted to investigate the influence of fatigue on some kinematic parameters and efficiency of jump shot in professional female basketball players. In reviewing

the literature, little is known about the association between fatigue and kinematic parameters in terms of professional female basketball players. The main findings of this study showed that there was significant difference in some kinematic parameters of jump shot between non-fatigue and fatigue condition.

The BL and RPE have been widely used to assess the athletes' physiological load during training (Brini *et al.*, 2020, Manzi *et al.*, 2010) and game (Narazaki *et al.*, 2009, Moreira *et al.*, 2012). In this study, the mean value of BL was 10.02 mmol/l when players completed the fatigue protocol. McInnes *et al.* investigated the physiological response to the real basketball games (McInnes *et al.*, 1995). As a result, they reported that the mean maximum BL for all subjects was 8.5 ± 3.1 mmol/l, with the highest individual 13.2 mmol/l. In addition, research by Erculj and Supej assessed the effect of progressive fatigue on basketball shooting (Erculj and Supej, 2009). A similar result (BL=9.7 mmol/l) to current study was observed when players completed the last series of the fatigue protocol. On the other hand, the current study demonstrated that the mean RPE score was 8.59, which is similar to a previous study showing that the RPE was 8.0 ± 0.9 in regular games and 8.3 ± 0.8 in overtime periods of the official games (Scanlan *et al.*, 2019). Thereby, it can be concluded in this study that conditions were similar to a real basketball game for players after the fatigue protocol, and that the difference in jump shot between non-fatigue and fatigue condition could be investigated.

The results of this study showed that some kinematic parameters changed when players were under the influence of fatigue, which is in agreement with previous studies showing that the movement pattern of shooting was changed under the influence of fatigue (Erčulj and Supej, 2006, Erculj and Supej, 2009, Rupčić *et al.*, 2020). The results of the present study demonstrated that the mean angular velocity of lower extremity was higher in fatigue condition than non-fatigue condition, while, at the same time, the angular velocity of upper extremity was lower in fatigue than non-fatigue condition. This finding is in line with a previous study reporting that the maximum of lower extremity increased in jump shots when players were under highly intensive fatigue, whereas the upper extremity continuously decreased (Rupčić *et al.*, 2020). The body segments move in a certain sequence for multiple joint movements—the force is transmitted from the proximal to the distal body parts (Hudson, 1986, Ueberschär *et al.*, 2019) and greater velocities during shooting were connected with the strategies of the reuse of the energy transferred from the lower extremity to upper extremity (Knudson, 1993, Okubo and Hubbard, 2015, Elliott, 1992, Okazaki and Rodacki, 2018). Furthermore, a study stated that the coordination is a skill required more than strength in jump shots for high-level basketball players (Uygur *et al.*, 2010). This study found that the efficiency did not differ between non-

fatigue and fatigue group. A very possible explanation for this might be that fatigue affected the reduction of muscle strength, which ultimately reduced angular velocities in upper extremity when players were under the influence of fatigue, but this can be compensated by the lower extremity so that players can ultimately perform a successful shot. This evidence is consistent with a previous study showing that high intensity repeated sprints impair postural control, but there was no influence on shooting efficiency through the readjustment of neuromuscular system in body segments (Barbieri *et al.*, 2017).

On the other hand, some previous studies have found that the efficiency of jump shot decreased when players were under the influence of fatigue (Marcolin *et al.*, 2018, Mulazimoglu *et al.*, 2017). In terms of the shooting protocol of the current study, players stood at a stable spot, received the ball from the shooting machine and took a shot. However, the aforementioned studies used the dynamic jump shot protocol (i.e., keep running to catch the ball and perform a shot), which was more complex compared to the present study and it increased the accumulation of fatigue during testing. Moreover, previous studies reported that fatigue has negative effect on the capacity of the muscle to generate force, which results in a player who is unable to keep moving at the same level of performance (Erculj and Supej, 2009, Sherwood *et al.*, 1988, Jarić *et al.*, 1997). With respect of this study, the distance of jump shot was relatively short, and it is possible that professional players still had sufficient force by readjusting its flow in body segments to make a successful shot.

The results of this study indicated that the mean values of HD (non-fatigue=13.30; fatigue=13.31) and SS (non-fatigue=0.86; fatigue=0.85) were almost identical. Likewise, this result may also be explained by the fact that elite basketball players can readjust their neuromuscular system in a way that lower extremity could compensate the lack of the force of upper extremity when they were under the influence of fatigue. In addition, the reason why the HD variable did not differ between two groups is likely that the players performed jump shots from a stable spot in this study, without previous movement. The HD variable may change significantly in the situation when players perform change of direction to catch the ball (dynamic jump shot). Consequently, fatigue is likely to affect players' balance (Wilkins *et al.*, 2004), causing the significant changes of HD between non-fatigue and fatigue group.

In terms of SS variable, the mentioned results may have been obtained due to the fact that the players took shots from a closer position to the basket. The assumption is that the shot speed will be extended when shooting from greater distances because players need more muscular strength and coordination to perform shots, but, considering the influence of fatigue, both parameters will be disturbed (Jarić *et al.*, 1997, Enoka and Duchateau, 2008). This explanation

is corresponding to previous studies reporting that the shot speed was decreased when the distance increased (Vencúrik *et al.*, 2021, Rupčić *et al.*, 2015).

The results of this study indicated that the RH was significantly higher in non-fatigue group compared to fatigue group (non-fatigue=201.54; fatigue=198.48). Elliott reported that releasing the ball before the highest point during a jump shot may allow players to transfer part of the vertical velocity resulting from the vertical displacement of their body to the ball in order to generate a greater impulse at ball release (Elliott, 1992). Thereby, a possible explanation for this result is that fatigue induced the players' force reduction, but they attempted to decrease the release height for obtaining a greater impulse. On the other hand, the EA was significantly higher before the fatigue protocol (non-fatigue=33.41; fatigue=32.27). This finding is contrary to previous studies which have suggested that higher EA has positive influence on the shooting efficiency (Okazaki and Rodacki, 2012, Miller and Bartlett, 1993). This result may be explained by the fact that the significant differences regarding EA were borderline ($p=0.04$) between two groups and some shots with slightly lower EA after the fatigue protocol were successfully made, but with touching the basket or backboard several times, which result in the efficiency of jump shots was almost identical in current study between non-fatigue and fatigue group. The evidence was supported by other studies that analyzed the efficiency with different standards, according to the fluency of the scoring (e.g., only shots without touching the rim or backboard were considered successful; higher points were awarded for successful shots without touching the rim or backboard, while lower points were awarded for successful shots touching the rim several times) (Miller and Bartlett, 1996, Uygur *et al.*, 2010, Lyons *et al.*, 2006, Delextrat *et al.*, 2018) so as to clearly assess the influence of fatigue on basketball techniques. Despite the fact that fatigue did not affect the efficiency of jump shot in this study, it should be noticed that the RH and EA significantly decreased, as previous studies have stated that these two variables play an important role in determination of shooting efficiency (Tran and Silverberg, 2008, Okazaki and Rodacki, 2012, Miller and Bartlett, 1993). Moreover, the lower RH is easy to be blocked by a defender when competing against teams which play good defense. Thereby, it is recommended that coaches include drills similar to the situational condition during a game in terms of fatigue and performance in the training process.

4.1 Limitations

In this study, players took jump shots from the stable spot with the interval of 5 seconds in current study. To some extent, thereby, they were in recovery state from testing itself between each shot. A further study with more focus on dynamic jump shot (i.e., keep moving to catch the ball and take a shot) will need to be undertaken.

Furthermore, the distance of jump shot in present study was relatively short, and it is possible that players still had sufficient force through readjusting the flow of force in body segments to make a successful shot. Therefore, it is worthwhile devoting effort to longer distance and complexity jump shot such as three-points and jump shot with defender in terms of female basketball players.

5. Conclusions

The main findings of this investigation showed that the angular velocity of lower extremity was higher in fatigue compared to non-fatigue group. Conversely, the angular velocity of upper extremity was lower in fatigue compared to non-fatigue group. In addition, the efficiency of jump shot did not decrease significantly in fatigue group. The results of this study indicated that elite female basketball players are able to maintain the efficiency through readjusting the neuromuscular system to make a successful jump shot when they were under fatigue condition. However, the results of current study showed that the release height and entry angle of the ball significantly decreased in fatigue group, suggesting that coaches need to include in the training process exercise that is similar in terms of fatigue and performance to the situational condition during the game as these two variables play an important role in determination of the shooting efficiency.

Disclosure statement

No potential conflict of interest was reported by the authors.

Ethical Approval Information

The study was conducted according to the guidelines of the Declaration of Helsinki and approved by the Ethics Committee of Faculty of Kinesiology of University of Zagreb (ethical code 108/2020, 27 November 2020)

Funding

The first author was supported by the China Scholarship Council (CSC) from the Ministry of Education of P.R. China under Grant [(2019) 110].

Data availability statement

The data that support the findings of this study are available on request from the corresponding author. The data are not publicly available due to its huge size and participants' privacy protection.

ORCID

Feng Li <https://orcid.org/0000-0003-4806-1374>

Tomislav Rupčić <https://orcid.org/0000-0002-5919-7069>

References

- ABDELRASOUL, E., MAHMOUD, I., STERGIOU, P. & KATZ, L. 2015. The accuracy of a real time sensor in an instrumented basketball. *Procedia Engineering*, 112, 202-206.
- ANGEL GÓMEZ, M., LORENZO, A., SAMPAIO, J., IBÁÑEZ, S. J. & ORTEGA, E. 2008. Game-related statistics that discriminated winning and losing teams from the Spanish men's professional basketball teams. *Coll Antropol*, 32, 451-6.
- BARBIERI, F. A., RODRIGUES, S. T., POLASTRI, P. F., BARBIERI, R. A., DE PAULA, P. H. A., MILIONI, F., REDKVA, P. E. & ZAGATTO, A. M. 2017. High intensity repeated sprints impair postural control, but with no effects on free throwing accuracy, in under-19 basketball players. *Hum Mov Sci*, 54, 191-196.
- BEN ABDELKRIM, N., EL FAZAA, S. & EL ATI, J. 2007. Time-motion analysis and physiological data of elite under-19-year-old basketball players during competition. *Br J Sports Med*, 41, 69-75; discussion 75.
- BODDINGTON, B. J., CRIPPS, A. J., SCANLAN, A. T. & SPITERI, T. 2019. The validity and reliability of the Basketball Jump Shooting Accuracy Test. *J Sports Sci*, 37, 1648-1654.
- BRINI, S., BEN ABDERRAHMAN, A., BOULLOSA, D., HACKNEY, A. C., ZAGATTO, A. M., CASTAGNA, C., BOUASSIDA, A., GRANACHER, U. & ZOUHAL, H. 2020. Effects of a 12-week change-of-direction sprints training program on selected physical and physiological parameters in professional basketball male players. *Int J Environ Res Public Health*, 17.
- CALLISTER, R., MILLER, A., AGUIAR, E., DASCOSBE, B., SMITH, C., CLARK, L. & ROGERS, T. 2010. Blood lactate levels support classification of the 300 m shuttle run as an anaerobic capacity field test. *Journal of Science Medicine in Sport*, 13, e30-e31.
- DELEXTRAT, A., GRUET, M. & BIEUZEN, F. 2018. Effects of small-sided games and high-intensity interval training on aerobic and repeated sprint performance and peripheral

- muscle oxygenation changes in elite junior basketball players. *J Strength Cond Res*, 32, 1882-1891.
- ELLIOTT, B. 1992. A kinematic comparison of the male and female two-point and three-point jump shots in basketball. *The Australian Journal of Science Medicine in Sport*, 24, 111-118.
- ENOKA, R. M. & DUCHATEAU, J. 2008. Muscle fatigue: what, why and how it influences muscle function. *J Physiol*, 586, 11-23.
- ERCULJ, F. & SUPEJ, M. 2009. Impact of fatigue on the position of the release arm and shoulder girdle over a longer shooting distance for an elite basketball player. *J Strength Cond Res*, 23, 1029-36.
- ERČULJ, F. & SUPEJ, M. 2006. The impact of fatigue on jump shot height and accuracy over a longer shooting distance in basketball. *UGDYMAS • KŪNO KULTŪRA • SPORTAS*, 4, 35-41.
- HUDSON, J. L. 1986. Coordination of segments in the vertical jump. *Medicine & Science in Sports & Exercise*.
- JARIĆ, S., RADOVANOVIĆ, S., MILANOVIĆ, S., LJUBISAVLJEVIĆ, M. & ANASTASIJEVIĆ, R. 1997. A comparison of the effects of agonist and antagonist muscle fatigue on performance of rapid movements. *Eur J Appl Physiol Occup Physiol*, 76, 41-7.
- KNUDSON, D. 1993. Biomechanics of the basketball jump shot—Six key teaching points. *Journal of Physical Education, Recreation Dance*, 64, 67-73.
- LI, F., KNJAZ, D. & RUPČIĆ, T. 2021. Influence of fatigue on some kinematic parameters of basketball passing. *Int J Environ Res Public Health*, 18.
- LYONS, M., AL-NAKEEB, Y. & NEVILL, A. 2006. The impact of moderate and high intensity total body fatigue on passing accuracy in expert and novice basketball players. *Journal of Sports Science & Medicine*, 5, 215.
- MANZI, V., D'OTTAVIO, S., IMPELLIZZERI, F. M., CHAOUACHI, A., CHAMARI, K. & CASTAGNA, C. 2010. Profile of weekly training load in elite male professional basketball players. *J Strength Cond Res*, 24, 1399-406.
- MARCOLIN, G., CAMAZZOLA, N., PANIZZOLO, F. A., GRIGOLETTO, D. & PAOLI, A. 2018. Different intensities of basketball drills affect jump shot accuracy of expert and junior players. *PeerJ*, 6, e4250.

- MCINNES, S. E., CARLSON, J. S., JONES, C. J. & MCKENNA, M. J. 1995. The physiological load imposed on basketball players during competition. *J Sports Sci*, 13, 387-97.
- MILLER, S. & BARTLETT, R. 1996. The relationship between basketball shooting kinematics, distance and playing position. *J Sports Sci*, 14, 243-53.
- MILLER, S. & BARTLETT, R. M. 1993. The effects of increased shooting distance in the basketball jump shot. *Journal of Sports Sciences*, 11, 285-293.
- MOREIRA, A., MCGUIGAN, M. R., ARRUDA, A. F., FREITAS, C. G. & AOKI, M. S. 2012. Monitoring internal load parameters during simulated and official basketball matches. *J Strength Cond Res*, 26, 861-6.
- MULAZIMOGLU, O., YANAR, S., TUNCA EVCIL, A. & DUVAN, A. 2017. Examining the effect of fatigue on shooting accuracy in young basketball players. *The Anthropologist*, 27, 77-80.
- NAKANO, N., FUKASHIRO, S. & YOSHIOKA, S. 2020. The effect of increased shooting distance on energy flow in basketball jump shot. *Sports Biomechanics*, 19, 366-381.
- NARAZAKI, K., BERG, K., STERGIOU, N. & CHEN, B. 2009. Physiological demands of competitive basketball. *Scand J Med Sci Sports*, 19, 425-32.
- OKAZAKI, V. H. A. & RODACKI, A. L. F. 2012. Increased distance of shooting on basketball jump shot. *Journal of sports science medicine*, 11, 231.
- OKAZAKI, V. H. A. & RODACKI, A. L. F. 2018. Basketball jump shot performed by adults and children. *Human movement*, 19, 71-79.
- OKUBO, H. & HUBBARD, M. 2015. Kinematics of arm joint motions in basketball shooting. *Procedia Engineering*, 112, 443-448.
- OUDEJANS, R. R., KARAMAT, R. S. & STOLK, M. H. 2012. Effects of actions preceding the jump shot on gaze behavior and shooting performance in elite female basketball players. *International Journal of Sports Science Coaching*, 7, 255-267.
- POJSKIC, H., SISIC, N., SEPAROVIC, V. & SEKULIC, D. 2018. Association between conditioning capacities and shooting performance in professional basketball players: an analysis of stationary and dynamic shooting skills. *J Strength Cond Res*, 32, 1981-1992.
- ROBERT-LACHAINE, X., MECHELI, H., LARUE, C. & PLAMONDON, A. 2017. Validation of inertial measurement units with an optoelectronic system for whole-body motion analysis. *Med Biol Eng Comput*, 55, 609-619.
- ROJAS, F. J., CEPERO, M., OÑA, A. & GUTIERREZ, M. 2000. Kinematic adjustments in the basketball jump shot against an opponent. *Ergonomics*, 43, 1651-60.

- RUPČIĆ, T., ANTEKOLOVIĆ, L., KNJAZ, D., MATKOVIĆ, B. & CIGROVSKI, V. Reliability analysis of the 94 fifty smart sensor basketball. 10th International Conference On Kinanthropology, 2016. 432-438.
- RUPČIĆ, T., FENG, L., MATKOVIĆ, B. R., KNJAZ, D., DUKARIĆ, V., BAKOVIĆ, M., MATKOVIĆ, A., SVOBODA, I., VAVAČEK, M. & GARAFOLIĆ, H. 2020. The impact of progressive physiological loads on angular velocities during shooting in basketball-case study. *Acta Kinesiologica*, 14, 102-109.
- RUPČIĆ, T., KNJAZ, D., BAKOVIĆ, M., DEVRNJA, A. & MATKOVIĆ, B. J. H. Š. V. 2015. Impact of fatigue on accuracy and changes in certain kinematic parameters during shooting in basketball. 1, 15-20.
- SCANLAN, A. T., STANTON, R., SARGENT, C., O'GRADY, C., LASTELLA, M. & FOX, J. L. 2019. Working Overtime: The Effects of overtime periods on game demands in basketball players. *Int J Sports Physiol Perform*, 1-7.
- SHERWOOD, D. E., SCHMIDT, R. A. & WALTER, C. B. 1988. The force/force-variability relationship under controlled temporal conditions. *J Mot Behav*, 20, 106-16.
- SLAWINSKI, J. P., LOUIS, J., POLI, J., TIOLLIER, E., KHAZOOM, C. & DINU, D. 2018. The effects of repeated sprints on the kinematics of 3-point shooting in basketball. *J Hum Kinet*, 62, 5-14.
- SPORIŠ, G., VUČETIĆ, V., MILANOVIĆ, L., MILANOVIĆ, Z., KRESPI, M. & KRAKAN, I. 2014. A comparison anaerobic endurance capacity in elite soccer, handball and basketball players. *Kinesiology*, 46, 52-59.
- STOJANOVIC, M. D., OSTOJIC, S. M., CALLEJA-GONZÁLEZ, J., MILOSEVIC, Z. & MIKIC, M. 2012. Correlation between explosive strength, aerobic power and repeated sprint ability in elite basketball players. *J Sports Med Phys Fitness*, 52, 375-81.
- STRUZIK, A., PIETRASZEWSKI, B. & ZAWADZKI, J. 2014. Biomechanical analysis of the jump shot in basketball. *J Hum Kinet*, 42, 73-9.
- TRAN, C. M. & SILVERBERG, L. M. 2008. Optimal release conditions for the free throw in men's basketball. *J Sports Sci*, 26, 1147-55.
- TRNINIĆ, S., DIZDAR, D. & LUKSIĆ, E. 2002. Differences between winning and defeated top quality basketball teams in final tournaments of European club championship. *Coll Antropol*, 26, 521-31.
- UEBERSCHÄR, O., FLECKENSTEIN, D., WARSCHUN, F., KRÄNZLER, S., WALTER, N. & HOPPE, M. W. 2019. Measuring biomechanical loads and asymmetries in junior elite

- long-distance runners through triaxial inertial sensors. *Sports Orthopaedics Traumatology*, 35, 296-308.
- UYGUR, M., GOKTEPE, A., AK, E., KARABÖRK, H. & KORKUSUZ, F. 2010. The effect of fatigue on the kinematics of free throw shooting in basketball. *Journal of human kinetics*, 24, 51-56.
- VENCÚRIK, T., KNJAZ, D., RUPČIĆ, T., SPORIŠ, G. & LI, F. 2021. Kinematic analysis of 2-point and 3-point jump shot of elite young male and female basketball players. *Int J Environ Res Public Health*, 18.
- WILKINS, J. C., VALOVICH MCLEOD, T. C., PERRIN, D. H. & GANSNEDER, B. M. 2004. Performance on the balance error scoring system decreases after fatigue. *J Athl Train*, 39, 156-161.
- ZWIERKO, T., POPOWCZAK, M., WOŹNIAK, J. & ROKITA, A. 2018. Visual control in basketball shooting under exertion conditions. *J Sports Med Phys Fitness*, 58, 1544-1553.

Study 3: The Impact of Progressive Physiological Loads on Angular Velocities during Shooting in Basketball-Case Study

Rupčić, T., Li, F., Matković, B. R., Knjaz, D., Dukarić, V., Baković, M., Matković, A., Svoboda, I., Vavaček, M., & Garafolić, H. (2020). The impact of progressive physiological loads on angular velocities during shooting in basketball-case study. *Acta Kinesiologica*, 14(2), 102–109.



Acta Kinesiologica

Manuscript submitted for publication: 11 June 2020

Manuscript accepted for publication: 5 November 2020

Indexed/Abstracted in: Web of Science (WoS).

ISSN: 1840-2976 (Print); ISSN: 1840-3700 (Online)

THE IMPACT OF PROGRESSIVE PHYSIOLOGICAL LOADS ON ANGULAR VELOCITIES DURING SHOOTING IN BASKETBALL – CASE STUDY**Tomislav Rupčić¹, Li Feng¹, Branka R. Matković¹, Damir Knjaz¹, Vedran Dukarić¹, Marijo Baković¹, Andro Matković², Ivan Svoboda¹, Martin Vavaček³, Hrvoje Garafolić¹**¹University of Zagreb Faculty of Kinesiology, Croatia²Department of diagnostic and interventional radiology, Merkur University hospital, Zagreb, Croatia³Faculty of sports studies, Masaryk university, Brno, Czech Republic

Original scientific paper

Abstract

The main objective of this research was to determine whether progressive physiological load affects changes in certain kinematic parameters while performing jump shots in basketball. This study primarily examined the effect of fatigue on changes in angular velocities of joints of the lower and upper extremities, however, the relationship of the mentioned parameters in terms of the ultimate outcome, i.e. the duration of the shot, as well as the precision of the shot were likewise studied. The research included one examinee who is a member of the Croatian U18 Men's National Team. The study incorporated a precisely determined protocol according to which the following parameters were determined: angles of the knee and hip joint at the moment of receiving the ball, maximum and average angular velocity in the ankle, knee, hip, shoulder, elbow and wrist joint, height at the moment of releasing the ball, duration of the shot, angle at which the ball enters the basket and shooting percentage. The obtained results indicate certain differences in angular velocities of the upper and lower extremities, as well as in the height at the moment of releasing the ball under the influence of progressive fatigue. Kinematic parameters affecting the ball (duration of the shot and the angle at which the ball enters the basket) demonstrated no significant variations, however there was a significant change of the shooting percentage.

Key words: *basketball; jump shot; physiological load; SIMI motion system; kinematic analysis*

Introduction

Considering that basketball is a very dynamic sport which includes different types of running (short and longer sprints), accelerations, decelerations, jumping, landing and physical contacts with team players and opponents, it is implied that during practices and competitions basketball players undergo discontinued physiological loads that are occasionally of extremely high intensity. The conclusion can be made that whether it is women's or men's competitions, or during competitions for younger age categories, basketball players are exposed to high physiological loads (McInnes et al., 1995; Matthew & Delextrat, 2009; Abdelkrim, El Fazaa & El Ati, 2007). Upon increasing the intensity and entering the anaerobic load zone, the concentration of lactic acid in the blood increases, which ultimately effects the gradual occurrence of fatigue in the organism of basketball players (Allen, Lamb & Westerblad, 2008). This in turn results with the presumption that players perform specific motor movements when playing under the influence of higher fatigue (Rodriguez-Alonso et al., 2003). Consequently, it is to be expected that in such conditions the performance of stereotypical and automatized movements usually performed by a basketball player shall also be modified.

The jump shot is one of the most common way of shooting in basketball (Hay, 1985). It represents the base in hierarchical structure of basketball game knowledge (Trninić, Trninić & Jelaska, 2010). The main characteristic of the mentioned element is the fact that it enables shooting the ball towards the basket from greater distances. As such, this element of basketball technique was a result of the players' desire and need to find the best solutions in new situations. Given the fact that the primary aim in basketball is to score a basket, this element became one of the most significant elements of technique in modern basketball (Hess, 1980). There have been many studies of the jump shot in terms of biomechanical analysis, that is in terms of performing the mentioned motor task (Podmenik et al., 2017). Rojas et al., (2000) studied the modification of performing the jump shot technique during the active play of the defensive player. Many researchers were also conducted on the effect of increasing the distance from which the jump shot is realized on the motor performance of the jump shot (Podmenik et al., 2017; Okazaki & Rodacki, 2012). Okazaki et al. (2007) also examined the relationship between the duration of the jump shot and efficiency which resulted in a small statistically significant correlation ($r=0,22$; $p>0,05$). Erculj and Supej (2009) studied the influence of fatigue on performing the jump shot from the 6,25 m distance, with a top shooter of NBA quality level as the subject of their research, and they managed to prove that the technique of performing the mentioned element changes under the influence of fatigue. Likewise, similar results were

obtained in other research which demonstrated that certain kinematic parameters are altered during the performance of the jump shot under the influence of fatigue (Rupčić et al., 2015). Kinematic changes in performing different motoric tasks under the influence of fatigue was also noticed in some other sports (Becker et al., 2017). So far, most of performed research included senior players. There is a need to determine if shooting training in real, situational conditions, especially while the players are under the influence of fatigue will produce better results.

The aim of this research is to precisely determine if there are statistically significant differences in kinematic parameters of young basketball players during shooting while in different stages of fatigue.

Methods

As part of this research there was one participant, a basketball player (age = 17yr) who is a member of the Croatian U18 Men's National Team. Subject was healthy and gave written consent for testing procedure. In order for each pass towards the player to be standardized in terms of its accuracy, the Dr Dish Basketball Shooting Machine® was used in this research. The shooting machine was placed under the basket and programmed to pass the ball towards the players in time intervals of 10 seconds. In order to determine the duration of the shot and the shooting angle the 94 Fifty® Smart Sensor Basketball by InfoMotion Sports Technologies Inc. was used in this study. The mentioned ball is of standard size and weight which correspond with the official propositions proscribed by FIBA. In addition, on the basis of previous research this device demonstrates validated and objective results and, as such, can be used for scientific purposes (Rupčić, Antekolović, Knjaz, Matković, Cigrovski, 2017).

For the purpose of creating a kinematic pattern during the jump shot the SIMI Motion system with eight cameras was used (Basler SCA 640GC; 100 images per second) and it was in a semi-circular position under the basket. For the purpose of kinematic analysis 16 markers were placed on the examinee's body in anatomically referential points according to the modified Dempster model (Winter, 1990): 1 and 2) fifth metatarsal joints, 3 and 4) lateral malleolus of the fibula, 5 and 6) lateral condyles of the tibia, 7 and 8) greater trochanters, 9 and 10) acromion, 11 and 12) lateral epicondyles, 13 and 14) distal radials, 15 and 16) fifth metacarpal joints.

Description of the variables:

KNEEangle_{catch} (°) – angle of the knee joint at the moment of receiving the ball;

HIPangle_{catch} (°) – angle of the hip joint at the moment of receiving the ball;

ANKLE_{max_angle_{vel}} (° /s) – maximum angular velocity of the ankle;
KNEE_{max_angle_{vel}} (° /s) - maximum angular velocity of the knee joint;
HIP_{max_angle_{vel}} (° /s) – maximum angular velocity of the hip joint;
SHOULDER_{max_angle_{vel}} (° /s) – maximum angular velocity of the shoulder joint;
ELBOW_{max_angle_{vel}} (° /s) – maximum angular velocity of the elbow joint;
WRIST_{max_angle_{vel}} (° /s) – maximum angular velocity of the wrist;
ANKLE_{aver_angle_{vel}} (° /s) – average angular velocity of the ankle;
KNEE_{aver_angle_{vel}} (° /s) – average angular velocity of the knee joint;
HIP_{aver_angle_{vel}} (° /s) – average angular velocity of the hip joint;
SHOULDER_{aver_angle_{vel}} (° /s) – average angular velocity of the shoulder joint;
ELBOW_{aver_angle_{vel}} (° /s) – average angular velocity of the elbow joint;
WRIST_{aver_angle_{vel}} (° /s) – average angular velocity of the wrist;
Pointofrelease (m) (° /s) – highest point at the vertical line in the release of the ball;
Shooting angle (°) – angle formed by the downward line of the ball in relation to the basket;
Time of shooting (s) – time between the moment of receiving the ball and the moment in which the ball leaves the hand.

The examinee performed 30 jump shots from the 6.75 m distance as warm-up, as well as a dynamic stretching before starting with the testing. The examinee then executed three series of jump shots, each consisting of 8 shots from the previously mentioned distance. Prior to the initial testing, the lactic acid concentration of the examinee was measured after which the examinee started performing the jump shots.

Before the second series of shooting, the examinee executed continued sprints of 4x15 meters (total of 60 meters) with a change of direction of 180 degrees between each sprint, and before the third, last series, he performed continued sprints of 8x15 meters (total of 120 meters), also with a change of direction of 180 degrees between each sprint.

Immediately, after the both series of sprints, his blood lactate concentration was determined using a portable lactate analyzer (Lactate Pro LT-1710, Arkray KDK Corporation, Shiga, Japan) and then the examinee started with performing the jump shots. The mentioned type of sprint was used to attain physiological load of the player because this type of movement is often present in modern basketball game during many fast changes between defence and offense.

In order to analyse the obtained data, the Statistica for Windows, ver. 12 was used. For each of the variables the basic descriptive statistical parameters (arithmetic mean, standard deviation) were calculated, whereas the occurrence of statistically significant differences was established by applying the ANOVA for repeated measurements. Partial eta-squared (η^2_p) was used as a

measure of effect size. For the purpose of determining statistically significant differences in a single variable between the three measurements, Tuckey post hoc tests were thus employed. The $p < 0,05$ criterion was used for establishing statistical significance.

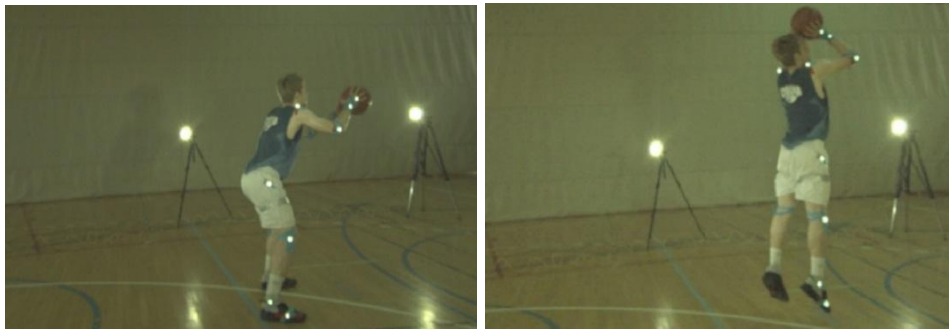

Figure 1-2. Player during the performance of a jump shot

Results

Table 1 demonstrates the basic descriptive statistical parameters of the observed variables in all three series of jump shots (initial, 4x15 m and 8x15 m), as well as the univariant analysis of variance. Out of the 17 examined variables, statistically significant differences were recognized in 8 variables (KNEEangle_{catch}, HIPangle_{catch}, SHOULDERmax_angle_{vel}, WRISTmax_angle_{vel}, ANKLEaver_angle_{vel}, KNEEaver_angle_{vel}, WRISTaver_angle_{vel}, Pointofrelease).

Table 1. Basic descriptive statistical parameters, ANOVA for the repeated measurements with partial eta-squared of the observed variables in the first, second and third series

Variable	1stseries AM±SD	2ndseries AM±SD	3rdseries AM±SD	F	p	η ² p
KNEEangle _{catch}	131.32±0.93	131.21±1.20	136.44±3.62	13.91	0.00	0.56
HIPangle _{catch}	131.13±4.93	131.85±2.03	139.16±3.63	11.39	0.00	0.52
ANKLEmax_angle _{level}	725.04±51.21	701.91±49.75	718.86±65.22	0.37	0.70	0.03
KNEEmax_angle _{level}	563.19±12.63	564.81±19.54	573.78±38.56	0.38	0.69	0.03
HIPmax_angle _{level}	357.02±11.88	354.82±13.61	359.94±20.99	0.21	0.81	0.02
SHOULDERmax_angle _{level}	510.89±22.10	504.57±9.65	484.46±18.56	4.94	0.02	0.32
ELBOWmax_angle _{level}	750.02±24.09	721.42±35.19	717.39±21.76	3.31	0.06	0.24
WRISTmax_angle _{level}	1227.02±143.73	934.88±66.76	950.04±53.23	23.23	0.00	0.69
ANKLEaver_angle _{level}	320.57±14.78	312.78±17.82	365.37±19.23	21.35	0.00	0.67
KNEEaver_angle _{level}	324.69±2.59	315.69±11.38	325.67±6.93	3.94	0.04	0.27
HIPaver_angle _{level}	171.24±8.29	181.90±6.90	171.74±12.23	3.26	0.06	0.24
SHOULDERaver_angle _{level}	305.38±12.87	303.21±9.95	291.31±14.84	2.84	0.08	0.21
ELBOWaver_angle _{level}	366.89±21.85	351.78±27.55	346.32±11.69	1.98	0.16	0.16
WRISTaver_angle _{level}	423.47±77.23	325.50±33.39	327.54±19.24	10.10	0.00	0.69
Pointofrelease	2.58±0.02	2.48±0.01	2.47±0.02	150.29	0.00	0.93
Shootingangle	41.38±1.92	40.75±0.89	41.25±1.83	0.33	0.72	0.03
Timeofshooting	0.80±0.04	0.78±0.03	0.79±0.01	0.45	0.64	0.04

Legend: KNEEangle_{catch}-angle of the knee joint at the moment of receiving the ball; HIPangle_{catch}-angle of the hip joint at the moment of receiving the ball; ANKLEmax_angle_{level}-

maximum angular velocity of the ankle; KNEEmax_angle_{vel}-maximum angular velocity of the knee joint; HIPmax_angle_{vel}-maximum angular velocity of the hip joint; SHOULDERmax_angle_{vel}-maximum angular velocity of the shoulder joint; ELBOWmax_angle_{vel}-maximum angular velocity of the elbow joint; WRISTmax_angle_{vel}-maximum angular velocity of the wrist; ANKLEaver_angle_{vel}-average angular velocity of the ankle; KNEEaver_angle_{vel}-average angular velocity of the knee joint; HIPaver_angle_{vel}-average angular velocity of the hip joint; SHOULDERaver_angle_{vel}-average angular velocity of the shoulder joint; ELBOWaver_angle_{vel}-average angular velocity of the elbow joint; WRISTaver_angle_{vel}-average angular velocity of the wrist; Pointofrelease-highest point at the vertical line in the release of the ball; Shooting angle-angle formed by the downward line of the ball in relation to the basket; Time of shooting-time between the moment of receiving the ball and the moment in which the ball leaves the hand, 1st series-initial testing; 2nd series-second series of shooting after 4x15 meters sprints; 3rd series-third series of shooting after 8x15 meters sprints; AM±SD-arithmetic mean±standard deviation; F-F test; p-level: p<0,05; η²p-partial eta-squared.

As expected, maximum deviations in relation to the initial conditions were recorded in the final measurement, when the examinee was exposed to the 8x15 meters sprint exercise, which is also demonstrated by the measured level of lactic acid concentration in the blood of 11,00 mmol/L (Tables 2 and 3).

Table 2. Tukey post hoc test of the following variables: angle of the knee joint and the hip joint at the moment of receiving the ball; maximum angular velocity of the shoulder joint and the wrist; average angular velocity of the ankle, the knee joint and the hip joint.

KNEEangle _{catch}			
sel	{1 st series} 131.32	{2 nd series} 131.21	{3 rd series} 136.44
2 nd series	0.99		
3 rd series	0.00	0.00	
HIPangle _{catch}			
sel	{1 st series} 131.13	{2 nd series} 131.84	{3 rd series} 139.16
2 nd series	0.92		
3 rd series	0.00	0.00	
SHOULDERmax_angle _{vel}			
sel	{1 st series} 510.89	{2 nd series} 504.57	{3 rd series} 484.46
2 nd series	0.75		
3 rd series	0.01	0.07	
WRISTmax_angle _{vel}			
sel	{1 st series} 1227.0	{2 nd series} 934.88	{3 rd series} 950.04
2 nd series	0.00		0.94
3 rd series	0.00	0.94	
ANKLEaver_angle _{vel}			
sel	{1 st series} 320.57	{2 nd series} 312.78	{3 rd series} 365.37
2 nd series	0.64		0.00
3 rd series	0.00	0.00	
KNEEaver_angle _{vel}			
sel	{1 st series} 324.69	{2 nd series} 315.69	{3 rd series} 325.67
2 nd series	0.07		0.04
3 rd series	0.96	0.04	
WRISTaver_angle _{vel}			
Sel	{1 st series} 423.47	{2 nd series} 325.50	{3 rd series} 327.54
2 nd series	0.00		
3 rd series	0.00	0.99	

Legend: KNEEangle_{catch}-angle of the knee joint at the moment of receiving the ball; HIPangle_{catch}-angle of the hip joint at the moment of receiving the ball; SHOULDERmax_angle_{vel}-maximum angular velocity of the shoulder joint; WRISTmax_angle_{vel}-maximum angular velocity of the wrist; ANKLEaver_angle_{vel}-average angular velocity of the ankle; KNEEaver_angle_{vel}-average angular velocity of the knee joint; WRISTaver_angle_{vel}-average angular velocity of the wrist; 1st series-initial testing; 2nd series-second series of shooting after 4x15 meters sprints; 3rd series-third series of shooting after 8x15 meters sprints; p-level: p<0.5

As presented in Table 3, it is obvious that lactate values significantly increased during the testing. From very low values of 0.9 mmol/L before the first shooting series, which corresponds to resting state, after 4x15 m sprint lactate concentration increased to 1.7 mmol/L, and after two shooting series and 8x15m sprints it was as high as 11.0 mmol/L.

Table 3. Indicators of shooting efficiency and level of lactates after all three measurements

variable	1 st series	2 nd series	3 rd series
Efficient of shooting	5/8	3/8	2/8
Lactate (mmol/L)	0.90	1.70	11.00

Legend: Efficiency of shooting-the ratio between successful and attempted shots; Lactate-blood lactate concentration before initial shooting (1st series) and after 4x15 meters sprint (2nd series) and 8x15 meters sprint (3rd series)

Angular velocities in different joints during the first, second and third series of shooting are presented in Table 4. It could be seen that maximum angular velocities of the shoulder joint and wrist were significantly scaling down with the greater manifestation of fatigue (SHOULDERmax_angle_{vel}=510.89±22.10; 504.57±9.65; 484.46±18.56, p=0.02 and WRISTmax_angle_{vel}=1227.02±143.73; 934.88±66.76; 950.04±53.23, p=0.00) as well as the elbow maximum angular velocity (ELBOWmax_angle_{vel}=750.02±24.09; 721.42±35.19; 717.39±21.76) where the diminution was present but not significant. At the same time shooting precision was reduced (Table 3.)

Table 4. Differences in the measured variables presented in percentages between the three levels of load

variable	1 st series	2 nd series	3 rd series	2.-1.	3.-2.	3.-1.
ANKLEaver_angle _{vel}	320.57	312.78	365.37	-2.43%	16.81%	13.97%
KNEEaver_angle _{vel}	324.69	315.69	325.67	-2.77%	3.16%	0.30%
HIPaver_angle _{vel}	171.24	181.90	171.74	6.22%	-5.58%	0.29%
SHOULDERaver_angle _{vel}	305.38	303.21	291.31	-0.71%	-3.92%	-4.60%
ELBOWaver_angle _{vel}	366.89	351.78	346.32	-4.11%	-1.55%	-5.60%
WRISTaver_angle _{vel}	423.47	325.50	327.54	-23.13%	0.62%	-22.65%
ANKLEmax_angle _{vel}	725.04	701.91	718.86	-3.19%	2.41%	-0.85%
KNEEmax_angle _{vel}	563.19	564.81	573.78	0.29%	1.59%	1.88%
HIPmax_angle _{vel}	357.02	354.82	359.94	-0.62%	1.44%	0.82%
SHOULDERmax_angle _{vel}	510.89	504.57	484.46	-1.24%	-3.99%	-5.17%
ELBOWmax_angle _{vel}	750.02	721.42	717.39	-3.81%	-0.56%	-4.35%
WRISTmax_angle _{vel}	1227.02	934.88	950.04	-23.81%	1.62%	-22.57%

Legend:ANKLEaver_angle_{vel}-average angular velocity of the ankle; KNEEaver_angle_{vel}-average angular velocity of the knee joint; HIPaver_angle_{vel}-average angular velocity of the hip joint; SHOULDERaver_angle_{vel}-average angular velocity of the shoulder joint; ELBOWaver_angle_{vel}-average angular velocity of the elbow joint; WRISTaver_angle_{vel}-average angular velocity of the wrist; ANKLEmax_angle_{vel}-maximum angular velocity of the ankle; KNEEmax_angle_{vel}-maximum angular velocity of the knee joint; HIPmax_angle_{vel}-maximum angular velocity of the hip joint; SHOULDERmax_angle_{vel}-maximum angular velocity of the shoulder joint; ELBOWmax_angle_{vel}-maximum angular velocity of the elbow joint; WRISTmax_angle_{vel}-maximum angular velocity of the wrist; 1st series-initial testing; 2nd series-second series of shooting after 4x15 meters sprints; 3rd series-third series of shooting after 8x15 meters sprints; 2.-1.-distinction between 2nd series and 1st series; 3.-2.-distinction between 3rd series and 2nd series; 3.-1.-distinction between 3rd series and 1st series

Changes in the height of releasing the ball as a result of different levels of the physiological load are presented graphically (Figure 3).

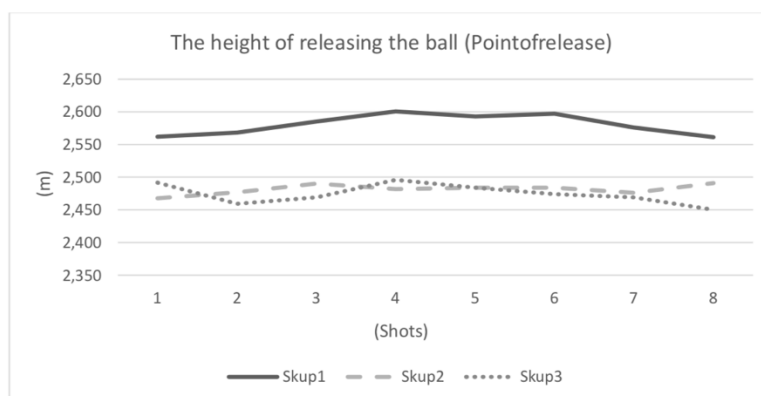

Figure 3. Changes in the height of releasing the ball as a result of different levels of load

Discussion

Upon analysis of the measured values of the knee joint and the hip joint at the moment of receiving the ball, it was noted that after greater fatigue intensity the mentioned values also increase, which thus indicates the fact that the examinee was in a more upright position at the moment of receiving the ball when exposed to a greater level of fatigue. Previous research determined that the values of the hip and knee were decreased when shooting from larger distances, i.e., when the player performs the jump shot from larger distances, he also lowers his centre of gravity in the initial phase of the shot, which consequently leads to the flexion of joints in the lower extremities (Svoboda et al., 2016).

It is presumed that in order for a player to perform the jump shot quickly enough, without him being obstructed by the defensive player, the player must be in active position which means that his centre of gravity is adequately lowered, in addition to a certain flexion of the lower extremities. Combined with properly balanced space-time conditions of receiving the ball and using the ground reaction force, such a position is assumed to influence the correct angle of releasing the ball, and then consequently also the shooting angle which ultimately impacts the precision of the jump shot. Former research also determined a statistically significant correlation between the angle of releasing the ball and the shooting angle, as well as a causal link with precision (Lenik & Lenik, 2016; Fontanella, 2006).

Upon examining the angular velocities of joints in the upper extremities, interesting observations can be recorded. When the examinee was most tired, maximum angular velocity values of the shoulder joint and the wrist statistically significant decreased, whereas in the elbow joint the observed values also decreased, however not in a statistically significant degree.

The above-mentioned observations can also be determined by performing additional analyses of the obtained results of average and maximum angular velocities of joints in the upper extremities which lead to the conclusion that the most significant changes were recorded between the initial measurement, when the examinee was not exposed to a high load level, and the most intensive load when the lactic acid concentration in the blood was 11.0 mmol/L. Therefore, the average angular velocity in the shoulder joint was reduced by 4.60%, in the elbow joint by 5.60% and in the wrist by 22.65%. This also refers to values of maximum angular velocities, in which case the shoulder joint value was decreased by 5.17%, the elbow joint by 4.35% and the wrist by 22.57%. Tsai et al. (2006) obtained comparable results where the values of angular velocities in the elbow joint and the wrist statistically significantly decreased under the influence of higher load.

After analysing the values of angular velocities of joint in the lower extremities, it can be noted that in most cases the mentioned values increase, particularly between the second (2nd series) and third measurement (8x15m). Thus, for example, the largest difference in the average angular velocity of the ankle was recorded between the second and third measurement, and it was 16.81% ($p=0,00$), while in the maximum angular velocity values the difference was 2.41%. Upon examining the knee joint and the hip joint the differences were not statistically significant, however, they were noticeable. Tsai et al. (2006) in their research concluded that under higher level of load, the angular velocity of the hip joint decreased for 3.04% (182.44; 176.88), and in ankle joint for 1.65% (564.77; 555.40), but the angular velocity in knee joint has increased by 9.46% (279.73; 306.21).

Based on the measured kinematic parameters, the conclusion can be made that the examinee changed his usual pattern of performing the jump shot. The above-mentioned is especially noticeable in the results of angular velocity of the wrist. It is precisely the wrist that plays an important role in the correct performance of jump shots as it produces the final "whip" when shooting the ball, which combined with the action of the fingers gives the ball the adequate speed and proper trajectory that consequently affects the precision of the shot (Fontanella, 2006). Changes in the pattern of performing the jump shot inevitable lead to changes in shooting precision. The notable decrease of shooting precision was determined. Similarly, Nezhad, Rahimi & Sarshin (2015) while studying the effects of fatigue on knee and elbow kinematics during 3 points jump shot concluded that general fatigue negatively affected shooting accuracy in young boys.

Furthermore, this research also showed a notable statistically significant difference in the height at the moment of releasing the ball. In other words, under the influence of fatigue the basketball

player performs the final phase of releasing the ball at a reduced height which can ultimately result in an allowed blocking of the shot by the defensive player (Rojas et al., 2010; Borović, Rupčić & Antekolović, 2015).

The parameters that demonstrated no statistically significant changes were the speed of releasing the ball and the angle at which the ball enters the basket.

Conclusion

From the biomechanical standpoint, the jump shot is a complex motor movement. Upon analysis of kinematic parameters of the jump shot of the examinee before and after the physiological load, the conclusion is made that fatigue impacts certain changes in the kinematic pattern of performing the jump shot. The angular velocities of joint in the lower extremities noticeably increased, while the mentioned parameters in the upper extremities decreased. In addition, as a result of fatigue, the height of releasing the ball also decreased. Despite the changes in the above-mentioned parameters, the action performed on the ball remained unchanged considering that the speed of releasing the ball, as well as the angle at which the ball entered the basket demonstrated no changes. Even though the action performed on the ball did not alter from the biomechanical standpoint, the reduction of shooting precision under the influence of a higher level of fatigue still suggests that certain deviations occurred in the overall pattern of performing the examined motor skill.

Based on this research, a proposal for the improvement of basketball practice is surely to perform training processes during which the jump shot and the development of shooting precision would be executed in conditions of variable load that shall ultimately be directed towards annulling the deviations in the kinematic pattern of the jump shot, which shall consequently also positively affect the development of shooting precision.

Considering that this research was conducted with only one examinee and in controlled environment, all the conclusions should be taken with caution. This research surely opens the possibility for future research that should focus on influence of fatigue during different in game situations on shot efficiency.

References

- ABDELKRIM, N. B., EL FAZAA, S., EL ATI, J. 2007. Time-motion analysis and physiological data of elite under-19-year-old basketball players during competition. *British Journal of Sports Medicine*, 41(2), 69 –75.
- ALLEN, D. G., LAMB, G. D., WESTERBLAD, H. 2008. Skeletal muscle fatigue: cellular mechanisms. *Physiological reviews*, 88(1), 287-332.
- BECKER, S., FRÖHLICH, M., KELM, J., LUDWIG, O. 2017. Change of muscle activity as well as kinematic and kinetic parameters during headers after core muscle fatigue. *Sports*, 5(1), 10.
- BOROVIĆ, I., RUPČIĆ, T., ANTEKOLOVIĆ, LJ. 2015. Does active position of defender player change some kinematic parameters in jump shot? 25. *Ljetna škola kineziologa Republike Hrvatske*, 169-175.
- ERČULJ, F., SUPEJ, M. 2009. Impact of fatigue on the position of the release arm and shoulder girdle over a longer shooting distance for an elite basketball player. *The Journal of Strength and Conditioning Research*, 23(3), 1029-36.
- FONTANELLA, J. J. 2006. *The Physics of Basketball*. The Johns Hopkins University Press.
- Hay, J. G. 1985. *The Biomechanics of Sports Techniques*. N.J.: Prentice – Hall.
- HESS, C. 1980. Analysis of the jump shot. *Athletic Journal*, 61(3), 30 - 33, 37 - 38, 58.
- LENIK, P., LENIK, J. 2016. The point system and kinematic parameters analysis of free throw with the use of “94fifty smart basketball” testing tool. *Scientific Review of Physical Culture*, 6 (4).
- MATTHEW D., DELESTRAT A. 2009. Heart rate, blood lactate concentration, and time-motion analysis of female basketball players during competition. *Journal of Sports Sciences*, 27(8), 813-821.
- MCINNES, S. E., CARLSON, J. S., JONES, C. J., MCKENNA, M. J. 1995. The physiological load imposed on basketball players during competition. *Journal of Sports Sciences* 13(5), 387-397.
- NEZHAD, V. S., RAHIMI, A., SARSHIN, A. 2015. Effect of fatigue on body joints kinematic in 3 points jump shot among basketball player young boys. *Biological Forum–An International Journal*, 7, 1910-1914.
- OKAZAKI, V., RODACKI, A. 2012. Increased Distance of Shooting on Basketball Jump Shot. *Journal of Sports Science and Medicine*, 11(2), 231–237.

- OKAZAKI, V. H. A., OKAZAKI, F. H. A., SASAKI, J. E., KELLER, B. 2007. Speed-accuracy relationship in basketball shoot. *The Fiep Bulletin*, 77, 745-747.
- PODMENIK, N., SUPEJ, M., ČOH, M., ERČULJ, F. 2017. The effect of shooting range on the dynamics of limbs angular velocities of the basketball shot. *Kinesiology*, 49, 92-100.
- RODRIGUEZ-ALONSO, M., FERNANDEZ-GARCIA, B., PEREZ-LANDALUCE, J., TERRADOS, N. 2003. Blood lactate and heart rate during national and international women's basketball. *The Journal of Sports Medicine and Physical Fitness*, 43: 432-436.
- ROJAS, F. J., CEPERO, M., ONA, A., GUTIERREZ, M. 2000. Kinematic adjustments in the basketball jump shot against an opponent. *Ergonomics*, 43(10), 1651-1660.
- RUPČIĆ, T.; ANTEKOLOVIĆ, LJ. KNJAZ, D. MATKOVIĆ, B.; CIGROVSKI, V. 2016. Reliability analysis of the 94 fifty smart sensor basketball. *Proceedings of the 10th International Conference on Kinanthropology*, Brno: Faculty of sport studies, 432-438.
- RUPČIĆ, T., KNJAZ, D., BAKOVIĆ, M., DEVRNJA, A., MATKOVIĆ, B. R. 2015. Impact of fatigue on accuracy and changes in certain kinematic parameters during shooting in basketball. *Hrvatski športskomedicinski vjesnik*, 30, 15-20.
- SVOBODA, I., KNJAZ, D., BAKOVIĆ, M., MATKOVIĆ, B., PRLENDA, N. 2016. Differences in some kinematic parameters during shooting from distance of 6,25 m and 6,75m. *25. Ljetna škola kineziologa Republike Hrvatske*, 279-284.
- TRNINIĆ, S., TRNINIĆ, M., JELASKA, I. 2010. Hierarchical structuring of knowledge in basketball game. *Acta Kinesiologica*, 4(1), 37-44.
- TSAI, C., HO, W. H., LI, Y. K., HUANG, C. H. 2006. The kinematic analysis of basketball three-point shoot after high intensity program. Taipei: Institute of Sports Science, Taipei Physical Education College.
- WINTER, D. A. 1990. *Biomechanics and Motor Control of Human Movement*, Second edition. John Wiley & Sons, Inc., Toronto.

Study 4: Kinematic Analysis of 2-Point and 3-Point Jump Shot of Elite Young Male and Female Basketball Players

Vencúrik, T., Knjaz, D., Rupčić, T., Sporiš, G., & Li, F. Kinematic Analysis of 2-Point and 3-Point Jump Shot of Elite Young Male and Female Basketball Players. *International Journal of Environmental Research and Public Health*, 2021, 18, 934.
<https://doi.org/10.3390/ijerph18030934>



International Journal of Environmental Research and Public Health, 18 (3), 934.

doi: 10.3390/ijerph18030934.

Manuscript submitted for publication: 1 December 2020

Manuscript accepted for publication: 15 January 2021

Journal impact factor: 3.390

Indexed/Abstracted in: MEDLINE and Web of Science (WoS).

ISSN: 1661-7827 (Print); 1660-4601 (Online)



Article

Kinematic Analysis of 2-Point and 3-Point Jump Shot of Elite Young Male and Female Basketball Players

Tomas Vencúrik ¹, Damir Knjaz ², Tomislav Rupčić ², Goran Sporiš ^{2,*} and Feng Li ²

¹ Department of Sports, Faculty of Sports Studies, Masaryk University, 62500 Brno, Czech Republic; vencurik@fsps.muni.cz

² Laboratory for Sports Games, Faculty of Kinesiology, University of Zagreb, 10000 Zagreb, Croatia; damir.knjaz@kif.unizg.hr (D.K.); tomislav.rupcic@kif.unizg.hr (T.R.); li.feng@kif.unizg.hr (F.L.)

* Correspondence: goran.sporis@kif.unizg.hr

Abstract: Basketball shooting is one of the most important offensive skills in basketball. Winning or losing a game mostly depends on the shooting effectiveness. The study aims to compare the selected kinematic variables of 2-point (2-pt) and 3-point (3-pt) jump shots (after making a cut and receiving the ball) and ascertain the differences between elite male under 16 and 18 (U16M, U18M) and female under 16 and 18 (U16F, U18F) basketball players. Overall, forty-eight young male and female basketball players participated in the study. 3D motion analysis using an inertial suit with the addition of utilizing a smart ball was performed for assessing the 2-pt and 3-pt shooting techniques. Players in male categories shot for 2-pt with a higher center of mass difference in the vertical direction (U16M 5.7 cm, U18M 3.9 cm vs. U16F 1.4 cm, U18F 0.6 cm), with higher release shoulder angle (U16M 110.9, U18M 113.8 vs. U16F 103, U18F 105), and with a higher entry angle of the ball (U16M 34, U18M 32 vs. U16F 30, U18F 30) when compared to female categories ($p < 0.001$). In the 3-pt shooting, there were differences between male and female categories in the shoulder angle when releasing the ball ($p < 0.001$). In the players shooting speed, there were differences between U16M vs. U18F (0.95 ± 0.1 vs. 0.88 ± 0.1 ; $p = 0.03$) and U16F vs. U18F (0.96 ± 0.06 vs. 0.88 ± 0.1 ; $p = 0.02$) players. Male categories shot 3-pt shots with a smaller center of mass difference in the horizontal direction when compared to 2-pt shots ($p < 0.001$). The entry angle was higher in successful shooting attempts compared to unsuccessful shooting attempts when shooting for 3-pt ($p = 0.02$). Player shooting speed was higher in all categories (except U18F) when shooting for 3-pt ($p < 0.001$). It appears that performers show difference in kinematic variables based on distance from the basket. Basketball coaches and players should work to minimize the kinematic differences between 2-pt and 3-pt shooting and to optimize the shooting technique.



Citation: Vencúrik, T.; Knjaz, D.; Rupčić, T.; Sporiš, G.; Li, F. Kinematic Analysis of 2-point and 3-point Jump Shot of Elite Young Male and Female Basketball Players. *Int. J. Environ. Res. Public Health* **2021**, *18*, 934. <https://doi.org/10.3390/ijerph18030934>

Received: 1 December 2020

Accepted: 15 January 2021

Keywords: catch-and-shoot; curl cut; center of mass; shoulder angle; entry angle

1. Introduction

Basketball shooting is an essential offensive skill because it directly influences the outcome of the game. Other basketball offensive skills such as dribbling and passing are used by players to create the best position for shooting. Several studies confirm the importance of basketball shooting. The investigation into game-related statistics revealed that especially effective field goals (along with defensive rebounds, free throw percentages, and assists) correlated with win/loss in elite basketball competitions [1-3]. Field goals include more types of shooting, i.e., lay-ups, jump shots, dunks, hook shots, and tip-ins. Except for jump shots, the other types of shooting are used primarily close to the basket. More than 60% of all field goal attempts in the Women's National Basketball Association (WNBA) in the 2010 season were jump shots, which supports the importance of this type of shooting [4]. National Basketball Association (NBA) shows similar statistics in shooting. According to NBA.com/Stats [5], 58.8% of all jump shots taken during the regular season 2016–2017, by all NBA teams. Furthermore, 29.5% of all shots were taken after receiving a pass (catch and shoot situation). The most common situation is when the offensive player with the ball drives to the basket and the weak side defender has to help with the drive. Then the player passes the ball to an undefended teammate who can shoot. Therefore, these statistics confirm the importance of shooting after receiving the pass. In this context, Ibáñez et al. [6] based on game-related statistics, detects the dependency between assisted shots and the winning of the game. The team, which made more assists in the game, had a higher chance to win the game.

In the past, various aspects related to jump shots were investigated. Miller and Bartlett [7] and Okazaki and Rodacki [8] assessed the impact of increasing horizontal distance on the kinematic parameters of a jump shot (segmental joint angle, center of mass displacement, release angle, release speed, etc.). When the distance increases, the player reduces the ball release angle, and the ball follows a flatter flight path. Erčulj and Supej [9] observed the impact of fatigue on joint angles and the height of the jump. The measured elbow and upper arm angles decrease with the growing fatigue. Their study demonstrates significant changes in shooting technique as a consequence of moderate and high fatigue. Another study, Rojas et al. [10] explores whether a defender's presence has any impact on selected kinematic parameters. When a player is confronted by an opponent, the ball is released faster and from a greater height. Furthermore, some studies investigate the visual control of a jump shot effectivity because this determinant of basketball shooting is considered important [11-12]. Training the visual control forces

players to learn to use the visual information about the rim in a shorter time (up to 400 ms). It means that players have more time to perceive other factors that relate to the game.

Scientific literature mentioned above assessing the kinematic and physical parameters of a jump shot presents only shots taken without any action before shooting (dribbling or cutting—no pull-up jump shots or catch-and-shoot jump shots). Measuring kinematic and physical parameters of a jump shot that are more similar to real game conditions is absent (e.g., catch-and-shoot situation after a cut). Moreover, comparing these parameters between gender is even less studied having in mind the differences between male and female in physical performance. The novelty and uniqueness of the current study is in the documented selected kinematic variables of the jump shot after making a cut and receiving a ball. Therefore, this study aims to compare the selected kinematic variables of a basketball jump shot (separately for 2-point and 3-point shots) after receiving the ball (catch-and-shoot situation after a cut) and ascertain the differences between the elite U16 and U18 male and female basketball players, and between successful and unsuccessful shots. It was hypothesized that differences in selected kinematic variables will be observed between 2-point and 3-point shots regarding different categories and success of the shots.

2. Materials and Methods

2.1. Participants

Fifty-eight basketball players participated in this study. Due to some technical issues with equipment and incorrect data, ten subjects were removed from the final data analysis. After removing ten players, forty-eight Croatian elite young basketball players were included in the research. All selected players were chosen for a wider national selection for the 2017 European Championship in U16 and U18 male and female categories. Sixteen male basketball players were members of the U16 team (U16M) with an average age 15.4 ± 0.6 , body height 192.6 ± 6.3 cm, and body mass 80.5 ± 9.8 kg. Fourteen male basketball players were members of the U18 team (U18M) with average age 17 ± 0.7 , body height 197.9 ± 7.9 cm, and body mass 87.5 ± 9.3 kg. The U16 female team (U16F) included eleven basketball players with average age 15.5 ± 0.9 , body height 178.3 ± 5.7 cm, and body mass 69 ± 9.1 kg. The U18 female team (U18F) included seven basketball players with average age 17 ± 0.8 , body height 176.5 ± 7.4 cm, and body mass 74.2 ± 8.8 kg. Participants had no injuries that could have affected their shooting performance. Players were informed about this study's goals, participated voluntarily, and signed the informed consent (in the case of a minor, a legal representative). The study was

conducted in accordance with the Declaration of Helsinki and following the ethical standards of the University of Zagreb (ethical approval number: 113/2016).

2.2. Procedure

Before each testing session, the players did a standardized warm-up, consisting of jogging with dribbling, shooting, lay-ups, and dynamic stretching. After the warm-up, players shot freely for 5 min—pull-up jump shots or catch-and-shoot jump shots. Each player performed four 2-pt shots from the right side and four 2-pt shots from the court's left side. The horizontal distance of the two shots on each side of the basket was approximately 4 m with an angle of 0° from the backboard. For the other two shots, the distance was approximately 4.9 m with an angle of 60° from the backboard ("elbow of the paint"). In a 2-pt shooting, player run from the first cone (1.8 m from baseline and 3.5 m from sideline), behind the second (3.75 m from baseline and 3.3 m from sideline) and third cone (5.7 m from baseline and 4.2 m from sideline) (Figure 1A), and vice versa (Figure 1B). Players also perform two 3-pt shots from the spot close to both corners of the court. All shots have been taken after a pass and after the player run around the cones to the marked shooting spot (catch-and-shoot situation). With a 3-pt shooting, the player run from underneath the basket to the corner of the court (see Figure 2). Player shot after a pass from an assistant coach (approximate distance 6.6–6.75 m). If the pass was not accurate (outside the shooting pocket), the player repeated the attempt. There was a rest period of at least 30 s between each attempt on each side. The player first attempted four 2-pt shots from one side of the court, then from the other side, and then moved to a 3-pt shooting where the player first attempted 2 shots from one side and then 2 attempts from the other side. The players have been instructed to shoot directly to the hoop (not a bank shot) with their natural technique as they do in training and during games, and before each measurement, they had several warm-up attempts.

For analysis of selected kinematic variables of jump shots, the MNV BIOMECH Awinda inertial system (Xsens Technologies B.V., Enschede, The Netherlands) was used. The player wore a full-body suit equipped with 17 wireless motion trackers (sampling frequency 60 Hz) to ensure full 3D motion analysis. Detailed movement analysis was done using the MVN Studio BIOMECH software (Xsens Technologies B.V., Enschede, The Netherlands). Calibration of sensors was set in N-pose. If calibration was rated less than successful it is repeated. After calibration and before start of measuring and each shot, subject was pleased to raise arms (approx. 90° and 180°) to assure that system is measuring correctly, sensors are in good position and calibration was indeed successful. If change of values occur during measuring or sensor moves from initial position calibration was repeated. If movement is very fast and long lasting,

multiple calibration should be performed for assuring correct data. Reprocessing of data after recording reduce errors of sensor positioning. Although measuring and data extraction is faster than previous methods, it is very important to be consistent in correct positioning of body segments and sensors. Calibration lasts more than 30 s which can significantly affect time and measurement protocol if there is need of multiple trials. Subject is standing under the basket pointing toward corner (3-pt shot). X-axis represents anterior-posterior movement regard to basket. Because the moment when the ball was received and released from the hand could not be identified by the software MVN Studio BIOMECH, the digital cameras Garmin VIRB ULTRA 30 (Garmin International, Inc., Olathe, KS, USA) were used (sampling frequency 60 fps). The video was used for qualitative purposes. There was no synchronization between camera and Xsens. To measure other parameters, i.e., the ball's entry angle (when the ball is approaching the rim) and the player's contact time with the ball, the 94fifty ball (InfoMotion Sports Technologies Inc., Dublin, Ohio, USA) was used. Ball contains nine accelerometers inside which can detect force (a 360-degree view of it) and speed, ball rotation and ball arc. Ball has a data transmission time of 100 milliseconds. The validity and reliability of 94fifty ball were investigated in studies by Abdelrasoul et al. [13] and Rupčić et al. [14].

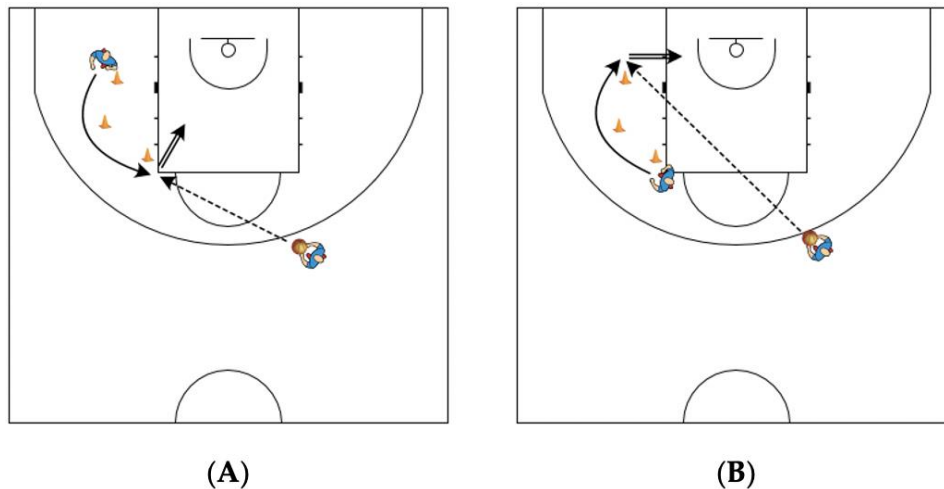

Figure 1. (A): 2-pt shooting after curl-cut with the angle of 60° from the backboard. **(B):** 2-pt shooting after curl-cut with the angle of 0° from the backboard.

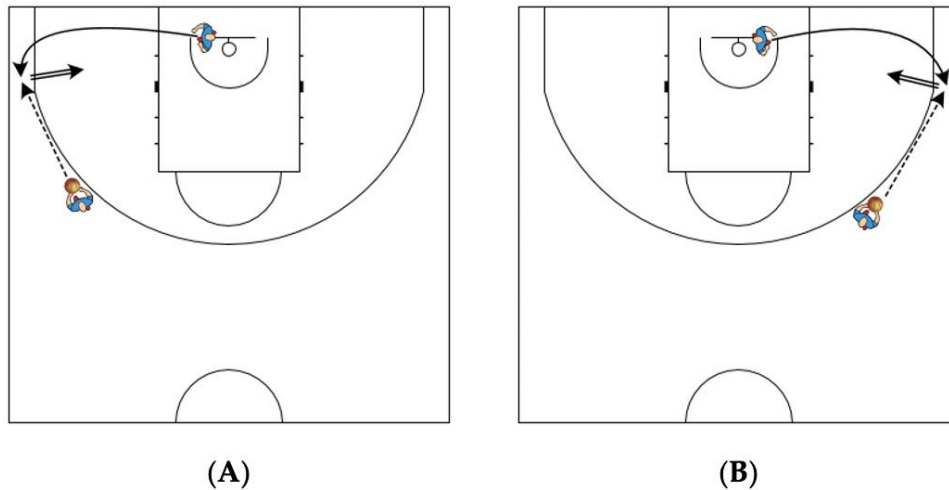

Figure 2. (A): 3-pt shooting after curl-cut from the left side. (B): 3-pt shooting after curl-cut from the right side.

2.3. Variables

During the jump shot, selected kinematic and physical parameters were observed: (a) center of mass when catching the ball (cm); (b) center of mass minimum with the ball (Z-axis—vertical direction) (cm); (c) shoulder angle at ball release (SA) ($^{\circ}$); (d) entry angle of the ball when approaching the rim (EA) ($^{\circ}$); (e) player shooting speed (contact time with the ball) (PSS) (s); (f) center of mass anterior-posterior displacement—when both feet touch the ground (X-axis—towards the basket) (cm). The last-mentioned variable (f) was set only for 3-pt shots. Two variables were computed. The first one was the difference between the center of mass when catching the ball and the center of mass minimum with the ball and was termed (g) center of mass difference Z-axis (CoMDZ) (cm). The second one was the difference between the center of mass when catching the ball and the center of mass anterior-posterior displacement and was termed (h) center of mass difference X-axis (CoMDX) (cm). Variables included in statistical analysis: (c–e), (g), and (h).

2.4. Statistical Analysis

An a priori analysis using G*Power software (version 3.1.9.2; Heinrich Heine University Düsseldorf, Düsseldorf, Germany) for ANOVA (using an effect size of 0.25, alpha value of 0.05, and power of 0.80) recommended a sample size of 175. Overall, 573 shots were analysed, while 381 shots were for 2-pt and 192 shots were for 3-pt. The successfulness of all shots was also recorded and included in the analysis. Descriptive statistics were used, and data are expressed as a mean \pm standard deviation. Shapiro-Wilk's test assessed the normality of distribution, and Levene's test evaluated the homogeneity of variance. When the normality of

distribution or homogeneity of variance was violated, the log-transformation of data for eliminating non-uniformity was used [15].

Factorial analysis of variance (ANOVA) (between-between design) was used because it simultaneously analyses the differences in the dependent variables between groups of subjects and between the effectivity of shots [16]. Therefore, the 4×2 design (two-way) was applied, where one main factor was a group of players (U16M, U18M, U16F, and U18F), and the other one was a shot effectivity (successful, unsuccessful). Moreover, the interaction of these two factors on the dependent variable was used because it can combine the effect of the factors on the dependent variable. If ANOVA detected any significant differences, the Tukey HSD post hoc test comparisons were carried out. Mean difference (MD), and 95% confidence intervals for post hoc comparison were also determined. The size of the effect was determined by partial eta squared (η^2_p), which is suggested by Lakens [17] and Richardson [18]. Partial eta squared values of 0.01, 0.06, and 0.14 indicated a small, medium, and large effect of the measurement [19]. Differences between 2-pt and 3-pt shots for each category separately were assessed by independent t-test and additionally by Cohen's d. Cohen's d values were interpreted as 0.2 for small, 0.5 for medium, and 0.8 for large effect size [19]. The level of statistical significance was set at $\alpha = 0.05$. For all statistical analyses, software IBM SPSS Statistics 24 (IBM Corp., Armonk, NY, USA) and Statistica 13.2 (StatSoft Inc., Tulsa, OK, USA) were used.

3. Results

3.1. Differences in Categories in 2-pt Shooting

Table 1 provides descriptive statistics for selected kinematic variables. CoMDZ was higher but insignificant in successful shooting attempts compared to unsuccessful ones ($F_{1,373} = 2.4$, $p = 0.12$, $\eta^2_p = 0.006$). Significant differences with large effect size in CoMDZ were detected between individual age categories of men and women ($F_{3,373} = 14.3$, $p < 0.001$, $\eta^2_p = 0.103$). The U18F category shot with the smallest difference in the center of mass displacement. A pairwise comparison of categories showed differences between the categories: U16M vs. U16F, $p < 0.001$, MD = 4.3, 95% CI (2.2, 6.4); between U16M vs. U18F, $p < 0.001$, MD = 5.1, 95% CI (2.7, 7.5); between U18M vs. U16F, $p = 0.01$, MD = 2.5, 95% CI (0.4, 4.7); between U18M vs. U18F, $p = 0.003$, MD = 3.3, 95% CI (0.9, 5.8). For interaction effect, difference was not detected ($F_{3,373} = 1$, $p = 0.38$, $\eta^2_p = 0.008$).

There was no significant difference between successful and unsuccessful shooting attempts in the variable SA ($F_{1,368} = 0.09$, $p = 0.76$, $\eta^2_p < 0.001$). SA was almost the same for successful and unsuccessful shots. However, the difference in SA was significant between the individual

age categories of men and women with large effect size ($F_{3,368} = 15.9$, $p < 0.001$, $\eta^2p = 0.115$). Pairwise comparison of categories using Tukey HSD test showed statistical differences: between categories U16M vs. U16F, $p < 0.001$, MD = 7.0, 95% CI (3.0, 11.0); between U18M vs. U16F, $p < 0.001$, MD = 10.5, 95% CI (6.4, 14.6); between U18M vs. U18F, $p < 0.001$, MD = 7.9, 95% CI (3.2, 12.7). Differences in SA in interaction effect were not significant ($F_{3,368} = 0.5$, $p = 0.72$, $\eta^2p = 0.004$).

EA was higher in successful shooting attempts compared to unsuccessful shooting attempts. However, the difference was insignificant ($F_{1,372} = 2.7$, $p = 0.1$, $\eta^2p = 0.007$). Significant differences with large effect size were recorded between the observed categories U16M, U18M, U16F, and U18F ($F_{3,372} = 13.4$, $p < 0.001$, $\eta^2p = 0.098$). Pairwise comparison of categories showed differences: between categories U16M vs. U18M, $p = 0.002$, MD = 2.6, 95% CI (0.8, 4.4); between U16M vs. U16F, $p < 0.001$, MD = 4.5, 95% CI (2.5, 6.4); between U16M vs. U18F, $p < 0.001$, MD = 4.2, 95% CI (2.0, 6.5). Interaction effect was also insignificant ($F_{3,372} = 1.1$, $p = 0.34$, $\eta^2p = 0.009$).

PSS was very similar for successful and unsuccessful shots, with minimal difference. there were no differences identified in shooting speed between successful and unsuccessful shots ($F_{1,373} = 1.5$, $p = 0.22$, $\eta^2p = 0.004$). There were no differences between the categories ($F_{3,373} = 1.4$, $p = 0.25$, $\eta^2p = 0.011$) or the interaction effect ($F_{3,373} = 0.3$, $p = 0.85$, $\eta^2p = 0.002$).

Table 1. Descriptive statistics of selected kinematic variables for 2-pt shooting according to efficiency and category.

Efficiency	Category	CoMDZ (cm)	SA (°)	EA (°)	PSS (s)
		M ± SD	M ± SD	M ± SD	M ± SD
Successful	U16M	6.5 ± 6.2	110.9 ± 10.4	35.0 ± 6.0	0.83 ± 0.09
	U18M	5.1 ± 5.8	113.8 ± 11.4	32.2 ± 3.9	0.83 ± 0.1
	U16F	2.5 ± 6.8	102.7 ± 7.7	31.6 ± 5.4	0.85 ± 0.09
	U18F	0.4 ± 6.4	104.3 ± 13.3	31.8 ± 5.5	0.85 ± 0.11
	Total	4.2 ± 6.6	108.9 ± 11.6	32.9 ± 5.4	0.84 ± 0.1
Unsuccessful	U16M	5.1 ± 5.1	109.5 ± 13.8	34.9 ± 5.8	0.84 ± 0.09
	U18M	3.1 ± 5.2	113.4 ± 11.4	32.5 ± 5.2	0.84 ± 0.1
	U16F	0.8 ± 5.7	103.3 ± 7.5	29.7 ± 5.1	0.87 ± 0.08
	U18F	1.2 ± 6.4	107.0 ± 10.7	29.6 ± 6.4	0.85 ± 0.11
	Total	2.9 ± 5.7	108.8 ± 12.0	32.2 ± 5.9	0.85 ± 0.09

Total	U16M	5.7 ± 5.6 ^{bc}	110.0 ± 12.5 ^b	34.9 ± 5.9 ^{abc}	0.84 ± 0.09
	U18M	3.9 ± 5.5 ^{bc}	113.6 ± 11.4 ^{bc}	32.3 ± 4.7	0.84 ± 0.1
	U16F	1.4 ± 6.1	103.1 ± 7.6	30.4 ± 5.2	0.86 ± 0.08
	U18F	0.6 ± 6.3	105.6 ± 12	30.7 ± 6.0	0.85 ± 0.11
	Total	3.5 ± 6.1	108.8 ± 11.8	32.5 ± 5.7	0.85 ± 0.1

Legend: M—mean, SD—standard deviation; a—difference when compared to U18M, b—difference when compared to U16F, c—difference when compared to U18F.

3.2. Differences in Categories in 3-pt Shooting

Descriptive statistics of selected kinematic variables for 3-pt shooting are given in Table 2. There were no differences in shooting efficiency ($F_{1,184} = 0.4$, $p = 0.51$, $\eta^2p = 0.02$) recorded in the CoMDZ variable between categories ($F_{3,184} = 0.3$, $p = 0.84$, $\eta^2p = 0.05$), nor in the interaction ($F_{3,184} = 0.2$, $p = 0.87$, $\eta^2p = 0.04$).

The differences in SA were small and insignificant between successful and unsuccessful shooting attempts ($F_{1,183} = 1.9$, $p = 0.17$, $\eta^2p = 0.01$). ANOVA detected a significant difference and large effect size between categories ($F_{1,183} = 9.3$, $p < 0.001$, $\eta^2p = 0.13$). Pairwise comparison using the Tukey HSD test showed differences: between U16M vs. U16F, $p < 0.001$, MD = 12.1, 95% CI (5.6, 18.6); between U18M vs. U16F, $p < 0.001$, MD = 16.2, 95% CI (9.5, 22.8); between U18M vs. U18F, $p < 0.002$, MD = 10.9, 95% CI (3.3, 18.5). The difference in SA in interaction was not significant and the effect size was small ($F_{3,183} = 0.8$, $p = 0.49$, $\eta^2p = 0.01$).

EA was higher in successful shooting attempts compared to unsuccessful shooting attempts. The difference was significant, the effect size indicates a small effect between the average EA values ($F_{1,183} = 6.0$, $p = 0.02$, $\eta^2p = 0.03$). The difference between the categories was insignificant in EA ($F_{3,183} = 1.9$, $p = 0.13$, $\eta^2p = 0.03$), similarly as for the interaction ($F_{3,183} = 0.6$, $p = 0.6$, $\eta^2p = 0.01$).

The PSS variable was lower for successful than for unsuccessful shooting attempts, but the difference was insignificant ($F_{1,183} = 0.6$, $p = 0.46$, $\eta^2p = 0.03$). Differences were also noted between the categories and the effect size indicated a medium effect ($F_{3,180} = 4.3$, $p = 0.06$, $\eta^2p = 0.067$). No significant differences were identified in the interaction ($F_{3,180} = 0.5$, $p = 0.65$, $\eta^2p = 0.009$). Pairwise comparison using Tukey HSD test showed specific differences between the U16M vs. U18F categories, $p = 0.03$, MD = 0.07, 95% CI (0.02, 0.12), and between U16F vs. U18F $p = 0.02$, MD = 0.08, 95% CI (0.02, 0.13).

In CoMDX, there was no difference between successful and unsuccessful shooting attempts ($F_{1,182} = 0.02$, $p = 0.88$, $\eta^2p < 0.01$). There were also insignificant differences between the categories, but the effect size indicates a large effect ($F_{3,182} = 2.2$, $p = 0.09$, $\eta^2p = 0.34$). Differences in the interaction were identified as insignificant ($F_{3,182} = 1.6$, $p = 0.2$, $\eta^2p = 0.03$).

Table 2. Descriptive statistics of selected kinematic variables for 3-pt shooting according to efficiency and category.

Efficiency	Category	CoMDZ (cm)	SA (°)	EA (°)	PSS (s)	CoMDX (cm)
		M ± SD	M ± SD	M ± SD	M ± SD	M ± SD
Successful	U16M	1.8 ± 5.2	114.8 ± 16.2	43.7 ± 4.8	0.96 ± 0.12	18 ± 12.5
	U18M	0.4 ± 4.8	115.2 ± 14.6	43.1 ± 4.2	0.9 ± 0.04	13.4 ± 11.1
	U16F	2.2 ± 6.3	103.4 ± 10.3	44.3 ± 4.3	0.93 ± 0.08	21.6 ± 13.9
	U18F	1.3 ± 4.2	111.4 ± 11.8	46.7 ± 4.3	0.89 ± 0.12	15.9 ± 10.2
	Total	1.4 ± 5.1	112.3 ± 14.5	44.0 ± 4.5 [†]	0.93 ± 0.1	17 ± 12.1
Unsuccessful	U16M	0.2 ± 6.8	111.6 ± 14.5	42.6 ± 4.6	0.95 ± 0.08	13.4 ± 11.1
	U18M	0.7 ± 5.4	117.3 ± 11.6	42.4 ± 4.1	0.93 ± 0.06	14.4 ± 14.8
	U16F	1.3 ± 6.5	99.7 ± 10.6	41.1 ± 4.9	0.97 ± 0.06	18.4 ± 9.3
	U18F	0.9 ± 4.6	103.9 ± 9.5	44 ± 4.3	0.88 ± 0.11	24 ± 13.2
	Total	0.7 ± 6.0	109.1 ± 13.8	42.4 ± 4.5	0.94 ± 0.08	16.5 ± 12.7
Total	U16M	0.7 ± 6.4	112.6 ± 15 ^a	43 ± 4.6	0.95 ± 0.1 ^b	14.8 ± 11.7
	U18M	0.6 ± 5.2	116.7 ± 12.4 ^{ab}	42.6 ± 4.1	0.92 ± 0.06	14.1 ± 13.8
	U16F	1.5 ± 6.4	100.5 ± 10.5	41.9 ± 4.9	0.96 ± 0.06 ^b	19.1 ± 10.4
	U18F	1.0 ± 4.5	105.8 ± 10.4	44.7 ± 4.4	0.88 ± 0.11	22 ± 12.8
	Total	0.9 ± 5.8	110. ± 14.1	42.9 ± 4.6	0.93 ± 0.09	16.7 ± 12.5

Legend: M—mean, SD—standard deviation; a—difference when compared to U16F, b—difference when compared to U18F, †—difference when compared to unsuccessful shots in total.

3.3. Differences between 2-pt and 3-pt Shooting

Differences between 2-pt and 3-pt shooting are presented in Table 3. The efficiency of 2-pt and 3-pt shooting of individual categories is depicted in Figure 3. Significant differences and large effect size between 2-pt and 3-pt shooting in U16M were in the variables of CoMDZ ($p < 0.001$; $d = 0.83$), EA ($p < 0.001$; $d = -1.35$), and PSS ($p < 0.001$; $d = -119$). There were no differences found in SA in all categories ($p > 0.05$). In the U18M category, there was difference between

2-pt and 3-pt shooting in the variables CoMDZ, EA, PSS ($p < 0.001$; $d = 0.63, -2.23, -1.01$). In the U16F category, the difference between 2-pt and 3-pt shooting was not significant in the variables CoMDZ and SA ($p > 0.05$). There was difference in the variables EA and PSS ($p < 0.001$). In the U18F category, the difference between 2-pt and 3-pt shooting was significant only in the EA variable ($p < 0.001$; $d = -2.57$). In the other variables (CoMDZ, SA, PSS), the difference was not significant ($p > 0.05$).

Table 3. Differences in kinematic variables between 2-pt and 3-pt shooting in individual categories.

Category	CoMDZ (cm)		SA (°)		EA (°)		PSS (s)	
	<i>p</i>	<i>d</i>	<i>p</i>	<i>d</i>	<i>p</i>	<i>d</i>	<i>p</i>	<i>d</i>
U16M	< 0.001	0.83	0.570	-0.09	< 0.001	-1.35	< 0.001	-1.19
U18M	< 0.001	0.63	0.107	-0.26	< 0.001	-2.23	< 0.001	-1.01
U16F	0.913	-0.02	0.111	0.31	< 0.001	-2.04	< 0.001	-1.32
U18F	0.755	0.08	0.956	-0.01	< 0.001	-2.57	0.248	-0.27

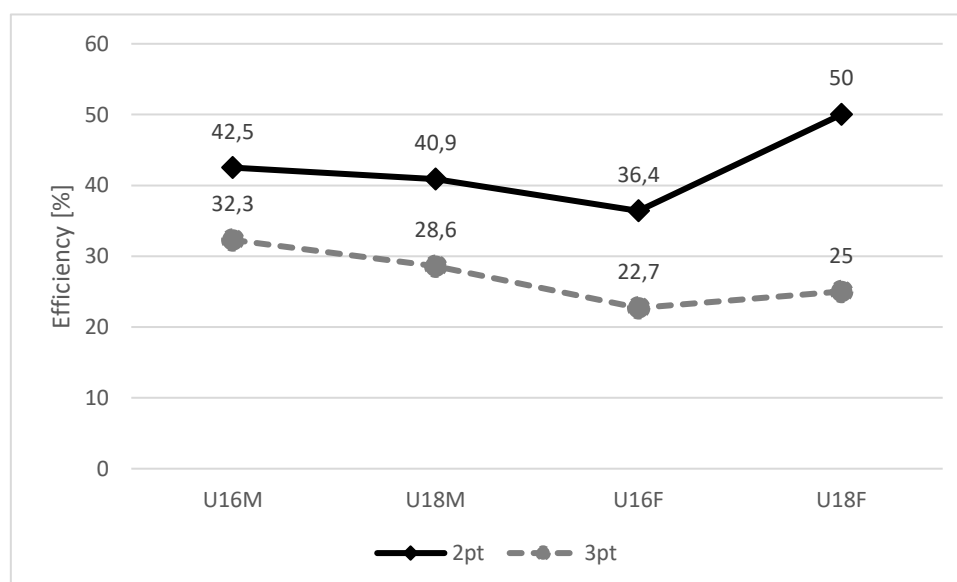

Figure 3. Efficiency of 2-pt and 3-pt shooting in individual categories.

4. Discussion

The main finding of the study is that female and male basketball players use different shooting techniques. We found out differences in 2-pt shooting in variable CoMDZ, SA, and EA between male and female categories. In the 3-pt shooting, we found out differences between male and female categories in variable SA and based on the effect size in variable CoMDX. Player shooting speed was higher in all categories (except U18F) when shooting for 3-pt. Therefore, our hypothesis that differences in selected kinematic variables will be observed between 2-point and 3-point shots regarding different categories and success of the shots can be partially

accepted having in mind that we did not find differences between successful and unsuccessful shots.

4.1. Differences in Categories in 2-pt Shooting

We did not find differences between successful and unsuccessful 2-pt shots in CoMDZ, SA, EA, and PSS based on statistical analyses. These findings correspond to the results of Uygur et al. [20] who also did not find differences in selected kinematic parameters (elbow, trunk, knee, and ankle joint angles) for free throw shooting between successful and unsuccessful attempts. In the CoMDZ variable, differences were identified between the individual categories (U16M vs. U16F, U16M vs. U18F, U18M vs. U16F, U18M vs. U18F). In male basketball players, in both categories, the difference between the center of mass displacement when catching the ball and the lowest point of the center of mass was greater than that of female players. The reason could be that male players release the ball during a jump shot from a greater height, and therefore a greater power impulse must be given to the lower limbs than it is for the female players [21]. On the other hand, the ball release height also affects the angle at which the ball is released [22]. A larger SA at the time of ball release was found in the male categories. The differences were between U16M vs. U16F, U18M vs. U16F, U18M vs. U18F. The lower SA in female players may be caused by the maximum flexed position adopted during the preparatory phase, which is also related to the lower entry angle of the ball [23]. In the male categories, SAs are presented lower than in the studies of Okazaki and Rodacki [8], Okazaki and Rodacki [24], Rojas et al. [10], namely 118.6° , 119.06° , 136.95° , respectively. In the above research, it was a set shot, except for Rojas et al. [10], where the shooting was carried out after a pass. The differences may have been due to higher age and greater experience of the players, as the mentioned studies involved adult players at the age of about 25 (except for Khlifa et al. [25]). This statement was also confirmed by Button et al. [26] and found greater consistency in kinematic patterns of free throws for players who had more experience in competitive games. Okazaki and Rodacki [24] report SA in 12-year-old children 102.54° , which confirms our assumptions. Female players shot with a lower SA as stated by Elliott and White [23], 113.8° , but we again attribute the difference to age and experience, as they were professional players. SA may also depend on the presence of a defender, as confirmed by Rojas et al. [10], and players in the presence of a defender shot with a larger SA than without the defender. In the variable EA, differences were recorded between category U16M and categories U18M, U16F, and U18F. Male players shot with more EA than female players. However, these EA values are lower compared to Rupčić et al. [14], where EA was 42.28° in male players U16.

The difference may also be that in the mentioned research, players shot from distances of 6 m and 6.75 m, and the given value is the average of shots from both distances. Nevertheless, the average angles of the U18M, U16F, and U18F categories appear to be too small, so it is possible that players in these categories had to shoot with more rotation of the ball to increase the chance of a successful shot. The entry angle of the ball entering the basket is considered one of the main criteria for a successful shot. As the EA of the ball increases, the width of the basket increases [27,8]. Therefore, the smaller EA is probably related to the smaller SA, which was observed in all categories. Based on the results, the lower EA is characteristic of young players, where the parabola of the trajectory of the shot ball is lower. We assume that reducing the rim diameter can be a good tool for young players, where players would have to shoot with a larger SA, and thus their EA would also increase. For example, in a study by Khlifa et al. [25], a reduction rim diameter of 0.35 m (regular rim diameter is 0.45 m) was used, where the minimum EA for the direct shot was 44.48°.

No differences between categories were found in the PSS. Male and female players shot at about the same time from catching the ball to the release phase of the ball. PSS corresponds to the results of studies by Gorman and Maloney [28], van Maarseveen [29] and Oudejans [12]), Rojas et al. [10], and Rupčić et al. [14], where the PSS was ~ 0.82 s, 0.896 s, 0.86 s, and 0.82 s, respectively. Okazaki and Rodacki [8], Okazaki and Rodacki [24], and Podmenik et al. [30] reported slightly lower PSS: 0.74 s, 0.77 s, and 0.73 s, respectively. Shots in the research, Okazaki and Rodacki [8,24] and Podmenik et al. [30] were not performed after the previous pass, which could have caused the difference just mentioned. As a result, players need more time to catch and shoot the ball than when they are already holding the ball in their hands.

From a practical point of view, PSS is significant because the shorter the time interval from catching the ball after passing to the moment the ball is released towards the basket, the more difficult it is for the defender to block a jump shot [31,10]. The PSS will also be affected by using the ground reaction force. If players cut and get into a catch and shoot situation, they need to transform the horizontal movement into a vertical one by using the ground reaction force in best possible way. Krause et al. [32] recommend that if a player wants to make a jump shot as quickly as possible, he should get into a low center of mass position with slightly bent lower extremities before receiving the ball.

4.2. Differences in Categories in 3-pt Shooting

There were no differences between the successful and unsuccessful 3-pt shots in the variables CoMDZ, SA, PSS, CoMDX. Differences between successful and unsuccessful attempts were

recorded in the EA parameter. The EA of the ball was on average 1.6° greater in successful attempts than in unsuccessful ones (44° vs. 42.4°). In both cases, however, EA can be considered sufficient, with unsuccessful shots having a lower release velocity of the ball, which is associated with higher shooting successfulness [33,22].

When comparing the differences in CoMDZ, there were no differences noted between the individual categories. It could be because young male and female players release the ball at a lower vertical point when shooting for 3-pt than for 2-pt. In SA, differences were observed between the categories U16M vs. U16F, U18M vs. U16F, and U18M vs. U18F. The difference in SA between the categories may have been due to a greater flexion in the elbow joint in female players, a forward movement of the dominant foot, and a greater horizontal shift in the center of mass [34,23]. The SA is similar in the male categories compared to Okazaki and Rodacki [8] and [7], where the SA was 117.5° and 123.3° , respectively. In these studies, however, players shot from a distance of 6.4 m. No differences were found between the individual categories in the variable EA. All players shot with about the same EA. The lowest EA was achieved in the U16F category. A similar EA is reported by Dobovičnik et al. [35], where it reached an average value of 41.58° for male players U18, which is in line with our findings. PSS was different in each category. Differences were recorded between the categories U16M vs. U18F and U16F vs. U18F. The U18F players achieved the fastest shooting. The PSS is larger than reported by Dobovičnik et al. [32], Okazaki and Rodacki [8], Podmenik et al. [30], and Gorman and Maloney [25]: 0.79 s, 0.67 s, 0.64 s and ~ 0.81 s, respectively. In the studies of Okazaki and Rodacki (2012), and Podmenik et al. [27], players performed a jump shot while already holding the ball in their hands. In the study of Dobovičnik et al. [32] and Gorman and Maloney [28], players stood in place waiting for a pass, after which they immediately made a jump shot. In our case, the players had to make a curl cut for the ball and only then received a pass, after which they could shoot. It reflects that player need more time to coordinate their movement after the previous cut and subsequent pass. It is a more demanding motor task, which is greatly influenced by the previous activity (curl cut).

No difference was found between the categories in CoMDX, but the effect size indicated a large effect. However, when we look at the results, the female players shot with a larger displacement of CoM in the horizontal direction than the male players. The reason may be less power in lower and upper extremities. The consequence is then the forward movement of the dominant foot when stopping, and thus a larger displacement of the CoM in the horizontal direction occurs, which corresponds to Elliott [34]. Podmenik et al. [30] reported CoM displacement toward the basket with a distance of 6.75 m at the level of 30 cm. Elliott and White [23], and Okazaki and

Rodacki [8] found a slightly higher CoM horizontal displacement from a distance of 6.4 m, namely, 40.4 cm and 50.3 cm, respectively. The differences concerning the studies mentioned above could have been due to the curl cut, which players had to perform before a pass. It means that after the curl cut, players try to transform the horizontal movement into a vertical one and minimize the displacement toward the basket.

4.3. Differences between 2-pt and 3-pt Shooting

Differences between 2-pt and 3-pt shooting were in the categories U16M and U18M in the variables CoMDZ, EA, PSS. In the categories U16F and U18F, there were differences in the variables EA and PSS (only for U16F).

It can be speculated that male players do not need to use as much power in the lower limbs for a 3-pt shot as in a 2-pt shot. It means that there was less countermovement in the 3-pt shot than in the 2-pt shot, which probably also caused to reduce the jump height and earlier release of the ball than in the jump height peak [7]. These findings are consistent with Elliott [34][33], and Okazaki and Rodacki [8], who argue that premature ball release at the time before reaching the jump height peak and lower jump provides the use of some of the jump energy to optimize the ball release impulse. These statements are also characteristic of the jump shot of female players. Interestingly, SA was slightly higher for 3-pt shots for male players and lower for female players. However, the differences were insignificant. Elliott and White [23], Miller and Bartlett [7], and Okazaki and Rodacki [8] report a reduction in shoulder flexion with increasing horizontal distance. Entry angle of the ball when approaching the rim increased for all categories in 3-pt shooting compared to 2-pt shooting. The EA may result from a larger release angle along with the release height and release velocity of the ball [35][22]. As the EA increases, so does the chance of success, and thus the width of the basket [27][8]. On the other hand, Erčulj and Supej [9] point to the negative effect of increasing release angle on shooting success. With increasing release angle, the flight trajectory of the ball also lengthens, making it more challenging to achieve the required accuracy. With a higher release angle, a larger release velocity of the ball and thus a larger force impulse is required [7]. Players have to reorganize the coordination of the body segments to meet the demands of the new task [8]. As a result, there may be a more significant failure in 3-pt shooting, as evidenced by our results (Figure 3).

PSS was different between 2-pt and 3-pt shooting in the U16M, U18M, and U16F categories. Players in these categories needed more time after the pass to release the ball. We assume that the U18F players had approximately the same values in the PSS due to maturity status and their

more stable coordination of movements. Players of other categories are still in the developmental process (e.g., growth, hormones), and their coordination of movements may not be at the same level as in adults. The differences found between 2-pt and 3-pt shooting may have occurred because players needed to give more release velocity of the ball and more force impulse [7]. In accordance with Dobovičnik et al. [35], players performed excessive movements with hands before releasing the ball to optimize the force impulse. In real game conditions, any excessive movement can slow players' shooting speed, giving the defender a better chance to close out or block a shot. In this point of view, Vencurik and Nykodym [36] determine that with increased defensive pressure, the chances for a successful shot decrease. The results of this study confirm the differences in some kinematic variables with other research. In this, we agree with the statement of Okazaki et al. [22] that the performance of skills could probably influence shooting performance before shooting, such as catching a pass and making a cut.

Major limitation in the current study is the lack of confounding variables such as morphological factors. Therefore, future studies should include morphological factors due to possible influence on the results. Nevertheless, this study's novelty and uniqueness is in the documented selected kinematic variables of the jump shot after making a cut and receiving a ball. For more precise and general conclusions, more subjects and more measured shots are needed. Further research in this area should focus on assessing the kinematic and physical parameters of the jump shot in situations that are more similar to real game conditions (e.g., pull-up jump shots, catch-and-shoot situations after a cut, defended shots).

5. Conclusions

Our hypothesis could be accepted having in mind our results concerning categories and success of the shots. The current results show that female and male basketball players used different shooting techniques. Players in male categories shot with a higher center of mass difference in the vertical direction, with a higher release shoulder angle, and with a higher entry angle of the ball.

Moreover, the entry angle of the ball increases in all categories when shooting for 3-pt. It means that players need more time for 3-pt shots after receiving a pass when compared to 2-pt shots. Therefore, the players are using excessive movements to optimize the shooting technique when shooting for 3-pt. Basketball coaches and players should work to minimize the kinematic differences between 2-pt and 3-pt shooting to increase the successfulness of shooting from longer distances.

Author Contributions: Conceptualization, T.V. and T.R.; methodology, G.S.; software, D.K.; validation, D.K.; formal analysis, G.S.; investigation, T.V.; resources, D.K.; data curation, T.V.; writing—original draft preparation, T.R.; writing—review and editing, F.L. and G.S.; visualization, T.R. and F.L.; supervision, F.L. and D.K.; project administration, G.S.; funding acquisition, D.K. All authors have read and agreed to the published version of the manuscript.

Funding: This research received no external funding.

Institutional Review Board Statement: The study was conducted according to the guidelines of the Declaration of Helsinki and approved by the Ethics Committee of Faculty of Kinesiology of University of Zagreb (ethical code 113/2016, approval date 20 December 2016).

Informed Consent Statement: Informed consent was obtained from all subjects involved in the study.

Data Availability Statement: The data presented in this study are available on request from the corresponding author. The data are not publicly available due to its huge size and participants' privacy protection.

Conflicts of Interest: The authors declare no conflict of interest.

References

1. GÓMEZ, M.Á., LORENZO, A., SAMPAIO, J., IBÁÑEZ, S.J., ORTEGA, E. 2008. Game-related statistics that discriminated winning and losing teams from the spanish men's professional basketball teams. *Coll. Antropol.*, 32, 451–456.
2. IBÁÑEZ, S.J., GARCÍA, J., FEU, S., LORENZO, A., SAMPAIO, J. 2009. Effects of consecutive basketball games on the game-related statistics that discriminate winner and losing teams. *J. Sports Sci. Med.*, 8, 458–462.
3. LORENZO, A., GÓMEZ, M.Á., ORTEGA, E., IBÁÑEZ, S.J., SAMPAIO, J. 2010. Game related statistics which discriminate between winning and losing under-16 male basketball games. *J. Sports Sci. Med.*, 9, 664–668.
4. OUDEJANS, R.R.D., KARAMAT, R.S., STOLK, M.H. 2012. Effects of actions preceding the jump shot on gaze behavior and shooting performance in elite female basketball players. *Int. J. Sports Sci. Coach.*, 7, 255–268.
5. Teams Shooting. Available online: <http://stats.nba.com/teams/shooting/> (accessed on 18 October 2017).

6. IBÁÑEZ, S.J., SAMPAIO, J., FEU, S., LORENZO, A., GÓMEZ, M.A., ORTEGA, E. 2008. Basketball game-related statistics that discriminate between teams' season-long success. *Eur. J. Sport Sci*, 8, 369–372.
7. MILLER, S., BARTLETT, R. 1996. The relationship between basketball shooting kinematics, distance and playing position. *J. Sports Sci*, 14, 243–253.
8. OKAZAKI, V.H.A., RODACKI, A.L.F. 2012. Increased distance of shooting on basketball jump shot. *J. Sports Sci. Med*, 11, 231–237.
9. ERČULJ, F., SUPEJ, M. 2009. Impact of fatigue on the position of the release arm and shoulder girdle over a longer shooting distance for an elite basketball player. *J. Strength Cond. Res*, 23, 1029–1036.
10. ROJAS, F.J., CEPERO, M., ONA, A., GUTIERREZ, M. 2000. Kinematic adjustments in the basketball jump shot against an opponent. *Ergonomics*, 43, 1651–1660.
11. DE OLIVEIRA, R.F., HUYS, R., OUDEJANS, R.R.D., VAN DE LANGENBERG, R., BEEK, P.J. 2007. Basketball jump shooting is controlled online by vision. *Exp. Psychol*, 54, 180–186.
12. OUDEJANS, R.R.D. 2012. Effects of visual control training on the shooting performance of elite female basketball players. *Int. J. Sports Sci. Coach*, 7, 469–480.
13. ABDELRASOUL, E., MAHMOUD, I., STERGIOU, P., KATZ, L. 2015. The accuracy of a real time sensor in an instrumented basketball. *Procedia Eng*, 112, 202–206.
14. RUPCIC, T., ANTEKOLOVIC, L., KNJAZ, D., MATKOVIC, B., CIGROVSKI, V. 2016. Reliability analysis of the 94 fifty smart sensor basketball. In *Proceedings of the 10th International Conference on Kinanthropology: Sport and Quality of Life*; Zvonar, M., Sajdlova, Z., Eds.; Masarykova University: Brno, Czech Republic; pp. 432–438; ISBN 978-80-210-8129-1.
15. HOPKINS, W.G., MARSHALL, S.W., BATTERHAM, A.M., HANIN, J. 2009. Progressive statistics for studies in sports medicine and exercise science: *Med. Sci. Sports Exerc.*, 41, 3–13.
16. VINCENT, W.J., WEIR, J.P. 2012. *Statistics in Kinesiology*, 4th ed.; Human Kinetics: Champaign, IL, USA; ISBN 978-1-4504-0254-5.
17. LAKENS, D. 2013. Calculating and reporting effect sizes to facilitate cumulative science: a practical primer for t-tests and ANOVAs. *Front. Psychol.*, 4, doi:10.3389/fpsyg.2013.00863.
18. RICHARDSON, J.T.E. 2011. Eta squared and partial eta squared as measures of effect size in educational research. *Educ. Res. Rev*, 6, 135–147.

19. COHEN, J. 1988. *Statistical Power Analysis for the Behavioral Sciences*, 2nd ed.; Routledge Academic: New York, NY, USA.
20. UYGUR, M., GOKTEPE, A., AK, E., KARABORK, H., KORKUSUZ, F. 2010. The effect of fatigue on the kinematics of free throw shooting in basketball. *J. Hum. Kinet*, 24, 51–56.
21. TURNER, A.N., JEFFREYS, I. 2010. The stretch-shortening cycle: proposed mechanisms and methods for enhancement. *Strength Cond. J*, 32, 87.
22. OKAZAKI, V.H.A., RODACKI, A.L.F., SATERN, M.N. 2015. A review on the basketball jump shot. *Sports Biomech*, 14, 190–205.
23. ELLIOTT, B., WHITE, E.J.T.A.J.O.S., SPORT, M.I. 1989. A kinematic and kinetic analysis of the female two point and three point jump shots in basketball, 21, 7-11.
24. OKAZAKI, V.H.A., RODACKI, A.L.F. 2018. Basketball jump shot performed by adults and children. *Hum. Mov*, 19, 71–79.
25. KHLIFA, R., AOUADI, R., HERMASSI, S., CHELLY, M.S., JLID, C., GABBETT, T.J. 2012. Kinematic adjustments in the basketball free throw performed with a reduced hoop diameter rim. *Int. J. Sports Sci. Coach*, 7, 371–382.
26. BUTTON, C., MACLEOD, M., SANDERS, R., COLEMAN, S. 2003. Examining movement variability in the basketball free-throw action at different skill levels. *Res. Q. Exerc. Sport*, 74, 257–269.
27. MILLER, S., BARTLETT, R.M. 1993. The effects of increased shooting distance in the basketball jump shot. *J. Sports Sci*, 11, 285–293.
28. GORMAN, A.D.; MALONEY, M.A. 2016. Representative design: Does the addition of a defender change the execution of a basketball shot? *Psychol. Sport Exerc*, 27, 112–119.
29. VAN MAARSEVEEN, M.J.J., OUDEJANS, R.R.D. 2018. Motor and gaze behaviors of youth basketball players taking contested and uncontested jump shots. *Front. Psychol*, 9, doi:10.3389/fpsyg.2018.00706.
30. PODMENIK, N., SUPEJ, M., KUGOVNIK, O., ERČULJ, F. 2015. Movement of the body's centre of mass during a jump shot related to the distance from the basket of young players. *Kinesiol. Slov*, 21, 21–33.
31. FONTANELLA, J.J. 2006. *The physics of basketball*; Johns Hopkins University Press: Baltimore, MD, USA; ISBN 978-0-8018-8513-6.
32. KRAUSE, J., MEYER, D., MEYER, J. 2008. *Basketball Skills & Drills*, 3rd ed.; Human Kinetics: Champaign, IL, USA; ISBN 978-0-7360-6707-2.
33. KNUDSON, D. 1993. Biomechanics of the basketball jump shot—six key teaching points. *J. Phys. Educ. Recreat. Dance*, 64, 67–73.

34. ELLIOTT, B. 1992. A kinematic comparison of the male and female two-point and three-point jump shots in basketball. *Aust. J. Sci. Med. Sport*, 24, 111–118.
35. DOBOVIČNIK, L., JAKOVLJEVIĆ, S., ZOVKO, V., ERČULJ, F. 2015. Determination of the optimal certain kinematic parameters in basketball three-point shooting using the 94ifty technology. *Phys. Cult. Fiz. Kult*, 69, 5–13.
36. VENCURIK, T., NYKODYM, J. 2017. Selected factors influencing the successfulness of shooting in women's basketball. In *Proceedings of the 8th International Scientific Conference on Kinesiology*, Dragan, M., Sporiš, G., Šalaj, S., Škegro, D., Eds.; University of Zagreb, Faculty of Kinesiology: Opatija, Croatia; pp. 428–431.

Study 5: The Effect of Fatigue on Kinematics and Kinetics in Basketball Dribbling with Changes of Direction

Li, F., Rupčić, T., and Knjaz, D. (2021). The Effect of Fatigue on Kinematics and Kinetics in Basketball Dribbling with Changes of Direction. *Kinesiology*, 53(2), 296-308. doi: 10.26582/k.53.2.12

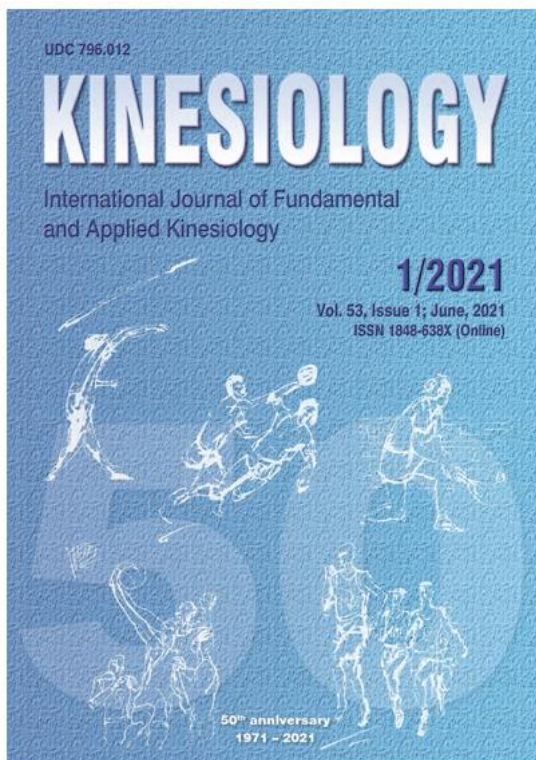

Kinesiology

doi: 10.26582/k.53.2.12

Manuscript submitted for publication: 13 May 2021

Manuscript accepted for publication: 9 December 2021

Journal impact factor: 1.452

Indexed/Abstracted in: MEDLINE and Web of Science (WoS).

ISSN: 1331-1441 (Print); ISSN: 1848-638X (Online)

THE EFFECT OF FATIGUE ON KINEMATICS AND KINETICS OF BASKETBALL DRIBBLING WITH CHANGES OF DIRECTION

Feng Li, Tomislav Rupčić, and Damir Knjaz

University of Zagreb, Faculty of Kinesiology, Laboratory for Sports Games, Croatia

Original scientific paper

DOI 10.26582/k.53.2.12

Abstract:

Basketball dribbling is one of the key elements in basketball game. There is a lack of studies investigating the effect of fatigue on kinematics and kinetics in basketball dribbling. There are two primary aims of this study: (1) to explore the effect of fatigue on kinematics and kinetics in dribbling with the change of directions; (2) to determine the effect of fatigue on dribbling speed. Fourteen Croatian senior male basketball players, not power forwards or centers (age: 21.16 ± 3.43 years; body height: 188.81 ± 6.88 cm; body mass: 87.81 ± 6.06 kg; body fat: $13.34 \pm 3.52\%$) participated in the study. Each player performed two types of change of direction (COD) while dribbling: front COD and spin move in the non-fatigued and then in the fatigued state. Xsens suit and Novel insoles were used to measure the kinematic and kinetic parameters. In terms of the front COD, the results of this study demonstrated that the maximum angular velocity in the knee ($p=.028$) and wrist joint ($p=.007$) as well as maximum force ($p=.004$) significantly decreased in the fatigued state. In terms of the spin move, the results showed that there were significant differences in pelvis velocity ($p=.000$), the maximum angular velocity in the knee joint ($p=.020$), and the first step velocity ($p=0.010$) between the fatigued and non-fatigued states. No significant difference was found in the pelvis position, minimum angle in the knee joint and maximum force. Importantly, dribbling speed significantly decreased in the fatigued state ($p=.002$). The findings of this study suggest that coaching staff should design appropriate training programs to optimize players' ability to resist fatigue when dribbling under real game speed conditions.

Key words: *dribble, change of direction, spin move, velocity, angular velocity, joint angle*

1. Introduction

During the competition, there are three essential action options for the next movement when a player holds the ball—he/she may dribble, pass, or take a shot (Arias-Estero, 2013). In set offense, a player with a proficient dribbling technique is able to break the opponent's intensive defense (e.g., using a crossover, penetration, and spin move), which creates free space to pass the ball to his/her teammates thus creating an open shot opportunity for them (Arias, Argudo, & Alonso, 2012; Arias-Estero, 2013), or to penetrate to the restricted area (paint). Additionally, it has been previously observed that fast break (Christmann, Akamphuber, Müllenbach, & Güllich, 2018; Conte, Favero, Niederhausen, Capranica, & Tessitore, 2017; Evangelos, Alexandros, & Nikolaos, 2005; Matulaitis & Bietkis, 2021) and transition to offense (Matulaitis & Bietkis, 2021; Milanović, Selmanović, & Škegro, 2014) are the most scoring efficient modes of attacking, both of which require high-speed dribbling to provide a temporal-spatial advantage over the defender while driving to the basket (Conte, et al., 2017). Moreover, Conte, Favero, Niederhausen, Capranica, and Tessitore (2016) have pointed out that the proper technique of passing and dribbling reduces the number of turnovers and induces more assists (Arias, et al., 2012). Therefore, it can be said that the effective dribbling technique plays an important role in determining the outcome of a match. When it comes to dribbling in basketball, one can recognize dribbling in place, dribbling in a straight line, dribbling with a change-of-pace, and dribbling with a change of direction (COD) (Krause & Nelson, 2018). Furthermore, it has been stated that dribbling with COD is the most frequently used way of dribbling during the competition (Cortis, et al., 2011; Fujii, Yamada, & Oda, 2010).

Given the importance of dribbling technique, various aspects have been investigated so far (Dos Santos, Pacheco, Basso, Bastos, & Tani, 2020; Guimarães, et al., 2019; Robalo, Diniz, Fernandes, & Passos, 2021). A number of studies investigated the frequency and efficiency of dribbling in basketball games and have reported that dribbling skills are constantly used during basketball games with elite players dribbling during ~10% of the live time (Andrić, 2011; Scanlan, Dascombe, & Reaburn, 2011; Scanlan, Dascombe, Kidcaff, Peucker, & Dalbo, 2015). In addition, some other aspects of dribbling skills have been investigated such as skill improvement (Dos Santos, et al., 2020; Fujii, et al., 2010), technique evaluation (Conte, et al., 2020; Jakovljević, Karalejić, Ivanović, Štrumbelj, & Erčulj, 2017; Robalo, et al., 2021), and the effect of supplementation on dribbling performance (Scanlan, et al., 2019). Surprisingly, literature revealed few studies detecting the influence of fatigue on basketball dribbling performance.

Basketball is an intermittent high-intensity team sport characterized by short sprints, abrupt jumps, shufflings, and CODs, which can lead to acute and accumulated chronic fatigue (Erčulj, Blas, & Bračić, 2010; Mancha-Triguero, García-Rubio, Calleja-González, & Ibáñez, 2019; Li, Knjaz, & Rupčić, 2021; Mancha-Triguero, García-Rubio, Gamonales, & Ibáñez, 2021). It is well understood that fatigue has a negative influence on players' performance (Calleja-González, et al., 2016; Erculj & Supej, 2009; Mulazimoglu, Yanar, Tunca Evcil, & Duvan, 2017; Thorpe, Atkinson, Drust, & Gregson, 2017). Several studies observed the effect of different physiological loads on shooting performance, reporting that shooting accuracy significantly decreased (Erculj & Supej, 2009; Rupčić, et al., 2020). Similarly, the passing performance has been investigated by several studies, showing that passing accuracy decreased when players were in the fatigued state (Li, et al., 2021; Lyons, Al-Nakeeb, & Nevill, 2006). Consequently, it is specifically important that players maintain a high level of skill performance under the influence of fatigue in order to win a game (Conte, et al., 2017).

With the development of technology, many researchers have used motion capture systems to objectively analyze basketball players' skill execution (Erculj & Supej, 2009; Nakano, Fukashiro, & Yoshioka, 2020; Okazaki & Rodacki, 2012; Okubo & Hubbard, 2015; Uygur, Goktepe, Ak, Karabörk, & Korkusuz, 2010). In the past, researchers have shown an increased interest in the influence of fatigue on kinematics of basketball skills (Erculj & Supej, 2009; Uygur, et al., 2010). Erculj and Supej (2009) observed the influence of fatigue on kinematics of shooting. Their findings revealed that the position of the release arm and shoulder significantly changed when players were shooting under the moderate- and high-intensity fatigue conditions (Erculj & Supej, 2009). Uygur et al. (2010) found that fatigue did not affect selected kinematic variables of the free throw. To the best of the author's knowledge, however, no previous study has investigated the influence of fatigue on kinematics of basketball dribbling. Therefore, there were two primary aims of this study: (1) to determine the effect of fatigue on kinematics and kinetics of dribbling with COD and (2) to observe the effect of fatigue on speed of dribbling with COD. It was hypothesized that differences in kinematic and kinetic parameters as well as in dribbling speed would be observed between dribbling of both types performed in the non-fatigued and fatigued state.

2. Methods

2.1 Participants

Fourteen Croatian senior basketball players (age: 21.16 ± 3.43 years; height: 188.81 ± 6.88 cm; body mass: 87.81 ± 6.06 kg; body fat: 13.34 ± 3.52 %; experience years: 9.42 ± 4.14) belonging to

three professional basketball clubs were recruited for this study. Inclusion criteria were regular participation in practice sessions and competitions, and the absence of injury in the past 6 months. Additionally, the inclusion criteria were point guards (n=5), shooting guards (n=4), and small forwards (n=5) since basketball is a game in which players have roles specific to position-of-play and outside players should have a higher level of fitness related to dribbling (Sekulic et al., 2017). Exclusion criteria were power forward and center players. Players refrained from heavy training for at least one day preceding testing sessions. Prior to the testing, participants were fully informed of the study protocol and provided a written informed consent. The obtained data were treated with the greatest confidentiality and scientific rigor, their use restricted by the guidelines for research projects following the scientific method required in each case, complying with the Organic Law 15/1999 of the 13th of December on the Protection of Personal Data (OLPPD); the proceedings used respected the ethic criteria of the Responsible Committee of Human Experimentation and the Helsinki Statement of 2008, updated in Fortaleza, October 2013 (2013 version). All testing procedures were approved by the Ethics Committee of the Faculty of Kinesiology, University of Zagreb (ethical approval number:108/2020), according to the ethical standards of the Declaration of Helsinki.

2.2 Experimental procedures

2.2.1 Instruments

In order to monitor the players' fatigue level, blood lactate concentration was conducted four times by a portable lactate analyzer (Lactate Scout 3, manufacturer: SensLab GmbH, Leipzig, Germany): before warm-up, after warm-up, after the first testing, and after the fatigue protocol, respectively. Additionally, the heart rate was evaluated throughout the testing by the heart rate monitor (Polar H10, manufacturer: Polar, Kempele, Finland). The reliability and validity of Lactate Scout 3 and Polar H10 were previously confirmed (Tanner et al., 2010, Belić et al., 2016, Speer et al., 2020, Hinde et al., 2021).

Kinematic parameters were measured using the Xsens MVN inertial system (Xsens Technologies B.V., Enschede, The Netherlands). The players wore a full-body suit equipped with 17 wireless motion trackers (sampling frequency of 60 Hz) to ensure a full 3D motion analysis. The kinematic parameters were derived from the corresponding MVN Studio BIOMECH software (Xsens Technologies B.V., Enschede, The Netherlands). A previous study has verified the reliability and validity of Xsens kinematic suit for the kinematic analysis of basketball skills (Robert-Lachaine, Mecheri, Larue, & Plamondon, 2017). In addition, it was used in previous studies for measuring similar data on the basketball court (Li, et al., 2021; Slawinski, et al., 2018).

For kinetic analysis pressure insoles were inserted in the participants' shoes for pressure detection with the sampling rate of 100Hz (Novel Pedar model W, Germany). Insoles are thin and light (2mm), having minimal influence on players' performance during testing, which is particularly important during a very dynamic COD in dribbling. Data were derived from the corresponding Novel software (Loadsol analysis 25.3.6). Previous studies have confirmed the reliability and validity of the Novel pressure insoles for analyzing foot pressure in sports (Sorrentino, et al., 2020; Stricker, Scheiber, Lindenhofer, & Müller, 2010). The standard calibration of pressure insoles was performed according to the manufacturers' instructions (Novel GmbH, Munich).

Players were asked to dribble and change direction as fast as possible. Their time was recorded by photocells (WittyGate, Microgate, Bolzano, Italy). The reliability and validity of photocells were proved and used by previous studies (Balsalobre-Fernández, et al., 2019; Doyle, Browne, & Horan, 2020).

2.2.2 Protocol

This study used a repeated measurements study design—measurements of kinetic and kinematic parameters of CODs in dribbling were conducted first in the non-fatigued and then in the fatigued state. All the fourteen players underwent the same protocol: they had one day of rest before the testing that consisted of the following: warm-up, a non-fatigued dribbling test, a fatigue protocol, and a fatigued dribbling test.

Prior to the testing procedure, basic anthropometric measurement was executed and data were used for the systems calibration, performed according to the instruction of the manufacturer (Xsens Technologies B.V., Netherlands). In order to ensure that all the participants were familiarized with the testing protocol, the warm-up consisted of five minutes of jogging, five minutes of dynamic stretching, and five minutes of low intensity dribbling consistent with the testing protocol. Afterwards, the calibration was conducted according to the manufacturers' instructions and the players were asked to stand in N-pose. After the calibration and synchronization, the players were asked to abduct their arms (up to first approx. 90° and then 180°) to ensure that the system was correctly calibrated, followed by the dribbling testing. In order to synchronize both the kinetic and kinematic systems, the players were asked to lift either left or right leg three times off the ground just before starting dribbling. That was the signal for the alignment of time-lapse of both systems.

The dribbling testing protocol is presented in Figure 1. The players dribbled the ball with their right hand from the start line until the finish line in full speed. They changed movement directions when they approached the cones (from cone 1 to cone 8). The skill of the front COD

in dribbling was performed at cones 1, 2, 5, and 6, and the spin move was performed at cones 3, 4, 7, and 8. Distance between the middle of the start line and the court baseline was 2.10 meters and distance between each two cones, where the players changed direction, was 6.10 meters. The photocells were placed at the start and finish line for measuring dribbling speed.

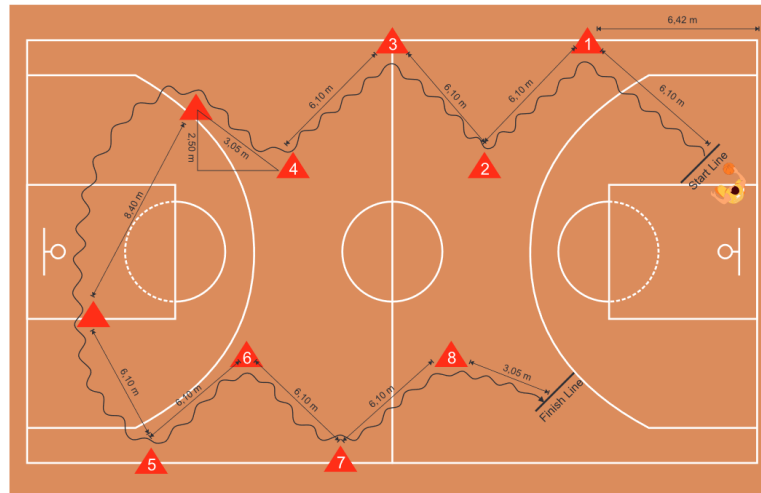

Figure 1 The illustration of the dribbling protocol

After the first dribbling test (non-fatigued state), the players were asked to perform the fatigue protocol: a 300-meter shuttle run (15×20 m with COD of 180°). This fatigue protocol was employed due to having similarities with actual game situations in which a player runs forward and backward consecutively and its reliability has been previously verified (Callister, et al., 2010; Sporiš, et al., 2014). During the 300-meter shuttle run, the players were instructed to sprint as fast as possible and the sprint time was recorded by photocells (WittyGate, Microgate, Bolzano, Italy). Afterwards, the players performed the dribbling task once again so that we can observe the difference in dribbling kinematic and kinetic COD performance between the non-fatigued and fatigued states.

2.3 Variables

Analysis of kinematic and kinetic variables was conducted on two elements of dribbling: front change and spin move. These two types of COD have been previously identified as the basic dribbling techniques (Krause & Nelson, 2018). The following variables were measured:

The dribbling time the players spent on completing the testing protocol (in seconds).

For the front COD: the minimum pelvis position (PP_{\min}) (cm), the maximum pelvis position (PP_{\max}) (cm), and the average pelvis position (PP_{aver}) (cm) at the moment when the players performed the front COD; the minimum angle in the knee joint of the outside leg (KA_{\min}) ($^\circ$); the maximum angular velocity in the knee joint of the outside leg during the concentric phase ($Knee_AV_{\max}$) ($^\circ/s$); the maximum angular velocity in the wrist joint ($Wrist_AV_{\max}$) ($^\circ/s$) from

the point that the players flexed their outside hand to switch the ball to their inside hand; the first step velocity (FSV) (cm) at the moment the player started to move to the reverse direction (COD has been performed); the maximum force of the outside foot during the concentric phase (Force_{max}) (N). Figure 2 demonstrated the movement pattern of the front COD.

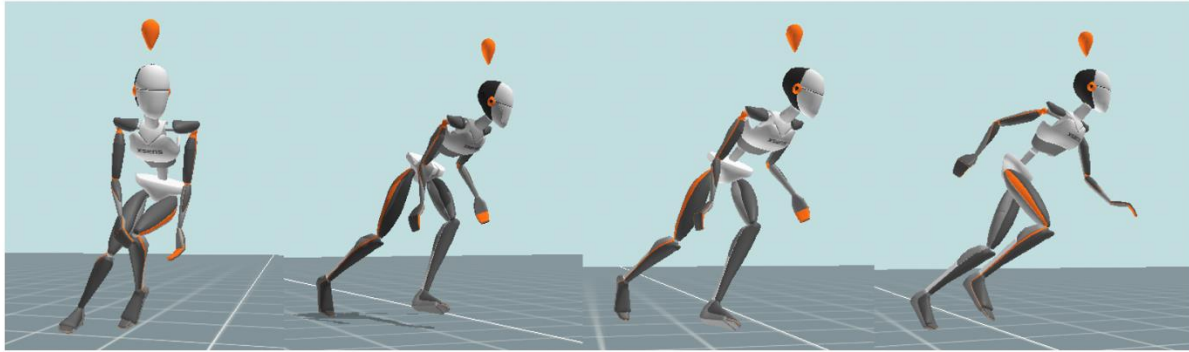

Figure 2 The movement pattern of the front change of direction

For spin move: the minimum pelvis position (PP_{min}) (cm), the maximum pelvis position (PP_{max}) (cm), and the average pelvis position (PP_{aver}) (cm) at the moment when the players performed spin move; the maximum velocity of the pelvis at the moment when the players performed spin move by rotating their pelvis (PV_{max}) (m/s); the minimum angle in the knee joint of the inside leg (KA_{min}) (°); the maximum angular velocity in the knee joint of the inside leg during the concentric phase (Knee_AV_{max}) (°/s); the velocity of the first step (FSV) (m/s); the maximum force of the inside foot during the concentric phase (Force_{max}) (N). Figure 3 demonstrated the movement pattern of the spin move.

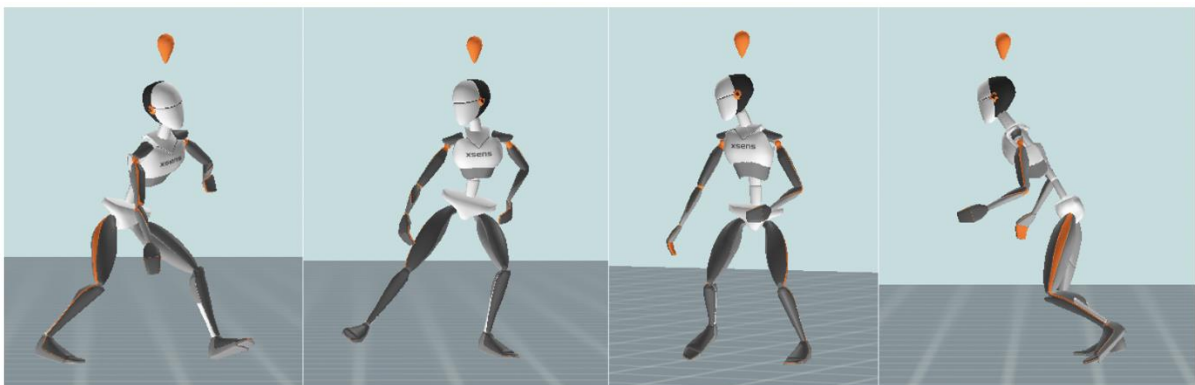

Figure 3 The movement pattern of the spin move

2.4 Statistical analysis

With the use of the G*power program, the sample size (the number) of dribbles needed for inferential statistical analysis was calculated (n = 98) at statistical significance of p<.05; statistical power 0.8; effect size 0.3, and two groups. Kinematic and kinetic parameters of dribbling were measured in every COD performance during a dribbling execution (giving a

total of 224 CODs performed, 56 of each type in each state of fatigue). Unfortunately, six of each type in each state of fatigue (24 CODs) were excluded from the final analysis due to some technical issues with the equipment or movement pattern execution. Overall, a total of 200 properly executed and measured CODs (50 of each type in each state of fatigue) was analyzed in this study.

All analyses were executed in the statistical package Statistica, version 13.5.0.17 (TIBCO Software Inc, Palo Alto, CA, USA; release date: November 2018). Values were expressed as mean \pm standard deviation. Basic descriptive parameters were calculated for all the measured variables. The normality of the data distribution was confirmed by a Shapiro-Wilk test. To verify the differences in the kinematic variables between the fatigued and non-fatigued states, an analysis of variance (ANOVA) for repeated measurements was applied. To determine the difference in dribbling speed between the non-fatigued and fatigued states, a t-test for dependent samples was conducted and the effect size was determined using the Cohen's d. The level of statistical significance was set at $\alpha=.05$.

3. Results

3.1 Front COD

Table 1 shows that there was a significant difference between the fatigued and non-fatigued state ($p=0.000$).

Table 1. The results of ANOVA for repeated measurements (for groups).

Test	Value	F	p
Wilks	0.75	3.87	0.000*

*Marked values were significant when $p < 0.05$.

Table 2 and Figure 4 provide the descriptive parameters and results of ANOVA for repeated measurements of the fatigued and non-fatigued states. First, the mean value of KNEE_AV_{max} significantly decreased in fatigued compared to non-fatigued state (fatigued=378.63; non-fatigued=429.72; $p=0.028$). Additionally, the mean value of WRIST_AV_{max} considerably decreased in fatigued compared to non-fatigued state (fatigued=300.85; non-fatigued=387.56; $p=0.007$). Furthermore, the mean value of Force_{max} dramatically decreased in fatigued compared to non-fatigued state (fatigued=1608.42; non-fatigued=1782.26; $p=0.004$). Second, the mean value of FSV was lower in fatigued than non-fatigued state (fatigued=4.55; non-fatigued=4.78) but there was no significant difference between the two groups ($p=0.229$). Last, the PP_{min}, PP_{max}, and PP_{aver} all slightly increased in the fatigued state compared to the non-fatigued state. Likewise, the KA_{min} was higher in the fatigued state than the non-fatigued state

(fatigued=119.23; non-fatigued=118.70). However, there was no significant difference in terms of PP_{\min} ($p=0.700$), PP_{\max} ($p=0.804$), PP_{aver} ($p=0.589$) and KA_{\min} ($p=0.707$).

Table 2. Descriptive parameters and results of ANOVA for repeated measurements of the fatigued and non-fatigued states.

Variable	Group	N	Mean	Min	Max	SD	F	p
PP_{\min} (cm)	Non-fatigued	50	76.79	64.93	91.30	6.47	0.15	0.700
	Fatigued	50	77.31	65.56	93.80	6.92		
PP_{\max} (cm)	Non-fatigued	50	90.51	76.12	107.05	6.53	0.06	0.804
	Fatigued	50	90.85	75.03	108.93	6.96		
PP_{aver} (cm)	Non-fatigued	50	82.72	71.21	98.16	6.08	0.29	0.589
	Fatigued	50	83.42	72.25	99.98	6.86		
KA_{\min} (°)	Non-fatigued	50	118.70	103.52	132.56	7.16	0.14	0.707
	Fatigued	50	119.23	102.58	132.88	6.93		
$KNEE_AV_{\max}$ (°/s)	Non-fatigued	50	429.72	222.59	664.81	109.01	4.97	0.028*
	Fatigued	50	378.63	180.72	661.01	119.79		
$WRIST_AV_{\max}$ (°/s)	Non-fatigued	50	387.56	115.26	709.03	164.31	7.62	0.007*
	Fatigued	50	300.85	96.52	771.62	149.34		
FSV (m/s)	Non-fatigued	50	4.78	2.58	7.32	1.06	1.09	0.299
	Fatigued	50	4.55	1.26	6.21	1.14		
Force _{max} (N)	Non-fatigued	50	1782.26	1109.16	2747.52	347.06	8.89	0.004*
	Fatigued	50	1608.42	1132.95	2043.40	222.52		

Legend: * $p < 0.05$; PP_{\min} - the minimum pelvis position at the moment when the players performed the front change; PP_{\max} - the maximum pelvis position at the moment when the players performed the front change; PP_{aver} - the average pelvis position at the moment when the players performed the front change; KA_{\min} - the minimum angle in the knee joint of the outside leg; $Knee_AV_{\max}$ – the maximum angular velocity in the knee joint of the outside leg during the concentric phase; $Wrist_AV_{\max}$ – the maximum angular velocity in the wrist joint from the point that the players flexed their outside hand to switch the ball to the inside hand; FSV- the first step velocity at the moment when the players performed the front change; $Force_{\max}$ - the maximum force of the outside foot during the concentric phase.

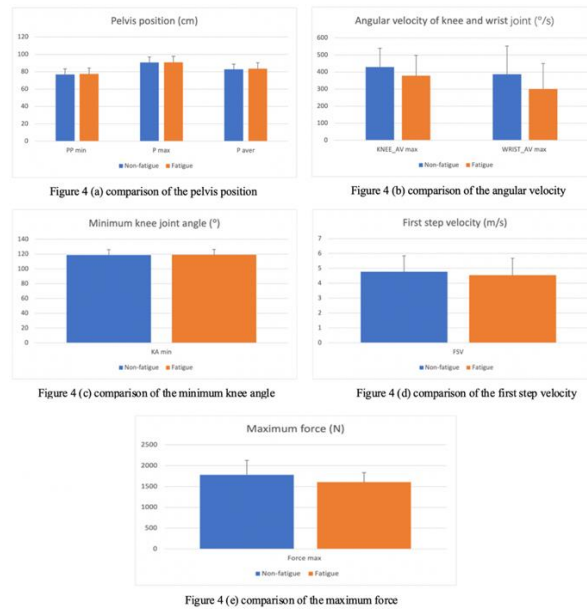

Figure 4 the comparison of the variables for front change of direction

3.2 Spin move

The statistical analysis of ANOVA for repeated measurements was used to observe the biomechanical difference between non-fatigued and fatigued states. As Table 3 shows, there was a significant difference between the two groups ($p=0.003$).

Table 3. The results of ANOVA for repeated measurements (for groups).

Test	Value	F	p
Wilks	0.78	3.20	0.003*

*Marked values were significant when $p < 0.05$.

Table 4 and Figure 5 present the descriptive parameters and results of ANOVA for repeated measurements of the fatigued and non-fatigued states. First, the mean value of PV_{max} significantly decreased in fatigued state compared to non-fatigued state (fatigued=2.79; non-fatigued=3.15; $p=0.000$). Likewise, the mean value of $KNEE_AV_{max}$ was dramatically decreased in fatigued state (fatigued=286.90; non-fatigued=328.63; $p=0.020$). Moreover, the FSV was considerably lower in fatigued than non-fatigued state (fatigued=7.41; non-fatigued=7.76; $p=0.010$). Second, the $Force_{max}$ in the fatigued state decreased compared to the non-fatigued state but did not significantly differ between the two groups (fatigued=1583; non-fatigued=1736.77; $p=0.059$). Last, similar to the results of the front change, the mean value of PP_{min} , PP_{max} , PP_{aver} , and KA_{min} were slightly higher in the fatigued state than non-fatigued state, whereas there were no significant differences in terms of PP_{min} ($p=0.386$), PP_{max} ($p=0.498$), PP_{aver} ($p=0.656$) and KA_{min} ($p=0.288$).

Table 4 Descriptive parameters and results of ANOVA for repeated measurements of the fatigued and non-fatigued states.

Variable	Group	N	Mean	Min	Max	SD	F	p
PP_{min} (cm)	Non-fatigued	50	78.82	70.16	98.25	6.59	0.76	0.386
	Fatigued	50	80.02	69.23	96.670	7.25		
PP_{max} (cm)	Non-fatigued	50	92.08	78.57	109.95	7.39	0.46	0.498
	Fatigued	50	93.07	80.75	106.43	7.20		
PP_{aver} (cm)	Non-fatigued	50	86.71	76.35	104.56	7.19	0.20	0.656
	Fatigued	50	87.36	74.93	102.00	7.42		
PV_{max} (m/s)	Non-fatigued	50	3.15	2.42	4.09	0.37	16.88	0.000*
	Fatigued	50	2.79	1.12	3.69	0.49		
KA_{min} (°)	Non-fatigued	50	111.98	92.85	135.21	9.61	1.14	0.288
	Fatigued	50	114.21	91.92	141.67	11.28		
KNEE_AV_{max} (°/s)	Non-fatigued	50	328.63	202.29	563.13	90.92	5.60	0.020*
	Fatigued	50	286.90	49.10	559.78	85.33		
FSV (m/s)	Non-fatigued	50	7.76	6.43	9.07	0.62	6.83	0.010*
	Fatigued	50	7.41	4.87	8.84	0.71		
Force_{max} (N)	Non-fatigued	50	1736.77	963.54	2786.40	415.88	3.64	0.059
	Fatigued	50	1583.00	982.80	2838.60	389.24		

Legend: * $p < 0.05$; PP_{min} - the minimum pelvis position at the moment when the players performed the spin move; PP_{max} - the maximum pelvis position at the moment when the players performed the spin move; PP_{aver} - the average pelvis position at the moment when the players performed the spin move; PV_{max} - the maximum velocity of the pelvis at the moment when the players performed the spin move by rotating their pelvis; KA_{min} - the minimum angle in the knee joint of the inside leg; Knee_AV_{max} – the maximum angular velocity in the knee joint of the inside leg during the concentric phase; FSV- the first step velocity at the moment when the players performed the spin move; Force_{max} - the maximum force of the inside foot during the concentric phase.

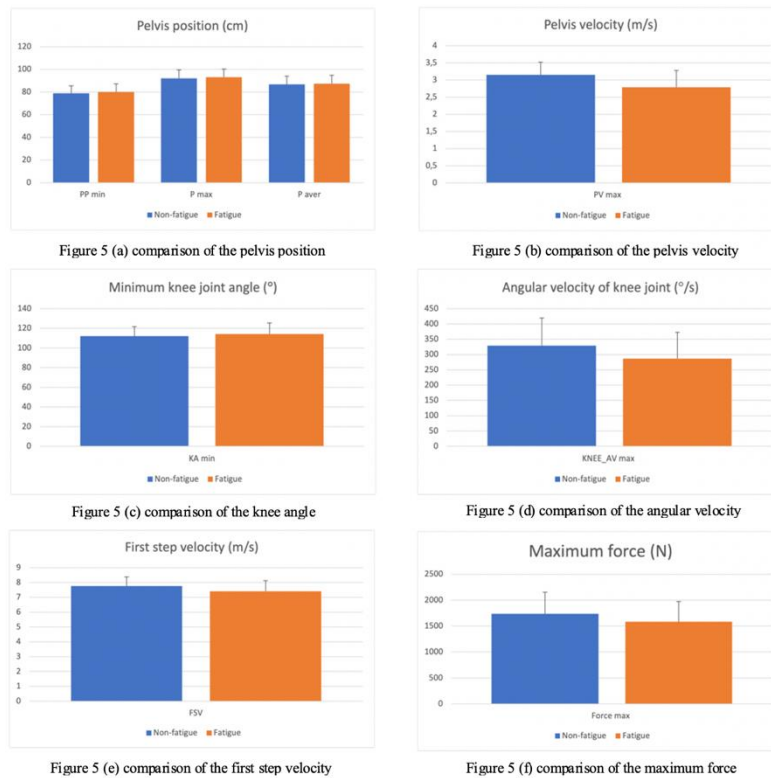

Figure 5 the comparison of the variables for spin move

To determine the difference in dribbling speed between non-fatigued and fatigued states, T-test for dependent samples was applied. As can be seen from Table 5, the players spent more time in the fatigued state compared to the non-fatigued state (fatigued=18.53; non-fatigued=17.50) and there was a significant difference between the two states ($p=0.002$).

Table 5 The results in dribbling speed of the T-test for dependent samples

Group	N	Mean (s)	SD	p	Cohen's (d)
Non-fatigued	14	17.50	0.87	0.002*	1.001
Fatigued	14	18.53	1.52		

*Marked values were significant when $p < 0.05$.

3.3 The physiological response during testing

Table 6 shows an overview of the heart rate and blood lactate in different states of testing for the non-fatigued and fatigued states. The mean value of the players' HR was 79.07 beats/min and 188.57 beats/min in the states of before warm-up (non-fatigued state) and after the fatigue protocol (fatigued state), respectively. Additionally, the mean value of the players' BL was 1.26 mmol/l and 11.06 mmol/l in the states before warm-up (non-fatigued state) and after the fatigue protocol (fatigued state), respectively. The aforementioned results revealed that there was a significant difference between the non-fatigued and fatigued states in fatigue levels.

Table 6 Descriptive statistics of Heart Rate (HR) and Blood Lactate (BL) between non-fatigued and fatigued states

Variable	N	Mean	Minimum	Maximum	SD
HR_B_WU (beats/min)	14	79.07	58.00	102.00	11.47
HR_A_FT (beats/min)	14	173.36	156.00	194.00	11.84
HR_A_FP (beats/min)	14	188.57	173.00	203.00	9.39
HR_D_ST_{max} (beats/min)	14	178.86	164.00	197.00	10.28
BL_B_WU (mmol/l)	14	1.26	0.60	1.70	0.35
BL_A_WU (mmol/l)	14	2.74	0.70	5.80	1.55
BL_A_FT (mmol/l)	14	5.55	2.60	10.00	2.52
BL_A_FP (mmol/l)	14	11.06	6.70	15.70	3.19

Legend: BL_B_WU- the players' heart rate before warm-up; HR_A_FT- the players' heart rate after the first testing (non-fatigued state); HR_A_FP- the players' heart rate after the fatigue protocol; HR_D_ST max- the players' heart rate during second testing (fatigued state); BL_B_WU- the players' blood lactate before warm-up; BL_A_WU- the players' blood lactate after warm-up; BL_A_FT- the players' blood lactate after the first testing (non-fatigued state); BL_A_FP- the players' blood lactate after the fatigue protocol (fatigued state).

4. Discussion and Conclusions

Dribbling with COD is motorically the most complex type of dribbling and players perform it frequently during competition due to a high level of pressure from defenders (Krause & Nelson, 2018). Previous studies have reported that fatigue has a negative influence on basketball players' performance (Erculj & Supej, 2009; Mulazimoglu, et al., 2017). Surprisingly, little is known about the effect of fatigue on kinematics and kinetics of basketball dribbling. The aim of this study was to determine the effect of fatigue on kinematics and kinetics of dribbling with COD as well as the effect of fatigue on dribbling speed. The results of the present study showed that there was a significant difference in dribbling kinematics and kinetics between the fatigued and non-fatigued states. Additionally, dribbling speed significantly decreased in the fatigued state compared to the non-fatigued state. The findings are in line with our previously formulated hypotheses.

In this study, the mean value of the players' HR was 79.07 ± 11.47 beats/min in the state before warm-up (non-fatigued state) and 188.57 ± 9.39 beats/min in the state after the fatigue protocol (fatigued state). Additionally, the mean value of the players' BL was 1.26 ± 0.35 mmol/L in the

state before warm-up (non-fatigued state) and 11.06 ± 3.19 mmol/L in the state after the fatigue protocol (fatigued state). There were some studies investigating the response of HR and BL to the real game situation (McInnes, Carlson, Jones, & McKenna, 1995; Torres-Ronda, Ric, Llabres-Torres, de Las Heras, & Schelling, 2016). Torres Ronda et al. (2016) assessed players' HR during a friendly basketball game, reporting that the peak HR was 198 beats/min. Another study by McInnes et al. (1995) observed the physiological response to basketball competition, stating that the mean maximum BL for all subjects was 8.5 ± 3.1 mmol/L, with the highest individual being 13.2 mmol/L. Given the aforementioned results, it can be concluded in this study that the conditions during testing in the fatigued state were similar to real basketball competition (game speed).

For the front change (FCOD) and spin move (SM), the selected variables of this study were pelvis position, KA min, KNEE_AV max, WRIST_AV max, FSV, and Force max. The pelvis position was used to observe the difference of the center of mass between the non-fatigued and fatigued states. Similarly, the KA min was used to observe the lowest position of the knee so to identify if the players lowered their body when the defenders (cones) were close to the ball handler. The assumption was that, if the aforementioned variables in the fatigued state had higher values, it would mean that the player, his center of mass, was in a higher position, which might consequently induce the possibility of losing ball possession and affect the realization of spatial and temporal advantage over the defender. Additionally, Force max was selected because it plays an important role in the players' FSV. Namely, FSV determines if a player can pass by the defender successfully. Furthermore, the KNEE_AV max was selected because the players with a higher KNEE_AV max could generally perform a quick first step. Moreover, the players with higher WRIST_AV max are able to switch the ball from the outside to the inside hand quickly so that they can not only protect the ball well but also make a quick COD to pass by the defenders. Last, the PV max in SM was selected because the higher velocity of pelvis rotation was not only critical for ball possession keeping but it also facilitated to achieve a spatial and temporal advantage over the defender.

Consistent with literature, this study found that there were significant differences between the non-fatigued and fatigued states in the kinematics of FCOD and SM, which was in agreement with previous studies showing that the kinematic parameters of basketball skills changed when the players were under the influence of fatigue (Erculj & Supej, 2006, 2009; Rupčić, et al., 2020). Additionally, the current study found that there was a statistically significant difference in Force max (kinetic) with respect to FCOD between the fatigued and non-fatigued states (fatigued=1608.42 N; non-fatigued=1782.26 N; $p=.004$). This finding is in line with previous

studies confirming that fatigue can cause the reduction in the capacity of the muscle to generate force (Arora, Budden, Byrne, & Behm, 2015; Morin, Samozino, Edouard, & Tomazin, 2011; Wan, Qin, Wang, Sun, & Liu, 2017), which results in a player who is unable to continue moving at the same level of performance (Cortes, Onate, & Morrison, 2014; Morin, et al., 2011). However, the Force max did not significantly decrease in the fatigued state in terms of SM (fatigued=1583 N; non-fatigued=1736.77 N; $p=.059$). A possible explanation for this result may be the technical difference between FCOD and SM. When players perform SM, they first make a hard step with the inside foot, then the pressure on the inside foot is shifted onto the outside foot with the rotation of the pelvis following the first step (Krause & Nelson, 2018). In terms of FCOD, however, the player conducts the first step by fully pressing the ground with the same foot. Therefore, the foot pressure of the support leg during the concentric phase is supposed to be lower in SM compared to FCOD. As a result, the Force max did not significantly decrease in the fatigued state.

The results of this study revealed that dribbling speed significantly decreased in the fatigued state ($p=.002$), corresponding to previous studies which concluded that fatigue has a negative influence on basketball players' performance (Erculj & Supej, 2009; Mulazimoglu, et al., 2017; Thorpe, et al., 2017). These results may be explained by the fact that the reduction of force production leads to the decrease of dribbling speed as it has been proved that there is a strong correlation between velocity and force (Janicijevic, et al., 2020; Zivkovic, Djuric, Cuk, Suzovic, & Jaric, 2017). Furthermore, previous studies have pointed out that greater lower body strength (Spiteri, Cochrane, Hart, Haff, & Nimphius, 2013) and the subsequent application of force and impulse (Spiteri, et al., 2014) enable athletes to perform a more effective and rapid motor response. In accordance with the present results, numerous studies have found the same result that sprint speed decreases when the subjects are in the fatigued state (Dal Pupo, Detanico, Ache-Dias, & Santos, 2017; Morin, et al., 2011). Morin et al. (2011) investigated the effect of fatigue on force production and force application technique during repeated sprints. Sprint speed and force production dramatically decreased. Furthermore, Dal Pupo et al. (2017) studied the fatigue effect of a simulated futsal match protocol on sprint performance and the kinematics of the lower limbs, demonstrating a significant decrement in sprint speed.

In our study, the KNEE_AV max ($p=.028$) and WRIST_AV max ($p=.007$) in the fatigued state significantly decreased compared to the non-fatigued state with respect to FCOD. Additionally, the mean value of KNEE_AV max dramatically decreased in the fatigued state ($p=.020$) regarding SM. These results may be explained by the fact that fatigue caused the reduction of muscle strength, velocity, and coordination (Janicijevic, et al., 2020; Morin, et al., 2011;

Zivkovic, et al., 2017), which ultimately reduced angular velocities in individual joint systems. Our study can explain the decrease of the FSV in both FCOD and SM by the fact that fatigue caused the decrease of force and then further led to the deterioration of FSV. Similarly, the mean value of PV max in SM significantly decreased in the fatigued state ($p=.000$), which was likely to be associated with this factor.

In this study, the pelvis position (PP min, PP max, PP aver) was higher and KA min was larger in the fatigued state than in the non-fatigued state regardless of whether in FCOD or SM. Previous studies have stated that decreases in the lower limb muscle activation due to fatigue could result in changes in pelvis position, and the reduction of strength tended to increase the players' center of mass (Lessi, dos Santos, Batista, de Oliveira, & Serrão, 2017; Lessi & Serrão, 2017). As a result, theoretically, the KA min is supposed to increase when the players' pelvis position increases.

In summary, the major conclusion drawn from this study according to the results was that fatigue significantly affects the kinematics and kinetics of basketball dribbling. Additionally, dribbling speed significantly decreased when the players were under the fatigued state. The higher pelvis position, the lower angular velocity in the knee and wrist joint, and the lower force when the players are under the fatigued state may induce their inability to take advantage over the defender successfully. Additionally, the decrease in dribbling speed under the fatigued state will make players less able to pass by the defender quickly during the fast break and transition to offense, which consequently makes them lose the opportunity of scoring.

Practical application

The findings of this study have provided evidence for the coaching staff why they are required to design appropriate training programs to optimize the players' fatigue tolerance needed in dribbling. There is an exceptional need, after the skill has been adopted, to practice it under the conditions of high load and game speed in order to decrease the expected reduction in efficiency. Segments that have shown statistical significance should be in the focus of expert coaches able to evaluate skill performance and constantly improve it using a large number of training operators under high load. It is important to ultimately achieve automatism in players whose skill performance will be close to perfect even under the conditions of extreme load in order to be able to respond to the challenges of modern basketball in which defensive pressure on the player with the ball is extremely high. Only players who can demonstrate a high level of skill performance under high loads (both cognitive and physical) can find the best solution in spatial and temporal on-court alignment and ultimately achieve exceptional situational efficiency.

Ethical Approval Information

The study was conducted according to the guidelines of the Declaration of Helsinki and approved by the Ethics Committee of Faculty of Kinesiology of University of Zagreb (ethical code 108/2020, 27 November 2020)

Funding

The first author was supported by the China Scholarship Council (CSC) from the Ministry of Education of P.R. China under Grant [(2019) 110].

References

- ANDRIĆ, M. 2011. Analysis of frequency and efficiency of using dribble in the European basketball championship in Poland in 2009. *Fizička kultura*, 65(1), 52-59.
- ARIAS, J. L., ARGUDO, F. M., & ALONSO, J. I. 2012. Effect of ball mass on dribble, pass, and pass reception in 9-11-year-old boys' basketball. *Res Q Exerc Sport*, 83(3), 407-412. doi:10.1080/02701367.2012.10599875
- ARIAS-ESTERO, J. L. 2013. Opportunities for and success in dribbling, passing, receiving, and shooting in youth basketball. *International Journal of Sports Science Coaching*, 8(4), 703-711.
- ARORA, S., BUDDEN, S., BYRNE, J. M., & BEHM, D. G. 2015. Effect of unilateral knee extensor fatigue on force and balance of the contralateral limb. *Eur J Appl Physiol*, 115(10), 2177-2187. doi:10.1007/s00421-015-3198-5
- BALSALOBRE-FERNÁNDEZ, C., BISHOP, C., BELTRÁN-GARRIDO, J. V., CECILIA-GALLEGO, P., CUENCA-AMIGÓ, A., ROMERO-RODRÍGUEZ, D. & MADRUGA-PARERA, M. 2019. The validity and reliability of a novel app for the measurement of change of direction performance. *Journal of sports sciences*, 37, 2420-2424.
- BELIĆ, M., RADIN, L., BRKLJAČA BOTTEGARO, N., BEER, L., BLANKA, B. M., STANIN, D. & VRBANAC, Z. 2016. Reliability of lactate scout portable analyzer in agility dogs during multiple measurements. *Acta Veterinaria-Beograd*, 66, 549-555.
- CALLEJA-GONZÁLEZ, J., TERRADOS, N., MIELGO-AYUSO, J., DELEXTRAT, A., JUKIC, I., VAQUERA, A., TORRES, L., SCHELLING, X., STOJANOVIC, M. & OSTOJIC, S. M. 2016. Evidence-based post-exercise recovery strategies in basketball. *Phys Sportsmed*, 44, 74-8.

- CALLISTER, R., MILLER, A., AGUIAR, E., DASCOMBE, B., SMITH, C., CLARK, L., & ROGERS, T. 2010. Blood lactate levels support classification of the 300 m shuttle run as an anaerobic capacity field test. *Journal of Science Medicine in Sport*, 13, e30-e31.
- CHRISTMANN, J., AKAMPHUBER, M., MÜLLENBACH, A. L., & GÜLLICH, A. 2018. Crunch time in the NBA—The effectiveness of different play types in the endgame of close matches in professional basketball. *International Journal of Sports Science Coaching*, 13(6), 1090-1099.
- CONTE, D., FAVERO, T. G., NIEDERHAUSEN, M., CAPRANICA, L., & TESSITORE, A. 2016. Effect of different number of players and training regimes on physiological and technical demands of ball-drills in basketball. *J Sports Sci*, 34(8), 780-786. doi:10.1080/02640414.2015.1069384
- CONTE, D., FAVERO, T. G., NIEDERHAUSEN, M., CAPRANICA, L., & TESSITORE, A. 2017. Determinants of the effectiveness of fast break actions in elite and sub-elite Italian men's basketball games. *Biol Sport*, 34(2), 177-183. doi:10.5114/biol sport.2017.65337
- CONTE, D., SCANLAN, A. T., DALBO, V. J., GANG, S. Z., SMITH, M. R., BIETKIS, T., & MATULAITIS, K. 2020. Dribble Deficit quantifies dribbling speed independently of sprinting speed and differentiates between age categories in pre-adolescent basketball players. *Biol Sport*, 37(3), 261-267. doi:10.5114/biol sport.2020.95637
- CORTES, N., ONATE, J., & MORRISON, S. 2014. Differential effects of fatigue on movement variability. *Gait & Posture*, 39(3), 888-893. doi:https://doi.org/10.1016/j.gaitpost.2013.11.020
- CORTIS, C., TESSITORE, A., LUPO, C., PESCE, C., FOSSILE, E., FIGURA, F., & CAPRANICA, L. 2011. Inter-limb coordination, strength, jump, and sprint performances following a youth men's basketball game. *J Strength Cond Res*, 25(1), 135-142. doi:10.1519/JSC.0b013e3181bde2ec
- DAL PUPO, J., DETANICO, D., ACHE-DIAS, J., & SANTOS, S. G. 2017. The fatigue effect of a simulated futsal match protocol on sprint performance and kinematics of the lower limbs. *J Sports Sci*, 35(1), 81-88. doi:10.1080/02640414.2016.1156727
- DOS SANTOS, F. G., PACHECO, M. M., BASSO, L., BASTOS, F. H., & TANI, G. 2020. Development and validation of a checklist to assess proficient performance of basketball straight speed dribbling skill. *J Hum Kinet*, 71, 21-31. doi:10.2478/hukin-2019-0073
- DOYLE, B., BROWNE, D. & HORAN, D. 2020. The relationship of aerobic endurance and linear speed on repeat sprint ability performance in female international footballers. *International Journal of Human Movement and Sports Sciences*, 8, 147-153.

- ERČULJ, F., BLAS, M., & BRAČIČ, M. 2010. Physical demands on young elite European female basketball players with special reference to speed, agility, explosive strength, and take-off power. *J Strength Cond Res*, 24(11), 2970-2978. doi:10.1519/JSC.0b013e3181e38107
- ERCULJ, F., & SUPEJ, M. 2009. Impact of fatigue on the position of the release arm and shoulder girdle over a longer shooting distance for an elite basketball player. *J Strength Cond Res*, 23(3), 1029-1036. doi:10.1519/JSC.0b013e3181a07a27
- ERČULJ, F., & SUPEJ, M. 2006. The impact of fatigue on jump shot height and accuracy over a longer shooting distance in basketball. *UGDYMAS • KŪNO KULTŪRA • SPORTAS*, 4(63), 35-41.
- EVANGELOS, T., ALEXANDROS, K., & NIKOLAOS, A. J. I. J. O. P. A. I. S. 2005. Analysis of fast breaks in basketball. *International Journal of Performance Analysis in Sport*, 5(2), 17-22.
- FUJII, K., YAMADA, Y., & ODA, S. 2010. Skilled basketball players rotate their shoulders more during running while dribbling. *Perceptual and Motor Skills*, 110(3), 983-994.
- FUJII, K., YAMADA, Y., & ODA, S. 2010. Skilled basketball players rotate their shoulders more during running while dribbling. *Percept Mot Skills*, 110(3 Pt 1), 983-994. doi:10.2466/pms.110.3.983-994
- GUIMARÃES, E., BAXTER-JONES, A., MAIA, J., FONSECA, P., SANTOS, A., SANTOS, E., JANEIRA, M. A. 2019. The roles of growth, maturation, physical fitness, and technical skills on selection for a portuguese under-14 years basketball team. *Sports (Basel)*, 7(3). doi:10.3390/sports7030061
- HINDE, K., WHITE, G. & ARMSTRONG, N. 2021. Wearable devices suitable for monitoring twenty four hour heart rate variability in military populations. *Sensors (Basel)*, 21, 1061
- JAKOVLJEVIĆ, S., KARALEJIĆ, M., IVANOVIĆ, J., ŠTRUMBELJ, E., & ERČULJ, F. 2017. Efficiency of speed and agility dribbling of young basketball players. *Kinesiology Slovenica*, 23(2), 22-32.
- JANICIJEVIC, D., KNEZEVIC, O. M., MIRKOV, D. M., PÉREZ-CASTILLA, A., PETROVIC, M., SAMOZINO, P., & GARCIA-RAMOS, A. 2020. Assessment of the force-velocity relationship during vertical jumps: influence of the starting position, analysis procedures and number of loads. *Eur J Sport Sci*, 20(5), 614-623. doi:10.1080/17461391.2019.1645886
- KRAUSE, J. V., & NELSON, C. 2018. *Basketball skills & drills: Human Kinetics*.

- LESSI, G. C., DOS SANTOS, A. F., BATISTA, L. F., DE OLIVEIRA, G. C., & SERRÃO, F. V. 2017. Effects of fatigue on lower limb, pelvis and trunk kinematics and muscle activation: gender differences. *Journal of Electromyography Kinesiology*, 32, 9-14.
- LESSI, G. C., & SERRÃO, F. V. 2017. Effects of fatigue on lower limb, pelvis and trunk kinematics and lower limb muscle activity during single-leg landing after anterior cruciate ligament reconstruction. *Knee Surgery, Sports Traumatology, Arthroscopy*, 25(8), 2550-2558.
- LI, F., KNJAZ, D., & RUPČIĆ, T. 2021. Influence of fatigue on some kinematic parameters of basketball passing. *Int J Environ Res Public Health*, 18(2). doi:10.3390/ijerph18020700
- LYONS, M., AL-NAKEEB, Y., & NEVILL, A. 2006. The impact of moderate and high intensity total body fatigue on passing accuracy in expert and novice basketball players. *Journal of Sports Science & Medicine*, 5(2), 215.
- MANCHA-TRIGUERO, D., GARCÍA-RUBIO, J., CALLEJA-GONZÁLEZ, J., & IBÁÑEZ, S. J. 2019. Physical fitness in basketball players: a systematic review. *J Sports Med Phys Fitness*, 59(9), 1513-1525. doi:10.23736/s0022-4707.19.09180-1
- MANCHA-TRIGUERO, D., GARCÍA-RUBIO, J., GAMONALES, J. M., & IBÁÑEZ, S. J. 2021. Strength and speed profiles based on age and sex differences in young basketball players. *Int J Environ Res Public Health*, 18(2). doi:10.3390/ijerph18020643
- MATULAITIS, K., & BIETKIS, T. 2021. Prediction of offensive possession ends in elite basketball teams. *Int J Environ Res Public Health*, 18(3). doi:10.3390/ijerph18031083
- MCINNES, S. E., CARLSON, J. S., JONES, C. J., & MCKENNA, M. J. 1995. The physiological load imposed on basketball players during competition. *J Sports Sci*, 13(5), 387-397. doi:10.1080/02640419508732254
- MILANOVIĆ, D., SELMANOVIĆ, A., & ŠKEGRO, D. 2014. Characteristics and differences of basic types of offenses in European and American top-level basketball. *Proceedings Book of the 7th International Scientific Conference on Kinesiology*-(pp. 400–403). Zagreb: Faculty of Kinesiology, University of Zagreb
- MORIN, J.-B., SAMOZINO, P., EDOUARD, P., & TOMAZIN, K. 2011. Effect of fatigue on force production and force application technique during repeated sprints. *J Biomech*, 44(15), 2719-2723. doi:https://doi.org/10.1016/j.jbiomech.2011.07.020
- MULAZIMOGLU, O., YANAR, S., TUNCA EVCIL, A., & DUVAN, A. 2017. Examining the effect of fatigue on shooting accuracy in young basketball players. *The Anthropologist*, 27(1-3), 77-80.

- NAKANO, N., FUKASHIRO, S., & YOSHIOKA, S. 2020. The effect of increased shooting distance on energy flow in basketball jump shot. *Sports Biomechanics*, 19(3), 366-381. doi:10.1080/14763141.2018.1480728
- OKAZAKI, V. H. A., & RODACKI, A. L. F. 2012. Increased distance of shooting on basketball jump shot. *Journal of sports science medicine*, 11(2), 231.
- OKUBO, H., & HUBBARD, M. 2015. Kinematics of arm joint motions in basketball shooting. *Procedia Engineering*, 112, 443-448. doi:10.1016/j.proeng.2015.07.222
- ROBALO, R. A. M., DINIZ, A., FERNANDES, O., & PASSOS, P. J. M. 2020. The role of variability in the control of the basketball dribble under different perceptual setups. *Eur J Sport Sci*, 1-10. doi:10.1080/17461391.2020.1759695
- ROBERT-LACHAINE, X., MECHERI, H., LARUE, C., & PLAMONDON, A. 2017. Validation of inertial measurement units with an optoelectronic system for whole-body motion analysis. *Med Biol Eng Comput*, 55(4), 609-619. doi:10.1007/s11517-016-1537-2
- RUPČIĆ, T., FENG, L., MATKOVIĆ, B. R., KNJAZ, D., DUKARIĆ, V., BAKOVIĆ, M., GARAFOLIĆ, H. 2020. The impact of progressive physiological loads on angular velocities during shooting in basketball-case study. *Acta Kinesiologica*, 14(2), 102-109.
- SCANLAN, A., DASCOMBE, B., & REABURN, P. 2011. A comparison of the activity demands of elite and sub-elite Australian men's basketball competition. *J Sports Sci*, 29(11), 1153-1160. doi:10.1080/02640414.2011.582509
- SCANLAN, A. T., DALBO, V. J., CONTE, D., STOJANOVIĆ, E., STOJILJKOVIĆ, N., STANKOVIĆ, R., MILANOVIĆ, Z. 2019. Caffeine supplementation has no effect on dribbling speed in elite basketball players. *Int J Sports Physiol Perform*, 14(7), 997-1000. doi:10.1123/ijsp.2018-0871
- SCANLAN, A. T., DASCOMBE, B. J., KIDCAFF, A. P., PEUCKER, J. L., & DALBO, V. J. 2015. Gender-specific activity demands experienced during semiprofessional basketball game play. *Int J Sports Physiol Perform*, 10(5), 618-625. doi:10.1123/ijsp.2014-0407
- SEKULIC, D., PEHAR, M., KROLO, A., SPASIC, M., ULJEVIC, O., CALLEJA-GONZÁLEZ, J., & SATTTLER, T. 2017. Evaluation of basketball-specific agility: applicability of preplanned and nonplanned agility performances for differentiating playing positions and playing levels. *J Strength Cond Res*, 31(8), 2278-2288. doi:10.1519/jsc.0000000000001646

- SLAWINSKI, J. P., LOUIS, J., POLI, J., TIOLLIER, E., KHAZOOM, C., & DINU, D. 2018. The effects of repeated sprints on the kinematics of 3-point shooting in basketball. *J Hum Kinet*, 62, 5-14. doi:10.1515/hukin-2017-0156
- SORRENTINO, I., ANDRADE CHAVEZ, F. J., LATELLA, C., FIORIO, L., TRAVERSARO, S., RAPETTI, L., PUCCI, D. 2020. A novel sensorised insole for sensing feet pressure distributions. *Sensors (Basel)*, 20(3). doi:10.3390/s20030747
- SPEER, K. E., SEMPLE, S., NAUMOVSKI, N. & MCKUNE, A. J. 2020. Measuring heart rate variability using commercially available devices in healthy children: A validity and reliability study. *European Journal of Investigation in Health, Psychology Education*, 10, 390-404.
- SPITERI, T., COCHRANE, J. L., HART, N. H., HAFF, G. G., & NIMPHIUS, S. 2013. Effect of strength on plant foot kinetics and kinematics during a change of direction task. *Eur J Sport Sci*, 13(6), 646-652. doi:10.1080/17461391.2013.774053
- SPITERI, T., NIMPHIUS, S., HART, N. H., SPECOS, C., SHEPPARD, J. M., & NEWTON, R. U. 2014. Contribution of strength characteristics to change of direction and agility performance in female basketball athletes. *J Strength Cond Res*, 28(9), 2415-2423. doi:10.1519/jsc.0000000000000547
- SPORIŠ, G., VUČETIĆ, V., MILANOVIĆ, L., MILANOVIĆ, Z., KRESPI, M., & KRAKAN, I. 2014. A comparison anaerobic endurance capacity in elite soccer, handball and basketball players. *Kinesiology*, 46(Supplement 1), 52-59.
- STRICKER, G., SCHEIBER, P., LINDENHOFER, E., & MÜLLER, E. 2010. Determination of forces in alpine skiing and snowboarding: Validation of a mobile data acquisition system. *European Journal of Sport Science*, 10(1), 31-41.
- TANNER, R. K., FULLER, K. L. & ROSS, M. L. 2010. Evaluation of three portable blood lactate analysers: Lactate Pro, Lactate Scout and Lactate Plus. *European journal of applied physiology*, 109, 551-559.
- THORPE, R. T., ATKINSON, G., DRUST, B., & GREGSON, W. 2017. Monitoring fatigue status in elite team-sport athletes: implications for practice. *Int J Sports Physiol Perform*, 12(Suppl 2), S227-s234. doi:10.1123/ijsp.2016-0434
- TORRES-RONDA, L., RIC, A., LLABRES-TORRES, I., DE LAS HERAS, B., & SCHELLING, I. D. A. X. 2016. Position-dependent cardiovascular response and time-motion analysis during training drills and friendly matches in elite male basketball players. *J Strength Cond Res*, 30(1), 60-70. doi:10.1519/jsc.0000000000001043

- UYGUR, M., GOKTEPE, A., AK, E., KARABÖRK, H., & KORKUSUZ, F. 2010. The effect of fatigue on the kinematics of free throw shooting in basketball. *Journal of Human Kinetics*, 24, 51-56.
- WAN, J. J., QIN, Z., WANG, P. Y., SUN, Y., & LIU, X. 2017. Muscle fatigue: general understanding and treatment. *Exp Mol Med*, 49(10), e384. doi:10.1038/emm.2017.194
- WORLD MEDICAL ASSOCIATION DECLARATION OF HELSINKI: ETHICAL PRINCIPLES FOR MEDICAL RESEARCH INVOLVING HUMAN SUBJECTS. JAMA. 2013 Nov 27;310(20):2191-4. DOI: 10.1001/jama.2013.281053
- ZIVKOVIC, M. Z., DJURIC, S., CUK, I., SUZOVIC, D., & JARIC, S. 2017. Muscle force-velocity relationships observed in four different functional tests. *J Hum Kinet*, 56, 39-49. doi:10.1515/hukin-2017-0021

CHAPTER 4: GENERAL CONCLUSION

This doctoral thesis was conducted in five independent investigations. The aim of this doctoral study was to identify the influence of fatigue on kinematic parameters and players' performance in basketball fundamental skills.

In general, the result showed that fatigue has negative effect on kinematic parameters in basketball fundamental skills—passing, shooting, and dribbling. Therefore, this research suggest that basketball coaches and teachers are required to design appropriate training programs to resist fatigue in order to minimize its influence on basketball players' fundamental skills. The specific conclusion was stated below:

The results of study 1 showed that there were significant differences in the maximum angular velocity of shoulder, elbow, and wrist between fatigue and non-fatigue condition. Additionally, the passing accuracy and ball speed when players were under the influence of fatigue were significantly decreased compared to non-fatigue condition. Furthermore, the players' pelvis position was obviously increased when they were under fatigue. Moreover, there was a significant difference in pelvis velocity related to X-axis between fatigue and non-fatigue condition, while there was no significant difference in Y-axis. The findings of this study could help coaches to better understand the pattern of movement of push passing and to correct the players' technique. It is extremely important to point out that players adopt the correct motor structure of passing to create an automatism during the training process of learning, which will ultimately not change even under the influence of fatigue. Only this can ensure the situational efficiency of the player, because any deviation from the ideal biomechanical structure also affects the occurrence of a larger number of motor errors, and consequently reduced efficiency. From the aspect of cooperation between two players in offense, in addition to the correctly adopted movement structure, it is also necessary to perfect spatial–temporal relations in passing and catching the ball, which is possible if the conditions of the players' training process are similar to the conditions of the game.

The results of study 2 indicated that the angular velocity of lower extremity was higher in fatigue compared to non-fatigue condition. Conversely, the angular velocity of upper extremity was lower in fatigue compared to non-fatigue condition. Additionally, the jump shot accuracy did not decrease significantly in fatigue condition. The results of this study indicated that elite female basketball players are able to maintain the efficiency through readjusting the

neuromuscular system to make a successful jump shot when they were under fatigue condition. Furthermore, the results of study 2 showed that the release height and entry angle of the ball significantly decreased in fatigue condition, suggesting that coaches need to include in the training process exercise that is similar in terms of fatigue and performance to the situational condition during the game as these two variables play an important role in determination of the shooting accuracy.

The results of study 3 demonstrated that fatigue impacts certain changes in the kinematic parameters of jump shot. The angular velocities of joints in the lower extremities noticeably increased, while the mentioned parameters in the upper extremities decreased, which is in line with study 2. Additionally, as a result of fatigue, the height of releasing the ball also decreased. Despite the changes in the above-mentioned parameters, the action performed on the ball remained unchanged considering that the shoot speed, as well as the angle at which the ball entered the basket demonstrated no changes. Even though the action performed on the ball did not alter from the biomechanical standpoint, the reduction of shooting accuracy under the influence of a higher level of fatigue still suggests that certain deviations occurred in the overall pattern of performing the examined motor skill. Based on this research, a proposal for the improvement of basketball practice is surely to perform training processes during which the jump shot, and the development of shooting accuracy would be executed in conditions of variable load that shall ultimately be directed towards annulling the deviations in the kinematic parameters of the jump shot, which shall consequently also positively affect the development of shooting accuracy.

The results of study 4 showed that female and male basketball players used different shooting techniques. Additionally, players in male categories shot with a higher center of mass difference in the vertical direction, with a higher release shoulder angle, and with a higher entry angle of the ball. Moreover, the entry angle of the ball increases in all categories when shooting for 3-pt, implying that players need more time for 3-pt shots after receiving a pass when compared to 2-pt shots. Therefore, the players are using excessive movements to optimize the shooting technique when shooting for 3-pt. Basketball coaches and players should work to minimize the kinematic differences between 2-pt and 3-pt shooting to increase the successfulness of shooting from longer distances.

The results of study 5 indicated that fatigue affects the kinematics and kinetics of basketball dribbling. Additionally, the dribbling speed significantly decreased when the players were

under the fatigue condition. From the result point of view, the higher pelvis position, the lower angular velocity in knee and wrist joint, and the lower force when the players are under the fatigue condition may induce that they are not able to take advantage of the defender successfully. Additionally, the decrease of the dribbling speed under the fatigue condition will lead to that the players are not able to pass by the defender quickly during the fast break and transition period, which consequently makes them lose the opportunity of scoring. Thereby, the findings of study 5 provide evidence that coaching staff are required to design appropriate training sessions to optimize the players' ability to resist fatigue in dribbling. There is an exceptional need, after the technique is adopted, to train in the phase of high load and game speed in order to decrease the expected reduction in efficiency. Segments that have shown statistical significance should be the focus of specialized educated coaches who are able to detect the current situation and constantly improve it with a large number of operators under high load. It is important to ultimately achieve automatism in players, even in conditions of extreme load in order to be able to respond to the challenges of modern basketball in which the pressure on the player with the ball is extremely significant. Only players who can demonstrate a high level of technique under a load (defensive, functional, and motor) can find the best solution in spatial and temporal alignment and ultimately achieve exceptional situational efficiency.

Strengths and limitations

This doctoral thesis has several strengths. On the one hand, according to the literature, there is little research investigating the influence of fatigue on kinematic parameters on basketball fundamental skills. This doctoral thesis objectively evaluates the influence of fatigue on players' fundamental skills, which could help coaches to better understand the movement pattern of passing, shooting, and dribbling and to design appropriate training sessions to resist the influence of fatigue on players' performance. Additionally, this research can help coaches in the selection of high-level basketball players. On the other hand, some new measurements were used together and synchronized to quantify kinematic parameters in this research. The MNV BIOMECH Awind inertial system (Xsens Technologies B.V., Enschede, The Netherlands) was employed in this doctoral thesis, which is more suited for field testing than previous methods and results in fewer biased data. There are also some strengths regarding the methodology of this doctoral thesis. In study 2, a shooting machine was used to standardize each pass directly influencing the shooting accuracy in order to minimize the interference from

external factors. In study 4, previous studies assessing the kinematic and physical parameters of a jump shot presented only shots taken without any action before shooting (dribbling or cutting—no pull-up jump shots or catch-and-shoot jump shots). Therefore, the jump shot protocol (catch-and-shoot situation after a cut), which is more similar to real game conditions, was conducted in this study.

In study 5, in addition to kinematic parameters, kinetic parameters were measured, which could help coaches and players to better understand the movement pattern of basketball dribbling. Additionally, the participants in this doctoral thesis were outside players (i.e., point guards, shooting guards, and small forwards) since they may have better performance, resulting in more objective results.

However, there are also a few limitations that need to be considered. First, in addition to main elements of passing, shooting and dribbling, fundamentals skills in basketball consist of many other elements. The influence of fatigue on kinematic parameters in other basketball fundamentals remains unexplored in this thesis. Second, in study 1, the study only focused on the technique of push passing, but the technique of other types of passing was not investigated. Additionally, the limitation of study 1 was the situation that the testing was performed without defensive players and the kinematic parameters and passing performance may be different. Third, in study 2, the players took jump shots from the stable spot with the interval of 5 s regarding testing protocol. To some extent, thereby, they were in recovery state from testing between each shot. Furthermore, the distance of jump shot in study 2 was relatively short (5 meters), and it is possible that players still had sufficient force through readjusting the flow of force in body segments to make a successful shot. Fourth, in study 3, considering that it was conducted with only one player as pilot research and in controlled environment, all the conclusions should be taken with caution. Fifth, in study 4, major limitation in this study is the lack of confounding variables such as morphological factors, which may affect the results. Sixth, in study 5, the players who play point guard, shooting guard, and small forward were volunteered to participate in the current study. Point guards may have a higher level of fitness related to dribbling because of their role related to dribbling. As a result, if all of the participants were point-guards, the data may be different.

Perspectives for future research

According to the limitations, it is recommended that future work should be undertaken to investigate the influence of fatigue on kinematic parameters in other basketball fundamentals, such as rebounds, defensive footwork etc. To be specific:

In study 1, other passing techniques such as chest or overhead passing are recommended for further analysis. Additionally, the defensive players can also be considered for the test protocol because it is more associated with the real game situation.

In study 2, a further study with more focus on dynamic jump shot (i.e., keep moving to catch the ball and take a shot) will need to be undertaken. Furthermore, it is worthwhile devoting effort to longer distance and complexity jump shots such as 3 points and jump shots with defender in terms of female basketball players.

In study 3, future research is required to recruit more volunteers to participate in testing.

In study 4, future studies should include morphological factors due to possible influence on the results. Further research in this area should focus on assessing the kinematic and physical parameters of the jump shot in situations that are more similar to real game conditions (e.g., pull-up jump shots, catch-and-shoot situations after a cut, defended shots).

In study 5, further research is recommended to investigate the same category of participants (i.e., investigating point guard or shooting guard or small forward independently) in terms of the current research topic.

Importantly, there is a lack of advanced technology that can evaluate player's skills in real game situations. Therefore, in the future, new technology is expected to be developed and used in real basketball games to evaluate basketball players of all age categories.

REFERENCES

- WORLD MEDICAL ASSOCIATION DECLARATION OF HELSINKI: ETHICAL PRINCIPLES FOR MEDICAL RESEARCH INVOLVING HUMAN SUBJECTS. 2013. *Jama*, 310, 2191-4.
- ABDELKRIM, N. B., EL FAZAA, S., EL ATI, J. 2007. Time-motion analysis and physiological data of elite under-19-year-old basketball players during competition. *British Journal of Sports Medicine*, 41(2), 69 –75.
- ABDELRASOUL, E., MAHMOUD, I., STERGIOU, P. & KATZ, L. 2015. The accuracy of a real time sensor in an instrumented basketball. *Procedia Engineering*, 112, 202-206.
- AHMED, T. 2013. The effect of upper extremity fatigue on grip strength and passing accuracy in junior basketball players. *Journal of Human Kinetics*, 37, 71-79.
- ALARCON, F., URENA, N. & CARDENAS, D. 2017. Mental fatigue impairs the basketball free-throw performance. *Revista De Psicologia Del Deporte*, 26, 33-36.
- ALLEN, D. G., LAMB, G. D., WESTERBLAD, H. 2008. Skeletal muscle fatigue: cellular mechanisms. *Physiological reviews*, 88(1), 287-332.
- ANDRIĆ, M. 2011. Analysis of frequency and efficiency of using dribble in the European basketball championship in Poland in 2009. *Fizička kultura*, 65, 52-59.
- ÁNGEL, G. M., EVANGELOS, T. & ALBERTO, L. 2006. Defensive systems in basketball ball possessions. *International Journal of Performance Analysis in Sport*, 6, 98-107.
- ANGEL GÓMEZ, M., LORENZO, A., SAMPAIO, J., IBÁÑEZ, S. J. & ORTEGA, E. 2008. Game-related statistics that discriminated winning and losing teams from the Spanish men's professional basketball teams. *Coll Antropol*, 32, 451-6.
- ARIAS, J. L. 2012. Performance as a function of shooting style in basketball players under 11 years of age. *Percept Mot Skills*, 114, 446-56.
- ARIAS, J. L., ARGUDO, F. M. & ALONSO, J. I. 2012. Effect of ball mass on dribble, pass, and pass reception in 9-11-year-old boys' basketball. *Res Q Exerc Sport*, 83, 407-12.
- ARIAS-ESTERO, J. L. 2013. Opportunities for and success in dribbling, passing, receiving, and shooting in youth basketball. *International Journal of Sports Science Coaching*, 8, 703-711.
- ARORA, S., BUDDEN, S., BYRNE, J. M. & BEHM, D. G. 2015. Effect of unilateral knee extensor fatigue on force and balance of the contralateral limb. *Eur J Appl Physiol*, 115, 2177-87.

- ARSLAN, Y. Z., KARABULUT, D., ORTES, F. & POPOVIC, M. B. 2019. 11 - Exoskeletons, exomusculatures, exosuits: dynamic modeling and simulation. *In: POPOVIC, M. B. (ed.) Biomechatronics. Academic Press.*
- ARYANTO, B., SUKOCO, P., LUMINTUARSO, R. J. I. J. O. H. M. & SCIENCES, S. 2020. The validity of construct analysis on assessment instrument of basketball skill for senior high school in Yogyakarta City. *International Journal of Human Movement and Sports Sciences*, 8, 193-198.
- BALSALOBRE-FERNÁNDEZ, C., BISHOP, C., BELTRÁN-GARRIDO, J. V., CECILIA-GALLEGO, P., CUENCA-AMIGÓ, A., ROMERO-RODRÍGUEZ, D. & MADRUGA-PARERA, M. 2019. The validity and reliability of a novel app for the measurement of change of direction performance. *Journal of sports sciences*, 37, 2420-2424.
- BARBIERI, F. A., RODRIGUES, S. T., POLASTRI, P. F., BARBIERI, R. A., DE PAULA, P. H. A., MILIONI, F., REDKVA, P. E. & ZAGATTO, A. M. 2017. High intensity repeated sprints impair postural control, but with no effects on free throwing accuracy, in under-19 basketball players. *Hum Mov Sci*, 54, 191-196.
- BECKER, S., FRÖHLICH, M., KELM, J., LUDWIG, O. 2017. Change of muscle activity as well as kinematic and kinetic parameters during headers after core muscle fatigue. *Sports*, 5(1), 10.
- BELIĆ, M., RADIN, L., BRKLJAČA BOTTEGARO, N., BEER, L., BLANKA, B. M., STANIN, D. & VRBANAC, Z. 2016. Reliability of lactate scout portable analyzer in agility dogs during multiple measurements. *Acta Veterinaria-Beograd*, 66, 549-555.
- BEN ABDELKRIM, N., CASTAGNA, C., JABRI, I., BATTIKH, T., EL FAZAA, S. & EL ATI, J. 2010. Activity profile and physiological requirements of junior elite basketball players in relation to aerobic-anaerobic fitness. *J Strength Cond Res*, 24, 2330-42.
- BEN ABDELKRIM, N., EL FAZAA, S. & EL ATI, J. 2007. Time-motion analysis and physiological data of elite under-19-year-old basketball players during competition. *Br J Sports Med*, 41, 69-75; discussion 75.
- BOCCOLINI, G., BRAZZIT, A., BONFANTI, L. & ALBERTI, G. 2013. Using balance training to improve the performance of youth basketball players. *Sport Sci Health*, 9, 37-42.
- BODDINGTON, B. J., CRIPPS, A. J., SCANLAN, A. T. & SPITERI, T. 2019. The validity and reliability of the Basketball Jump Shooting Accuracy Test. *J Sports Sci*, 37, 1648-1654.

- BOGDANIS, G. C., ZIAGOS, V., ANASTASIADIS, M. & MARIDAKI, M. 2007. Effects of two different short-term training programs on the physical and technical abilities of adolescent basketball players. *J Sci Med Sport*, 10, 79-88.
- BONFANTI, N. & LORENZO, A. 2015. Can the rate of perceived exertion and fatigue of one professional basketball player be modified through a long term nutritional intervention? *Revista De Psicologia Del Deporte*, 24, 9-12.
- BOROVIĆ, I., RUPČIĆ, T., ANTEKOLOVIĆ, LJ. 2015. Does active position of defender player change some kinematic parameters in jump shot? 25. *Ljetna škola kineziologa Republike Hrvatske*, 169-175.
- BRINI, S., BEN ABDERRAHMAN, A., BOULLOSA, D., HACKNEY, A. C., ZAGATTO, A. M., CASTAGNA, C., BOUASSIDA, A., GRANACHER, U. & ZOUHAL, H. 2020. Effects of a 12-week change-of-direction sprints training program on selected physical and physiological parameters in professional basketball male players. *Int J Environ Res Public Health*, 17.
- BUTTON, C., MACLEOD, M., SANDERS, R., COLEMAN, S. 2003. Examining movement variability in the basketball free-throw action at different skill levels. *Res. Q. Exerc. Sport*, 74, 257–269.
- CALÁBRIA-LOPES, M., GRECO, P. J. & PÉREZ-MORALES, J. C. 2019. Teaching games for understanding in basketball camp: the impact on process and product performance.[Teaching Games for Understanding en un campamento de baloncesto: impacto en el rendimiento del proceso y del producto]. *RICYDE. Revista Internacional de Ciencias del Deporte*, 15, 209-224.
- CALLEJA-GONZÁLEZ, J., TERRADOS, N., MIELGO-AYUSO, J., DELEXTRAT, A., JUKIC, I., VAQUERA, A., TORRES, L., SCHELLING, X., STOJANOVIC, M. & OSTOJIC, S. M. 2016. Evidence-based post-exercise recovery strategies in basketball. *Phys Sportsmed*, 44, 74-8.
- CALLISTER, R., MILLER, A., AGUIAR, E., DASCOMBE, B., SMITH, C., CLARK, L. & ROGERS, T. 2010. Blood lactate levels support classification of the 300 m shuttle run as an anaerobic capacity field test. *Journal of Science Medicine in Sport*, 13, e30-e31.
- CAPRINO, D., CLARKE, N. D. & DELEXTRAT, A. 2012. The effect of an official match on repeated sprint ability in junior basketball players. *J Sports Sci*, 30, 1165-73.
- CASTAGNA, C., MANZI, V., D'OTTAVIO, S., ANNINO, G., PADUA, E. & BISHOP, D. 2007. Relation between maximal aerobic power and the ability to repeat sprints in young basketball players. *J Strength Cond Res*, 21, 1172-6.

- CHASE, M. A., EWING, M. E., LIRGG, C. D. & GEORGE, T. R. 1994. The effects of equipment modification on children's self-efficacy and basketball shooting performance. *Res Q Exerc Sport*, 65, 159-68.
- CHEN, W. H., WU, H. J., LO, S. L., CHEN, H., YANG, W. W., HUANG, C. F. & LIU, C. 2018. Eight-week battle rope training improves multiple physical fitness dimensions and shooting accuracy in collegiate basketball players. *J Strength Cond Res*, 32, 2715-2724.
- CHRISTMANN, J., AKAMPHUBER, M., MÜLLENBACH, A. L. & GÜLLICH, A. 2018. Crunch time in the NBA—The effectiveness of different play types in the endgame of close matches in professional basketball. *International Journal of Sports Science Coaching*, 13, 1090-1099.
- CLEMENTE, F. M., MENDES, B., BREDT, S. D. T., PRACA, G. M., SILVERIO, A., CARRICO, S. & DUARTE, E. 2019. Perceived training load, muscle soreness, stress, fatigue, and sleep quality in professional basketball: a full season study. *Journal of Human Kinetics*, 67, 199-207.
- COHEN, J. Statistical power analysis for the behavioral sciences. 1988. 2nd ed.; Routledge Academic: New York, NY, USA,.
- CONTE, D., FAVERO, T. G., NIEDERHAUSEN, M., CAPRANICA, L. & TESSITORE, A. 2016. Effect of different number of players and training regimes on physiological and technical demands of ball-drills in basketball. *J Sports Sci*, 34, 780-6.
- CONTE, D., FAVERO, T. G., NIEDERHAUSEN, M., CAPRANICA, L. & TESSITORE, A. 2017. Determinants of the effectiveness of fast break actions in elite and sub-elite Italian men's basketball games. *Biol Sport*, 34, 177-183.
- CONTE, D., SCANLAN, A. T., DALBO, V. J., GANG, S. Z., SMITH, M. R., BIETKIS, T. & MATULAITIS, K. 2020. Dribble deficit quantifies dribbling speed independently of sprinting speed and differentiates between age categories in pre-adolescent basketball players. *Biol Sport*, 37, 261-267.
- CONTE, D., SMITH, M. R., SANTOLAMAZZA, F., FAVERO, T. G., TESSITORE, A. & COUTTS, A. 2019. Reliability, usefulness and construct validity of the Combined Basketball Skill Test (CBST). *Journal of sports sciences*, 37, 1205-1211.
- COOPER JOHN MILLER, S. D. 1975. *The theory and science of basketball*, London, Great Britain, Henry Kimpton.
- CORTES, N., ONATE, J. & MORRISON, S. 2014. Differential effects of fatigue on movement variability. *Gait & Posture*, 39, 888-893.

- CORTIS, C., TESSITORE, A., LUPO, C., PESCE, C., FOSSILE, E., FIGURA, F. & CAPRANICA, L. 2011. Inter-limb coordination, strength, jump, and sprint performances following a youth men's basketball game. *J Strength Cond Res*, 25, 135-42.
- CSATALJAY, G., O'DONOGHUE, P., HUGHES, M. & DANCS, H. 2009. Performance indicators that distinguish winning and losing teams in basketball. *International Journal of Performance Analysis in Sport*, 9, 60-66.
- DAL PUPO, J., DETANICO, D., ACHE-DIAS, J. & SANTOS, S. G. 2017. The fatigue effect of a simulated futsal match protocol on sprint performance and kinematics of the lower limbs. *J Sports Sci*, 35, 81-88.
- DANIA, A., HARVEY, S. J. J. O. P. E. & SPORT 2020. Teaching basketball to sampling-year athletes: A game-centered and situated learning perspective. *Journal of Physical Education and Sport*, 20, 529-538.
- DAVEY, P. R., THORPE, R. D. & WILLIAMS, C. 2002. Fatigue decreases skilled tennis performance. *Journal of Sports Sciences*, 20, 311-318.
- DELEXTRAT, A., GRUET, M. & BIEUZEN, F. 2018. Effects of small-sided games and high-intensity interval training on aerobic and repeated sprint performance and peripheral muscle oxygenation changes in elite junior basketball players. *J Strength Cond Res*, 32, 1882-1891.
- DELEXTRAT, A. & MARTINEZ, A. 2014. Small-sided game training improves aerobic capacity and technical skills in basketball players. *Int J Sports Med*, 35, 385-91.
- DENISA ZAMBOVÁ, L. U. T. N. 2012. An efficiency shooting program for youth basketball players. *SportLogia*, 8, 87-92.
- DICHARRY, J., 2010. Kinematics and kinetics of gait: from lab to clinic. *Clinics in sports medicine*, 29(3), pp.347-364.
- DICTIONARY, A. 2021. Fundamental skill. *APA Dictionary of Psychology*.
- DE OLIVEIRA, R. F., HUYS, R., OUDEJANS, R. R., VAN DE LANGENBERG, R., & BEEK, P. J. 2007. Basketball jump shooting is controlled online by vision. *Experimental psychology*, 54(3), 180–186. <https://doi.org/10.1027/1618-3169.54.3.180>
- DOBOVIČNIK, L., JAKOVLJEVIĆ, S., ZOVKO, V., ERČULJ, F. 2015. Determination of the optimal certain kinematic parameters in basketball three-point shooting using the 94fifty technology. *Phys. Cult. Fiz. Kult.* 69, 5–13.

- DOS SANTOS, F. G., PACHECO, M. M., BASSO, L., BASTOS, F. H. & TANI, G. 2020. Development and validation of a checklist to assess proficient performance of basketball straight speed dribbling skill. *J Hum Kinet*, 71, 21-31.
- DOYLE, B., BROWNE, D. & HORAN, D. 2020. The relationship of aerobic endurance and linear speed on repeat sprint ability performance in female international footballers. *International Journal of Human Movement and Sports Sciences*, 8, 147-153.
- DRINKWATER, E. J., PYNE, D. B. & MCKENNA, M. J. 2008. Design and interpretation of anthropometric and fitness testing of basketball players. *Sports Med*, 38, 565-78.
- EDWARDS, T., SPITERI, T., PIGGOTT, B., BONHOTAL, J., HAFF, G. G. & JOYCE, C. 2018. Monitoring and managing fatigue in basketball. *Sports*, 6.
- ELLIOTT, B. 1992. A kinematic comparison of the male and female two-point and three-point jump shots in basketball. *The Australian Journal of Science Medicine in Sport*, 24, 111-118.
- ELLIOTT, B., WHITE, E.J.T.A.J.O.S., SPORT, M.I. 1989. A kinematic and kinetic analysis of the female two point and three point jump shots in basketball. 21, 7-11.
- ELVAN, A. & OZYUREK, S. 2020. Chapter 2 - Principles of kinesiology. In: ANGIN, S. & ŞİMŞEK, I. E. (eds.) *Comparative Kinesiology of the Human Body*. Academic Press.
- ENOKA, R. M. 1995. Mechanisms of muscle fatigue: Central factors and task dependency. *Journal of Electromyography and Kinesiology*, 5, 141-149.
- ENOKA, R. M. & DUCHATEAU, J. 2008. Muscle fatigue: what, why and how it influences muscle function. *J Physiol*, 586, 11-23.
- ENOKA, R. M. & DUCHATEAU, J. 2016. Translating fatigue to human performance. *Medicine and Science in Sports and Exercise*, 48, 2228-2238.
- ERČULJ, F., BLAS, M. & BRAČIČ, M. 2010. Physical demands on young elite European female basketball players with special reference to speed, agility, explosive strength, and take-off power. *J Strength Cond Res*, 24, 2970-8.
- ERCULJ, F. & SUPEJ, M. 2009. Impact of fatigue on the position of the release arm and shoulder girdle over a longer shooting distance for an elite basketball player. *J Strength Cond Res*, 23, 1029-36.
- ERČULJ, F. & SUPEJ, M. 2006. The impact of fatigue on jump shot height and accuracy over a longer shooting distance in basketball. *UGDYMAS • KŪNO KULTŪRA • SPORTAS*, 4, 35-41.
- EVANGELOS, T., ALEXANDROS, K. & NIKOLAOS, A. J. I. J. O. P. A. I. S. 2005. Analysis of fast breaks in basketball. 5, 17-22.

- FONTANELLA, J. J. 2006. The physics of basketball. The Johns Hopkins University Press.
- FORESTIER, N. & NOUGIER, V. 1998. The effects of muscular fatigue on the coordination of a multijoint movement in human. *Neuroscience Letters*, 252, 187-190.
- FRANÇA, C., GOMES, B. B., GOUVEIA É, R., IHLE, A. & COELHO, E. S. M. J. 2021. The jump shot performance in youth basketball: a systematic review. *Int J Environ Res Public Health*, 18.
- FUJII, K., YAMADA, Y. & ODA, S. 2010. Skilled basketball players rotate their shoulders more during running while dribbling. *Percept Mot Skills*, 110, 983-94.
- GARCÍA, J., IBÁÑEZ, S. J., DE SANTOS, R. M., LEITE, N. & SAMPAIO, J. 2013. Identifying basketball performance indicators in regular season and playoff games. *Journal of Human Kinetics*, 36, 161-168.
- GÒMEZ, M.-Á., LORENZO, A., ORTEGA, E., SAMPAIO, J. & IBÁÑEZ, S. J. 2009. Game related statistics discriminating between starters and nonstarters players in Women's National Basketball Association League (WNBA). *Journal of Sports Science & Medicine*, 8, 278.
- GÓMEZ, M. Á., LORENZO, A., JIMÉNEZ, S., NAVARRO, R. M. & SAMPAIO, J. 2015. Examining choking in basketball: effects of game outcome and situational variables during last 5 minutes and overtimes. *Perceptual and Motor Skills*, 120, 111-124.
- GORMAN, A.D., MALONEY, M.A. 2016. Representative design: Does the addition of a defender change the execution of a basketball shot? *Psychol. Sport Exerc*, 27, 112–119.
- GUIMARÃES, E., BAXTER-JONES, A., MAIA, J., FONSECA, P., SANTOS, A., SANTOS, E., TAVARES, F. & JANEIRA, M. A. 2019. The roles of growth, maturation, physical fitness, and technical skills on selection for a portuguese under-14 years basketball team. *Sports (Basel)*, 7.
- GUNDERSEN, L. A., VALLE, D. R., BARR, A. E., DANOFF, J. V., STANHOPE, S. J. & SNYDER-MACKLER, L. 1989. Bilateral analysis of the knee and ankle during gait: an examination of the relationship between lateral dominance and symmetry. *Phys Ther*, 69, 640-50.
- HALL, S. J. 2015. *Basic biomechanics*, McGraw-Hill Education.
- HAY, J. G. 1985. The biomechanics of sports techniques. N.J.: Prentice – Hall.
- HESS, C. 1980. Analysis of the jump shot. *Athletic Journal*, 61(3), 30 - 33, 37 - 38, 58.
- HINDE, K., WHITE, G. & ARMSTRONG, N. 2021. Wearable devices suitable for monitoring twenty four hour heart rate variability in military populations. *Sensors (Basel)*, 21, 1061.

- HOPKINS, W. G., MARSHALL, S. W., BATTERHAM, A. M., & HANIN, J. 2009. Progressive statistics for studies in sports medicine and exercise science. *Medicine and science in sports and exercise*, 41(1), 3–13.
- HU, X., MO, S. & QU, X. 2020. Basketball activity classification based on upper body kinematics and dynamic time warping. *International Journal of Sports Medicine*, 41, 255-263.
- HUDSON, J. L. 1986. Coordination of segments in the vertical jump. *Medicine & Science in Sports & Exercise*.
- IBÁÑEZ, S. J., GARCÍA, J., FEU, S., LORENZO, A. & SAMPAIO, J. 2009. Effects of consecutive basketball games on the game-related statistics that discriminate winner and losing teams. *J Sports Sci Med*, 8, 458-62.
- IBÁÑEZ, S. J., SAMPAIO, J., FEU, S., LORENZO, A., GÓMEZ, M. A. & ORTEGA, E. 2008. Basketball game-related statistics that discriminate between teams' season-long success. *European Journal of Sport Science*, 8, 369-372.
- JAKOVLJEVIĆ, S., KARALEJIĆ, M., IVANOVIĆ, J., ŠTRUMBELJ, E. & ERČULJ, F. 2017. Efficiency of speed and agility dribbling of young basketball players. *Kinesiologia Slovenica*, 23, 22-32.
- JANICIJEVIC, D., KNEZEVIC, O. M., MIRKOV, D. M., PÉREZ-CASTILLA, A., PETROVIC, M., SAMOZINO, P. & GARCIA-RAMOS, A. 2020. Assessment of the force-velocity relationship during vertical jumps: influence of the starting position, analysis procedures and number of loads. *Eur J Sport Sci*, 20, 614-623.
- JARIĆ, S., RADOVANOVIĆ, S., MILANOVIĆ, S., LJUBISAVLJEVIĆ, M. & ANASTASIJEVIĆ, R. 1997. A comparison of the effects of agonist and antagonist muscle fatigue on performance of rapid movements. *Eur J Appl Physiol Occup Physiol*, 76, 41-7.
- JEFFRIES, A. C., MARCORA, S. M., COUTTS, A. J., WALLACE, L., MCCALL, A. & IMPELLIZZERI, F. M. Development of a revised conceptual framework of physical training for use in research and practice. *Sports Medicine*.
- KAESAMAN, N. & EUNGPINICHPONG, W. 2019. The acute effect of traditional thai massage on recovery from fatigue in basketball players. *International Journal of Geomate*, 16, 53-58.
- KAURANEN, K. J., SIIRA, P. T. & VANHARANTA, H. V. 1998. A 10-week strength training program: effect on the motor performance of an unimpaired upper extremity. *Arch Phys Med Rehabil*, 79, 925-30.

- KAZEM, A. Q., JOMAA, A. H. & HAMID, A. S. 2021. The effect of using homogeneous small groups in learning basketball passing and shooting from stability for female students. *Karbala Magazine of Physical Edu. Sciences*, 6.
- KHLIFA, R., AOUADI, R., HERMASSI, S., CHELLY, M.S., JLID, C., GABBETT, T.J. 2012. Kinematic adjustments in the basketball free throw performed with a reduced hoop diameter rim. *Int. J. Sports Sci. Coach*, 7, 371–382.
- KIOUMOURTZOGLOU, E., DERRI, V., TZETZIS, G. & THEODORAKIS, Y. 1998. Cognitive, perceptual, and motor abilities in skilled basketball performance. *Percept Mot Skills*, 86, 771-86.
- KNJAZ, D. 2000. *Passing in basketball game*. Faculty for Physical Education, University of Zagreb.
- KNUDSON, D. 1993. Biomechanics of the basketball jump shot—Six key teaching points. *Journal of Physical Education, Recreation Dance*, 64, 67-73.
- KRAUSE, J., MEYER, D. & MEYER, J. 2008. *Basketball Skills and Drills*, USA, Human Kinetics.
- KRAUSE, J. V. & NELSON, C. 2018. *Basketball skills & drills*, USA, Human Kinetics.
- LAFOND, D., DUARTE, M. & PRINCE, F. 2004. Comparison of three methods to estimate the center of mass during balance assessment. *J Biomech*, 37, 1421-6.
- LAKENS D. 2013. Calculating and reporting effect sizes to facilitate cumulative science: a practical primer for t-tests and ANOVAs. *Frontiers in psychology*, 4, 863.
- LAM, W. K., MAXWELL, J. P. & MASTERS, R. S. 2009. Analogy versus explicit learning of a modified basketball shooting task: performance and kinematic outcomes. *J Sports Sci*, 27, 179-91.
- LEHANE, J. 1981. *Basketball Fundamentals: teaching techniques for winning*, Boston, Allyn & Bacon.
- LENIK, P., LENIK, J. 2016. The point system and kinematic parameters analysis of free throw with the use of “94fifty smart basketball” testing tool. *Scientific Review of Physical Culture*, 6 (4).
- LEONOV, A. & MALVIZ, A. A. 1990. *Basketball for children*, Thessaloniki, Salto publ.
- LESSI, G. C., DOS SANTOS, A. F., BATISTA, L. F., DE OLIVEIRA, G. C. & SERRÃO, F. V. 2017. Effects of fatigue on lower limb, pelvis and trunk kinematics and muscle activation: gender differences. *Journal of Electromyography Kinesiology*, 32, 9-14.
- LESSI, G. C. & SERRÃO, F. V. 2017. Effects of fatigue on lower limb, pelvis and trunk kinematics and lower limb muscle activity during single-leg landing after anterior

- cruciate ligament reconstruction. *Knee Surgery, Sports Traumatology, Arthroscopy*, 25, 2550-2558.
- LI, F., KNJAZ, D. & RUPČIĆ, T. 2021. Influence of fatigue on some kinematic parameters of basketball passing. *Int J Environ Res Public Health*, 18.
- LI, F., LI, Z., BOROVIĆ, I., RUPČIĆ, T. & KNJAZ, D. 2021. Does fatigue affect the kinematics of shooting in female basketball? *International Journal of Performance Analysis in Sport*, 1-13.
- LI, F., RUPČIĆ, T. & KNJAZ, D. 2021. The Effect of Fatigue on Kinematics and Kinetics in Basketball Dribbling with Changes of Direction. *Kinesiology*, 53(2), 296-308.
- LORENZO, A., GÓMEZ, M., ORTEGA, E., IBÁÑEZ, S. J. & SAMPAIO, J. 2010. Game related statistics which discriminate between winning and losing under-16 male basketball games. *J Sports Sci Med*, 9, 664-8.
- LYONS, M., AL-NAKEEB, Y. & NEVILL, A. 2006. The impact of moderate and high intensity total body fatigue on passing accuracy in expert and novice basketball players. *Journal of Sports Science & Medicine*, 5, 215.
- MADUENO, M. C., DALBO, V. J., GUY, J. H., GIAMARELOS, K. E., SPITERI, T. & SCANLAN, A. T. 2018. Reduced fatigue in passive versus active recovery: an examination of repeated-change-of-direction sprints in basketball players. *International Journal of Sports Physiology and Performance*, 13, 1034-1041.
- MAIMÓN, A. Q., COUREL-IBÁÑEZ, J. & RUÍZ, F. J. R. J. J. O. H. K. 2020. The basketball pass: A systematic review. 71, 275.
- MANCHA-TRIGUERO, D., GARCÍA-RUBIO, J., CALLEJA-GONZÁLEZ, J. & IBÁÑEZ, S. J. 2019. Physical fitness in basketball players: a systematic review. *J Sports Med Phys Fitness*, 59, 1513-1525.
- MANCHA-TRIGUERO, D., GARCÍA-RUBIO, J., GAMONALES, J. M. & IBÁÑEZ, S. J. 2021. Strength and speed profiles based on age and sex differences in young basketball players. *Int J Environ Res Public Health*, 18.
- MANZI, V., D'OTTAVIO, S., IMPELLIZZERI, F. M., CHAOUACHI, A., CHAMARI, K. & CASTAGNA, C. 2010. Profile of weekly training load in elite male professional basketball players. *J Strength Cond Res*, 24, 1399-406.
- MARCOLIN, G., CAMAZZOLA, N., PANIZZOLO, F. A., GRIGOLETTO, D. & PAOLI, A. 2018. Different intensities of basketball drills affect jump shot accuracy of expert and junior players. *PeerJ*, 6, e4250.

- MARKOVIC, G., DIZDAR, D. & JARIC, S. 2006. Evaluation of tests of maximum kicking performance. *J Sports Med Phys Fitness*, 46, 215-20.
- MATTHEW, D. & DELESTRAT, A. 2009. Heart rate, blood lactate concentration, and time–motion analysis of female basketball players during competition. *Journal of sports sciences*, 27, 813-821.
- MATULAITIS, K. & BIETKIS, T. 2021. Prediction of offensive possession ends in elite basketball teams. *Int J Environ Res Public Health*, 18.
- MCINNES, S. E., CARLSON, J. S., JONES, C. J. & MCKENNA, M. J. 1995. The physiological load imposed on basketball players during competition. *J Sports Sci*, 13, 387-97.
- MECKEL, Y., GOTTLIEB, R. & ELIAKIM, A. 2009. Repeated sprint tests in young basketball players at different game stages. *Eur J Appl Physiol*, 107, 273-9.
- MCGINNIS, P.M., 2013. Biomechanics of sport and exercise. Human Kinetics.
- MILANOVIĆ, D., SELMANOVIĆ, A. & ŠKEGRO, D. Characteristics and differences of basic types of offenses in European and American top-level basketball. 7th International Scientific Conference on Kinesiology, 2014. 400.
- MILLER, S. & BARTLETT, R. 1996. The relationship between basketball shooting kinematics, distance and playing position. *J Sports Sci*, 14, 243-53.
- MILLER, S. & BARTLETT, R. M. 1993. The effects of increased shooting distance in the basketball jump shot. *Journal of Sports Sciences*, 11, 285-293.
- MONTESANO, P., TAFURI, D. & MAZZEO, F. 2013. Improvement of the motor performance difference in athletes of wheelchair Basketball. *Journal of Physical Education Sport Scientific And Practical Aspects*, 13, 362.
- MONTGOMERY, P. G., PYNE, D. B., HOPKINS, W. G., DORMAN, J. C., COOK, K. & MINAHAN, C. L. 2008. The effect of recovery strategies on physical performance and cumulative fatigue in competitive basketball. *Journal of Sports Sciences*, 26, 1135-1145.
- MONTGOMERY, P. G., PYNE, D. B. & MINAHAN, C. L. 2010. The physical and physiological demands of basketball training and competition. *Human kinetics journals*, 5, 75-86.
- MOREIRA, A., MCGUIGAN, M. R., ARRUDA, A. F., FREITAS, C. G. & AOKI, M. S. 2012. Monitoring internal load parameters during simulated and official basketball matches. *J Strength Cond Res*, 26, 861-6.

- MORIN, J.-B., SAMOZINO, P., EDOUARD, P. & TOMAZIN, K. 2011. Effect of fatigue on force production and force application technique during repeated sprints. *Journal of Biomechanics*, 44, 2719-2723.
- MULAZIMOGLU, O., YANAR, S., TUNCA EVCIL, A. & DUVAN, A. 2017. Examining the effect of fatigue on shooting accuracy in young basketball players. *The Anthropologist*, 27, 77-80.
- NAKANO, N., FUKASHIRO, S. & YOSHIOKA, S. 2020. The effect of increased shooting distance on energy flow in basketball jump shot. *Sports Biomechanics*, 19, 366-381.
- NARAZAKI, K., BERG, K., STERGIOU, N. & CHEN, B. 2009. Physiological demands of competitive basketball. *Scandinavian Journal of Medicine & Science in Sports*, 19, 425-432.
- NEUMANN, D. A. 2016. *Kinesiology of the musculoskeletal system-e-book: foundations for rehabilitation*, Elsevier Health Sciences.
- NEZHAD, V. S., RAHIMI, A., SARSHIN, A. 2015. Effect of fatigue on body joints kinematic in 3 points jump shot among basketball player young boys. *Biological Forum—An International Journal*, 7, 1910-1914.
- NORDIN, M. & FRANKEL, V. H. 2001. *Basic biomechanics of the musculoskeletal system*, Lippincott Williams & Wilkins.
- NUNES, H., IGLESIAS, X., DAZA, G., IRURTIA, A., CAPARRÓS, T. & ANGUERA, M. 2016. The influence of pick and roll in attacking play in top-level basketball. *Cuadernos de Psicología Del Deporte*, 16, 129-142.
- OKAZAKI, V. H. A. & RODACKI, A. L. F. 2012. Increased distance of shooting on basketball jump shot. *Journal of sports science medicine*, 11, 231-237.
- OKAZAKI, V. H. A. & RODACKI, A. L. F. 2018. Basketball jump shot performed by adults and children. *Human movement*, 19, 71-79.
- OKAZAKI, V. H., RODACKI, A. L., & SATERN, M. N. 2015. A review on the basketball jump shot. *Sports biomechanics*, 14(2), 190–205.
- OKAZAKI, V. H. A., OKAZAKI, F. H. A., SASAKI, J. E., KELLER, B. 2007. Speed-accuracy relationship in basketball shoot. *The Fiep Bulletin*, 77, 745-747.
- OKOROHA, K. R., LIZZIO, V. A., META, F., AHMAD, C. S., MOUTZOUROS, V. & MAKHNI, E. C. 2018. Predictors of elbow torque among youth and adolescent baseball pitchers. *Am J Sports Med*, 46, 2148-2153.
- OKUBO, H. & HUBBARD, M. 2015. Kinematics of arm joint motions in basketball shooting. *Procedia Engineering*, 112, 443-448.

- OUDEJANS, R. R. D, KARAMAT, R. S. & STOLK, M. H. 2012. Effects of actions preceding the jump shot on gaze behavior and shooting performance in elite female basketball players. *International Journal of Sports Science Coaching*, 7, 255-267.
- OUDEJANS, R.R.D. 2012. Effects of visual control training on the shooting performance of elite female basketball players. *Int. J. Sports Sci. Coach*, 7, 469–480.
- PAPPAS, E. & CARPES, F. P. 2012. Lower extremity kinematic asymmetry in male and female athletes performing jump-landing tasks. *J Sci Med Sport*, 15, 87-92.
- PATE, T. R. 2000. A conditioning program to increase vertical jump. *Strength and Conditioning Journal*, 22, 7-11.
- PATRONA, F., CHATZITOFIS, A., ZARPALAS, D. & DARAS, P. 2018. Motion analysis: Action detection, recognition and evaluation based on motion capture data. *Pattern Recognition*, 76, 612-622.
- PERALTA-GEIS, M., ARBOIX-ALIO, J., SANROMA, J. C. & AGULLED, R. M. 2021. Influence of fatigue in decision-making in football referees. *Sport Tk-Revista Euroamericana De Ciencias Del Deporte*, 10, 164-175.
- PODMENIK, N., LESKOŠEK, B. & ERČULJ, F. 2012. The effect of introducing a smaller and lighter basketball on female basketball players' shot accuracy. *J Hum Kinet*, 31, 131-7.
- PODMENIK, N., SUPEJ, M., ČOH, M., ERČULJ, F. 2017. The effect of shooting range on the dynamics of limbs angular velocities of the basketball shot. *Kinesiology*, 49, 92-100.
- PODMENIK, N.; SUPEJ, M.; KUGOVNIK, O.; ERČULJ, F. 2015. Movement of the body's centre of mass during a jump shot related to the distance from the basket of young players. *Kinesiol. Slov*, 21, 21–33.
- POJSKIĆ, H., ŠEPAROVIĆ, V., MURATOVIĆ, M. & UŽIČANIN, E. 2014. The relationship between physical fitness and shooting accuracy of professional basketball players. *Motriz: Revista de Educação Física*, 20, 408-417.
- POJSKIC, H., SISIC, N., SEPAROVIC, V. & SEKULIC, D. 2018. Association between conditioning capacities and shooting performance in professional basketball players: an analysis of stationary and dynamic shooting skills. *J Strength Cond Res*, 32, 1981-1992.
- PORTER, C., GREENWOOD, D., PANCHUK, D. & PEPPING, G. J. 2020. Learner-adapted practice promotes skill transfer in unskilled adults learning the basketball set shot. *Eur J Sport Sci*, 20, 61-71.
- QUÍLEZ-MAIMÓN, A., ROJAS-RUIZ, F. J., DELGADO-GARCÍA, G. & COUREL-IBÁÑEZ, J. 2021. The Q-pass index: a multifactorial imu-based tool to assess passing skills in basketball. *Sensors (Basel)*, 21, 4601.

- RAGHU, S. L., CONNERS, R. T., KANG, C.-K., LANDRUM, D. B. & WHITEHEAD, P. N. 2021. Kinematic analysis of gait in an underwater treadmill using land-based Vicon T 40s motion capture cameras arranged externally. *Journal of Biomechanics*, 124, 110553.
- RASHID, D. M. S., FARAJ, S. M. S. & HEDAYATPOUR, N. 2020. The effect of triceps brachii fatigue on shot accuracy of male and female basketball players. *International Journal of Performance Analysis in Sport*, 20, 206-218.
- REILLY, T., DRUST, B. & CLARKE, N. 2008. Muscle fatigue during football match-play. *Sports Medicine*, 38, 357-367.
- RICHARDSON, J.T.E. 2011. Eta squared and partial eta squared as measures of effect size in educational research. *Educ. Res. Rev*, 6, 135–147.
- ROAD, R. 2021. *Basketball Passing* [Online]. Rookie Road. [Accessed].
- ROBALO, R. A. M., DINIZ, A., FERNANDES, O. & PASSOS, P. J. M. 2020. The role of variability in the control of the basketball dribble under different perceptual setups. *Eur J Sport Sci*, 1-10.
- ROBERT-LACHAINE, X., MECHERI, H., LARUE, C. & PLAMONDON, A. 2017. Validation of inertial measurement units with an optoelectronic system for whole-body motion analysis. *Medical & Biological Engineering & Computing*, 55, 609-619.
- RODRIGUEZ-ALONSO, M., FERNANDEZ-GARCIA, B., PEREZ-LANDALUCE, J., TERRADOS, N. 2003. Blood lactate and heart rate during national and international women's basketball. *The Journal of Sports Medicine and Physical Fitness*, 43: 432-436.
- ROJAS, F. J., CEPERO, M., OÑA, A. & GUTIERREZ, M. 2000. Kinematic adjustments in the basketball jump shot against an opponent. *Ergonomics*, 43, 1651-60.
- ROSE, L. 2012. *Winning basketball fundamentals*, Human Kinetics.
- RUPČIĆ, T., ANTEKOLOVIĆ, L., KNJAZ, D., MATKOVIĆ, B. & CIGROVSKI, V. Reliability analysis of the 94 fifty smart sensor basketball. 10th International Conference On Kinanthropology, 2016. 432-438.
- RUPČIĆ, T., FENG, L., MATKOVIĆ, B. R., KNJAZ, D., DUKARIĆ, V., BAKOVIĆ, M., MATKOVIĆ, A., SVOBODA, I., VAVAČEK, M. & GARAFOLIĆ, H. 2020. The impact of progressive physiological loads on angular velocities during shooting in basketball-case study. *Acta Kinesiologica*, 14, 102-109.
- RUPČIĆ, T., KNJAZ, D., BAKOVIĆ, M., DEVRNJA, A. & MATKOVIĆ, B. J. H. Š. V. 2015. Impact of fatigue on accuracy and changes in certain kinematic parameters during shooting in basketball. *Hrvatski športskomedicinski vjesnik*, 30, 15-20.

- SAMPAIO, J., MCGARRY, T., CALLEJA-GONZÁLEZ, J., JIMÉNEZ SÁIZ, S., SCHELLING, I. D. A. X. & BALCIUNAS, M. 2015. Exploring game performance in the national basketball association using player tracking data. *PLoS One*, 10, e0132894.
- SATERN, M. Kinematic parameters of basketball jump shots projected from varying distances. ISBS-Conference Proceedings Archive, 1993.
- SCANLAN, A., DASCOTBE, B. & REABURN, P. 2011. A comparison of the activity demands of elite and sub-elite Australian men's basketball competition. *J Sports Sci*, 29, 1153-60.
- SCANLAN, A. T., DALBO, V. J., CONTE, D., STOJANOVIĆ, E., STOJILJKOVIĆ, N., STANKOVIĆ, R., ANTIĆ, V. & MILANOVIĆ, Z. 2019. Caffeine supplementation has no effect on dribbling speed in elite basketball players. *Int J Sports Physiol Perform*, 14, 997-1000.
- SCANLAN, A. T., DASCOTBE, B. J., KIDCAFF, A. P., PEUCKER, J. L. & DALBO, V. J. 2015. Gender-specific activity demands experienced during semiprofessional basketball game play. *International Journal of Sports Physiology Performance*, 10, 618-625.
- SCANLAN, A. T., TUCKER, P. S., DASCOTBE, B. J., BERKELMANS, D. M., HISKENS, M. I. & DALBO, V. J. 2015. Fluctuations in activity demands across game quarters in professional and semiprofessional male basketball. *The Journal of Strength Conditioning Research*, 29, 3006-3015.
- SEITZ, L. B., RIVIÈRE, M., DE VILLARREAL, E. S. & HAFF, G. G. 2014. The athletic performance of elite rugby league players is improved after an 8-week small-sided game training intervention. *J Strength Cond Res*, 28, 971-5.
- SEKULIC, D., PEHAR, M., KROLO, A., SPASIC, M., ULJEVIC, O., CALLEJA-GONZÁLEZ, J. & SATTTLER, T. 2017. Evaluation of basketball-specific agility: applicability of preplanned and nonplanned agility performances for differentiating playing positions and playing levels. *J Strength Cond Res*, 31, 2278-2288.
- SHARPE, M. & WILKS, D. 2002. Fatigue. *BMJ*, 325, 480-483.
- SHERWOOD, D. E., SCHMIDT, R. A. & WALTER, C. B. 1988. The force/force-variability relationship under controlled temporal conditions. *J Mot Behav*, 20, 106-16.
- SILVA, L. C. D., PEREIRA-MONFREDINI, C. F. & TEIXEIRA, L. A. 2017. Improved children's motor learning of the basketball free shooting pattern by associating subjective error estimation and extrinsic feedback. *J Sports Sci*, 35, 1-6.

- SINGER, H. S., MINK, J. W., GILBERT, D. L. & JANKOVIC, J. 2016. Chapter 5 - Motor Assessments. In: SINGER, H. S., MINK, J. W., GILBERT, D. L. & JANKOVIC, J. (eds.) *Movement Disorders in Childhood (Second Edition)*. Boston: Academic Press.
- SLAVKO, T. 2000. *Recognizing, evaluation and encourageing the elite basketball players*, Zagreb, Croatia, Croatian Basketball Federation.
- SLAWINSKI, J., LOUIS, J., POLI, J., TIOLLIER, E., KHAZOOM, C. & DINU, D. 2018. The effects of repeated sprints on the kinematics of 3-point shooting in basketball. *Journal of human kinetics*, 62, 5-14.
- SLAWINSKI, J., POLI, J., KARGANOVIC, S., KHAZOOM, C. & DINU, D. Effect of fatigue on basketball three points shot kinematics. ISBS-Conference Proceedings Archive, 2015.
- SORRENTINO, I., ANDRADE CHAVEZ, F. J., LATELLA, C., FIORIO, L., TRAVERSARO, S., RAPETTI, L., TIRUPACHURI, Y., GUEDELHA, N., MAGGIALI, M., DUSSONI, S., METTA, G. & PUCCI, D. 2020. A novel sensorised insole for sensing feet pressure distributions. *Sensors (Basel)*, 20.
- SPEER, K. E., SEMPLE, S., NAUMOVSKI, N. & MCKUNE, A. J. 2020. Measuring heart rate variability using commercially available devices in healthy children: A validity and reliability study. *European Journal of Investigation in Health, Psychology Education*, 10, 390-404.
- SPITERI, T., COCHRANE, J. L., HART, N. H., HAFF, G. G. & NIMPHIUS, S. 2013. Effect of strength on plant foot kinetics and kinematics during a change of direction task. *Eur J Sport Sci*, 13, 646-52.
- SPITERI, T., NIMPHIUS, S., HART, N. H., SPECOS, C., SHEPPARD, J. M. & NEWTON, R. U. 2014. Contribution of strength characteristics to change of direction and agility performance in female basketball athletes. *J Strength Cond Res*, 28, 2415-23.
- SPORIŠ, G., VUČETIĆ, V., MILANOVIĆ, L., MILANOVIĆ, Z., KRESPI, M. & KRAKAN, I. 2014. A comparison anaerobic endurance capacity in elite soccer, handball and basketball players. *Kinesiology*, 46, 52-59.
- STOJANOVIC, M. D., OSTOJIC, S. M., CALLEJA-GONZÁLEZ, J., MILOSEVIC, Z. & MIKIC, M. 2012. Correlation between explosive strength, aerobic power and repeated sprint ability in elite basketball players. *J Sports Med Phys Fitness*, 52, 375-81.
- STOJANOVIĆ, E., STOJILJKOVIĆ, N., SCANLAN, A. T., DALBO, V. J., BERKELMANS, D. M., & MILANOVIĆ, Z. 2018. The activity demands and physiological responses

- encountered during basketball match-play: a systematic review. *Sports medicine (Auckland, N.Z.)*, 48(1), 111–135.
- STRICKER, G., SCHEIBER, P., LINDENHOFER, E. & MÜLLER, E. 2010. Determination of forces in alpine skiing and snowboarding: Validation of a mobile data acquisition system. *European Journal of Sport Science*, 10, 31-41.
- STRUZIK, A., PIETRASZEWSKI, B. & ZAWADZKI, J. 2014. Biomechanical analysis of the jump shot in basketball. *J Hum Kinet*, 42, 73-9.
- SUFYANDI, A., SULAIMAN, S. & SOEGIYANTO, S. 2019. The effects of hand-eye coordination on basketball passing at publicsenior high school 1 lasem. *Journal of Physical Education Sports*, 8.
- SUMMIT PH, J. D. 1996. *Basketball: fundamental and tema play*, Boston, McGraw_Hill Companies.
- SVOBODA, I., KNJA , D., BAKOVIĆ, M., MATKOVIĆ, B., PRLENDA, N. 2016. Differences in some kinematic parameters during shooting from distance of 6,25 m and 6,75m. 25. *Ljetna škola kineziologa Republike Hrvatske*, 279-284.
- TANNER, R. K., FULLER, K. L. & ROSS, M. L. 2010. Evaluation of three portable blood lactate analysers: Lactate Pro, Lactate Scout and Lactate Plus. *European journal of applied physiology*, 109, 551-559.
- TAYLOR, J. 2003. Basketball: Applying time motion data to conditioning. *Strength and Conditioning Journal*, 25, 57-64.
- Teams Shooting. Available online: <http://stats.nba.com/teams/shooting/> (accessed on 18 October 2017).
- THEOHAROPOULOS, A., LAPARIDIS, K. K., GALAZOULAS, C. & TSITSKARIS, G. 2010. A comparative study relating pass between male and female basketball players. *Journal of Physical Education & Sport*, 26.
- THORLUND, J. B., MICHALSIK, L. B., MADSEN, K. & AAGAARD, P. 2008. Acute fatigue-induced changes in muscle mechanical properties and neuromuscular activity in elite handball players following a handball match. *Scandinavian Journal of Medicine & Science in Sports*, 18, 462-472.
- THORPE, R. T., ATKINSON, G., DRUST, B. & GREGSON, W. 2017. Monitoring fatigue status in elite team-sport athletes: implications for practice. *Int J Sports Physiol Perform*, 12, S227-s234.
- TONON, B. A., GOUTHON, P. N., NIGAN, I. B., AKPATCHI, R. V. & NOUATIN, B. K. 2020. Changes in selected physiological parameters following a training block of

- specific circuit training among national top-level basketball players. *Int J Exerc Sci*, 13, 1156-1166.
- TORRES-RONDA, L., RIC, A., LLABRES-TORRES, I., DE LAS HERAS, B. & SCHELLING, I. D. A. X. 2016. Position-dependent cardiovascular response and time-motion analysis during training drills and friendly matches in elite male basketball players. *J Strength Cond Res*, 30, 60-70.
- TRAN, C. M. & SILVERBERG, L. M. 2008. Optimal release conditions for the free throw in men's basketball. *J Sports Sci*, 26, 1147-55.
- TRNINIĆ, S., DIZDAR, D. & LUKSIĆ, E. 2002. Differences between winning and defeated top quality basketball teams in final tournaments of European club championship. *Coll Antropol*, 26, 521-31.
- TRNINIC, S., MARKOVIC, G. & HEIMER, S. 2001. Effects of developmental training of basketball cadets realised in the competitive period. *Collegium Antropologicum*, 25, 591-604.
- TRNINIĆ, S., TRNINIĆ, M. & JELASKA, I. 2010. Hierarchical structuration of knowledge in the basketball game. *Acta Kinesiologica*, 4, 37.
- TSAI, C., HO, W. H., LII, Y. K., HUANG, C. H. 2006. The kinematic analysis of basketball three-point shoot after high intensity program. Taipei: Institute of Sports Science, Taipei Physical Education College.
- TURNER, A.N.; JEFFREYS, I. 2010. The stretch-shortening cycle: proposed mechanisms and methods for enhancement. *Strength Cond. J*, 32, 87.
- UEBERSCHÄR, O., FLECKENSTEIN, D., WARSCHUN, F., KRÄNZLER, S., WALTER, N. & HOPPE, M. W. 2019. Measuring biomechanical loads and asymmetries in junior elite long-distance runners through triaxial inertial sensors. *Sports Orthopaedics Traumatology*, 35, 296-308.
- UYGUR, M., GOKTEPE, A., AK, E., KARABÖRK, H. & KORKUSUZ, F. 2010. The effect of fatigue on the kinematics of free throw shooting in basketball. *Journal of human kinetics*, 24, 51-56.
- VAN MAARSEVEEN, M., & OUDEJANS, R. 2018. Motor and gaze behaviors of youth basketball players taking contested and uncontested jump shots. *Frontiers in psychology*, 9, 706.
- VENCÚRIK, T., KNJAZ, D., RUPČIĆ, T., SPORIŠ, G. & LI, F. 2021. Kinematic analysis of 2-point and 3-point jump shot of elite young male and female basketball players. *Int J Environ Res Public Health*, 18.

- VENCURIK, T.; NYKODYM, J. 2017. Selected factors influencing the successfulness of shooting in women's basketball. In Proceedings of the 8th International Scientific Conference on Kinesiology, Opatija, Croatia, 428–431.
- VERHOEVEN, F. M. & NEWELL, K. M. 2016. Coordination and control of posture and ball release in basketball free-throw shooting. *Hum Mov Sci*, 49, 216-24.
- VINCENT, W.J.; WEIR, J.P. 2012. Statistics in kinesiology, 4th ed.; Human Kinetics: Champaign, IL, USA, ISBN 978-1-4504-0254-5.
- WAN, J. J., QIN, Z., WANG, P. Y., SUN, Y. & LIU, X. 2017. Muscle fatigue: general understanding and treatment. *Exp Mol Med*, 49, e384.
- WANG, J., LIU, W. & MOFFIT, J. 2009. Skills and offensive tactics used in pick-up basketball games. *Perceptual and Motor Skills*, 109, 473-477.
- WANG, X. 2015. Food nutritional supplement as a fatigue recovery method for basketball players. *Carpathian Journal of Food Science and Technology*, 7, 93-97.
- WINTER, D. A. 1990. Biomechanics and Motor Control of Human Movement, Second edition. John Wiley & Sons, Inc., Toronto.
- WILKINS, J. C., VALOVICH MCLEOD, T. C., PERRIN, D. H. & GANSNEDER, B. M. 2004. Performance on the balance error scoring system decreases after fatigue. *J Athl Train*, 39, 156-161.
- WISSEL, H. 1994. *Basketball: steps to success*, Alberta, Canada, Human Kinetics.
- WOODEN, J. R. 1966. *Practical modern basketball*, New York, USA, The ronald Press company.
- ZAGATTO, A. M., ARDIGÒ, L. P., BARBIERI, F. A., MILIONI, F., DELLO IACONO, A., CAMARGO, B. H. F. & PADULO, J. 2017. Performance and metabolic demand of a new repeated-sprint ability test in basketball players: does the number of changes of direction matter? *J Strength Cond Res*, 31, 2438-2446.
- ZHANG, G. & ZHANG, D. 2018. Model construction of technical test and evaluation of “young basketball players”. *Journal of Discrete Mathematical Sciences Cryptography*, 21, 1449-1454.
- ZIFCHOCK, R. A., DAVIS, I., HIGGINSON, J., MCCAW, S. & ROYER, T. 2008. Side-to-side differences in overuse running injury susceptibility: a retrospective study. *Hum Mov Sci*, 27, 888-902.
- ZIV, G. & LIDOR, R. 2009. Physical attributes, physiological characteristics, on-court performances and nutritional strategies of female and male basketball players. *Sports Med*, 39, 547-68.

- ZIVKOVIC, M. Z., DJURIC, S., CUK, I., SUZOVIC, D. & JARIC, S. 2017. Muscle force-velocity relationships observed in four different functional tests. *J Hum Kinet*, 56, 39-49.
- ZWIERKO, T., POPOWCZAK, M., WOŹNIAK, J. & ROKITA, A. 2018. Visual control in basketball shooting under exertion conditions. *J Sports Med Phys Fitness*, 58, 1544-1553.

BIOGRAPHY OF PUBLISHED WORKS

Publications in scientific journals

Feng Li, Damir Knjaz and Tomislav Rupčić. Influence of fatigue on some kinematic parameters of basketball passing. *International Journal of Environmental Research and Public Health*, 2021, 18, 700. <https://doi.org/10.3390/ijerph18020700>

Feng Li, Zheng Li, Iva Borović, Tomislav Rupčić & Damir Knjaz. Does fatigue affect the kinematics of shooting in female basketball? *International Journal of Performance Analysis in Sport*, 21(5), 754-766. <https://doi.org/10.1080/24748668.2021.1945878>

Feng Li, Tomislav Rupčić and Damir Knjaz. The effect of fatigue on kinematics and kinetics in basketball dribbling with changes of direction. *Kinesiology*, 53(2), 296-308. <https://doi.org/10.26582/k.53.2.12>

Tomas Vencúrik, Damir Knjaz, Tomislav Rupčić, Goran Sporiš and **Feng Li**. Kinematic analysis of 2-point and 3-point jump shot of elite young male and female basketball players. *International Journal of Environmental Research and Public Health*, 2021, 18, 934. <https://doi.org/10.3390/ijerph18030934>

Tomislav Rupčić, **Feng Li**, Branka R. Matković, Damir Knjaz, Vedran Dukarić. The impact of progressive physiological loads on angular velocities during shooting in basketball-case study. *Acta Kinesiologica*, 2020,14(2),102-109.

Vedran Dukarić¹, Tomislav Rupčić¹, **Feng Li**, Vjekoslav Cigrovski¹ & Damir Knjaz. Determining asymmetry using specific unilateral tests in young basketball players. *Sportlogia*, 2020,16(1),67-69. doi: 10.5550/sgia. 201601.en. drfck

Stipe Čubrić, Tomislav Rupčić, Vedran Dukarić, **Feng Li**, Branka R. Matković, Damir Knjaz. Kinematic models of the shot with one hand from the spot and the jump shot and their differences. *Hrvat. Sportskomed. Vjesn*, 2019 ,34,69-78.

Ivona Čačić, Tomislav Rupčić, Vedran Dukarić, **Feng Li**, Vjekoslav Cigrovski. Differences in motor skills between female basketball and volleyball players. *Hrvat. Sportskomed. Vjesn*, 2020; 35:41-45. <https://hrcak.srce.hr/250198>

Presentations in international scientific conferences (Full text)

Feng Li, Vedran Dukarić, Dražen Orešković, Slobodan Simović, Zhongchun Bi. Differences in kinematic parameters of basketball jump shot performed from different shooting positions. 9th International Scientific Conference on Kinesiology 2021, Opatija, Croatia. **(Oral presentation)**

Qiong Wang, Zhongchun Bi, **Feng Li**. Analysis of basketball performance of screen switching in the NBA TV broadcast. 9th International Scientific Conference on Kinesiology 2021, Opatija, Croatia. **(Poster presentation)**

Feng Li, Damir Knjaz. The physiological responses of repeated sprint ability test in basketball- a system review. 19th International Scientific Conference of Athletes 2021, Zagreb, Croatia. **(Oral presentation)**

Ivan Bon, **Feng Li**, Vedran Dukarić, Mateja Očić, Damir Knjaz. Support to the analysis of the Beijing Sport University advanced basketball program in the Republic of Croatia. The 2nd Belt and Road Physical Education and Sport Forum 2020, Beijing, China. **(Oral presentation)**

Mateja Očić, **Feng Li**, Ivan Bon, Vedran Dukarić, Damir Knjaz. Beijing Sport University handball development program in the Republic of Croatia. The 2nd Belt and Road Physical Education and Sport Forum. 2020, Beijing, China. **(Oral presentation)**

Vedran Dukarić, **Feng Li**, Mateja Očić, Ivan Bon, Damir Knjaz. The impact of the training program on some motor and functional abilities of young national football players of China. The 2nd Belt and Road Physical Education and Sport Forum 2020, Beijing, China. **(Oral presentation)**

Iva Borović, **Feng Li**, Mateja Očić, Ivan Bon, Vedran Dukarić. Razlike u skok šutu kod košarkaša kadetskog uzrasta za 2 i 3 poena u određenim kinematičkim parametrima. 18th International Scientific Conference of Athletes 2020, Zagreb, Croatia. **(Poster presentation)**

Presentations in international scientific conferences (Abstract)

Feng Li, Qian Peng. Discriminant analysis of pacing behavior on mass start speed skating. 15th International Conference on Sport Medicine and Sport Science October 28-29, 2021, Paris, France. **(Oral presentation)**