

7th International Scientific Conference on Kinesiology: Fundamental and applied kinesiology - steps forward : proceedings

**Andrijašević, Mirna; Baić, Mario; Baković, Marijo; Barbaros Tudor, Petar;
Barić, Renata; Bartoluci, Sunčica; Bok, Daniel; Bosnar, Ksenija;
Cigrovski, Vjekoslav; Ciliga, Dubravka; ...**

Edited book / Urednička knjiga

Publication status / Verzija rada: **Published version / Objavljena verzija rada (izdavačev PDF)**

Publication year / Godina izdavanja: **2014**

Permanent link / Trajna poveznica: <https://um.nsk.hr/um:nbn:hr:117:284411>

Rights / Prava: [In copyright](#)/[Zaštićeno autorskim pravom.](#)

Download date / Datum preuzimanja: **2024-07-25**



Repository / Repozitorij:

[Repository of Faculty of Kinesiology, University of Zagreb - KIFoREP](#)



7th INTERNATIONAL SCIENTIFIC CONFERENCE ON KINESIOLOGY



Fundamental and Applied Kinesiology – Steps Forward

May 22 - 25, 2014, Opatija, Croatia



Proceedings

Editors-in-Chief

Dragan Milanović and Goran Sporiš

Organizer

University of Zagreb, Faculty of Kinesiology, Croatia

Under the patronage of

Croatian Academy of Sciences and Arts



7TH INTERNATIONAL SCIENTIFIC CONFERENCE ON KINESIOLOGY

**FUNDAMENTAL AND APPLIED
KINESIOLOGY – STEPS FORWARD**

Opatija, Croatia, May 22 – 25, 2014

Proceedings

Editors-in-Chief:

Dragan Milanović and Goran Sporiš

University of Zagreb, Faculty of Kinesiology
Zagreb, 2014

Publisher: Faculty of Kinesiology, University of Zagreb, Croatia

For the Publisher: Damir Knjaz, Dean

Editors-in-Chief: Dragan Milanović
Goran Sporiš

Editors/Editorial: Mirna Andrijašević, Mato Bartoluci, Ksenija Bosnar, Dubravka Ciliga, Zrinko Čustonja, Sanja Ćurković, Cvita Gregov, Stjepan Heimer, Igor Jukić, Danijel Jurakić, Goran Marković, Uroš Marušić, Branka Matković, Vladimir Medved, Dragan Milanović, Marjeta Mišigoj-Duraković, Antonela Nedić, Boris Neljak, Dario Novak, Rado Pišot, Lana Ružić, Sanja Šalaj, Dario Škegro, Sanela Škorić, Tatjana Trošt Bobić, Vlatko Vučetić, Saša Vuk

Indexers: Darko Štefanec, Vlatko Vučetić

Copysetting: Vlatko Vučetić

Layout and Cover: Stef, d.o.o.

Printed by: Tiskara Zelina, Croatia

Edition: 400 copies

Printed in Zagreb, Croatia

A CIP catalogue record for this book is available from the National and University Library in Zagreb under the number 877742. (for CD 877739)

ISBN: 978-953-317-027-5

The statements and views expressed in the contributions are those of their authors and do not necessarily represent those of the Editorial Board and the publisher.

This Proceedings Book includes all the conference communications (invited, oral and poster) received before the editing deadline. Those received later are not published in the book.

Organizer: Faculty of Kinesiology, University of Zagreb, Croatia

Under the patronage of: Croatian Academy of Sciences and Arts

In cooperation with: Faculty of Sports Studies Masaryk University, Brno
Beijing Sport University, China
Science and Research Centre, University of Primorska, Koper, Slovenia
Lithuanian Sports University, Lithuania

Supported by: European College of Sport Science (ECSS)
International Association for Physical Education in Higher Education (AIESEP)
International Federation of Physical Education (FIEP)
International Network of Sport and Health Sciences (INSHS)

ORGANISING COMMITTEE

Chairman:

Prof. Dragan Milanović, PhD,
Faculty of Kinesiology, University of Zagreb, Croatia

Vice-chairman:

Dario Škegro, PhD,
Faculty of Kinesiology, University of Zagreb, Croatia

Conference Secretary:

Natalija Babić,
Faculty of Kinesiology, University of Zagreb, Croatia

MEMBERS:

Assist. Prof. Mario Baić, PhD,
Faculty of Kinesiology, University of Zagreb, Croatia

Željka Jaklinović, MagA
Faculty of Kinesiology, University of Zagreb, Croatia

Drago Kalajžić, MagBA,
Faculty of Kinesiology, University of Zagreb, Croatia

Đurđica Kamenarić
Faculty of Kinesiology, University of Zagreb, Croatia

Prof. Damir Knjaz, PhD,
Faculty of Kinesiology, University of Zagreb, Croatia

Ivan Krakan, mag.cin.
Faculty of Kinesiology, University of Zagreb, Croatia

Assist. Prof. Tomislav Krističević, PhD,
Faculty of Kinesiology, University of Zagreb, Croatia

Prof. Emil Hofman, PhD,
Faculty of Kinesiology, University of Zagreb, Croatia

Uroš Marušić, PhD,
Science and Research Centre, University of Primorska, Koper, Slovenia

Eva Špilingova, PhD,
Faculty of sports studies, Masaryk University, Czech Republic

Prof. Irena Valentine, PhD,
Lithuanian Sports University, Lithuania

SCIENTIFIC COMMITTEE

Chairpersons:

Prof. Goran Sporiš, PhD and Prof. Franjo Prot, PhD,
Faculty of Kinesiology, University of Zagreb, Croatia

Secretary:

Vlatko Vučetić, PhD,
Faculty of Kinesiology, University of Zagreb, Croatia

CROATIAN MEMBERS:

- Prof. Mirna Andrijašević, PhD,**
Faculty of Kinesiology, University of Zagreb, Croatia
- Prof. Mato Bartoluci, PhD,**
Faculty of Kinesiology, University of Zagreb, Croatia
- Daniel Bok, PhD,**
Faculty of Kinesiology, University of Zagreb, Croatia
- Prof. Ksenija Bosnar, PhD,**
Faculty of Kinesiology, University of Zagreb, Croatia
- Prof. Dubravka Ciliga, PhD,**
Faculty of Kinesiology, University of Zagreb, Croatia
- Zrinko Čustonja, PhD,**
Faculty of Kinesiology, University of Zagreb, Croatia
- Sanja Ćurković, PhD,**
Faculty of Agriculture, University of Zagreb, Croatia
- Cvita Gregov, PhD,**
Faculty of Kinesiology, University of Zagreb, Croatia
- Prof. Stjepan Heimer, PhD,**
Faculty of Kinesiology, University of Zagreb, Croatia
- Prof. Igor Jukić, PhD,**
Faculty of Kinesiology, University of Zagreb, Croatia
- Danijel Jurakić, PhD,**
Faculty of Kinesiology, University of Zagreb, Croatia
- Prof. Goran Marković, PhD,**
Faculty of Kinesiology, University of Zagreb, Croatia
- Prof. Branka Matković, PhD,**
Faculty of Kinesiology, University of Zagreb, Croatia
- Prof. Vladimir Medved, PhD,**
Faculty of Kinesiology, University of Zagreb, Croatia
- Prof. Dragan Milanović, PhD,**
Faculty of Kinesiology, University of Zagreb, Croatia
- Prof. Đurđica Miletić, PhD,**
Faculty of Kinesiology, University of Split, Croatia
- Prof. Marjeta Mišigoj-Duraković, PhD, MD**
Faculty of Kinesiology, University of Zagreb, Croatia
- Antonela Nedić, MD,**
Faculty of Kinesiology, University of Zagreb, Croatia
- Prof. Boris Neljak, PhD,**
Faculty of Kinesiology, University of Zagreb, Croatia
- Dario Novak, PhD,**
Faculty of Kinesiology, University of Zagreb, Croatia
- Marija Rakovac, PhD,**
Faculty of Kinesiology, University of Zagreb, Croatia
- Prof. Lana Ružić, PhD,**
Faculty of Kinesiology, University of Zagreb, Croatia
- Sanja Šalaj, PhD,**
Faculty of Kinesiology, University of Zagreb, Croatia
- Sanela Škorić, PhD,**
Faculty of Kinesiology, University of Zagreb, Croatia
- Tatjana Trošt Bobić, PhD,**
Faculty of Kinesiology, University of Zagreb, Croatia
- Saša Vuk, PhD,**
Faculty of Kinesiology, University of Zagreb, Croatia

INTERNATIONAL MEMBERS:

- Prof. Branislav Antala, PhD,**
Faculty of PE and Sport, University of Bratislava, Slovakia
- Prof. Herman Berčić, PhD,**
Faculty of Sport, University of Ljubljana, Slovenia
- Prof. Lee E. Brown, PhD,**
California State University, USA
- Prof. Martin Buchheit, PhD,**
ASPIRE – Academy for Sports Excellence, Doha, Qatar
- Prof. Julio Calleja-Gonzales, PhD,**
Department of Research and Development, Athletic Club Bilbao Basque Country, Spain
- Prof. Milan Čoh, PhD,**
Faculty of Sport, University of Ljubljana, Slovenia
- Prof. Maria Dinold, PhD,**
Vice President, International Federation of Adapted Physical Activity (IFAPA), Centre for Sport Science and University Sports, University of Vienna, Austria
- Prof. Jacques Duysens, PhD,**
Faculty of Kinesiology and Rehabilitation Sciences, Leuven, Belgium
- Prof. Jay R. Hoffman, PhD,**
College of New Jersey, Ewing, NJ, USA
- Prof. Annette Hofmann, PhD,**
President, International Society for the History of Physical Education and Sport (ISHPES), University of Education, Ludwigsburg, Germany
- Prof. Vladimir Issurin, PhD,**
Elite Sport Department, Wingate Institute, Israel
- Prof. Gregor Jurak, PhD,**
Faculty of Sport, University of Ljubljana, Slovenia
- Prof. Antonio Méndez Giménez, PhD,**
Faculty of Teacher Training and Education, University of Oviedo, Spain
- Prof. Dragan Mirkov, PhD,**
Faculty of Sports and Physical Education, University of Belgrade, Serbia
- Prof. Marco Narici, PhD,**
President, European College of Sport Science (ECSS), School of Graduate Entry Medicine and Health, University of Nottingham, UK
- Prof. Sergej Ostojić, PhD,**
Faculty of Physical Education and Sport, University of Novi Sad, Serbia
- Prof. Tomaž Pavlin, PhD,**
Faculty of Sport, University of Ljubljana, Slovenia
- Prof. Rado Pišot, PhD,**
University of Primorska, Institute for Kinesiology Research, Slovenia
- Prof. Claude Sobry, PhD,**
Faculty of Sport Sciences, University of Lille, France
- Prof. Janko Strel, PhD,**
Faculty of Sport, University of Ljubljana, Slovenia
- Prof. Boštjan Šimunič, PhD,**
University of Primorska, Slovenia
- Prof. Barbara Wessner, PhD,**
Institute for Sport Science, University of Vienna, Austria
- Prof. Weimo Zhu, PhD,**
Kinesiology and Community Health College of Applied Health Sciences USA
- Prof. Martin Zvonar, PhD,**
Masaryk University, Brno, Czech Republic

HONORARY COMMITTEE

- Prof. Branislav Antala, PhD
president, International Federation Physical Education, Bratislava, Slovakia
- Prof. Duško Bjelica, PhD, dean,
Faculty of Sport and Physical Education, Nikšić, Montenegro
- Prof. Aleksa Bjeliš, PhD,
rector, University of Zagreb, Croatia
- Prof. Marc Cloes PhD,
president, International Association for Physical Education in Higher Education, Belgium
- Henriette Dancs, PhD,
head coordinator, International Network of Sport and Health Science
- Prof. Christophe Delecluse, PhD,
dean, Faculty of Kinesiology and Rehabilitation Sciences, Catholic University, Leuven, Belgium
- Assist. Prof. Arūnas Emljanovas, PhD,
dean, Lithuanian Sports University, Lithuanian
- Prof. Emeritus Vladimir Findak, PhD,
Faculty of Kinesiology, University of Zagreb, Croatia
- Annette Hofmann, President,
International Society for the History of Physical Education and Sport (ISHPES), University of Education, Ludwigsburg, Germany
- Mr. Chi Jian,
vice-president, Beijing Sport University, China
- Assist. Prof. Željko Jovanović, PhD,
minister, Ministry of Science, Education and Sports, Zagreb, Croatia
- Prof. Vladimir Koprivica, PhD,
Faculty of Sport and Physical Education, Beograd
- FCA Zvonko Kusić, MD, PhD,
president, Croatian Academy of Sciences and Arts, Zagreb, Croatia
- Prof. Dean Madić, PhD,
dean, Faculty of Sport and Physical Education, Novi Sad
- Prof. Narici Marco PhD,
president, European College of Sport Science, Germany
- Zlatko Mateša, PhD,
president, Croatian Olympic Committee, Zagreb, Croatia
- Prof. Ifet Mahmutovic, PhD,
dean, Faculty of Sport and Physical Education, Sarajevo, Bosnia and Herzegovina
- Prof. Boris Maleš, PhD,
dean, Faculty of Kinesiology, University of Split, Croatia
- Jiri Nykodým,
Faculty of Sport Studies, Masaryk University, Brno, Czech Republic (Assoc.
- Prof. Rado Pišot, PhD,
dean, Science and Research Centre University of Primorska, Koper, Slovenia
- FCA Pavao Rudan, MD, PhD,
secretary, Croatian Academy of Sciences and Arts, Zagreb, Croatia
- Prof. Włodzimierz Starosta, PhD,
University School of Physical Education in Białystok, Institute of Physical Culture in Gorzów, Poland
- Prof. Simo Vuković, PhD,
dean, Faculty of Physical Education and Sport, Banja Luka, Bosnia and Herzegovina
- Prof. Vujica Živkovic, PhD,
dean, Faculty of Physical Education, Skopje
- Prof. Milan Žvan, PhD,
dean, Faculty of Sport, University of Ljubljana, Slovenia

TECHNICAL STAFF

- Dora Bučan, Faculty of Kinesiology University of Zagreb, Croatia
- Ivana Degirmedžić, Faculty of Kinesiology University of Zagreb, Croatia
- Stipe Gorenjak, Faculty of Kinesiology University of Zagreb, Croatia
- Danijela Gudelj, Faculty of Kinesiology University of Zagreb, Croatia
- Dorijan Jelinčić, Faculty of Kinesiology University of Zagreb, Croatia
- Lucija Mudronja, Faculty of Kinesiology University of Zagreb, Croatia
- Tomislav Paripović, Faculty of Kinesiology University of Zagreb, Croatia
- Alen Plevnik, Faculty of Kinesiology University of Zagreb, Croatia

Dear colleagues, Conference delegates and Proceedings' readers,

It is our pleasure to greet you on behalf of the Faculty of Kinesiology, University of Zagreb. Quite a number of significant anniversaries in this year are related to sport, physical education and kinesiology in Croatia. The most important anniversary is the 55th birthday of the College of Physical Culture/Faculty of Physical Culture/Faculty of Kinesiology establishment in 1959. However, the tradition of physical education teachers' education in Croatia is much longer than that. Namely, in 1874, the Croatian Falcon (Hrvatski sokol) was founded and in 1894, first course for gymnastic teachers was organised as the first higher education course in the field of kinesiology in Croatia. Along with these important anniversaries, this year we are marking the 17th birthday of our Conference on kinesiology, dear Reader, and you are one of the most important reasons why is this so. From the first Conference in Dubrovnik in 1997 up nowadays, many changes in our science have occurred as well as in the practice of physical exercise and sports along with innumerable changes in political and social dimensions of modern life. However, we are deeply convinced that one thing has remained unchanged; that is the passion for investigation and knowledge acquisition, the need for new discoveries and love for kinesiology as the main field of our research. Also, we are assured that our ideas about the conference as a meeting point of distinguished scientists, leading researchers in different fields of our science and young investigators have become reality.

We expect discussions and exchange of ideas that should result, as they have before, in new research ideas, insights, and research teams and projects the eventual outcome of which would be further advances in kinesiology and in cognate and adjacent scientific areas. The Conference will work under the motto "Fundamental and applied kinesiology - steps forward" in usual plenary and parallel sessions addressing ten comprehensive kinesiological topics: adaptation of human organism to disuse and ageing; adapted physical activity and kinesitherapy; biology and medicine of sport and exercise; biomechanics and motor control; physical education; kinesiological (sports) recreation; kinesiology of top-level sport; management of sport; kinesiology and social sciences (sociology, psychology, history, philosophy) and kinesiology in physical conditioning. Certain areas will be addressed at the Conference for the first time, like adaptation of human organism to disuse and ageing. All the papers that have got positive reviews, performed by at least two respectable referees, are published in these proceedings. The best papers, so recognized by the peer reviewers, will be published in the journal Kinesiology supplement. Two significant satellite symposiums are going to be held during this year Conference under the titles: University Sport and Health Kinesiology. Both symposia are aiming at provoking experts from these areas to find solutions and answers to recent problems in these specific fields

From the very beginning, the Croatian Academy of Sciences and Fine Arts has been giving its high patronage to the Conference, thus underpinning the recognition of kinesiology in the structure of different areas in science. We are proud to have partners and cooperating institutions like Beijing Sports University (China), Faculty of Sport Studies Masaryk University, Brno (the Czech Republic), Science and Research Centre, University of Primorska (Slovenia) and Lithuanian Sports University. Also, our conference is supported by a number of important organisations in the field of kinesiology such as: the European College of Sport Science (ECSS), International Association for Physical Education in Higher Education (AIESEP), International Federation of Physical Education (FIEP), and International Network of Sport and Health Sciences (INSHS).

This year the assembly of kinesiologists from 32 countries will discuss diverse aspects of a variety of kinesiological issues presented in 220 papers and abstracts written by 514 authors. The Proceedings and Abstract Book is a reminder of the research findings accomplished in the field of kinesiology, or sport sciences, or kinetics, or kinanthropology throughout the past three years. The presented papers are a basis and a probable starting point for future findings and inferences since they cover a wide range of anthropological (understood in the widest sense), methodological and didactic investigations in the areas of physical education, competitive sport, kinesiological recreation, and kinesitherapy.

We wish to express exceptional gratitude to all the authors of papers, reviewers, conference participants, members of the Organising and Programme Committee, Section Editors and technical support staff for their contributions, time and effort inbuilt in quality of the 7th Conference on Kinesiology and its Proceedings.

Looking forward to meeting you again at the 8th International Conference on Kinesiology in 2017.

Organising Committee

CONTENTS

ADAPTED PHYSICAL ACTIVITY AND KINESITHERAPY

Maria Dinold	
THE IMPACT OF DANCE AND CREATIVE ACTIVITIES ON THE QUALITY OF LIFE OF INDIVIDUALS WITH DISABILITIES	22
Dubravka Ciliga, Tatjana Trošt Bobić and Branimir Filipović	
EFFECT OF FATIGUE ON DYNAMIC BALANCE IN DIFFERENT DIRECTIONS	27
Matea Crnjak, Valerija Kršak and Sabina Stančić	
EFFECTS OF POSTURAL DEFORMATIONS ON KNEE JOINT INJURIES. A SYSTEMATIC REVIEW	31
Dagmar Hrusova	
EFFECT OF A MODIFIED PILATES PROGRAMME ON STABILIZATION AND MUSCLE COORDINATION AT WOMEN WITH A SEDENTARY JOB	36
Petra Kurková	
CONDITIONS FOR HEALTHY LIFESTYLE IN CZECH PUPILS WHO ARE DEAF AND HARD OF HEARING	40
Gabriela Ochiană and Nicolae Ochiană	
THE ROLE OF THE ADJUSTMENT IN 3 DIMENSIONS OF THE CERVICAL SPINE IN THE CASE OF PATIENTS WITH DISK HERNIATION	43
Lidija Petrinović	
ADAPTED SPORT – BADMINTON IN PERSPECTIVE OF DIFFERENT DISABILITIES	50
Matej Plevnik, Iztok Retar and Anton Zupan	
EVALUATION OF HYDROTHERAPY IN THE REHABILITATION PROGRAMME FOR PEOPLE WITH MUSCULAR DYSTROPHY	54
Mousa Sarmad, Ahmed Rajua and Mohab Hamid	
EFFICACY OF A PROPOSED PROGRAM FOR THE DEVELOPMENT OF BASIC MOVEMENTS TRANSITION FOR THE CHILDREN AGED 4-6 YEARS	57
Tatjana Trošt Bobić, Dubravka Ciliga and Iris Zavoreo	
SPECIFIC EFFECTS OF STRENGTH TRAINING ON DYNAMIC BALANCE	60
Matej Voglar and Neje Šarabon	
EFFECT OF KINESIO TAPE APPLICATION ON TRUNK ISOMETRIC STRENGTH	63
Iris Zavoreo, Branimir Filipović, Goran Bobić and Vanja Bašić Kes	
EVALUATION OF CONVENTIONAL CEREBROVASCULAR RISK FACTORS IN POPULATION OF KINESITHERAPY STUDENTS	67
Tea Čišić	
CLASSIFICATION PROCESS OF ATHLETES WITH INTELLECTUAL IMPAIRMENT IN ATHLETICS: A REVIEW	71
Vilma Juodzbalienė, Ginas Cizauskas, Giedre Jurgelaitienė and Milda Bilinauskaitė	
DOES SINGLE TEST REFLECT TRUE PELVIS POSITION AND HELP TO DETERMINE ITS RELATIONSHIP WITH THIGH MUSCLES LENGTH?	72
Irina Roy, Andrey Rusanov and Olga Rusanova	
DESCRIPTION OF THE MAINTENANCE BALANCE AND WALKING PATIENTS WITH LESIONS OF ANTERIOR CRUCIATE LIGAMENT KNEE JOINT IN THE PREOPERATIVE PERIOD	73
Artem Vetkasov and Blanka Hošková	
OBJECTIFICATION OF IMPORTANCE OF BREATHING EXERCISES IN PERSONS WITH SPINAL CORD INJURY	74

BIOLOGY AND MEDICINE OF SPORT AND EXERCISE

Barbara Wessner GENETIC VARIABILITY AND GENE-ENVIRONMENT INTERACTION IN RELATION TO MOVEMENT AND SPORT?	76
Martina Bernaciková, Zdenko Reguli and Michal Kumstát SOMATOTYPES OF DIFFERENT LEVELS IN CZECH AIKIDOKAS	77
Gordana Ivković NUTRITIONAL KNOWLEDGE AND DIETARY HABITS IN FEMALE BASKETBALL PLAYERS	82
Mihaela Jurdana, Ana Petelin and Zala Jenko Pražnikar ASSOCIATION BETWEEN PHYSICAL INACTIVITY, ANTHROPOLOGICAL AND BIOCHEMICAL PARAMETERS IN OVERWEIGHT AND NORMAL WEIGHT MIDDLE-AGED ADULTS	86
Jana Juříková EATING HABITS AND SPORTS ACTIVITIES IN THE MILITARY UNIVERSITY STUDENTS	90
Elvir Kazazović, Mensur Vrcić and Erol Kovačević RECIPROCAL AND BILATERAL RATIO OF THE STRENGTH OF DYNAMIC KNEE STABILIZERS IN ACTIVE HANDBALL AND BASKETBALL PLAYERS.....	94
Nevia Mavra, Gordana Ivković and Ivan Žderić THE DIETARY HABITS OF CROATIAN WOMEN BASKETBALL PLAYERS AND MENSTRUAL IRREGULARITIES	98
Bryan McCormick PROMOTING PHYSICAL ACTIVITY AND EXERCISE AS ADJUNCT TREATMENT OF COGNITIVE DYSFUNCTION IN PSYCHIATRIC DISORDERS	103
Zora Svobodova, Alexandra Malá, Radks Adámková, Lenka Dovrtělová, Michal Hrouzek, Andrea Janíková, Katerina Kapounková, Jan Kohout, Pavel Seman, Pavel Stejskal and Tamas Vodička PHYSICAL ACTIVITIES PROGRAM SUITABLE FOR HEMATO-ONCOLOGICAL PATIENTS - A PILOT STUDY	107
Dorjana Zerbo Šporin SCREENING OF YOUNG WOMEN FOR DIABETES MELLITUS TYPE 2 USING BODY MASS INDEX: THE ROLE OF A KINESIOLOGIST	111
Weiai Zhou, Haitao Chen and Dongjian Li RESEARCH ON THE NEUROBIOLOGICAL CHARACTERISTICS OF THE CHINESE ELITE TRAMPOLINE ATHLETES	114
Marijo Baković, Damir Knjaz, Ljubomir Antekolović and Tomislav Rupčić THE EFFECTS OF FATIGUE ON ACCURACY AND SOME KINEMATIC PARAMETERS ON BASKETBALL SHOOTING	120
Hashem Kilani and Mostafa Waly WHAT IS THE CURRENT STATUS OF OMANI ADOLESCENT'S LIFE STYLE?	121
Branka R. Matković, Antonela Nedić, Andro Matković, Tomislav Rupčić and Petra Ožegović ALCOHOL AND TOBACCO USE IN SPORT COACHES	122
Jadranka Plavšić, Slavica Djordjevic-Šaranović and Sanja Mazić MORPHOFUNCTIONAL CHARACTERISTICS OF THREE NATIONAL WATER POLO TEAMS OF VARIOUS AGE GROUPS	123
Lana Ružić, Sebastijan Mohar and Ivan Radman INTERACTIVE DANCE: AN EXCITING WAY TO ENHANCE CHILDREN'S PHYSICAL ACTIVITY LEVEL	124
Ewa Szczepanowska DIFFERENCES BETWEEN GIRLS AND BOYS IN PHYSICAL EFFICIENCY TEST RESULTS IN THE DEPENDENCE ON BODY MASS COMPONENTS	125

Jianfang Xu THE INFLUENCES OF DIFFERENT EXERCISE TRAINING ON CHRONIC INFLAMMATORY MARKERS IN YOUNG OBESE ADULTS	126
Kristina Zaicenkoviene and Arvydas Stasiulis THE INFLUENCE OF PRIOR STEP EXERCISE ON THE ELECTRICAL ACTIVITY OF LEG MUSCLES DURING INCREASING RUNNING TEST IN YOUNG MEN	127
Dajana Zoretić, Nada Grčić-Zubčević and Katarina Zubčić THE EFFECTS OF HYPERCAPNIC-HYPOXIC TRAINING ON HEMOGLOBIN CONCENTRATION AND MAXIMUM OXYGEN UPTAKE OF ELITE SWIMMERS	128
BIOMECHANICS AND MOTOR CONTROL	
Jacques Duysens IN SEARCH OF AN AUTOMATIC PILOT FOR WALKING	130
Dana Badau, Dušan Mitić, Goran Prebeg and Liliana Rogozea RELATIONSHIP BETWEEN THE REACTION TIME OF RIGHT-HAND AND LEFT-HAND	131
Aco Gajević, Jelena Ivanović and Nemanja Badnjarević THE INFLUENCE OF ATHLETIC BACKGROUND ON MUSCLE FORCE PRODUCTION	137
Mitja Geržević and Veronika Mikuletič COMPARISON OF TRUNK MUSCLES' ACTIVATION AND PERCEIVED SITTING DISCOMFORT ON A STANDARD OFFICE CHAIR AND A NOVEL ACTIVE CHAIR®	142
Željko Hraski FUNCTIONAL RELATIONSHIPS AMONG KINEMATIC AND KINETIC PARAMETERS OF BACKWARD SOMERSAULTS	146
Jelena Ivanović, Milivoj Dopsaj, Saša Jakovljević, Milivoje Karalejić and Aco Gajević FUNCTIONAL DIMORPHISM OF DIFFERENT INDICATORS OF LEG EXTENSORS EXPLOSIVE FORCE REGARDING JUNIORS IN SPORTS GAMES	150
Miroslav Janura, Lee Cabell and Milan Elfmark LONGITUDINAL MONITORING OF PERFORMANCE IN BIOMECHANICAL LABORATORY TESTS AIMED AT SKI JUMPING IN NORDIC COMBINED ATHLETES	155
Tomislav Krističević, Kamenka Živčić Marković and Lucija Mudronja COMPARATIVE KINEMATIC ANALYSIS OF AIRBORNE PHASE IN ACROBATIC ELEMENTS FROM “STUFF POSITION”	159
Maja Mahnić, Filip Ujaković, Saša Janjić, Slavenka Petrak and Vladimir Medved COMPARATIVE ANALYSIS AND ADJUSTMENTS OF ANTHROPOMETRIC PARAMETERS ON SYSTEM FOR KINEMATIC MOVEMENT ANALYSIS AND 3D BODY SCANNER	165
Petra Mandić Jelaska, Durdica Miletić and Igor Jelaska RELATIONS BETWEEN PRECISION, SPEED AND PERFORMANCE QUALITY OF HEAD AND FOOT INSTEP KICK AMONG FOOTBALL PLAYERS	170
Eliska Martinaskova, Jiri Gallo, Petr Kaminek and Miroslav Janura GROUND REACTION FORCE IN PATIENTS AFTER TOTAL HIP ARTHROPLASTY REVISION – A PILOT STUDY	174
Marijo Možnik and Željko Hraski KINEMATIC EFFICIENCY OF THE “MOZNIK” ELEMENT PERFORMANCE	177
Petr Nemecek and Lee Cabell KINEMATICS OF HORSE AND RIDER INTERACTION DURING SIMULATED HORSE JUMPING	181
Marketa Prochazkova, Zdenek Svoboda, Michaela Blazkova and Lucie Tepla THE STATIC BALANCE ASSESSMENT IN BALLET DANCERS: THE EFFECT OF VISION AND LEG PREFERENCE	187

Vladimir Psalman and Jozef Balaz BIOMECHANICS OF SKI TURN MOVEMENT IN DOWNHILL SKIING	192
Ozren Radenović, Ljubomir Antekolović and Ivan Jurak DIFFERENCES IN PERFORMANCE OF ISOLATED ARM SWINGS IN ATHLETICS, VOLLEYBALL AND ARTISTIC GYMNASTICS	196
Zdenek Svoboda, Lucia Bizovska, Zuzana Kovacikova, Patrik Kutilek and Ales Gaba VARIABILITY OF CENTRE OF PRESSURE MOVEMENT IN STATIC AND DYNAMIC CONDITIONS IN MIDDLE-AGE WOMEN	201
Ivan Šerbetar THE ROLE OF DYNAMIC SYSTEMS IN MOTOR DEVELOPMENT RESEARCH: JUST A METAPHOR OR A NOTABLE REALITY?	205
Martin Vaváček and Marek Hardoň DEPENDANCE OF THE SHOT PUT PERFORMANCE ON THE SELECTED KINEMATIC PARAMETERS OF THE TECHNIQUE	209
Lucie Vorlickova and Pavel Korvas EVALUATION OF REHABILITATION INFLUENCE ON STATIC PARAMETRES OF FOOT IN FLATFOOT DIAGNOSIS	214
Martin Zorko, Blaž Lešnik, Bojan Nemeč, Jan Babič and Matej Supej COMPARISON BETWEEN KNEE JOINT KINEMATICS IN LABORATORY SKIING SIMULATION AND IN REAL SKIING WHILE USING SKIES OF DIFFERENT WIDTH	218
Martin Zvonar and Katerina Kolarova CASE STUDY: VERIFYING THE EFFECT OF SPECIFIC ORTHOPAEDIC INSOLES AND BIOMECHANICAL SHOES ON PLANTAR PRESSURE	221
Kristina Buckova, Zuzana Hirjakova and Frantisek Hlavacka POSTURAL ADJUSTMENTS OF LEANING DURING STANCE ON INCLINED SURFACE	227
Saeed Ghorbani and Andreas Bund THE ROLE OF RELATIVE MOTION INFORMATION DURING OBSERVATIONAL LEARNING IN SPORTS	228
Michaela Hassmann, Mario Heller, Arnold Baca, Miran Kondrič and Kerstin Witte ANALYZING INDIVIDUAL COORDINATION PATTERNS OF FOREHAND TOPSPIN TABLE TENNIS STROKES DURING FATIGUE USING PCA	229
Zuzana Hirjakova, Jana Lobotkova and Frantisek Hlavacka VISUAL BIOFEEDBACK MAGNIFICATION FOR STANCE CONTROL IN YOUNG AND ELDERLY	230
Katja Koren, Boštjan Šimunič, Enrico Rejc, Stefano Lazzer and Rado Pišot SKELETAL MUSCLE'S CONTRACTILE PARAMETERS DIFFER WHEN MEASURED FROM LONGITUDINAL THAN FROM TRANSVERSAL TWITCH DEFORMATIONS	231
Vladimir Kunitson, Kristjan Port and Tatjana Gnezdilova COMPARISON ANALYSIS OF FINSWIMMING WITH RIGID AND SOFT MONOFINS	232
Jana Lobotková and Kristína Bučková POSTURAL ADJUSTMENTS IN GAIT INITIATION DETECTED BY INERTIAL SENSORS	233
Zrinka Potocanac, Jaap van Dieën, Sabine Verschueren, Jacques Duysens and Mirjam Pijnappels ONLINE STEP ADJUSTMENTS DURING UNEXPECTED TRIPPING	234
Wisam Salah and Talib Hussein EFFECTS OF SUGGESTED EXERCISES OF SENSITIVE – MOVEMENT REALIZATION DEVELOPMENT AND RESPONSE SPEED IN PERFORMANCE ACCURACY OF SOME OVERHEAD KICKS FOR YOUTH BADMINTON	235
Andi Spahi, Juel Jarani and Agron Kasa THE IMPORTANCE OF A WELL BALANCED STRENGTH TRAINING PROGRAM IN DIFFERENT SPORTS IN YOUTH FOR LOWER EXTREMITIES	236

Michal Wychowanski, Jan Gajewski, Jacek Laskowski, Piotr Pietrzak, Michal Udvardy and Andrzej Wit USING 6-POINT SCALE FOR ASSESSMENT OF HIP JOINT STRENGTH AND BALANCE ABILITIES IN PATIENTS TREATED WITH BIRMINGHAM HIP RESURFACING	237
PHYSICAL EDUCATION	
Antonio Méndez-Giménez SELF-MADE MATERIALS IN PHYSICAL EDUCATION CONTEXTS: AN INNOVATIVE COMPLEMENT TO INSTRUCTIONAL MODELS	240
Branislav Antala INTERNATIONAL ORGANISATIONS AND NETWORKS AND THEIR INFLUENCE TO THE DEVELOPMENT OF PHYSICAL EDUCATION IN THE WORLD	246
Marko Badrić, Goran Sporiš, Ivan Prskalo, Zoran Milanović, Ivan Krakan, Zlatko Šafarić, Zvonko Miljković and Saša Pantelić DIFFERENCES IN MOTOR ABILITIES OF PUPILS ACCORDING TO NUTRITIONAL STATUS	247
Urška Čeklić COHERENT CHILD CRAWLING PATTERN IN EARLY CHILDHOOD	253
Tina Erceg and Ana Kezić THE EFFECT OF GENDER ON CHILDREN’S RHYTHMIC GYMNASTICS SKILLS	257
Marijana Hraski, Vatroslav Horvat and Igor Bokor EFFICIENCY OF A PHYSICAL ACTIVITY TREATMENT ON MOTOR PROFICIENCY AMONG PRESCHOOLERS	260
Juel Jarani, Keida Ushtelenca and Andi Spahi THE CURRENT LEVEL OF HEALTH AND SKILLS RELATED FITNESS INDICATORS IN ALBANIAN CHILDREN; REFERENCE VALUES FROM A COUNTRY IN TRANSITION	264
Srna Jenko Miholic, Ivan Prskalo and Marina Prebila PUPILS PHYSIOLOGICAL LOAD IN THE LESSON OF PHYSICAL EDUCATION IN THE COMBINED AND THE STANDARD CLASSROOMS	269
Marino Krespi, Igor Jelaska and Petra Mandić Jelaska COMPARISON OF DIFFERENT REGRESSION MODELS BETWEEN COORDINATION AND SELECTED VARIABLES OF ANTHROPOLOGICAL STATUS	274
Julijan Malacko, Aleksandra Pejčić and Braco Tomljenović THE INTERACTION BETWEEN THE MORPHOLOGICAL CHARACTERISTICS AND MOTOR SKILLS OF BOYS AND GIRLS AGED 7 TO 11	278
Ivana Nikolić, Snježana Mraković and Dražen Rastovski GENDER DIFFERENCES IN OBJECT CONTROL SKILLS OF THE YOUNGER SCHOOL AGE CHILDREN	282
Aleksandra Pejčić, Julijan Malacko and Helena Muvrin GENDER DIFFERENCES IN THE MORPHOLOGICAL CHARACTERISTICS AND MOTOR SKILLS OF FIRST- FOURTH GRADE ELEMENTARY SCHOOL CHILDREN	286
Vilko Petrić, Ana Čuić Tanković and Dario Novak DOCTORAL DISSERTATIONS ON PHYSICAL EDUCATION: CROATIAN CASE	291
Ingrid Ružbarská and Erika Chovanová PRIMARY SCHOOL CHILDREN DIAGNOSED WITH ADHD AND PHYSICAL ACTIVITY PREFERENCES	295
Zvonimir Tomac, Biljana Trajkovski and Josipa Dolibašić TEST – RETEST RELIABILITY OF THE BENT ARM HANGING TEST FOR THE EVALUATION OF THE MUSCULAR STRENGTH OF PRESCHOOL CHILDREN	298

Biljana Trajkovski and Marjeta Mišigoj-Duraković DIFFERENCES IN MEASURES OF THE SUBCUTANEOUS FAT AMONG CHILDREN WITH REGARDS TO THEIR INCLUSION IN A SPORTS PROGRAM AT PRESCHOOL AGE	303
Eng Hoe Wee PERCEPTIONS OF NON-PE-MAJOR TEACHERS ON THE IMPLEMENTATION OF MALAYSIAN SECONDARY SCHOOL PE PROGRAM	307
Tomáš Vespalec and Jindřich Pavlík TRI-AXIAL ACCELEROMETER USAGE IN PEDAGOGICAL PROCESS IN CZECH ELEMENTARY SCHOOL	314
Michal Vít, Martin Bugala and Jan Šenkýř LEARNING OUTCOMES OF SELF-DEFENSE TEACHING IN HIGH SCHOOL PHYSICAL EDUCATION	318
Kamenka Živčić Marković, Lucija Milčić and Dan Lanc ANALYSIS OF THE QUALITY CHILDREN'S PLAYGROUNDS TO BE USED FOR LEARNING BASIC GYMNAS TIC CONTENT	322
Vlado Balaban and Gorica Bilak-Moconja ANALYSIS OF SELECTED MOTOR CHARACTERISTICS IN RELATION TO PHYSICAL ACTIVITY IN PRIMARY SCHOOL AGE CHILDREN	327
Vida Cesnaitiene and Justina Kairyte EXPRESSION OF PSYCHOLOGICAL FUNCTIONING DIFFICULTIES FOR PHYSICALLY ACTIVE AND PHYSICALLY INACTIVE 16-18-YEAR-OLD ADOLESCENTS IN THE PERIODS OF AUTUMN AND SPRING	328
Vjekoslav Cigrovski, Ivan Radman, Bojan Matković, Gurmeet Singh and Hrvoje Podnar EFFECTS OF ALPINE SKI SCHOOL ON ATTITUDE TOWARD ALPINE SKIING	329
Tamas Csányi, István Karsai, Mónika Kaj, Orsolya Marton, Ferenc Ihász, Gregory Welk, Weimo Zhu, Pedro Saint-Maurice, Kelly Laurson and Kevin Finn ASSESSMENT OF HEALTH-RELATED FITNESS IN HUNGARY: THE NETFIT, AS THE HUNGARIAN FITNESSGRAM INITIATIVE	330
Arunas Emeljanovas, Brigita Mieziene, Laura Tumynaite, Dovydas Mikalauskas, Magdalena Mo Ching Mok and Ming-kai Chin EFFECTS OF HOPSPORTS ON-LINE-STREAMING BRAIN BREAKS INTERVENTION PROGRAM IN PRIMARY SCHOOL	331
Nataša Sturza Milić THE INFLUENCE OF MOTOR EXPERIENCE ON MOTOR CREATIVITY (FLUENCY) OF PRESCHOOL CHILDREN	332
KINESIOLOGICAL RECREATION	
Herman Berčić and Maja Pori HEALTHY LIFESTYLE OF THE SLOVENIAN POPULATION AND CERTAIN FACTORS DISCUSSED IN INDIVIDUAL STUDIES	334
Ana Đerek, Ana Lenard and Danijel Jurakić THE MOST COMMON PHYSICAL RECREATION AND SPORT ACTIVITIES: CROSS-SECTIONAL STUDY IN CROATIAN GENERAL POPULATION	339
Gordana Furjan-Mandić, Mirna Strikinac and Josipa Radaš EXERCISING HABITS AND SUBJECTIVE QUALITY OF LIFE SELF-EVALUATION OF WOMEN ENROLLED IN GROUP FITNESS PROGRAMS	343
Daniela Gračan and Marina Barkidija SPORTS AND RECREATIONAL ACTIVITIES IN CROATIAN MINI CRUISER OFFER	348
Dražen Harasin and Petar Martinec INFLUENCE OF STEP LENGTH AND STEP FREQUENCY ON ENERGY CONSUMPTION WHILE WALKING ON THE INCREASE	352

Milena Mikalacki, Sandra Vujkov, Nebojsa Cokorilo and Darinka Korovljev FUNCTIONAL ABILITIES IN WOMEN OF DIFFERENT AGE	355
Aleš Sekot PHYSICAL ACTIVITIES VERSUS SEDENTARY SOCIETY: CZECH CONTEXT	359
Jana Stará and Michal Charvát WELLNESS PROGRAMMING FOR OLDER ADULTS	363
Gordana Grozdek Čovčić, Lukrecija Jakuš and Marina Horvat RECREATIONAL PHYSICAL ACTIVITY AND SELF-PERCEPTION OF HEALTH	366
Bulent Gurbuz and Erman Oncu MEANINGS OF LEISURE TO ADULTS WITH PHYSICAL DISABILITIES	367
Sergii N. Ivaschenko THE RELATIONSHIP BETWEEN THE STATE OF HEALTH IN YOUNG ADULTS AND THE MODE OF THEIR IMPELLENT ACTIVITY	368
Danijel Jurakić, Zrinka Greblo and Mirna Andrijašević MOTIVES FOR EXERCISING IN GENERAL POPULATION OF CROATIA	369
Daniel Mayorga-Vega, Humberto Blanco Vega, José R. Blanco Ornelas, Martha Ornelas Contreras and Jesús Viciano PHYSICALLY ACTIVE YOUTH MORE MOTIVATED TOWARD PHYSICAL EXERCISE REPORT LESS PERCEIVED EXERCISE BARRIERS	370
Ana Žnidarec Čučković and Katarina Ohnjec CHILDREN AND YOUTH INTERESTS IN THE CONTEXT OF PREVALENCE OF PHYSICAL ACTIVITIES AND SPORT	371
 KINESIOLOGY OF TOP-LEVEL SPORT	
Vladimir B. Issurin PERIODIZATION TRAINING FROM ANCIENT PRECURSORS TO STRUCTURED BLOCK MODELS	374
Cristina Casals, Patrik Drid, Marko Stojanović, Miodrag Drapšin and Sergej Ostojić SOMATOTYPES OF ELITE SERBIAN JUDOKAS FROM DIFFERENT WEIGHT CATEGORIES	375
Milan Čoh, Milan Žvan, Stanislav Peharec and Petar Bačić BIOPHYSICAL ANALYSIS OF DROP JUMPS IN FEMALE ELITE TRIPLE JUMP ATHLETES	379
Ruta Dadelienė, Einius Petkus, Rutenis Paulauskas, Kazys Milasius and Algirdas Raslanas STUDY OF ELITE FEMALE ROWERS' AEROBIC FITNESS DURING THE ANNUAL PREPARATORY CYCLE	383
Vedrana Grčić, Alen Miletić and Saša Krstulović PAIN STATUS MONITORING AMONG INTERNATIONAL COMPETITIVE SPORT DANCERS	386
Marko Hrgetić, Marko Milanović and Ivan Krakan THE DIFFERENCES BETWEEN THE GROUPS OF PLAYERS AT DIFFERENT LEVELS OF COMPETITION IN THE TESTS FOR ASSESSING FITNESS PREPAREDNESS	389
Rasa Kreivytė FREE THROWS NUMBER AND ACCURACY IMPACT ON THE RESULT OF BASKETBALL GAME	393
Goran Leko and Klara Šiljeg EFFECTS OF ANAEROBIC TRAINING IN FEMALE SWIMMERS	396
Dragan Milanović, Aleksandar Selmanović and Dario Škegro CHARACTERISTICS AND DIFFERENCES OF BASIC TYPES OF OFFENSES IN EUROPEAN AND AMERICAN TOP-LEVEL BASKETBALL	400

Hrvoje Sertić, Marko Žaja and Ivan Segedi DIFFERENCE IN IMPORTANCE OF HAND AND LEG TECHNIQUES IN THE COMPETITIVE KICKBOXING DISCIPLINES	404
Kenneth Swalgin THE RELATIONSHIP BETWEEN THE NUMBER OF PASSES IN A POSSESSION AND THE PROBABILITY OF SCORING IN MEN'S DIVISION I COLLEGE BASKETBALL IN THE UNITED STATES	409
Saša Vuk BILATERAL DIFFERENCES IN PUNCH VELOCITY AND ACCURACY IN TAEKWONDO ATHLETES	417
Eiko Yamada EVALUATION OF ATTACK-CONTRIBUTION IN COLLEGIATE WOMEN'S HANDBALL	422
Mario Baić, Hrvoje Karninčić and Dražen Šprem BEGINNING WITH WRESTLING, WRESTLING EXPERIENCE AND WRESTLING MATURITY – TRENDS IN 2002-2012	425
Petar Barbaros Tudor, Miroslav Zečić and Bojan Matković DIFFERENCES BETWEEN 2010 AND 2011 SITUATION-RELATED INDICATORS OF TENNIS PLAY EFFICIENCY AT THE GRAND SLAM TOURNAMENTS – ROLAND-GARROS, WIMBLEDON AND US OPEN	426
Renata Barić and Marko Mijić DOES A RED FIGHTER WIN MORE OFTEN IN TAEKWONDO FIGHTS?	427
Boris Bazanov HOW TO REDUCE THE DURATION OF JUMP SHOT IN BASKETBALL?	428
Tomislav Đurković, Nenad Marelić and Tomica Rešetar DIFFERENCES IN AEROBIC CAPACITY INDICATORS BETWEEN CROATIAN NATIONAL TEAM AND CLUB LEVEL VOLLEYBALL PLAYERS	429
Tina Erceg, Sunčica Delaš Kalinski and Mirjana Milić THE SCORE DIFFERENCES BETWEEN ELITE EUROPEAN JUNIOR AND SENIOR WOMEN GYMNASTS	430
Zdeněk Janík NEW APPROACH IN COACHING AND METHODOLOGICAL PRACTICE	431
Mikola Misjuk, Indrek Rannama and Ervin Kõll ISOKINETIC MUSCLE STRENGTH, ASYMMETRY AND H:Q RATIO OF SOCCER PLAYERS ACCORDING TO PLAYING POSITION	432
Salvatore Napolitano, Daniela Tursi and Domenico Tafuri CLIFF DIVING: EVALUATION OF THE IMPACT WITH THE WATER AND PERFORMANCE ANALYSIS	433
Indrek Rannama, Kristjan Port and Boris Bazanov RELATIONSHIP BETWEEN ISOKINETIC MUSCLE STRENGTH AND KINEMATICS OF SPRINT CYCLING	434
Ivan Segedi and Hrvoje Sertić CLASSIFICATION OF JUDO THROWING TECHNIQUES ACCORDING TO THEIR IMPORTANCE IN JUDO BOUT	435
Goran Sporiš, Vlatko Vučetić, Luka Milanović, Zoran Milanović and Marino Krespi A COMPARISON OF ANAEROBIC ENDURANCE CAPACITY IN ELITE SOCCER, HANDBALL AND BASKETBALL PLAYERS	436
Richard Stretch RELATIVE AGE EFFECT IN ELITE SOUTH AFRICAN CRICKETERS	437

MANAGEMENT OF SPORT

Gregor Jurak, Stevo Popović, Damjan Jakšić, Edvard Kolar, Wladimir Andreff and Jakob Bednarik THE IMPACT OF THE GLOBAL ECONOMIC CRISIS ON THE FINANCES IN SPORT: CASE OF SLOVENIA	440
Jana Nová SPORT MANAGEMENT AS AN INTEGRAL PART OF KINANTHROPOLOGY	447
Sanda Čorak, Snježana Boranić Živoder and Zrinka Marušić STRATEGIC MANAGEMENT ISSUES OF CROATIAN NATIONAL SPORT FEDERATIONS	451
Lorena Dadić FINANCING SPORTS ASSOCIATIONS IN CONDITIONS OF ECONOMIC CRISIS – A CASE STUDY: THE CITY OF RIJEKA	456
Alen Jerkunica, Ivana Jadrić and Josip Zec ECONOMIC IMPACTS OF FIFA WORLD CUPS	461
Eli Marušić, Katija Kovačić and Duje Petričević THE STRATEGIC ORIENTATION AND PERFORMANCE OF FOOTBALL CLUBS	465
Marko Perić and Nensi Puškarin Radun SPORTS FACILITY MANAGEMENT – CASE STUDY: MULTI-PURPOSE HALL / ICE RINK IN DELNICE	469
Iztok Retar, Saša Pišot and Edvard Kolar SOCIAL COMPETENCES OF SLOVENIAN SPORT MANAGERS	473
Duško Bjelica, Stevo Popović, Damjan Jakšić, Rašid Hadžić and Selçuk Akpınar HOW DOES ADVERTISING THROUGH SPORT WORK? EVIDENCE FROM TURKEY	477
Miroslav Mandić and Morana Fudurić SPORTING EVENTS WITH A CAUSE: THE CASE OF CROATIAN RUGBY UNION AND WOMEN'S SHELTER	478
Sanela Škorić and Mato Bartoluci PLANNING IN CROATIAN NATIONAL SPORT FEDERATIONS	479
Irena Valantine, Ingrida Krikstaponyte and Gytis Junevicius CLUSTER AS A POSSIBILITY FOR SPORT SECTOR	480

KINESIOLOGY IN SOCIAL SCIENCES AND HUMANITIES

Annette R. Hofmann FACING CHALLENGES: AN INTERNATIONAL PERSPECTIVE OF SPORT HISTORY IN ACADEMIA	482
Zrinko Čustonja CROATIAN SOKOL OR HOW DID POLITICS INFLUENCE ON EARLY DEVELOPMENT OF SPORTS AND PHYSICAL EXERCISE IN CROATIA	483
Mabrouk Mohamed Aboamaed and Sarmad Ahmed Mousa ACHIEVEMENT MOTIVATION AND ITS RELATIONSHIP WITH CONCERN THE FUTURE AMONG THE STUDENTS OF THE UNIVERSITY OF TRIPOLI	486
Boris Balent and Ksenija Bosnar AN ATTEMPT TO IMPROVE OPERATIONAL DEFINITION OF MINDSET IN SPORT CONCEPT	490
Sunčica Bartoluci NATIONAL IDENTITY AND HANDBALL - IMAGE OF THE CROATIAN SOCIETY?	495
Saša Ceraj ROLE AND SIGNIFICANCE OF THE INTERNATIONAL OLYMPIC ACADEMY FOR THE OLYMPIC MOVEMENT	499

Jitka Čihounková and Michal Vít	
KARATEKAS OF VARIOUS STYLES PLACING ASSOCIATIONAL WORDS CONNECTED WITH TRAINING OF MARTIAL ART	503
Petra Dolenc	
PHYSICAL SELF-CONCEPT IN ADOLESCENT ATHLETES: RELATION TO GENDER, AGE, TYPE OF SPORT AND TRAINING FREQUENCY	507
Tjaša Geržević and Mitja Geržević	
MOTIVES AND ATTITUDES OF NURSING HOME RESIDENTS TOWARDS EXERCISING IN THE SENIOR EXERCISE PARK: A PRELIMINARY REPORT	511
Petr Hrusa	
DEPENDANCE OF NEGATIVE EXPRESSIONS OF BASKETBALL PLAYERS' BEHAVIOUR ON THE FREQUENCY OF REFEREES	516
Živko Kalentić, Snežana Vujanović, Nenad Sudarov, B. Strajnić, Branko Đukić and Nebojša Vujkov	
SPECIFIC ASPECTS OF FOOTBALL GOALKEEPERS MENTAL POTENTIAL IN RELATION TO OTHER PLAYERS IN THE TEAM	520
Jan Mach, Viktor Pacholík, Sylva Hřebíčková and Damjan Siriški	
ANALYSIS OF THE DYNAMICS OF SUBJECTIVE MENTAL STATES DURING COMPETITIVE ACTIVITY OF CZECH ELITE TRACK CYCLISTS	525
Michal Mazurkiewicz	
BODY, MOVEMENT AND SPORT IN AMERICAN PAINTING	529
Darija Omrčen and Hrvoje Knežević	
EXPRESSING KEY CONCEPTS IN HUMAN MOVEMENT SCIENCE: ANALYSIS OF FOOTBALL-RELATED ARTICLES' TITLES	532
Franjo Prot, Boris Balent and Ksenija Bosnar	
GENDER DIFFERENCES IN SPORT MINDSET	537
Leo Rafolt	
RITUAL FORMALISM OF THE JAPANESE KORYU BUDO: A SOCIO-ANTHROPOLOGICAL APPROACH	540
Zdenko Reguli, Jitka Čihounková and Martin Sebera	
FLOW STATE OF DIFFERENT LEVELS IN AIKIDO PRACTITIONERS	544
Dejan S. Savičević, Maja S. Cvijetić and Zdravko B. Ivanković	
TOTAL PHYSICAL RESPONSE AND SECOND LANGUAGE ACQUISITION	547
Tanja Stibilj Batinić, Vjeran Švaić and Janko Babić	
DIFFERENCES IN EMOTIONAL COMPETENCE BETWEEN INDIVIDUAL AND TEAM SPORTS ATHLETES	552
Iлона Tilindiene and Tomas Stupuris	
THE FEATURES OF SELF-ESTEEM AND AGGRESSION IN ADOLESCENT ATHLETES AND NON-ATHLETES	556
Jadranka Vlašić, Zlatka Glavurtić and Goran Oreb	
THE ATTITUDE OF THE PRESCHOOL CHILDREN'S PARENTS IN ZADAR AND ZAGREB TOWARDS DANCE	561
Dinko Vuleta jr. and Ivana Klaričić	
THE INFLUENCE OF THE SOCIAL STATUS, MICRO SOCIAL TEAM STRUCTURE AND GROUP COHESION ON THE SCORING EFFICIENCY OF ELITE CROATIAN JUNIOR NATIONAL TEAM HANDBALL PLAYERS	566
Irena Auersperger, Branko Škof, Bojan Leskošek, Bojan Knap, Aleš Jerin, Mitja Lainščak and Tanja Kajtna	
BIOCHEMICAL, HORMONAL AND PSYCHOLOGICAL MONITORING OF EIGHT WEEKS ENDURANCE RUNNING TRAINING PROGRAM IN FEMALE RUNNERS	571

Dušan Macura, M. Toni and Mojca Doupona Topič THE MORAL POTENTIAL OF SPORT VALUES	572
Benjamin Perasović, Renata Franc and Marko Mustapić PREVALENCE AND SOCIODEMOGRAPHIC CORRELATES OF YOUTH ORGANIZATIONAL SPORT ENGAGEMENT	573
Dario Škegro and Zrinko Čustonja BEGINNINGS OF EDUCATION AND TRAINING FOR CONDUCTING PHYSICAL EDUCATION CLASSES IN CROATIA – 140 YEARS OF TRADITION	574
Paola Vago, Francesco Casolo, Ferdinando Cereda, Monica Gatti and Furio Danelon PERSONALITY TRAITS AND REHABILITATION: INFLUENCE ON OUTCOME FOLLOWING ACL RECONSTRUCTION	575
Jesús Viciana, Humberto Blanco Vega, José R. Blanco Ornelas, Martha Ornelas Contreras and Daniel Mayorga-Vega ANALYSIS OF MOTIVATION OF MEXICANS TOWARDS SPORT	576
 KINESIOLOGY IN PHYSICAL CONDITIONING	
Steven J. Fleck NONLINEAR PERIODIZATION: RESEARCH AND PRACTICE	578
Tea Bešlija, Ana Kezić and Mario Tomljanović RELATIONS BETWEEN FUNCTIONAL MOVEMENT SCREEN AND STANDING LONG JUMP IN CHILDREN	579
Mate Brekalo, Dragan Milanović and Petra Zaletel THE EFFECTS OF A TRAINING PROGRAM FOR THE DEVELOPMENT OF STRENGTH AND POWER IN JUNIOR BASKETBALL PLAYERS	582
Marin Dadić, Luka Svilar and Luka Milanović EFFECTS OF PLYOMETRIC TRAINING ON EXPLOSIVENESS AMONG JUNIOR FOOTBALL PLAYERS	588
Petra Drušković, Jelena Paušić and Jeremy Todd DOES THE USE OF FOAM ROLLER HAVE AN INFLUENCE ON RECTUS FEMORIS ELONGATION?	592
Lauras Grajauskas THE IMPACT OF DIFFERENT TRAINING METHODS ON 12–14-YEAR-OLD BOYS ORIENTEERING SKILLS AND HEART RATE RESPONSES	595
Kemal Idrizović and Marko Aleksandrović THE CHRONOLOGICAL AGE AS THE IMPACT FACTOR OF PHYSIOLOGICAL CHARACTERISTICS ON TRACK AND FIELD EVENT LONG JUMP	598
Hrvoje Karninčić, Mario Baić and Kristijan Slačanac METRIC CHARACTERISTICS OF THE NEWLY CONSTRUCTED QUESTIONNAIRE FOR ASSESSING THE KNOWLEDGE OF WRESTLING COACHES ON NUTRITION AND DOPING	602
Gun Do Kim and Willy Pieter MODELING ISOKINETIC STRENGTH IN RECREATIONAL ADOLESCENT KARATE ATHLETES	607
Marek Kokinda THE ASSOCIATION BETWEEN PHYSICAL DEVELOPMENT AND SPORTS TRAINING IN SPECIALIZED ICE HOCKEY CLASSES	611
Rūtenis Paulauskas, Rūta Dadelienė and Mindaugas Balčiūnas CHANGES IN PHYSICAL DEVELOPMENT, PHYSICAL FITNESS AND FUNCTIONAL CAPACITY OF YOUNG BASKETBALL PLAYERS AGED 16-19 YEARS	615
Denis Pudja, Ana Forko and Cvita Gregov ECCENTRIC EXERCISE IN TREATMENT OF TENDINOPATHY	620

Ante Rađa, Marko Erceg and Zoran Grgantov KICKING ACCURACY OF CROATIAN U-16 SOCCER PLAYERS	630
Pavel Ruzbarsky, Viera Smerecka and Jozef Moroscak INTRAINDIVIDUAL ASSESSEMENT OF AEROBIC AND ANAEROBIC FITNESS IN ICE HOCKEY PLAYERS THROUGHOUT ANNUAL TRAINING CYCLE	634
Ondřej Smolka, Michal Kumstát and Iva Hrnčířiková CAFFEINE INTAKE ENHANCES ENDURANCE PERFORMANCE IN SUB-ELITE BUT NOT IN ELITE ATHLETES	638
Marijan Tomašić, Marijana Čavala and Ratko Katić DIFFERENCES IN MORPHOLOGICAL AND MOTORICAL ABILITIES BETWEEN JUNIORS AND SENIORS IN BASEBALL	642
Pavel Vacenovský and Tomáš Vencúrik THE EFFECT OF SPECIFIC WARM-UP ON REACTIVE AGILITY IN TABLE TENNIS	646
Vlatko Vučetić, David Zubčić, Gordana Jukić and Igor Jukić EVALUATING THE INFLUENCE OF BIOENERGY ON PHYSIOLOGICAL PARAMETERS IN THE RECOVERY AFTER HIGH - INTENSITY STIMULATION	650
Vlatka Wertheimer THE EFFECT OF AQUATIC PLYOMETRIC TRAINING ON PHYSICAL PERFORMANCE	654
Cvita Gregov and Sanja Šalaj THE EFFECTS OF DIFFERENT TRAINING MODALITIES ON BONE MASS: A REVIEW	658
Dajana Jašić EFFECT OF MOTOR ABILITIES TO RESULT IN SWIMMING 11-YEAR OLD BOYS	660
Egle Kemeryte-Riaubiene, Nijoje Jascaniniene, Sniegina Poteliuniene and Virginija Juodvirse THE IMPACT OF AEROBIC GYMNASTICS PHYSICAL LOADS ON THE 6-11 YEARS GIRLS' PHYSICAL AND FUNCTIONAL STATUS	661
Marko Sukreški, Josip Zekić and Tajana Geršić COMPARISON OF FOUR METHODS FOR DETERMINING THE ANAEROBIC THRESHOLD	662
Satellite Symposiums:	
ADAPTATION OF HUMAN ORGANISM TO DISUSE AND AGEING	
Boštjan Šimunič TENSIOMYOGRAPHY – PAST AND FUTURE DIRECTIONS?	664
Saša Pišot and Uroš Marušič GENDER RELATED DIFFERENCES OF PHYSICAL ACTIVITY AMONG OLDER ADULTS	668
Dušan Hupka COMPARISON OF WALK FORCE CHARACTERISTICS OF CZECH ADULT WOMEN	672
Uroš Marušič EFFECTIVENESS AND TRANSFER OF COMPUTERIZED COGNITIVE TRAINING ON COGNITIVE AND PSYCHOMOTOR FUNCTIONS IN OLDER ADULTS DURING PROLONGED INACTIVITY	676
Tomáš Vodička, Martin Zvonař and Martin Sebera ISOKINETIC STRENGTH IN LEUKEMIA PATIENTS PRIOR TO AND AFTER TREATMENT – PILOT STUDY	680
Lina Cancellara, Luana Toniolo, Tatiana Moro, Katja Koren, Antonio Paoli and Carlo Reggiani EFFECTS OF TWO WEEKS OF BED REST AND SUBSEQUENT REHABILITATION ON SIZE AND FUNCTION OF SINGLE MUSCLE FIBRES	682

Filippo Giorgio Di Girolamo, Sara Mazzucco, Martina Lanza, Nina Mohorko, Roberta Situlin, Rado Pišot and Gianni Biolo	
AGEING IS ASSOCIATED TO A LOWER DEGREE OF INSULIN RESISTANCE DEVELOPMENT, AS INDUCED BY 14-D EXPERIMENTAL PHYSICAL INACTIVITY	683
Tariq Ali Gujar and Anita Hökelmann	
COMPARATIVE STUDY OF YOUNG AND SENIOR PEOPLE ELECTROENCEPHALOGRAPHY ACTIVITY DURING SENSORY ORGANIZATION BALANCE TEST IN RESPECT OF VISUAL FUNCTION	684
Sara Mazzucco, Filippo Giorgio Di Girolamo, Martina Lanza, Nina Mohorko, Roberta Situlin, Rado Pišot and Gianni Biolo	
EFFECTS OF AGEING ON THE DEVELOPMENT OF ANABOLIC RESISTANCE DURING EXPERIMENTAL BED-REST, AS ASSESSED BY A SIMPLIFIED STABLE ISOTOPE-BASED METHOD	685
Enrico Rejc, Alberto Botter, Mirco Floreani, Rado Pišot, Pietro di Prampero and Stefano Lazzer	
EFFECTS OF 14 DAYS OF BED REST AND FOLLOWING PHYSICAL TRAINING ON THE MAXIMAL EXPLOSIVE POWER OF LOWER LIMBS IN ELDERLY AND YOUNG HEALTHY MALES	686
UNIVERSITY SPORT AND PHYSICAL ACTIVITY	
Ensar Abazović, Đurdica Miletić and Erol Kovačević	
MONITORING THE SUBJECTIVE EXERCISE EXPERIENCE IN PHYSICAL EDUCATION STUDENTS	688
Romana Caput Jogunica, Biserka Vrbek and Sanja Ćurković	
ATHLETES AND EDUCATION: WHAT SHOULD WE DO TO SUPPORT ATHLETES IN DUAL CAREER DEVELOPMENT?	692
Katja Cerar and Miran Kondrič	
GENDER DIFFERENCES OF MOTIVATIONAL FACTORS IN STUDENTS FOR SPORTS ACTIVITIES	696
Josip Cvenić and Renata Barić	
THE CONSTRUCT VALIDITY OF THE FIGURE RATING SCALE BASED ON ESTIMATES OF FEMALE STUDENTS AT THE UNIVERSITY IN OSIJEK	698
Sanja Ćurković, Mirna Andrijašević and Romana Caput-Jogunica	
PHYSICAL ACTIVITY BEHAVIORS AMONG UNIVERSITY STUDENTS	703
Stanislav Dadelo	
MOTIVATIONAL CHARACTERISTICS OF LITHUANIAN STUDENTS' IN PHYSICAL EDUCATION	707
Ksenija Fučkar Reichel, Natalija Špehar and Jelka Gošnik	
THE LEVEL OF PHYSICAL ACTIVITY OF UNDERGRADUATE STUDENTS AT THREE FACULTIES OVER A SEVEN-DAY PERIOD	712
Marija Lorgjer and Mateja Kunješić	
ABILITY REALIZATION OF COMPLEX MOTOR STRUCTURES WITH FACULTY OF TEACHER EDUCATION STUDENTS	717
Tonći Mašina, Miroslav Zečić and Davor Pavlović	
GENDER DIFFERENCES IN SOME ANTHROPOMETRIC AND MOTOR CHARACTERISTICS AMONG STUDENTS OF ZAGREB UNIVERSITY SCHOOL OF MEDICINE	722
Tihana Nemčić and Mladen Sedar	
MOTIVATIONAL DIFFERENCES FOR PLAYING FUTSAL AMONG ZAGREB UNIVERSITY STUDENTS	726
Josipa Radoš, Gordana Furjan Mandić and Maja Horvatin Fučkar	
THE INFLUENCE OF RHYTHMIC GYMNASTICS TREATMENT ON FLEXIBILITY OF FEMALE STUDENTS FACULTY OF KINESIOLOGY	731

Aleksandar Selmanović, Matija Čale-Mratović and Đivo Ban ANALYSIS OF THE IMPACT OF HEALTH-RELATED HABITS ON THE BODY COMPOSITION OF STUDENTS IN DUBROVNIK	734
Katja Bilić A ROLE OF PHYSICAL ACTIVITY IN EXPLANATION OF MENTAL AND PHYSICAL HEALTH SYMPTOMS AMONG UNIVERSITY STUDENTS	739
HEALTH KINESIOLOGY	
Stjepan Heimer HEALTH KINESIOLOGY STUDY	742
Joao Breda HEALTH-ENHANCING PHYSICAL ACTIVITY IN WHO EUROPEAN REGION	746
Sanja Musić Milanović PUBLIC HEALTH AND HEALTH KINESIOLOGY – THE CORE FIELDS FOR MUTUAL COOPERATION	748
Herbert Hartmann GRASSROOTS SPORTS – A FIELD FOR REALISATION OF HEALTH KINESIOLOGY IDEAS	750
Danijel Jurakić and Daniel Bok THE PROFESSIONAL AND SOCIAL SIGNIFICANCE OF HEALTH KINESIOLOGY FOR EXPERTS IN KINESIOLOGY	755
Goran Sporiš and Stjepan Heimer SOUTH-EAST EUROPEAN POSTGRADUATE HEALTH KINESIOLOGY STUDY – A PROPOSAL	757
LATE SUBMISSION	
Mario Luca Morieri, Cecilia Soavi, Daniela Francesconi, Juana Maria Sanz, Sonia Poma, Giovanni Zuliani and Angela Passero THE EFFECT OF 14 DAYS OF BED REST ON THE LIPID AND INFLAMMATORY PROFILE ON THE ELDERLY	760
INDEX OF AUTHORS	761



Adapted Physical Activity and Kinesitherapy

**7th INTERNATIONAL
SCIENTIFIC
CONFERENCE ON
KINESIOLOGY**

**FUNDAMENTAL
AND APPLIED
KINESIOLOGY – STEPS
FORWARD**

**Editors:
Prof. Dubravka Ciliga, PhD
Tatjana Trošt Bobić, PhD**

**Peer Reviewers:
Prof. Dubravka Ciliga, PhD
Prof. Maria Dinold, PhD
Prof. Iris Zavoreo, PhD**



THE IMPACT OF DANCE AND CREATIVE ACTIVITIES ON THE QUALITY OF LIFE OF INDIVIDUALS WITH DISABILITIES

Maria Dinold

University of Vienna, Centre for Sport Science and University Sports, Austria

Abstract

Dance, creative dance in specific, is known as a means in artistic, educational, and therapeutic context. When working with people with a disability all three structural elements can be used for the enhancement of personal development and quality of life. With reference to the main components of inclusive dance pedagogy some long time experience and a few research results could identify the most important impact factors in this concern. Given that inclusive offers have mutual influence on the participants with and without disabilities in a dance class some qualitative perceptions could be stated.

Key words: creative dance, inclusive dance pedagogy, disability, impact on personal development

Introduction

The elements of dance include movement – structured by form, time, space and their dynamic variations. It is said that dancing can inhibit personal development, intrinsic learning, self-reflection, and self-expression. In order to justify the use of this means in adapted physical activities the aspect of creativity helps to explain the effects. The pioneers of “creative and/or expressive dance” provided examples how dancing may be seen as an important art form as well as a pedagogical and therapeutic tool. This contribution will identify those factors that are supposed to promote personal development and quality of life – especially for persons with a disability.

If we talk about dance therapy it might not concern all individuals, but more or less those with some psychiatric or developmental disorders. If we talk about dance education it might concern those individuals who are identified to be talented to become professional dancers. Looking at dance as an art form a wide range of styles can be distinguished and it stresses a great mastery of performance. Because of so many different interpretations the term dance pedagogy – inclusive dance pedagogy in specific – is chosen as the most appropriate notion to apply dance in this context.

Dance and creativity in art, therapy and pedagogy

When thinking about dance as an art form an older quote from Margaret H'Doubler (1957, p. 47) is appropriate: “Dance as an art, when understood, is the province of every human being.” She calls dance “a creative art experience” and refers to related thoughts of other earlier artists and philosophers who later on have been reassured by modern artists who said: *everyone can be an artist* (Joseph Beuys in fine arts or Steve Paxton by using every day's movement in artistic performance). Her restricting opinion suggests that “not everyone can be an artist in the more limited sense of the word. But, if we recognize that it is the nature of the original impulse that leads to creative activity, and the emotional value of its expression that distinguishes any activity as art, then we shall see that he who approaches his work in a creative spirit and makes it the expression of his own vision of life is an artist.” (p. 53). The all-important factor involved seems to be creativity. “Art is creation. For the artist it is creation by expression; for the appreciator it is creation by evocation.” (Hirn, 1900, quoted in H'Doubler, 1957, p. 53).

Creativity and *interaction* are the two elements which work in art, as well as in therapy and pedagogy. Milani-Comparetti (1998) suggests that their roots are already dispositional as an autonomous initiative of the fetal human individual. His approach of “*dialogue*” might be applied in a medical-therapeutic as well as in a pedagogical-educational context and it supports the idea that the competence for *suggesting*, seen as a *creative intention* of the child, has to be put in the center of all considerations of a health medicine. He leans up against traditional therapeutic and pedagogical methods, which favor a stimulus – response attitude. He trusts in the belief that a child/individual is able to learn/ to develop if he/she wants to do it him/herself. It is the task of the parent to observe the child's proposals (however they come forward), to seize them and start a dialogue by bringing in a counter-proposal (Bews, 1992). *Creativity* can be assigned for being the engine of interaction.

Looking at creativity from the therapeutic perspective we may refer to a definition by Bean (1994): “Creativity is the process across which an individual may express his/her original nature through his body or another media providing a deep sensation of fulfillment” (p. 15). Another description is valued as a problem solving competence when suggesting:

“We become creative in the moment when we cannot find an appropriate solution of a problem by means which are known to us, and when at the same time it is strongly in our interest to solve this problem” (Kast, 1994, p. 24). When translating the term from the Latin word “*creare*” it means “the ability to develop something new” or “to give birth to something”, and this implicates a duality of the creative activity. The term is often associated with art and unsurprisingly there is given much attention to the creative process in all the art forms.

Some female dancers in the early and middle twentieth century in Europe (Germany: Mary Wigman, Switzerland: Trudi Schoop, Austria: Rosalia Chladek) and USA (Isadora Duncan, Martha Graham) tried to establish creative/expressive dance as an art form and became forerunners for new forms of modern, post-modern or later contemporary dance styles. It was their intention to put emphasis on inner feelings which urge to be expressed through the body in an individual way.

A psychological assertion is confirmed by Petzold & Orth (1991) when they talk about the creative dimension of dance which is made possible by the activation of basic abilities of the creative human being. The kinesthetic activity of the sensory system, which is predominantly responsible for expressive movement, is producing within a self-induced activity and via an interactive processes (perception – impression – integration – expression - effect) a media of relation (e.g. dance). The sensation, the assimilation, and the transfer into creative movement induce the emergence of changes. These shifts may help to accept developmental events and to identify again the individual personality and his/her social interpersonal relations (Dinold, 2004).

Creative dance seen as personal expression is used in *education* aiming at the achievement of self-induced activity and autonomy which works because of two aspects: “... one, the capacity to take in, to become impressed; the other, the capacity to give out, to express. To receive impressions informs the mind, but to express its reactions to these impressions requires coordination and cooperation of all mental powers. (...) The concern should be to develop the power of expression through the study of dance.” (H'Doubler, 1957², p. 62).

Inclusive Dance Pedagogy

What makes the difference between dance education and inclusive dance pedagogy? In the context of adapted physical activity and kinesiotherapy it is the target group which makes the difference. The perspective of education is not as much on the development of specific skills but on the holistic development of the individuals. The elements and beneficial factors of an inclusive setting for people with and without disability may have psychomotor, cognitive, emotional and socio-psychological character. The methods used do not differ too much from usual dance pedagogy but should have a particular focus depending on the necessary adaptations.

Psychomotricity

Psychomotricity has existed as a concept since the 1930'ies and already in the early 40'ies, formal education styles using psychomotricity were founded. Over the years, the concepts have developed parallel to each other in the various countries. There was not very much contact between them. The term psychomotricity is related to the interdependency of cognition, emotion and motion – and its significance for the development of the competence to act in the psycho-social context. The distinctive time of developing the child's “physical literacy” (Whitehead, 2010) starts already in early childhood and has to be developed lifelong. Through play children develop their psychomotricity and relate to the world around them, through the action of their bodies they situate themselves in time and space, and improve their quality of life and well-being. Moreover, they prepare and resolve anxiety-generating situations which are part of their daily lives. On interacting with adults (in previously planned and duly recorded activities), children learn how to speak and internalize values, concepts, social roles, and the cultural repertoire, while empowering themselves and asserting their existence as social beings. In case of inhibit interaction with the environment (impairment, disorder, disability) of the child psychomotor interventions may help.

Usually, in Austria and Germany psychomotricity includes five guiding principles:

Holistic Approach – the individual is seen as a bio-psycho-social unit

Development oriented – curiosity is seen as the driving force for individual development

Action oriented – the individual becomes autonomous by learning how to direct oneself

Resources oriented – the concept starts from the strengths of an individual

Voluntariness – the person has to find out his/her own decisions

These principles have to be combined with four dimensions, which are considered when working with the clients of all ages: time, space, relation, and meaningful content. The components time and space are the most important when building up dance structures – they are created by rhythmic figures as well as by shapes in space and time. In order to make this visible and meaningful the dancers have to be in relation, they learn to communicate and to interact, and individual needs have to be respected.

Rhythmic movement education

The concept of *Rhythmic Movement Education* pursues three important goals: stimulation of the senses, development of creative abilities, and social learning. (Witoszynskyj, Schindler, & Schneider, 2001). With this in mind a similarity with the earlier mentioned concept can be identified. By stimulating the sensory system the children are invited to discover their individual abilities, they become curious about the next activity which should be accomplished, and they can find it based on their own decision making. Nobody should tell them to do a movement in a certain way. They will become creative themselves – they develop their own creative learning; they observe the process of creating and may admire their own product (a dance piece, a theater scene, a song or a game, etc.) at the end.

Developmental Movement

Similar pedagogical aims are intended by the concept of *Developmental Movement* (Sherborne, 1990/1998). The various possibilities how young children (mainstream or with special needs) can learn and develop their abilities are strongly connected to relationship – moving in relation. Sherborne (1990, p. 5) distinguishes three types of relationship play: “caring” or “with” relationships; “shared” relationships, and “against” relationships. In the German translation (by Christian Dirjack) “caring” is explained as interacting with somebody with care, “shared relationships” are characterized by alternating contacts, and in “against relationships” someone’s power is used against the power or the resistance of another person or surface. In her summary Sherborne (1990, p. 111) emphasizes that developmental movement can help the children in the two areas: *physical development* (“feel at home in their bodies, learn to use and control their bodies, develop general skills”) and the *development of personality* (sense of self, identity, confidence in their own abilities, use inventiveness, be sensitive to needs and feelings of others, etc.).

Sherborne’s approach uses the movement analysis system of Rudolf von Laban who has to be named when talking about educational and creative dance. He had founded and later influenced many artists (see p. 2), teachers and therapists who used dance as a means for their intervention – and many examples could serve as representative role models.

MiteinanderS

The elements, partly taken from the three mentioned approaches, used in the concept called “MiteinanderS” – meaning *together but different* (Dinold & Zanin, 1996) intend to support cultural inclusion and personal development through dance, theater, creative movement and spontaneous play. By collecting feedbacks of the participants in the workshop offers of this working method over some years as well as by a qualitative study the most important impact factors of this approach and the components which are effective in practical teaching could be found.

Impact Factors

Investigations about possible influence on personal development through dance and creative movement for individuals with and without disabilities (Dinold, 2000) identified some important factors:

The significance of movement when used as a media of creative expression;

The importance of the coherence of perception and movement;

The development of personal identity;

The impact of *structures of space and time in dance* on the individuals’ development of orientation in space and time.

According to the chosen title it seems appropriate to discuss just the factors which contribute to the *development of personal identity* – given that such a development secures the quality of life of individuals with disabilities. Developing/establishing one’s own identity is in the focus of Erikson’s psycho-social theory of development (1973). He described this progression according to the dominant influencing emotional components which are active at a time: struggling between two polarities (e.g. trust –distrust, autonomy – disbelief, initiative – liability). Goals like “establishing own identity”, “developing trust”, “fostering independence” are used purposely in many concepts of dance therapy. When dancing – it is possible to discover new qualities of self-experience. “Basic dance is the externalization of those inner feelings which cannot be expressed in rational speech but can only be shared in rhythmical, symbolic action.” (Chaiklin, 1975, p. 203).

Creative movement and dance are proper means in supporting the development of the necessary demands. The following tasks may be seen as examples for such demands: for developing *trust* you may work with material which can be used to cover the body; for building *autonomy* and *declared intention* it seems helpful to offer several options for solving a movement task; for promoting *initiatives* the students can be invited to take over new roles or to cope with an unknown task. One of many important aspects of developing identity by dancing activities is realized by providing multiple body experiences in order to have a positive picture of the body, to come to know its limitation, to be aware of the body’s opportunities of expression and to establish one’s perceived competence.

Feedbacks collected from the participants after the practical inclusive dance workshops, offered in Vienna in a period of time of about three years, gave a rough picture about the factors which are appreciated and what kind of work might not be that successful. This way the following benchmark of the concept had been identified:

Connecting factor: Daily Life – this means that the creative work must start with playful offers which reflect daily life of the participants but will then lead to new intensive experiences

Atmosphere of acceptance, appreciation, fun, awareness – the atmosphere of familiarity may develop when there is the feeling of security, openness, joy, and satisfaction of expectations and personal needs;

Dancing – dance is said that it facilitates: personal encounter, security, expression of feelings, intensive self and social awareness;

Use of material – material (balls, water, textures, etc.) promotes adventure, sensitivity, sense of balance and motion;

Flexible structures – structures are important to keep the track, but must be flexible in order to adapt to the individual needs of the dancers.

A follow-up study (Dinold 2000) identified different effects on persons with and without disability. The qualitative investigation carried out in form of problem-centered interviews with persons with and without disabilities who had participated in the dance and creative movement program over a period of time of at least three years aimed to find out possible changes of personal development. Integrating the results of the two groups who had been asked a comparing analysis focusing on how the offers met the needs of each individual appropriately was made. An obvious difference could be evaluated concerning motivations and expectations on dance and movement. *People with a disability* were very much motivated to go through joy, fun, and excitement when moving and dancing. They seemed to be grateful for the fact that their limitations eventually were not ignored. Such a self-experience was not the main interest of *participants without impairments*. Many of them were more interested in the methodical approach and the ways of addressing persons with a disability by dance and theater. But, nevertheless, some of them valued the movement quality for not being technically too demanding but stressing individual creative abilities.

Positive influence on all participants could be recognized in respect to relationships, getting in touch with each other and in continuous interaction. The attraction for each other varied from being especially attracted by persons belonging to the same group (e.g. because the woman with paralyzed legs found another partner in a wheelchair who could share the same impressions) or to quite the opposite. Experiencing and going through something new, something very different, could cause feelings of sympathy and attraction. High creative energy made it easy to allow big things to arise from small initiatives. These effects were mentioned as the reasons for evaluating the experience being successful and fulfilling.

Conclusion

In order to report on personal beneficial factors of participating in dance and creative activities two main points have to be accentuated:

Individuals with disabilities develop towards a higher level of self-consciousness, openness and autonomy. They emphasized their enlargement of experience and quality of life by coming to know new people and having fun meeting them, eventually building up long time relations. *Participants without impairments* develop towards being more sociable with differently looking people, change their attitudes more easily, and they become emotionally aware of inclusive situations. They discover their own abilities in experiencing fun, joy and creativity together with even less familiar partners.

References

1. Bean, R. (1994), *Kreative Kinder*. Hamburg: rororo.
2. Bews, S. (1992), *Integrativer Unterricht in der Praxis: Erfahrungen – Probleme – Analysen*. Innsbruck: Österreichischer Studienverlag.
3. Chaiklin, H. (1975). *Marian Chace: Her Papers*. Columbia: American Dance Therapy Association.
4. Dinold, M. (2004). Interpersonal Relation – the essential precondition for human development and integration. *Psychomotricity – Portuguese Review of Psychomotricity Nr. 3*. European Congress of Psychomotricity. Lisbon, 2004, 77-86.
5. Dinold, M. (2000), *Tanz und kreative Bewegung als lebenslange Entwicklungsförderung für Menschen mit und ohne Behinderung. Ein Beitrag zur Integrationsforschung in der Bewegungs- und Sportpädagogik – Entwicklungsförderung zwischen Pädagogik und Therapie*. Unveröff. Dissertation am Institut für Sportwissenschaft der Universität Wien.
6. Erikson, E. H. (1973). *Identität und Lebenszyklus*. Drei Aufsätze übersetzt von Käte Hügel. Frankfurt am Main: Suhrkamp Taschenbuch Verlag.
7. Dinold, M. & Zanin, K. (1996), *Miteinander*. Handbuch einer kreativen Arbeitsweise für behinderte und nichtbehinderte Menschen mit den Mitteln Körpererfahrung, spontanem Spiel, Tanz und Theater. Wien: hpt-Verlag.

8. Milani-Comparetti, A. (1998), Fetale und neonatale Ursprünge des Seins und der Zugehörigkeit zur Welt. übers. v. B. Dorsey. *BEHINDERTE in Familie, Schule und Gesellschaft*, 21, (1), 1-12 (Hefmitte).
9. Margaret H'Doubler, *Dance: A Creative Art Experience* (Madison, WI: The University of Wisconsin Press, 1940, 1957²),
10. Petzold, H. & Orth, I. (1991). (Hrsg.). *Die neuen Kreativitätstheorien. Handbuch der Kunsttherapie*, Band I und II. Paderborn: Junfermann Verlag, 2. Auflage.
11. Sherborne, V. (1990/1998). *Developmental Movement for Children. Mainstream, special needs and pre-school*. Cambridge: Cambridge University Press./ *Beziehungsorientierte Bewegungspädagogik*. München/Basel: Ernst Reinhardt Verlag.
12. Whitehead, M. (2010).(Ed.). *Physical Literacy: Throughout the Lifecourse*. London: Taylor & Francis.
13. Witoszynskyj, E., Schindler, G. & Schneider, M. (2001). *Erziehung durch Musik und Bewegung*. Wien: öbv & hpt.

EFFECT OF FATIGUE ON DYNAMIC BALANCE IN DIFFERENT DIRECTIONS

Dubravka Ciliga¹, Tatjana Trošt Bobić¹ and Branimir Filipović²

¹Faculty of Kinesiology, University of Zagreb, Croatia

²Faculty of Kinesiology, University of Zagreb, doctoral studies, Croatia

Abstract

Evidence suggests that fatigue may negatively affect joint neuromuscular function as well as lead to an increased injury risk in athletes. The aim of this study was to determine the effect of fatigue on dynamic balance using a task that implies the capacity of maintaining balance on one leg while moving the other leg in different directions. The study was conducted on a sample of 22 healthy, physically active men, mean age 22.8 ± 1.2 years. Subjects were randomly assigned to a control (N=10) or an experimental group (N=12). In order to determine the impact of fatigue on the measured capacity of maintaining dynamic balance, the subjects of the experimental group were measured before and immediately after the implementation of a fatiguing protocol. For the control group an equally duration of walk was planned. Before and after the fatiguing protocol for the experimental, and a walk for the control group, dynamic balance was determined on both legs (preferred and non-preferred), using the star excursion balance test. The ability to maintain dynamic balance was estimated by the distance covered with the upraised leg in eight different directions, while maintaining balance with the other leg. The used two-way analysis of covariance showed that the subjects of the experimental group significantly decreased their capacity of maintaining dynamic balance, from initial to final measurements, compared to the control group, only in certain directions (anterior, anterolateral and lateral). It should be noted that this significant decrease for those three directions due to fatigue, has been recorded in the performance of both, the preferred and the non-preferred leg ($p < 0.05$), indicating the consistency of the obtained results in both lower extremities. This study suggests the possibility that fatigue may differently affect the capacity of maintaining dynamic balance, when it is disturbed in different directions. It seems that fatigue primarily impairs the ability of maintaining unilateral dynamic balance in situations when the upraised leg is positioned in front or lateral to the standing leg. The results of this study also point out the necessity of implementing preventive balance exercise even at the end of a training session that is, in condition of fatigue, in order to adapt the joint neuromuscular function to tiredness. A more comprehensive effect on knee joint stability may also be achieved by performing stabilization exercises using different kind of disturbances from different directions, and especially in anterior and lateral disturbing conditions.

Key words: *fatigue, dynamic balance, star excursion balance test*

Introduction

The capacity of maintaining balance in dynamic conditions represents an important protective ability in terms of injury risk. It is well known that athletes with better dynamic balance, as well as with higher levels of static balance, agility and explosive strength are at lower injury risk than those who perform worse in those abilities (Hübsher et al., 2010). Evidence suggests that fatigue may negatively affect dynamic balance as well as lead to an increased injury risk in athletes (Zech et al., 2012). In athletes, injuries often happen at the end of training or competition (Ballanty and Shields, 2010; Hawkins and Fuller, 1999). Lower extremity injuries in football players mostly occur in the second half of the game (Hawkins and Fuller, 1999). Injuries of the knee joint in handball players also predominantly occur at the end of the game (Vauhnik et al., 2011). Those facts suggest that fatigue is a major risk factor of injury to athletes during competition, as well as during training (Zech et al., 2012; Vauhnik et al., 2011; Ballanty and Shields, 2010; Hawkins and Fuller, 1999). In presence of fatigue, there is a significantly negative impact on the stability of the joint, which increases the risk of injury (Zech et al., 2012). Proper dynamic stability implies the ability of the neuromuscular system to quickly correct the position of the joint (local neuromuscular function), as well as the whole body (on a global level of neuromuscular function) in space (Zech et al., 2012; Ortiz et al., 2010; Hübsher et al., 2010). During fatigue, the time of activation of the muscle stabilizing the knee joint is different compared to their activation when rested (Quammen et al., 2012). Fatigue may also impair neuromuscular function of the joint by reducing the capacity to precisely modulate muscle force (Ballanty and Shields, 2010; Hawkins and Fuller, 1999; Marks, 1994). So disturbed motor control of the lower extremities in conditions of fatigue lead passive structures of the knee and ankle to considerable loads by increasing their risk of injury (Zech et al., 2012; Ballanty and Shields, 2010). According to this, balance training is often used in the prevention and functional rehabilitation of lower extremity injuries, especially injuries of the knee and ankle joint (Olsen et al., 2005; McKeon and Hertel, 2008). Muscle adaptation to fatigue could significantly reduce the risk of his injury. This is especially important for the knee joint,

where injuries are often of serious nature (Myklebust, Skjølberg and Bahr, 2013). However, in order to assure that the implementation of specific exercises of balance in conditions of fatigue would not cause injury to athletes, it would be interesting to investigate to what extent fatigue affects knee stability. It is also important to answer the question under what conditions does fatigue mostly affect joint stability. The aim of this study is to determine the effect of fatigue on dynamic balance using a task that implies the capacity of maintaining balance on one leg while moving the other leg in different directions. The impact of fatigue on the capacity of stabilizing the knee joint in different disturbance conditions could contribute to the optimization of training protocols used for the prevention and rehabilitation of its injuries.

Methods

The study was conducted on a sample of 22 healthy, physically active men, mean age 22.8 ± 1.2 years. Subjects were randomly assigned to a control (N=10) or an experimental group (N=12). In order to determine the impact of fatigue on the measured capacity of maintaining dynamic balance, the subjects of the experimental group were measured before and immediately after the implementation of a fatiguing protocol. For the control group an equally duration of walk was planned. Before and after the fatiguing protocol for the experimental, and a walk for the control group, dynamic balance was determined on both legs (preferred and non-preferred), using the star excursion balance test (SEBT). The ability to maintain dynamic balance was estimated by the distance covered with the upraised leg in eight different directions: anterior (A), anterolateral (AL), lateral (L), posterolateral (PL), posterior (P), posteromedial (PM), medial (M) and anteromedial (AM), while maintaining balance with the other leg (Figure 1). A verbal and visual demonstration of the testing procedure was given to each subject by the examiner. Before official testing, subjects tried two times the SEBT task. Participants performed the test 3 times with each leg. Mean value of three executions was calculated for each of the eight measured directions. Only the subjects of the experimental group were subjected to fatigue protocol. The fatiguing protocol consisted of four consecutive running protocols at maximum speed changing directions at different length, without pause (2x10m, 2x20m, 2x30m and 2x40m). Each running protocol lasted approximately one minute. Two minutes of rest were planned between each run. The average overall duration of the whole fatiguing protocol (work + rest) was 10 minutes. In accordance with recent knowledge (Baker et al., 2012; Choukou et al., 2012), a fatiguing protocol similar to the one used in this study should place the organism in conditions of significant glycolysis, which ensures the occurrence of fatigue and impairs the ability to control movement in the lower extremities (Quammen et al., 2012). During the implementation of the fatigue protocol, the subject's heart rate was monitored in real time by means of the Polar Team System (Polar Electro © 2013). Immediately after the fatiguing protocol and after dynamic balance testing, blood lactate were also estimated. At the same intervals a modified Borg scale for subjective assessment of the efforts was given to the participants (from 1 - negligible effort to 10 - extreme exertion) (Coutts et al., 2009 ; Borg, Ljunggren and Ceci, 1985). This study plan enable the verification that the tested subjects where really fatigued, and that the results obtained in the final testing were influenced by fatigue. A condition of fatigue after the final testing was imperative for the realization of the research objectives. The change in each of the dependent variables in the experimental group and the significance of intergroup differences was analyzed using two-way analysis of covariance (group x time) with repeated measures on one factor (time). The level of significance was set at $p < 0.05$.

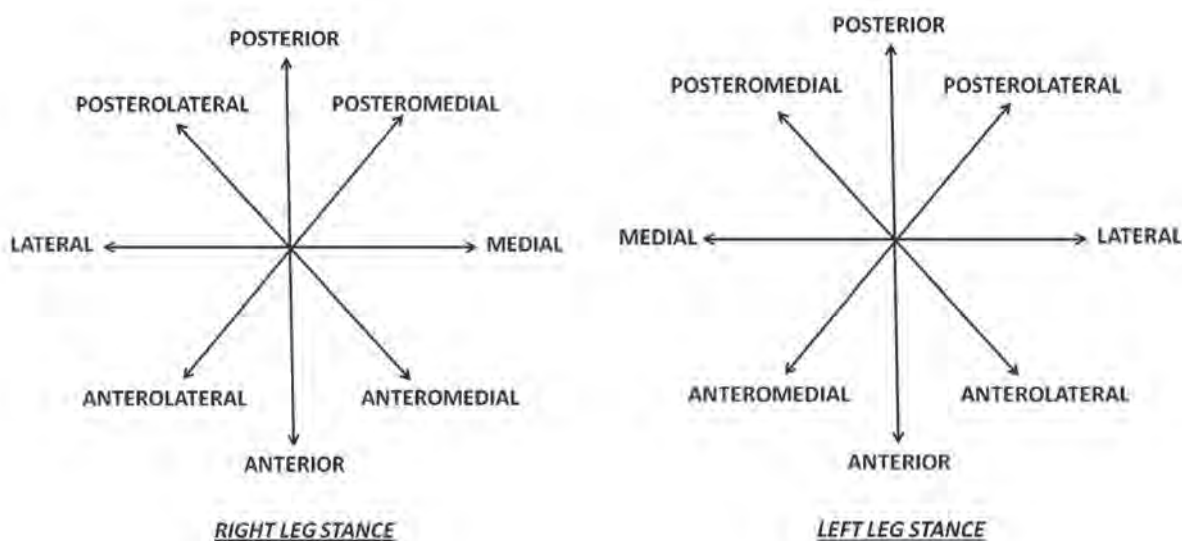

Figure 1: Reaching directions for the Star Excursion Balance Test

Results

The used two-way analysis of covariance showed that the subjects of the experimental group significantly decreased their capacity of maintaining dynamic balance, from initial to final measurements, compared to the control group, only in the anterior, anterolateral and lateral directions. This significant decrease for those three directions due to fatigue, has been recorded in the performance of both, the preferred and the non-preferred leg ($p < 0.05$), indicating the consistency of the obtained results in both lower extremities (Table 1 and 2).

Table 1: Changes in dynamic balance with different directions of disturbance, for the experimental groups, analyzed by mean of a two-way analysis of covariance. Data for the preferred leg

	Variable	Unit of measure	RANCOVA	p	Group	Initial (Arit.mean \pm SD)	Final (Arit.mean \pm SD)
PREFERRED LEG	Anterior	Cm	Time*Group	0,046	CON	75,73 \pm 5,62	77,57 \pm 6,08
	(A)				EXP	78,06 \pm 5,78	67,13 \pm 6,59
	Anterolateral	Cm	Time*Group	0,042	CON	63,30 \pm 7,24	64,79 \pm 7,63
	(AL)				EXP	68,82 \pm 7,89	56,91 \pm 6,37
	Lateral	Cm	Time*Group	0,048	CON	84,81 \pm 4,59	86,97 \pm 4,87
	(L)				EXP	80,72 \pm 6,16	71,43 \pm 4,47
	Posterolateral	Cm	Time*Group	0,612	CON	91,32 \pm 7,51	90,60 \pm 5,34
	(PL)				EXP	94,67 \pm 4,25	92,84 \pm 7,83
	Posterior	Cm	Time*Group	0,723	CON	99,83 \pm 8,95	100,78 \pm 8,71
	(P)				EXP	101,47 \pm 7,47	98,36 \pm 4,89
	Posteromedial	Cm	Time*Group	0,289	CON	102,91 \pm 9,76	102,30 \pm 4,01
	(PM)				EXP	100,32 \pm 6,65	101,58 \pm 7,26
	Medial	Cm	Time*Group	0,683	CON	93,30 \pm 5,78	94,57 \pm 6,08
	(M)				EXP	94,38 \pm 7,85	90,17 \pm 5,31
Anteromedial	Cm	Time*Group	0,192	CON	86,30 \pm 5,24	89,72 \pm 6,63	
(AM)				EXP	85,29 \pm 5,89	81,82 \pm 7,92	

Table 2: Changes in dynamic balance with different directions of disturbance, for the experimental groups, analyzed by mean of a two-way analysis of covariance. Data for the non-preferred leg

	Variable	Unit of measure	RANCOVA	p	Group	Initial (Arit.mean \pm SD)	Final (Arit.mean \pm SD)
NON-PREFERRED LEG	Anterior	Cm	Time*Group	0,038	CON	76,24 \pm 6,82	64,29 \pm 7,38
	(A)				EXP	79,10 \pm 4,52	68,17 \pm 7,43
	Anterolateral	Cm	Time*Group	0,041	CON	68,94 \pm 4,86	57,03 \pm 6,02
	(AL)				EXP	70,32 \pm 6,17	59,73 \pm 5,82
	Lateral	Cm	Time*Group	0,032	CON	77,23 \pm 8,96	67,15 \pm 5,29
	(L)				EXP	78,74 \pm 7,63	65,82 \pm 6,91
	Posterolateral	Cm	Time*Group	0,629	CON	90,94 \pm 6,28	89,18 \pm 4,06
	(PL)				EXP	92,60 \pm 5,49	90,53 \pm 7,59
	Posterior	Cm	Time*Group	0,823	CON	100,82 \pm 7,38	100,67 \pm 7,95
	(P)				EXP	99,21 \pm 7,41	100,42 \pm 8,12
	Posteromedial	Cm	Time*Group	0,371	CON	101,18 \pm 6,39	102,47 \pm 4,19
	(PM)				EXP	100,62 \pm 6,83	101,27 \pm 6,72
	Medial	Cm	Time*Group	0,634	CON	91,27 \pm 7,24	93,37 \pm 5,72
	(M)				EXP	92,79 \pm 8,25	92,83 \pm 6,27
Anteromedial	Cm	Time*Group	0,293	CON	80,75 \pm 5,17	82,06 \pm 6,29	
(AM)				EXP	83,54 \pm 4,99	85,24 \pm 6,26	

Discussion and conclusions

The main finding of this study is the selected effect of fatigue on dynamic balance in different conditions. The subjects of the experimental group significantly decreased their capacity of maintaining dynamic balance, from initial to final measurements, compared to the control group, only in specific directions (anterior, anterolateral and lateral). This

significant decrease has been recorded in the performance of both, the preferred and the non-preferred leg ($p < 0.05$), indicating the consistency of the obtained results in both lower extremities. The results suggests the possibility that fatigue may differently affect the capacity of maintaining dynamic balance, when it is disturbed in different directions. It seems that fatigue primarily impairs the ability of maintaining unilateral dynamic balance in situations when the upraised leg is positioned in front or lateral to the standing leg. The anterior reaching direction of the SEBT test is one of the more challenging due to the fact that it is almost impossible for the subject performing the task to see the label on the floor indicating the direction he/she should stick to. Furthermore, to reach the anterolateral and lateral label on the floor with the upraised leg, the subject has to pass through the standing leg, which may be a more challenging situation for maintaining balance compared to the medial reaching direction. Based on the obtained results, it may be suggested that the conducted fatiguing protocol has aggravate the capacity of maintaining dynamic balance in the more challenging tasks (directions), leaving intact the same capacity during easier directions. Recommendations related to the implementation of prevention training traditionally describe the implementation of balance exercises at the beginning of the training session, when the athletes are not fatigued yet (Hübscher et al., 2010). These recommendations are based on the desire to reduce the possibility of injury due to tiredness during the training. However, the fact that athletes frequently injured at the end of training activities (Mallo and Dellal, 2012; Stovitz and Shrier, 2012) emphasizes the importance of developing a greater level of tolerance to fatigue. Exercising without fatigue will not necessarily reduce the impact of fatigue on the level of muscle activation. Therefore, there is a growing number of experts and researchers who recommend the implementation of balance exercises at the end of the training, with the aim of encouraging the adaptation to neuromuscular fatigue (Quammen et al., 2012; Zech et al., 2012; Ballantyne and Shields, 2010). The findings of this study supports the idea of implementing balance exercising even at the end of a training procedure.. The results of this study point out the necessity of implementing preventive balance exercise even at the end of a training session that is, in condition of fatigue, in order to adapt the joint neuromuscular function to tiredness. A more comprehensive effect on knee joint stability may also be achieved by performing stabilization exercises using different kind of disturbances from different directions, and especially in anterior and lateral disturbing conditions.

References

1. Baker, J.S., Thomas, N., Cooper, S.M., Davies, B., Robergs, R.A. (2012). Exercise duration and blood lactate concentrations following high intensity cycle ergometry. *Research in Sports Medicine*, 20(2), 129-141.
2. Ballantyne, B.T. i Shields, R.K. (2010). Quadriceps fatigue alters human muscle performance during a novel weight bearing task. *Medicine and Science in Sports and Exercise*, 42(9), 1712-1722.
3. Borg, G., Ljunggren, G., Ceci, R. (1985). The increase of perceived exertion, aches and pain in the legs, heart rate and blood lactate during exercise on a bicycle ergometer. *European Journal of Applied Physiology*, 54(4), 343-349.
4. Choukou, M.A., Laffaye, G., Heugas-De Panafieu, A.M. (2012). Sprinter's motor signature does not change with fatigue. *European Journal of Applied Physiology*, 112(4):1557-1568.
5. Couttsa, A.J., Rampinini, E., Marcorac, M.S., Castagnad, C., Impellizzeri, F.M. (2009). Heart rate and blood lactate correlates of perceived exertion during small-sided soccer games. *Journal of Science and Medicine in Sport*, 12, 79-84.
6. Hawkins, R., Fuller, C.A. (1999). A prospective epidemiological study of injuries in four English professional football clubs. *British Journal of Sports Medicine*, 33(3), 196-203.
7. Hübscher, M., Zech, A., Pfeifer, K., Hänsel, F., Vogt, L., Banzer, W. (2010). Neuromuscular training for sports injury prevention: a systematic review. *Medicine and Science in Sports and Exercise*, 42(3), 413-21.
8. Mallo, J., Dellal, A. (2012). Injury risk in professional football players with special reference to the playing position and training periodization. *The Journal of Sports Medicine and Physical Fitness*, 52(6), 631-638.
9. Marks, R. (1994). Effect of exercise-induced fatigue on position sense of the knee. *Australian Journal of Physiotherapy*, 40(3), 175-181
10. McKeon, P.O., Hertel, J. (2008). Systematic review of postural control and lateral ankle instability, part II: Is balance training clinically effective? *Journal of Athletic Training*, 43(3), 305-315.
11. Myklebust, G., Skjølberg, A., Bahr, R. (2013). ACL injury incidence in female handball 10 years after the Norwegian ACL prevention study: important lessons learned. *British Journal of Sports Medicine*, 47(8), 476-479.
12. Olsen, O., Myklebust, G., Engebretsen, L., Holme, I., Bahr, R. (2005). Exercises to prevent lower limb injuries in youth sports: Cluster randomised controlled trial. *British Medical Journal*, 330(7489), 449-452.
13. Quammen, D., Cortes, N., Van Lunen, B.L., Lucci, S., Ringleb, S.I., Onate, J. (2012). Two different fatigue protocols and lower extremity motion patterns during a stop-jump task. *Journal of Athletic Training*, 41(1), 32-41.
14. Stovitz, S.D., Shrier, I. (2012). Injury rates in team sport events: tackling challenges in assessing exposure time. *British Journal of Sports Medicine*, 46(14), 960-963.
15. Vauhnik, R., Morrissey, M.C., Rutherford, O.M., Turk, Z., Pilih, I.A., Perme, M.P. (2011). Rate and risk of anterior cruciate ligament injury among sportswomen in Slovenia. *Journal of Athletic Training*, 46(1), 92-98.
16. Zech, A., Steib, S., Hentschke, C., Eckhardt, H., Pfeifer, K. (2012). Effects of localized and general fatigue on static and dynamic postural control in male team handball athletes. *Journal of Strength and Conditioning Research*, 26(4), 1162-1168.

EFFECTS OF POSTURAL DEFORMATIONS ON KNEE JOINT INJURIES. A SYSTEMATIC REVIEW

Matea Crnjak, Valerija Kršak and Sabina Stančić

Faculty of Kinesiology, University of Zagreb, Croatia

Abstract

The sedentary way of life that is prevalent in society nowadays has influenced more and more people to take part in different sports activities in order to improve their health and increase the quality of their lives. Although the conditions of training and partaking in sports activities are getting better on a daily basis, the frequency of sports injury occurrence, especially knee joint injuries, is still very high, both in professional and recreational sport.

Postural deformations are only one of a number of significant intrinsic factors which increase the risk of knee joint injury. The most commonly researched postural deformations related to knee joint injuries are valgus position, knee joint hyperextension and muscle strength disbalance of the upper leg muscle groups. Better understanding and comprehension of the influence these postural deformations have upon the development of knee injuries during sports activities is the key to programing higher quality prevention and rehabilitation programs in order to maximally decrease the risk of knee joint injuries in sport and recreation.

Introduction

Sport, whether recreational or professional, constitutes a part of life of a large number of people of all ages. Although the conditions for training and practicing sports are continually improving, from better sports centres to sports equipment and footwear, a high level of sports injuries is still present in professional and recreational sport.

Postural deformations are only one of a number of significant intrinsic factors which increase the risk of knee joint injury. The most commonly researched postural deformations related to knee joint injuries are valgus position, knee joint hyperextension and muscle strength disbalance of the upper leg muscle groups. From a knee stability viewpoint, along with upper leg muscle strength, ACL has the most significant role in the knee joint, especially in preventing abnormal movements and controlling knee joint movements (Nordin & Frankel, 2001). The main role of the ACL is to prevent and control the forward translation of the tibia relative to the femur, to prevent hyperextension and provide knee joint stability during the rotation of the tibia. (Markolf, Mensch & Amstutz 1976; Takeda et al., 1994).

Numerous studies have shown that female athletes are more prone to knee joint injuries than male athletes, (Myklebust et al., 1997; Roos et al., 1995), while Arendt & Dick, in 1995, state that as many as 80% of non-contact knee joint injuries are found in female athletes and 65% are found in male athletes.

Depending on the type of sports activities and specific structural movements during those sports activities, postural deformations can in a greater or lesser way increase the risk of knee joint injuries. The studies have shown that athletes most often sustain their injuries by non-contact injury mechanisms while performing movements such as sudden changes of directions or cutting movements, during improper take offs, after landing from a jump, during deceleration or during a fall, which are therefore perceived as movements or situations with the highest injury risk (Childs, 2002).

The valgus position of the knee joint

The valgus position of the knee joint is the most researched postural disorder and it is mainly found in female athletes due to anatomical differences between women and men. The Q-angle is the most significant anatomical difference which has an impact on the valgus position. The Q-angle is comprised of two lines. The first line starts from the *spina iliaca anterior superior* and descends toward the top of the *patella*, while the other line connects the bottom of the ischium bone and the tibial tubercle. (Huston et al., 2000) (Figure 1).

A larger Q-angle in the knee joint in females is caused by wider hips which consequently increase the slope of the femur.

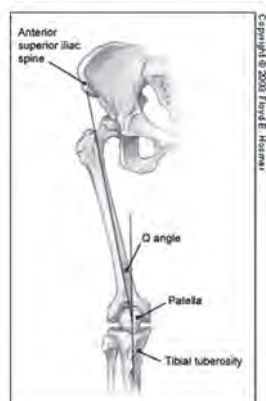

Figure 1: Q-angle (Calmbach & Hutchens, 2003).

The Q-angle higher than 15° in men and 20° in women is considered to be clinically abnormal. (Hvid, Anderson & Schmidt, 1981). A larger Q-angle, and hence a larger knee joint valgus position, pulls more strongly on the lateral side of the anterior upper leg muscles and on the patella therefore creating greater pressure on the medial part of the knee joint (Shambaugh, Klein & Herbert, 1991).

The studies have shown that the knee joint flexion ranging from 20° and 40° causes a considerable valgus – varus (lateral) instability (Markolf, Mensch & Amstutz 1976; Takeda et al., 1994).

The inability of muscles surrounding the knee joint to control lateral movements in the joint leads to ACL overload while attempting to limit medial movements in the knee joint, i.e. the valgus position of the knee which increases the risk of ligament injury (Dugan, 2005). Athletes experience a medial collapse of the knee joint most often during landing after a jump or during sudden changes of direction (Figure 2).



Figure 2: Valgus position of the knee joint in two foot jump (Pope, 2012).

Hewett et al. in 2005 concluded that an excessive valgus position of the knee joint in landing contributes to ACL injuries thus presenting a significant risk factor in non-contact injury mechanisms (Speer et al., 1992), while Griffin et al. in 2006 indicated that while performing a sudden change of direction the knee joint is exposed to a more pronounced valgus position which increases the chances of an ACL injury. The valgus position of the knee joint combined with internal or external rotation leads to overloading of the joint itself and therefore makes the athletes more prone to injuries. (Olsen et al., 2004).

Hyperextension of the knee joint

The basic movements in the knee joint are extension and flexion, both of which are performed around the transversal axis of the knee which passes through both condyles of the femur (figure 3). Knee joint extension which is achieved actively, with the help of muscles, can reach as far as 0° , while passive extension of the knee can reach as far as 5° . Knee extension is also followed by lower leg external rotation of up to 5° . The reach of the active knee flexion can be up to 135° while passive flexion can go as far as 160° . With the knee flexion there follows a lower leg internal rotation of up to 5° . The range between 135° and 160° of knee flexion is referred to as the “dead muscle space”.

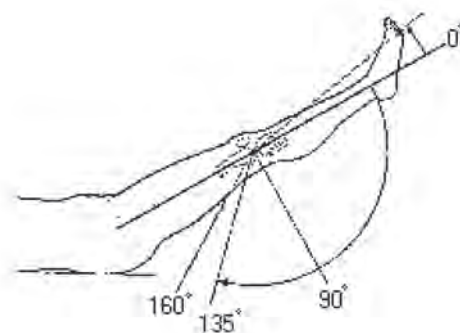

Figure 3: Range of motion of knee extension and flexion (<http://zastitaisigurnost.com.hr/portal/artroza-koljena/>)

Hyperextension is a knee joint deformation where the knee is being bent backwards which leads to joint extension carrying over 5° (Loudon, Goist & Loudon, 1998). Knee hyperextension can be caused by ankle joint distortion, injuries or excessive knee joint instability and by postural habits (<http://www.wisegeek.com/what-is-genu-recurvatum.htm>).



Figure 4: Anatomical depiction of a normal knee joint and of knee joint hyperextension showing the direction of the axis through both of them (<http://46.4.230.144/web/UpToDate.v19.2/contents/f18/9/18751.htm>)

Individuals with knee hyperextension while standing have the axis in the knee joint go through the femur a slope, backwards and down, directing the ground force reaction toward the anterior part of the knee joint (figure 4). Such positioning makes the anterior upper leg muscles completely inactive while at the same time overloading the structures at the posterior side of the knee joint by making them establish the balance in the standing position (Loudon, Goist & Loudon, 1998). While walking, individuals with knee hyperextension have the weight of their body, i.e. the load, transfer directly from the femur to the tibia without the muscles absorbing any of the force, which can lead to pain in the medial part of the knee joint and posterior ligamentary structures (Loudon, Goist & Loudon, 1998). The research of Kawahara et al., 2012, concerning the effects knee hyperextension has on parameters of walking, indicates that hyperextension paired with ACL injuries changes the parameters of walking. Hyperextension is associated with internal rotation of the femur in the knee joint near the end of the knee hyperextension movement, which causes the ACL and posterior knee structures to overload (Brownstein et al., 1988). Stauffer, Chao and Gyory, 1977, indicate that individuals with knee hyperextension can have *m.quadriceps femoris* or *m.gastrocnemius* strength deficits (Kendall et al., 1993). The research conducted by Deavan et al. in 2004 has shown that athletes with knee hyperextension had a below normal value of anterior and posterior upper leg muscle power ratio, measured at angular velocities of $60^\circ/s$ and $300^\circ/s$, which indicates an increase in anterior upper leg muscle strength and endurance in regards to posterior upper leg muscles.

Individuals with knee hyperextension often perceive this joint position as “natural” because it is not an obstacle for them in everyday activities, however, during more demanding activities, such as sports activities, knee hyperextension can lead to a greater risk of injury (Hutchison & Ireland, 1995; Loudon, Jenkins & Loudon, 1996; Lin et al., 2009).

Upper leg muscle strength

Muscle strength, coordination and reaction time of active knee joint stabilizers are all abilities that increase the knee joint stability and protect it from overloading during sports activity (Huston et al., 2000). Muscle strength disbalance of active knee joint stabilizers, unilateral or bilateral, is a relevant injury risk factor during sports activities. Unilateral disbalance refers to muscle strength disproportion of agonistic and antagonistic muscles of a certain joint, while bilateral disbalance implies muscle strength disproportions between left and right side of the body. Knappik and Ramos, 1980, say that the knee joint functioning is dependent on a balanced agonistic (*m. quadriceps*) and antagonistic (*m. biceps femorisa*) muscle strength distribution, with the posterior upper leg muscle strength amounting to at least 60% of the anterior upper leg muscle strength.

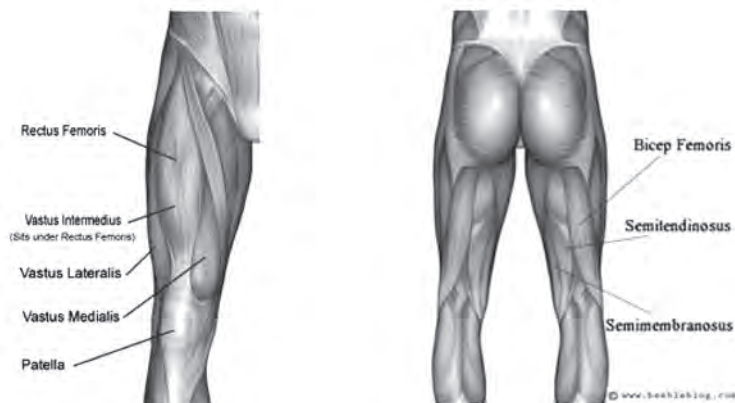

Figure 5: Anterior and posterior upper leg muscles (Bowman, 2009; <http://www.muska-posla.com/misicnaanatomijastrazn.htm>).

Depending on the velocity of the movement, posterior upper leg muscle strength should amount from 60% to 100% of the anterior upper leg muscle strength in the ipsilateral leg. When the movement velocity is lower the strength ratio can be lower as well, but any angular velocity increase within the knee joint should bring that strength ratio closer. Any bigger deviation of those two ratios results with an increase in the possibility of injury of the knee joint system (Devan et al., 2004). Grace et al., in 1984 conducted a study on injuring and indicated that a muscle strength disbalance between the dominant and non-dominant leg above 10% can be a factor in potential injuries.

Biomechanical studies show that force increase during anterior upper leg muscle contraction results in greater forward tibial translation, especially if the angle in the knee joint is between 0° and 30° (Renstrom et al., 1986). Likewise, Li et al., in 1999 indicate that anterior upper leg muscle activation, without the co-activation of the posterior upper leg muscles, can cause frontal tibial subluxation where the load on the ACL increases significantly. On the other hand if there is only posterior upper leg muscle activation without anterior upper leg muscle co-activation, the possibility of frontal tibial translation decreases which concurrently reduces the load placed on the ACL (More et al., 1993). Baratta et al., in 1988 talk about the importance of anterior and posterior upper leg muscle co-activation on knee joint stability, concluding that said co-activation assures a balanced load distribution on the joint surface and a better adaptation of the joint mechanical resistance. In their study Hagood et al., in 1990 report that anterior and posterior upper leg muscle co-activation is at its highest during extreme knee joint movements in order to protect the knee joint from going beyond its physiological movement limits.

A study by Knappik et al., in 1991 indicated a correlation between lower leg injuries and anterior – posterior upper leg muscle strength disbalance, measured at an angular velocity of 180°/s, while the mentioned muscle strength disbalance measured at an angular velocity of 30°/s did not show the same correlation. One of the possible explanations as to why that correlation was only found at an angular velocity of 180°/s is the fact that the mentioned angular velocity is similar to angular velocities in which the athletes perform movements during their sports activities. Athletes that have posterior upper leg muscle power of the right leg (angular velocity of 180°/s) equal to or bigger than 15% of that in the left leg, have a 2,6 times greater possibility of injury that athletes with a bilateral disbalance lower than 15%. Furthermore, athletes with higher posterior upper leg muscle power in their left leg have a 1,7 times greater possibility of injury than athletes without the disbalance (Knappik et al., 1991).

The results shown can partially be explained by the fact that greater force generation in the right leg can cause damage at contractions of high speed to the left leg if the posterior left side upper leg muscles cannot absorb or equally distribute that force (Knappik et al., 1991). Knappik et al., in 1991., also report that athletes whose posterior upper leg muscle strength amounts to less than 75% of the anterior upper leg muscle strength, at angular velocity of 180°/s, have a 1,6 times greater possibility of injury than athletes that have a smaller strength disbalance. Numerous studies also confirm that an individual

is more prone to injuries if he or she has a anterior/posterior upper leg muscle strength ratio below normal values (Appen & Duncan, 1986; Stafford & Grana, 1984). Based on the stated it can be concluded that by strengthening the posterior upper leg muscles and decreasing the bilateral and unilateral disbalance we can also decrease the dominance of anterior upper leg muscles in muscle co-activation during sports activities and contribute to lowering the risk of knee joint injuries.

Conclusion

The increase of injury incidence during sports activities has made the need for better understanding of postural deformations and their role in the risk of knee joint injury and in injury mechanisms all the more greater. It is reported that athletes with postural deformations have a much higher tendency toward injuries while performing sport specific movements. Sports experts and coaches, during training sessions and while their athletes are performing sport specific movements, should put special attention on decreasing emphasized valgus and hyperextension knee joint positions in order to minimize the injury risk factors, especially with female athletes. One of the significant female anatomical characteristics that increase the risk of knee joint injury by consequently emphasizing the valgus knee position even more is the Q angle. Therefore it is of great importance that coaches turn their attention to anatomical characteristics of their female athletes in prevention programs and stress the need for proper performance of sport-specific movement structures.

Conditioning trainers should also take into account the need to decrease any possible unilateral or bilateral muscle strength disbalance in regard to all the knee joint active stabilizers because by neglecting that disbalance the risk of knee joint injury can be made higher.

In the end it should be said that there is not a single intrinsic risk factor that causes any sports injury, there needs to be an interrelation between different intrinsic and extrinsic risk factors with elements of sports injury mechanisms in order for the injury to happen. Therefore, although specific prevention and rehabilitation programs can lower the injury risks they can never completely exclude those risks during sports activities, they can only minimize them.

References

1. Appen, L., & Duncan, P.W. (1986). Strength relationship of the knee musculature: Effects of gravity and sport. *Journal of Orthopaedic and Sports Physical Therapy*, 7(5), 232-235.
2. Arendt, E., & Dick, R. (1995). Knee injury patterns among men and women in collegiate basketball and soccer. NCAA data and review of literature. *American Journal of Sports Medicine*, 23(6), 694-701.
3. Baratta, R., Solomonow, M., Zhou, B.H., Letson, D., Chuinard, R., & D'Ambrosia, R. (1988). Muscular coactivation. the role of the antagonist musculature in maintaining knee stability. *American Journal of Sports Medicine*, 16(2), 113-122.
4. Bowman, T. (2009). *Discover The #1 Reason Why You Should Build Leg Muscle & Develop Your Thighs & Calves* /on line/. Downloaded on August 30, 2012. from: <http://www.gainmuscleandloseweight.com/build-leg-muscle/#.UGN3xq549Wk>
5. Brownstein, B., Noyes, F.R., Mangine, R.E., Kryger, S. (1988). Anatomy and biomechanics. In R.E. Mangine (Ed.), *Physical Therapy of the Knee*, (pp. 1-30). New York: Churchill Livingstone
6. Calmbach, W. & Hutchens, M. (2003). *Evaluation of Patients Presenting with Knee Pain: Part I. History, Physical Examination, Radiographs, and Laboratory Tests* /on line/. Downloaded on August 30, 2012. from: <http://www.aafp.org/afp/2003/0901/p907.html>
7. Childs, S.G. (2002). Pathogenesis of anterior cruciate ligament injury. *Orthopaedic Nursing / National Association of Orthopaedic Nurses*, 21(4), 35-40.
8. Devan, M.R., Pescatello, L.S., Faghri, P., & Anderson, J. (2004). A prospective study of overuse knee injuries among female athletes with muscle imbalances and structural abnormalities. *Journal of Athletic Training*, 39(3), 263-267.
9. Dugan, S.A. (2005). Sports – related knee injuries in female athletes. *American Journal of Physical Medicine and Rehabilitation*, 84(2), 122-130.
10. Grace, T.G., Sweetser, E.R., & Nelson, M.A. (1984). Isokinetic muscle imbalance and knee-joint injuries. A prospective blind study. *Journal of Bone and Joint Surgery - Series A*, 66(5), 734-740.
11. Griffin, L.Y., Albohm, M.J., Arendt, E.A., Bahr, R., Beynnon, B.D., DeMaio, M., Yu, B. (2006). Understanding and preventing noncontact anterior cruciate ligament injuries: A review of the hunt valley II meeting, january 2005. *American Journal of Sports Medicine*, 34(9), 1512-1532.

EFFECT OF A MODIFIED PILATES PROGRAMME ON STABILIZATION AND MUSCLE COORDINATION AT WOMEN WITH A SEDENTARY JOB

Dagmar Hrusova

Department of Leisure and Tourism, Faculty of Informatics and Management, University of Hradec Kralove, Czech Republic

Abstract

Pilates is a complex exercise with key principles (core, concentration, control, precision, breath, and flow) referring to effective activation and of deep stabilizing system (core) and correct muscle involvement and effective movement. The aim of the research study was to determine the effect of a three-month modified pilates exercise programme, with a frequency of three sixty-minute classes a week, on stabilization and muscle coordination. The problem was solved by empirical, causal research – quasi experiment, with quantitative (sign test and Wilcoxon pair test; $p < 0.05$) and qualitative analysis. Participants ($n = 21$) were examined in pre-test and post-test. The total results suggest a significant difference in stabilizing function and in muscle coordination between pre-test and post-test.

Key words: function, musculoskeletal system, intervention, exercise therapy

Introduction

Pilates is based on its characteristics and key principles (core, concentration, control, precision, breath, and flow) referring to effective activation and optimal function of deep stabilizing system (core) as a precondition of correct muscle involvement and effective movement. Pilates employs specific breathing technique and therefore facilitates stabilizing function, because respiratory and postural mechanisms are mutually related (Suchomel, 2006). Pilates is often recommended in clinical practice as a therapy for functional muscle disorders. Effect of pilates on the musculoskeletal system in healthy subjects was analyzed in a systematic reviews of Cruz- Ferreira et al. (2011), La Touche et al. (2008), Lim et al. (2011), and Pereira et al. (2012). O'Brien et al. (2006), Curnow et al. (2009) and Rydeard et al. (2006) focused on the lumbar - pelvic stabilization and based on the results suggested a statistically significant improvement in stabilizing function.

Deep stabilizing system of spine is characterized as muscle synchronization that stabilizes spine in all movements (Kolář a Lewit, 2005). The muscle involvement in spine stabilization is automatic, the involved muscles are: diaphragm, m. transversus abdominis, pelvic floor muscles and m. multifidus. The activity of the stabilizing muscles precedes the activity of extremities (Kolář, 2009). Hodges and Richardson (1997) verified the postural reaction of m. transversus abdominis, connected to anticipation of the upcoming movement of lower extremities. Hodges and Richardson (1999) also verified that targeted contraction of m. transversus abdominis is connected to co-contraction of m. multifidus, and vice versa. Concerning pilates exercise, m. transversus abdominis and m. obliquus internus are activated in the selected exercises, provided that the pilates exercise is done with proper technique (Critchley et al., 2011). Correct technique and proper concentration are important also for optimal motor stereotypes practice, together with an individualized approach. Motor stereotypes reflect muscle coordination. In case of change in muscle function, the imbalance can affect the optimal muscle involvement in the stereotype; the activation can be delayed or decreased, with substitutions and incoordination.

Methods

The aim of the research was to determine the effect of a three-month modified pilates exercise programme on stabilization and muscle coordination. The problem was solved by an empirical, causal research - quasi experiment with both quantitative and qualitative data analysis. Data were collected by method of observation, and techniques of evaluation – alternative score (0/1), ordinal scale (4 grades) and check-list (2 items).

It was assumed that the function will be improved in both followed variables. Three indicators were employed to evaluate *stabilizing function* in the selected postural stereotypes, with regard to the core, shoulder and pelvic girdle. The indicators were: core co-contraction and one-leg stand (Trendelenburg test) and press-up kneeling. Other three indicators were employed to evaluate *muscle coordination* in the selected motor stereotypes, again with regard to the core, shoulder and pelvic girdle. The indicators were: the tests of trunk flexion, hip extension and shoulder flexion. The intervention was based on pilates principles, individual exercise was modified (individualized approach). The volume and frequency of exercise was sixty minutes three times a week for three months. In total there were 33 exercise classes. Participants were examined in pre-test and post-test.

Participants

Research sample comprised 21 women at working age (22 - 64 years), pregnancy excluded, The main criteria for inclusion were character of work (routine or creative intellectual activity, sedentary work), no previous experience with pilates, and no injury or rehabilitation in the past six months. The age distribution was: 22-29 years: 19%, 30-39 years: 19%, 40-49 years: 19%, 50-59 years: 24%, 60-64 years: 19%). In terms of the age the sample was heterogeneous, however, in terms of the above mentioned criteria the sample can be considered homogeneous.

Analysis

Data were analyzed by quantitative and qualitative analysis. Statistical significance of the difference was calculated by nonparametric tests for dependent choices (sign test and Wilcoxon paired test), at the level of statistical significance of $p < 0.05$. In qualitative analysis the results were evaluated according to the criteria determining minimum intervention effect, based on a consensus of expert opinions ($n = 3$): relative frequency of improvements (at least 50% of cases) and zero absolute frequency of impairments between pre-test and post-test. Participants who scored by the median of the range of optimal function (“norm”) in the given indicator in pre-test were not calculated in the evaluation ($n = 21 - \text{norm}$, see table 3). The parallel validity of both criteria was required.

Results

The collected data were processed and evaluated to determine the effect of a modified pilates programme on the selected function of musculoskeletal system. The significance of the difference was calculated in statistical analysis (sign test and Wilcoxon pair test, $p < 0.05$) and qualitative analysis. One hypothesis (H1) focused on stabilization and the other hypothesis (H2) focused on muscle coordination.

Stabilization (H1) was verified by means of three selected indicators, the two of which (core co-contraction and one-leg stand) indicated significant difference between pre-test and post-test, based on both statistical analysis (see table 1 and 2) and qualitative analysis (see table 3). The significance of difference was calculated on $p < 0.05$. The criterion of relative frequency of improved cases was exceeded (core co-contraction: 53% of cases; one-leg stand: 55% of cases) and there was no impairment. Concerning the third indicator of stabilizing function (press-up kneeling), the statistical significance was not confirmed. The relative frequency of improved cases (33%) did not exceed the criterion; moreover, there was impairment in function in one case. With regard to confirmation of majority of partial hypotheses, the overall results of stabilizing function suggest improvement between pre-test and post-test.

Table 1: Sign test – statistical significance of the difference in indicators of stabilization and muscle function

Indicator	Sign test			
	Level of significance $p < 0,05$			
	Number of different	Percent	Z	p
$v < V$				
Core co-contr.	9	100	2,67	0,008
One-leg stand	11	0	3,015	0,003
Press-up kneel.	8	12,5	1,77	0,077
Trunk flexion	11	0	3,02	0,003
Hip extension	5	100	1,78	0,07
Shoulder abd.	11	100	3,06	0,003

Table 2: Wilcoxon pair test – statistical significance of the difference in indicators of stabilization and muscle function

Indicator	Wilcoxon pair test			
	Level of significance $p < 0,05$			
	Number of valid	T	Z	p
Core co-contr.	9	0	2,67	0,08
One-leg stand	11	0	2,93	0,003
Press-up kneel.	8	4,5	1,89	0,059
Trunk flexion	11	0	2,93	0,003
Hip extension	5	0	2,02	0,043
Shoulder abd.	11	0	2,93	0,003

Table 3: Qualitative analysis of the difference in indicators of stabilization and muscle coordination

Indicator	Absolute frequency of differences				Relative frequency of improvement	Criteria		Verification
	(n = 21 – norm)							
	„+“	„0“	„-“	norm				
Core co-contr.	9	23	0	5	0,53	> 50%	0 impairment	YES
One-leg stand	11	10	0	1	0,55	> 50%	0 impairment	YES
Press-up kneel.	7	13	1	0	0,33	> 50%	0 impairment	NO
Trunk flexion	12	9	0	0	0,57	> 50%	0 impairment	YES
Hip extension	5	16	0	1	0,25	> 50%	0 impairment	NO
Shoulder abd.	11	10	0	1	0,55	> 50%	0 impairment	YES

Muscle coordination (H2) was verified by means of three selected indicators, the two of which (trunk flexion and shoulder abduction) indicated significant difference between pre-test and post-test, based on both statistical analysis (see table 1 and 2), and qualitative analysis (see table 3). The significance of difference was calculated on the level of significance of $p < 0.05$. The criterion of relative frequency of improved cases was exceeded (trunk flexion: 57% of cases; shoulder abduction: 55% of cases) and there was no impairment. Concerning the third indicator of muscle coordination (hip extension), the statistical significance was not confirmed. The relative frequency of improved cases (25%) did not exceed the criterion. With regard to confirmation of majority of partial hypotheses, the overall results of muscle coordination suggest improvement between pre-test and post-test.

Discussion

The research was based on muscle involvement in stabilizing function pilates exercise, as a precondition for efficient movement and optimal muscle involvement in motor stereotypes. To tests of stabilizing function were focused on the core, pelvic girdle and shoulder girdle, the results demonstrate the ability to control and stabilize the spine. The effect of Pilates exercise programme was reflected in the improvement of the stabilizing function in the core and pelvic girdle, in congruence with the findings of other authors who focused on the lumbar - pelvic stabilization depending on pilates intervention (O'Brien et al., 2006; Rydeard et al., 2006; Curnow et al., 2009). Emery et al. (2010) focused on scapula stabilization and confirmed a significant difference, together with improved posture in thoracic spine. In this research scapula stabilization was involved in the postural stereotype of press-up kneeling. However, a significant difference was not shown in this indicator between pre-test and post-test. This may be explained due to a complexity of the postural stereotype that makes great demands on maintaining a centered position of all the joints. To verify the assumed change longer intervention effect or individual therapy would be suggested.

In the field of muscle function the authors concerned mainly with muscle strength or endurance, primarily in abdominal muscles (Kloubec, 2010; O'Brien et al., 2006; Emery et al., 2010), and their findings suggested statistically significant difference. In our research the main focus was on muscle activation and involvement in motor stereotypes, as suggested by Segal et al. (2004).

In the indicator of hip extension, a significant difference ($p < 0.05$) was showed only in Wilcoxon pair test, contrary to the statistical sign test or qualitative analysis. In majority of cases ($n = 16$) there was no change in function between pre-test and post-test. The low percentage of changes may be related to the ratio of flexion/extension oriented exercises in pilates. Pilates exercise employs extension less than flexion (Blahušová, 2010). Despite this fact, hip extension was selected as an indicator of muscle coordination in this research, because it is an important stereotype in the pelvic girdle, participating in the step mechanism in walking. Since walking and hip extension is a routine stereotype fixed by everyday use, to verify the assumed change again longer intervention effect would be suggested.

The statistical analysis was supported by substantive qualitative analysis, as recommended by van Tulder et al. (2007). Despite the above-mentioned discussions, the total results of the study suggest a positive effect of pilates on stabilization and coordination function at the selected sample – women with a sedentary job. Due to the postural load of sedentary jobs, the findings can be beneficial in prevention and compensation of changes or disorders in muscle function. However, due to the limited size of the sample and no control group (quasi experiment), the findings cannot be generalized and further research is needed.

Conclusions

The aim of this study was to determine the effect of three-month modified pilates exercise programme on stabilization and muscle coordination at women with a sedentary job. The modified pilates exercise programme based on the key pilates principles (core, concentration, control, precision, breath, and flow) was empirically verified. The results suggest a significant difference in both stabilization and muscle coordination function between pre-test and post-test. An expected use of the pilates exercise programme in practice is both for prevention and therapy of changes in function of musculoskeletal system. Pilates may influence musculoskeletal system in more aspects and therefore should be a course of further study.

References

1. Blahušová, E. *Pilates pro rehabilitaci: zdravé cvičení bez bolesti*. Praha: Grada Publishing, 2010. ISBN 978-80-247-3307-4. ISBN 978-80-247-330B-
2. Critchley, D. J., Pierson, Z., Battersby, G. Effect of Pilates mat exercise and conventional exercise programmes on transversus abdominis and obliquus internus abdominis activity: pilot randomised trial. *Man Ther.* 2011; 2: 183–189.
3. Curnow, D. et al. Altered motor control, posture and the Pilates method of exercise prescription. *Journal of Bodywork & Movement Therapies.* 2009; 13(1): 104–111.
4. Emery et al. The effects of a Pilates training program on arm-trunk posture and movement. *Clinical Biomechanics.* 2010; 25(2): 124–130.
5. Hodges, P. W., Richardson, C. A. Contraction of the abdominal muscles associated with movement of the lower limb. *Physical Therapy.* 1997; 77(2): 132–142.
6. Hodges, P. W., Richardson, C. A. Transversus abdominis and the superficial abdominal muscles are controlled independently in a postural task. *Neurosci Lett.* 1999; 265(2): 91–94.
7. Kolář, P. Kineziologie páteře, pánve a hrudníku. pp. 128–143. In kolář, P. et al. *Rehabilitace v klinické praxi*. Praha: Galén, 2009. ISBN 978-80-7262-657-1.
8. Kolář, P., Lewit, K. Význam hlubokého stabilizačního systému v rámci vertebrogenních obtíží. *Neurologie pro praxi.* 2005; 5: 270–275.
9. La Touche, R., Escalante, K., Linares, M. T. Treating non-specific chronic low back pain through the Pilates method. *Journal of Bodywork & Movement Therapies.* 2008; 12(4): 364–370.
10. Lim, E. C. et al. Effects of pilates-based exercises on pain and disability in individuals with persistent nonspecific low back pain: A systematic review with meta-analysis. *Journal of Orthopaedic and Sports Physical Therapy.* 2011; 41(2): 70–80.
11. O'Brien, N.; Hanlon, M.; Meldrum, D. Randomized Controlled Trial Comparing Physiotherapy and Pilates in the Treatment of Ordinary Low Back Pain. *Physical Therapy Reviews.* 2006; 11(3): 224–225.
12. Pereira, L. M. et al. Comparing the pilates method with no exercise or lumbar stabilization for pain and functionality in patients with chronic low back pain: systematic review and meta-analysis. *Clinical Rehabilitation.* 2012; 26(1): 10–20.
13. Rydeard, R., Leger, A., Smith, D. Pilates-based therapeutic exercise: effect on subjects with nonspecific chronic low back pain and functional disability: a randomized controlled trial. *J Orthop Sport Phys.* 2006; 36(7): 472–484.
14. Segal, N. A., Hein, J., Basford, J. R. The effects of pilates training on flexibility and body composition: an observational study. *Arch Phys Med Rehab.* 2004; 85(12): 1977–1981.
15. Suchomel, T. Stabilita v pohybovém systému a hluboký stabilizační systém – podstata a klinická východiska. *Rehabilitace a fyzikální lékařství.* 2006; 3: 112–124.
16. Van Tulder, M. W. et al. Method guidelines for systematic reviews in the cochrane collaboration Back Review Group for Spinal Disorders. *Spine.* 1997; 22: 2323–2330.

Acknowledgement

I am thankful to my colleague, Blahoslav Komeščík, for his kind support and encouragement, which made it possible for the research to have been carried out.

CONDITIONS FOR HEALTHY LIFESTYLE IN CZECH PUPILS WHO ARE DEAF AND HARD OF HEARING

Petra Kurková

Faculty of Physical Culture, Palacký University, Olomouc, Czech Republic

Abstract

The purpose of this study was to compare the educational environments of pupils educated in regular and special education programs to ascertain which environment promotes a healthy life style for pupils who are deaf and hard of hearing attending at nine basic schools (grade 6th-9th). Six principals of regular schools and three principals of schools for the deaf were interviewed. The following methods were used: document analysis, questionnaires, interviews, and basic statistical procedures. The Mann-Whitney test was used to evaluate the interrelationship's of the questionnaires. The schools for the deaf have in more cases a teacher of physical education with a specialization for adapted physical activities or special education ($p=.07$) than the regular schools. Among regular schools and schools for the deaf in school capacity, developing educational and/or health related projects, thematic units that focus on health education and realized events in the field of health promotion and sport were not found any differences. The lack of graduated teacher in the field of specific communication needs for students who are deaf and hard of hearing at regular schools is evident. Therefore is necessary to develop better cooperation among specialist in the field of special needs for individuals who are deaf and hard of hearing.

Key words: physical activity, physical education, sport, leisure time, school settings

Introduction

Implementing health-promoting programmes for the most excluded groups forms a key part of any efforts to address underserved populations and reduce health inequalities in society. Regular physical activity increases active longevity, improves the quality of life and promotes health in all individuals without age differences (Blair & Morris, 2009). Healthy development in children and youth is strongly dependent on promoting healthy life style in students in school environment. However, there is lacking general dissemination of effective and targeted intervention to the members of cultural minority groups, including persons with disabilities (LaVeist, 2005). For instance, in the case of the deaf community, which are recognized as members of a cultural and linguistic minority (Marchark, 2007), access to information related to health and an active movement regimen may be handicapping in comparison to the majority population (Iezzoni et al., 2004; Pollard & Barnet, 2009; Sadler et al., 2001).

Inclusive educational settings could imply to have educational, social, emotional benefits for pupils who are deaf and hard of hearing, but on the other site inadequate counselling and to high expectations of parents and could be too demanding for the deaf child and could lead to their emotional deprivation and social isolation (Cerney, 2007; Marschark, 2007). The purpose of this study was to compare how physical and health education are taught in selected Czech school (regular and special education) for pupils from grades 6 up to 9.

Method

The participants of the study included six principals from regular basic schools and three principals from schools for the deaf. Two questionnaires were distributed throughout the study. The first questionnaire (Muzikova's, 2006) has been use in the Czech Republic to access basic information about the school (e.g., demographic information, school capacity), health and physical education, teachers' credentials, and provide information on any activities that support a healthy lifestyle. The second questionnaire (Institute for Information on Education, Fast Surveys, Wave 4, 2006) assesses information on school diet, physical activities, leisure activities, after-school centres and school clubs. For evaluation of the interrelationships of both questionnaires the Mann-Whitney test was used.

Results

Conditions in school settings

When comparing answers of the school principals (regular and special education) the following differences have been discovered:

- ✓ Principals of schools for the deaf consider efficiency of preventive programmes realized at schools sufficient more than directors of regular schools ($p < .05$).
- ✓ Lessons of family education are given more often at regular schools ($p < .05$), while lessons of health education are concentrated on more at schools for the deaf ($p < .07$).
- ✓ Physical education teachers having, at the same time, the approbation special pedagogy or applied moving activities work at schools for the deaf more often than at regular schools ($p < .07$).

When comparing regular schools to schools for the deaf, differences in the following fields were not found:

- ✓ School capacity (a school with one class for each year only was considered a small school; a school with two or more parallel classes for a year was considered a large school).
- ✓ School involvement in educational and developing projects in the field of health support.
- ✓ Compiling thematic plans affecting problems of health education.
- ✓ Events aimed at health and sports, realized within the frame of the school.

Free time activities

When realizing free time activities of pupils who are deaf and hard of hearing, big differences were discovered in accessibility to classrooms and school facilities (when following the set rules) out of classes. The differences are as follows:

- ✓ In the days of school classes pupils who are deaf and hard of hearing, attending a school for the deaf, have access to the sports ground ($p < .02$) and to specialized classrooms ($p < .04$), operation of which is also fully organized (sports ground $p < 0.007$; specialized classrooms $p < .006$) more often than pupils who are deaf and hard of hearing, attending regular schools.

Discussion

In this study were compared the educational environments of pupils educated in regular and special education programs at nine Czech basic schools (grade 6th-9th). The physical education curriculum standards are the same for both the schools for the deaf and the regular schools. Nevertheless there are different conditions for extracurricular physical and sport activities. Those were varying depending on the type of school (residential, non-residential). And there was found negative aspect by physical education teacher's qualification in regular schools. This lack of teacher training programs for educator in regular schools can deepen the information and communication barriers of individuals who are deaf and hard of hearing in their future life style. Therefore is necessary to enable pupils who are deaf and hard of hearing full access to information in healthy life style during compulsory school education. This is only possible with close cooperation among principals, teachers of health and physical education, and also parents of pupils and responsible local boards.

Conclusion

In the present study, nine principals were polled to compare conditions in physical and health education in selected Czech basic schools (regular and special education). It is evident that there is a critical shortage of qualified professionals graduating from teacher training programs in deaf education. As a result there are not enough teachers of the deaf and hard of hearing pupils who possess the communication skills to work with this population. Therefore, it is necessary to develop better cooperation among specialists in the field of special needs for individuals who are deaf and hard of hearing.

Obtained results from the study are possible to summarize into the following recommendations:

- ✓ Support the trend in approach to individuals who are deaf or hard of hearing in transformation of focused segregation to legislative supported inclusion of these individuals into general life in the sphere of education, work and leisure time.
- ✓ Create a friendly environment in school settings, not only for pupils who are deaf or hard of hearing and their classmates, but also for their teachers. In relationship to the creation of positive habits, which are leading to the embracing of health supporting behaviour by pupils in adulthood, it is critical that physical education teachers be motivated to engage in lifelong learning and become collaborative partners while pursuing research and remaining current in the field. It is essential that these teachers remain up to date on the changing trends in education so that they can better serve students who are deaf or hard of hearing as well as those with multiple disabilities who are attending school in general or special education settings.

- ✓ Adapt school settings in physical education (observing the principles of correct communication and making use of technological equipment). These adaptations make easy the orientation of pupils who are deaf or hard of hearing and can have a positive influence on their experiences in physical education. If a sensitive pedagogical approach is used, the general school setting can be a stimulating factor for the creation of an active physical regime, which will lead to a healthy life style.
- ✓ Include in schools an education programme providing information about successful athletes and deaf sport. Teaching of this issue supplemented with communications specific to individuals with hearing loss would be without a doubt beneficial for pupils who are studying at general schools. This would be a good way for them to gain new information about persons with hearing loss or with other disabilities.

References

1. Blair, S. N., & Morris, J. M. (2009). Healthy hearts—and the universal benefits of being physically active: Physical activity and health. *Annals of Epidemiology*, 19(4), 253–256.
2. Cerney, J. (2007). *Deaf education in America: Voices of children from inclusion settings*. Washington, D.C.: Gallaudet University Press.
3. Iezzoni, L. I., O'Day, B. L., Killen, M., & Harker, H. (2004). Communicating about health care: Observations from persons who are deaf or hard of hearing. *Annals of Internal Medicine*, 140(5), 356–362.
4. Institute for Information on Education (2006). *Rychlá šetření 2006, 4. kolo: 4.–8. 12. 2006* [Fast Surveys, Wave 4: 4th–8th December 2006]. Retrieved April, 10, 2007 from: <http://www.uiv.cz/clanek/442/1237>
5. LaVeist, T. A. (2005). *Minority populations and health: An introduction to health disparities in the United States*. San Francisco: Josey-Bass.
6. Marschark, M. (2007). *Raising and educating a deaf child. A comprehensive guide to the choices, controversies, and decision faced by parents and educators*. (2nd ed.). Oxford, NY: Oxford University Press.
7. Mužiková, L. (2006) *Výchova ke zdraví v současném základním školství*. Rigorózní práce. [Health Education in Recent Basic Education. Unpublished Rigorous Thesis]. Brno, Czech Republic: Masaryk University.
8. Pollard, R. Q., & Barnett, S. (2009). Health-related volabulary knowledge among deaf adults. *Rehabilitation Psychology*, 54(2), 182–185.
9. Sadler, G. R., Huang, J. T., Paden, C. A., Elion, L., Galey, T. A., Gunsauls, D. C., & Bauer, B. (2001). Bringing health care information to the deaf community. *Journal of Cancer Education*, 16(2), 105–108.

Acknowledgement

This paper was supported by a grant of the Czech Science Foundation No. 406/07/P176 and also by the grant project *Increasing professional competencies of students in healthcare and sports study programmes in relation to persons with a disability*, CZ.1.07/2.2.00/28.0181, funded by ESF and the budget of the Czech Republic.

THE ROLE OF THE ADJUSTMENT IN 3 DIMENSIONS OF THE CERVICAL SPINE IN THE CASE OF PATIENTS WITH DISK HERNIATION

Gabriela Ochiană and Nicolae Ochiană

*Faculty of Movement, Sports and Health Sciences,
“Vasile Alecsandri” University of Bacău, Romania*

Abstract

The purpose of this study is to maintain a professional, social and family activity at a high quality standard by removing the compression on the level of the central nervous system. We started from the following hypothesis: if an adjustment in three dimensions of the cervical spine is performed on patients with cervical disk herniation, the interference on the level of the central nervous system will be removed and symptoms such as pain, paresthesias and motor deficiency will not occur. The study was carried out over a period of 1 year, on a number of 20 patients. The experimental group benefited from the 3D adjustment of the cervical spine, and the control group followed the medication prescribed by the physician. For the assessment, we used the pain assessment scale, the scanning using the hand-scanner, the X-ray and the MRI. After setting the pattern (3 successive scans), we performed the 3D adjustment of the cervical spine according to the radiologic listing, with a frequency of 1-2 sessions per week. The results achieved confirm the hypothesis according to which the cervical adjustment eliminates the subluxation, removes the interference on the central nervous system and the symptoms disappear. In conclusion, the alignment of the cervical spine sets the proper conditions for reducing disk herniation, and the formation of cervical lordosis, prevents any future herniation.

Key words: *central nervous system, pain, paresthesia, subluxation, listing*

Introduction

The vertebral column is the pillar that supports the human body. Besides its many functions (mobility, stability), the most important one is that of protecting the central nervous system in the medullary tract. Due to the fact that the spine is used in all the activities of daily living as well as in professional activities (adopting a sitting position with the flexion of the head and the neck and the kyphosis of the lumbar spine, lifting and carrying heavy things, etc), the intervertebral disk can shift to the postero-lateral (most frequently) or posterior side, pressing on the nerve roots or on the dura mater, with characteristic clinical manifestations: pain, paresthesia or even motor deficiency on a certain area corresponding to the peripheral nerve (Popescu, E., Ionescu, I., 1995). In case of the first cervical vertebrae, other clinical signs can also be associated: dizziness, nausea/vomiting, balance disorders, intense cephalaea. (Ionescu, R., 2007)

During the last years, the frequency of disk disorders and cervical disk herniations have increased alarmingly, pathology which limits the performance of professional activities or even the performance of daily activities (Ochiană, G., 2009). Classical medicine recommends medication which decreases the inflammation on the level of the nerve, relaxes the muscle but does not remove the cause, which is the compression of the disk/vertebra on the nerve (Crețu, A., 1996). The subluxation will create interference on the level of the central nervous system, with all the manifestations described below, and requires a 3D adjustment of the cervical spine, which clears the compression and leads to the disappearance of the symptoms. Chiropractic, within which 3D adjustment of the cervical spine is performed, is considered to be complementary and alternative medicine used to prevent disorders of the neuro-myo-arthro-kinetic system and the effects of these disorders on the general health (Chapman-Smith, 2005).

Methods

The purpose of this study is to maintain a professional, social and familial activity performed at a higher standard by removing the compression on the level of the central nervous system. We started from the following hypothesis: if in the case of patients with cervical disk herniation we perform an adjustment in 3 dimensions of the cervical spine, the interference on the level of the central nervous system will disappear and the symptoms such as pain, paresthesia and motor deficiency will not occur.

The study was carried out over a period of 1 year, on a number of 20 subjects with ages between 21 and 60, divided into 2 groups. The experimental group (table 1), made up of 10 subjects, benefited from the 3D adjustment of the cervical spine, while the control group (10 subjects) took only the medication prescribed by the physician (table 2).

For the assessment we used: the pain assessment scale (0 – 10), the scanning of the cervical spine (from C7 to C0) using the hand-scanner (the value 0 corresponding to the absence of interference on the level of the nervous system, while the values over 2 show the existence of interference), the x-ray of the cervical spine on sagittal plane (in order to follow the anteriority or the posteriority of the atlas and the inferiority of the axis) and on frontal plane with the mouth open, which allowed us to visualize the vertebrae C1 and C2, and their displacement, as well as the MRI.

After 3 successive scans at intervals of 10 minutes, we set the pattern for each patient. According to the radiologic listing and the presence of interference (values over 2 during the scanning) we performed the adjustment of the cervical spine. After the procedure, each patient rests in dorsal decubitus position for 10 minutes up to 2 hours. The frequency of sessions was of 1 per week, and when the scanning showed values of 0 – 1, we performed only an alignment of the lower limbs and a balancing of the vertebral spine in general.

Table 1: Subjects of the experimental group

No	Name	Sex	Age	X-ray/MRI/Symptoms	Listing	Duration of the treatment
1	A.M.	M	42	X-ray – straight cervical spine, vertebral bodies C5-C6 slightly compressed; MRI – disk herniation L4 – L5 left; disk herniation C5 – C6 left. Paresthesias and pain in the left upper limb. Lumbar pain with irradiation on the bilateral lower limb;	ESR/ ASRA	2 months and 1/2
2	F.R.	M	38	X-ray – disk herniation L4 – L5 left. Lumbar pain with irradiation on the left lower limb, paresthesias of the left antero-lateral thigh.	PLI/ AIL	3 months and 1/2
3	P.N.	M	21	X-ray – the cervical spine tends to be straight; Paresthesias of the right upper limb.	ASRA/ PRI	2 months
4	C.I.	M	43	X-ray – straight cervical spine pressing on the intervertebral area C5-C6; Paresthesias of the left upper limb, pain in the left shoulder blade.	ASLA/ ESL	2 months and 1/2
5	N.M.	F	41	X-ray – straight cervical spine, diskopathy C4-C5, C5-C6; Dizziness, nausea, occipital neuralgia, lumbar pain	BR/ ASR	2 months
6	M.T.	F	60	X-ray – straight cervical spine, disk herniation left L4-L. Paresthesias on the upper limbs, occipital neuralgia, lumbar pain with irradiation on the left lower limb.	AIL/ BR	5 months
7	L.S.	F	37	X-ray – straight cervical spine. MRI- disk herniation C3-C4, disk protrusions C4-C5 and C5-C6 which press on the dura mater and the medullar belt Great intensity headache, paresthesias of the left upper limb, stiffness of the cervical spine, dizziness	BR/ AS+R	5 months
8	A.R.	F	48	X-ray – straight cervical spine. MRI- small posterior sub-ligament disk protrusions C3-C4, C4-C5, C5-C6 and C6-C7, without medullo-radicular contact. Stiffness of the cervical spine and of the shoulders, dizziness, occipital neuralgia	ESR/ AS	5 months
9	C.G.	F	53	X-ray – straight cervical spine and a tendency to kyphosis, disk protrusion C3-C4. Dizziness, stiffness and pain in the shoulder	PRI/ ASR+	5 months
10	G.P.	F	42	X-ray – straight cervical spine. Lumbar pain with irradiation in the left lower limb, paresthesias of the posterior shank, dizziness, headache	ASL/ PRI	2 months and 1/2

PR=spine C2 rotated to the right; AR=C1 moved to the right; AS=C1 moved to the left; PRI=spine C2 moved downward and to the right; AS+R= C1 moved to the right; ESR= C2 moved to the right; BR=C2 moved to the right; AIL=C1 moved downward to the left; PLI=spine C2 moved downward to the left; ASLA=C1 moved forward and to the left; ESL= C2 moved to the left; ASRA= C1 moved forward and to the left; AIL= C1 moved downward to the left; ASR= C1 moved upward to the right; ESR= C2 moved to the right

Table 2: Subjects in the control group

No	Name	Sex	Age	X-ray/MRI/Symptoms	Listing
1	T.I.	M	43	Paresthesias and pain in the right upper limb, the cubital edge	2 weeks
2	D.O.	M	45	Occipital neuralgia, pain in the right part of the chest, paresthesias of the right upper limb	3 weeks
3	M.V.	M	42	Paresthesias of both upper limbs, intense headache	2 weeks
4	R.B.	M	43	Dizziness, nausea, occipital neuralgia	2 weeks
5	C.E.	F	41	Stiffness, paresthesias and pain in the shoulders	3 weeks
6	R.S.	F	43	Paresthesias in both upper limbs and occipital neuralgia	2 weeks
7	G.L.	F	44	Pain and paresthesia in the left upper limb, on the cervical nerve tract	3 weeks
8	P.I.	F	49	Paresthesias and pain in the right shoulder, nausea, vomiting	2 weeks
9	N.G.	F	45	Headache and occipital paresthesia	2 weeks
10	P.V.	F	42	Pain in the left shoulder, paresthesia of the left upper limb	2 weeks

Results

For the subjects in the control group, the number of sessions was different according to the location of the disk herniation on the level of the spine, the duration of the affection, the degree to which the indications had been obeyed, the age of the subjects. Thus, the evolution of the subjects and the results achieved were the following:

1. A.M. – The lumbar pain improved significantly, and during the 3rd session it was only a lumbar discomfort, without irradiation on the level of the lower limbs. The paresthesias disappeared for good after session 2, on the level of both upper and lower limbs. After a 3-week break (the patient went to a resort for recovery), since the scanning showed interference, he benefited from 7 more sessions, and the last 2 scans the listing was back to 0 (figure 1).

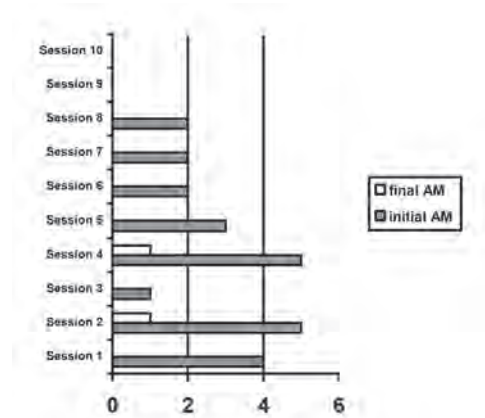

Figure 1: Results of the scan for subject A. M. before and after the adjustment

2. F.R. – The pain improved significantly, so as in the 8th session it disappeared for good and the paresthesias disappeared after session 3. When the patient resumed the physical activity, only discomfort was present in the lumbar area (only when the patient did not have a proper position of the spine). 15 sessions were necessary for 2 successive scans of 0 initial, as it follows from figure 2.

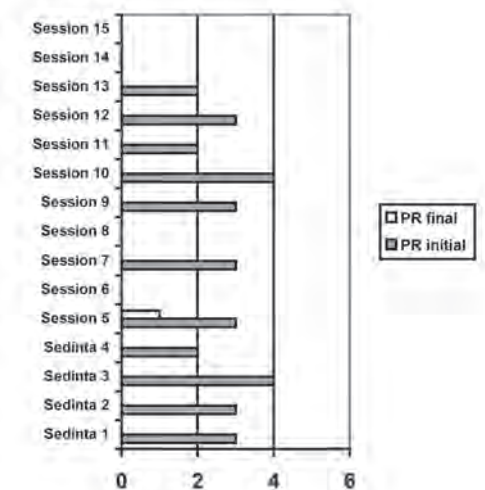

Figure 2: Results of the scan for subject F.R. before and after the adjustment

3. P.N. – The paresthesias disappeared after the first adjustment, but we got two consecutive scans with the value 0 only during the sessions 7 and 8 (figure 3).

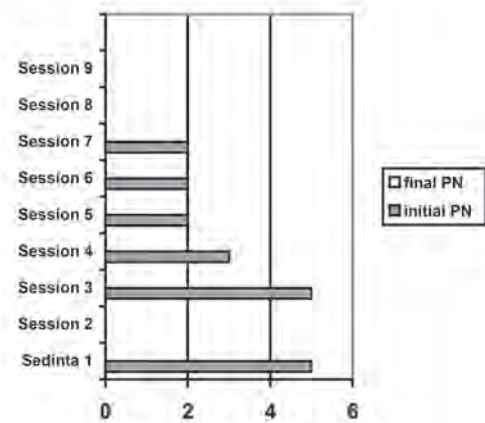

Figure 3: Results of the scan for the subject P.N. before and after the adjustment

4. C.I. During session 4, the pain is present only on the level of the shoulder blade, and during session 5 paresthesias and the pain disappeared, only 10 sessions being necessary (figure 4).

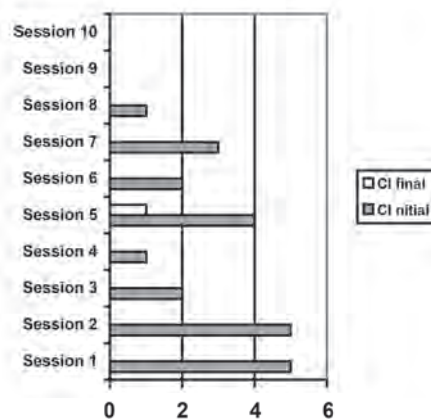

Figure 4: Results of the scan for the subject C.I. before and after the adjustment

5. N.M. – The pain decreased in intensity during session 6, paresthesias after session 4, and during session 5 the dizziness disappeared, 10 sessions being necessary. (graph no. 5)

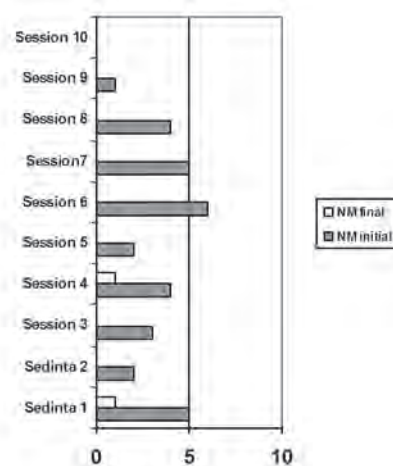

Figure 5: Results of the scan for the subject N.M. before and after the adjustment

6. M.T. – benefited from 20 sessions, until 2 consecutive scans had the value 0, and the pain diminished significantly after session 4, paresthesias after session 6. (figure 6)

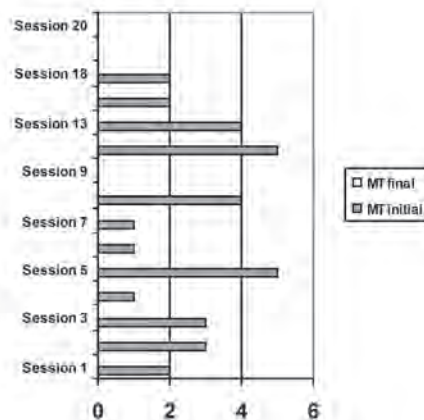

Figure 6: Results of the scan for the subject M.T. before and after the adjustment

7. L.S. – the pain disappeared completely after 8 sessions, the paresthasias after session 3 and the spine regain joint mobility, and the cervical lordosis replaced the straightness. (figure 7)

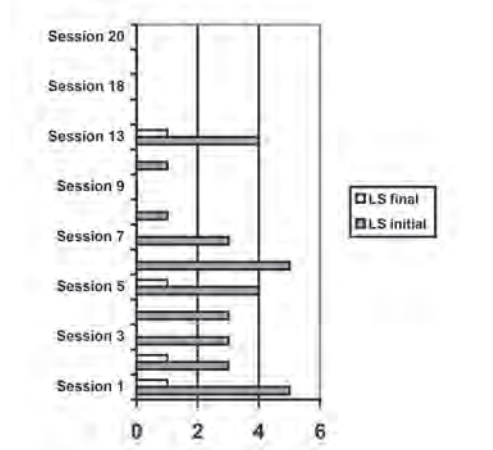

Figure 7: Results of the scan for the subject L.S. before and after the adjustment

8. A.R. – the pain was reduced in intensity progressively and was absent after session 4, the spine mobility improved and the muscle contractions disappeared. (figure 8)

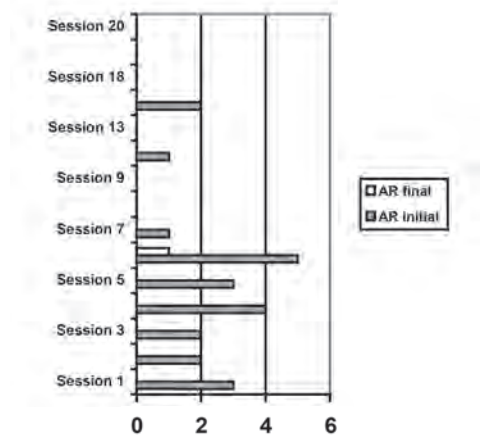

Figure 8: Results of the scan for the subject A.R. before and after the adjustment

9. C.G. – the pain in the shoulder disappeared (session 4), the mobility of the spine and the shoulders increased and paresthasias disappeared after session 2 (figure 9).

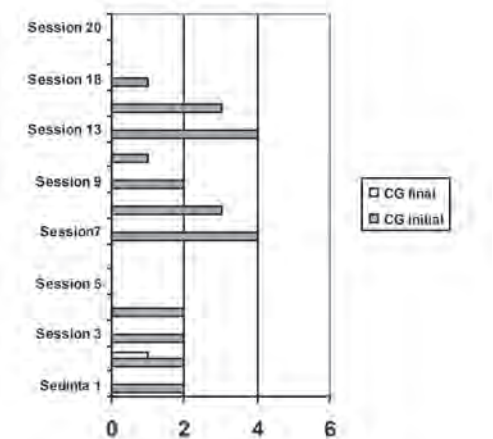

Figure 9: Results of the scan for the subject C.G. before and after the adjustment

10. G.P. – after session 2, paresthesias disappeared, pain disappeared after session 4, the dizziness diminished progressively until it disappeared for good (figure 10).

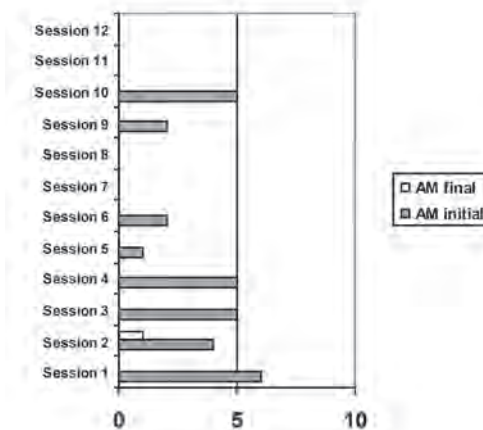

Figure 10: Results of the scan for the subject G.P. before and after the adjustment

In the case of the subjects in the control group, who were assessed before and after the medication, the results are not good, since the compression on the nervous system continues (figure 11). The improvement of pain after the medication, in the case of 6 out of the 10 subjects, was only short-term, reappearing 2 weeks after the treatment ended. When scanned, all the subjects had high values during the initial testing (values of 5 and 6), and the final test (values of 2 and 5). None of the subjects reached the value 0, which corresponds to the alignment of the cervical spine, the formation of the lordotic curvature and the absence of interference on the level of the nervous system.

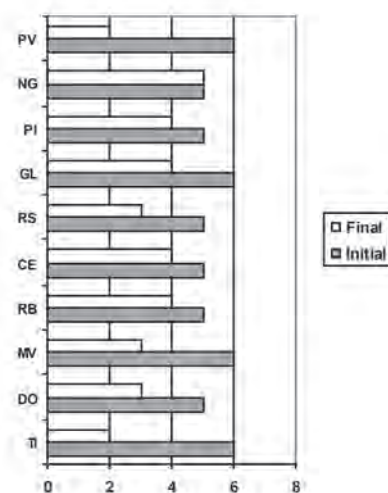

Figure 11: Evolution of the subjects in the control group by scanning with the hand-scanner

Discussion and conclusions

The adjustment in 3 dimensions of the cervical spine is beneficial in the case of patients with affections of the spine, respectively with disk herniations localized on cervical or lumbar level. These statements are supported by the results recorded for the subjects in the control group (graphs 1-10), who have symptoms such as: pain, paresthesias, headache, muscle contractures and stiffness; these symptoms disappeared according to the number of hernias and to their location. In the case of the subjects with 2, 3 or even 4 cervical disk herniation's (or disk protrusions), more sessions were necessary in order to remove the interference, for the pain and paresthesias to disappear, compared to the ones with only one herniated disk, be it lumbar or cervical. The treatment using medicine is only a provisional alternative which reduces nerve inflammation, relaxes the muscles but does not reduce the subluxation and does not decrease the interference on the nervous system. In conclusion, the alignment of the cervical spine creates favorable conditions to reduce disk herniations, and the formation of cervical lordosis prevents any future herniations.

The 3D adjustment of the cervical spine is a solution not only for the affections of the spine, but also for organic functional disorders which may appear due to the compression on the nervous system. The result of the adjustment is checked using the hand-scanner which shows the presence/absence of interference, if the adjustment was done, when the adjustment was done, being a very useful assessment tool for chiropractors.

References

1. Crețu, A., *Afecțiuni reumatice care beneficiază de kinetoterapie*. Edit. Romfel, București, 1996
2. Ionescu, R., *Esențialul în reumatologie*. Ediția a 2-a revizuită, Edit. Medicală Almatea, 2007
3. Ochiană, G., *Kinetoterapia în afecțiuni reumatismale*. Edit. Alma Mater, Bacău, 2009
4. Popescu, E., Ionescu, R., *Compendiu de reumatologie*. Edit. a II a, Edit. Tehnică, București, 1995
5. Chapman-Smith DA, Cleveland CS III (2005). *International status, standards, and education of the chiropractic profession*. In Haldeman S, Dagenais S, Budgell B *et al.* (eds.). *Principles and Practice of Chiropractic* (3rd ed.). McGraw-Hill. pp. 111–34.

ADAPTED SPORT – BADMINTON IN PERSPECTIVE OF DIFFERENT DISABILITIES

Lidija Petrinović

Faculty of Kinesiology, University of Zagreb, Croatia

Abstract

Disabilities as a term cover impairments, activity limitations, and participation restrictions. Adapted sport is sport modified or special created to meet the needs of individuals with disabilities. Persons with disability may participate in regular sport or in adapted sport depends on the way of organizations in a way of individualization or segregation. There are many sports which include persons with disability in their regular rules and made detail functional classification to ensure equal participation. Badminton is one of the sports that tend to be sport for all, where Badminton World Federation promotes vision of “one sport – one team”. Badminton sport is on Deaflympic, Special Olympic and Para Badminton is Paralympics candidate for Paralympics games 2020. There are no special adaptations that are necessary for the players on the Deaflympics. On Special Olympics there are some special disciplines concerning badminton technical elements, which is adapted to people with more severe disabilities. Unified sport disciplines promote partnership between persons with intellectual disabilities and partner without. For Para Badminton there is specific Classification that recognizes six Sport Classes. The rules are official rules governing by the Badminton World Federation, which are adapted for some Classes (e.g. wheelchair classes).

Key words: disability, intellectual disability, sport classification, deaflympics, Para-badminton

Introduction

About 15% of the world’s population has some form of disability, and 2-4% of them experience significant difficulties in functioning. This percentage of prevalence is higher than previous WHO estimates, which were a percentage of around 10%. This estimation for disability is due to population ageing and the rapid spread of chronic diseases. Disabilities as a term cover impairments, activity limitations, and participation restrictions. An impairment is a problem in body function or structure; an activity limitation. People with disabilities include those who have permanent physical, mental, intellectual or sensory impairments. Limitations in ability are limitations in mental or physical functioning, which only refers to impacts on how the body or mind functions. This approach to disability defines the interaction between a person’s functional limitations and the environment as creating barriers or facilitating participation. Overcoming these difficulties requires interventions to remove environmental and social barriers. Sport is one of areas where people with disability can find their fulfillment but also can find a lots of barriers. Adapted sport is sport modified or special created to meet the needs of individuals with disabilities. Persons with disability may participate in regular sport or in adapted sport depends on the way of organizations (individualization, segregation). The terms Disability sport and Adapted sport, adapted sport encompasses disability sport with typical focus on segregated participation in regular or adapted sport. The term adapted sport is more connected with terms like Adapted Physical activity and Adapted Physical education. The focus is more on modification of sport rather than on disability. Responses to disability have changed in last few decades, new self-organization of people with disabilities, and tendency to see disability as a human rights issue. There are many sports which include persons with disability in their regular rules, made detail sport classification etc. Badminton is one of the sport that tend to be sport for all, with a BWF (Badminton World federation) promotes a “one sport – one team” philosophy.

Para - Badminton

Badminton is not official recognized sport at Paralympics Games, but is tend to become in Paralympics Program in Tokyo 2020. The BWF is responsible for developing, regulating and managing badminton and Para-badminton at the international level. Para-badminton is official name for badminton adapting for persons with some kind of physical disability (detail in classification rules of the sport). Para-badminton players can compete in all five traditional badminton disciplines. Players have to be classified into special “Sport Classes”, and the aim is to ensure fairness in competition. Functional Classification in every sport is very important and processes in progress that are tend to focus on scientific bases. In badminton there are 6 Sport Classes: Wheelchair Sport Classes - WH 1 and WH 2, Standing Sport Classes - SL 3, SL 4 and SU 5, Short Stature Sport Class - SS 6. Classification regulations which comply with the IPC Classification Code and International Standards are part of official Laws and Regulations of the badminton game in BWF. Para-

badminton Committee and Para-badminton Commission are responsible of development of Para-badminton. Classifiers evaluate players and determine their Sport Class and Sport Class Status for play in tournaments. They are trained by BWF and there are three levels of classifier: Trainee Classifier, Level 1 - International Classifier and Level 2 – Senior International Classifier. In 2012. The BWF Council approved an annex to the Laws of Badminton. This covers Additional Equipment for Para-Badminton, refers to uses of wheelchair, crutch and prosthetic limbs. A player's body may be fixed to the wheelchair with a strap either around the waist or across the thighs, or both and a player's feet must be fixed to the footrest of the wheelchair. In time when a player strikes the shuttle, a part of the trunk and the legs must be in contact with the seat of the wheelchair. The seat of the wheelchair, including any padding can be horizontal or angled backwards, but not be angled forward. An upper or lower leg amputee may use a crutch, which must not exceed the players' natural measurement from the armpit to the ground. An amputee player may use a prosthetic limb. The prosthetic limb must be the same length as the players existing limb, and be in proportion with the players other limbs.

The World Para-Badminton Championships were held in 2013, in Germany. In six Sport Classes 235 players competing and nineteen countries winning medals (there were no playing for the third place, so there are two bronze medals). They play in traditional five categories, and the competition entered thirty-three nations, entries with WH Class: 61 MS, 18 WS, 31 MD, 10WD, 37MXD; Standing Class: 104 MS, 17 WS, 58MD, 11WD, 41 MXD; Short Stature 14MS, 5 WS, 5MXD, 9 D (together doubles category). In Table 1. and Table 2. are shown some basic statistic data from the World Para-Badminton Championship in two categories – one Wheelchair Class (WH1) and one Standing Class (SL3).

There are average match duration between 24-26 minutes, with longest match played in discipline Men Singles over one hour. There are some problems concerning entries in discipline Women Doubles, that there were not enough entries so it was necessary to put two Classes together.

Table 1: Basic statistic parameters concerning match play in Wheelchair Class 1

	WH1 – MS	WH1 - WS	WH1 – MD	WH1/2 –WD	WH1 - XD
Number of matches	62	15	30	17	15
Number of player/pairs	37	8	16	10	8
Average duration of the match	24,38	25,13	26,83	26,76	26,53
Average duration in Group stage	21,92	23,33	25,52	26,5	24,25
Average duration match elimination stage	28,56	32,33	31,14	27,4	35,66
Shortest match duration (min)	12	17	13	15	18
Longest match duration (min)	62	43	48	48	54
Number of matches on three games	7 / (11%)	2 / (13%)	4 (13%)	2 / (11%)	0

Table 2: Basic statistic parameters concerning match play in Standing Class 3

	SL3 – MS	SL3/4 - WS	SL3 – MD	Standing –WD	Standing - XD
Number of matches	65	12	32	6	19
Number of player/pairs	39	8	19	4	41
Average duration of the match	27,56	22,75	24,56	21,33	22,63
Average duration in Group stage	27,40	22,33	23,28	-	19,08
Average duration match elimination stage	27,86	24,0	27,0	-	28,71
Shortest match duration (min)	13	12	16	16	13
Longest match duration (min)	52	40	44	25	43
Number of matches on three games	9 / (14%)	3 / (25%)	4 / (13%)	0	4 / (21%)

Badminton at Deaflympics

Badminton has been an official sport at Summer Deaflympics since 1985. In 2013. in Bulgaria, at the 22nd Summer Deaflympics 99 players competing and six countries were winning medals: Bulgaria, China, Chinese Taipei, Indonesia, Russia, and Korea. They play in traditional five categories, and the competition entered twenty-three nations, entries with 57 men and 42 women (MS 55, WS 38, MD 24, WD 16, and MXD 34).

The Summer and Winter Deaflympics are among the world's fastest growing multi-sports events. Organized since 1924 by the International Committee of Sports for the Deaf, the Summer and Winter Deaflympics are sanctioned by the International Olympic Committee (IOC).

Participation in the Deaflympics is restricted to persons who are deaf, defined as a hearing loss of at least 55dB in the better ear. From the technical regulations the use of any hearing aid(s)/amplification or external cochlear implant parts is strictly forbidden from the restricted zone area. The restricted zone area is from the time athletes enter on the whole badminton courts hall area during the warm-up and competition period.

There are no special adaptations that are necessary for the players, and the rules are official rules governing by the Badminton World Federation (BWF)

Table 3: Basic statistic parameters concerning match play at Deaflympic 2013.

	MS	WS	MD	WD	MXD
Number of matches	101	66	40	32	58
Number of player/pairs	55	38	24	16	34
Average duration of the match (min)	26,03	24,57	26,12	22,25	23,78
Average duration in Group stage	23,05	21,54	23,3	20,29	20,78
Average duration match elimination stage	32,34	29,87	30,18	28,12	28,72
Shortest match duration (min)	14	12	14	12	12
Longest match duration (min)	56	62	57	48	51
Number of matches on three games / (%)	17 / (16%)	12 / (18%)	6 / (15%)	3 / (9%)	13 / (22%)

Badminton at Special Olympics

The first International Special Olympics Summer Games were held in 1968. in United States. The movement of Special Olympics starts in the 1950s and early 1960s, with initiative of Eunice Kennedy Shriver. The goal was to give people with intellectual disability a chance to learn what they can do in sports and other activities, rather than what they cannot do. Intellectual disability (or ID) is a term for person who has certain limitations in cognitive functioning and skills, including communication, social and self-care skills.

According to the American Association of Intellectual and Developmental Disabilities, an individual has intellectual disability if meets three criteria: IQ is below 70-75, there are significant limitations in two or more adaptive areas (e.g. communication or self-care). Intellectual disability is term formerly known as mental retardation.

Badminton is on Special Olympics since 1995. and the rules are based on the BWF rules. Official events on Special Olympics are: Individual Skills Competition, Singles, Doubles, Mixed Doubles, Unified Sports Doubles and Mixed Doubles. Modifications in Laws Special Olympics can be for wheelchair athletes who will have the option of serving an overhead serve area and the serving area is shortened to half the distance for Special Olympics wheelchair athletes. In Special Olympics sports, athletes are formed in competition divisions according to ability level, age and gender. Special Olympics athletes can participate in Unified Sports Badminton doubles and mixed doubles events. Unified Sports is a unique programme that combines Special Olympics athletes and athletes without intellectual disabilities (partners).

In Individual Skills Competition athletes can compete in basic badminton skills. These skills include strokes, serves and volleys. A player's final score is getting from adding together the scores achieved in each of the event.

1. Hand Feeding , the feeder (usually the coach) holds five shuttles at one time in his/her arm and throws the shuttles, one at a time, and athlete tries to hit the shuttles with his/her racket and is awarded one point each time he/she hits the shuttle.
2. Racket Feeding (for overhead strokes), the feeder holds five shuttles and one at a time hits the shuttle high to the athlete using an underhand stroke, and the athlete is awarded one point if he/she hits the shuttle.
3. The "Ups" Contest, the shuttle is repeatedly hit in the air by the athlete; the point is awarded for each hit within a 30-second time frame.
4. Forehand Stroke, the athlete stands two feet from the net with the feeder positioned on the opposite side of the net, the feeder, using an underhand serve, hits the shuttle to the forehand side of the athlete, the athlete has five attempts and receives one point for each successful forehand stroke that goes over the net and into the court.
5. Backhand Stroke, scored the same as the forehand stroke except that the feeder hits the shuttle to the backhand side of the athlete.
6. Serve, the athlete has five attempts to serve from either side of the service court (underhand or overhand serve may be used).

Conclusions

The percentage of prevalence of the world's population that have some kind of disability, estimated by WHO, in past were around 10%, but today is about 15%. The goal of adapted sport is from this percentage to attract as many people in sports activities. Disabilities as a term should focus on what persons can do, not the opposite, what he lost with disabilities. The sport is definitely one of the way that person can self realized. Adapted sport is sport modified or special created to meet the needs of individuals with disabilities. In Badminton sport there are just few modifications. On Special Olympics there are more non competitive and more adapted elements. Deaflympic and Para Badminton is competition oriented, with just few adaptations in Para badminton, like dimension of the court for wheelchair users. The results from top badminton competition in 2013. like Deaflympic and Para Badminton World Championships shows some matches on high competition level. Average duration of the mach was around 25 minutes (min 12 and max 62min). In standard population, World Championship 2013, there was average duration around 40 minutes (min 17 and max 85min). Percentage of matches on three games was around 15%, in standard population there are 25% respectively. It can be seen lower participation in women disciplines at Para Badminton competition. With a popularization of the game, promoting unique approach, with one governing body, better access to information, notification of the results of all competitions at the same place (web page of BWF) will contribute to the further development of this part of the adapted sport. The aim is to involve as many players in the system, promote badminton as a very accessible and adapted sport.

References

1. Tweedy, S. M., Vanlandewijck, Y. C. (2011). International Paralympic Committee position stand-background and scientific principles of classification in Paralympic sport. *British Journal of Sports Medicine*. Vol. 45 (4), Pages: 259-269.
2. Karahan, M., Salman, M.N., Unlu, H. (2012). Badminton basic skills learning level of boys with mild intellectual disabilities. *Energy Education Science and Technology Part B-Social and Educational Studies*. Volume: 4 Issue: 1 Pages: 413-418.
3. Petrinović-Zekan, L., Ciliga, D., Trkulja-Petković, D. (2011). Research on sport activity in persons with disability in Croatia. In: D. Milanović i G. Sporiš (Ur.), *Proceedings Book of the 6th International Conference on Kinesiology "Integrative Power of Kinesiology"*, Opatija 8-11.09. (67-72). Zagreb: Kineziološki fakultet Sveučilišta u Zagrebu.

EVALUATION OF HYDROTHERAPY IN THE REHABILITATION PROGRAMME FOR PEOPLE WITH MUSCULAR DYSTROPHY

Matej Plevnik¹, Iztok Retar¹ and Anton Zupan²

¹University of Primorska, Science and Research Centre, Institute for Kinesiology Research, Koper, Slovenia

²University of Ljubljana, University Rehabilitation Institute - Soča, Ljubljana, Slovenia

Abstract

The objective of our study was the evaluation of the hydrotherapy programme, swimming abilities of subjects and the importance of different rehabilitation techniques included in the rehabilitation programme. 236 people who attended the National Rehabilitation Programme for people with muscular dystrophy, organised by the Muscular Dystrophy Association of Slovenia, filled out the designed questionnaire with 32 variables. Hydrotherapy and swimming are besides individual exercises in physiotherapy and therapeutic massage an important part of rehabilitation for people with muscular dystrophy. People, who were not able to swim under water or were not able to dive, evaluate hydrotherapy as more useful part of the rehabilitation procedure. Adaptation to water and learning effective self-rescuing techniques represent an important part of hydrotherapy programmes for people with neuromuscular disorders.

Key words: *swimming, muscular dystrophy, independent moving, rehabilitation programme*

Introduction

Hydrotherapy can be essential for maintaining the best quality of life for the longest time possible and is seen as a vital part of conventional medicine and patients are reimbursed by health insurance companies in many countries. It is a highly effective form of therapeutic exercise for people with neuromuscular disorders. With other water-based activities they are a vital health and society activity for people with neuromuscular disorders and also for their families. In water they build confidence and promote mobility, particularly because water is an environment, where people with neuromuscular disorders have a chance for completely independent movement. Furthermore, movement especially in warm water gives a feeling of well-being and relaxation even if exercising is quite hard. Several studies report that measurement improvement in the quality of daily living may be obtained in patients with neuromuscular disorders when they receive physiotherapy in association with hydrotherapy (Cunha, Olivera, Labronici & Gabbai, 1996). The general scope of rehabilitation programmes for people with neuromuscular disorders are the prevention of muscular weakness, contractures, scoliosis, respiratory insufficiency, cardiac affection, nutrition disturbances, dependence on the help of others, social isolation, physiological and other problems (Zupan, 2004). All problems also lead to reduced physical activity and sedentary lifestyle (McDonald, 2009). Exercises in water are useful because of the physical effect of water. Aquatic rehabilitation is currently used for people with neuromuscular disorders who have abnormal sensation, impaired motor control or weakness, poor coordination, impaired balance or equilibrium reaction, decreased ability, abnormal gait pattern, decreased endurance and depression or poor motivation (Rosen, 1999). Because of the characteristics of water (density, viscosity, buoyancy, increased resistance, hydrostatic pressure and thermodynamics), water environment helps patients achieve rehabilitation goal and also allow performing exercises that would normally be impossible on land (Zupan & Plevnik, 2009). Becker (2009) explains that the most appropriate form of water exercise for people with neuromuscular disorders suggest one-on-one therapies, respiratory training in water, watsu (an aquatic technique derived from shiatsu massage and Bad Ragaz, a floating technique focusing on carefully controlled movement and breathing, and gently progressive strengthening combined with aerobic exercise) and group warm water exercises. Reduced physical activity is a consequence of progressive neuromuscular diseases, which negatively impact quality of life and health outcomes (McDonald, 2002).

Methods

Sample of subjects

226 people, who participated in the rehabilitation programme for people with neuromuscular disorders, which was organised by the University Institute of Rehabilitation of Slovenia and Muscular Dystrophy Association of Slovenia in summer 2006, were included in our study.

Table 1: Basic characteristics of the sample

	Sample	Males	Females
Gender	226	113 (50%)	113 (50%)
Age (yrs)			
<10	5 (2.1%)	3 (2.7%)	2 (1.8%)
11–20	22 (9.9%)	14 (12.4%)	8 (7.2%)
21–30	21 (9.0%)	10 (8.8%)	11 (9.9%)
31–40	35 (15.0%)	19 (16.8%)	16 (14.4%)
41–50	38 (17.2%)	17 (15%)	21 (18.9%)
51–60	51 (23.2%)	25 (22.1%)	26 (23.4%)
61–70	31 (14.2%)	16 (14.2%)	15 (13.5%)
>70	21 (9.4%)	9 (8%)	12 (10.8%)
Diagnosis			
Muscular dystrophy	117 (51.8%)	64 (56.6%)	53 (46.9%)
Spinal muscular atrophy	39 (17.3%)	17 (15%)	22 (19.5%)
Neuropathy	24 (10.6%)	8 (7.1%)	16 (14.2%)
Myasthenia gravis	5 (2.2%)	2 (1.8%)	3 (2.7%)
Amyotrophic lateral sclerosis	7 (3.1%)	4 (3.5%)	3 (2.7%)
Friedreich's ataxia	7 (3.1%)	4 (3.5%)	3 (2.7%)
Other	25 (12.0%)	14 (12.4%)	13 (11.5%)

Procedure and data analysis

All subjects completed a questionnaire after the programme was finished. The questionnaire was made up of 32 questions, which referred to the general characteristics of socioeconomic status, their health status, swimming behaviour characteristics and their ability to swim. Data were analysed with SPSS RAW Statistics 20.0, using the method of frequencies distribution and the t-test for differences between groups.

Results

For the purpose of evaluation swimming activities among other rehabilitation techniques, we compared different rehabilitation approaches and classified them by their swimming abilities. The results show that people with better swimming abilities (swimming under water, fear of swimming in deep water and head diving) evaluate swimming activities as statistically significantly lower (Table 2).

Table 2: Evaluation of different rehabilitation techniques ($M \pm SE$)

	All	Swimming under water		Fear of swimming in deep water		Head diving	
		Yes 73.1%	No 26.9%	Yes 51.0%	No 49.0%	Yes 49.3%	No 50.7%
Individual exercises in physiotherapy	2.8 ± 0.10	2.7 ± 0.12	2.9 ± 0.21	2.9 ± 0.16	2.8 ± 0.15	2.9 ± 0.16	2.7 ± 0.14
Therapeutic massage	2.9 ± 0.09	2.9 ± 0.10	3.0 ± 0.17	2.9 ± 0.13	3.0 ± 0.13	2.9 ± 0.13	3.0 ± 0.12
Hydrotherapy	3.4 ± 0.11	3.5 ± 0.13	3.0 ± 0.18 *	3.7 ± 0.16	3.0 ± 0.14 ***	3.7 ± 0.16	3.0 ± 0.14 **
Breathing exercises	3.5 ± 0.10	3.3 ± 0.11	4.0 ± 0.19 **	3.3 ± 0.14	3.7 ± 0.14	3.2 ± 0.14	3.7 ± 0.14 *
Group exercises in physiotherapy	4.0 ± 0.10	4.1 ± 0.12	3.8 ± 0.22	3.8 ± 0.15	4.0 ± 0.16	4.1 ± 0.15	3.9 ± 0.15
Electrotherapy	4.4 ± 0.09	4.5 ± 0.11	4.4 ± 0.18	4.3 ± 0.14	4.4 ± 0.13	4.3 ± 0.13	4.6 ± 0.12

* $p < 0.05$, ** $p < 0.01$, *** $p < 0.001$; mark 1 represents the most important value

Body control and the ability to move independently in water is vital important for safe and effective movement. Table 3 shows the percentage of people with muscular dystrophy who can independently move in different body positions in water.

Table 3: Independent movement in different positions in water

	Yes	No
Independent movement from supine to back position	49.3%	50.7%
Independent movement from lying on the back to sitting position	48.4%	51.6%

One half of the sample of subjects could independently move from supine to back position (49.3%) and from lying on the back to the sitting position (48.4%).

Discussion and conclusion

Hydrotherapy and swimming activities are an important part of physical activity programmes as well as for rehabilitation programmes for people with neuromuscular disorders. Inclusion in swimming activities offers a profusion of new motor as well as sensory experiences that have an influence on emotional and social health. Many research studies have demonstrated the efficacy of aquatic rehabilitation of individuals with neuromuscular disorders (Cunha, Oliveira, Labronici & Gabbai, 1996; Rosen, 1999). Findings, that people with better swimming abilities evaluate the importance of water activities as less important seems interesting for further discussion. Reasons for these findings could be in the rehabilitation approach, namely, swimming activities were organised for groups with one general aim, to swim independently. Other rehabilitation techniques offer more individual approaches and focus more on the improvement of body functions. That could be a reason that people with better swimming abilities evaluate other rehabilitation approaches as more important while individuals with worse swimming abilities evaluate swimming as more important. The first step to swimming and other forms of movement in water is to overcome the fear of new environment. Swimming requirements also include good breathing efficiency, technique and abilities. Variables as swimming under water and head diving show that breathing as a vital part of those swimming abilities should be acquired. Breathing efficiency among people with neuromuscular disorders is decreased. Efficient breathing programmes in water should be the first step to learning how to swim as well as swimming promotion. The variable fear of swimming in deep water could present the care of individuals for their safety because of their diminished body efficiency and motor abilities. As Becker (2009) explains, the most appropriate form of water exercise for people with neuromuscular disorders is one-to-one therapy, which begins with respiratory training in water. The suggested approach could offer possibilities for acquiring swimming abilities. Acquired swimming abilities are the basis for safety and efficient swimming and can also effect more frequent swimming activities. Other rehabilitation approaches can complete independent movement, which does not only impact body and motor efficiency. It strengthens and develops emotional and social well-being.

References

1. Cunha, M. C., Oliveira, A. S., Labronici, R. H., & Gabbai, A. A. (1996). Spinal muscular atrophy type II (intermediary) and III (Kugelberg-Welander). Evolution of 50 patients with physiotherapy and hydrotherapy in a swimming pool. *Arquivos De Neuro-Psiquiatria*, 54(3), 402–406.
2. Grange, R. W., & Call, J. A. (2007). Recommendations to Define Exercise Prescription for Duchenne Muscular Dystrophy. *Exercise and Sport Sciences Reviews*, 35(1), 12-17.
3. Sveen, M. L., Jeppesen, T. D., Hauerslev, S., Køber, L., Krag, T. O., & Vissing, J. (2008). Endurance training improves fitness and strength in patients with Becker muscular dystrophy. *Brain*, 131(11), 2824–2831.
4. Kilmer, D. D. (2002). Response to aerobic exercise training in humans with neuromuscular disease. *American Journal of Physical Medicine & Rehabilitation / Association of Academic Physiatrists*, 81(11 Suppl), S148–150.
5. Zupan, A. (2004). Rehabilitation programs for people with neuromuscular disorders. *Zdravniški Vestnik*, 73, Suppl. II: 47–50.
6. Rosen, H. T. (1999). *Development of an aquatic muscle test for persons with neuromuscular disorders*. Master thesis. Washington: San Jose State University.
7. Zupan, A. & Plevnik, M. (2009). *Swimming and other Forms of Aquatic Exercise for People with Neuromuscular Disorders*. Ljubljana: Muscular Dystrophy Association of Slovenia: University Rehabilitation Institute – SOČA.
8. Becker, B. E. (2009). Aquatic Therapy: Scientific Foundations and Clinical Rehabilitation Applications. *American Academy of Physical Medicine and Rehabilitation*, Vol 1, 859–872.
9. McDonald, C. M. (2002). Physical Activity, Health Impairment, and Disability in Neuromuscular Disease. *American Journal of Physical Medicine & Rehabilitation*, Vol. 81, No. 11 (Suppl).

Acknowledgements

Authors would like to thank the Muscular Dystrophy Association of Slovenia for making this inquiry possible and also all persons who participated in our study.

EFFICACY OF A PROPOSED PROGRAM FOR THE DEVELOPMENT OF BASIC MOVEMENTS TRANSITION FOR THE CHILDREN AGED 4-6 YEARS

Mousa Sarmad, Ahmed Rajua and Mohab Hamid

Abstract

The development of childhood stage the basic thing to be strong and healthy body to develop basic skills transition in the future. And this the importance of research resorted fact basic movements are the basis for the preparation of a healthy body movements based on valid and sound, and the aim of research is to identify the effectiveness of the proposed program for the development of basic movements to transition children aged 4-6 years (childhood). The subjects of the study were (40) children aged 4-6 years (childhood), they have been divided in to two groups – experimental and control, in the first group (experimental) they were practicing game by aspecial method for development of basic movements transition, consisted of two training per week for six weeks. Following the completion of the training program each subject was re-evaluated to determine change in total. The results of this study that experimental group were trained in proposed program in basic movements transition approbation more then control group in tradition way.

Key words: Efficacy, program, basic movements transition, childhood

Introduction

Childhood stage has a special nature in treating mental, psychological, social energies of children and where motor is one of life supporters for child so, he can not live without it. Brining up child and developing his basic movements transition depends on motor and through it he learns, grows and develops, therefore, it was necessary to confirm the importance of the role of motor education in the educational process and especially with childhood. During its growth and development an organism is most sensitive to the impact of various physical activities, which cause multiple changes in morphological features and improved functional – motor abilities (Neljak, 2002). Regarding the fact that natural forms of movement are less and less represented in everyday life, children should be first of all, taught to, run ,jump and leaping in the correct way i.e. they should be movement, which is possible (Breslauer and Markovic 2011). Movements which develop the child in this stage becomes important substrate for movement skills, in diverse sports activities in the future, where it becomes easy to learn any skill (Rateb, 1990). The basic movements transition in childhood stage working to develop the movements of the child and delivers to performance perfect for basic movements (Darwish, 1999).

The importance of research in the launch of a new form of motor programs and activities and follow the latest methods for the development basic movements transition skills of children by employing basic movements of the child in the form of practical. Researchers have noted the problem appear in the lack of interest in training programs and mobility for children, which explains through a few of these programs and their vulnerability in keeping pace with the development and scientific planning for pre-school programs which will reflect negatively on the children's basic movements transition.

Methods

The aim of our study was to investigate the effectiveness of program for the development of basic movements transition for the children aged 4-6 years (mean age = 5.1 years) on the sample of the (40) child. The research was conducted in December 2013. The sample of the subjects was divided in two Groups experimental (20 child) and control group (20 child). Control group participated in the physical education classes (2 x 45 min a week), and experimental group used the proposed program (program for the development of basic movements transition) (2 x 45 min a week). To establish basic motor dimensions, 4 standard tests were used (Running 20m test), (One leg hop test), (jumping test), (Leaping test) (Khyon, Y. 2007).

Results

Table 1 shows Descriptive Statistics (M – Mean, SD – standard deviation, d – differences between final and initial and t – test – calculate t value) for Experimental group

Table 1

Variables	Experimental Group					
	Initial		final		D	T
	M	SD	M	SD		
Running 20m	17.45	1.84	8.7	1.174	-8.75	15.59
One leg hop	1.05	0.826	7.7	0.801	6.65	22.72
Jumping	1.9	0.852	8.45	0.999	6.55	19.95
Leaping	1.85	0.813	6.85	1.089	5.0	17.23

In the table (1) in experimental group, improvement in all measured variables is observable, in the test running 20 m there is a significant difference (-8.75) between initial and final for the interest of final selection, also in the other tests (one leg hop, jumping and leaping).

Table (2) shows Descriptive Statistics (M – Mean, SD – Standard deviation, d – differences between final and initial and t – test – calculate t value) for Control group.

Table 2

Variables	Control Group					
	Initial		Final		D	T
	M	SD	M	SD		
Running	17.7	1.75	15.05	1.638	-2.65	9.67
One leg hop	1.25	1.118	4.15	1.089	2.9	8.54
Jumping	1.95	1.05	4.25	0.851	2.3	8.16
Leaping	1.8	1.152	2.95	0.887	1.15	4.52

In the table (2) in control group, revealed no significant differences in the control group between the initial and final measurement.

Table 3

VAR	Diff	T	P (t)
20 m Running	-6.35	14.09	100.0
One leg hop	3.55	11.74	100.0
Jumping	4.2	14.32	100.0
Leaping	3.9	12.41	100.0

Table (3) results of T-test analysis for final measurement between experimental and control groups.

The results of t - test analysis for final measurement between experimental and control groups of basic movements transition test the following can be established; in the running 20m, one leg hop, jumping, leaping there is significant difference in results among from this research for experimental group in the final test.

Discussion

The researchers found several results, including the presence of significant differences between the results of the tests before and after the experimental group in the development of basic movements transition for the children aged 4-6 years.

The researchers also recommended the need for attention to physical education programs for children through evolution and modern software to its importance in educating young people sound physical education.

References

1. Darwish, Hoda (1999). Effect of locomotor activity organizer on some basic movements, Alexandria University.
2. Khyon, Yarub and Fadel, Adil (2007). Motor Development and Evaluation. Collage of Sport, Baghdad University.
3. Neljak, B. (2002). Validacija planova i program a nastave tjelesne i zdravstvene kulture. (Unpublished doctoral dissertation, University of Zagreb). Zagreb: Faculty of Kinesiology, University of Zagreb.
4. Nevenka Breslauer¹ and Kamenka Živčić Marković (2011). Changes in motor abilities of the fifth grade pupils due to a one-year modified physical education programme. ¹Medimurje University of Applied Sciences in Čakovec, Croatia Faculty of Kinesiology, University of Zagreb, Croatia.
5. Rateb, Osama Kamel, Motor development, Dar alfaker Alarebi, Cairo, 1990.

SPECIFIC EFFECTS OF STRENGTH TRAINING ON DYNAMIC BALANCE

Tatjana Trošt Bobić¹, Dubravka Ciliga¹ and Iris Zavoreo²

¹Faculty of Kinesiology, University of Zagreb, Croatia

²University Department of Neurology, University Hospital Center Sestre milosrdnice, Zagreb, Croatia

Abstract

Evidence suggests that strength training performed in a ballistic mode may lead to the development of dynamic balance. The aim of this study was to determine the effects of lower leg ballistic strength training on the capacity of maintaining balance in dynamic conditions. Twenty-four healthy Physical education students (mean \pm SD age 23.1 \pm 1.7 years), with no history of neurological diseases or major orthopaedic lesions were included in the study. The subjects were randomly assigned to a training (n=13) or control (n=11) group. All participants underwent dynamic balance testing a week before, and a week after five weeks of unilateral ballistic ankle strength training. Dynamic balance testing consisted of balancing with one leg on a moving platform in an anterior-posterior direction. Ballistic strength training of plantar and dorsal foot flexors was performed unilaterally. Two-way analysis of covariance showed that the subjects of the experimental group significantly increased their time spent in active balancing, from initial to final measurements, compared to the control group ($p=0,001$), but did not significantly decreased the number of contacts between the platform and the floor, compared to the control group ($p=0,069$). The obtained results showed different effects of the implemented ballistic strength training on different variables measuring dynamic balance. Based on the obtained results, it may be assumed that ballistic strength training may differently influence a wide number of dynamic balance parameters. Such results show that ballistic training is likely to cause adaptations to many neural elements that are involved in the control of movement. Furthermore, strength training may affect movement execution during a single leg balance task, but this effect may not be detected with certain variables. It is therefore suggested that investigators should use more than one variable when assessing the effects of strength training on dynamic balance.

Key words: *dynamic balance, ballistic strength training, ankle joint*

Introduction

Evidence suggests that strength training performed in a ballistic mode may lead to the development of dynamic balance. Ballistic strength training of the lower extremities has been demonstrated to enhance balance performances in older adults (Raymond & Singh, 2008). Ballistic actions are characterised by high firing rates, brief contraction times and high rates of force development (Zehr & Sale, 1994) which are also typically seen in dynamic postural control tasks (Gruber et al., 2007). Therefore, ballistic training, except for developing explosive strength, is increasingly used for the development of balance (Schubert et al., 2008). Ballistic strength training and balance training may lead to very similar effects, but via different mechanisms of neuromuscular adaptations (Zehr and Sale, 1994; Behm, 1995; Bruhn, Kullman and Gollhofer, 2004; Beck et al., 2007; Taube, Gruber and Gollhofer, 2008). Balance and ballistic training may led to a series of changes in the neuromuscular function, which can be of neural or morphological nature (Falvo et al., 2010; Taube, Gruber and Gollhofer, 2008). One of the often cited evidence of neural adaptation to ballistic training is the early change in postural control while standing on one leg (Gollhofer et al., 2000). Studying the effects of ballistic training on dynamic balance seems essential to determine the potential mechanisms of neuromuscular adaptations that are in the background of dynamic postural control as well as the introduction of science-based methods of ballistic training in the field of sport, recreation and rehabilitation exercise or kinesitherapy. The aim of this study is to determine the effects of lower leg ballistic strength training on the capacity of maintaining balance in dynamic conditions.

Methods

Twenty-four healthy Physical education students (mean \pm SD age 23.1 \pm 1.7 years), with no history of neurological diseases or major orthopaedic lesions were included in the study. The subjects were randomly assigned to a training (n=13) or control (n=11) group. All participants underwent dynamic balance testing a week before, and a week after five weeks of unilateral ballistic ankle strength training. Dynamic balance testing was performed on a moving platform in an anterior-posterior direction. The subjects were asked to balance with one leg for the duration of 30s. After oral instructions, subjects tried the task once. The extracted variables were the percentage of time spent actively balancing the platform (Time) and the number of contacts between the platform and the floor (Contact). The task was performed on

both legs. Since strength training was performed on one leg (the non-preferred leg), only the results for the trained leg are presented in this paper. Ballistic strength training of plantar and dorsal foot flexors was performed unilaterally. Only the non-preferred leg was trained. The preferred leg was assessed by asking the participants to choose the leg with which they would precisely kick a ball as far as possible (Beynonn et al., 2000). Subjects of the training group performed 20 sessions (five weeks/4 times weekly) of unilateral plantar and dorsal maximal ballistic strength training of the non-preferred leg on an appositely designed dynamometer. During training subjects were encouraged to alternatively perform maximal plantar and dorsal foot flexion “as explosive and strongly as possible”, therefore stressing explosive force production. The training load progression is presented in table 1. Descriptive statistics were calculated for all variables in two sessions (Pre- and Post- training). Since dynamic balance testing included three trials the best of the three performed trials was taken in consideration for further analysis. The differences between the initial and final testing in the measured variables for the training and control group separately, was calculated by means of a paired sample t-test. The change in each of the dependent variables in the experimental group and the significance of intergroup differences was analyzed using two-way analysis of covariance (group x time) with repeated measures on one factor (time). The level of significance was set at $p < 0.05$.

Table1: Training load progression and figure of the training situation

Week	Task	N. of contractions	Duration of the contraction	N. of sets
Week 1	Plantar and dorsal foot flexion	5	3 sec	3
Week 2	Plantar and dorsal foot flexion	6	3 sec	3
Week 3	Plantar and dorsal foot flexion	5	3 sec	4
Week 4	Plantar and dorsal foot flexion	6	3 sec	4
Week 5	Plantar and dorsal foot flexion	6	3 sec	5

Results

T-test for dependent samples showed an improvement in dynamic balance in the experimental group for both the measured variables (% of time spent actively balancing the platform and the number of contacts between the platform and the floor) ($p < 0,01$) (Table 2). However, two-way analysis of covariance showed that the subjects of the experimental group significantly increased their time spent in active balancing, from initial to final measurements, compared to the control group ($p= 0,001$), but did not significantly decreased the number of contacts between the platform and the floor, compared to the control group ($p= 0,069$) (Table 3). The obtained results showed different effects of the implemented ballistic strength training on different variables measuring dynamic balance.

Table 2: Descriptive data for initial and final testing (arithmetic mean \pm standard deviation) and the results of t-test for dependent samples, for the measured variables describing dynamic balance (% of time spent actively balancing the platform and the number of contacts between the platform and the floor)

Variable	CONTROL GROUP			TRAINING GROUP		
	Initial (Arit. mean \pm SD)	Final (Arit. mean \pm SD)	Pre/post t-test (p)	Initial (Arit. mean \pm SD)	Final (Arit. mean \pm SD)	Pre/post t-test (p)
Time (%)	58,38 \pm 8,02	61,70 \pm 7,24	,047	60,73 \pm 9,92	70,88 \pm 8,65	,000
Contact (n)	18,64 \pm 5,36	17,08 \pm 10,16	,440	21,71 \pm 5,50	14,36 \pm 5,07	,000

Table 3: Changes in the measured indicators of dynamic balance (% of time spent actively balancing the platform and the number of contacts between the platform and the floor), for the experimental groups, analyzed by mean of a two-way analysis of covariance.

Variable	RANCOVA	F	P	Group	Initial (Arit. mean \pm SD)	Final (Arit. mean \pm SD)
Time (%)	Time	6,17	0,018	CONTROL	58,38 \pm 8,02	61,70 \pm 7,24
	Time*Covariation	1,52	0,226	TRAINING	60,73 \pm 9,92	70,88 \pm 8,65
	Time*Group	8,91	0,001			
Contact (n)	Time	0,64	0,429	CONTROL	18,64 \pm 5,36	17,08 \pm 10,16
	Time*Covariation	0,20	0,655	TRAINING	21,71 \pm 5,50	14,36 \pm 5,07
	Time*Group	2,89	0,069			

Discussion and conclusions

The main finding of this study is the fact that the subjects of the experimental group significantly increased their time spent in active balancing, from initial to final measurements, compared to the control group, but did not significantly decrease the number of contacts between the platform and the floor, compared to the control group. The obtained results showed different effects of the implemented ballistic strength training on different variables measuring dynamic balance. It may be assumed that the subjects of the experimental groups spent more time actively balancing the platform after the training period, because the contacts between the platform and the floor were shorter than those registered in the initial testing protocol. However, since the duration of each contact, as well as the overall duration of the contacts between the platform and the floor was not measured, this assumption may not be confirmed by data. Based on the obtained results, it may be assumed that ballistic strength training may differently influence a wide number of neuromuscular mechanisms supporting the capacity of maintaining balance in dynamic conditions. It may therefore diversely affect different dynamic balance parameters. Ballistic actions are characterised by high firing rates, brief contraction times and high rates of force development (Zehr & Sale, 1994) which are also typically seen in dynamic postural control tasks (Gruber et al., 2007). The measured improvement in dynamic balance performance found after ballistic ankle strength training is in line with previous knowledge. Ballistic strength training of the lower extremities has been demonstrated to enhance balance performances in older adults as well as in athletes (Raymond & Singh, 2008; Schubert i sur., 2008). However, previous data about balance performance improvement as a consequence of strength training has been contradictory (Raymond & Singh, 2008; Gruber et al., 2007). One possible reason for contradictory result is the wide range of different types of training used in previous investigations (i.e. isometric strength training, eccentric isokinetic training or ballistic strength training) (Orr et al. 2008; Raymond & Singh, 2008). However, such discrepancies may indicate that a number of neuromuscular adaptations interact to determine the nature of transfer from resistance training to functional movements. Ballistic actions are present in everyday tasks and they cause numerous specific neuromuscular adaptations that may be linked with dynamic postural control (Caroll, Riek & Carson, 2001). For example, antagonist co-contraction increase with movement speed and this seems to be a function of movement strategy. In line with that, increase in joint angular velocity, as in ballistic movements, causes a marked increase in the electromyographic (EMG) activity of antagonist muscles acting at the joint (Zehr and Sale, 1994). The functional significance of this observed antagonist co activation during ballistic movements may be to prevent injury and maintain joint integrity, thus balance. Those may be the reasons why the implemented ballistic ankle strength training improved the capacity of maintaining balance on a moving in dynamic conditions. In conclusion, the found dynamic balance enhancement after ballistic strength training is probably due to the similarity of the neurophysiologic mechanisms that sub serve ballistic movement and balance performance. However, the obtained results showed different effects of the implemented ballistic strength training on different variables measuring dynamic balance. Ballistic training is likely to cause adaptations to many neural elements that are involved in the control of movement. Furthermore, strength training may affect movement execution during a single leg balance task, but this effect may not be detected with certain variables. It is therefore suggested that investigators should use more than one variable when assessing the effects of strength training on dynamic balance.

References

1. Beynon, B.D., Helie, B.V., Alosa, D.M., Renstrom, P.A. (2000). The benefit of a single-leg strength training program for the muscles around the untrained ankle. *American Journal of Sports Medicine*, 28(4), 568-573.
2. Gruber, M., Taube, W., Gollhofer, A., Beck, S., Amtage, F., Schulbert, M. (2007). Training-specific adaptations of H- and stretch reflexes in humans soleus muscle. *Journal of Motor Behaviuor*, 39(1), 68-78.
3. Raymond, O.R. & Singh, F.M. (2008). Efficacy of progressive resistance training on balance performance in older adults: a systematic review of randomized controlled trials. *Sports Medicine*, 38(4), 317-343.
4. Caroll, T.J., Riek, S. & Carson, R.G. (2001). Neural adaptations to resistance training. Implications for movement control. *Sports Medicine*, 31(12), 829-840.
5. Schubert, M., Beck, S., Taube, W., Amtage, F., Faist, M., Gruber, M. (2008). Balance training and ballistic strength training are associated with task-specific corticospinal adaptations. *European Journal of Neuroscience*, 27, 2007-2018.
6. Beck, S., Taube, W., Gruber, M., Amtage, F., Gollhofer, A., Schubert, M. (2007). Task-specific change in motor evoked potentials of lower limb muscles after different training interventions. *Brain Research*, 1179, 51-60.
7. Bruhn, S., Kullmann, N., & Gollhofer, A. (2004). The effects of a sensorimotor training and a strength training on postural stabilisation, maximum isometric contraction and jump performance. *International Journal of Sports Medicine*, 25(1), 56-60.
8. Falvo, M. J., Sirevaag, E. J., Rohrbaugh, J. W., & Earhart, G. M. (2010). Resistance training induces supraspinal adaptations: Evidence from movement-related cortical potentials. *European Journal of Applied Physiology*, 109(5), 923-933.
9. Taube, W., Gruber, M., Beck, S., Faist, M., Gollhofer, A., Schubert, M. (2007). Cortical and spinal adaptations induced by balance training: correlation between stance stability and corticospinal activation. *Acta Physiologica*, 189, 347-358.

EFFECT OF KINESIO TAPE APPLICATION ON TRUNK ISOMETRIC STRENGTH

Matej Voglar¹ and Nejc Šarabon²

¹Science and Research Centre Koper, Institute for Kinesiology Research, University of Primorska, Slovenia

²Science and Research Centre Koper, Institute for Kinesiology Research, University of Primorska, Slovenia; 1 -S2P Ltd., Laboratory for Motor Control and Motor Behaviour, Slovenia

Abstract

It has been shown that Kinesio Taping might have some small clinically important beneficial effects on range of motion and strength but the results are not conclusive and the exact mechanisms by which it would achieve expected results have not been fully elucidated. Therefore the aim of this study was to test if Kinesio Taping influences maximal isometric strength of the trunk. Twelve healthy young participants were recruited for the crossover, placebo controlled study. In the experimental condition the tape was applied over the paravertebral muscles and placebo condition was sham application of the tape transversally over the lumbar region. Participants performed three repetitions of maximal isometric exertions in the direction of trunk extension, trunk flexion and trunk lateral flexion before and one hour after Kinesio Taping and placebo application. Results showed no statistically significant effects of tape application on maximal isometric strength in any of the measured voluntary actions. There was no difference between Kinesio Taping and placebo condition and no significant interactions either. We can conclude that application of Kinesio Taping over lumbar region does not seem to affect the isometric strength of the trunk in young healthy population. In the future, additional studies in low back pain patients would be encouraged.

Key words: taping, physical therapy, muscle performance, low back

Introduction

Muscle strength is a key component of sport performance and one of the main goals in rehabilitation. In order to improve performance in sport or rehabilitation several intervention techniques have been applied. For example, cutaneous stimulation to enhance muscle contraction has been used but the effects of this stimulation are not long lasting with cessation of effects within 15 to 30 minutes after the treatment (Huang et al., 2011). It has been suggested that application of adhesive elastic tape might assure sufficient cutaneous stimulation with potentially longer lasting effects. Therapeutic Kinesio Taping (KT) method is in practice used for treatment of various musculo-skeletal conditions. The tape has been designed to allow for a longitudinal stretch of 55 – 60% of its resting length. This mimics the qualities of the skin and after approximately 10 minutes the client will generally not perceive there is a tape on his/her skin (Kase et al., 2003). The method was first introduced by Kenso Kase to mechanically support the movement and to enhance sensory input to mechanoreceptors. In a recent meta-analysis about effects of KT in treatment and prevention of sport injuries, Williams et al. (2012) included both studies on patients and on healthy population. They concluded that KT might have some small clinically important beneficial effects on range of motion and strength but most likely only trivial effects on pain perception. On the contrary, recent review by Kalron and Bar-Sela (2013) concluded that there is not enough evidence connecting application of KT and improvement of strength, therefore further research is needed.

The mechanisms by which KT would achieve expected results have not been fully elucidated. According to the founder of the KT the tape can be applied in two conceptually different ways as regards to the direction of the application and the amount of the stretch of the tape during its application. This way, KT is thought to facilitate or inhibit muscle function via cutaneous stimulation. To facilitate muscle function the tape should be applied with moderate (25–50% of the available) tension in the direction from origin to insertion and to inhibit muscle function the tape is applied in the opposite direction with very light (15-25% of the available) tension (Kase et al., 2003).

Some previous studies showed that application of KT can improve grip strength and knee extensors' power (Williams et al., 2012). Application of KT over lumbar region have the potential to improve trunk extensors endurance (Castro-Sanchez et al., 2012) but the effects on trunk strength have not been reported. Therefore the aim of this study was to investigate the effects of KT application on maximal isometric strength of trunk muscles. We hypothesized that application of KT will improve isometric trunk strength in the direction of muscle extension but will have no effect on trunk flexion and lateral flexion.

Methods

In the present study 12 active University students were recruited (4 female and 8 male, [Mean \pm Standard Deviation] 23.4 ± 3.5 years, 180.6 ± 8.5 cm and 74.8 ± 13.1 kg). Participants were healthy individuals and had no history of low back pain in the last 6 months. They also had no known neurological disorders or sensory deficits. Measurements were performed in a randomized, placebo controlled cross-over study design. The participants underwent two study conditions, namely KT and PL condition. The participants were blinded of KT or PT condition and were randomized into KT or PT condition in a counterbalanced order. After explaining the purpose and potential risks of the study, a written informed consent was obtained. The study was approved by the National Medical Ethics Committee.

In the KT condition three "I" stripes of elastic tape (Darco International, Inc., Huntington, USA) were placed in parallel with the goal of muscle facilitation. One stripe was placed from the line between left and right posterior superior iliac spine to processus spinosus of 12th thoracic vertebrae in a neutral standing position.

This distance was first measured and then reduced by 25% to determine the resting length of the tape and consequently get near to 50% of the available 50-60% stretch of the tape when applied. On both ends 3 to 5 cm of the "I" stripe was applied without tension. The other two stripes were placed 4 cm laterally from the first stripe with the same length and tension (Fig. 1 A). In PT condition a single 20 cm "I" stripe with no tension was placed transversely at level of the 3rd lumbar vertebrae (Fig. 1 B). Participants were naive about the KT method and it was explained that they are receiving two types of therapeutic taping applications. All taping was applied by a single person trained in KT method.

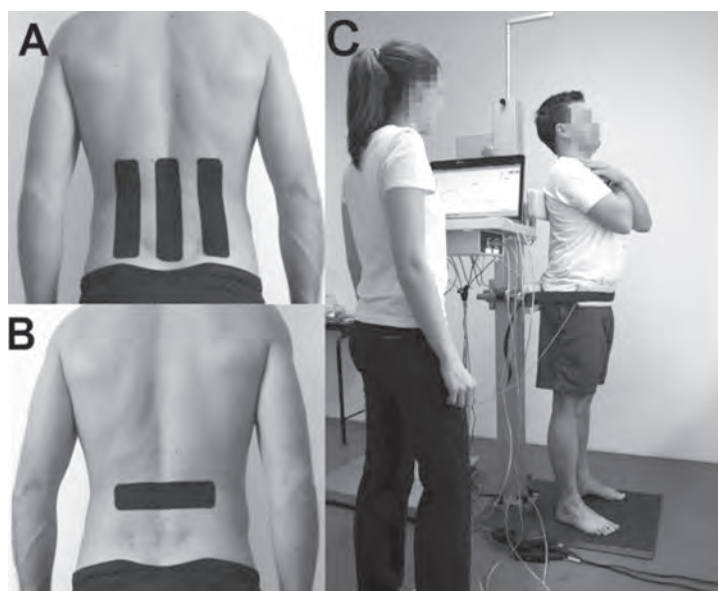

Figure 1: Kinesio tape (a) and placebo (B) application was placed over lumbar region. In both conditions maximal isometric strength was measured (C).

Participants performed three repetitions of maximal isometric exertions in the direction of trunk extension, trunk flexion and trunk lateral flexion before and one hour after KT and PL application (Fig 1. C). Measurements were performed in standing position. To measure trunk extension strength the participant was fixated with the padded belt over the anterior superior iliac spine. The force sensor (PW10AC3 200 kg, HBM, Nemčija) was placed behind the padded support at the height of the participant's shoulder blades, just below the spinae scapulae. To measure trunk flexion the participant was facing the padded support that remained at the same height as for extension measurement. The fixation belt was placed over the spina iliaca posterior superior. For both side flexion measurements participant was turned sideways touching the padded support with the shoulder and pelvis fixation just above the trochanter major. The best result out of three repetitions was used in further analysis.

SPSS 18.0 (SPSS Inc., Chicago, USA) was used for statistical analyses. Descriptive statistics were calculated for all variables and reported as mean (\pm standard errors). Kolmogorov-Smirnov test showed normal distribution of the data. Two way repeated measures analysis of variance (ANOVA) was used with repeated measures on condition (PT and KT) and on time (pre application and post application) (condition (2) X tape application (2)). The level of statistical significance was set at $p < 0.05$.

Results

All recruited participants ($n = 12$) completed the study. For both the KT and PL condition there was no significant difference in baseline measurements. We found no statistically significant effects of tape application on maximal isometric strength in direction of trunk extension ($F(1,11) = 1.672$, $p = 0.22$, $\eta^2 = 0.132$), trunk flexion ($F(1,11) = 0.02$, $p = 0.90$, $\eta^2 = 0.001$), right lateral flexion ($F(1,11) = 0.09$, $p = 0.77$, $\eta^2 = 0.008$) or left lateral flexion ($F(1,11) = 0.07$, $p = 0.796$, $\eta^2 = 0.006$). There were also no differences between KT and PL condition ($F(1,11) < 1.89$, $p > 0.20$, $\eta^2 < 0.15$) and no significant interactions ($F(1,11) < 1.81$, $p > 0.21$, $\eta^2 < 0.14$) in any of the measured directions (Fig. 2).

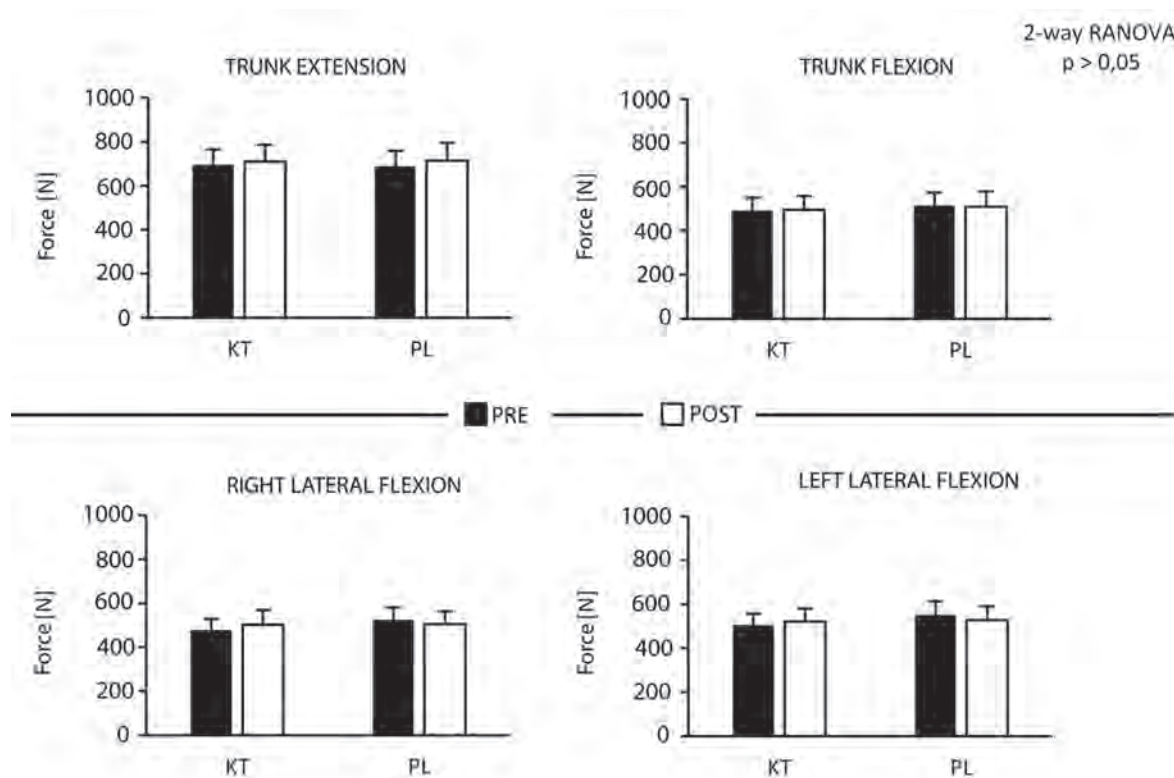

Figure 2: Results of isometric strength measurements in the direction of trunk extension, flexion, right lateral flexion and left lateral flexion; before (PRE) and one hour after (POST) tape (Kinesio (KT) and placebo (PL)) application.

Discussion

The aim of this study was to investigate the effects of KT application on trunk maximal isometric strength in young healthy participants. In contrast to hypothesis the taping application did not affect isometric strength in any of the measured voluntary muscle actions in young healthy population. There were also no differences between KT and PL application.

Results are in contrast with previous 5 out of 6 studies included in the meta-analysis by Williams et al. (2012) that have shown significant changes in strength. Most of the researches included in this review were performed on upper extremities, evaluating grip strength in healthy population and in participants with shoulder impingement syndrome. Two studies were analyzing leg strength, showing potentially beneficial effects on quadriceps eccentric and concentric muscle strength. Both studies presenting positive effects on quadriceps strength were evaluating strength in dynamic, isokinetic conditions. In the present study, strength was measured in static conditions which could potentially result in the absence effect of KT on skin proprioceptors and potentially insufficient input for changes in force producing capacity.

KT is hypothesized to improve muscle strength by producing pull on the fascia, which may stimulate increased muscle contraction or by improved muscle activation and better muscle alignment (Williams et al., 2012). In contrast with taping of forearm where some changes in muscle alignment would be possible it is not expected in taping application used in this study. The placing used in this study followed recommendations from Kase et al. (2003) and was also used in a previous study on low back pain by Paoloni et al. (2011). In general there is also little agreement in KT placing between different studies (Kalron and Bar-Sela 2013) which might be one of the reasons for inconclusive results of previous studies.

The present study is, to our knowledge, the first to investigate the effects of KT on maximal strength of trunk muscles. Previous study of KT application over lumbar region from Castro-Sanchez et al. (2012) noted improved functional scores on Roland-Morris functional scale and Oswestry score after one week of tape in situ. After treatment with KT application for one week they also found reduction in pain and improved trunk muscle endurance. Both pain reduction and better

muscle endurance at 4 week follow up remained significantly different when compared to the control group. Similarly, Paoloni et al. (2011) investigated effects of KT application and exercise program on low back pain. He found similar reduction of pain in exercise group and in KT application group. Further, only exercise group reported improvements in Roland-Morris scores but KT group have shown no improvements which is in contrast with findings from Castro-Sanchez et al. (2012). In the present study participants were pain free. We assume that, some potential strength improvement might be expected in low back pain patients. Reduced strength is often seen in low back pain population which might, among other, result from changed sensory input. In this population alleviation of pain from KT application shown in previous studies (Castro-Sanchez et al., 2012, Paoloni et al., 2011, Williams et al., 2012) might have some indirect effects on maximal force production capacity.

There are some limitations of this study. The effect of KT were measured 1 hour after the application, therefore we might miss out potential immediate effects of KT. On the other hand if the effects would not last for an hour its clinical and practical value would be questionable. A small sample size is another limitation of the present study that was partially mitigated by the use of repeated measures design. Only active young healthy participants were recruited in present study therefor the results cannot be extrapolated on elderly, inactive population or persons with back pathology. Therefore further research is needed to investigate effects of KT in these specific populations.

Conclusions

Application of KT over lumbar region does not improve isometric strength of trunk muscles in young healthy population and therefore no performance improvements would be expected. Future research in population with reduced trunk strength due to pathology or inactivity would further disclose the eligibility of KT use in rehabilitation.

References

1. Castro-Sanchez AM, Lara-Palomo IC, Mataran-Penarrocha GA, Fernandez-Sanchez M, Sanchez-Labraca N, Arroyo-Morales M (2012) Kinesio Taping reduces disability and pain slightly in chronic non-specific low back pain: a randomised trial. *J Physiother* 58: 89-95.
2. Huang CY, Hsieh TH, Lu SC, Su FC (2011) Effect of the Kinesio tape to muscle activity and vertical jump performance in healthy inactive people. *Biomed Eng Online* 10: 70.
3. Kalron A, Bar-Sela S (2013) A systematic review of the effectiveness of Kinesio Taping--fact or fashion? *Eur J Phys Rehabil Med* 49: 699-709.
4. Kase K, Wallis J, Kase T, Association KT (2003) *Clinical Therapeutic Applications of the Kinesio Taping Methods* edn). Kinesio Taping Assoc.
5. Paoloni M, Bernetti A, Fratocchi G, Mangone M, Parrinello L, Del Pilar Cooper M, Sesto L, Di Sante L, Santilli V (2011) Kinesio Taping applied to lumbar muscles influences clinical and electromyographic characteristics in chronic low back pain patients. *Eur J Phys Rehabil Med* 47: 237-244.
6. Williams S, Whatman C, Hume PA, Sheerin K (2012) Kinesio taping in treatment and prevention of sports injuries: a meta-analysis of the evidence for its effectiveness. *Sports Med* 42: 153-164.

Acknowledgements

This study was carried out in the framework of the project "Evaluation of neuro-muscular trunk stabilization functions and development of exercise programs for lower back pain prevention (grant no. L5—4293)" funded by Slovenian Research Agency. We would like to thank to Matej Kleva for his assistance in data collection.

EVALUATION OF CONVENTIONAL CEREBROVASCULAR RISK FACTORS IN POPULATION OF KINESITHERAPY STUDENTS

Iris Zavoreo¹, Branimir Filipović², Goran Bobić² and Vanja Bašić Kes¹

¹University Department of Neurology, University Hospital Center Sestre milosrdnice, Croatia

²Faculty of Kinesiology, University of Zagreb, doctoral studies, Croatia

Abstract

Cerebrovascular disease is the third most frequent cause of death worldwide and the most frequent cause of permanent disability. Modification of lifestyle and risk factors treatment in the world has led to the reduction of cerebrovascular disease incidence and mortality of stroke. The economic burden is tremendous as well as influence on private and social life, since many stroke survivors require chronic care and long-term institutionalization. Cerebrovascular disease prevention begins with recognition of its risk factors as soon as possible, even in young, at first site healthy population, because most of people have multiple cerebrovascular disease risk factors which are unrecognized for a long period of time. Therefore it is of great importance to recognize all of the cerebrovascular disease risk factors and to educate population how to control them.

Key words: *cerebrovascular disease, modifiable risk factors, non modifiable risk factors, life style*

Introduction

Cerebrovascular disease risk factors have been classified as traditional and novel (hyperhomocysteinemia, hypercoagulable states, and select biomarkers), and modifiable and non modifiable. Non modifiable risk factors are: age, gender, race/ethnic, genotype, previous myocardial infarction, TIA or stroke and modifiable risk factors are: diabetes, hyperlipidemia, arterial hypertension, atrial fibrillation, coronary and or peripheral artery disease, obesity, physical inactivity, stress, alcohol consumption, and smoking (Whisnant JP. 1997)

Atherosclerosis is a central pathomorphological mechanism which leads to narrowing of arterial walls throughout the body as well in brain causing cerebrovascular disease. Atherosclerosis is thought to be result from chronic inflammation and injury to the arterial wall in the peripheral or coronary vascular system. In response to endothelial injury and inflammation, oxidized lipids from LDL (low density lipoproteins) particles accumulate in the endothelial part of the vessel wall. Angiotensin II may promote the oxidation of such particles. Monocyte than infiltrate the arterial wall and differentiate into macrophages, which accumulate oxidized lipids to form foam cells. Once formed, foam cells stimulate macrophage proliferation and attraction of T-lymphocytes. T-lymphocytes in turn, induce smooth muscle proliferation in the arterial walls and collagen accumulation. The net result of the process is the formation of a lipid-rich atherosclerotic lesion with a fibrous cap. Rupture of this lesion leads to acute vascular infarction, this ruptures and bleeding into the plaque are more frequent in diabetic patients (diabetic patients have higher perioperative risk for carotid endarterectomy as well). In addition to atheroma formation, there is a strong evidence of increased platelet adhesion, hypercoagulability, impaired nitric oxide generation and increased free radical formation as well as altered calcium regulation in diabetic patients (Sacco RL. 1998)

Hypertension is the most prevalent modifiable risk factor for stroke with a prevalence of about 30% in modern western countries. The prevalence of hypertension increases with age, The Framingham Heart Study investigators reported the lifetime risk of hypertension to be approximately 90% for men and women who were non-hypertensive at age 55 or 65 years and survived to ages 80–85 years old. A meta-analysis of one million adults enrolled in 6 observational studies concluded that death from ischemic heart disease and stroke increases. Progressively and linearly with systolic blood pressure levels as low as 115 mm Hg and diastolic 75 mm Hg upward. This study also found that for every 20 mm Hg systolic or 10 mm Hg diastolic increase in blood pressure there is a doubling of mortality from both ischemic heart disease and stroke. The authors suggest a 10 mm Hg reduction in systolic or a 5 mm Hg reduction in diastolic blood pressure would result in a 40% lower risk of stroke death and a 30% lower risk of death from ischemic heart disease or other vascular death.

Several large randomized trials of statins have demonstrated reduction of stroke risk associated with lowering lipid levels. However, observational prospective studies have not found a consistent relation between cholesterol levels and incidence of stroke. When evaluating pathomorphological mechanisms of atherosclerosis, the beneficial effects of statins on stroke risk reduction may be mediated by additional mechanisms of action such as improvement of endothelial function (regulation of heart function, blood pressure, and hyperglycemia), antioxidant properties, inhibition of inflammatory

responses, immunomodulatory actions, and stabilization of atherosclerotic lesions. Although the agent used, and the dose has varied across studies, the results have been consistent, showing stroke relative risk reduction ranging approximately from 10 to 50%. (Whisnant JP. 1996)

Diabetes is chronic illness that requires continual medical care and patient self management education in order to prevent acute complications and to reduce the risk of long-term complications. Of patients who suffered stroke, a large proportion either has or is later diagnosed with diabetes (16-24%). Patients with diabetes are at 1.5-3 times the risk of stroke compared with general population and associated mortality and morbidity is greater than in those without this underlying condition. Even patients with metabolic syndrome component have a 1.5 fold increased risk of stroke. This is primarily due to increased proatherogenic risk factors-abnormal plasma lipid profiles, hypertension, hyperglycemia. However, other pathological features associated with diabetes, such as insulin resistance and hyperinsulinemia, also lead to atherosclerotic changes in extracranial and intracranial vessels independently of glycemia or other attendant risk factors. This is particularly expressed in smaller cerebral vessels increasing the incidence of both- overt and silent lacunar infarctions.

Mainstay of the mental health is the control of the conventional cerebrovascular risk factors, practice of physical activity, and healthy nutrition, stress management and mental stimulation. Stress management is important, because stress has shown cytotoxic properties. Prolonged stress damages the hippocampus which is engaged in memory and learning. We must learn how to cope stress with daily relaxation techniques, a personal exercise program, pertinent life style changes, a healthy diet, good sleep and appropriate nutritional habits. (Kiely DK. 1993)

Physical activity is of great importance because it activates all of the regulatory mechanism of glucose and lipid metabolism, as well as better function of systemic and cerebral circulation with better free radicals elimination. Also with its central mechanisms (endofines and brain derived neurotrophic factor production increase) it enhance mental state of the individual, rise positive emotions as well as improves heart and skeletal muscles metabolism.

Mediterranean diet with reduction of saturated fats and polysaharides, full of polyunsaturated fats (fish) as well as fruits and vegetables full of antioxidants should be a part of cerebrovascular disease prevention. (Demarin V. 2006)

In order of better and faster evaluation of stroke risk factors the Framingham Stroke Risk Profile (FSRP) was developed. Authors of the FSRP were using data from 36 years follow up in the Framingham cohort and has been validated in other cohorts. The FSRP provides sex specific estimation of the probability of stroke using clinical information. (Kiely DK. 1993)

According to these results University Department of Neurology Stroke prevention unit UHC Sestre milosrdnice has developed general questionnaire for evaluation of cerebrovascular disease stroke factors evaluation and stroke risk estimation.

In young population, especially professionals who will be involved in different kind of physical activities (preventive or curative) after leaving Faculty, there should be high level of awareness about cerebrovascular risk factors and how to modify them.

Methods

We included in the study 77 students volunteers (45 men and 32 women) of the 10th semester Faculty of Kinesiology (modul Kinesitherapy) University in Zagreb. We evaluated cerebrovascular disease risk factors according to the standardized questionnaire for general population. Risk factors were evaluated separately and at presented as sum at the end of a questionnaire. Questionnaire is divided into two sections- non modifiable risk factors-age, sex, family history and modifiable risk factors- body weight, blood pressure, increased lipids in serum, increased glucose in serum and/or diabetes mellitus in family, atrial fibrillation, alcohol consumption, smoking, physical activity, stress. Individual results were compared with standardized categories: 6-15 low risk, 16-21 good result but correction of cerebrovascular risk factors and follow up is needed, 22-29 obligatory good physical exam and laboratory work up according to protocol for cerebrovascular disease, 30-39 increased risk, 40-50 high risk, >51 very high risk- last 3 categories should perform all laboratory work up for cerebrovascular disease as soon as possible and should be followed up regularly. Student test will be applied for evaluateing different groups. Statistical significance was set for P value <0,05.

Results

All students had score less than 21. In the group 0-15 were 67 students, while in the group 16-21 were 10 students. Number of students according to individual CV risk is presented in table 1. Most of the students have low risk and are in the group 0-15 points mostly with result from 3-10 points, there is also in these group decreasing trend of student number with increase of the CV risk total value. There is a minority of students in the group 16-21 points with also decreasing trend of student number with increase of the CV risk total value.

Table 1: Number of students for each CV risk estimation value

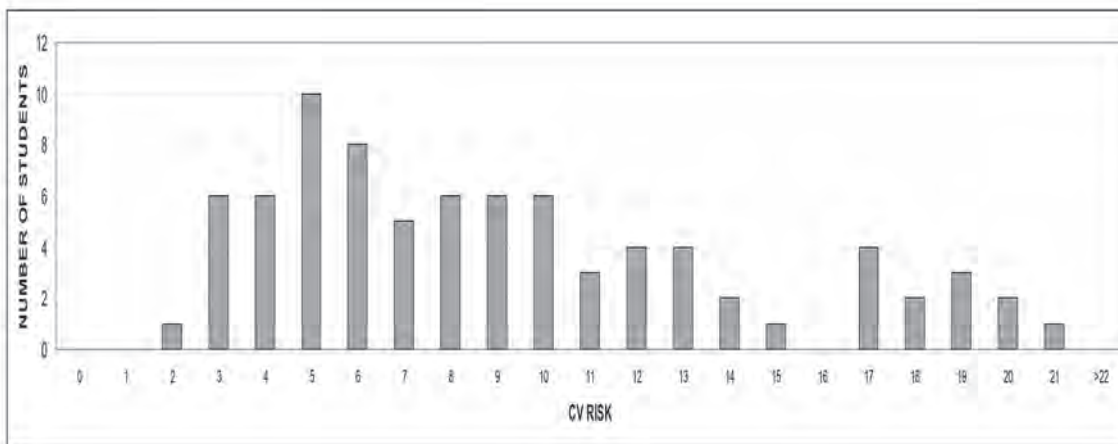

In table 2. are presented total value for each category, average for each CV risk estimation result as well as standard deviation. For each category student were very low at risk estimation level for modifiable and non modifiable risk factors, but some of the modifiable risk factors are higher than it should be expected- lipid and glucose serum levels as well as other life style habits- smoking, alcohol as well as stress and lower level of physical activity during attending lectures (in these groups is also high standard deviation shoving high variability in results for each group).

Table 2: Presentation of total value, average and standard deviation for each modifiable and non modifiable risk factor in the questionnaire

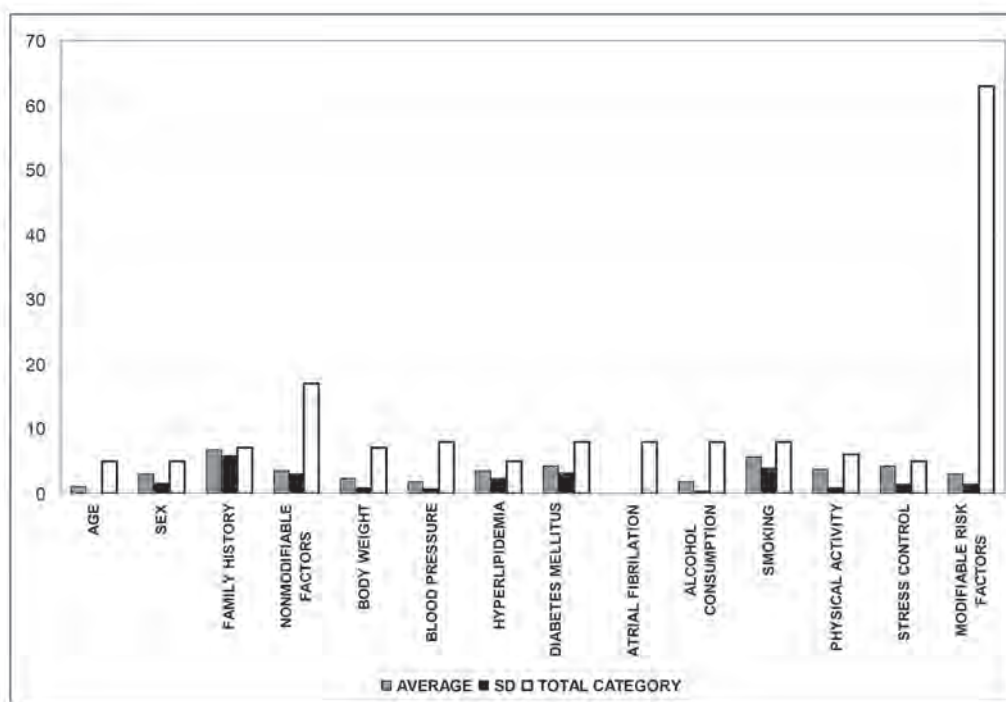

Discussion

Results of our study have shown that students who were evaluated have high level of awareness about healthy life style and results have shown that they have low level of modifiable as well as nonmodifiable cerebrovascular disease risk factors. There was no statistically signifacnt difference all cerebrovascular risk factor between different men and women, only sex was individual cerebrovascular risk factor for increase of stroke in men (according to large clinical studies published before) and therefore it was not specially important in our study. Family history was one of the most important nonmodifiable CV risk factors therefore it is of great importance to evaluate personal anamnesis even in young people, at first sight healthy people, because some data from anamnesis such as cerebrovascular disease or diabetes

mellitus are multiplying CV risk. Students often have no time for proper diet during the day full of lectures at different sites, and most of them are consumers in public restaurants and therefore their diet is not regular as well as balanced. In our interview with students after CV risk factor estimation we found out that these are the main reasons of increased lipids and sugar values which were not expected in this population. Also watching TV and tendency to sedentary way of life, alcohol consumption and smoking are bad life style habits of modern societies and these habits are present also in our evaluated population. We can conclude that our evaluated population in general has low CV risk values, especially modifiable risk factors which can be modify more with consecutive CV risk further decrease. Further actions should be at general improvement of meals served in public restaurants. Previously mentioned bad life style habits are present only in minority of students and with minimal effort they can correct them and minimize their CV risk. In conclusion we have students with low CV risk scores and with high level of conscience about healthy life style and prevention of CV disease in their cases, as well possibility to counsel others how to improve their life styles and prevent CV disease.

References

1. Demarin V, Lovrenčić-Huzjan A, Trkanjec Z et al. (2006) Recommendations for Stroke Management-update. *Acta Clin Croat* 45:219-285.
2. Kiely DK, Wolf PA, Cupples LA, Beiser AS, Myers RH. (1993) Familial aggregation of stroke. The Framingham Study. *Stroke* 24(9): 1,366–1,371.
3. Sacco RL, Boden-Albala B, Gan R. (1998) Stroke incidence among white, black, and Hispanic residents of an urban community: the Northern Manhattan Stroke Study. *Am J Epidemiol* 147(3): 259–268.
4. Whisnant JP, Wiebers DO, O'Fallon WM, Sicks JD, Frye RL. (1996) A population-based model of risk factors for ischemic stroke: Rochester, Minnesota. *Neurology* 47(6):1,420–1,428.
5. Whisnant JP. (1997) Modeling of risk factors for ischemic stroke. *The Willis Lecture Stroke* 28(9):1840–1844.

CLASSIFICATION PROCESS OF ATHLETES WITH INTELLECTUAL IMPAIRMENT IN ATHLETICS: A REVIEW

Tea Čišić

Faculty of Kinesiology, University of Zagreb, Croatia

Abstract

The purpose of this paper is to review recent progress that has been done in Paralympics by re-including athletes with learning disabilities in three sports: athletics, swimming and table tennis. The focus is on a specific classification procedure used in athletics, which is viewed from interdisciplinary aspect by taking into account the needs and characteristics of athletes with intellectual impairment (II), all to provide guidelines for future development of classification process.

The International Paralympic Committee (IPC) has come up with a new battery of tests that are used to determine whether an athlete's II has an influence on his/ her performance in sport. After Sidney's cheating scandal, which caused withdrawal of athletes with II from Paralympics, much research has been done to ensure new classification system. The purpose of classification is to promote sport for people with disabilities by diminishing the effect of eligible impairment on the competition result. In order to achieve this, classification process (1) determines eligibility criteria by defining type and severity of impairment, and (2) uses methods to classify impairments towards the level of activity restriction caused by the same impairment.

Athletes now have to pass primary eligibility check that is done by International Federation for Para-Athletes with an Intellectual Disability (INAS), and Sport-specific classification done by the IPC. New classification evidence-based system that is now rigorous and comprehensive, enabled this impairment class to re-enter the London 2012 Paralympics by proving that intellectual impairment has an impact on sports performance. In athletics, three disciplines are currently present: long jump, shot put and 1500m. Sport classification consists of: (1) Sport Cognition Test battery that checks components of intellectual functioning important in sport settings, (2) Sport-specific assessment that measure the athlete's tactical abilities and (3) Observation at competition.

Although the primary goal of re-inclusion has been achieved, there is still a lot to do. Research should focus on comparing able-bodied athletes to athletes with II on a larger and international sample, with the aim of developing more reliable and standardized tests that are easily explainable and applicable. Furthermore, other sports should be included and subclasses should be considered.

Key words: *athletes with learning disabilities, Paralympic classification, INAS, sport intelligence*

DOES SINGLE TEST REFLECT TRUE PELVIS POSITION AND HELP TO DETERMINE ITS RELATIONSHIP WITH THIGH MUSCLES LENGTH?

Vilma Juodzbaliene¹, Ginas Cizauskas², Giedre Jurgelaitiene¹ and Milda Bilinauskaite²

¹Lithuanian Sports University, Lithuania

²Kaunas University of Technology, Lithuania

Imbalance of biomechanical system of the body leads to many complications, such as abnormal posture, altered spinal curves and lower cross syndrome. Accurate, reliable, safe and low cost tools are needed for musculoskeletal assessment. Visual observation provides non quantitative and sometimes controversial information about pelvis position or the lumbar lordosis size. The evidence regarding relationship between pelvis position, lumbar lordosis size and thigh muscles length found in scientific literature are controversial.

Purpose: to determine accuracy of the clinical test for the pelvis position and establish correlation between length of the thigh muscles, pelvis position and lumbar lordosis size.

Methods: 27 healthy subjects 21 to 28 years of age volunteered in the study. Subject exclusion criteria: abnormal BMI, athletes, present scoliosis, leg deformation, leg length difference greater than 1cm, neuropathy, diabetes mellitus, systemic musculoskeletal and vestibular disorders, sacroiliac joint dysfunction, injury of spine and lower extremities. Pelvis position and lumbar lordosis size of the subjects were examined visually by experienced physiotherapist, using digital photography and AutoCAD program, also movement analysis program (SIMI motion). Subjects were divided into two groups: I – individuals with neutral pelvis position, II – individuals with tilted forward pelvis position. The length of the anterior and posterior thigh muscles was measured using goniometry and clinical tests. The distribution of neutral and tilted pelvis positions determined using different tests and correlation between length of the thigh muscles, pelvis position and lumbar lordosis size were established.

Results: 40.7 percent of pelvis position was recognized as neutral and 59.3 percent as tilted forward after visual examination was performed, analogically 37 and 63 percent analyzing digital photography and AutoCAD program data, 74.1 and 25.9 percent using movement analysis program.

Conclusions: Single clinical test i.e. visual examination even performed by experienced physiotherapist not always reflects true pelvis position and may not help to make reliable clinical decision about thigh muscle length as main contributing factor for the change of pelvis position.

DESCRIPTION OF THE MAINTENANCE BALANCE AND WALKING PATIENTS WITH LESIONS OF ANTERIOR CRUCIATE LIGAMENT KNEE JOINT IN THE PREOPERATIVE PERIOD

Irina Roy, Andrey Rusanov and Olga Rusanova

*Institute of Traumatology and Orthopedics NAMS of Ukraine;
National University of Physical Education and Sport of Ukraine*

Abstract

Based on initial biomechanical characteristics of maintaining balance obtained in the course of the balancing test in patients identified violations load distribution of the lower extremities with lesions anterior cruciate ligament of the knee joint.

Key words: *anterior cruciate ligament of the knee joint, balance training, stabilography, physical rehabilitation*

Statement of the problem. Analysis of recent research and publications. As the knee is one of the most active and functionally navantazhuvanyh, he played a leading role in the injury statistics capsule - ligament apparatus, especially anterior cruciate ligament [2]. The number of surgical interventions for plastic anterior cruciate ligament of the knee joint is 34 per 100 000 population [1-3]. The goal of physical rehabilitation of patients after reconstruction of the anterior cruciate ligament of the knee joint is to restore the function of maintaining balance and gait, improve overall physical and emotional condition of the patient [4, 5].

In the rehabilitation of patients with disorders of the knee joint, including the reconstruction of the anterior cruciate ligament, a special place is the problem diagnosis function and motor disorders, monitoring the effectiveness of treatment and training activities. Computer stabilography is one of the most modern methods of investigation that allows you to record fluctuations in the patient's body for performance support reactions while maintaining balance or walking.

The purpose of the study. Examine the state of the maintenance of balance and walking patients with lesions of the anterior cruciate ligament of the knee joint, according to research stabilohrafichnoho preoperatively physical rehabilitation.

We used the following methods: analysis of the literature, the method stabilography (stepping and balancing tests) and statistical processing of the data.

The main material of research. The study examined 21 patients with lesions of the anterior cruciate ligament of the knee joint. In the initial study changes support reactions that were determined during stabilography while performing the balancing test, the patients observed redistribution of body weight at a healthy limb, as reported load values intact limbs were significantly higher than that of the affected and accounted for - $39,08 \pm 2,04$ kg and $35,9 \pm 1,98$ kg ($p < 0.05$), respectively. There was a load distribution asymmetry of the lower limbs (the difference in time load (dominant) and the affected limbs intact) - $30,65 \pm 12,78\%$. Average values of the asymmetry of the load on the affected and intact were - $34,4 \pm 2,67\%$ and $63,48 \pm 2,59\%$ respectively (figures for the dominant load times,%). Thus, in patients with lesions of the anterior cruciate ligament of the knee joint maintaining balance in the vertical rack is provided through the redistribution of body weight in intact limb.

Results stabilohrafichnyh research in functional rehabilitation period (increased physical activity) shown by the fact that patients are imbalance in the vertical rack, patients continue to overload the intact limb. Thus, the test results obtained in functional rehabilitation period (increased physical activity), indicate the need for balance-training program in restorative treatment.

Conclusions. Thus, based on the initial biomechanical characteristics of balance, obtained in the course of the balancing test in patients identified violations load distribution of the lower extremities with lesions of the anterior cruciate ligament of the knee joint. Installed the need for balance-training program in restorative treatment. Prospects for further research in this direction. Evaluating the effectiveness of rehabilitation techniques, including the use of balance training on stabiloplatfomu "Gamma Platform", for patients with lesions of the anterior cruciate ligament of the knee joint based on the asymmetry of loading of the lower extremities.

References

1. Abdelkafy A., Aigner N., Zada M., et al. Two to nineteen years follow-up of arthroscopic meniscal repair using the outside-in technique: a retrospective study// Arch Orthop Trauma Surg. –2007. –V. 127(4).– P.245–252. 61

OBJECTIFICATION OF IMPORTANCE OF BREATHING EXERCISES IN PERSONS WITH SPINAL CORD INJURY

Artem Vetkasov and Blanka Hořková

Charles University, Faculty of Physical Education and Sport, Czech Republic

From clinical practice and research it is known that breathing exercises have a positive effect in people with spinal cord injury (SCI). The purpose of this study was to perform special breathing exercises in persons with SCI and evaluate their effectiveness by using X-ray of lungs and other tests. Sample consisted of 15 respondents with SCI, 8 men and 7 women, mostly middle-aged and elderly. Intervention program has lasted six months, with the frequency of exercise five times a week, in the range of 20-30 minutes. The study has included: 1) Chest X-Ray in a sitting position during inhalation and exhalation; 2) chest excursion; 3) determination of forced vital capacity (FVC) and forced expiratory volume during first second (FEV1); 4) measurement of respiratory rate. Pretest X-ray showed that the difference in the movement of the lower ribs during inhalation and exhalation was 2-35 mm. Measurement of chest circumference showed a limitation of chest expansion related to normal values corrected with age and sex. Tetraplegics FVC decreased by 30-50% compared with the values of healthy population and paraplegics FVC reduced by about 80%. Respiratory rate for all respondents with SCI was 13 to 22 breaths / min. After six months, we repeated the tests. X-ray examination showed that the difference in the movement of the lower ribs during inhalation and exhalation has increased by 49% (6 to 45 mm). Circumference of chest during inspiration increased by 3.5% and chest circumference during exhalation decreased by 1.27%. One-second vital capacity increased by 5.68% and forced vital lung capacity by 7.61%. Respiratory rate decreased on average by 16.22%. In this study, by using X-ray and other tests, we have noted the objective influence of breathing exercises on the respiratory muscles in persons with SCI.

Key words: *breathing exercises, spinal cord injury, X-ray*



Biology & Medicine of Sport and Exercise

**7th INTERNATIONAL
SCIENTIFIC
CONFERENCE ON
KINESIOLOGY**

**FUNDAMENTAL
AND APPLIED
KINESIOLOGY – STEPS
FORWARD**

Editors:

Prof. Branka Matković, PhD, MD

Prof. Marjeta Mišigoj-Duraković, PhD, MD

Prof. Lana Ružić, PhD, MD

Antonela Nedić, MD

Peer Reviewers:

Prof. Branka Matković, PhD, MD

Prof. Marjeta Mišigoj-Duraković, PhD, MD

Prof. Lana Ružić, PhD, MD

Marija Rakovac, PhD, MD

Maroje Sorić, PhD, MD



GENETIC VARIABILITY AND GENE-ENVIRONMENT INTERACTION IN RELATION TO MOVEMENT AND SPORT?

Barbara Wessner

Centre of Sports Sciences and University Sports, University of Vienna, Austria

Human physical performance is determined by a variety of factors including training history, nutritional status, technical aids, psychological strength, social environment but also genetic factors. Several studies have revealed that heritability is a strong component of key endurance (maximal oxygen uptake, lactate/ventilatory threshold, economy of movement, ...) and strength phenotypes (muscle strength, sprint performance, ...). To date more than 200 gene entries and quantitative trait loci have shown some associations or linkages with exercise-related phenotypes (Bray et al. 2009; Pérusse et al. 2013). Many of these associations seem to be rather weak or need to be proven in larger populations, but the impact of the R577X single nucleotide polymorphism of the α -actinin 3 (ACTN3) gene on elite athletic performance and trainability has been confirmed in a series of studies (MacArthur and North 2007). This holds true for a couple of other genetic variants in genes such as the angiotensin I-converting enzyme (ACE), the beta2-adrenergic receptor (ADRB2), the adenosine monophosphate deaminase 1 (AMPD1) or the insulin-like growth factor-1 (IGF-1). However, it is very likely that more than one genetic variant will be responsible for a complex trait such as athletic performance. Therefore, a combinatory polymorphic approach could be one approach to predict human elite status, response to a certain type of exercise or injury risk (Williams and Folland 2008). This lecture will give an overview about the current knowledge about the genetic contribution to sports performance and critically discuss the use and disuse of genetic testing in sports.

1. Bray, M. S., J. M. Hagberg, et al. (2009). "The human gene map for performance and health-related fitness phenotypes: the 2006-2007 update." *Med Sci Sports Exerc* 41(1): 35-73.
2. MacArthur, D. G. and K. N. North (2007). "ACTN3: A genetic influence on muscle function and athletic performance." *Exerc Sport Sci Rev* 35(1): 30-4.
3. Pérusse, L., Rankinen, T., et al. (2013). "Advances in exercise, fitness, and performance genomics in 2012". *Med Sci Sports Exerc.* 45(5):824-31.
4. Williams, A. G. and J. P. Folland (2008). "Similarity of polygenic profiles limits the potential for elite human physical performance." *J Physiol* 586(1): 113-21.

SOMATOTYPES OF DIFFERENT LEVELS IN CZECH AIKIDOKAS

Martina Bernaciková, Zdenko Reguli and Michal Kumstát

Faculty of Sport Studies, Masaryk University, Brno, Czech Republic

Abstract

The purpose of this study was to assess the somatotypes of aikido practitioners. Thirty-three Czech male aikido practitioners (age 36.5 ± 10 years, height 178.1 ± 8.1 cm, and weight 81.2 ± 10.1 kg) (mean \pm SD) participated in this study. The subjects were divided according to ranking system into three groups: Beginners (up to third kyu), Intermediate (second and first kyu) and Advanced (dan holders). The Heath-Carter method was used to assess the somatotype. Bioelectrical impedance was used to assess body composition. The differences between three aikido levels were determined by 1-way ANOVA. The present study showed that the general somatotype of aikido practitioners is between 3.5-5.8-1.8 (Beginners: 2.0-4.9-2.6, Intermediate 4.1-5.9-1.6 and Advanced 3.8-6.3-1.4). There were significant differences in endomorphy component ($p=.001$) between Advanced and Beginners ($p=.006$), Intermediate and Beginners ($p=.001$), whereas no differences were identified in mesomorphy ($p=.082$) and ectomorphy ($p=.079$) component.

Key words: *endomorph, mesomorph, ectomorph, kyu, dan, martial arts*

Introduction

There is only one way to measure performance in Aikido, by examination. In ranking system, there are 6th to 1st kyu grades and 1st to 10th dan degrees. All aikido students wears white belt until they obtain black one for shodan, or 1st dan degree. Except that, more skilful aikidokas are allowed to wear traditional wide pants hakama. Second and first kyu grade holders are recognized as intermediate practitioners, all dan holders are recognised as advanced practitioners. It costs about three years of minimum practice to obtain second kyu and about five years to obtain black belt of first dan.

Technical skills in Aikido consist mainly of throwing an opponent on one side and falling and standing from the ground on the other side. Except that, many cuts and thrusts are done with wooden weapons. There is no ground fighting in Aikido. Only several techniques on the ground while kneeling are practised.

Usual training routine is called *ippan keiko*, common training. It means that aikido students of all levels and age (in case of adult classes) are practising together. After warm up consisting of preparatory exercises, elementary movements and basic falling techniques, teacher shows a technique, and then students try to repeat it for about ten to fifteen minutes. Every technique is practised with different practitioner. So, one always meets more and less experienced partners during the training session. More advanced students, *sempais*, help others to understand techniques. In this case, techniques are performed in slow and safe pace. Of course, when advanced student meets a partner at around the same level, they practise safe, but dynamic with true fighting spirit. Every aikido practitioner sets his own tempo according to chosen training partners. Additionally, there are many aikido styles. Some of them are more static or slow, other are powerful and dynamic. Aikido group selected for the testing is from aikikai group, taught mainly by shihan Franck Noel from France and Seishiro Endo from Japan. The style is dynamic and fluid, and rather sportive than traditional, enabling to practise Aikido to wide population.

Although it may sound strange, they still use traditional way of training. Usually, there are not special training units or exercises for developing simple abilities as strength or speed for instance.

Aikido is usually practised in mixed groups with no age selection and often among people of various performance levels. So we can expect a wide dispersion in age, body mass, somatotypes in any group of Aikido practitioners.

There are several studies conducted in Martial Arts that describe anthropometric characteristics (Pieter & Bercades, 2009; Giampietro et al., 2003; Strekowicz-Przybycień, 2010; Strekowicz-Przybycień & Almansaba, 2011). To our knowledge, there are no studies describing somatotypes in aikido practitioners. The aim of this study is therefore to assess somatotypes in three groups of aikidokas of different levels.

Methods

Thirty three Czech male aikido practitioners, aged 36.5 ± 10 y, height 178.1 ± 8.1 cm, weight 81.2 ± 10.1 kg, BMI 25.6 ± 2.7 (mean \pm SD), volunteered to participate in this study. Practitioners were intentionally classified into three subgroups according to the divisions to which they belonged: Beginners (up to third kyu), Intermediate (second and first kyu),

Advanced (dan holders). The training volume in the selected sample (n=33) is characterized by training session lasting from 1.5-2hours practised 2-4/week. Technical and social factors are typically developed also on occasional weekend seminars, held usually once per month.

The measurements were taken as follows: the subjects were asked to be barefooted on the measuring device only with shorts on them. Height was measured with a stadiometer Tanita HR-001 with accuracy of 0.01 cm. An InBody device scales (InBody 230, model: MW 160) was used for measurements of weight (an accuracy of 0.01 kg) and body composition by means of bioimpedance analysis (BIA). On the basis of the anthropometrical measurements, body mass index (BMI) was calculated.

Skinfold thicknesses were taken with a Best caliper with contact surface pressure of 20 g.mm⁻² (an accuracy of 0.1 mm) at the dominant side of the body twice. Limb girths were performed with a flexible tape measure and four skeletal breadths were measured using an anthropometer Trystom with an accuracy of 0.01 cm.

Somatotype components (endomorph, mesomorph and ectomorph) were determined by the anthropometric Heath-Carter method (1967). Ten variables were used for calculation of anthropometrical somatotype, i.e. body height, weight, four skinfolds (triceps skinfold, subscapular skinfold, supraspinale skinfold, medial calf skinfold), two breadths (humerus breadth and femur breadth) and two girths (flexed and tensed upper arm girth, standing calf girth). For calculation of somatotypes, Carter and Heath's equations were used (1967).

The data obtained were statistically analyzed in Statistica 12 and presented as mean, standard deviation (SD) and range (minimum and maximum values). Standard statistical methods were used to calculate the mean and standard deviations. To determine the differences in somatotype a 1-way ANOVA was used (with Bonferroni's post hoc test). The level of significance was set at the $p < .05$ level. A special computer software "Somatotype" was used to process the results pertaining to the classification of somatotype defined by means of Heath-Carter method (1967).

Results

There were significant differences between Advanced and Beginners in weight (kg), body fat (%), BMI. The same differences were identified between Intermediate and Beginners in weight (kg). Table 1 shows statistical differences between sample characteristics in 3 different subgroups of aikido practitioners.

Table 1: Comparison of characteristics between selected samples

Parameters	Descriptive statistic			ANOVA		Post hoc
	Sample group	Mean (SD)	Range	F	p	
Age (years)	Advanced	39.4 (9.6)	27-52	0.71	.502	
	Intermediate	35.3 (10.7)	20-56			
	Beginners	34.7 (7.7)	26-50			
Height (cm)	Advanced	178.8 (11.5)	162.5-201.0	0.30	.745	
	Intermediate	178.5 (5.8)	169.0-189.5			
	Beginners	175.9 (6.5)	164.5-181.0			
Weight (kg)	Advanced	85.4 (9.0)	75.1-108.4	5.46	.010	ADV vs BEG ($p < .05$)
	Intermediate	85.5 (8.0)	69.4-97.6			INT vs BEG ($p < .05$)
	Beginners	71.6 (10.7)	58.1-84.6			ADV vs INT ($p > .05$)
BF (%)	Advanced	19.5 (4.8)	10.5-28.5	3.60	.040	ADV vs BEG ($p < .05$)
	Intermediate	17.7 (5.6)	10.4-25.6			INT vs BEG ($p > .05$)
	Beginners	13.2 (3.7)	8.8-18.1			ADV vs INT ($p > .05$)
FFM (kg)	Advanced	68.8 (8.7)	55.2-87.0	1.89	0.17	
	Intermediate	68.0 (5.6)	60.9-78.9			
	Beginners	62.1 (9.5)	51.0-76.3			

Legend: BF – body fat, FFM – fat free mass; bioelectrical impedance analysis was used to determine BF and FFM, ADV – Advanced, INT – Intermediate, BEG – Beginners

There was a main effect ($p < .05$) in endomorphy component of somatotype in Advanced vs Beginners group and Intermediate vs Beginners group. The analysis of the somatotype components showed no differences both in mesomorphy and ectomorphy component and within all selected groups. Table 2 shows statistical differences between somatotype components in 3 different groups of aikido practitioners.

Table 2: Comparison of somatotype features between selected samples

Parameters	Descriptive statistic			ANOVA		Post hoc
	Sample group	Mean (SD)	Range	F	p	
ENDO	Advanced	3.81 (.65)	2.8-4.8	8.73	.001	ADV vs INT (p<0,05)
	Intermediate	4.06 (1.36)	1.2-6.2			INT vs BEG (p<.05)
	Beginners	2.04 (.65)	1.1-2.8			ADV vs INT (p>.05)
MESO	Advanced	6.34 (1.23)	3.6-8.2	2.72	.082	
	Intermediate	5.94 (1.21)	4.2-7.7			
	Beginners	4.90 (1.27)	2.6-6.7			
ECTO	Advanced	1.35 (0.92)	0.1-3.3	2.77	.079	
	Intermediate	1.61 (0.98)	0.2-3.7			
	Beginners	2.60 (1.45)	1.4-5.3			

Legend: ENDO – endomorphy, ECTO – ectomorphy, MESO- mesomorphy, ADV – Advanced, INT – Intermediate, BEG - Beginners

Figure 1 shows somatoplots for aikido practitioners. The endomorphic mesomorph is typical for Advanced (9/11) as well as for Intermediate (12/15). In Advanced group we found one practitioner with the ectomorphic mesomorph and one with cenral somatotype. In Intermediate group we identified one practitioner with the ectomorphic mesomorph, one practitioner with the mesomorph-ectomorph and one practitioner with the mesomorp-endomorph. Three out of seven Beginners are characterized by the endomorphic mesomorph, two out of seven by balanced mesomorph and two out of seven by mesomorphic ectomorph.

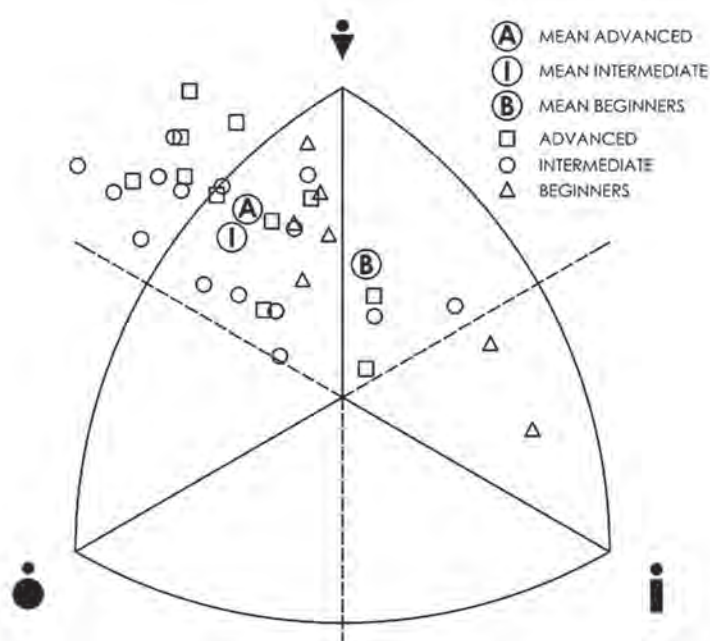

Figure 1: Somatotypes in aikido practitioners in Beginners, Intermediate and Advanced.

Discussion and conclusions

The present study demonstrated that the higher level (dan holders and first and second kyu) the higher endomorphy component in comparison to the lower level (up to third kyu). Table 3 shows comparative data on somatotypes and other anthropometric characteristics in male combative athletes (e.g. karate, judo, jiu-jitsu, silat and wrestling) found in recent literature.

Table 3: Comparison of selected anthropometric data among martial arts (Mean (SD)).

Discipline and reference	n	Age (years)	Height (cm)	Weight (kg)	BF (%)	BMI (kg.m ²)	ENDO	MESO	ECTO
AIKIDO									
this study	33	36.5 (13.5)	178.0 (8.0)	81.1 (10.1)	17.2 (5.3)	25.6 (2.7)	3.5 (1.33)	5.8 (1.36)	1.8 (1.28)
SILAT									
Pieter & Bercades (2009)	8	26.9 (2.0)	169.0 (5.6)	70.9 (16.2)			3.20 (1.71)	5.58 (1.63)	2.02 (1.08)
KARATE									
Pieter (2009)	12	24.0 (4.8)	169.7 (4.9)	64.2 (7.1)			2.42 (.72)	4.70 (.95)	2.55 (1.10)
Giampietro et al. (2003)	14	23.8 (2.8)	180.0 (7.0)	72.4 (8.7)	9.8 (1.6)	22.3 (1.7)	2.10 (.60)	3.50 (1.00)	3.10 (.80)
Sterkowicz-Przybycień (2010)	30	25.0 (5.8)	180.0 (6.0)	83.6 (10.5)	16.6 (2.2)	25.8 (2.2)	3.20 (2.15)	6.32 (1.63)	1.64 (.94)
JUDO									
Sterkowicz-Przybycień & Almansba (2011)	22	22.2 (3.6)	179.6 (8.1)	87.5 (24.9)	14.3 (4.7)	26.8 (5.2)	3.20 (2.15)	6.32 (1.63)	1.64 (.94)
JIU-JITSU									
Sterkowicz-Przybycień (2010)	5	20.6 (4.2)	178.0 (6.0)	85.3 (4.1)	11.7 (1.9)	27.1 (2.4)	3.00 (.96)	6.70 (1.09)	1.20 (.76)
Sterkowicz-Przybycień (2010)	13	22.2 (4.9)	176.0 (8.0)	69.3 (8.2)	7.1 (2.0)	22.4 (1.8)	1.90 (.41)	5.50 (1.05)	2.80 (.97)
Andreato et al. (2012)	11	25.8 (3.3)	180.1 (6.5)	83.1 (8.7)	10.3 (2.6)	25.6 (1.5)	3.00 (.80)	5.50 (1.00)	1.70 (.60)
GRAECO-ROMAN WRESTLING									
Sterkowicz-Przybycień et. al. (2011)	23	24.9 (5.5)	175.0 (9.0)	81.8 (14.3)	12.1 (2.0)	26.3 (2.2)	2.00 (.50)	6.60 (.90)	1.20 (.50)

Legend: BF – body fat, BMI – body mass index, ENDO – endomorphy, ECTO – ectomorphy, MESO- mesomorphy

Compared to elite Philippines silat, the Czech aikidos were more endomorphic and less ectomorphic (Pieter, 2009). Karate athletes were usually balanced mesomorph (Pieter, 2009 and Giampietro et al., 2003). Sterkowicz-Przybycień (2010) presented similar values for Polish karate athletes. Endomorphic mesomorph is typical for Polish judo (Sterkowicz-Przybycień and Almansba, 2011) and Polish and Brazilian jiu-jitsukas (Sterkowicz-Przybycień, 2010 and Andreato et al., 2012). Polish judo athletes had higher weight (87.5 kg vs. 81.2 kg) and body height (179.6 cm vs. 178.1 cm) and jiu-jitsu athletes had similar weight (83.1 kg vs 81.2 kg) and height (180.1 cm vs 178.1 cm). Sterkowicz-Przybycień and Almansba (2011) found that in judo, which is the most similar to aikido in technique, a mean percentage body fat (14.3%) was slightly lower than that for our sample of subjects (17.2%).

Aikido uses many circular movements utilize centrifugal and centripetal forces and according to the philosophy of aikido, tanden is the centre of vital power. The anthropometric characteristics of combat sport competitors compared to untrained subjects available in references are very scarce. When we compare somatotype features of Czech aikido practitioners with results research from our laboratory of Czech collegiate students of Physical Education (PE) (unpublished data), endomorphy component was dominant. The sample of Czech PE students (n=63) was characterized by ectomorphic mesomorph somatotype (2.2±0.8-4.7± 1.2-3.1±0.9).

There are several issues that might contribute to the somatotype variability and remain to be determined, e.g. gender differences, period of training experience, fitness status etc.

In conclusion, the present study demonstrated that the general somatotype of aikido practitioners is between 3.5-5.8-1.8, which represents endomorphic mesomorph type. In our studied group the endomorphic mesomorph component was dominant in 24 out of 33 tested subjects.

References

1. Andreato, L. V. & Franchini, E. & Moraes, S. M. F. & Esteves, J. V. C. & Pastório, J. J. & Anreato T. V. & Gomes, T. L. M. & Vieira, J. L. L. Morphological profile of Brazilian Jiu-jitsu elite athletes. *Revista Brasileira de Medicina do Esporte*, 18 (1).
2. Giampietro, M., Pujia, A. & Bertini, I. (2003) Anthropometric features and body composition of young athletes practicing karate at a high and medium competitive level. *Acta Diabetologica*, 40, S145-S148.
3. Heath B. H. and Carter J. E. L. (1967) A modified somatotype method. *American Journal of Physical Anthropology*; 27: 57-74.
4. Pieter, W. & Bercades, L. T. (2009) Somatotypes of national elite combative sport athletes. *Brazilian Journal of Biometricity*, 3 (1), 21-30.
5. Strekowicz-Przybycień, K. L. (2010). Technical diversification, body composition and somatotype of both heavy and light Polish ju-jitsukas of high level. *Science & Sports*, 25, 194-200.
6. Strekowicz-Przybycień, K. L. (2010) Body Composition and Somatotype of the Top of Polish Male Karate Contestants. *Biology of Sport*, 27 (3), 195-201.
7. Strekowicz-Przybycień, K. L. & Almansba, R. (2011). Sexual dimorphism of anthropometrical measurements in judoist vs untrained subject. *Science & Sports*, 26, 316-323.
8. Strekowicz-Przybycień, K. L., Strekowicz, S. & Zarów, R. T. (2011). Somatotype, Body Composition and Proportionality in Polish Top Greco-Roman Wrestlers. *Journal of Human Kinetics*, 28, 141-154.

NUTRITIONAL KNOWLEDGE AND DIETARY HABITS IN FEMALE BASKETBALL PLAYERS

Gordana Ivković

University of Zadar, Croatia

Abstract

The aim of this study was to determine the knowledge of women basketball players about nutrition and eating habits and the relationship between knowledge and habits. The sample consists of 236 basketball players, average age at 20.33 years. Most basketball players have a BMI within normal range. The nutritional course was attended by 22.88% basketball players. They have better eating habits, but not better nutritional knowledge. Dietary supplements used 46.19% basketball players, a higher percentage of vitamins and minerals. Test results show a lack of knowledge about nutrition and the worst knowledge is shown on fats and proteins. The average number of points for eating habits is 31.29 out of a possible 45. The research results indicate a lack of nutritional knowledge and show average eating habits. Nutritional knowledge does not affect their habits. All this points the need to increase education for basketball players, parents, coaches and sports trainers and nutritionists necessity in clubs.

Key words: athlete, diet, eating habits, basketball players

Introduction

The combination of endurance, speed, strength, agility, specific basketball skills and mental focus, makes basketball a very intense sport. While players rarely come to the maximal running speed, they spend a considerable amount of energy for a change of direction, acceleration and deceleration movements, jumps and passing the ball. All this makes the basketball very demanding for the anaerobic and aerobic energy system. In order to learn its energy needs and to ensure adequate amounts of nutrients to build the body, adequate nutrition is an important factor in the training process for a female basketball player. Proper nutrition is not only a very important role in reducing and delaying fatigue, which creates an edge over rivals, but also reduces the chance of injury. Many injuries occur in the final minutes of the game when the basketball players are physically and mentally tired. Diet for female basketball players should be mainly based on carbohydrates and that carbohydrates constitute 55-65% of total energy intake, fat 20-30% and proteins 15%. This means that the basketball player whose energy intake should be 16 000 kJ should consume throughout the day 550-600 g carbohydrates, 94 to 140 g of protein and 110-130 grams of fat. Further it is recommended that the total quantity of carbohydrates is consumed about 60% is in the form of complex carbohydrates and an identical percentage of fat in the form of unsaturated fatty acids. The food must contain a sufficient amount of micronutrients, vitamins and minerals. Vitamins and minerals play an important role in energy production, synthesis of hemoglobin, maintaining bone health, proper immune system and protect tissues from oxidative damage. Supplements of vitamins and minerals are not necessary if the consumption of various food intake is energy sufficient to maintain body weight. However, athletes who restrict energy intake, use rigorous diets, eliminating one or more food groups from your diet, or consume unbalanced diet, can use supplements. Dietary supplements should be added to the regular diet as directed by a doctor, although some studies question the quality of support and safety of use (The American Dietetic Association. 2005.; Burke, L. 2006). The use of nutritional supplements out of control specialists and taking large doses can be dangerous.

Methods

The sample was composed of 236 female basketball players. Larger group of 153 are women basketball players of Croatian first and second league and another group of 83 foreign basketball players, who are members of the ten college basketball teams and participating in international tournaments. Knowledge about sports nutrition as well as dietary habits are established through appropriate questionnaires. Questionnaire on knowledge (50 queries) on sports nutrition is designed to determine knowledge about nutrition basketball players in general, about the ingredients necessary to ensure the athletes enough energy for training and competition, about supplements, meal schedule before training and competition, as well as during recovery and the importance of liquids, dehydration and rehydration during training and competition. For all the particles of the questionnaire were calculated frequencies and percentages. The existence of a correlation between dietary habits and nutritional knowledge was tested using Pearson's correlation coefficient, and the differences between individual groups of women's t-test and analysis of variance. All coefficients are tested at a significance level $p < 0.05$.

Results and discussion

Women basketball players have an average 20.33 years, average height is 176.82 centimeters, body weight of 68.23 kg and an average body mass index of 21.94. Croatian basketball players were significantly younger than foreign basketball player and also there is a statistically significant difference in body mass index (BMI).

Figure 1. shows the degree of nutritional subjects according to BMI values due to the group. Underweight (BMI <18.5 kg/m²) was 3.81% Croatian basketball players and a 2.41% foreign basketball players. The largest number of basketball players, (Croatian 91.58% and by 78.31%) have a BMI within the limits of normal values (18.5 to 24.9). High values of body mass index have 19, 8% of foreign basketball players, and 3.92% of Croatian basketball player. Yet excessively high body mass index (BMI> 30) does not exist among respondents. Results indicate the expected absence of overweight among tested basketball players, but the population group in relation to the rest of the population has a higher energy consumption.

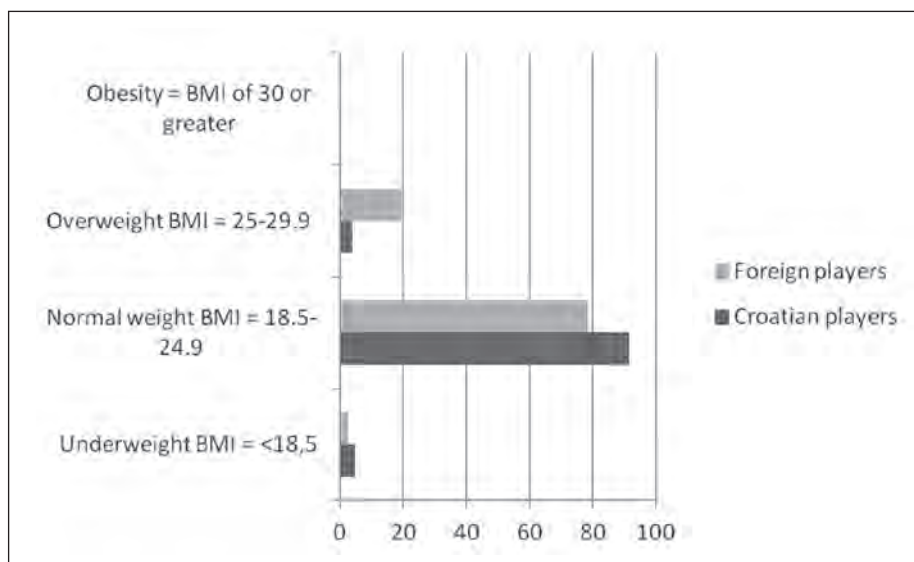

Figure1: Display of body weight given to group

Table 1: Use of nutritional supplements

	All players	Croatian players	Foreign players
Using Nutritional Supplements%			
Do not use	53,81	56,21	49,4
Use	46,19	43,79	50,6
Types of dietary supplements%			
Vitamins	48,04	56,72	36,36
Minerals	36,04	19,4	61,36
Proteins	11,71	17,91	2,27
Carnitine	0,9	1,49	0
vitamins and minerals	2,7	4,48	0

In Table 1. there are results related to dietary supplements. Despite the conventional point of view that athletes use supplements in large quantities (Beltz et al. 1993), this study shows that 53% of women basketball players do not use supplements. Of those who use supplements, 48.4% take vitamins, 36.04% minerals, and other dietary supplements in a smaller proportion of 20%. Interestingly, the Croatian women basketball players consume vitamins in larger numbers than foreign women basketball players. On the other hand, foreign women basketball players use a lot more minerals than Croatian basketball player as dietary supplements. The results show a lack of nutritional knowledge. The level of expertise of female basketball player is at 64.06%. Other studies also show a lack of nutritional knowledge among women basketball players. Greater lack of knowledge about nutrition among Turkish basketball player was spotted in research of Suel E. et al (2009), then Jessri M. et al (2010) in Iranian female basketball players. American university athletes, including women basketball players, also showed less nutritional knowledge (Dann D. et al. 2001) as well as New Zealand adolescents including female basketball players (Burkhart S. 2010).

Table 2: The average number of correct statements related to a particular area of food due to the group ($\bar{x} \pm sd$) ($n = 236$)

	All players	Croatian players	Foreign players	t-test
Basketball players statements related to carbohydrate%				
$\bar{x} \pm sd$	69 ± 0,43	68 ± 0,41	70 ± 0,44	0,22
Statements related to proteins %				
$\bar{x} \pm sd$	49 ± 0,49	44 ± 0,47	54 ± 0,50	0,23
Statements related to fat %				
$\bar{x} \pm sd$	30 ± 0,45	24 ± 0,45	37 ± 0,45	2,11*
Statements related to water and beverages %				
$\bar{x} \pm sd$	67 ± 0,45	64 ± 0,46	70 ± 0,45	0,28
Statements related to vitamins and minerals %				
$\bar{x} \pm sd$	71 ± 0,43	76 ± 0,40	66 ± 0,45	0,17
Statements related to nutrition in general %				
$\bar{x} \pm sd$	74 ± 0,41	79 ± 0,39	70 ± 0,43	0,07
Statements regarding dietary supplements %				
$\bar{x} \pm sd$	59 ± 0,44	59 ± 0,41	58 ± 0,46	0,28

* Statistically significant differences at $p < 0.05$

Table 2. contains statements that are divided considering the core area of nutrition that they define. In each group, the statement shows the number of correct answers in the group. Unsatisfactory knowledge (below 50%) of Croatian basketball players are shown in claims related to fats and proteins. According to these data, a statistically significant difference between the Croatian and foreign female basketball player shows only the assertion of fat. Worse knowledge of all the basketball players are shown with allegations of proteins. In this study, out of a maximum 45 points, 60.17%, basketball players, on average, had 31.29 points to questions about the frequency of consumption of food and beverages.

Table 3: Ratings of the dietary habits of basketball player

Rank	All	%	Croatian	%	Foreign	%
	n		n		n	
1 (<50%)	6	2,54	3	1,96	3	3,61
2 (50-60%)	45	19,07	33	21,57	12	14,46
3 (61-79%)	142	60,17	97	63,4	45	54,22
4 (80-89%)	36	15,25	18	11,76	18	21,69
5 (90-100%)	7	2,97	2	1,31	5	6,02

Table 3. presents basketball players according to the assigned scores for dietary habits and shows the most frequent rating of “good” as an intermediate measure. However, the rating “good” covers most basketball players that are in that range of good eating habits (60%). Only 2.54% of basketball players had poor dietary habits and excellent dietary habits had seven (2.97%) basketball player. The association between dietary knowledge and habits assessed using Pearson’s correlation coefficient, which indicates that there is no statistically significant correlation between nutritional knowledge and eating habits of basketball player (Table 4.).

Table 4: Pearson’s correlation coefficient

	Knowledge	Habits
Knowledge	1	0,048
Habits	0,048	1

Table 5: Knowledge about nutrition, dietary habits and body mass index (BMI), in relation to the finished course on nutrition ($x \pm sd$)

	Course on nutrition	$x \pm sd$	df	F	p
Knowledge about nutrition	completed (n=54)	63,56 \pm 13,3	1	0,188	0,664
	not completed (n=184)	64,21 \pm 8,50			
dietary habits	completed (n=54)	32,62 \pm 4,00	1	6,153	0,013*
	not completed (n=184)	30,90 \pm 4,40			
BMI	completed (n=54)	23,00 \pm 2,44	1	17,52	0,000*
	not completed (n=184)	21,62 \pm 2,02			

* Statistically significant differences at $p < 0.05$

The dietary course was attended by 22.88% female basketball players, of which only 6.12% of Croatian and 42.15% of foreign female basketball players. Basketball players who have undergone a dietary course have better dietary habits, but no nutrition knowledge. The results show that female basketball players benefit from the dietary course .

Table 6: Source of information and dietary habits of female basketball player (% of respondents)

Frequency	Worse dietary habits	Better dietary habits	t-test
Source of information related to nutrition %			
Internet	42,86	25,37	-2,25*
Magazines	37,14	43,28	
Coach	17,14	18,91	
Other	0	1,49	
Professionnal and scientific journals	2,86	10,95	

* Statistically significant differences at $p < 0.05$

The results also show a statistically significant difference between the way that basketball players receive information about their diet and eating habits (Table 6.). Women basketball players who use scientific and professional journals as sources of information have better dietary habits than players who rely on the Internet as the dominant literature. The research results indicate a lack of nutritional knowledge among women basketball players and show average dietary habits. Female basketball players nutritional knowledge does not affect their habits.

Conclusion

Results of this study show a lack of nutritional knowledge among women basketball players . The level of expertise of women basketball players is at 64.06%. Other research of nutritional knowledge female basketball player also point to deficiencies in knowledge in this area . In this study , out of a maximum 45 points, 60.17% , basketball players, on average, had 31.29 points to questions about the frequency of consumption of food and beverages . There was no statistically significant correlation between nutritional knowledge and eating habits of female basketball players. Basketball players who have undergone a course of diet have better eating habits , but no nutritional knowledge . The results show that basketball players benefit from the dietary course . Women basketball players who use scientific and professional journals as sources of information have better dietary habits while basketball players that rely on the Internet as the dominant literature. This study is consistent with previous studies conducted in female athletes that showed that basketball players have insufficient nutritional knowledge, that female basketball players are not enough aware of the importance of nutrition for basketball performance and have questionable eating habits. All this points to the necessity for education in women basketball, as well as trainers and coaches.

Reference

- Burkhart S. J. (2010) I Assessment of nutritional knowledge and food skills in talented adolescent athletes. Massey University, Palmerston North, 284
- Heaney S, O'Connor H, Michael S, Gifford J, Naughton G. (2011) Nutrition knowledge in athletes: a systematic review. *Int J Sport Nutr Exerc Metab.* 21(3):248-61.
- Süel Emin, Şahin Ibrahim, Korkmaz Cihat, at all. (2009). In the grade universty the determination of female and male basketball players nutrition knowdlwge and habits *International Journal of Human Sciences*, 6,(2)
- Jessri M; at all (2010) Evaluation of Iranian college athletes' sport nutrition knowledge. *Int J Sport Nutr Exerc Metab.*20 (3), pp. 257-63
- Dunn, MS, Eddy, JM, Wang, MQ, Perko, MA & Bartee, RT (2001). Influence of Parents, Coaches, and Trainers on Attitudes, Subjective Norms and Intentions among Male and Female Adolescents. *Journal of Adolescent and Family Health* , 16(3), 41-46.
- Burke L. (2006) Supplements and sports foods. In: Burke L, Deakin V, editors. *Clinical Sports Nutrition* . Sydney, Australia: McGraw-Hill; p. str 485-579. exercise performance. *Med Sci Sports Exerc* 1996;28:1300-4.

ASSOCIATION BETWEEN PHYSICAL INACTIVITY, ANTHROPOLOGICAL AND BIOCHEMICAL PARAMETERS IN OVERWEIGHT AND NORMAL WEIGHT MIDDLE-AGED ADULTS

Mihaela Jurdana^{1,2}, Ana Petelin¹ and Zala Jenko Pražnikar¹

¹University of Primorska, Faculty of Health Sciences, Izola, Slovenia

²University of Primorska, Science and research centre Koper, Institute for Kinesiology research

Abstract

The manuscript discusses about the evidence linking physical inactivity with overweight and obesity. The hypothesis is that low levels of physical activity and sedentary lifestyles favour positive energy balance, therefore leading to obesity low grade inflammation and weight gain.

Based on body mass index (BMI) the percentage of fat mass and waist circumference, the participants were divided in overweight and normal weight group. Anthropometric parameters, biochemical variable C-reactive protein (CRP) and serum visfatin and life style factors were compared between the studied groups using Student's t-test. On relating BMI with the various lifestyle factors, a statistically significant difference regarding physical activity, physical fitness and biochemical parameters were found between studied groups. Conclusion: The increasing prevalence of physical inactivity seems to be an important explanation for increasing obesity and obesity related disorders.

Key words: *physical activity, physical fitness, overweight/obesity, inflammation*

Introduction

Globally, obesity has reached an epidemic proportion, within 2008, 1.5 billion adults, 20 years of age and older, being overweight (WHO, 2011). In developed countries obesity is increasing continuously, especially since obesity arises from a complex of lifestyle factors, among them decreasing levels of physical activity (Warburton et al., 2006). Obesity is associated with a state of chronic low-grade inflammation due to changes in the function of adipocytes and macrophages (Weisberg et al., 2003). C-reactive protein (CRP), one of the strongest markers of chronic inflammation, is associated with obesity and could be used as a diagnostic marker for cardiovascular diseases (Ridker, 2009). Visfatin, originally isolated from peripheral blood lymphocytes as a secreted growth factor that enhances B-cell precursor's maturation, has recently been identified as a novel adipocytokine, associated with visceral fat in humans and mice. The physiological role of visfatin is not completely understood, nevertheless, the discovery of this adipokine has great potential for enhancing understanding of the pathogenesis of obesity.

It has been demonstrated that risk of overweight and/or obesity are directly associated with physical inactivity and sedentary habits; such as time spent sitting per week during leisure time (Proper et al., 2006), and time spent in cars and miles travelled by car per week (Frank et al., 2004). Moreover, low levels of physical activity have been shown to be associated with an increased level of body weight (Chaput et al., 2011) and with increased risk of overall mortality and several common diseases and disorders, including coronary heart disease, stroke, osteoporosis, diabetes, and others (Lee et al., 2012). On the contrary, a simple remedy like daily implementation of routine physical exercise prevents the occurrence of several chronic diseases (Wadden et al., 2012). In addition, it has been shown that routine physical activity improve body composition (reduced abdominal adiposity and improved weight control), glucose homeostasis and insulin sensitivity, coronary blood flow and cardiac function, enhance endothelial function, lipid lipoprotein profiles, reduce blood pressure and systemic inflammation (Greene et al., 2012). Chronic inflammation, as indicated by elevated circulating levels of inflammatory mediators such as CRP, has been also shown to be strongly associated with most of the chronic diseases whose prevention has benefited from exercise (Warburton et al., 2006).

The aim of our study was to investigate a potential association between physical inactivity, anthropological and biochemical parameters in overweight and control middle-aged adults.

Methods

1. Participants

96 healthy participants (66% females and 34% males) aged 25-49 years with no history of disorders participated in our cross-sectional study. The study was approved by the Slovenian National Medical Ethics Committee and was performed in accordance with the ethical standards laid down in the 1964 Declaration of Helsinki. The project (A multidisciplinary approach in the treatment of obesity) was carried out between October and December 2011 at the University of Primorska, Faculty of Health Sciences, Izola, Slovenia.

2. Anthropometric and other measurements

Subject height was measured to the nearest 0.1 cm in a standing position, without shoes, using Leicester Height Measure (Invicta Plastics Limited, Oadby, England). Body weight of the participants wearing common light indoor clothing without shoes was measured with a 0.1 kg precision. Body composition was assessed by using bioelectrical impedance analysis (BIA) Tanita BC 418MA (Tanita Corporation, Arlington Heights, IL). Waist and hip circumferences were measured with measuring tape to the nearest 0.1 cm. Serum concentrations of CRP were measured using of Olympus reagents and performed on an AU 680 analyser (Beckman Coulter). Serum visfatin concentrations were measured in duplicate with a human visfatin ELISA Kit (BioVision, Mountain View, CA, USA) performed on a microplate reader (Tecan, Männedorf, Switzerland). Assay sensitivity was 30 pg/mL, and interassay and intraassay CVs were both <10%.

2.1. Classification of obesity

The body mass index (BMI) was calculated using the formulae: weight (kg)/height (m²). Overweight and obesity were defined as BMI 25-29 kg/m² and ≥ 30 kg/m² (20), respectively, and by large waist circumference (WC) (≥ 94 cm in men and ≥ 80 cm in women), and by high % of total fat ($\geq 21,5\%$ in men and $\geq 32\%$ in women). Participants with at least two of these characteristics were classified as member of the overweight group.

2.2. Assessment of lumbar paraspinal and trunk muscle endurance

To assess muscle capabilities we performed the extensor and flexor endurance test as previously described (Biering-Sørensen, 1984). Briefly, to measure back extensor endurance, participants laid prone with the lower body fixed to the test bed and the upper body extended in a cantilevered fashion over the edge of the test bench. Participants maintained their position at 0° of lumbar flexion. The flexor endurance test required participants to sit on the test table and place the upper body at an angle of 60° from table. The trial was initiated with a 2 min resting baseline, the endurance time was manually recorded in seconds.

2.3. Testing physical fitness

Physical fitness was assessed to predict maximal oxygen uptake and to measure the ability of brisk walking. Functional status was assessed by estimation of the ability for low intensity walking over 2 km according to the UKK walk test programme. The walking time was recorded; the pulse rate was measured at the cervical aorta for 15 s and multiplied by 4. Fitness index (FI) was calculated on the basis of the mentioned programme developed by the UKK Institute for Health Promotion Research, Tampere, Finland based on age, BMI, walking time and pulse by the following formulas: for males: $[I = 420 + A*0.2 - T*11.6 - P*0.56 - BMI*2.6]$ and for females: $[I = 304 + A*0.4 - T*8.5 - P*0.32 - BMI*1.1]$, where A = age; T = walking time in minutes, seconds; P = pulse; BMI = body mass index. The interpretation of FI measurements is: 1) FI < 70 significantly low; 2) FI 70–89 under average; 3) FI 90–100 average; 4) FI 111–130 above average; and 5) FI > 130 significantly high.

2.4. Assessment of physical activity by questionnaire

The Physical questionnaire AMA accessible through the web site (<http://www.ama-assn.org>) was used to assess the physical activity. The questionnaire collected information on the time spent performing physical activity (number of sessions and average time per session), sedentary pursuits; essentially sitting and physical activity barriers.

3. Statistical methods

To describe the characteristics of the overweight and normal weight group, the mean values with standard deviations and proportions were calculated and statistically analysed using the IBM SPSS version 19.0 (SPSS Inc, Chicago, IL, USA). Two groups were formed in respect to BMI, percent of total fat, and WC. All anthropometric variables and lifestyle factors were compared between the studied groups and by gender using the Student's t-test. P value of less than 0.05 was taken as statistically significant difference between the tested parameters. The Pearson's correlation test (r) was used in the second stage for identifying the correlation between FI and visfatin.

Results

Table 1 summarizes the anthropometric, biochemical and life style parameters of 48 normal weight and 48 overweight participants. No significant difference of age was observed between the studied groups. Statistically significant differences between these two groups were observed in BMI, WC, the percentage of fat mass, visceral fat rating, CRP and serum visfatin concentration (Fig 1). On relating BMI with the various subject's lifestyles, no statistically significant differences in the prevalence of obesity by spending time sitting were found, but a statistically significant difference regarding physical activity, endurance times of trunk and lumbar muscle and physical fitness was found. In terms of minutes per week the physical activity was significantly higher in the normal weight group compared with the overweight group. Similar results were obtained in terms of the frequency of physical activity per week and for the physical fitness.

The most common barriers for overweight participants to be physically active include: lack of time, being lazy, being on the job/working a lot, and in the case of women not having enough motivation. Other reasons for not being physically active in the overweight group include: relying on cars and public transportation instead of walking or biking to their place of work. In the overweight group only 2% of the participants reported walking or cycling to and from the job, while in the normal weight group this percentage was 25% (data not shown).

	Overweight group	Normal weight group	<i>p</i>
	M ± SD	M ± SD	
Participants (n)	48	48	ns
Age (y)	38.8 ± 6.1	36.5 ± 6.3	ns
BMI (kg/m ²)	29.4 ± 2.7	21.9 ± 2.4	0.0001**
Waist circumference (cm)	94.4 ± 7.7	76.1 ± 8.1	0.000***
Hip circumference (cm)	107.5 ± 7.8	92.6 ± 6.5	0.000***
Fat mass (%)	33.7 ± 7.7	21.4 ± 6.4	0.000***
Visceral fat rating	7.8 ± 2.1	3.3 ± 1.7	0.000***
CRP (mg/l)	3.02 ± 3.00	0.84 ± 0.82	0.000***
Visfatin (ng/ml)	4.22 ± 0.82	2.27 ± 0.73	0.003**
Physical activity (frequency per week)	1.8 ± 1.5	3.0 ± 2.1	0.001**
Physical activity (min per week)	110 ± 82	180 ± 156	0.008**
Fitness index	82.3 ± 15.6	107.9 ± 14.9	0.000***
Sitting time (h/ day)	6.9 ± 3.3	7.4 ± 3.7	ns
Lumbar paraspinal muscle endurance time (s)	77.6 ± 35.4	108.2 ± 21.2	0.000***
Trunk muscle endurance time (s)	32.7 ± 29.2	62 ± 36.6	0.000***

Note: BMI, Body mass index; CRP, C-reactive protein; n, number of participants.

The mean difference is significant at the 0.05 level; ***P<0.001, **P<0.01, *P<0.05.

Figure 1

Discussion

Physical inactivity is one of the most important reasons for an increasing number of people in Europe, to be at risk in reaching overweight and obesity (Axelsen et al., 2012). From the aspect of unhealthy habits the findings of our study provide evidence on the high prevalence of low level of physical activity of the participants from the overweight group. Although increasing physical activity is an effective therapy for weight loss, higher physical fitness may also emerge as a promising treatment for reducing overall inflammation and contribute to clinical benefits (Beavers et al., 2010). Given that physical activity and obesity are inversely related, it is not clear as to whether the anti-inflammatory health benefits of a physically active lifestyle are due to exercise per se or result from favorable changes in body composition (Calder et al., 2011). Indeed, we observed a significantly higher value of CRP and serum visfatin in overweight group compared to normal weight group.

Many personal variables, including physiological and behavioural factors, may affect the plans of participants to become more/less physically active. Three most common reasons which participants cite, for not adopting more physically active lifestyles are time, laziness, working, and also motivation. Similar results were also shown in other studies (Wadden et al., 2012).

We found that the quantity of physical activity in overweight group was under the minimum of official public health recommendations. These findings suggest that especially the overweight individuals should be encouraged to perform exercise.

Physical fitness, which generally increases with increased physical activity, also may attenuate obesity related mortality (Wadden et al., 2012). The perceived physical fitness is an integrated result of the functional status and health of many organ systems, in which particularly the cardio vascular system plays a pivotal part.

Conclusion

Our study provides evidence on the high prevalence of low level of physical activity of the participants from the overweight group compared to the normal weight group.

Moreover, our results suggest that, in addition to antropometric factors, the subject's aerobic and anaerobic capabilities, biochemical parameters (serum CRP and visfatin concentration), are important and may reflect the inflammation state of participants.

References

1. Axelsen, M., Danielsson, M., Norberg, M. & Sjöberg A. (2012). Eating habits and physical activity: Health in Sweden: The National Public Health Report 2012. *Scandinavian Journal of Public Health*, 40(9), 164-175.
2. Beavers, K. M., Brinkley, T. E., & Nicklas, B. J. (2010). Effect of exercise training on chronic inflammation. *Clinica Chimica Acta*, 411, 785-793.
3. Biering-Sørensen F. Physical measurements as risk indicators for low back trouble over a one-year period. *Spine*. 1984;9:106–119.
4. Calder, P. C., Ahluwalia, N., Brouns, F., & Winklhofer-Roob, B. (2011). Dietary factors and low-grade inflammation in relation to overweight and obesity. *British Journal of Nutrition*, 106 (Suppl 3), S5-S78.
5. Chaput, J.P., Klingenberg, L., Rosenkilde, M., Gilbert, J.A., Tremblay, A., & Sjödén, A. (2011). Physical Activity Plays an Important Role in Body Weight Regulation. *Journal of Obesity*, doi:10.1155/2011/360257.
6. Fitness for Health . Tamper Finland. At: 2002;[accessed 14.09.12] <http://www.ukkinstituutti.fi>
7. Greene, N.P., Martin, S.E., & Crouse, S.F. (2012). Acute exercise and training alter blood lipid and lipoprotein profiles differently in overweight and obese men and women. *Obesity (Silver Spring)*, 20(8), 1618-1627.
8. Lee, I.M., Shiroma, E.J., Lobelo, F., Puska, P., Blair, S.N. & Katzmarzyk, P.T. (2012). Effect of physical inactivity on major non-communicable diseases worldwide: an analysis of burden of disease and life expectancy. *Lancet*, 380(9838), 219-229.
9. Proper, K.I., Cerin, E., Brown, W.J & Owen, N. (2006). Sitting time and socioeconomic differences in overweight and obesity. *International journal of obesity*, 31, 169-176.
10. Ridker, P.M. (2009). Testing the inflammatory hypothesis of atherothrombosis: scientific rationale for the cardiovascular inflammation reduction trial (CIRT). *Journal of thrombosis and haemostasis*, 7, 332-339.
11. Wadden, T.A., Webb, V.L., Moran, C.H. & Bailer, B.A. (2012). Lifestyle Modification for Obesity New Developments in Diet, Physical Activity, and Behaviour Therapy. *Circulation*, 125, 1157-1170.
12. Warburton, D.E., Nicol, C.W. & Bredin, S.S. (2006). Health benefits of physical activity: the evidence. *The Canadian Medical Association Journal*, 174, 801-809.
13. Weisberg, S.P., McCann, D., Desai, M., Rosenbaum, M., Leibel, R.L. & Ferrante, A.W. (2003). Obesity is associated with macrophage accumulation in adipose tissue. *Journal of Clinical Investigation*, 112, 1796-1808.
14. World Health Organization (2011). Fact sheet no. 311: obesity and overweight. Available at <http://www.who.int/mediacentre/factsheets/fs311/en/index.html>. Accessed on 02/04/201

EATING HABITS AND SPORTS ACTIVITIES IN THE MILITARY UNIVERSITY STUDENTS

Jana Juříková

Faculty of Sports Studies, Department of Kinesiology, Masaryk University, Brno, Czech Republic

Abstract

Presented paper outlines the eating habits and sports activities of the Military University students. High mental and physical demands are put on these students during their studies. This should correspond with their good eating habits. The research shows that a lot of informants do not eat either breakfast, lunch or dinner daily. What is more the intake both of fruit and vegetables tends to be low. The majority of students occasionally perform sports activities in their free time.

Key words: breakfast, lunch, dinner, fruit, vegetables, sports activities

Introduction

University students form a specific population group of mentally working people in the age range from 18 to 26 characterised by typical health and nutritional problems. Most of them appear for the first time out of the reach of their family which tends to influence and sometimes completely changes their lifestyle. Compared to secondary school studies the psychological demands increase especially during the testing period when they can reach a critical point. In addition students of the University of Defence are subjects to many lessons of physical activities aimed at the building-up of their physical fitness for completing demanding fighting tasks besides theoretical and practical lessons.

This paper presents the results obtained by taking anthropometric measurements and questionnaire survey carried out among the students of the University of Defence, in its former part Military University of Ground Forces in Vyškov, Czech Republic.

Methods

50 students of the University of Defence, its former part Military University of Ground Forces in Vyškov became subjects to the research. Students were chosen at random from all five study years. Firstly the basic anthropometric measurements as the body weight and body height were taken. Body weight was taken by personal scales and height by anthropometer. Secondly a body mass index (BMI) was calculated. Thirdly informants filled in a questionnaire created by the Department of nutrition economy and hygiene. The questionnaire consisted from 25 items containing questions about informants' eating habits, drinking regime, cigarette smoking, drinking alcohol and free time physical activities. Informants filled in the questionnaire during one of the theoretical lessons. The survey was anonymous. Students were able to discuss any doubts concerning questions immediately. Thus 100% rate of return of questionnaires was achieved. This paper introduces evaluation of some of the anthropometric measurements as well as some results concerning the questionnaire. This paper presents the answers on some questions from questionnaire only.

Results and discussion

Survey was carried out with 50 informants, 16 males and 34 females. Their age range was between 18 and 26 and the average age was 20.7 ± 2.7 years. The average body weight was 65.7 ± 0.2 which represents the standard weight for both males and females. The majority of students 76% were of this average weight, 5 female students were underweight and 7 male students overweight. On one hand in no female overweight was identified on the other hand in no male underweight was identified neither. The incidence of 5 female students who were underweight shows that the trend for having an ideal figure corresponds with the higher interest in ones body weight in females compared to males. The similar results were introduced by Provazníková et al. (2002).

The first item deals with the frequency of having breakfast in students. For results see Figure 1.

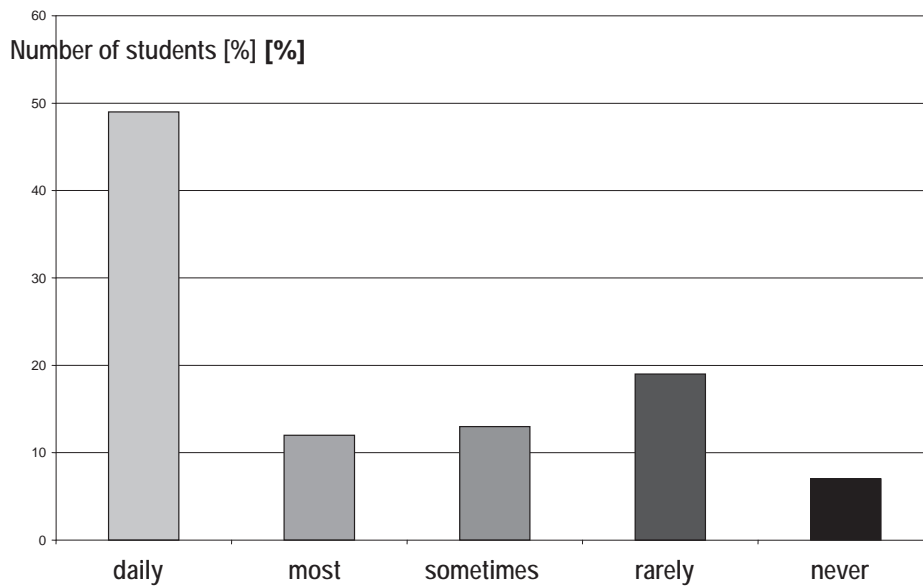

Figure 1: Frequency of having breakfast in students

The above graph indicates that only 49% of students have breakfast and 8% of students never have breakfast. It seems to correspond to their lifestyle when they adapt the time of getting up to the term schedule or to the time spent learning at night in the testing period. Špindlerová et Vodáková (1999) found out even more alarming results in their research, only 42% of informants had breakfast regularly.

The second item deals with the frequency of having lunch in students. For results see Figure 2.

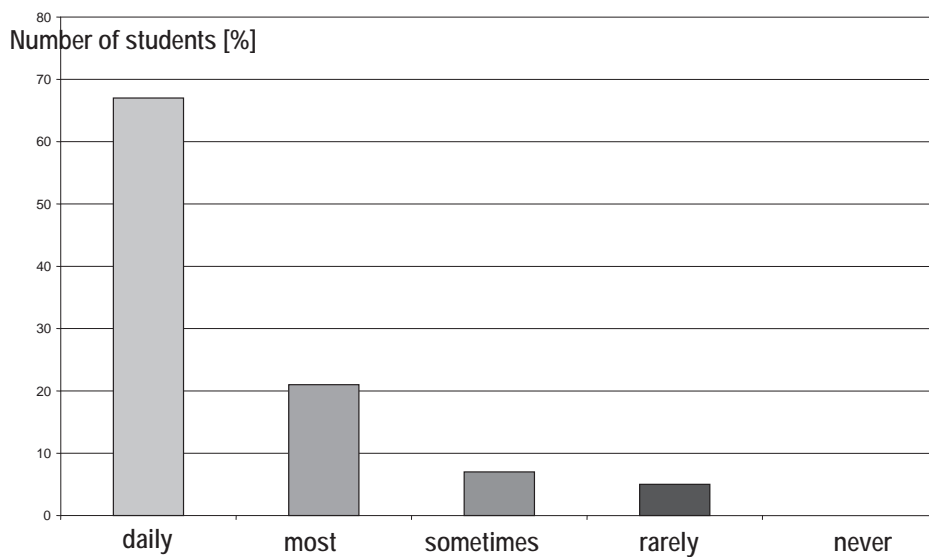

Figure 2: Frequency of having lunch in students

The above graph shows that only 67% of informants have lunch. Due to the psychical and physical demands of the military training the more regular lunch eating would be expected. This assumption is supported by the fact that the everyday lunch is provided by the school canteen.

The third item deals with the frequency of having dinner in students. For results see Figure 3.

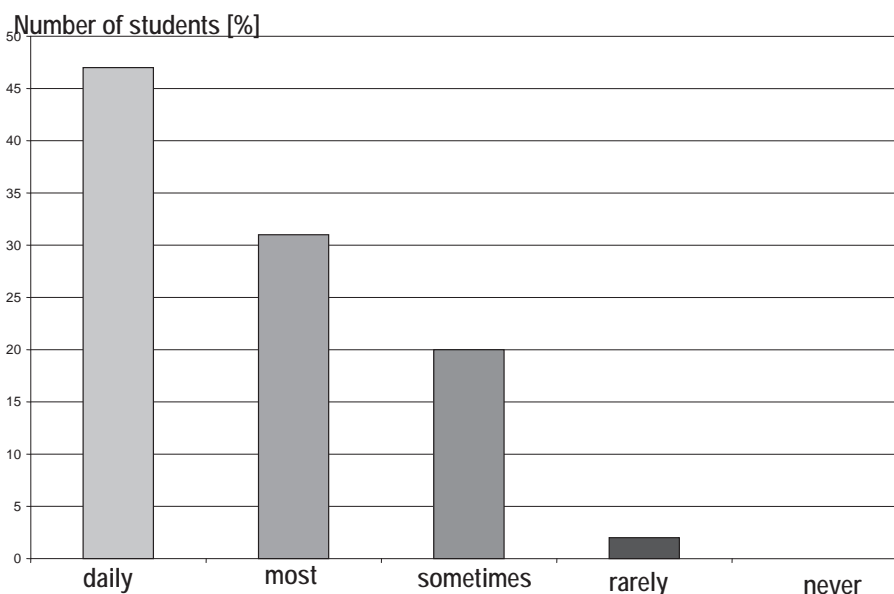

Figure 3: Frequency of having dinner in students

The above graph indicates that only 47% of informants have dinner daily but on the other hand no informant said that he never has dinner. The obtained results did not correspond with the results introduced by Špindlerová et Vodáková (1999) which suggest that the most frequent meal is dinner. These results can be supported by the fact that in this hectic period, families gather at home just to have dinner together. This cannot be identified in informants of current research since they stay in student halls of residence and not with their families.

The following two items deal with the frequency of eating fresh fruit and vegetables. Figure 4 indicates the number of portions of fresh fruit and vegetables eaten by students daily.

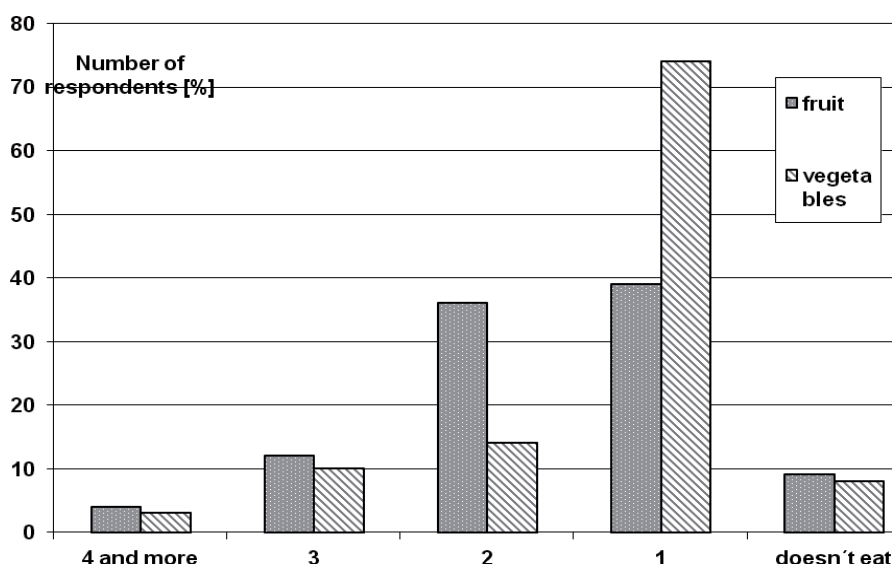

Figure 4: Number of portions of fresh fruit and vegetables eaten by students daily

The above graph shows that most of the respondents 39% eat only 1 portion of fresh fruit and 36%, 2 portions. Concerning the vegetables 73% of informants, which is a majority, eat 1 portion of fresh vegetables daily. The recommended number of portions of fresh fruit and vegetables in scientific literature is 5. Different items of research show the insufficient consumption of fresh fruit and vegetables as stated by Chalcarz et Radzimirska-Graczyk (2008). Wądołowska et al. (2008) declared that most of students eating fruit and vegetables are girls on the ground of slim figure.

The last item deals with the frequency of sports activities performed by informants in their free time. Results can be seen from Figure 5.

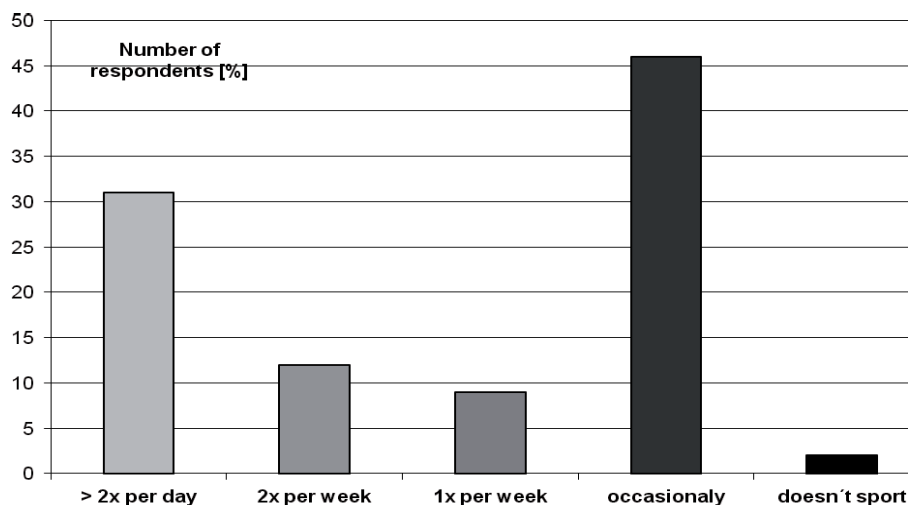

Figure 5: Frequency of sports activities performed by informants in their free time

The above graph suggests that the majority 46% of informants perform sports activities occasionally. On the other hand 31% perform sports activities more than twice a week. This is above the scope of their regular physical training, forming a part of their studies at the University of Defence. Just 2% of informants did not perform physical activity in their free time at all. These results are specific for the University of Defence where the demands for physical fitness are high and are different from the attitude to sports of the students at other civil universities.

Conclusions

In conclusion it is necessary to say that students of the University of Defence do not have regular eating habits. 49% of informants had breakfast regularly, 67% of informants had lunch regularly and less than a half of them – 47% had a regular dinner. Although the informants are students of the University of Defence where the emphasis is put on the good physical condition, less than half of them, exactly 52% perform sports activities in their free time and 46% of students perform physical activities occasionally except for the physical exercise lessons at school.

References

1. Chalcarz, W., & Radzimirska-Graczyk, M. (2008). Ocena preferencji pokarmowych warzyw i ich przetworów wśród uczniów gimnazjum sportowego. *VIII Krajowe Warsztaty żywieniowe "Metody ankietowe w badaniach żywieniowych"* (str. 14). Marózek kol Olsztynka (Poland): University Warmia and Mazury in Olsztyn.
2. Provazníková, H., Schneiderová, D., & Valenta, V. (4. 47 2002). Determinanty zdraví vysokoškolských studentů. *Hygiena*, stránky 214-219.
3. Špindlerová, R., & Vodáková, J. (3. LIV 1999). Názory studentů a žáků odborných škol a učilišť na výživu a jejich současné stravovací zvyklosti. *Výživa a potraviny*, stránky 36-37.
4. Wądołowska, L., Schlegel-Zawadzka, M., Babicz-Zielinska, E., & Przyslawski, J. (S1. 45 2001). Factors influencing food choice among Polish youth. *Annals of Nutrition and Metabolism*, str. 158.

RECIPROCAL AND BILATERAL RATIO OF THE STRENGTH OF DYNAMIC KNEE STABILIZERS IN ACTIVE HANDBALL AND BASKETBALL PLAYERS

Elvir Kazazović, Mensur Vrcić and Erol Kovačević

Faculty of Sport and Physical Education

Abstract

The aim of this research was to evaluate knee extensor and flexor peak torque, total work as well as bilateral and reciprocal ratio. Examinees in this research were students of Faculty of Sport and Physical Education in Sarajevo (age 21.2 ± 2.5 ; height 180.8 ± 6.1 cm; weight 77.4 ± 7.8 kg). All of them were active in sport for 6.9 ± 2.5 years (22 handball players and 27 basketball players). Knee extensors and flexors were evaluated using isokinetic dynamometer (Biodex System 3) at angular velocities $60^\circ/s$ and $180^\circ/s$. The results showed no significant differences in knee extensors and flexors peak torque, total work and agonist and antagonist ratio in dominant and nondominant leg. These results point out that handball and basketball trainings and matches have equal influence on muscle strength and agonist/antagonist ratio, measured by isokinetic dynamometer.

Key words: *Isokinetic strength, muscle balance, knee extensor, knee flexor, handball players, basketball players*

Introduction

Basketball and handball are considered to be some of the most popular sports around the world. There are several complex and strenuous movements in these games which require great effort such as dribbling, duel, sprint, jump, etc. (Reilly Thomas, 1976.) These efforts depend on the strength of neuromuscular system, especially of the lower limbs. (Cometti et al., 2001).

Dynamic knee stabilizers are important in the prevention of injuries as well as in the improvement of knee function. Very often knee stabilizers are injured during the matches, which causes missing a lot of trainings (Muckle, 1981). There are several factors which cause these injuries. Some of them are imbalance in muscle strength of both legs as well as reciprocal ratio of muscle groups. Activities which force only one side of the body (like take off on one leg) can cause asymmetry and dominance of one limb, which finally results in great strength disbalance (Brady et al., 1993). It is proved in all researches that weakness of one leg contributes to the majority of injuries (Reilly, 1996). The difference among reciprocal muscle groups (agonist and antagonist knee stabilizers) presents a threat for the weaker muscle groups. Hypertrophy of knee muscles causes flexor injury (Reilly, 1996). The capability to use both legs equally improves the efficiency of handball and basketball players.

There are researches in comparing the strength of dominant and non-dominant leg with different results. Some researchers point out the symmetry between dominant and non-dominant leg (Brad et al., 1993, Rosene et al., 2001, Siqueira 2002), while others point out a significant asymmetry (Molnar, Aleksandar 1974, Goslin i Charteris 1979, Wyatt i Edwards 1981).

The aim of the research is to define, by isokinetic testing, the influence of handball and basketball trainings and matches on bilateral ratio of dynamic knee flexors and extensors as well as on reciprocal ratio of agonists and antagonists of the left and right leg in students who are active handball and basketball players.

Examinee sample

The examinees for this research were 49 students of Faculty of Sport and Physical Education. Twenty-two of them were active handball players aged 20.8 ± 2.7 ; height 180.8 ± 6.9 cm; weight 78.4 ± 5.1 kg and 7.9 ± 2.4 years of active training. Twenty-seven of them were active basketball players aged 21.2 ± 2.5 ; height 180.8 ± 6.1 cm, weight 77.4 ± 7.8 kg and 6.9 ± 2.5 years of active training.

The frequency of trainings was almost the same in both groups. Active handball players as well as basketball players trained 3 to 5 times a week. The duration of their trainings was almost the same (about 2 hours a day). During the period of contests, the examinees did exercises for muscle strength which use the weight of their body. However, in the preparation period, all of them had specific strength training programmes. Isokinetic testing of dynamic knee stabilizers was performed 15 days before the end of the peak season.

None of the examinees had any knee operation, any kind of knee injury or any injury of locomotor apparatus. Peak torque and total work of knee flexors and extensors were tested on isokinetic equipment (Biodex 3) at angular velocities $60^\circ/s$ and $180^\circ/s$. These angular velocities were used by many researchers in order to examine the strength of dynamic

knee stabilizers (Kellis, Gerodimos, Kellis, Manou 2001; Dauty, Poriton-Josse, Rochcongar 2003; Ergun, Islegen, Taskiran 2004; Kazazović, Rado, Dervišević, Kovač 2007; Kazazović E., Tabaković M. 2008; Kazazović, E., Hadžikadunić A., Kozić V. 2008). These tests were performed in a sitting position. The examinees were given the instructions on how to perform the test. During the performance, the examinees had verbal encouragement.

Before the test performance, the examinees did some warm-up activities (3 submaximal, 1 maximal repetition). The test consisted of peak torque test at angular velocity of 60°/s (5 repetitions), followed by a break (30 seconds), and peak torque test at angular velocity 180°/s (5 repetitions). After testing one leg and making a three-minute pause, the other leg was tested under the same conditions.

Statistical analysis

Paired – Samples T-test was used to compare the peak torque of dependent variables in both legs of basketball and handball players. For all analysis, there was the following statistical significance level $p < 0,05$.

Results

The analysis of the results shows that there are no significant bilateral and reciprocal differences in results except for the results at different angular velocities (60°/s i 180 °/s). Peak torque and total work are higher at lower angular velocity and viceversa. There is no significant relation between dominant and non-dominant side, which points out that peak torque of dynamic knee stabilizers for any od the tested muscle groups do not influence the dominance between the muscle (Table 1).

Table 1: Peak torque (Nm) and total work of knee extensors and flexors at angular velocities 60 and 180 °/s and comperision between left and right leg in handball and basketball players (students of Faculty of Sport and Physical Education in Sarajevo

Angular velocities		Handball players					Basketball players				
		Left leg	Right leg	r	t	p	Left leg	Right leg	r	t	p
Extensors 60°/s	Peak torque	213.98 ± 51	211.87 ± 43	0.867	.791	.465	225.09 ± 34	221.68 ± 34	0.828	.879	.387
	Total work	874.49 ± 158	859.87 ± 171	0.912	.977	.341	941.21 ± 139	900.67 ± 177	0.723	1.712	.099
	Peak torque	138.77 ± 31	137.69 ± 29	0.878	.445	.661	144.87 ± 23	143.24 ± 24	0.861	.685	.499
Extensors 180°/s	Total work	622.38 ± 123	627.48 ± 125	0.759	-.534	.571	669.83 ± 103	638.56 ± 104	0.620	1.807	.082
	Peak torque	118.64 ± 26	121.41 ± 22	0.809	-.862	.399	128.03 ± 21	129.06 ± 22	0.774	-.367	.716
	Total work	583.31 ± 129	592.73 ± 135	0.872	-	.211	615.80 ± 115	637.56 ± 133	0.796	-	.176
Flexors 60°/s	Peak torque	91.68 ± 24	90.4 ± 22	0.834	.427	.658	96.46 ± 23	95.16 ± 23	0.848	.536	.597
	Total work	438.45 ± 123	447.58 ± 131	0.902	-.944	.336	458.53 ± 102	466.33 ± 112	0.790	-	.568
	Peak torque										

Reciprocal ration of agonists and antagonists of dynamic knee stabilizers in both legs of hanball and basketball players is presented in Table 2. Statistically significant differences were not found for this inter-musle ratio in these two groups of examinees.

Table 2: Comparision of inter-muscular ration of reciprocal group in both legs at both angular velocities

Angular velocity	Handball players					Basketball players				
	Left leg	Right leg	r	t	p	Left leg	Right leg	r	t	p
60°/s	55.21 ± 7.1	55.98 ± 7.3	0.630	-	.164	56.02 ± 6.6	56.97 ± 6.6	0.498	-	.461
	64.43 ± 10.1	65.25 ± 8.7	0.687	-.623	.534	64.75 ± 12.7	66.35 ± 11.4	0.739	-	.352
180°/s										

Discussion

The results of this research show similar results of dynamic knee stabilizers in left and right leg for both groups of examinees. This result suggests that strength is linked with demands in sport, in this case with handball and basketball (Zakas et al., 1995). In this research Thostensson et al. found the differences in muscle strength in alpine skier, jumper and sprinter.

All results support the lack of asymmetry between right and left leg for each tested group, which is proved by the following example (Brady et al., 1993, Holmes i Alderink 1984, Gur et al., 1999, Rosenei et al., 2001, Siqueira et al., 2002, te Kazazović et al., 2008). This research also denies the presence of asymmetry (Molnar, Aleksandar 1974, Goslin and Charteris 1979, Wyatt et al., 1981). Muscle asymmetry which occurred in this research in knee flexors and extensors can be a consequence of balanced pressure on both limbs. It seems that the players who were in the training process were adjusted to specific loads equal for both limbs and that they could balance the strength of both sides. During the handball and basketball matches and trainings, the players perform various explosive movements like sprints, jumps, duels and dribblings. In all these activities, both limbs are active equally.

Muscle symmetry which was found in this work of knee extensors and flexors can be caused by strength training which is performed during the preparation period.

Recent researches in reciprocal ratio of dynamic knee stabilizers is shown in the research of Rosene et al. (2001) and Siqueira et al. (2002). In this research, the ratio is on the same level and the only difference is in angular velocities. At greater angular velocities, higher results are noted. At angular velocity 180°/s, the results are higher. In scientific bibliography there are numerous contradictory studies. Some of them point out that angular velocity does not influence the results of muscle ratio and that the results are similar at all angular velocities, taking into consideration correction of gravity (Zakas et al., 2002, Fillyaw et al., 1986). On the contrary, reciprocal ratio is greater at higher angular velocities, when gravity correction is not taken into consideration (Zakas et al., 2002; Fillyaw et al., 1986).

Zakas et al. (2002) confirmed similar indicators at the same angular velocities in professional Greek basketball, handball and football players.

When there is asymmetry in muscle strength between the limbs or in reciprocal ratio of agonists and antagonists, it is suggested to undergo the muscle rehabilitation and improve weaker muscle group in order to make balance between two legs.

According to this research, there is no significant difference between extensors and flexors of dynamic knee stabilizers as well as in reciprocal ratio of agonists and antagonists in both legs. One must be active in handball and basketball training process and matches during a certain period of time (8 years) in order to improve their peak torque and total work. The coaches are suggested to make individual strength programmes for the players who have asymmetry of bilateral and reciprocal muscle groups of dynamic knee stabilizers.

Conclusion

According to the results of this research, there is no significant difference between knee extensors and flexors strength, as well as, there is no significant difference in the reciprocal (agonist/antagonist) ratio in both, dominant and nondominant leg. By active participating in handball and basketball training process and matches during a certain period of time, in this case, time period is 8 years, sportspeople can improve their peak torque and total work values. Reciprocal ratio of knee extensors and flexors do not differ these two groups of examinees. However, based on the earlier findings, coaches are suggested to make individual, additional strength programmes for players with bilateral and/or reciprocal muscle asymmetries. In the case of asymmetry, an appropriate treatment, with the purpose of its removal must be an obligatory part of the strength training programme.

References

1. Cometti G., Maffiuleti N.A., Pousson M., Chatard J.C. and Maffulli N. *Isokinetic strength and anaerobic power of elite, subelite and amateur French soccer players*, International Journal of Sports Medicine 22 (2001), 45-51.
2. Dauty M, et al. (2003). *Identification of previous hamstring muscle injury by isokinetic concentric and eccentric torque measurement in elite soccer players*. Isokinetic and Exercise Science 11(3): 139-144.
3. Ergun M, et al. (2004). *A cross-sectional analysis of sagittal knee laxity and isokinetic muscle strength in soccer players*. International Journal of Sports Medicine 25(8): 594-598.
4. Fillyaw M., Bevins T. and Fernandez L. (1986). *Importance of correcting isokinetic peak torque for the effect of gravity when calculating knee flexor to extensor muscle ratios*, Physical Therapy, 66:23-29.
5. Goslin B.R. and Charteris J. (1979). *Isokinetic dynamometry: normative data for clinical use in lower extremity (knee) cases*, Scandinavian Journal of Rehabilitation Medicine 11, 105-109.
6. Gur H., Akova B., Punduk Z. and Kucukoglu S. (1999). *Effects of age on the reciprocal peak torque ratios during knee muscle contractions in elite soccer players*, Scandinavian Journal of Medicine and Science in Sports 9(2) 81-87.

7. Kellis S, et al. (2001). *Bilateral isokinetic concentric and eccentric strength profiles of the knee extensors and flexors in young soccer players*. *Isokinetic and Exercise Science* 9(1): 31-39.
8. Kazazović, E., Rađo, I., Dervišević, E., Kovač, S., (2007). *Utjecaj trenožnih programa na povećanje max. jačine dinamičkih stabilizatora koljena kod aktivnih sportaša*. *New technologies in sports*. Sarajevo.
9. Kazazović E., Tabaković M. (2008). *Influence of the maximum strength of dynamic knee stabilizers on the field of movable balance, utjecaj maksimalne jačine dinamičkih stabilizatora koljena na motorički prostor ravnoteže*. 5 International scientific conference on kinesiology, Faculty of Kinesiology, Zagreb, Croatia. Septeber 10-14.
10. Kazazović, E., Hadžikadunić A., Kozić V. (2008). *Effects of additional exercise programme performed with Biodex apparatus at the maximal strength of the dynamic stabilization of knee muscles in active handball players*. *Youth sport*, 4th International Symposium, Ljubljana.
11. Kazazović, E., Kozić, V., Hadžikadunić, A. (2008). *Differences in dynamic knee stabilizers strength between football and handball players aged 18 to 22*, Međunarodna naučna konferencija, Teorijski, metodološki i metodički aspekti fizičkog vaspitanja, Beograd.
12. Molnar G.E. and Alexander J. (1974). *Objective quantitative muscular testing in children: a pilot study*, *Archives of Physical Medicine and Rehabilitation* 57, 224-228.
13. Muckle D.S. (1981). *Injuries in professional footballers*, *British Journal of Sports Medicine*, 1637-39.
14. Reilly T. and Thomas V. (1976). *A motion analysis of work-rate in different positional roles in professional football match-play*, *Journal of Human Movement Studies* 2 87-97.
15. Reilly T. *Fitness assessment*, in: *Science and soccer*, T. Reilly, ed., E and FN Spon, London, 1996, pp. 25-49.
16. Rosene J.M., Fogarty T.D. and Mahaffey B.L. (2001). *Isokinetic hamstring:quadriceps ratios in intercollegiate athletes*, *Journal of Athletic Training* 36(4) 378-383.
17. Siqueira C.M., Pelegrini F.R.M.M., Fontana M.F. and Greve J.M.D. (2002). *Isokinetic dynamometry of knee flexors and extensors: comparative study among non-athletes, jumper athletes and runner athletes*, *Revista do Hospital das Clinicas*, 5719-24.
18. Thorstensson A., Larsson L., Tesch P. and Karlsson J. (1977). *Muscle strength and fiber composition in athletes and sedentary men*, *Medicine Science in Sports*, 926-30.
19. Wyatt M.P. and Edwards A.M. (1981). *Comparison of quadriceps and hamstring torque values during isokinetic exercise*, *Journal of Sports Physical Therapy* 3, 48-56.
20. Zakas A., Mandroukas K., Vamvakoudis E., Christoulas K. and Aggelopoulou N. (1995). *Peak torque of quadriceps and hamstring muscles in basketball and soccer players of different divisions*, *The Journal of Sports Medicine and Physical Fitness* 35 199-205.
21. Zakas A., Grammatikopoulou M.G., Vergou A. and Zakas N. (2002). *Gravity effect on the isokinetic peak torque and hamstring to quadriceps ratios in elite basketball, volleyball and soccer players*, *Journal of Human Movement Studies* 42271-289.

THE DIETARY HABITS OF CROATIAN WOMEN BASKETBALL PLAYERS AND MENSTRUAL IRREGULARITIES

Nevia Mavra¹, Gordana Ivković² and Ivan Žderić³

¹Postgraduate student, Faculty of Kinesiology University in Zagreb, Croatia

²University in Zadar, Croatia

³VSPU Baltazar Adam Krčelić, Zaprešić, Croatia

Abstract

Due to the length of sporting activities and competitions throughout the year, women basketball belongs in a category of very demanding and grueling sports. Therefore, the importance of diet in training has an important role because the possibilities for the development of health complications and injuries are related to high physical loads. The aim of this study is to present eating habits of female basketball players in Croatia and their relation to menstrual irregularities. Female basketball players (N = 153) completed a questionnaire about their eating habits and menstrual irregularities. In this study, the maximum value was 45 points. Most of the players (63.4%) had 33.29 points to questions about the frequency of consumption of food and beverages. The results suggest that players often skip meals and reduce food consumption through diet. Those who have better eating habits have less menstrual irregularities. This results indicate that the improvement in dietary habits can avoid nutritional deficiencies and menstrual dysfunctions.

Key words: women basketball, dietary habits, menstrual irregularities,

Introduction

The length of sporting activities, loads in training in different parts of the season, the length of the competition season, rest periods and consumption during training and competitions are factors that determine that diet, nutrition and education, become an integral part of the training process. Although the composition of the body is different in women and men basketball, the basic principles of proper nutrition for both are still the same with minor differences. Basketball male players have a greater need for certain nutrients mainly due to the fact that female are more prone to nutritional deficiencies because of the menstrual cycle, which takes place once a month. The loss of iron (Fe) during the menstrual cycle is between 15 and 30 mg, which means that women in basketball must consume additional 5 mg of iron per day to compensate this loss. Practice shows that a large number of girls is uneducated which can have unpleasant consequences. Anemia in female athletes is not a rare occurrence that may even lead to termination of sporting activities, which is actually a drastic punishment for ignorance (Kulier, I. 2001). During the training of high intensity and duration, adequate to energy needs, food must be taken in order to maintain body weight, increasing the effects of training and maintaining health. Low energy intake can lead to loss of muscle mass, menstrual disorders, loss or failure to obtain bone density, increased risk of fatigue, injury and illness, and it can prolong the process of recovery. Girls and women with a low dietary intake are susceptible to many complications, including fatigue, dehydration, growth delay, reduced immune system, which increases the incidence of upper respiratory tract infections and problems with cell-mediated immunity (Montero et al., 2002). Inadequate nutrition can lead to amenorrhea and delayed puberty. Amenorrhea can also occur due to emotional or physical stress, such as intense training. Amenorrhea occurs more frequently in female athletes (3-6%) compared to the general female population (2-4%) (Manroe, M. 2002nd; Goodman et al., 2005). Female athlete triad can leave severe and long-lasting effects. Characteristics of the triad are the following: amenorrhea, eating disorders and osteoporosis. Gabel (2006.) in his study found that athletes who compete in sports that require a lean look 70.1% are in greater risk for the female athlete triad than in those sports where is not required (55.3%). Due to the low bioavailability of iron in plant nutrition vegetarians his stocks are usually insufficient (Craig, WJ. 1994). In addition, physical activity can increase the need for iron and basketball vegetarian must constantly check the value of iron in the blood. Research in female athletes has shown occurrence of a weakened immune system, and related problems (Gleeson, M. et al., 2004) and disorders of menstrual function and risk of osteoporosis, eating disorders and anemia. Planning a diet for any basketball player should be individualized and complex process in which we must take into account the size and composition of the body, to set goals related to body weight and daily training schedule.

Methods

The sample consists of 79 female basketball players who are competing in the first Croatian league and 74 basketball players who are competing in the second Croatian league. They were investigated for dietary habits and menstrual irregularities using a questionnaire based on national and international studies (Paugh, 2005). Morphological characteristics that were measured are height, body mass and calculated values of body mass index (BMI). The data obtained were analyzed by standard statistical methods package Statistica for Windows 97. We have calculated the basic descriptive parameters: mean and standard deviation. The difference between foreign and Croatian female basketball player first and second leagues is tested by one-way analysis of variance and t-test. The existence of a relationship between dietary habits and menstrual irregularities were tested using Pearson's correlation coefficient.

Results and discussion

Table 1. presents the results of morphological characteristics of female basketball player from which it appears that the basketball players who are competing in the first division have on average 21.9 years, the average height is 179.14 centimeters, weight 70.68 pounds and BMI of 21, 99. Players who compete in the second Croatian league on average have 17.3 years with an average height of 174.14 cm, weight of 64.44 kilograms and a BMI of 20.99. There is statistically significant difference in all measured morphological characteristics between first and second league basketball players, the first league basketball players are elderly, higher and have a higher body mass index.

Table 1: Morphological characteristics of female basketball player

	Rank	$\bar{x} \pm sd$	Minimum	Maximum	t-test
AGE	1. division	21,90±4,89	15,00	40,00	7,05*
	2. division	17,30±2,85	13	27,00	
HEIGHT	1. division	179,14±8,38	157,00	197,00	3,53*
	2. division	174,64±7,33	160	188,00	
WEIGHT	1. division	70,68±8,44	55,00	96,60	4,92*
	2. division	64,14±7,97	43,00	78,00	
BMI	1. division	21,99±1,80	18,00	28,70	3,23*
	2. division	20,99±2,04	15,60	26,00	

* Statistically significant differences at $p < 0.05$

Younger age of female basketball players in second division is justified if it is known that female cadets and junior women Croatian basketball teams, along with a few experienced basketball player, gain competitive experience in this league. Given that this young basketball players are still in development (age range from 13), and probably a fewer number of sessions per week, it is understandable lower weight and body mass index than in the first division female basketball players. A higher body mass index of female basketball player in first division, which is in the normal range, it probably shows a greater muscle mass. Eating habits are established by the respondents answers to questions about the number of meals per day, skipping meals, consumption of certain foods from different parts of the food pyramid, the consumption of liquids and sports drinks and supplements, with a special focus on the specific additives used by athletes.

Table 2: Rating of diatal habits of female basketball player

Rating	All together	%	First division	%	Second division	%
1 (<50%)	3	1,96	1	1,27	2	2,7
2 (50-60%)	33	21,57	19	22,78	15	20,27
3 (61-79%)	97	63,4	68	62,03	48	64,86
4 (80-89%)	18	11,31	78	12,66	8	10,81
5 (90-100%)	2	1,31	79	1,27	1	1,35

Table 2. shows basketball scores assigned to dietary habits which shows that the most frequent rating of "good" as intermediate indicator. However, the rating "good" covers most basketball players who in that range have good eating habits (63.4% female basketball player). Only 1.96% basketball player had poorer dietary habits and excellent dietary habits had only two (1.31%) basketball player.

Table 3: Week frequency of consuming meals determined by questionnaire about consuming food and drinks FFQ with respect to group (% of respondents)

Frequency of consumption	First division	Second division	t-test
3 meals a day %			
never	11,39	10,81	2,10*
1-2 times a week	12,66	18,92	
3-4 times a week	21,52	44,59	
5-7 times a week	54,43	25,68	
Brekfast %			
never	2,53	1,35	1,50
1-2 times a week	10,13	29,73	
3-4 times a week	22,78	8,11	
5-7 times a week	64,56	60,81	
The frequency of skipping meals %			
never	34,18	18,92	-1,58
1-2 times a week	32,91	37,84	
3-4 times a week	20,25	31,08	
5-7 times a week	12,66	12,16	
The frequency of eating between meals per day %			
never	1,27	5,41	0,68
1-2 times a week	26,58	27,03	
3-4 times a week	40,51	36,49	
5-7 times a week	31,65	31,08	

* Statistically significant differences at $p < 0.05$

Table 3. shows the weekly frequency of consumption of food and beverages due to the league. Female basketball players in first division (54.43% of them) have three meals a day, 5-7 times a week while only 25.68% other league female basketball players has three meals each day. The fact that about 11% of them never takes three meals a day, in this case, it is unclear, because it can mean that the entries more and less than three daily meals. Given the importance of proper distribution of meals and increasing physical activity during the day, it is interesting that only 64.56% of the first league female basketball players and 60.81% other leagues, breakfast 5-7 times a week. Further, daily snacks takes only 31.65% female basketball players while most snacks are taken 3-4 times a week (40.51%). It is worrying that 12% of female basketball players skip at least one daily meal 3-4 times a week, of which 20.25% in first league and even 31.08% in second basketball league.

First division female basketball players never skip a meal (34.18%) and in second league 18.92%. Suel E. et al. (2009) who also studied female basketball players, 34.8% of them responded that they have three meals a day, and only 13.4% confirmed to have breakfast every day, 22.3% sometimes, while 36.0% of female basketball players take daily snack. Skipping meals and reduction of food intake, either because of lack of time or because of the aesthetics of the body without the supervision and control of professionals, can cause a decrease in the effectiveness of the basketball game and can lead to major health problems and dangers of eating disorders.



Figure 1: Shows the relationship of dietary habits of Croatian female basketball player

Results of analysis of variance of dietary habits in female basketball players related to the group are shown in *Figure 1*. Croatian basketball players were not significantly different in eating habits, but the first basketball league players have a better habits of second leagues players. Menstrual irregularities were obtained by asking of the year of getting menarche, menstrual cycle regularity, the existence of cramps, bloating, breast tenderness, mood changes and exercise during menstruation.

Table 4: Correlation coefficient eating habits and menstrual status

Correlations Marked correlations are significant at $p < ,05000$ N=236 (Casewise deletion of missing data)	
	HABITS
FIRST MENSTURATION	-0,01
CRAMPS	0,06
MOOD SWINGS	0,09
REGULARITY	0,04
WORKOUT	-0,10

*Statistically significant differences at $p < 0.05$

The correlation between dietary habits and menstrual irregularities has been assessed by using correlation tables showing. No statistically significant correlation is determined. However female basketball players who have better dietary habits have regular periods.

Table 5. shows that menarche at 79.66% basketball players starts from the 12-14-years, at 9.32% basketball players in the ninth and tenth year of life. At 8.47% basketball players (20 basketball players) menarche has occurred from fifteen to seventeen years old, which may indicate on possibility of amenorrhea.

Table 5: Shows the menarche age

Years of menarche	Count	Cumulative Count	Percent	Cumulative Percent
9	1	1	0,42	0,42
10	5	6	2,12	2,54
11	22	28	9,32	11,86
12	49	77	20,76	32,63
13	70	147	29,66	62,29
14	69	216	29,24	91,53
15	11	227	4,66	96,19
16	7	234	2,97	99,15
17	2	236	0,85	100
Missing	0	236	0	100

Results of analysis of variance between age of menarche considering the rank of competition show that female players in second leagues have higher average age of menarche and they are, on average, considerably younger than basketball players in first division (Table 1.) The most common reason for late menarche occurrence in women is considered to be a constitutive factor, but also the lack of reduced meals in some female athletes. However, if strenuous sports training begins in early childhood and there is not enough energy backed by adequate nutrition, it is possible in young athletes to expect later emergence and maturation (Borms and Caine, 2003). Although it is known that regular participation in organized training, in this case basketball, offers a range of health benefits, such as increasing bone density, increasing the chances for an active healthy life (Torres, McGhee, T. 2009), improper and irregular meals at an earlier age during hard training can cause health and menstrual problems.

Conclusion

The results suggest that female basketball players show average eating habits. Basketball players who compete in the first division in the average age of 21.9 years, the average height of 179.14 centimeters, weight of 70.68 kg and an average body mass index of 21.99. Female basketball players who compete in the second Croatian league, on average have 17.3 years with an average height of 174.14 cm, weight of 64.44 kg and a BMI of 20.99. Basketball players of first and second league show statistically significant difference in all measured morphological characteristics, and the first basketball league players are elderly, higher and with higher body mass index. Female basketball players often skip meals and reduce food consumption through diet, they have better eating habits and less menstrual irregularities.

Similar results in other studies (Abood et al., 2004; Chapman, P. and sur., 1997, Suzanne L., et al. 2013; Torstveit, MC; Sundgot - Borgen J., 2005) concluded that by the improving dietary habits nutritional deficiencies that can result in health problems and menstrual dysfunction could be avoid. Female basketball players in Croatia that have better eating habits have regular periods. Basketball players in the second division are significantly younger, have higher age of getting menarche. In the study of Dušek T. (2001.) who investigated female athletes, including basketball players, results show that high intensity training at an early age delays the onset of menarche. Current dietary recommendations suggest the need for education of coaches and players on the proper consumption, energy sufficient food especially during training and matches high intensity in order to avoid the loss of muscle and bone mass, prevent fatigue, reduce the risk of menstrual dysfunction and injury.

References

1. Abood, D.A., Black, D.R., Birnbaum, R.D. (2004). Nutrition Education Intervention for College Female. *Athlete Journal of Nutrition Education and Behavior*, 36(3), 135-139
2. Craig WJ. (1994). Iron status of vegetarians. *Am J Clin Nutr*; 59(suppl):1233S-7S.
3. Chapman P, et al. (1997). *Nutrition* knowledge among adolescent high school female athletes. *Adolescence*. 32 (126): 437-446 (PubMed).
4. Dušek, T. (2001). Influence of high intensity training on menstrual cycle disorders in athletes PubMed - indexed for Medline 42 (1) :79-82
5. Gabel KA. (2006) Special nutritional concerns for the female athlete. *Curr Sports Med Rep* . 5(4):187-91.
6. Goodman LR, Warren MP. (2005). The female athlete and menstrual function. *Curr Opin Obstet Gynecol*. 17(5):466-70.
7. Kulier Ignac, *Prehrana vrhunskih sportaša*, Impress Zagreb 2001
8. Montero, A., et al. (2002). The implication of the binomial nutrition-immunity on sportswomen's health. 56 Suppl 3:S38-41.
9. Paugh, S.L.: Dietary habits and nutritional knowledge of college athletes (2005) Masters Abstracts International, 43-06, page: 2208 California University of Pennsylvania,
10. Suzane L. et al. (2013). Dietary Habits, Menstrual Health, Body Composition, and Eating Disorder Risk Among Collegiate Volleyball Players: A Descriptive Study *International Journal of Exercise Science* 6(1) : 52-62, 2013.
11. Torstveit, M K; Sundgot-Borgen J. (2005). Participation in leanness sports but not training volume is associated with menstrual dysfunction: a national survey of 1276 elite athletes and controls *Br J Sports Med* 2005; 39:141-147
12. Position of the American Dietetic Association, Dietitians of Canada, and the American College of Sports Medicine: Nutrition and athletic performance. *J Am Diet Assoc* 109 (3): 509-527, 2009.

PROMOTING PHYSICAL ACTIVITY AND EXERCISE AS ADJUNCT TREATMENT OF COGNITIVE DYSFUNCTION IN PSYCHIATRIC DISORDERS

Bryan McCormick

Indiana University, United States

Abstract

While psychiatric disorders are characterized by emotional disturbances, cognitive dysfunction is commonly encountered. Research evidence demonstrates that physical activity (PA) and exercise affect cognition in a number of psychiatric disorders. The best evidence supports exercise in slowing age-related decline and rescuing cognitive function in dementing illnesses. Research also suggests that PA and exercise may be beneficial in improving cognition in schizophrenia, depression, and other psychiatric disorders. For many patients, a long period of physical inactivity and decline may have preceded treatment. Thus PA and exercise programs should follow an increasing progression of intensity level while providing interesting and stimulating variety of forms.

Key words: Attention, Executive Function, Social Cognition, Neuroplasticity

Introduction

Although psychiatric disorders are widely recognized as having emotional disturbances, cognitive dysfunction is just as characteristic of most commonly encountered psychiatric disorders. Furthermore, in many disorders the cognitive symptoms are largely untreated by current medications and have significant impact on functional abilities (Millan et al., 2012). In response to these challenges a number of pharmaceutical, psychological and educational therapies have been developed. Recent research using animal models has identified that physical activity and exercise may play an important role in improving cognition. As such, it should be considered as an important adjunct therapy in the treatment of a number of psychiatric disorders. This paper presents some of the key cognitive deficits associated with the most common psychiatric disorders. In addition, a review is provided of the research linking physical activity and exercise to cognitive improvement, as well as proposed mechanisms of action. Finally, implications and recommendations for practice and research are provided.

Cognitive Dysfunction in Common Psychiatric Disorders

Among the most common disorders with cognitive impairments are those associated with aging such as dementia and Parkinson's disease as well as psychiatric disorders such obsessive-compulsive disorder (OCD), post-traumatic stress disorder (PTSD) and schizophrenia. Finally, disorders more typically identified in childhood such as attention deficit hyperactivity disorder (ADHD) and autism spectrum disorders (ASD) also present with significant cognitive deficit. One cognitive function that is disrupted in virtually all disorders is that of *attention* (Millan et al., 2012). In cases such as dementia, ADHD and schizophrenia focused attention is disrupted (Dere, Pause, & Pietrowsky, 2010), yet in disorders such as PTSD and OCD there is a hyperattention to threatening stimuli (Castaneda, Tuuio-Henriksson, Marttunen, Suvisaari, & Lonnqvist, 2008). Another aspect of cognition commonly disrupted in many disorders is that of *executive function*. Executive function is a cognitive component implicated in such activities as planning, decision-making and problem solving (Millan et al., 2012). Executive function also interacts with attention and working memory to permit people to act in non-routine environments. Aspects of executive function are disrupted differently in different disorders, for example children with ADHD demonstrate poor planning (Vaidya & Stollstorff, 2008), cognitive inflexibility is characteristic in ASD (Robinson, Goddard, Dritschel, Wisley, & Howlin, 2009), response inhibition is present in OCD (Burdick, Robinson, Malhotra, & Szeszko, 2008), and schizophrenia demonstrated generalized deficits in many elements of executive function (Kalkstein, Hurford, & Gur, 2010). Finally, *social cognition*, which is a form of higher cognitive function, is also impaired in many common disorders. Social cognition is cognitive process through which people perceive, interpret and respond to the assumed intentions and behaviors of others (Green & Horan, 2010). Such behavior requires the creation of a mental understanding of others' thinking, referred to as theory of mind, as well as both receptive and expressive language skills. Social cognition is markedly impaired in ASD and schizophrenia, but also noted in depressive disorders, ADHD, Parkinson's disease and Alzheimer's disease (Millan et al., 2012).

Animal Models of PA & Cognition

Some of the earliest work to identify the relationship of PA to cognition was identified through a technique that has come to be termed environmental enrichment (van Praag, Kempermann, & Gage, 2000). Environmental enrichment involves providing an enlarged living space, increased social interaction as well as increased physical activity for laboratory animals. Using principally rodent models, physical activity and exercise regimen have been found to improve such cognitive function as spatial memory and learning (da Silva et al., 2012), recognition memory (Vedovelli et al., 2011) and working memory (Langdon & Corbett, 2012) among typically developing rodents. Exercise has also been found to improve cognitive functioning among animals whose cognitive function had been compromised by chronic stress (Kwon et al., 2013), a viral model of schizophrenia (Wolf, Melnik, & Kempermann, 2011), chronic ethanol consumption (Hashemi Nosrat Abadi, Vaghef, Babri, Mahmood-Alilo, & Beirami, 2013) and amyloidosis (Maliszewska-Cyna, McLaurin, & Aubert, 2013). Thus in both normally developing as well as rodents with induced disorders, exercise regimen have been found to have beneficial outcomes for cognition.

Human Trials of PA or Exercise & Cognitive Function

The research to identify the impact of exercise and physical activity on cognitive function among humans is relatively young compared to the research on other non-human animals. For example, no human experiments appear in the research literature prior the late 1970s (e.g., Young, 1979). Given the challenges of cognitive decline in later adulthood, much of the research on PA or exercise and cognition has focused on older adults. One approach to examining the role of PA and exercise on cognitive function has examined this relationship among adults without cognitive impairment. In a review of PA interventions among adults without cognitive impairment Angevaren et al (2009) concluded that aerobic physical activity that improves cardiorespiratory fitness appears to be beneficial to cognitive speed as well as auditory and visual attention. At the same time, effects were not been uniformly demonstrated across all dimensions of cognitive function. A subsequent meta-analysis by Smith and colleagues (2010) concluded that aerobic exercise confers modest cognitive improvements among older adults in the areas of attention and processing speed, executive function and memory. Another approach has been to examine the role of early life PA in later life cognitive impairment. Both retrospective and prospective study designs have been supportive of physical exercise as a preventative or disease modifying effect in later life (Ahlskog, Geda, Graff-Radford, & Petersen, 2011). Among adults with already existing cognitive impairments, PA and exercise have also been found to improve general cognition, executive function and memory (van Uffelen, Paw, Hopman-Rock, & van Mechelen, 2008), and that the effect may be greater among those already experiencing cognitive decline (Smith et al., 2010).

The majority of research thus far examining the connection between PA or exercise and cognition has focused on older adults and dementing illnesses. There is a growing body of research that has also examined this connection in other types of psychiatric disorders. For example, recent randomized clinical trials (RCTs) have examined the effect of exercise on cognitive performance in schizophrenia. The evidence here is ambiguous as one small study found an effect (Pajonk et al., 2010), while a larger follow up study failed to find an effect (Falkai et al., 2013). The research on the effects of physical exercise on cognitive performance is also limited. Among adults with major depressive disorder, exercise has been found to be associated with improvements in attention and inhibitory control (Kubesch et al., 2003; Vasques, Moraes, Silveira, Deslandes, & Laks, 2011) and in one study it was more beneficial than an antidepressant in executive function improvement (Hoffman et al., 2008).

Similarly, there has only recently been interest in PA and exercise in other psychiatric disorders such as ADHD and ASD. Among children with ADHD, moderate to vigorous PA has been found to be associated with better executive function (Chang, Liu, Yu, & Lee, 2012; Gapin, Labban, & Etnier, 2011), improvements in vigilance and impulsivity (Medina et al., 2010) and sustained attention (Verret, Guay, Berthiaume, Gardiner, & Beliveau, 2012). Overall, while findings are consistent with animal models and outcomes in other populations, the current research is notably weak in design (Berwid & Halperin, 2012). As with ADHD, the research on physical activity or exercise and cognitive improvement in ASD is just beginning. In one of the very few trials of physical activity in autism, Anderson-Haley, Tureck and Schneiderman (2011) found that the use of physically active video games resulted in improvements in some aspects of executive function; however, this was based on very small samples with no control condition. Finally, at present there are no identified studies that have examined the relationship of PA or exercise to the disorders of PTSD or OCD.

Potential Mechanisms of Action

Much of the work in the identification of mechanisms of action comes from animal models. Marmeleira (2013) provides a comprehensive review of potential mechanisms. One of the most obvious mechanisms is related to improved vascular fitness. This is characterized as the cerebral circulation hypothesis. Given the large demands of the brain for oxygen and glucose, one mechanism may be that improved fitness results in more efficient delivery of oxygen and nutrients to the brain. In addition, such improved vascular resources also promote angiogenesis, which

while important to improved cognition is not sufficient cause for cognitive improvement (Angevaren et al., 2009). Another likely mechanism appears to be related to change in brain structures such as increased volume of the hippocampus (Ferreira, Real, Rodrigues, Alves, & Britto, 2011). This is an important brain area for cognition due to its role in learning and memory, as well as its role in the expression of the neurotrophin brain-derived neurotrophic factor (BDNF). BDNF and other neurotrophic factors are important in the neuroplastic processes of neurogenesis, synaptogenesis, gliogenesis, and arborization (Kramer & Erickson, 2007). Finally, one hypothesized mechanism posits that through exercise, changes in the availability of neurotransmitters such as dopamine and noradrenaline may reduce depressive symptoms, which as noted above, impair cognitive processes (Marmeleira, 2013).

Implications and Recommendations

There is sound research evidence to suggest that PA and exercise are important factors in aging and cognition. Regular PA provides both a prophylactic effect to cognitive decline and appears to be able to rescue age-related cognitive loss to some degree. The role of PA and exercise in cognitive impairment associated with other psychiatric disorders is less clear. While there is some evidence to suggest that it may have effects to improve cognition in a variety of disorders, the quality and number of supporting studies is quite limited. Another challenge in coming to conclusions about the research evidence in both human and rodent studies has been the variability of intensity and duration of PA interventions. Some studies have examined the role of vigorous exercise on cognition, whereas others have examined overall levels of physical activity. Duration also varies from a single bout to twelve months of exercise intervention. Another challenge in interpreting the research is that only some interventions collected data on both fitness and cognition. Without measuring changes in fitness level, it is difficult to determine if the PA or exercise intervention may have a direct or mediated effect (via vascular fitness) on cognition.

Although there is only modest evidence for the effect of PA and exercise on cognition across all psychiatric disorders, increasing regular PA is warranted. First, from a fitness point of view, many of the cited disorders are associated with sedentary behavior, weight gain and obesity. Increasing regular PA can reduce the impact of such secondary health conditions. In addition, increasing regular PA may also increase the cognitive complexity of the lives of people with these disorders. Marmeleira (2013) noted that “nothing speeds brain atrophy more than being immobilized in the same environment and that the monotony undermines our dopamine and attentional systems crucial to maintaining brain plasticity” (p. 89). Finally, although there may be clear benefits to PA and exercise, adherence is frequently challenging. For some people with psychiatric disorders, a long period of physical inactivity and decline may have preceded their treatment. High intensity exercise programs among such deconditioned clients may add to a low rate of adherence. Thus PA and exercise programs should follow an increasing progression of intensity level while providing interesting and stimulating variety of forms.

References

1. Ahlskog, J. E., Geda, Y. E., Graff-Radford, N. R., & Petersen, R. C. (2011). Physical Exercise as a Preventive or Disease-Modifying Treatment of Dementia and Brain Aging. *Mayo Clinic Proceedings*, 86(9), 876-884. doi: 10.4065/mcp.2011.0252
2. Anderson-Hanley, C., Tureck, K., & Schneiderman, R. L. (2011). Autism and exergaming: effects on repetitive behaviors and cognition. *Psychology research and behavior management*, 4, 129-137. doi: 10.2147/prbm.s24016
3. Angevaren, M., Aufdemkampe, G., Verhaar, H. J. J., Aleman, A., & Vanhees, L. (2009). Physical activity and enhanced fitness to improve cognitive function in older people without known cognitive impairment. *Cochrane Database of Systematic Reviews*(4).
4. Berwid, O. G., & Halperin, J. M. (2012). Emerging Support for a Role of Exercise in Attention-Deficit/Hyperactivity Disorder Intervention Planning. *Current Psychiatry Reports*, 14, 543-551. doi: 10.1007/s11920-012-0297-4
5. Burdick, K. E., Robinson, D. G., Malhotra, A. K., & Szeszko, P. R. (2008). Neurocognitive profile analysis in obsessive-compulsive disorder. *Journal of the International Neuropsychological Society*, 14, 640-645. doi: 10.1017/s1355617708080727
6. Castaneda, A. E., Tuutio-Henriksson, A., Marttunen, M., Suvisaari, J., & Lonnqvist, J. (2008). A review on cognitive impairments in depressive and anxiety disorders with a focus on young adults. *Journal of Affective Disorders*, 106, 1-27. doi: 10.1016/j.jad.2007.06.006
7. Chang, Y.-K., Liu, S., Yu, H.-H., & Lee, Y.-H. (2012). Effect of Acute Exercise on Executive Function in Children with Attention Deficit Hyperactivity Disorder. *Archives of Clinical Neuropsychology*, 27, 225-237. doi: 10.1093/arclin/acr094
8. da Silva, S. G., Unsain, N., Hugo Masco, D., Toscano-Silva, M., de Amorim, H. A., Silva Araujo, B. H., ... Arida, R. M. (2012). Early exercise promotes positive hippocampal plasticity and improves spatial memory in the adult life of rats. *Hippocampus*, 22(2), 347-358. doi: 10.1002/hipo.20903
9. Dere, E., Pause, B. M., & Pietrowsky, R. (2010). Emotion and episodic memory in neuropsychiatric disorders. *Behavioural Brain Research*, 215, 162-171. doi: 10.1016/j.bbr.2010.03.017
10. Falkai, P., Malchow, B., Wobrock, T., Gruber, O., Schmitt, A., Honer, W. G., . . . Cannon, T. D. (2013). The effect of aerobic exercise on cortical architecture in patients with chronic schizophrenia: a randomized controlled MRI study. *European Archives of Psychiatry and Clinical Neuroscience*, 263, 469-473. doi: 10.1007/s00406-012-0383-y

11. Ferreira, A. F. B., Real, C. C., Rodrigues, A. C., Alves, A. S., & Britto, L. R. G. (2011). Short-term, moderate exercise is capable of inducing structural, bdnf-independent hippocampal plasticity. *Brain Research*, *1425*, 111-122. doi: 10.1016/j.brainres.2011.10.004
12. Gapin, J. I., Labban, J. D., & Etnier, J. L. (2011). The effects of physical activity on attention deficit hyperactivity disorder symptoms: The evidence. *Preventive Medicine*, *52*, S70-S74. doi: 10.1016/j.ypmed.2011.01.022
13. Green, M. F., & Horan, W. P. (2010). Social Cognition in Schizophrenia. [Article]. *Current Directions in Psychological Science*, *19*, 243-248. doi: 10.1177/0963721410377600
14. Hashemi Nosrat Abadi, T., Vaghef, L., Babri, S., Mahmood-Alilo, M., & Beirami, M. (2013). Effects of different exercise protocols on ethanol-induced spatial memory impairment in adult male rats. *Alcohol (Fayetteville, N.Y.)*, *47*, 309-316. doi: 10.1016/j.alcohol.2013.01.008
15. Hoffman, B. M., Blumenthal, J. A., Babyak, M. A., Smith, P. J., Rogers, S. D., Doraiswamy, P. M., & Sherwood, A. (2008). Exercise fails to improve neurocognition in depressed middle-aged and older adults. *Medicine and Science in Sports and Exercise*, *40*, 1344-1352. doi: 10.1249/MSS.0b013e31816b877c
16. Kalkstein, S., Hurford, I., & Gur, R. C. (2010). Neurocognition in Schizophrenia. In N. R. Swerdlow (Ed.), *Behavioral Neurobiology of Schizophrenia and Its Treatment* (Vol. 4, pp. 373-390): Springer.
17. Kramer, A. F., & Erickson, K. I. (2007). Capitalizing on cortical plasticity: influence of physical activity on cognition and brain function. *Trends in Cognitive Sciences*, *11*, 342-348. doi: 10.1016/j.tics.2007.06.009
18. Kubesch, S., Bretschneider, V., Freudemann, R., Weidenhammer, N., Lehmann, M., Spitzer, M., & Gron, G. (2003). Aerobic endurance exercise improves executive functions in depressed patients. *Journal of Clinical Psychiatry*, *64*, 1005-1012.
19. Kwon, D.-H., Kim, B.-S., Chang, H., Kim, Y.-I., Jo, S. A., & Leem, Y.-H. (2013). Exercise ameliorates cognition impairment due to restraint stress-induced oxidative insult and reduced BDNF level. *Biochemical and Biophysical Research Communications*, *434*, 245-251. doi: http://dx.doi.org/10.1016/j.bbrc.2013.02.111
20. Langdon, K. D., & Corbett, D. (2012). Improved Working Memory Following Novel Combinations of Physical and Cognitive Activity. *Neurorehabilitation and Neural Repair*, *26*, 523-532. doi: 10.1177/1545968311425919
21. Maliszewska-Cyna, E., McLaurin, J., & Aubert, I. (2013). Effects of voluntary exercise on cognition, neurogenesis, and plaque load in a mouse model of Alzheimers disease. *Faseb Journal*, *27*, 712.733.
22. Marmeleira, J. (2013). An examination of the mechanisms underlying the effects of physical activity on brain and cognition. *European Review of Aging and Physical Activity*, *10*, 83-94. doi: 10.1007/s11556-012-0105-5
23. Medina, J. A., Netto, T. L. B., Muszkat, M., Medina, A. C., Botter, D., Orbetelli, R., . . . Miranda, M. C. (2010). Exercise impact on sustained attention of ADHD children, methylphenidate effects. *Attention Deficit and Hyperactivity Disorders*, *2*, 49-58. doi: 10.1007/s12402-009-0018-y
24. Millan, M. J., Agid, Y., Bruene, M., Bullmore, E. T., Carter, C. S., Clayton, N. S., . . . Young, L. J. (2012). Cognitive dysfunction in psychiatric disorders: characteristics, causes and the quest for improved therapy. *Nature Reviews Drug Discovery*, *11*, 141-168. doi: 10.1038/nrd3628
25. Pajonk, F.-G., Wobrock, T., Gruber, O., Scherk, H., Berner, D., Kaizl, I., . . . Falkai, P. (2010). Hippocampal Plasticity in Response to Exercise in Schizophrenia. *Archives of General Psychiatry*, *67*, 133-143.
26. Robinson, S., Goddard, L., Dritschel, B., Wisley, M., & Howlin, P. (2009). Executive functions in children with Autism Spectrum Disorders. *Brain and Cognition*, *71*, 362-368. doi: 10.1016/j.bandc.2009.06.007
27. Smith, P. J., Blumenthal, J. A., Hoffman, B. M., Cooper, H., Strauman, T. A., Welsh-Bohmer, K., . . . Sherwood, A. (2010). Aerobic Exercise and Neurocognitive Performance: A Meta-Analytic Review of Randomized Controlled Trials. *Psychosomatic Medicine*, *72*(3), 239-252. doi: 10.1097/PSY.0b013e3181d14633
28. Vaidya, C. J., & Stollstorff, M. (2008). Cognitive neuroscience of attention deficit hyperactivity disorder: Current status and working hypotheses. *Developmental Disabilities Research Reviews*, *14*, 261-267. doi: 10.1002/ddrr.40
29. van Praag, H., Kempermann, G., & Gage, F. H. (2000). Neural consequences of environmental enrichment. *Nature Reviews Neuroscience*, *1*, 191-198. doi: 10.1038/35044558
30. van Uffelen, J. G. Z., Paw, M. J. M. C. A., Hopman-Rock, M., & van Mechelen, W. (2008). The Effects of Exercise on Cognition in Older Adults With and Without Cognitive Decline: A Systematic Review. *Clinical Journal of Sport Medicine*, *18*(6), 486-500.
31. Vasques, P. E., Moraes, H., Silveira, H., Deslandes, A. C., & Laks, J. (2011). Acute exercise improves cognition in the depressed elderly: the effect of dual-tasks. *Clinics*, *66*, 1553-1557. doi: 10.1590/s1807-59322011000900008
32. Vedovelli, K., Silveira, E., Velho, E., Stertz, L., Kapczynski, F., Schroeder, N., & Bromberg, E. (2011). Effects of increased opportunity for physical exercise and learning experiences on recognition memory and brain-derived neurotrophic factor levels in brain and serum of rats. *Neuroscience*, *199*, 284-291. doi: 10.1016/j.neuroscience.2011.08.012
33. Verret, C., Guay, M.-C., Berthiaume, C., Gardiner, P., & Beliveau, L. (2012). A Physical Activity Program Improves Behavior and Cognitive Functions in Children With ADHD: An Exploratory Study. *Journal of Attention Disorders*, *16*, 71-80. doi: 10.1177/1087054710379735
34. Wolf, S. A., Melnik, A., & Kempermann, G. (2011). Physical exercise increases adult neurogenesis and telomerase activity, and improves behavioral deficits in a mouse model of schizophrenia. *Brain Behavior and Immunity*, *25*(5), 971-980. doi: 10.1016/j.bbi.2010.10.014
35. Young, R. J. (1979). The effect of regular exercise on cognitive functioning and personality. *British Journal of Sports Medicine*, *13*(3), 110-117.

PHYSICAL ACTIVITIES PROGRAM SUITABLE FOR HEMATO-ONCOLOGICAL PATIENTS - A PILOT STUDY

Zora Svobodova, Alexandra Malá, Radka Adámková, Lenka Dovrtělová, Michal Hrouzek, Andrea Janíková, Katerina Kapounková, Jan Kohout, Pavel Seman, Pavel Stejskal and Tamas Vodička

Faculty of Sports Studies of Masaryk University; Hemato-oncological department of the University Hospital Brno, Czech Republic

Abstract

The aim of the research was to create an intervention program of physical activities suitable for hemato-oncological patients after treatment to continuously improve their physical condition and mental state.

In a 3-month pilot research we were looking for such forms and intensity of physical activities suitable for hemato-oncological patients. Outcome measures are increase in muscle mass and overall physical condition, cooperation in the collective while exercising, an increase of mental toughness and building a relationship of trust between patients and those that participate in the project. Partial results - the selection of physical activities is wide to allow us to compare the results when the pilot program finishes and create a recommended intervention program comprising of physical activities with different focus which will be offered to physicians and patients as a supportive treatment of these diseases.

Key words: intervention exercise program, condition, heart rate monitoring, fitness abilities, core stability

Introduction

Hematology-Oncology Diseases and their treatment have a plethora of side effects which decrease patients' quality of life. The most common side effect is an extreme fatigue, which is related to the subjective condition of a patient since the commencement of the disease, and which may increase in the course of therapy and may last for months or years after the treatment has been discontinued or when in remission. This fatigue is a multidimensional, subjective and objective physiological condition which is characterized by persisting extreme fatigue, decreased capacity for physical and mental activities (patients often fail to perform routine daily activities which leads to a loss of independence, demoralization, pessimism, anxiety, etc.) and an inability to rest or sleep (fatigue is often described as being worse than vomiting, nausea, pain and depression).

The main aim of the intervention exercise program was to increase fitness abilities of patients and prevent the loss of muscle mass which is the result of the illness and treatment. The project team also focused on psycho-social aspect of physical activity and conducted the exercise in a way to change the quality of life of the patients, their approach to their own bodies, to exercise and to sport. In the introductory lessons, instructors were introduced and met the patients and an effort was made to create a pleasant atmosphere and to build trust in the team that was involved in exercises and measurement. During the group interview, both common and different features were identified - most patients spoke about frequent fatigue feelings and a great willingness to participate in the program.

The structure of lessons was then selected in accordance with the three-month pilot research - to increase fitness abilities of the patients. Due to generally accepted rules, the structure of particular parts of a lesson was comprised of introductory part, the main part and conclusion. These three parts should always be included in any exercise program (Dovalil, 2002).

Description of the observed set

Seven patients were included in the pilot program (5 women and 2 men) and they attended a three-month exercise program three times a week, i.e. 30 lessons. The attendance ranged between 75 and 100% with one female patient terminating her attendance due to health reasons.

Patients with haematological malignancies treated with systematic anticancer therapy were recruited from the Haematology and Oncology Clinic of University Hospital Brno, Czech Republic. Eligibility criteria included, among others, histologically confirmed haematological malignancy and received chemotherapy before enrolment of the patients. Of seven patients included in the pilot study, 2 suffered from Hodgkin lymphomas, 3 from non-Hodgkin lymphomas, and 2 from leukaemias.

Physical fitness, fitness abilities

Fitness is sometimes used to refer to a good health condition - in our case this was optimal health state considering the disease as well as the ability to overcome obstacles easily, quickly, strongly and dexterously. Fitness may be identified as a state of an organism which is prepared or adapted to a particular performance. Physical fitness may be divided into health-related-fitness and performance-related-fitness. The project team focused on the former. This is identified as fitness which directly (and indirectly) influences person's health, acts as prevention, particularly against physical and mental issues related to hypokinesia – low active muscle work and other organs and systems (musculoskeletal apparatus, neuromuscular control system, neuroendocrine system, energy metabolism, transport system - circulatory and respiratory system, metabolism, water and minerals, etc.) (Novotný, 2014).

Suchomel (2006) prefers the terminology which is closer to anthropometrics and the practice of physical education, e.g. aerobic (cardio-vascular) fitness, body composition, muscular strength, endurance and flexibility. For exercises whose main purpose is to improve or maintain good health or to increase physical fitness and performance it is necessary to measure heart rate carefully. Therefore, during the course of aerobic exercises, heart rate monitors (Polar RS100, China) were used to monitor heart rate. This gives the number of heart beats per minute. This is also the only unit which accurately describes the exertion on organism during sport and other activities. Physical activities and sports were selected to be beneficiary for organism, not to put an extreme exertion on it. To increase heart and respiratory system activity high intensity of exercises is necessary. Instructors conducted the exercises so that patients could, according to their heart rate monitoring, change the intensity of their exercises so that their heart rate was between 65 and 90% of the maximum heart rate. As the program was comprised of three lessons a week, each for the duration of 60 minutes, a sufficient exercise was ensured to increase fitness. Utilizing the sports facilities of the Faculty of Sports Studies the following were included in the lessons: SPINNING program, rowing, Crosscountry trainer, walking on treadmill, dancing, body styling, gymball exercises, BOSU® (BOSU® Balance Trainer, USA), badminton and table tennis.

Outcome measures

- Heart rate is the main functional indicator. In healthy individuals, it shows a linear increase with the increasing intensity of physical exercises until submaximal intensity is reached.
- We have chosen power level 60% and 75% of the maximal individual heart rate for each patient in order to increase physical fitness.
- Observation of body composition showed the impact and results of exercise programs. Bioimpedance method is non-invasive and safe. It is quite resilient towards human error (Bunc, 2001) at the early stages of physical exercise program.
- The Borg Rating of Perceived Exertion Scale is used to measure perceived exertion i.e. the intensity of physical exertion. An individual assesses his/her feelings during exertion and these are entered in a protocol. This scale is used to assess clinically relevant symptoms, to estimate labor activities, to assess the success of therapy and rehabilitation and to assess daily activities in various epidemiological researches (Borg, 1982).

Physical activities specification

Spinning

SPINNING Program has been selected in the pilot study as an essential aerobic exercise in cardio training. An exercise lesson was 60 minutes long and took place three times a week for 3 months. SPINNING lessons were placed at the initial stage of the exercise. This is a fitness exercise based on group ride on stationary bicycles (SPINNERS) to music.

Cardio Zone

The advantage of exercise on various cardio trainers is that it exercises correct movement stereotypes of human locomotion - walking, running, stair climbing, cycling and rowing. Physical activities on treadmill and country cross and rowing trainers support maximally the development of endurance and strength.

Bodystyling

The program needed such exercise which would form and strengthen the whole body. Therefore, bodystyling has been selected. Exercises were focused on forming of muscle groups of the whole body with a special emphasis on the workout of thighs, bottom and stomach muscles. Bodystyling is suitable for individuals of various ages and fitness. This is also the reason why this exercise has been selected - due to the variety of patients - different ages and sport background.

Dancing

Simple dance elements have been used which focused on various types of natural movement with the aim of gradual development of exercise abilities in accordance with music and one's own feelings. During exercising, physical fitness is naturally growing, the body core strengthened - CORE stability and the whole body is relaxed to various rhythms.

Shaking

Another alternative for cardio exertion was “*shaking*” - shaky movements of the whole body or some parts. Shaking is done to music in rapid rhythm. As patients reached their recommended heart rate quite quickly, and this exercise is relatively easy and effective for cardio-respiratory endurance, we will continue to expand this alternative method of exercise.

SM System

This original method (Smišek, R., 2011) is used for functional stabilization and mobilization of the spine. This is an exercise for spine treatment and regeneration using elastic rope. SM system exercises help to create aligning posture, eliminate muscular imbalances and strengthen weak muscles. These exercises also help a balanced exertion of muscles which support the spine and it also relaxes these muscles. It allows a good quality relaxation of exerted muscles which shortens the time needed for regeneration.

Balance exercises

These are exercises aimed at correcting body posture, they include exercises when standing, sitting, and lying on a gymball. All these exercises are aimed at weakened muscles and stretching those muscles with a tendency to shorten. Gradually, other exercise equipment will be included, e.g. BOSU®.

Exercises with Pilates elements

Pilates is suitable for any age and level of fitness. Pilates is particularly useful for the correction of wrong body posture. During this exercise, the patients were taught to check their posture and perceive balance and exercise the body core muscles which help the correct posture. While exercising, the aim is to perceive one's body as a whole. It is important to focus on surface muscles as well as on internal muscles exercises which are usually omitted in other types of exercise.

BOSU®

BOSU® is a Balance Trainer which has been used to exercise and strengthen cardio-vascular system and to strengthen the body core. BOSU® is used to improve body posture and movement coordination as well as the ability to keep balance necessary for good sport performance and rehabilitation. BOSU® exercises are focused on all muscle groups, it exercises postural and phasic chain muscle systems in a quick, safe and complex way.

Partial results

The actual exercise was 50 minutes long on average. Initial and final part of each lesson was spent warming-up and stretching of main muscle groups. Spinning was the main aerobic exercise. Alternatively, rowing trainer or elliptic crosstrainers were included in this program as well as a 15-minute dance, shaking, badminton and table tennis. Another part of each exercise was resistance exercise utilizing one's own body - bodystyling and selected Pilates exercises included in workout length. For a complete strengthening of the muscles of the whole body, particularly the Core stability, improvement of locomotor coordination and balance, correct posture and improvement of physical fitness, in about 20% of the lesson exercises on BOSU® were included as well as exercises on gymballs. SM-system exercises were used to compensate for muscle imbalances.

Table 1: Exertion intensity during endurance exercising

	x	SD
monitoring length (min)	36.59	6.07
heart rate start (min ⁻¹)	91.34	10.61
heart rate max (min ⁻¹)	149.51	18.03
average heart rate during exercising (min ⁻¹)	126.59	14.2
exercising in the zone (%)	46.49	18.4
exercising over the zone (%)	28.47	24.18
exercising below the zone (%)	25.04	20.27

During the course of aerobic exercises, Heart rate monitoring was used to monitor heart rate (Table 1). Average exertion was around 60% and for most of the time (75% on average) exertion intensity did not drop below the lower limit of the recommended extent of exertion.

This corresponded to the subjective assessment of exertion (Borg RPE) which was a little over 12 on average which ranged from “light” to “somewhat hard”. During the course of the lesson, RPE average values increased slightly. When intervention ended, 6 patients (one of the patients discontinued the intervention) were asked 7 question for final assessment. On a scale of 0 to 10, majority of the patients were satisfied with the work of instructors (one 9, the rest of the patients gave 10 points) and with the atmosphere within the group (one 8, the rest gave 10 points). The content of lessons was also highly praised (4 times 10 points). The best result is the high assessment (mostly 9 points) of the influence of exercises on the patients’ well-being. Patients also appreciated learning new types of exercises (7 to 10 points). Bigger difference in responses and a little lower assessment was received in questions concerning the improvement of physical fitness and the difficulty of exercises (5 to 8 points).

The conclusion drawn from the questionnaire is that a well-planned and good-quality group exercise was helpful for the patients, interesting and it significantly improved their well-being.

The patients were given questionnaires immediately after the lesson to subjectively assess the instruction, content, difficulty and overall satisfaction with the exercises. Patients indicated their assessment on a scale of 0 to 10.

The results regarding changes in body composition (Table 2).

Table 2: Basic Somatometric parameters

Parameter	Before intervention		After intervention		Difference	p
	x	SD	x	SD		
Weight (kg)	87,58	19,99	88,42	19,41	0,83	0,1495
Body height (m)	1,76	0,10	1,76	0,10	0,00	1,0000
BMI (kg.m ⁻¹)	28,20	5,75	28,42	5,56	0,22	0,2176
Fat (%)	31,37	9,29	31,42	9,17	0,05	0,8417
Fat(kg)	27,63	11,94	27,92	11,61	0,28	0,2782
Muscles (%)	38,14	5,71	38,18	5,61	0,04	0,8116
Muscles (kg)	33,43	10,08	33,78	9,75	0,35	0,3227

Conclusion

After the end of this pilot study, it may be concluded that, based on the findings, a regular physical activity is a suitable recondition tool for hemato-oncological patients to gradually restore their fitness abilities and for their overall physical and mental well-being. The group, with some new members, will continue to exercise. The next stage of this research will focus on the creation of fitness program suitable for home, individual exercising of patients who lack means to exercise with an instructor.

The conclusion drawn from the questionnaire is that a well-planned and good-quality group exercise was helpful for the patients, interesting and it significantly improved their well-being.

References

1. DovalilL, J.(2002). Performance and training in sport. Praha: Olympia. ISBN 80-7033-760-5
2. Suchomel, A. (2006). *Physical fitness of children of school age (motor evaluation, the main factors of occurrence, fitness programs)*. Liberec : TU
3. Bunc, V. st al.(2001). *The possibility of establishing somatometrical parametrs children bioimpedance method. Proceedings of the Movement and Health*. Olomouc: U.P.
4. Novotný,J. <http://www.fsps.muni.cz/~novotny/Hypokin.htm> 17.3.2014
5. Smisek, R. http://smsystem.eu/index.php?option=com_content&view=article&id=61&Itemid=59&lang=cs17.3.2014
6. Mustian KM, Morrow GR, Carroll JK, Figueroa-Moseley CD, Jean-Pierre P, Williams GC. *Integrative nonpharmacologic behavioral interventions for the management of cancer-related fatigue*. *The Oncologist* 2007;12(Supplement 1):52-67.
7. Borg, G. (1982) *Psychophysical bases of perceived exertion*. *Medicine and Science in Sports and Exercise*, 14 (5), p. 377-81

SCREENING OF YOUNG WOMEN FOR DIABETES MELLITUS TYPE 2 USING BODY MASS INDEX: THE ROLE OF A KINESIOLOGIST

Dorjana Zerbo Šporin

Applied kinesiology, University of Primorska, Koper, Slovenia

Abstract

The incidence of central obesity related diabetes mellitus type 2 is rising. The risk for developing this illness can be reduced by healthy lifestyle, especially if it starts at a young age. Easily obtainable anthropometric parameters to identify critical adiposity could be useful for population screening. The present study has shown that body mass index (BMI) significantly correlates ($p < 0.001$) with waist circumference (WC), the increase of which may be indicative for the diagnosis of glucose metabolism disorders. BMI of 28 kg/m² or higher indirectly indicates the WC of clinical importance. BMI is routinely calculated in sports and wellness centres as well outdoors, so it can be widely used to assess the risk for type 2 diabetes. We conclude that a kinesiologist has the possibility to identify and to direct individuals with increased probability of metabolic diseases using very basic anthropometric tools in daily practice.

Key words: *primary prevention, abdominal obesity, waist circumference, anthropometry, glucose metabolism disorders*

Introduction

The incidence of type 2 diabetes has risen dramatically and is set to increase further. The number of cases worldwide in 2000 among adults was estimated to 171 million and is expected to approximately double by 2030. In association with high diabetes prevalence, the proportion of deaths due to cardiovascular diseases and other complications related to diabetes (Wild et al., 2004) will inevitably increase. Special attention should be paid to the youth, since they have shown a profound effect of obesity/type 2 diabetes on vascular diseases (Gungor et al., 2004). The risk for the onset of type 2 diabetes can be reduced by preventing abdominal obesity and physical inactivity. A combined intervention of individualised physical activity programme and a diet can reduce the risk for type-2 diabetes by approximately 50% in overweight subjects with impaired glucose intolerance (Tuomilehto et al., 2001). Such interventions could be implemented also by a kinesiologist who has the possibility to identify individuals at risk among people s/he meets during daily practice. It is well known that waist circumference (WC) highly correlates with abdominal adiposity and is a reliable clinical parameter for glucose metabolic disorders (Janssen et al., 2004). Furthermore, an exact determination of WC requires a quite complex way of measurement, taking into account the anthropometrical points in front/on the side of the abdomen, and the measurements should be made in a separate room. The body mass index (BMI) still remains the standard for determining obesity. BMI as a simple anthropometric index, easy to compute from body weight and height, is also useful in sports centres and outdoors. Based on these facts, the aim of our study was to define whether there was a significant relationship between BMI and WC in Slovene female students, thus allowing the use of BMI instead of WC to predict the risk for type 2 diabetes. Identified individuals at risk should be immediately involved in therapeutic protocols; physical activity intervention and the appropriate diet have to be prescribed.

Methods

169 female students, in average 22 years old, visiting various faculties of the University of Ljubljana, Slovenia were anthropometrically examined. A research was carried out at the Department of Biology, Biotechnical Faculty in Ljubljana. All the participants voluntarily participated in the study and an informed consent was obtained. All measurements were taken by the same examiner in a quiet, properly illuminated and thermally neutral environment. The participants were wearing light indoor clothing. Body height (BH) and body weight (BW) were measured according to the standardised International Biological Programme protocol. Each subject's height was determined in Frankfurt's plane and bare feet to the nearest 0.1 cm using a Martin's anthropometer (SiberHegner, Switzerland). BW was measured on Tanita TBF-305 (Tanita Corporation, Arlington Heights, IL) to exactly 0.1 kg, wearing light clothes and no shoes (Weiner and Lourie, 1989). BMI was calculated as the ratio between body weight (kg) and squared height (m²). Waist circumference was valued using a flexible inextensible tape and expressed accurately to 0.1 cm. WC was estimated halfway between the costal edge and the iliac crest on the side and between processus xyphoideus and umbilicus in the front (Tran and Weltman, 1989). A cut-off point of 80 cm for WC was used for identifying individuals with moderate risk for cardio-metabolic disorders

linked to abdominal obesity. Pearson's correlation coefficient (r) was determined to investigate the relationship between WC and BMI values. Statistical analysis was performed on SPSS. A $p < 0.050$ was considered as significant.

Results

As shown in figure 1, there is a significant linear correlation between WC in BMI ($r = 0.79$, $p < 0.001$) of young adult females, suggesting the possibility to estimate WC from body height and weight. BMI explains 63% of variance for WC in female students. The expressed relationship $1.65\text{BMI} + 33.74 = \text{WC}$ determines, that BMI of 28 kg/m^2 or more indicates waist circumferences (80 cm and over) of clinical importance.

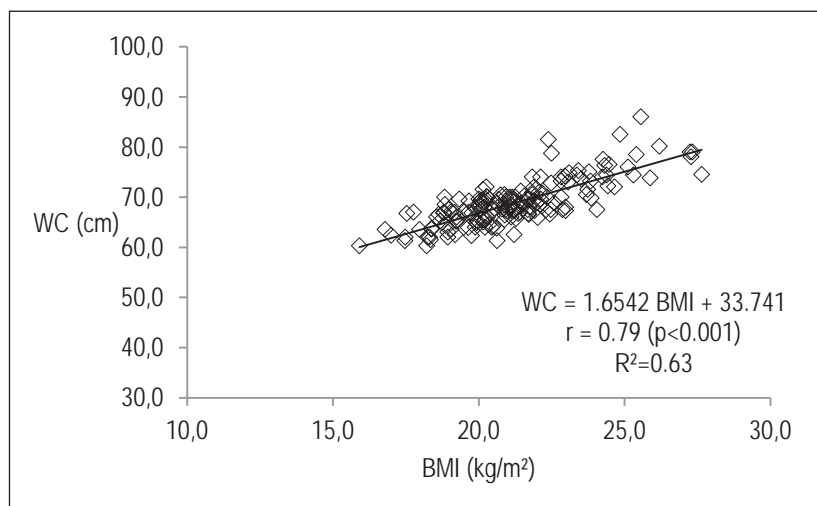

Figure 1: Linear relationship between body mass index and waist circumference for 169 female students

Discussion and conclusions

By considering the observed increase in prevalence of abdominal obesity as an important risk factor for type 2 diabetes, the last should in the near future be addressed as an epidemic (Wild et al., 2004). Easily obtainable anthropometrical parameters to identify critical adiposity and a co-related risk could be useful for screening, also outside medical institutions. Kinesiologists in sports centres can play an important role in the early diagnosis of elevated risk for type 2 diabetes, especially in young subjects. Of particular concern is the excess weight that occurs already among the youth, because it increases the likelihood of obesity and related diseases in adulthood. Elevated WC is established as a reliable clinical parameter for the glucose metabolic disorders prognosis (Janssen et al., 2004). But WC measurements could be less practical, especially outside. An exact determination of WC requires a separate room and a quite complex measuring protocol, taking into account anthropometrical points in front and on the side of the abdomen. This study has demonstrated that BMI as a simple anthropometric index, also routinely calculated in sports and wellness centres, can be applied instead of WC to predict the risk for type 2 diabetes. In fact, a significant linear correlation between WC and BMI was found ($r = 0.79$, $p < 0.001$), suggesting the BMI values of 28 kg/m^2 or higher were indirectly estimated at clinically important WC of 80 cm and higher for at least female students. We conclude that using simple anthropometrical tools like BMI, a kinesiologist can play an important role in the clinical screening of large samples for the risk of metabolic diseases, such as type 2 diabetes. Special attention should be put on young subjects. Individuals at risk have to be addressed to a general physicians and evidence based physical activity protocol for weight reduction should be prescribed. The limitation of the study: the correlation between WC and BMI should be tested for both sexes and all age groups to evaluate the clinical usefulness of BMI in the entire population.

References

1. Gungor, N., Thomson, T., Sutton-Tyrrell, K., Janosky, J. and Arslanian, S. (2004). Early Signs of Cardiovascular Disease in Youth With Obesity and Type 2 Diabetes. *Diabetes Care*, 28(5), 1219-1221.
2. Janssen, I., Katzmarzyk, P.T. and Ross, R. (2004). Waist circumference and not body mass index explains obesity-related health risk. *American Journal of Clinical Nutrition*, 79, 379-384.
3. Tran, Z.V. and Weltman, A. (1989). Generalized equations for predicting body density of women from girth measurements. *Medicine and Science in Sports and Exercise*, 21(1), 101-104.

4. Tuomilehto, J., Lindström, J., Eriksson, J.G., Valle, T.T., Hämäläinen, H., Ilanne-Parikka, P., Keinänen-Kiukaanniemi, S., Laakso, M., Louheranta, A., Rastas, M., Salminen, V., Aunola, S., Cepaitis, Z., Moltchanov, V. Hakumäki, M., Mannelin, M., Martikkala, V., Sundvall, J. and Uusitupa, M. (2001). 5. Prevention of Type 2 Diabetes Mellitus by Changes in Lifestyle among Subjects with Impaired Glucose Tolerance. *The New England Journal of Medicine*, 344, 1343–1350.
5. Weiner, J.S. and Lourie, J.A. (1996). *Human biology: a guide to field methods*. Oxford: Burgess and Son Press.
6. Wild, S., Roglic, G., Green, A., Sicree, R. and King, H. (2004). Global prevalence of diabetes: estimates for the year 2000 and projections for 2030. *Diabetes Care*, 27(5), 1047–1053.

RESEARCH ON THE NEUROBIOLOGICAL CHARACTERISTICS OF THE CHINESE ELITE TRAMPOLINE ATHLETES

Weiwei Zhou, Haitao Chen and Dongjian Li

Chinese Institute of Sports Science, Beijing, China

Abstract

Objective: The aim of this study was to explore the brain functional state and the brain neurotransmitters of the Chinese elite trampoline athletes preparing for the Beijing Olympics Games. **Methods:** By means of EEG and Encephalofluorograph (SET), 10 key athletes in the Chinese Trampoline Team were monitored. **Results and conclusions:** (1) In whole team, both the brain arousal index level and the brain energy ratio of the optional movement were slightly higher than of compulsory movement; the data which fluctuated within a certain range suggested that the exercise load bored in the athlete's brain was not identical at different training stages. (2) In the 3rd monitoring, the values of DA, 5-HT, INH and EXC were minimum, while whole-brain coordination parameter appeared the lowest point in the fourth monitoring. (3) DA and the brain energy ratio of the optional movement had correlation; ACh correlated with the brain arousal index of the optional movement; both 5-HT and ACh were highly correlated with the brain coordination parameter.

Purpose

Trampoline was one of newly rising Olympic events. Although Chinese trampoline project started late, it was still in the advanced ranks in the world. Trampoline belonged to showing off difficulty and beauty group. One complete routine required that the athletes performed 10 different flips and twists in the air before hitting the trampoline in less than 2 minutes. To perform a routine, a high exercise quality for athlete was required, which included the ability of the central nervous system's control and determination. The exercising load of athletes in training resulted in strong stimulation and stress to the central nervous system. That how to monitor and regulate promptly the state of the central nervous system, especially the brain state, ensured the athlete's brain gaining effective training and being in the best state in various competitions was the more difficult part in Trampoline training monitoring. This study was that monitored the brain function state of the athletes in the Chinese Trampoline Team who prepared for the 2008 Beijing Olympics, in order to explore the neurobiological regularity and characteristics of the central nervous system of the trampoline athletes, and to provide a basic for related services.

Methods

- 1.1 Participants: The participants were 11 major athletes who prepared for the Beijing Olympic Games, including 5 men and 5 women, in the State Trampoline Team. The average age was 19.60 ± 1.67 (male) and 19.80 ± 1.30 (female).
- 1.2 Testing place and time: In October 2007, January, March and July 2008, 4 tests carried out at the Beijing Gymnasium and Beijing Sports University. The first testing took place on 1~2 weeks before the World Cup, the second testing was in the middle of the winter exercising, the third test was in before the end of the winter exercising, and the last time took place in 2008 July, before the athletes came into the Olympic Village
- 1.3 Instruments: QDBS1018 Quantitative Digital Electroencephalography (Solar Electronic Technologies Co., Ltd, Beijing). The analysis software was "Solar System SOLAR2000" and "SET Advancing EEG Analysis System" (Solar Electronic Technologies Co., Ltd, Beijing).
- 1.4 Methods: According to the international 10-20 lead system^[1], the EEG of athletes was recorded continuously. In the whole recording process, athletes were required sitting silently with closing eyes.
- 1.5 Indexes: Arousal index, brain power spectrum energy ratio, brain neurotransmitters (Inh, Exc. 5-HT, DA, NE and ACh)

The final data on the neurotransmitters obtained by the "SET Advancing EEG Analysis System" were automatically calculated based on both the measured value and the corresponding data stored data in the model library in the system, which depended on the frequency in the quantization array in a certain time^[2].

- 1.6 Statistical analyses: The data were analyzed by using the SPSS for Windows 16.0 (SPSS Inc. USA) statistical package. The data were presented as mean \pm sd. t-test and ANOVA were performance to evaluate differences between and within trail. The significance level was set at $P < 0.05$.

Results

2.1 The brain arousal index, brain power spectrum energy ratio of trampoline athletes

The brain arousal index reflecting the level of the brain excitability reached the international master reference value (>33%) [3-5], furthermore the index when recalled the optional movement was slightly higher than when recalled the compulsory movement. The brain energy ratio to reflect the influence of the training load on the brain when recalled the optional movement was slightly higher than when recalled the compulsory movement as well. These data suggested that the athletes' brain borne dissimilar training load in different training phase, but they were in the moderate range. The data were not statistically significant between male and female athletes. See Tab 1.

Table 1: The brain function evaluation of the Chinese elite trampoline athletes

Time	Gender	N	Brain arousal index		brain power energy ratio	
			compulsory movement %	optional movement %	compulsory movement	optional movement
1 st	male	5	34.56±2.23	37.40±3.12	2.750±0.471	3.041±0.391
	female	5	37.67±2.48	39.37±2.01	3.055±0.698	3.340±0.735
2 nd	male	5	34.28±2.41	36.52±1.89	2.749±0.459	2.809±0.492
	female	5	32.10±2.48	35.31±3.96	3.006±0.449	3.291±0.523
3 rd	male	5	29.18±1.38	33.44±3.88	2.769±0.239	3.004±0.490
	female	4	32.42±2.41	33.69±1.90	3.010±0.133	3.114±0.224
4 th	male	2	36.91±0.17	40.97±0.78	3.310±0.440	3.508±0.500
	female	3	38.04±1.22	39.45±2.86	3.346±0.493	3.365±0.619
Total	male	17	33.17±3.30	36.39±3.58	2.820±0.411	3.020±0.467
	female	17	34.55±3.51	36.52±3.63	3.079±0.440	3.264±0.490

2.2 The whole brain level of the transmitters in the trampoline athletes

In statistical analysis, the value of a neurotransmitter in a same test was no significant difference between the male and the female athletes, and the trends of the values of various neurotransmitters were coincident in different time point. The results indicated that the activity of the brain neurotransmitter was not affected by gender. The lowest values of DA, 5-HT, INH and EXC were occurred in the third test, however, the highest values were not in regularity. In the 6 neurotransmitters, INH rather than the other 5 neurotransmitters changed significantly (Tab 2).

Using correlation analysis among the brain arousal level, the brain energy ratio and the neurotransmitters, the data showed that both the ACh related to the brain arousal index when recalled the optional movements and the DA correlated with the brain power ratio when recalled the optional movements (Table 3).

Using correlation analysis among the neurotransmitters, there was significant correlation between the DA and 5-HT (Table 4).

2.3 The brain neural coordination of the trampoline athletes

The brain coordination, which reflected the activity synchronization and the ability of synergy in various regions of the brain, fluctuated in small range at a higher level in both male and female athletes.

The data of male was slightly higher than that of female, but there was no statistically different. See Table 5.

Using correlation analysis, the brain cooperativity was related to 5-HT and Ach significantly (Table 6).

Table 2: The whole brain level of the transmitters in the trampoline athletes

Time	gender	N	INH	EXC	5-HT	DA	NE	ACh
1 st	Male	5	5.73±4.14	9.51±7.98	10.34±9.20	13.77±11.12	6.32±3.02	7.01±5.35
	Female	5	11.96±5.98	7.49±4.28	10.40±8.30	14.84±6.70	12.30±9.69	11.49±8.98
	Total	10	8.84±7.25	8.50±6.13	10.37±8.26	14.31±8.68	9.31±7.97	9.25±7.76
2 nd	Male	5	16.12±8.60 ^{aa}	10.83±3.73	11.48±6.09	13.32±5.65	11.17±5.09	12.35±8.43
	Female	5	23.61±12.36 ^{aa}	15.23±9.07	8.04±2.71	8.41±5.20	7.12±5.19	10.43±6.72
	Total	10	19.86±10.79 ^{aa}	13.03±7.89	9.76±5.41	10.87±6.28	9.14±5.81	11.39±7.26

3 rd	Male	5	9.16±11.40	7.13±5.81	9.82±5.74	10.62±7.61	10.17±7.94	12.74±7.56
	Female	4	4.72±2.36 ^{aa,bb}	13.10±6.35	5.39±2.30	6.80±5.97	13.23±10.02	7.57±6.48
	Total	9	6.74±8.68 ^b	9.78±6.47	7.96±5.47	8.83±7.00	11.53±8.47	10.44±7.19
4 th	Male	2	18.35±1.02 ^{aa,c}	8.22±5.90	10.73±2.66	10.34±8.22	12.36±9.53	3.21±4.41
	Female	3	20.05±13.93 ^{a,cc}	7.07±7.70	12.65±10.31	14.27±12.47	7.01±6.86	3.79±4.16
	Total	5	19.37±9.91 ^{aa,cc}	7.53±6.22	11.88±7.49	12.69±9.96	9.08±9.21	3.56±3.69

a: P<0.05; aa: P<0.01, compared to the 1st; b: P<0.05; bb: P<0.01, compared to the 2nd; c: P<0.05; cc: P<0.01, compared to the 3rd

Table 3: The correlation analysis among the brain arousal level value, the brain energy ratio of the trampolines athletes and brain neurotransmitters

Evaluation index	N		INH	5-HT	ACh	DA	NE	EXC
Arousal index, compulsory movement	34	Correlation	0.111	-0.017	-0.309	0.144	0.073	-0.055
		Significance	0.532	0.925	0.076	0.417	0.682	0.757
Arousal index, optional movement	34	Correlation	0.160	0.002	-0.352	0.083	0.023	-0.066
		Significance	0.367	0.989	0.041*	0.639	0.896	0.710
Power energy ratio, compulsory movement	34	Correlation	0.199	0.289	-0.096	0.199	0.079	0.082
		Significance	0.258	0.098	0.590	0.258	0.658	0.644
Power energy ratio, optional movement	34	Correlation	0.080	0.293	-0.301	0.360	-0.007	-0.061
		Significance	0.651	0.093	0.084	0.036*	0.968	0.734

The significance test of the correlation; *, P<0.05, there was significant correlation

Table 4: The correlation analysis among the neurotransmitters in the brain of the trampolines athletes

Neurotransmitters	N	Coordination analysis	INH	5-HT	ACh	DA	NE	EXC
INH	34	Correlation	1.000					
		Significance						
5-HT	34	Correlation	0.048	1.000				
		Significance	0.792					
ACh	34	Correlation	0.125	-0.108	1.000			
		Significance	0.488	0.551				
DA	34	Correlation	-0.104	0.865	-0.264	1.000		
		Significance	0.563	0.000**	0.137			
NE	34	Correlation	-0.025	-0.082	0.121	-0.048	1.000	
		Significance	.889	0.652	0.501	0.792		
EXC	34	Correlation	0.406	-0.292	0.232	-0.335	0.036	1.000
		Significance	0.019*	0.099	0.194	0.056	0.840	

The significance test of the correlation: *, P<0.05, there was significant correlation; **, P<0.01, there was high significant correlation

Table 5: The brain neural cooperativity of the trampolines athletes

Time	gender	N	Whole brain cooperativity	Left and right brain cooperativity	Forebrain and hindbrain cooperativity (left)	Forebrain and hindbrain cooperativity (right)
1 st	Male	5	164.20±45.49	45.60±13.90	37.40±11.52	31.80±10.18
	Female	5	145.80±53.49	42.80±23.06	29.00±11.68	31.40±15.58
	Total	10	155.00±47.80	44.20±18.01	33.20±11.80	31.60±12.41
2 nd	Male	5	183.60±36.11	58.40±19.49	38.80±15.28	41.00±15.17
	Female	5	141.60±37.47	43.80±18.03	27.60±11.86	31.60±9.07
	Total	10	162.60±41.15	51.10±19.30	33.20±14.18	36.30±12.78

3 rd	Male	5	194.00±20.74	64.20±18.39	44.40±15.79	45.80±13.70
	Female	4	143.25±38.92	37.00±11.16	35.50±9.00	33.50±11.00
	Total	9	171.44±38.71	52.11±20.52	40.44±13.30	40.33±13.46
4 th	Male	2	172.50±33.23	48.50±13.43	39.00±1.41	29.00±16.97
	Female	3	138.00±78.26	45.67±36.68	29.67±22.94	34.33±23.11
	Total	5	151.80±62.70	46.80±26.83	33.40±17.02	32.20±18.64

Table 6: The coordination analysis between the brain neural cooperativity of the trampoline athletes and the neurotransmitters

Neuro-trans-mitters	N	Coordination analysis	Whole brain cooperativity	Left and right brain cooperativity	Forebrain and hindbrain cooperativity (left)	Forebrain and hindbrain cooperativity (right)
INH	34	Correlation	-0.177	-0.002	-0.185	-0.077
		Significance	0.317	0.990	0.294	0.665
5-HT	34	Correlation	0.507**	0.582**	0.498**	0.512**
		Significance	0.002	0.000	0.003	0.002
ACh	34	Correlation	0.311	0.350*	0.351*	0.324
		Significance	0.073	0.042	0.042	0.062
DA	34	Correlation	0.253	0.271	0.236	0.233
		Significance	0.148	0.121	0.179	0.185
NE	34	Correlation	0.191	0.119	-0.007	0.116
		Significance	0.279	0.504	0.969	0.513
EXC	34	Correlation	0.015	0.061	0.062	-0.009
		Significance	0.935	0.732	0.727	0.958

The significance test of the correlation: *, $P < 0.05$, there was significant correlation; **, $P < 0.01$, there was high significant correlation

Discussions

3.1 The analysis on the brain state of the trampoline athletes

The brain arousal index reflecting the brain excitability level reached the reference values of the International Master in the first 3 testing, even that of some athletes had reached the reference value of the world champion and the Olympic champion. These results suggested that the exercising intensity highly stimulated the brain of trampoline athletes. That the brain arousal index of the optional movement was slightly higher than that of the compulsory movement illustrated that the optional movement stimulated more strongly the brain. The data of the brain energy ratio to reflect the influence of exercise on the brain suggested that the exercising load borne by an athlete's brain was not the same in different training phase, however, the ratio were in the moderate range. Dynamic analyzing of the 4 test data, it was observed that the average value of whole the team fluctuated in a certain range, furthermore, the data showed a downward trend from the first test to the third test, but it rose and reached the highest value at the fourth test. These results reflected the athlete's brain bore various exercise loads in different training or competition stage. The first test was at the end of the competition season and before the finals of the World Cup, in which the athletes detected were the key players to participate. The athlete's brain was subjected to match load and the brain excitability was higher. The second test was at the interim during the winter training, in which not only the athletes had no competition but the routine exercising load was relatively lower, therefore, the data were reduced. The third test was conducted before the end of the winter training, and these data lowered further to the minimum among the 4 test. The fourth test was carried out in July when the Beijing Olympic Games had less than a month. The 5 detected athletes who were candidates for the final qualification of the formal competition in the Games were in very uptight state, so the data reflected not only the brain excitability reached the highest point, but the exercise load borne by brain reached the maximum so that some players had been in alert state. This result suggested that the athlete's brain had entered the competition state so early that both coaches and athletes needed to control reasonably the athlete's state. These results coincided with what were gotten in other sports, such as diving [5], shooting [6], women's rugby [7], that is, both the brain arousal index and the brain energy ratio of athletes who participated in the competition to were higher than that of athletes who did not participated in the competition

3.2 The analysis on the relation between the brain state of the trampoline athletes and central neurotransmitters

Usually the central neurotransmitters played impotent roles in the physiological activities of their target cells or target sites that were excited or inhibited. Generally, ACh, DA, Glu belonged to the excitatory neurotransmitter because the most of the target cells or target sites was excited, but 5-HT, NE, Gly, GABA were inhibitory neurotransmitters due to their inhibiting effects on their target cells. This study found that the ACh correlated to the brain arousal index when recalled optional movements. This result suggested that the ACh not only played an important role in maintaining the athlete's high excitement state but also was one of the physiological and biochemical bases in the central nervous system regulation of trampoline athletes performing more difficult movements. Neural biochemical studies had also found that the ACh had excitatory effects on the cerebral cortex, which played an important role in the maintenance of behavior, EEG activating, promoting learning and memory et al^[8]. The difference of the ACh content in brain in different physiological conditions reflected distinct brain excitatory state or inhibitory state. Under the condition of exercise-induced fatigue, the memory lowering, the dysesthesia, the visceral organ dysfunction and other physiological responses might concern with the brain ACh, which our results confirmed. Another important central nervous transmitter, DA, was observed to relate with the brain energy ratio when recalled optional movements in this research, of DA and appearance of action also has relevance, which suggested that exercising load borne by the athlete's brain was closely relevant with the DA. Researching on neural biochemistry of DA discovered that DA related directly to muscular movement function, general behavior, mental activities and emotional, neuroendocrine and so on. During the exercising, the dopamine metabolism in many encephalic regions including midbrain, hippocampus, hypothalamus was active^[9], however, both the synthesis and the metabolism of dopamine decreased in the fatigue state. When the exercising load was very high, including large exercising intensity, or participating in a major sporting events such as the Olympic Games, the athletes borne very heavy exercising load or competing load, and their brain accepted also very huge exercising load. At this time, the DA activity relatively increased, neuroendocrine activities were active, and the hormone associated with the exercising secreted, so the control ability of athletes to muscle movement had been strengthened, and the athletes were able to cope with more intense and more complex movements. Meanwhile, relatively high DA enabled athletes to maintain emotional, mental activity at a high level so that the athletes could make an accurate judgment to the changing situation on the exercising field or competing field and could formulate an optimal response.

Interestingly, the results of this study on ACh and DA were inconsistent with our previous researches on the shooting athletes. The previous study found when the brain exercising stress ability of shooting athletes was estimated as optimal or good, ACh value was high, but ACh was the minimum when the brain exercise stress ability was poor, suggesting a relationship between the brain stress ability and ACh was more closely. However, the relation between the DA and the brain exercising state and stress ability of the shooting athletes was not close, and DA related more closely with the sports rank of the athletes^[6]. The reason for this difference between the 2 events perhaps was that they belonged to different sports items, which the shooting belonged to the performing accuracy but trampoline belongs to the performing difficulty and beautifulness. Because of their essential differences, the central neurotransmitter activity was likely to be inconsistent.

As for the other neurotransmitters, such as 5-HT, NE, INH (that GABA was reflected) and EXC (that Glu was reflected), the obvious regularity did not appear, but in the third testing, DA, 5-HT, INH and EXC were the lowest, which prompted that the athlete's brain function activation was a relatively low at the end of the winter training.

In addition, the correlation analysis among the several neurotransmitters showed there were high negative correlation with both DA vs. 5-HT and EXC vs. INH. This result was consistent with the traditional understanding of these several neurotransmitters, that is, the neural physiological and biochemical function of DA vs. 5-HT, Glu vs. GABA were respectively the excitatory vs inhibitory and antagonism each other. The DA related directly to the muscular movement, general behavior, mental activities and emotional, neuroendocrine and so on; the 5-HT participated mainly control of sleep, exercise and emotion, maintaining stable spirit^[10, 11], and was an important medium of the central fatigue^[12]. That the brain 5-HT synthesis rate increased caused the brain to enhance sensitivity to other fatigue signal so that the body movement ability descended and fatigue feeling occurred easily; on the contrary, the synthesis and metabolism of dopamine decreased in the fatigue state. Glu, a typical, the most widely distributed and the most content of excitatory amino acid neurotransmitter, had strongly excitatory effects to almost all neuron what it functioned^[13,14]; GABA, widely distributed in the brain, had many physiological functions, such as anxiolytic effect^[14,15]. Our results suggested that, in the sports items performing difficulty and beautifulness, of this phenomenon of paired central neurotransmitters represented more obviously than in the static project such as shooting. Further it was conjectured that the ratio between the paired central neurotransmitter caused directly the changes of athlete brain function state, and even the emergence of sports central fatigue. In a research on SET and EEG in the National Women's Rugby players, we also observed that the whole brain average level of both DA vs. 5-HT and INH vs. EXC decreased synchronously and the level of NE and ACh increased in anterior-posterior 2 testing^[7], which also prompted that the central neurotransmitter activity in the brain of a same-field-contest sports was more similar to the sports items performing difficulty and beautifulness.

3.3 The relation between the brain neural coordination and the brain functional state of the trampoline athletes

The neural cooperativity parameters reflected the coordinated ability of the brain regions in the advanced nerve activity. The higher the cooperativity parameter was, the more coincidentally the regions of the brain involved in the same activity. That the whole brain cooperativity parameters of the elite trampoline athletes were higher than average of the ordinary peoples showed the brain synergism ability of the elite trampoline athletes among the brain regions surpassed the ordinary people. However, we also noted that there were the minimum at the fourth testing in spite of there was no significant statistical difference. Because the fourth testing was carried out in less than 1 month before the Olympic Games, the data suggested the athletes did not reach the best brain synergism ability and the brain function state was not the best at this time.

Analyzing the correlation between the cooperativity parameters and the central neurotransmitters in the brain, we found that 5-HT related closed with brain cooperativity parameters are highly correlated, which suggested 5-HT played an important role in the synergism activity function in the brain regions. The higher the 5-HT was, the stronger the brain synergism ability was; on the other hand, increasing of the 5-HT was likely to result in the central fatigue. Therefore, when the 5-HT in the brain of the elite trampoline athletes was maintained at a level or range, the brain synergism ability was the strongest, and there was no the central fatigue or fatigue omen, which the brain function should be in the best state at this time. This needed to be further studied.

Conclusion

- (1) In whole team, both the brain arousal index level and the brain energy ratio of the optional movement were slightly higher than of compulsory movement; the data which fluctuated within a certain range suggested that the exercise load bored in the athlete's brain was not identical at different training stages.
- (2) In the 3rd monitoring, the values of DA, 5-HT, INH and EXC were minimum, while whole-brain coordination parameter appeared the lowest point in the fourth monitoring.
- (3) DA and the brain energy ratio of the optional movement had correlation; ACh correlated with the brain arousal index of the optional movement; both 5-HT and ACh were highly correlated with the brain coordination parameter.

Reference

1. YL Tan, Y Hou. (1999). Clinic electroencephalography and electroencephalotopogram [M]. Beijing: People's Medical Publishing House, 21 - 25.
2. L Mei. ET. (1995). The New Techniques of Brain Function Test [M]. Beijing: Defense Industry Publishing House, 136-182.
3. ZM Zhang, WA Zhou, ZH Cai, et al. (2002). Research on the Neurobiological Characteristics of the Chinese Table-Tennis Champions [J]. Chin J Sports Med, 21(1): 452-457.
4. ZM Zhang, WA Zhou, Y Zhang et al. (2004). Research on diagnosis of central fatigue using brain bioelectricity evoked test [J]. Chin J Sports Med, 23(4): 422-425.
5. WA Zhou, ZM Zhang, WG He et al. (2004). Research on the Brain Function of the Chinese Elite Diving Athletes [J]. Chin J Sports Med, 23(6), 649-653.
6. WA Zhou, HT Chen, WG He et al. (2010). Analyzing of Encephalofluctuograph on the Elite Chinese Shooting Athletes [J]. Chin J Sports Med, 29(2), 205-210.
7. H Xu, WA Zhou, XL Gao et al. (2011). Research on the Neurobiological Characteristics of the Elite Chinese Woman Rugby Players [J]. Chin J Sports Med, 23 (6), 649-653.
8. Perry E, Walker M, Grace J, et al. (1999). Acetylcholine in mind: a neurotransmitter correlate of consciousness? [J] Trends Neurosci, 22(6):273.
9. B Wang, Y Zhang, J Li, et al. (2002). Effect of Exhausting Treadmill Running on Monoamine Neurotransmitters Concentration in Corpus Striatum, Midbrain and Hypothalamus of Rat [J]. Chin J Sports Med, 21 (3): 248 – 252.
10. Chaouloff. (1997). Effects of acute physical exercise on central serotonergic system [J]. Med Sci Sports Exerc, 1: 58 – 62.
11. Weicker H, Struder HK. (2001). Influence of exercise on serotonergic neuromodulation in the brain [J]. Amino Acids, 20(1): 35 - 47.
12. Davis JM, Alderson NL, Welsh R S. (2000). Serotonin and central nervous system fatigue: nutritional considerations [J]. Am J Clin Nutr, 72 (Suppl. 2): s573 - 578.
13. Guertin PA. (2009). The mammalian central pattern generator for locomotion [J]. Brain Res Rev, 62: 45-56.
14. Sirvanci S, Meshul CK, Onat F, et al. (2005). Glutamate and GABA immunocytochemical electron microscopy in the hippocampal dentategyrus of normal and genetic absence epilepsy rats [J]. Brain Res, 1053 (1-2): 108 - 115.
15. Marty A, Llano I. (2003). Excitatory effects of GABA in established brain networks [J]. Trends Neurosci, 28(6): 284-9.

Acknowledge

This study was supported by Chinese Institutes of Sports Science Fundamental Grant: 06-24 and 10-13.

THE EFFECTS OF FATIGUE ON ACCURACY AND SOME KINEMATIC PARAMETERS ON BASKETBALL SHOOTING

Marijo Baković, Damir Knjaz, Ljubomir Antekolović and Tomislav Rupčić

Faculty of Kinesiology, University of Zagreb, Croatia

The aim of this study was to determine the effects of fatigue on basketball shooting. Two very important kinematic parameters that affect the level of accuracy during jump shot (considering players situational efficiency during the game) were analyzed; shot speed (time from the moment of receiving to the moment of releasing the ball) and angle of entry the ball into the basket.

The subject of the study was one high level basketball player (age: 16, height: 190 cm, weight: 74,1 kg).

The variables of the experimental protocol were: precision (the ratio of successful and unsuccessful shot), shot speed and angle of entry the ball into the basket. All parameters were analyzed during 2 and 3 points shooting, while during shooting for 1 point (free throws) shot speed was not evaluating. The fatigue level was measured during standard specific protocol in which subject was instructed that intensity is maximum and protocol ends when there is no energy to continue activity. Physiological load was examined with perception of exertion and blood lactate concentration. Subjective stress level was estimated with Borg scale (BS) by subject after the activity, expressed in 1 to 13 levels. Level 1 means very, very low intensity, while 13 means maximum intensity without no energy to continue activity. Blood lactate concentration (LAC) was measured from a fingertip blood drop with Lactate Scout analyzer (LS, SensLab GmbH, Germany).

The measured blood lactate concentration was 10,2 mmol/L and subjective perception of stress level was 12.

Based on the results it can be concluded that fatigue does not affect the level of accuracy ($2P_{\text{inicial}} 60\% - 2P_{\text{final}} 66\%$; $3P_{\text{inicial}} 40\% - 3P_{\text{final}} 46\%$; $1P_{\text{inicial}} 100\%$, $1P_{\text{final}} 100\%$).

Analysis of kinematical parameters shows statistically significant differences in shot speed before and after the produced fatigue in shots for 2 and 3 points ($2PV_{\text{inicial}} 0,82\text{sec} - 2PV_{\text{final}} 0,88\text{sec}$ ($p=0,00$); $3PV_{\text{inicial}} 0,85\text{sec} - 3PV_{\text{final}} 0,91\text{sec}$ ($p=0,01$)). Further, there is no statistically significant difference in angles of entry the ball into the basket in shots for 2 and 3 points ($2PA_{\text{inicial}} 44,46^\circ - 2PA_{\text{final}} 42,46^\circ$ ($p=0,10$); $3PA_{\text{inicial}} 43,00^\circ - 3PA_{\text{final}} 42,73^\circ$ ($p=0,76$)). Analysis of 1 point shots (free throws) shows that fatigue affects on angle of entry the ball into the basket, but precision level stays the same ($1PA_{\text{inicial}} 43,90^\circ - 1PA_{\text{final}} 39,60^\circ$ ($p=0,01$)).

WHAT IS THE CURRENT STATUS OF OMANI ADOLESCENT'S LIFE STYLE?

Hashem Kilani¹ and Mostafa Waly²

¹*Department of Physical Education, College of Education*

²*Food Science & Nutrition Department, College of Agricultural & Marine Sciences, Sultan Qaboos University, Oman*

Back ground: The overall health status of the Omani population has evolved over the past 4 decades from one dominated by infectious disease to one in which chronic disease poses the main challenge. Currently, more than 75% of the disease burden in Oman is attributable to non-communicable diseases, with cardiovascular disease as the leading cause of death.

Objectives: to survey the Omani adolescent's status with respect to physical activity inactivity, dietary intake, and hours of daily and weekly sleep duration.

Methods: 802 Omani adolescents (442 females and 360 males), aged 15–18 years were randomly recruited. Anthropometric indices, physical activity-in activity level, dietary intake and hours of daily and weekly sleep duration were evaluated by the Arab Teenage Lifestyle questionnaire (ATLS). A semi-quantitative food frequency questionnaire for dietary assessment was also administered.

Results: The results showed that although the study subjects had a sedentary lifestyle (lack of physical activity, average of 6.7 hours sleep, and consumption of high calorie foods), they maintained a normal body mass (less than 25 Kg/m²). Males were more than twice as active as females. With respect to dietary intake, there were few gender differences, except in dairy and meat consumption where 62.5% and 55.5% of males consumed more than 3 servings, respectively, compared to 18.78% and 35.2% of females, respectively. In addition, waist/height ratio, height, reasons for being active, energy drinks, potato consumption, eating sweets, vigorous physical activity and breakfast intake were statistically significant independent predictors for BMI, $P < 0.05$ for both males and females.

Conclusion: This study revealed a high prevalence of sedentary behaviors and a low level of physical activity, especially among females. Unhealthy dietary habits were also widely found among both genders. There is an urgent need for more research as well as a national policy promoting active living and healthy eating and discouraging sedentary behavior among Omani adolescents.

Key words: *Adolescent, Oman, Lifestyle, Physical Activity, Dietary intake, sleep duration*

ALCOHOL AND TOBACCO USE IN SPORT COACHES

Branka R. Matković, Antonela Nedić, Andro Matković¹, Tomislav Rupčić and Petra Ožegović²

Faculty of Kinesiology, University of Zagreb, Croatia

¹*Medical Center Zagreb – Center, Zagreb, Croatia*

²*Clinical Hospital Merkur, Zagreb, Croatia*

Abstract

Sport coaches are a population with its specific characteristics and because of their association with the athletes, especially the young, their lifestyle habits deserve attention. The aim of this study was to determine the habits related to alcohol consumption and smoking in Croatian sport coaches. The study was conducted on 56 women and 147 men, coaches of various sport disciplines in 2012. AUDIT questionnaire related to alcohol consumption and FTND questionnaire to determine nicotine addiction were used. Most of the sports coaches of both genders have no problems with alcohol and their nicotine addiction is on average weak, although there are some very serious nicotine addicts.

Key words: *sports coaches, alcohol, AUDIT, smoking, FTND*

MORPHOFUNCTIONAL CHARACTERISTICS OF THREE NATIONAL WATER POLO TEAMS OF VARIOUS AGE GROUPS

Jadranka Plavšić, Slavica Djordjevic-Šaranović and Sanja Mazić

Serbian Institute of Sport and Sport Medicine, Belgrade, Serbia

Introduction

The differences in anthropomorphic and cardio-respiratory parameters among young athletes could be influenced by the biological development itself or they could appear under the impact of the training stimulus that is characteristic for a certain type of sport.

Aim

The aim of this study was to show the differences in anthropomorphic and cardio-respiratory parameters between three groups of national water polo selections of a different age.

Method

The research includes 52 selected water polo players, divided in three groups: younger group (Y) aged 14 to 16 years ($n_1=20$), older group (O) aged 17 to 19 years ($n_2=17$), and A selection (A) aged 21 to 33 years ($n_3=15$). The research was conducted in the laboratory for functional diagnostic in the Serbian Institute of Sport and Sport Medicine. In total, 23 measurements were performed within the anthropomorphic examinations (ISAK). Maximal progressive ergospirometry test was done on a Treadmill T200 Cosmed and using Quark b² Breath by breath Pulmonary Gas Exchange (VO_{2max} , VO_{2max}/kg).

Student's T-test was used for comparison of measured parameters.

Results

The comparison of measured parameters between the first two groups (younger and older) showed the statistically significant difference in body height (Y 183.70 ± 7.40 cm vs. O 190.21 ± 5.17 cm), body weight (Y 74.75 ± 11.23 kg vs. O 86.62 ± 12.09 kg), BMI (Y 22.11 ± 2.55 kg/m² vs. O 23.83 ± 2.36 kg/m²), chest circumference (Y 94.05 ± 6.80 cm vs. O 103.09 ± 7.65 cm), forearm circumference (Y 26.10 ± 2.07 cm vs. O 27.65 ± 1.39 cm), VO_{2max} (Y 4251.60 ± 805.65 ml/min vs. O 5040.47 ± 728.83 ml/min)($p<0.01$ for all). Between the second and the third group (older group and A selection) the statistically significant difference was noticed in body weight (O 86.62 ± 12.09 kg vs. A 100.00 ± 5.84 kg), chest circumference (O 103.09 ± 7.65 cm vs. A 112.07 ± 5.88 cm), waist circumference (O 82.85 ± 9.58 cm vs. A 90.80 ± 5.31 cm), hip circumference (O 100.73 ± 6.20 cm vs. A 105.90 ± 5.03 cm), upper arm circumference (O 31.68 ± 2.33 cm vs. A 35.33 ± 1.53 cm), forearm circumference (O 27.65 ± 1.39 cm vs. A 33.77 ± 0.98 cm), thigh circumference (O 56.88 ± 4.09 cm vs. A 61.47 ± 1.90 cm), calf circumference (O 37.38 ± 2.71 cm vs. A 40.43 ± 2.00 cm)($p<0.01$ for all).

Conclusion

These results show that training stimulus leads to the same adaptive changes of the cardio-respiratory system, and also that noticed differences most likely derive from a different level of biological development.

Key words: *water polo, anthropometric, VO_{2max}*

INTERACTIVE DANCE: AN EXCITING WAY TO ENHANCE CHILDREN'S PHYSICAL ACTIVITY LEVEL

Lana Ružić¹, Sebastijan Mohar¹ and Ivan Radman²

¹University of Zagreb, Faculty of Kinesiology, Zagreb, Croatia

²University of Vienna, Institute of Sport Science, Vienna, Austria

Abstract

Purpose

Exergaming has become widely popular as a recreational activity but the problem that emerges is the adequacy of the exercise intensity for participants of different skills and fitness. That is why the aim of this study was to determine the physiological load in children during the “iDance” class (Positive Gaming™) and to investigate whether the elicited physiological response was related to the proficiency of the subject or to the engagement in other sport activities.

Methods

Twenty-one subjects (11F, 10M; 10.7±1.6 y) were tested during the Machine “iDance” class, which is a computer game played by the body movements under the visual instructions on the big screen (25 different levels possible). The feedback is a percentage of both accuracy of movement and accuracy of timing in comparison to the possible maximal score. The heart rate, the energy expenditure and the perceived exertion were recorded.

Results

The HR_{mean} during the class was 147±8.5 bpm (or 70.23±6.8% of the estimated HR_{max}) which indicated that the children exercised at the moderate intensity. Nevertheless, 22% of the overall interactive-dance time was spent in a high-intensity zone. The energy costs were 5.1 kcal/kg/h. In 86% of participants the activity was perceived as light and they reported being only moderately tired. No correlations were determined between the “iDance” experience or playing level and physiological load. Also, we did not find the significant differences in energy expenditure between groups of children that participate and do not participate in other sport activities (%HR_{max} 68.72±8.44 vs. 71.15±5.68 bpm, p=0.256; energy consumption 4.76±0.93 vs. 5.31±1.24 kcal/kg/h, p=0.256)

Conclusions

According to the estimated energy consumption and the exercise intensities, the “iDance” program might elicit positive changes in aerobic capacities and might be an useful weight management help but more longitudinal studies would be needed. This program enabled every participant to exercise at the similar exercise intensity regardless of their experience or participation in other sports because it is adjustable. As it requires high coordination, agility and anticipation skills it might also serve as a complimentary conditioning activity.

Key words: exergaming, play, physiological load, caloric consumption, machine-dance

DIFFERENCES BETWEEN GIRLS AND BOYS IN PHYSICAL EFFICIENCY TEST RESULTS IN THE DEPENDENCE ON BODY MASS COMPONENTS

Ewa Szczepanowska

University of Szczecin, Poland

Human physical efficiency and performance depend more on body mass components than body size. The aim of work is to evaluate a relation between results of 16 physical efficiency tests carried out in the college girls and boys in the dependence on body mass components.

The research was carried out among 83 girls (age 18.06 SD 1.118 years; body height 164.99 SD 6.209 cm; body mass 58.89 SD 9.887 kg) and 146 boys (18.03 SD 1.089 years; 179.30 SD 6.590 cm; 72.74 SD 11.447 kg, respectively). Body composition (BC) was assessed by the bioimpedance method using TANITA BC-601 Body Composition Analyzer.

Body composition significantly differed between genders. The analysis of clusters was used to study the dependence of 13 physical efficiency variables (common for both genders) on body mass components. To analysis of clusters standardized variables and both genders together were taken under the consideration because standardization was carried out within the gender and chronological age. Mean values in both clusters differed significantly. In one cluster were positive values (N=109) and in the second – negative (N=116), then clusters represented better and worse results. The analysis of variance (with body mass components as dependent variables) showed significant differences in body mass, fat and water contents, in these two groups of clusters. However, muscle mass did not significantly differed.

The level of obesity differentiated both genders in regard to physical efficiency test results. Obesity measured by body proportions influenced more negatively on physical efficiency test results in boys (as much as 8 tests) than in girls (only one test). In boys it was noticed the more wider variability range of studied features than in girls.

Key words: *physical efficiency test, body mass components, girls, boys*

THE INFLUENCES OF DIFFERENT EXERCISE TRAINING ON CHRONIC INFLAMMATORY MARKERS IN YOUNG OBESE ADULTS

Jianfang Xu

Chian Institute of Sport Science, China

Purpose: With the increasing of the number of overweight and obese around the world, it is not only a mental stress to who is overweight or obese, but also an economic pressure to the society. It is known to us that the obesity is in a chronic inflammatory status, so this paper is aimed to discuss the effect of aerobic and resistance training on young obesity in chronic inflammatory by the testing of chronic inflammatory markers.

Methods: With the diet controlling, 37 volunteers (male-18, female-19) were divided into 2 groups, such as the aerobic training (AT) group (male-10, female-10, 21.1±2.0 years, BMI=30.28±2.17) and resistance training (RT) group (male-8, female-9, 21.1±1.6 years, BMI=30.10±2.35). The training time was last 4 weeks and there had three times to take the venous blood samples of the volunteers to test the contents of TNF- α , IL-6, hs-CRP, ADP, LEP, IL-10 by using ELISA at the beginning, 4 weeks later and 8 weeks later (the last 4 weeks without diet controlling and no training).

Results: 1. The body weight of the volunteers in AT and RT groups decreased significantly after 4 weeks, and it maintained at a low level after 8 weeks (AT: 92.13±13.68 to 84.08±11.90 to 83.86±11.59 kg, RT: 86.68±13.91 to 79.79±11.82 to 79.72±12.36 kg). 2. The body fat rate of the volunteers also have the same tendency as the trend of the body weight. (AT: 38.71±5.79 to 34.21±6.91 to 33.09±7.42%, RT: 38.84±5.54 to 34.65±6.51 to 33.99±7.33%). 3. The contents of TNF- α decreased significantly after 8 weeks (AT: 16.29±2.55 to 14.93±2.48, RT: 16.60±2.22 to 14.13±1.82 ng/ml). The contents of IL-6 decreased significantly after 4 weeks, but increased after 8 weeks. While there is no significant change with hs-CRP.

Conclusions: 1. Aerobic and resistance training can lose weight by reduce the mass of the fat. 2. The chronic inflammatory of the body can be inhibited in aerobic and resistance training group by decreasing the contents of TNF- α and IL-6.

Key words: *Chronic Inflammatory Markers, Obese, Aerobic Training, Resistance Training*

THE INFLUENCE OF PRIOR STEP EXERCISE ON THE ELECTRICAL ACTIVITY OF LEG MUSCLES DURING INCREASING RUNNING TEST IN YOUNG MEN

Kristina Zaicenkoviene and Arvydas Stasiulis

Lithuanian Sports University, Lithuania

Research object: The influence of prior step exercise on the electrical activity of leg muscles during increasing running test in young men.

Research problem: After unusual physical activities including eccentric and concentric muscle contractions we might observe delayed onset muscle soreness (DOMS) which is mostly felt 24–72 hours after physical loads (Armstrong, 1984, Yanagisawa et al., 2010). Eccentric physical exercise, like bench stepping, can cause DOMS (Clarkson, Hubal, 2002) and muscle fiber damage and thus reduce functional capacities of muscles (Skurvydas et al., 2000; Cheung et al., 2003; Yu et al., 2003; Piitulainen et al., 2011).

Research hypothesis: Eccentric concentric stepping exercise can induce calf muscle damage and decrease strength, thus it might affect leg muscle electrical activity during increasing running test (IRT) on a treadmill.

Research aim was to evaluate the influence of prior step exercise on the electrical activity of leg muscles during IRT in young men.

Research sample and organization. The subjects in the research were 9 males (age 22.8 (0.69)) healthy different sports specializations (sport aerobics, dance, basketball) from the Lithuanian Sports University. The subjects performed three IRT on a treadmill – a control one, 1 hour and 24 hours after stepping test. On the first day of testing the subjects performed control IRT on a treadmill (LE 200 CE, HP Cosmos). Before running IRT they had electrodes for estimating EMG (Biometrics Ltd, UK) fastened to their Vastus lateralis, Vastus medialis, Gastrocnemius lateralis, Gastrocnemius medialis leg muscles. Measures of the recruited muscles activity were analyzed using available software (Biometrics Data Log) and minute average values of the amplitude of EMG, the Root Mean Square (RMS), integrative EMG (IEMG) and the Mean frequency of EMG Power Spectrum were calculated. While running, the subjects had to give subjective evaluations of their efforts at the end of each minute of running. Right after running they lied down for 5 min. On the 5th and the 20th min after IRT blood samples were taken from their fingers to estimate the blood lactate concentration. After several days the study was repeated, where the subjects had warm-up, then they performed stepping test, and after 1 hour – IRT on a treadmill. After 24 hours the subjects came to the laboratory for the third time, evaluated their muscle soreness and repeated IRT.

Conclusions: The mean square value of EMG amplitude and integrated electrical activity of young men of muscles vastus lateralis and medialis does not change during IRT after 1h and 24 h after stepping exercise. After 1 h after this prior load the root mean square value of EMG amplitude of m. gastrocnemius lateralis increases, but after 24 h EMG mean frequency of power spectrum of this muscle decreases.

THE EFFECTS OF HYPERCAPNIC-HYPOXIC TRAINING ON HEMOGLOBIN CONCENTRATION AND MAXIMUM OXYGEN UPTAKE OF ELITE SWIMMERS

Dajana Zoretić, Nada Grčić-Zubčević and Katarina Zubčić

Faculty of Kinesiology, University of Zagreb, Croatia

Abstract

The aim of this research was to establish the effects of the hypercapnic-hypoxic training on hemoglobin concentration (Hb) and the maximum oxygen uptake (VO_{2max}) in swimmers. The research was conducted on a sample of 16 Croatian elite male swimmers (n=8 experimental group, n=8 control group). Both groups were subjected to the same swimming trainings and additional trainings on a conveyor belt. The experimental group was subjected to hypercapnic-hypoxic training with enhanced muscular activity. The experiment lasted for eight weeks. For the purpose of the research the following variables were used: hemoglobin concentration (Hb) and maximum oxygen uptake (VO_{2max}). The ANOVA series application for the repeated measurements have shown that there are significant Hb and VO_{2max} concentration differences related to the effect of both groups. The hypercapnic-hypoxic training method which was applied on elite swimmers has resulted in a 5.35% higher Hb concentration at the end of the program, which also caused a 10.79% increase of the VO_{2max} .

Key words: *hypercapnic-hypoxic training, hemoglobin concentration, maximum oxygen uptake, swimmers*



**7th INTERNATIONAL
SCIENTIFIC
CONFERENCE ON
KINESIOLOGY**

**FUNDAMENTAL
AND APPLIED
KINESIOLOGY – STEPS
FORWARD**



Biomechanics and Motor Control

Editors:

**Prof. Vladimir Medved, PhD
Prof. Goran Marković, PhD
Saša Vuk, PhD**

Peer Reviewers:

**Prof. Ljubomir Antekolović, PhD
Josipa Bradić, PhD
Prof. Mario Cifrek, PhD
Prof. Ivan Čuk, PhD
Prof. Milan Čoh, PhD
Assist. Prof. Sunčica Delaš Kalinski, PhD
Assist. Prof. Dražen Harasin, PhD
Assist. Prof. Željko Hraski, PhD
Assist. Prof. Tanja Jurčević Lulić, PhD
Assist. Prof. Mario Kasović, PhD
Prof. Bojan Matković, PhD
Prof. Dragan Mirkov, PhD
Assist. Prof. Pavle Mikulić, PhD
Prof. Goran Oreb, PhD
Assist. Prof. Tomislav Pribanić, PhD
Prof. Lana Ružić, PhD
Prof. Goran Sporiš, PhD**

IN SEARCH OF AN AUTOMATIC PILOT FOR WALKING

Jacques Duysens

Dept. of Kinesiology, KU-Leuven, Belgium

Walking and running are very common motor activities and it is therefore not surprising that there have been many efforts to study its neural basis. These “locomotor” activities are based on the multiple repetitions of a basic motor act, the step. Hence it makes sense that the basic pattern of locomotion is already organized at a low level in the central nervous system. Indeed there is good evidence that even humans use spinal central pattern generators (CPG’s) to support various forms of locomotion (including walking backward). However, gait has to be adapted to the environment and here is a role for the shaping of output by afferent input and by adaptation due to cortical activity. This cortical drive has its limitations however, in particular because the pathway for sensors in the leg to cortex to motor neurons is long and thus requires time. This is a serious limitation, in particular when gait is perturbed and very fast adjustments are needed. It is argued that there are subcortical mechanisms that may be important for these fast adjustments (“automatic pilot”).

One important structure is the cerebellum. This part of the brain receives input both from all types of sensory organs but it is also informed about planned motor activities. This allows constructing an internal model of gait. Such model allows predicting sensory consequences of gait and it allows comparing these consequences with the actually occurring feedback. In case of mismatch a correction signal can be sent quickly.

How can one study these mechanisms during human gait? The contribution of cortical mechanisms can be studied by having humans walk and perform a cognitive secondary task (such as counting backwards). If gait is fully automated then both tasks can be easily performed simultaneously.

However, when gait requires considerable cortical involvement (such as occurs in elderly) then gait deteriorates because the dual task requires the same type of cortical resources as does gait.

Whether the cortex is also involved in reactions to gait perturbations can be studied with another method. Conscious reactions, involving the cortex, take at least 150 ms (voluntary reaction time). Hence if responses have a shorter latency they are most likely due to subcortical mechanisms. In a series of studies it was shown that indeed there are many instances of responses with shorter latencies. These involve experiments with obstacle avoidance under time pressure, tripping and slipping. It will be argued that these short-latency responses could be due to prepared motor activity patterns, which are released by a given trigger (“triggered reactions”). Such pattern could be built in the brainstem, which explains that they are so fast (closer to spinal cord). Furthermore, these reactions can be made to occur even faster when the perturbations are associated with startle-like stimuli (“start-react” effects).

One way to examine the involvement of these various mechanisms is to look at pathology and degeneration (aging). The role of the cerebellum can be studied in patients with resection of cerebellar tumors. In such patients it can be shown that there are deficits in predicting the outcome of self-generated activities. In aging, there is a general slowing of various circuits, which can be examined by testing elderly with various challenging gait perturbations. It will be shown that reactions are indeed delayed in elderly but they still have latencies below those involving voluntary reactions. Understanding these adaptations in elderly is important in the context of fall prevention.

References

1. Duysens J and Van de Crommert H.W.A.A.: Neural control of locomotion; The central pattern generator from cats to humans. *Gait Posture* 7: 131-141. (1998)
2. Duysens J, Clarac F. and Cruse H.: Load regulating mechanisms in Gait Posture: comparative aspects. *Physiol. Rev.* 80 (1), pp 83-133 (2000)
3. Duysens J, De Groote F, Jonkers I. The flexion synergy, mother of all synergies and father of new models of gait. *Front Comput Neurosci.* 2013 Mar 13; 7:14.
4. Hoogkamer W, Meyns P, Duysens J. Steps forward in understanding backward gait: from basic circuits to rehabilitation. *Exerc Sport Sci Rev.* 2014 Jan;42(1):23-9.
5. Potocanac Z, Hoogkamer W, Carpes FP, Pijnappels M, Verschueren SM, Duysens J. Response inhibition during avoidance of virtual obstacles while walking. *Gait Posture.* 2013

RELATIONSHIP BETWEEN THE REACTION TIME OF RIGHT-HAND AND LEFT-HAND

Dana Badau¹, Dušan Mitić², Goran Prebeg² and Liliana Rogozea³

¹Faculty of Medicine, University of Tirgu Mures, Romania

²Faculty of Sport and Physical Education, University of Belgrade, Serbia

³Faculty of Medicine, Transilvania University of Brasov, Romania

Abstract

The main goal of the conducted research was to identify the differences between right hand and left hand, in terms of simple reaction time (TR) to the visual stimulus, according to gender and dominant segment. The research included 290 students with age $M \pm SD = 20.91 \pm 2.8$ evaluated with the ruler test at both hands. The tests highlighted significant statistical differences in favour of the left hand of 0.056ms, $t_{value} = 4.470$, $p < 0.05$. The results for the left hand in the men subgroup were significantly higher compared to the right hand with 0.059 ms, $t_{value} = 3.503$, $p < 0.05$. For the women subgroup the difference between the two hands has not statistical significance. The testes at the right-handed subjects show a superiority which is statistical significant for the left hand with 0.030ms, and at left-handed subjects with 0.0167ms, the differences being statistical significant: $t_{value} = 2.366$, $p < 0.05$ right-handed and $t_{value} = 5.953$, $p < 0.05$ left-handed. The results confirm the hypothesis, we consider there are significant differences between the right and left hand as regards reaction time, owing to the motric prevalence determined by the cerebral dominance; the results have practical applicability in streamlining the development of the reaction speed and in forming motric skills.

Key words: handedness, time reaction, ruler test, gender, left hand and right hand

Introduction

The reaction speed or latency time is reckoned the result of assessing the necessary time for the apparition of a motor response to a stimulus. The reaction speed depends on a series of factors (Huciński et al., 2007; Badau, 2006; Davis, 2000) such as:

- independent factors, which cannot be influenced: age, gender;
- factors that may be influenced: factors depending on the applied stimulus: simple or complex stimuli, type and intensity of the stimuli, number of possible responses; body-dependent factors: sports experience and training level, psychological condition, level of fitness, personality types, state of alertness, length of neural pathways, available time, anticipation, health, body temperature.

Training exercises on the reaction speed of the visual stimuli aim at improving the reaction time, which is particularly important in different sports, being focused on the sports-men's adequate motor response, in order to comply with the efficiency parameters.

The reaction speed has the following components: stimulus-reception duration (3-5ms), afferent transmission of the message to the central nervous system (5-10ms for the visual, acoustic, gustative and olfactory stimuli, and 20-25ms for the cutaneous and myoartokinetic ones), central analysis and synthesis time for command elaboration (82ms), afferent transmission (6-10ms), effective time of the motoric act (25-35ms), whose values undergo, according to the studies, major modifications, according to age, training condition and neuromuscular fatigue level (Darbutas et al., 2013; Ritesh et al., 2012; Cojocariu et al., 2011).

Controlling the reaction time to visual stimuli in physiological terms involves the retina (Cojocariu et al., 2011; Manno, 1996; Davis et al.), intra-cerebral visual pathways (Cojocariu et al., Guyton A.C., 1996), motor cortex and cerebellum (Cojocariu et al., 2011).

The issue of the dominant member and the manner of forming skills in the other member is important in the sportsmen's development activity, with a view to obtaining high sports performance (Dražen et al., 2010).

The specific goals of research were: 1. to analyse and compare the differences between right hand and left hand, in terms of reaction time; 2. to analyse and compare the differences between male and female in terms of reaction time for the right hand and left hand; 3. to analyse and compare the differences between the reaction time of the right-handers and left-handers, for the right and left hand.

In achieving the study, we adopted the hypothesis that, in the case of the sportsmen-students, lower values are offered for the simple reaction time by the left hand than by the right one, as adaptive neuromuscular response determined by sports experience, motoric prevalence and by the differences in the central reaction time of the nervous impulse transmission between the right and left hand.

The group was quite homogeneous in terms of age $M \pm SD = 20.91 \pm 2.8$ and preoccupations for the development of the motoric skills; its members were tested under standard conditions, characteristic of this type of experiment.

The study was conducted on 290 students from the specialisations: physical education, kinesiology and recreation, within 3 the Faculties of Physical Education and Sports from Brasov and Tirgu Mures (Romania) and Belgrade (Serbia), who were tested under standard conditions, observing the same experimental conditions.

The group included 187 men (64.5%), 103 women (35.5%), whereof: 253 right-handers (87.2%), 37 left-handers (12.8%).

One's having been categorized as predominantly left-hander or right-hander considered the most frequently utilized hand (excepting hand-writing).

The same test was applied to the entire group - *ruler test*, both for the right hand and for the left hand. The test was conducted in November 2013.

The purpose of the test was to monitor the athlete's reaction time and its steps were:

1. the 30cm-ruler is held by the assistant between the outstretched index finger and thumb of the athlete's dominant and non-dominant hand, so that the tip of the athlete's thumb is on the same level with the zero centimetre line on the ruler;
2. the assistant releases the ruler and the athlete catches the ruler between his/her index finger and thumb as quickly as possible;
3. the assistant is to record the distance between the end of the ruler and the tip of the athlete's thumb where the ruler has been caught,
4. the assistant must ask the athlete if (s)he is ready and within 30 sec (s) he releases the ruler;
5. the test is repeated twice and the average value is used in the assessment;
6. the average reaction times are worked out.

The formula for working out the reaction time in milliseconds:

$$TR = \sqrt{2d/g} \times 1000$$

Where: TR = reaction time (milliseconds), d = dropped-ruler distance (cm); g = acceleration conversion from seconds to milliseconds.

The data were statistically processed with the software IBM SPSS Statistics 20 for Windows. In order to analyse the reaction time, we calculated: arithmetic mean (M), minimum (Min), maximum (Max), standard deviation (SD), variation coefficient (Cv), t-test (t), correlation index (r-Pearson).

Results

Table 1: Descriptive Statistics (means and standard deviation) – Group

	N	Min.	Max.	M	SD
TRRH (ms)	290	.11	.22	.1684	.02124
TRLH (ms)	290	.11	.22	.1628	.02177
RTRH (cm)	290	6.00	24.00	14.1103	3.49318
RTLH (cm)	290	6.00	23.00	13.1966	3.29926

TRRH–reaction time of the right hand; TRLH–reaction time of the left hand;
RTRH–results at the ruler test with the right hand, RTLH–results at the ruler test with the left hand

$M \pm SD$ recorded for the group consisting of 290 subjects at the ruler test was $14.11\text{cm} \pm 0.021$ for the right hand and $13.19\text{cm} \pm 0.021$ for the left hand; the difference being of 0.9 cm in favour of the left hand. The difference between the arithmetic means of the reaction speed between the two segments was of 0.056ms in favour of the left hand, according to table no. 1. The variation coefficient – Cv for the reaction speed of the right hand at the ruler test was 12.61%, which reveals only a good homogeneity.

Table 2: Basic descriptive parameters of speed reaction measured on right-hand and left-hand for group; t-test paired samples and r- Pearson correlation

		Paired Differences			t-value	df	Sig. (2-tailed)	Paired Samples Correlations	
		Mean	Std. Deviation	Std. Error Mean				r- Pearson	Sig. (1-tailed)
Pair 1	TRRH - TRLH	.00564	.02150	.00126	4.470	289	.000	.486 ^{**}	.000

Paired-samples t-test; significant differences between the right and the left hand: *p<.05.

The correlation is significant at the **p<.01 level (1-tailed).

TRRH – reaction time of the right hand; TRLH – reaction time of the left hand

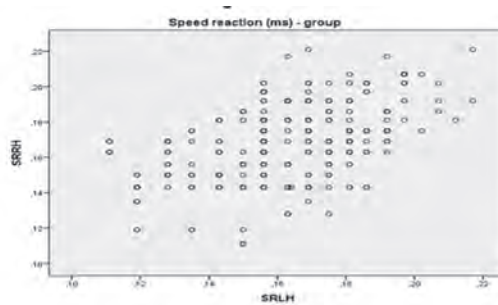

Graph 1: Dispersion of the results reflecting the reaction time for the right hand and for the left hand

The correlation of the reaction time between the right hand and the left hand was r- Pearson=0.486, p<0.01, which indicates a statistically significant correlation (table 2). The T-test for pair groups points to significant differences of the reaction time between the right hand and the left hand, this way $t_{value}=4.470$, for $df=289$. $p<0.05$. T_{value} is higher than the value t_{tabel} , which determines the rejection of the null hypothesis.

Table 3: Descriptive Statistics (means and standard deviation) for sub-group male and sub-group female

	N	Min	Max	M	SD
TRRHM (ms)	187	.11	.22	.1673	.02112
TRLHM (ms)	187	.11	.20	.1614	.02197
TRRHF (ms)	103	.11	.22	.1704	.02141
TRLHF (ms)	103	.13	.22	.1677	.02097
RTRHM (cm)	187	6.00	23.00	13.9305	3.44550
RTLHM (cm)	187	6.00	20.00	12.8556	3.23381
RTRHF (cm)	103	6.00	24.00	14.4369	3.57187
RTLHF (cm)	103	8.00	23.00	13.8155	3.34238

TRRHM–reaction time of the right hand-male; TRLHM–reaction time of the left hand-male; TRRHF– reaction time of the right hand- female; TRLHF–reaction time of the left hand-female; RTRHM– results at ruler test with the right hand-male, RTLHM – results at the ruler test with the left hand-male; RTRHF– results at the ruler test with the right hand -female, RTLHF– results at the ruler test with the left hand- female

The analysis of the results obtained by the sub-group of male, consisting of 187 subjects, and the sub-group of female, consisting of 103 subjects, shows differences in terms of reaction time and results at the ruler test, between the right and the left hand, according to table 3. The difference of the arithmetic mean between the two hands for the sub-group of male at the ruler test was 1.07cm, and of the reaction time was 0.059ms, in favour of the left hand. As regards the sub-group of female, a difference between the average values of the ruler test of 0.62 cm and 0.027ms was recorded in favour of the left hand. The differences of the arithmetic means between the sub-group of male and the sub-group of female for the right hand were -0.50cm, respectively -0.031ms in terms of reaction time, and for the left hand -0.96cm, respectively -0.063ms in terms of reaction time. Cv in terms of reaction time for the sub-group of male was 12.62% for the right hand and 13.61% for the left hand, which highlighted good homogeneity. As regards the sub-group of female, Cv of the reaction time was 12.56% for the right hand and 12.50% for the left hand, in compliance with a good homogeneity.

Table 4: Basic descriptive parameters of speed reaction measured for the right-hand and left-hand for the sub-group of male and the sub-group of female; t-test paired samples and r- Pearson correlation

	Paired Differences			t _{value}	Df	Sig. (2-tailed)	Paired Samples Correlations	
	Mean	Std. Deviation	Std. Error Mean				r- Pearson	Sig. (1-tailed)
Pair 1 TRRHM - TRLHM	,00591	,02307	,00169	3,503*	186	,001	,472**	,000
Pair 2 TRRHF - TRLHF	,00267	,02184	,00215	1,241*	102	,218	,469**	,000

Paired-samples t-test; significant differences between the right and the left hand: * $p < .05$., The correlation is significant at the ** $p < .01$ level (1-tailed)., TRRHM – reaction time of the right hand-men; TRLHM – reaction time of the left hand – men; TRRHF – reaction time of the right hand - women; TRLHF – reaction time of the left hand – women

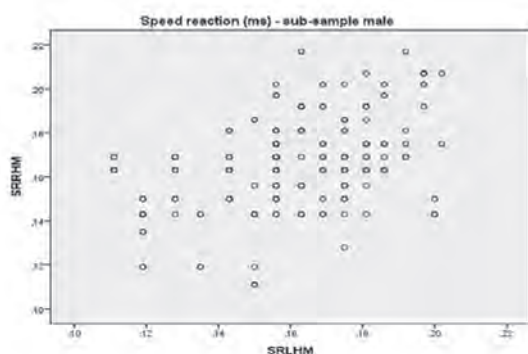

Graph 2: Dispersion of reaction time –sub-group of male

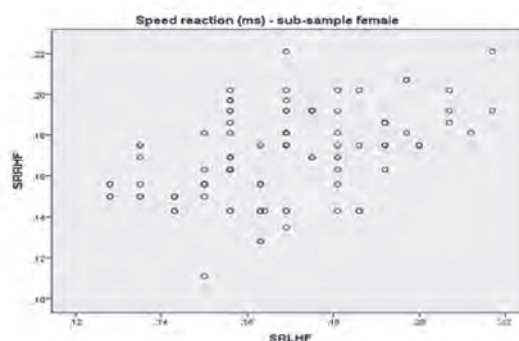

Graph 3: Dispersion of reaction time –sub-group of female

The results of the sub-group of male points to a significant correlation as regards the reaction time between the right hand and the left hand r -Pearson=0.472, similarly as in the case of the sub-group of female, where r -Pearson=0.469, for $p < .01$. As regards the sub-group of male, for the reaction time between the two hands, t value=3.503, df =186, $p < 0.05$ were recorded, t value being higher, the null hypothesis being therefore rejected. For the sub-group of female t value is lower than the value of t table, the differences being statistically insignificant and the null hypothesis being thereby rejected.

Table 5: Descriptive Statistics (means and standard deviation-SD) for sub-group of right-handers

	N	Min	Max	M	SD
TRRHR (ms)	253	,11	,22	,1668	,0213
TRLHR (ms)	253	,11	,22	,1638	,0229
RTRHR (cm)	253	6.00	24.00	13.853	3.482
RTLHR (cm)	253	6.00	23.00	13.221	3.460

TRRHR–reaction time of the right hand–right- handers; TRLHR–reaction time of the left hand–right- handers; RTRHR–results at the ruler test with the right hand–right-handers, RTLHR–results at the ruler test with the left hand–right-handers

As regards the sub-group of right- handers, consisting of 253 subjects, the following average differences between the left hand and the right hand were recorded at the ruler test: 0.63 cm, respectively 0.030 ms according to table 5. Cv for the reaction time of the right hand at the ruler test was 12.76% which reveals good homogeneity, as well as for the left hand, with $Cv=13.98\%$.

Table 6: Basic descriptive parameters of speed reaction measured on right-hand and left-hand; t-test paired samples and r- Pearson correlation – sub-group of right-handers

	Paired Differences			t _{value}	df	Sig. (2-tailed)	Paired Samples Correlations	
	Mean	Std. Deviation	Std. Error Mean				r- Pearson	Sig. (1-tailed)
Pair 1 TSRHR - TSLHR	,00301	,02287	,00144	2,095*	252	,037	,467**	,000

Paired-samples t-test; significant differences between the right and the left hand: * $p < .05$.

The correlation is significant at the ** $p < .01$ level (1-tailed).

TSRHR – reaction time of the right hand – right-handers; TSLHR – reaction time of the left hand – left-handers



Graph 4: Dispersion of reaction time – sub-group of right-handers

The correlation of the reaction time between the right hand and the left hand was $r=0.440$, $p<0.01$, which points to a statistically significant correlation (table 6). Statistically significant differences in terms of time between the right hand and the left hand for paired groups are also confirmed by the values $t_{value}=2.366$, $df=252$, $p<0.05$, which is higher than the value t_{table} which determines the rejection of the null hypothesis.

Table 7: Descriptive Statistics (means and standard deviation-SD) for the sub-group of left-handers

	N	Min	Max	M	SD
TRRHL (ms)	37	,14	,22	,1792	,0175
TRLHL (ms)	37	,14	,19	,1625	,0116
RTRHL (cm)	37	10,0	24,0	15,864	3,074
RTLHL (cm)	37	10,0	18,0	13,027	1,878

TRRHL - reaction time of the right hand -left-handers; TRLHL - reaction time of the left hand – left-handers; RTRHL - results at the ruler test with the right hand – left-handers; RTLHL - results at the ruler test with the left hand – left-handers

As regards the sub-group consisting of 37 female, a difference of the arithmetic means between the left and the right hand of 2.84 cm was recorded, as well as an average difference in terms of reaction time, of 0.167 ms, according to table 7. The Cv of the right hand for the reaction time at the ruler test was 9.78%, and the Cv of the left hand was 7.19% which highlights a very good homogeneity in both cases.

Table 8: Basic descriptive parameters of the speed reaction measured for the right hand and left hand; t-test paired samples and r-Pearson correlation – sub-group of left-handers

	Paired Differences			t-value	df	Sig. (2-tailed)	Paired Samples Correlations	
	Mean	Std. Deviation	Std. Error Mean				r-Pearson	Sig. (2-tailed)
Pair 1 TRRHL - TRLHL	.01670	.01707	.00281	5.953*	36	.000	.373**	.023

Paired-samples t-test; significant differences between the right and the left hand: * $p<0.05$. Correlation is significant at the ** $p<0.05$ level (2-tailed). TRRHL– reaction time of the right hand–left-handers; TRLHL–reaction time of the left hand – left-handers

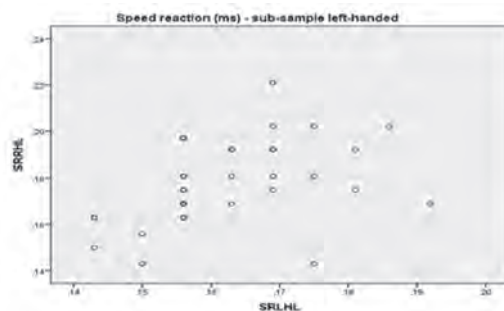

Graph 5: Dispersion of time reaction – sub-group of left-handers

The reaction time of the sub-group of female, between the right and the left hand for pair groups revealed significant statistical differences, confirmed by the values $t_{\text{value}}=5.953$, $df=36$, $p<0.05$, which is higher than the value t_{table} , the null hypothesis being therefore rejected. The correlation of the sub- group of female in terms of reaction time between the right hand and the left hand was $r\text{- Pearson}=0.373$, $p<0.01$, which points to a statistically significant correlation (table 8).

Discussion and conclusions

Testing the entire group shows that the reaction time of the left hand is shorter than the one of the right hand. The submitted study highlights a significant correlation between the right and left hands, in terms of reaction time, after having tested the entire group. The reaction time of the entire group at the ruler test pointed to statistically significant differences, which confirms the aforementioned hypothesis.

The differences in terms of reaction time according to gender, after having analysed the results offered by the sub-group of male and the one of female, were statistically significant, in favour of the male. The analysis of the data yielded by the test with the right hand and left hand for the sub- group of men and women highlights that the reaction time of the left hand was better than the one of the right hand. The correlation of the reaction time between segments of the sub-group of male was, on an average, statistically significant, similarly as in the female' case. The differences between the right hand and the left hand in terms of reaction time, of the sub-group of male are statistically different; the null hypothesis is therefore rejected.

These results differ from the conclusions of the studies focused on the reaction time at complex stimuli, which show no statistically significant differences between the groups of male and female (Cojocarui et al., 2011).

As regards the sub-group of female, the difference in terms of reaction time between the segments is insignificant, the null hypothesis being therefore accepted.

We dare say these results were influenced, in the female' group, by the sports training standards, which frequently suggested the use of both dominant and non-dominant members, a fact leading to the symmetrisation of the motoric skills, and implicitly improved the reaction times.

The analysis of the results yielded by the sub-group of right-handers and the one of left-handers pointed to a significant correlation between the two segments of the reaction time.

Both sub-groups showed better results in terms of reaction time for the left hand, with statistically significant differences, which confirms the research hypothesis.

Likewise, the conducted study reveals statistically significant differences in terms of reaction time, in favour of the left hand, the exception being the female' sub-group.

The most significant average differences between the reaction time of the right hand, compared to the left hand, were recorded for the left-handers' group. Based on these results, we posit that the transmission speed of the nerve impulse, corroborated with the sports training and the motoric prevalence, determined by the specialization of the cerebral hemisphere for the left hand is faster than the reaction speed for the right hand.

All these results contribute to rendering sports training more efficient.

References

1. Badau D (2006). Ambidexterity in motor activities, Transilvania University Press, 2:67, 78
2. Cojocarui A., Honceriu C. (2011). The effect of the specific training upon the values of the choice reaction time at the level of the upper limbs in the lawn tennis (16-18-year-old). *Revista Sport si Societate*, 79:79-84
3. Darbutas T, Juodžbalienė V, Skurvydas A, Kriščiūnas A (2013). Dependence of reaction time and movement speed on task complexity and age, *Medicina (Kaunas, Lithuania)*, 49(1):18-22
4. Davis, B. et al. (2000). Physical Education and the study of sport. 4th ed. Spain: Harcourt., 312
5. Dražen Čular, Đurdica Miletić, Alen Miletić (2010). Influence of dominant and non-dominant body side on specific performance in taekwondo, *Kinesiology* 42, 1,2:182-93
6. Geisert, E.E. (1980). Cortical projection of the lateral geniculate nucleus of the cat, *Journal Comp. Neurol.* 190, 793-812.
7. Guyton, A.C. (1996). Fiziologie, Ed. Medicală AMALTEA, 7:282, 346, 383, 390, 397, 579, 585.
8. Ritesh M. Karia, Tejas P. Ghuntla, Hemant B. Mehta, Pradnya A. Gokhale, Chinmay J. Shah (2012). Effect Of Gender Difference On Visual Reaction Time: A Study On Medical Students Of Bhavnagar Region, *IOSR Journal of Pharmacy*, Vol. 2, Issue 3, 452-454
9. Schiller, P., Malpeli J.G. (1978) Functional specificity of lateral geniculate nucleus laminae of the rhesus monkey, *Journal Neurophysiology* 41, 788-797.
10. Tadeusz Huciński, Janusz Łapszo, Roman Tymański and Pawel Zienkiewicz (2007).The relationship between the speed of motor reaction and short-distance runs and the effectiveness of play iIn defence and offense in basketball, *Kinesiology* 39, 2:157-164

THE INFLUENCE OF ATHLETIC BACKGROUND ON MUSCLE FORCE PRODUCTION

Aco Gajević, Jelena Ivanović and Nemanja Badnjarević

Serbian Institute of Sport and Sports Medicine, Belgrade, Serbia

Abstract

Aim of this work is to determine characteristics of maximal isometric force at four muscle groups in various trained and healthy male young athletes. 500 male athletes were tested from Taekwondo (N=19), Orienteering (N=11), Track and field (N=64), Table tennis (N=18), Karate (N=58), Handball (N=38), Hockey (N=37), Sport dance (N=23), Archery (N=84), Rugby (N=72), Weightlifting (N=29), Judo (N=37), Fencing (N=10). In order to assess characteristics of the maximal isometric force, tensiometric probe and standardized tests were used. Four muscle groups were tested: left (F_{\max} LHG) and right (F_{\max} RHG) hand grip, legs (standing position) (F_{\max} LEG) and back-waist extensors (isometric dead lift) (F_{\max} DL). Maximal isometric force characteristics was analysed according to absolute and relative (allometric, All) values. General Significant difference was established between subsamples for the measurement characteristics at the level of Wilks' Lambda 0.652, $F=4.573$, $p=0.000$. Statistically significant difference was also established in all tested contractile sub-fields regarding the function the observed sub-samples of different sports: F_{\max} LEG $F=8.657$, $p=0.000$; F_{\max} DL $F=10.005$, $p=0.000$; F_{\max} RHG $F=4.282$, $p=0.000$; F_{\max} LHG $F=5.596$, $p=0.000$; F_{allom} LEG $F=8.657$, $p=0.000$; F_{allom} DL $F=10.005$, $p=0.000$; F_{allom} RHG $F=4.282$, $p=0.000$; F_{allom} LHG $F=5.596$, $p=0.000$. The differences in all observed characteristics were established between tested athletes from different sport branches. They can be explained with differences in muscle tissue and maximal nervous activation of muscles during the specific training, i.e. adaptation to specific training. The results obtained will be useful while assessing decision criteria, for diagnostic purposes – standardized tests, for metrological purposes – analytic aspect of the obtained results.

Key words: *isometric force, hand grip, back-waist extensors, leg extensors, male athletes*

Introduction

Values of developed force generated during isometric (static) muscle contraction comprise the fundamental data on contractile ability (Dopsaj et al., 2010; Ivanović & Dopsaj, 2013). Contractile characteristics of different muscle groups are fundamental features in achieving top-level results in different sports, whether the emphasis is on speed, power, games, complex disciplines or endurance. Therefore, information on the force-time characteristics of a certain muscle group equates to basic information concerning the ability of an athlete, which is gathered with a view to controlling his physical preparation (Zatsiorsky & Kraemer, 2006). Results showed a significant correlation between different sport disciplines and the force efficiency of leg and back-waist extensors and muscles flexors of the dominant and non-dominant hand, in athletes with the most intense adaptation at force level, with regard to those whose level of training is unspecified and for those members of the population who are untrained (Dopsaj et al., 2010; Ivanović et al., 2011; Ivanović & Dopsaj, 2013). These differences can be explained by the use of different methods and models for conducting the training process. It is well known that two basic biological mechanisms are of great importance for top level athletes in training, namely homeostasis and adaptation (Milišić, 2007). Athletes are adapted to demonstrate muscle force and its characteristics differently. Assessing contractile characteristics of a certain muscle group is essential for different purposes such as diagnosing fitness level, monitoring training adaptations or identifying talent. The aim of this work is to determine characteristics of maximal isometric force at four muscle groups in various trained and healthy male young athletes.

Methods

Samples

A total of 500 male elite athletes (Age=16.47±0.79 years, Body mass=70.70±14.17 kg, Body height=178.18 cm, Body mass index=22.17±3.67 kg/m²) divided into 13 groups according to sport branch (Taekwondo N=19, Orienteering N=11, Track and field N=64, Table tennis N=18, Karate N=58, Handball N=38, Hockey N=37, Sport dance N=23, Archery N=84, Rugby N=72, Weightlifting N=29, Judo N=37, Fencing N=10) were tested. All examinees were members of the best national player teams in their age categories. All tests were performed in The Serbian Institute of sport and Sport Medicine in Belgrade by applying the same procedure and measuring device (method of isometric dynamometry). Four

muscle groups were tested: left (F_{\max} LHG) and right (F_{\max} RHG) hand grip, legs (standing position) (F_{\max} LEG) and back-waist extensors (isometric dead lift) (F_{\max} DL). Maximal isometric force characteristics was analysed according to absolute and relative values.

Testing procedure

The testing was realized through the hardware-software system (Institute Nikola Tesla, Belgrade) consisting of special cells ranging to 7500 N and with the sensitivity of 1.25 N. The A/D conversion of the force/time ratio was evaluated at the frequency of 100 kHz, and all the data of muscle force produced from the beginning of muscle contraction to its maximal values for each attempt were recorded in special databases. All the tests were carried out under isometric conditions on the following muscle groups: the extensors of the lower back by means of the “Dead lift” test; the muscles flexors of the dominant hand by means of the “Hand grip” test; the leg extensors, by means of the “Standing leg extension” test. The following mechanical characteristics were measured: the level of the maximal developed muscle strength, in Newtons (N) – F_{\max} and relative value of maximal isometric force by allometric partialisation. Maximal isometric hand grip allometric partialisation was done by applying the following procedure: $F_{\text{allom}} = F_{\max} / BM^{0.667}$ (Jarić et al., 2005). After a short warm up of three minutes, it was explained to the athletes what each particular test was, and after that the participants made their initial/probe attempts. After a five-minute break two measures were taken for every muscle group following the earlier described procedures (Rajić et al., 2004; Dopsaj et al., 2000; Dopsaj et al., 2001; Ivanovic & Dopsaj, 2012).

Statistical Analysis

All the results were processed applying the descriptive statistics as well as the multivariate statistical method – General Linear Method – multivariate procedure (Hair, 1998). All statistic analysis were done by the application of software package SPSS for Windows, Release 17.0 (Copyright © SPSS Inc., 1989–2002).

Results

The results of the descriptive statistic regarding different sports are shown in Table 1.

Table 1: Descriptive statistic analysis regarding the different sport

Descriptive Statistics per Sports ($\bar{X} \pm SD$)								
	F_{\max} LEG (N)	F_{\max} DL (N)	F_{\max} RHG (N)	F_{\max} LHG (N)	F_{allom} LEG (N/kg ^{0.667})	F_{allom} DL (N/kg ^{0.667})	F_{allom} RHG (N/kg ^{0.667})	F_{allom} LHG (N/kg ^{0.667})
Track and field	1494.03±311.04	1537.56±324.39	521.16±107.77	495.10±98.01	91.3533±19.0186	94.0151±19.8352	31.8663±6.5895	30.2730±5.9926
Weightlifting	1369.00±221.38	1416.02±229.78	507.41±88.83	466.82±86.46	83.7083±13.5363	86.5834±14.0503	31.0260±5.4315	28.5440±5.2867
Judo	1438.53±204.97	1483.43±270.31	503.23±88.41	483.08±89.98	87.9596±12.5328	90.7051±16.5280	30.7700±5.4057	29.5379±5.5020
Hockey	1213.79±214.27	1276.10±222.32	438.80±85.07	412.02±83.72	74.2177±13.1019	78.0274±13.5936	26.8305±5.2018	25.1932±5.1192
Karate	1179.57±261.35	1170.60±253.69	457.18±100.28	426.40±95.66	72.1252±15.9801	71.5771±15.5119	27.9545±6.1315	26.0722±5.8494
Fencing	1415.58±174.27	1384.19±213.85	535.63±54.17	461.07±58.50	86.5565±10.6556	84.6370±13.0760	32.7511±3.3121	28.1923±3.5767
Sport dance	1200.66±206.26	1259.95±213.94	469.17±71.95	444.01±76.63	73.4148±12.6118	77.0399±13.0817	28.6879±4.3992	27.1491±4.6856
Table tennis	1197.91±258.12	1243.15±274.70	400.58±95.19	370.60±71.97	73.2468±15.7831	76.0127±16.7964	24.4933±5.8202	22.6605±4.4009
Archery	1256.61±198.43	1266.54±197.28	467.84±83.63	435.38±70.16	76.8363±12.1331	77.4432±12.0627	28.6065±5.1136	26.6213±4.2902
Rugby	1272.17±225.94	1328.71±240.77	500.86±88.77	479.06±86.64	77.7872±13.8155	81.2446±14.7218	30.6250±5.4279	29.2920±5.2976
Handball	1378.56±186.98	1504.54±264.73	497.99±107.64	460.04±66.21	84.2929±11.4329	91.9960±16.1871	30.4496±6.5819	28.1292±4.0486
Taekwondo	1260.84±192.05	1305.25±209.80	482.76±100.98	438.87±68.27	77.0948±11.7431	79.8099±12.8285	29.5183±6.1743	26.8348±4.1742
Orienteering	1170.96±207.56	1164.71±224.31	474.45±89.30	438.77±65.53	71.5987±12.6913	71.2170±13.7154	29.0103±5.4600	26.8291±4.0067

The results of partial differences between observed contractile variables of the flexors of the dominant and non-dominant hand among tested sports are shown in Table 2.

Table 2: Partial differences between the observed variables of the flexors of the dominant and non-dominant hand in the tested groups

Absolute values of the flexors of the dominant hand	(I) sub-sample	(J) sub-sample	MAD (I-J)	Sig.	Relative values of the flexors of the dominant hand	(I) sub-sample	(J) sub-sample	MAD (I-J)	Sig.
	Absolute values of the flexors of the dominant hand	Track and field	Hockey	82.36		0.002	Track and field	Hockey	Hockey
Karate			63.98	0.013	Karate	Karate		3.9119	0.013
Table tennis			120.58	0.000	Table tennis	Table tennis		7.3730	0.000
Archery			53.31	0.045	Archery	Archery		3.2598	0.045
Weightlifting		Table tennis	106.84	0.011	Weightlifting	Table tennis	6.5327	0.011	
Judo		Table tennis	102.65	0.010	Judo	Table tennis	6.2767	0.010	
Fencing		Table tennis	135.05	0.019	Fencing	Table tennis	8.2578	0.019	
Table tennis		Rugby	-100.28	0.004	Table tennis	Rugby	Rugby	-6.1317	0.004
		Handball	-97.41	0.021		Handball	Handball	-5.9563	0.021
Absolute values of the flexors of the non-dominant hand		Track and field	Hockey	83.08	0.000	Track and field	Hockey	Hockey	5.0799
	Karate		68.70	0.000	Karate		Karate	4.2008	0.000
	Table tennis		124.50	0.000	Table tennis		Table tennis	7.6125	0.000
	Archery		59.72	0.001	Archery		Archery	3.6517	0.001
	Weightlifting	Table tennis	96.22	0.010	Weightlifting	Table tennis	5.8835	0.010	
	Judo	Hockey	71.06	0.020	Judo	Hockey	Hockey	4.3448	0.020
		Table tennis	112.48	0.000		Table tennis	Table tennis	6.8774	0.000
	Hockey	Rugby	-67.04	0.006	Hockey	Rugby	Rugby	-4.0989	0.006
	Karate	Rugby	-52.66	0.028	Karate	Rugby	Rugby	-3.2198	0.028
	Table tennis	Rugby	-108.46	0.000	Table tennis	Rugby	Rugby	-6.6315	0.000
		Handball	-89.44	0.015		Handball	Handball	-5.4687	0.015

Multivariate statistical analysis established that there is a significant difference at all contractile characteristics at the level of Wilks' Lambda 0.652, $F=4.573$, $p=0.000$, among the observed sub-samples in different sports. Statistically significant difference was also established in all tested contractile sub-fields regarding the function the observed sub-samples of different sports: $F_{max}LEG F=8.657$, $p=0.000$; $F_{max}DL F=10.005$, $p=0.000$; $F_{max}RHG F=4.282$, $p=0.000$; $F_{max}LHG F=5.596$, $p=0.000$; $F_{allom}LEG F=8.657$, $p=0.000$; $F_{allom}DL F=10.005$, $p=0.000$; $F_{allom}RHG F=4.282$, $p=0.000$; $F_{allom}LHG F=5.596$, $p=0.000$. The results of partial differences between observed contractile variables of leg extensors and the extensors of the lower back among tested sports are shown in Table 3.

Table 3: Partial differences between the observed variables of leg extensors and the extensors of the lower back in the tested groups

Absolute values of leg extensors muscle	(I) sub-sample	(J) sub-ample	MAD (I-J)	Sig.	Relative values of leg extensors muscle	(I) sub-sample	(J) sub-sample	MAD (I-J)	Sig.
	Absolute values of leg extensors muscle	Track and field	Hockey	280.23		0.000	Track and field	Hockey	Hockey
Karate			314.45	0.000	Karate	Karate		19.2281	0.000
Sport dance			293.36	0.000	Sport dance	Sport dance		17.9385	0.000
Table tennis			296.12	0.000	Table tennis	Table tennis		18.1064	0.000
Archery			237.42	0.000	Archery	Archery		14.5171	0.000
Rugby			221.87	0.000	Rugby	Rugby		13.5661	0.000
Taekwondo			233.19	0.010	Taekwondo	Taekwondo		14.2584	0.010
Orienteering			323.07	0.002	Orienteering	Orienteering		19.7545	0.002
Weightlifting		Karate	189.43	0.028	Weightlifting	Karate	Karate	11.5831	0.028
Judo		Hockey	224.73	0.003	Judo	Hockey	Hockey	13.7418	0.003
		Karate	258.95	0.000		Karate	Karate	15.8343	0.000
		Sport dance	237.86	0.010		Sport dance	Sport dance	14.5447	0.010
		Table tennis	240.61	0.026		Table tennis	Table tennis	14.7127	0.026
		Archery	181.91	0.006		Archery	Archery	11.1233	0.006
Karate	Rugby	166.35	0.033	Karate	Rugby	Rugby	10.1723	0.033	
	Handball	-198.99	0.004		Handball	Handball	-12.1676	0.004	

Absolute values of extensors of the lower back		Relative values of extensors of the lower back							
Absolute values of extensors of the lower back	Track and field	Hockey	261.47	0.000	Relative values of extensors of the lower back	Track and field	Hockey	15.9876	0.000
		Karate	366.95	0.000			Karate	22.4379	0.000
		Sport dance	277.62	0.000			Sport dance	16.9751	0.000
		Table tennis	294.42	0.001			Table tennis	18.0023	0.001
		Archery	271.01	0.000			Archery	16.5718	0.000
		Rugby	208.84	0.000			Rugby	12.7704	0.000
		Taekwondo	232.32	0.030			Taekwondo	14.2051	0.030
		Orienteering	372.85	0.000			Orienteering	22.7980	0.000
	Weightlifting	Karate	245.42	0.001		Weightlifting	Karate	15.0062	0.001
		Judo	Hockey	207.33			0.029	Judo	Hockey
	Karate		312.83	0.000		Karate	19.1279		0.000
	Archery		216.88	0.001		Archery	13.2618		0.001
	Orienteering		318.72	0.017		Orienteering	19.4880		0.017
	Hockey	Handball	-228.45	0.006		Hockey	Handball	-13.9686	0.006
		Karate	Rugby	-158.11			0.027	Karate	Rugby
	Handball		-333.93	0.000		Handball	-20.4189		0.000
	Sport dance	Handball	-244.59	0.017		Handball	Sport dance	14.9561	0.017
	Table tennis	Handball	-261.39	0.021			Table tennis	15.9833	0.021
	Archery	Handball	-238.01	0.000			Archery	14.5528	0.000
	Rugby	Handball	-175.82	0.036			Rugby	10.7514	0.036
Handball	Orienteering	339.83	0.006	Orienteering	20.7790	0.006			

Discussion and conclusions

The highest average value of almost all observed characteristics was measured in track and field and minimal in orienteering and table tennis (Table 3-4), which is understandable considering the nature of these sports. In elite strength athletes, as a result of adaptation to long-term training load specificity on maximal force, strength and power, values which were above the average were established in relation to other sports, as well as to the control population (Dopsaj et al., 2010; Ivanovic et al., 2011; Ivanovic & Dopsaj, 2012; Ivanovic & Dopsaj, 2013). As mentioned before, previous research had demonstrated the importance of isometric force and strength to successful performance in a range of different sports. The existence of interaction between sport discipline and force production in regard to unspecific trained and untrained population isn't surprising, especially in athletes, for whom the adaptation is the most intensive at the force level. Different training methods, overall intensity and dimension and/or type of explosive and strength training during the training process, differences in muscle tissue and maximal nervous activation of muscles during the specific training, i.e. adaptation to specific training is most likely the reason why athletes are adapted to demonstrate muscle force and its characteristics differently (Dopsaj et al., 2010; Ivanovic et al., 2011; Ivanovic & Dopsaj, 2012; Ivanovic & Dopsaj, 2013; Hakkinen, 1991; Aagaard, Simonsen, Andersen, Magnusson & Poulsen, 2002). A comparison with the results published by others researchers (Hakkinen, 1991; Aagaard et al., 2002) and our previous research (Dopsaj et al., 2010; Ivanovic et al., 2011; Ivanovic & Dopsaj, 2012; Ivanovic & Dopsaj, 2013), shows a positive correlation with our results. For example, Power Lifters who usually perform heavy-resistance training programmes, that is performed over the years may have produced long term training-induced increases in the maximal voluntary neural drive to the muscles associated with increased rapid neural activation of motor units and/or selective hypertrophy or transformation of type II muscle fibres into stronger counterparts (Dopsaj et al., 2009). The same phenomenon was established in highly trained female athletes from sports which are known to require significantly strong hand grip strength – Karate and Handball, which are significantly stronger than their untrained female counterparts (Ivanović & Dopsaj, 2012), also in highly trained female volleyball players, where were established different factor structure of indicators for evaluating isometric leg extensors explosive force in regard to different trained populations (Ivanović et al., 2011). The results of factor analysis of the observed indicators for evaluating leg extensors explosiveness showed that separated variables and factors belong to the space that is responsible, from the motor aspect, for realization of the specific technical and tactical requirements, frequent changes of direction in frontal and lateral plane, numerous high and long jumps in volleyball.

Besides the fact that muscle force play an important role in sports that have been analyzed in this research, due to years of training and competing athletes have adapted to express muscle force and its characteristics in different ways. With the obtained results we will be able to define the influence of different sports on the observed contractile characteristics and the level of the specific adaptation in different sports. Generally, presented results can serve as criteria for any future sports training technology improvement according to male youth athletes as well as considering long term planning process.

References

1. Aagaard, P., Simonsen, E.B., Andersen, J.L., Magnusson, P., & Poulsen, P.D. (2002). Increased rate of force development and neural drive of human skeletal muscle following resistance training. *Journal of Applied Physiology*, 93, 1318–1326.
2. Dopsaj, M., Milošević, M., & Blagojević M. (2000). An analysis of the reliability and factorial validity of selected muscle strength mechanical characteristics during isometric multi-joint test. In Y. Hong & D. P. Johns (Eds.), *Proceedings of XVIII International Symposium on Biomechanics in Sport*, (pp. 146-149). Hong Kong: The Chinese University.
3. Dopsaj, M., Ivanović, J., Blagojević, M., Koropanovski, N., Vučković, G., Janković, R., Marinković, B., Atanasov, D., & Miljuš, D. (2009). Basic and specific characteristics of the hand grip explosive force and time parameters in different strength trained population. *Brazilian Journal of Biomechanics*, 3(2), 177–193.
4. Dopsaj, M., Blagojević, M., Koropanovski, N., & Vučković, G. (2010). Structural analysis of basic leg extensor F-t curve characteristics in male athletes in different sports measured in standing position. In: M. Duncan, M. Lyons (Eds.), *Trends in Human Performance Research* (pp. 53–70). Hauppauge, NY: Nova Science Publisher.
5. Hair, J., Anderson, R., Tatham, R. & Black, W. (1998). *Multivariate data analysis*. Prentice - Hall, Inc: New Jersey.
6. Hakkinen, K. (1991). Force production characteristics of leg extensor, trunk flexor and extensor muscles in male and female basketball players. *Journal of Sports Medicine and Physical Fitness*, 31, 325-331.
7. Ivanović, J., Dopsaj, M., & Nešić, G. (2011). Factor structure differences of indicators for evaluating isometric leg extensors explosive force in female volleyball athletes and different trained female population. *British Journal of Sports Medicine*, 45: 542.
8. Ivanović, J., Dopsaj, M. (2012). Functional dimorphism and characteristics of maximal hand grip force in top level female athletes. *Collegium Antropologicum*, 36 (4): 1231-1240.
9. Ivanović, J., & Dopsaj, M. (2013). Reliability of force-time curve characteristics during maximal isometric leg press in differently trained high-level athletes. *Measurement*, 46 (7): 2146–2154.
10. Jaric, S., Mirkov, D., & Markovic, G. (2005) Normalization of muscle strength and movement performance tests for body size: A proposal for standardization. *Journal of Strength and Conditioning Research*, 19:467–474.
11. Milišić, B. (2007). Efficiency in sport and training management theory. *Serbian Journal of Sports Sciences*, 1(1–4), 7–13.
12. Rajić, B., Dopsaj, M., & Abela, C.P. (2004). The influence of the combined method on the development of explosive strength in female volleyball players and on the isometric muscle strength of different muscle. *Groups Facta Universitatis. Series: Physical Education and Sport*, 2(1), 1–12.
13. Zatsiorsky, V.M. & Kraemer W.J. (2006). *Science and practice of strength training* (2nd ed.), Champaign, IL: Human Kinetics.

COMPARISON OF TRUNK MUSCLES' ACTIVATION AND PERCEIVED SITTING DISCOMFORT ON A STANDARD OFFICE CHAIR AND A NOVEL ACTIVE CHAIR®

Mitja Gerževič¹ and Veronika Mikuletič²

¹University of Primorska, Science and Research Centre, Institute for Kinesiology Research, Koper, Slovenia

²University of Primorska, Faculty of Mathematics, Natural Sciences and Information Technologies, Applied Kinesiology, Koper, Slovenia

Abstract

The purpose of this study was to evaluate differences in trunk muscles' activation and perceived sitting discomfort during prolonged office-computer work on a standard office chair and a chair with unstable seat Active Chair®. Fourteen healthy volunteers (6 men, 8 women), aged 22.4 ± 2.2 years, body mass 65.0 ± 11.8 kg; body height 169.9 ± 11.6 m, performed four 15-minute long computerized office tasks. While performing the tasks electromyography (EMG) activity of eight trunk muscles (left and right lower *trapezius* (LT), *erector spinae* (ES), *rectus abdominis* (RA) and *obliquus externus* (OE)) and the overall level of perceived sitting discomfort at the beginning and after each task were measured and analyzed. The results showed that the average EMG activity of back and abdominal muscles during 1 hour of work on the Active Chair® was only 1.35% of the maximum voluntary contraction (MVC) and was not significantly different from the standard chair ($p = .323$). On the Active Chair® the right ES activity was significantly lower ($p = .002$), while the activity of the left OE was significantly higher ($p = .026$) compared to the standard office chair. The overall level of perceived sitting discomfort on the Active Chair® at the beginning (40.2 ± 26.0 mm; $p = .001$) and at the end (65.7 ± 25.7 mm; $p < .001$) of 1-hour work was significantly higher compared to the standard office chair at the end of 1-hour work (9.1 mm). However, the discomfort level on the Active Chair® increased significantly only after 45 minutes (61.0 ± 20.9 mm; $p = .024$). It could be concluded that sitting on the Active Chair® increases the activity of some muscles, but it is relatively low considering muscles' activity during MVC. The overall level of sitting discomfort on the Active Chair® is higher than on a standard office chair, which is somehow expected for these types of chairs, yet it could still be improved.

Key words: active sitting, electromyography, unstable seat, computerized office work

Introduction

With the rise in sedentary work and all the negative consequences that could arise from it influencing human locomotor apparatus, the importance of workplace exercise, physical activity and training aids for their implementation are increasingly emphasized. Among many, sitting on stability balls or chairs with unstable seats are often recommended and promoted as "active sitting", an alternative to a standard office chair and an efficient way to prevent and reduce low back pain as well as to increase muscle work, strength and blood flow. However, little research has been done to evaluate this (Gregory, Dunk & Callaghan, 2006; McGill, Kavcic & Harvey, 2006; Schult et al., 2013). Therefore, it was the purpose of this study to evaluate differences in trunk muscles' activation and perceived sitting discomfort during prolonged office-computer work on a standard office chair and a novel chair with unstable seat Active Chair®. There were three main objectives: i) to evaluate the differences in the activity of back and abdominal muscles during 1 hour of computerized office work on a standard chair and the Active Chair®, ii) to identify if there are differences in the overall level of perceived sitting discomfort between the two chairs and iii) when the level of perceived discomfort on the Active Chair® during 1-hour working time significantly increases.

Methods

Fourteen healthy adult volunteers (6 men, 8 women), aged between 19 and 28 years (Table 1), randomly performed four 15-minute long computerized office tasks on the Active Chair® (Figure 1a). The tasks included: i) typing, ii) computer-aided design, iii) typing/mouse combined work, and iv) reading from the monitor (Figure 1b).

Table 1: Sample's basic characteristics (average \pm 1 SD)

Gender	n	Age (years)	Mass (kg)	Height (cm)
Male	6	22.5 ± 0.5	76.0 ± 3.2	181.7 ± 4.7
Female	8	22.3 ± 3.0	56.8 ± 8.5	161.1 ± 5.1
Total	14	22.4 ± 2.2	65.0 ± 11.8	169.9 ± 11.6

Before and immediately after each 15-minute task the participants rated the overall level of perceived sitting discomfort on a 100-millimeter Visual Analogue Scale (VAS; Hawker et al., 2011), where 0 mm stood for very comfortable and 100 mm for very uncomfortable. During the tasks bipolar surface electromyography (EMG) signal of eight muscles (lower trapezius (LT), erector spinae (ES), rectus abdominis (RA) and obliquus externus (OE)) was recorded on the left and right side.

Two self-adhesive disposable Ag/AgCl electrodes Ambu BlueSensor N (Ambu A/S, Ballerup, Denmark) were placed on each muscle's belly according to SENIAM recommendations (Hermens et al., 1999; Figure 1c) with the reference electrode on the anterior superior iliac spine. Raw EMG signals were sampled at 3000 Hz and band-pass filtered from 10 Hz to 500 Hz with a Butterworth filter using an 8-channel telemetric system TeleMyo 2400T G2 (Noraxon U.S.A. Inc., Scottsdale, USA). The EMG data were then processed off-line, using MyoResearch XP Clinical Application Protocol 1.07 software (Noraxon U.S.A. Inc., Scottsdale, USA): i) passed through a bi-directional Butterworth filter with a cut-off frequency of 2.5 Hz, ii) rectified and ii) smoothed using root mean square (RMS) on a time window of 50 ms to produce a linear envelope for each eight muscles. The data were normalized to the maximum average RMS value on a 500-ms interval during maximum voluntary contraction (MVC) performed in the position for crunches (supine, bended knees, arms crossed on the chest, flexed trunk $\sim 30^\circ$), rotation crunches (supine, bended knees, arms crossed on the chest, flexed trunk $\sim 30^\circ$ and rotated left/right side) and trunk extension (trunk over the bench in line with legs (0°), palms behind the neck, elbows in line with shoulders). Average RMS values (expressed as % MVC) of each muscle and each 15-minute interval, while performing the computerized office tasks were considered for further analysis.



Figure 1: Representation of a) a novel chair with unstable seat (Active Chair[®]), b) a computerized office task while measuring EMG activity on the Active Chair[®] and c) EMG electrodes positions for left and right lower trapezius and erector spinae (upper picture) and rectus abdominis and obliquus externus (lower picture) muscles.

The measuring protocol was carried out along the lines of Gregory, Dunk & Callaghan (2006), who compared muscle activation, lumbar spine posture and perceived discomfort during 1 hour of computerized office work on a therapeutic ball with the standard office chair. Thus, using one-sample t-test, the data of muscles' activation and the level of perceived sitting discomfort on the Active Chair[®] were compared to the data obtained for the standard office chair by Gregory, Dunk & Callaghan (2006). Differences in the scores of perceived sitting discomfort on the Active Chair[®] in time were analyzed with ANOVA for repeated measurements. If there were significant differences Bonferroni correction was used for post-hoc analysis. All analyses were performed using the IBM SPSS Statistics 20.0 software (IBM Corporation, Armonk, New York, USA) and the statistical significance was set at the p-level < .05 (two-tailed).

Results

All muscle activation parameters (average RMS values) were not normally distributed ($p < .05$), except the RMS of the right ES muscle. Therefore, instead of a parametric one-sample t-test, a Wilcoxon's non-parametric one-sample t-test was used. However, the sitting discomfort parameters were normally distributed ($p > .05$).

The analyses showed the overall average muscle activation for all four 15-minute tasks and all eight muscles was $1.35 \pm 0.54\%$ on the Active Chair[®] which was not significantly different ($p = .323$) compared to the standard chair ($1.07 \pm 0.48\%$; Gregory, Dunk & Callaghan, 2006). On the Active Chair[®] the activation of right ES muscle was significantly lower ($p = .002$), while that of the left OE muscle was significantly higher ($p = .026$) in comparison with the standard office chair (Figure 2), but the effect size was large only for the left OE muscle (Cohen's $d = 2.0$).

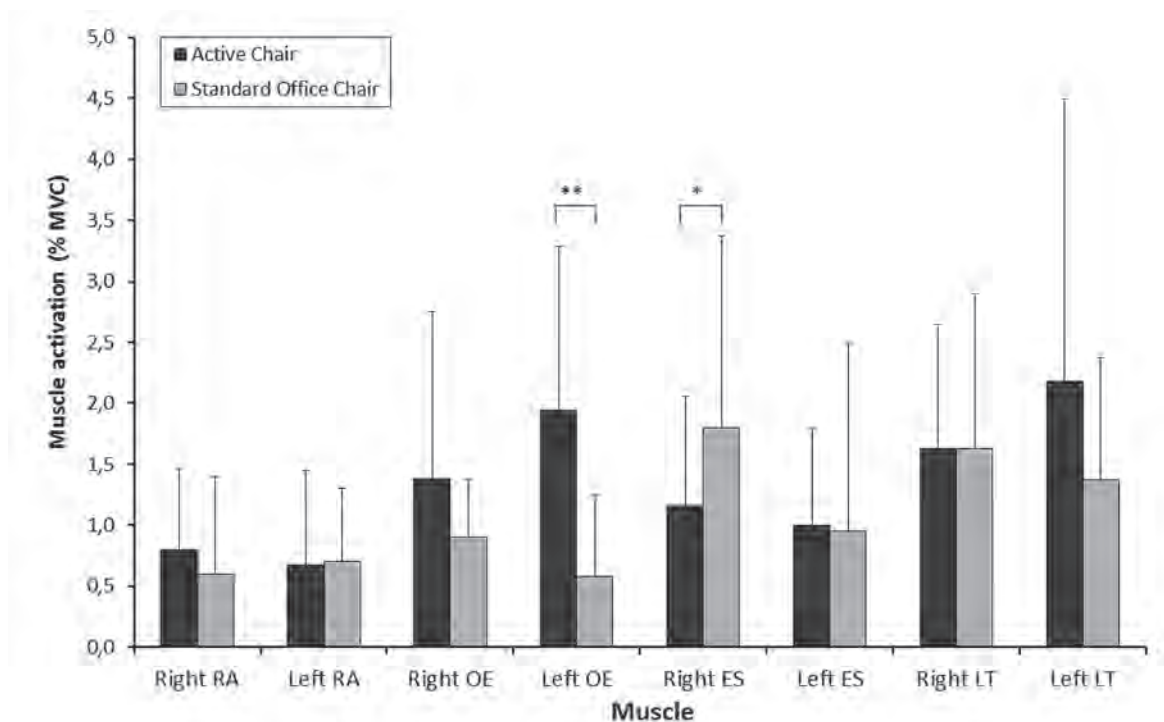

Figure 2: Average muscle activation (RMS), expressed as% of maximal voluntary contraction for right and left rectus abdominis (RA), obliquus externus (OE), erector spinae (ES), and lower trapezius (LT) during 1-hour computerized office work on the Active Chair[®] (dark grey bars) and the standard office chair (light grey bars). Values for the standard office chair were taken from the study Gregory, Dunk & Callaghan (2006). Significant differences are marked with asterisks: * – $p < .05$, ** – $p < .01$.

The level of perceived sitting discomfort on the Active Chair[®] increased with time (Figure 3a). Compared to the initial value (40.2 ± 26.0 mm) the level of discomfort increased significantly after 45 minutes (61.0 ± 20.9 mm; $p = .024$) and 60 minutes (65.7 ± 25.7 mm; $p = .001$) of work with large effect sizes ($d_{0-45\text{min}} = .81$ and $d_{0-60\text{min}} = .98$). The discomfort level after 1 hour of computerized office work on the standard chair (9.1 mm) showed to be significantly lower than that on the Active Chair[®], both at the beginning ($p = .001$) and at the end ($p < .001$) of 1-hour work (Figure 3b).

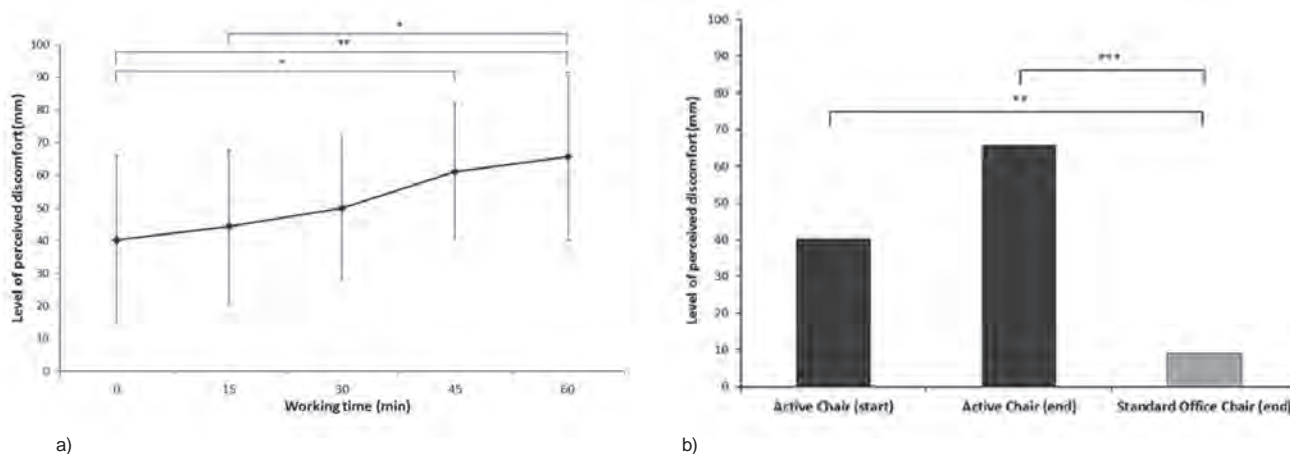

Figure 3: Representation of a) the increase in the perceived sitting discomfort with the increase in working time on the Active Chair[®] before (time 0 min) and immediately after each 15-minute task (time 15, 30, 45 and 60 min) of computerized office work and b) the differences in the perceived sitting discomfort level between the Active Chair[®] at the beginning (start) and at the end (end) of 1-hour work and the discomfort level on a standard office chair after 1-hour work (end). Values for the standard office chair were taken from the study Gregory, Dunk & Callaghan (2006). Significant differences are marked with asterisks: * – $p < 0.05$, ** – $p < 0.01$, *** – $p < 0.001$.

Discussion and conclusion

The present study showed that the overall average muscle activation during 1 hour of computerized office work on the Active Chair® (1.35% MVC) is low and it is not significantly different from the activation on the standard office chair. This is in accordance with similar studies (Gregory, Dunk & Callaghan, 2006; McGill, Kavcic & Harvey, 2006) where sitting/working on standard (stable) chairs was compared with stability balls. The advantage of the latter showed to be only in a reduced pelvic tilt (Gregory, Dunk & Callaghan, 2006), which could be assumed also for the Active Chair®, but unfortunately spine kinematics was not measured in the present study. The Active Chair® showed to induce a significantly greater activation of left OE muscle, which could be a consequence of unilateral mouse work with the right hand (all participants were right-handed) and it was generally much more uncomfortable than the standard office chair already at the beginning of the work. The discomfort increased with working time, reaching significant difference after 45 minutes. These results are in accordance with the before mentioned older studies as well as with the latest one (Grooten et al., 2013), where postural sway, sway velocities and muscle activation, surprisingly, showed to be smaller during “active sitting” (chair without backrest) and standing compared to standard office chair condition.

Therefore, it could be concluded that from the muscle activation perspective the Active Chair® do not have any advantages compared to standard office chairs. Namely, muscle activation does not reach even a minimal value typical for normal walking (5–80% MVC). Safety and well-being are also questionable due to the higher level of sitting discomfort on the Active Chair®, which is on the other hand expected for these types of chairs, yet it still could be improved with optional height adjustment of the seat, possibility of fixing the seat as well as changing position during sitting.

References

1. Hawker, G.A., Mian, S., Kendzerska, T. & French, M. (2011). Measures of adult pain: Visual Analog Scale for Pain (VAS Pain), Numeric Rating Scale for Pain (NRS Pain), McGill Pain Questionnaire (MPQ), Short-Form McGill Pain Questionnaire (SF-MPQ), Chronic Pain Grade Scale (CPGS), Short Form-36 Bodily Pain Scale (SF-36 BPS), and Measure of Intermittent and Constant Osteoarthritis Pain (ICOAP). *Arthritis Care & Research*, 63(Suppl 11), S240–252.
2. Hermens, H.J., Freriks, B., Merletti, R., Hägg, G.G., Stegeman, D., Blok, J. et al. (1999). *European recommendations for surface electromyography*. Enschede: Roessingh Research and Development.
3. Gregory, D.E., Dunk, N.M. & Callaghan, J.P. (2006). Stability ball versus office chair: comparison of muscle activation and lumbar spine posture during prolonged sitting. *Human Factors*, 48(1), 142–153.
4. Grooten, W.J., Conradsson, D., Ang, B.O. & Franzén, E. (2013). Is active sitting as active as we think? *Ergonomics*, 56(8), 1304–1314.
5. McGill, S.M., Kavcic, N.S. & Harvey, E. (2006). Sitting on a chair or an exercise ball: various perspectives to guide decision making. *Clinical Biomechanics*, 21(4), 535–560.
6. Schult, T.M., Awosika, E.R., Schmunk, S.K., Hodgson, M.J., Heymach, B.L. & Parker, C.D. (2013). Sitting on stability balls: biomechanics evaluation in a workplace setting. *Journal of Occupational and Environmental Hygiene*, 10(2), 55–63.

Acknowledgements

This study was part of a project entitled “*With active sitting to better health and higher working efficiency*” which was financially approved within the Public call for co-financing projects for health promotion at working place in 2013-2014 by the Health Insurance Institute of Slovenia and co-financed by PFEIFER, Boris Pfeifer s.p.

FUNCTIONAL RELATIONSHIPS AMONG KINEMATIC AND KINETIC PARAMETERS OF BACKWARD SOMERSAULTS

Željko Hraski

Faculty of Kinesiology, University of Zagreb, Croatia

Abstract

In this paper, on the base of correlation analysis applied on the biomechanical parameters extracted from the execution of seven different types of backward somersaults, functional relations among kinematic and kinetic variables have been analysed. The obtained results showed, on the descriptive level, numerous interactions among selected variables, especially those concerning the touch-down and take-off parameters, parameters of the CG trajectory and values of the angular momentum.

Key words: gymnastics, biomechanics, correlation analysis, cluster analysis

Introduction

A different type of backward somersaults assumes great varieties in the basic biomechanical parameters that define the take-off, flight phase and landing of a gymnast. At the same time, considering that all types of back somersaults are classified under the biomechanically very determined definition of the basic form of somersault, it is supposed that there are many similarities in these parameters, as well as in their mutual relations. The question is how gymnasts and coaches are dealing with these differences and similarities, which are changing from, e.g. a single layout somersault with triple rotation around the longitudinal axis to double back tucked somersault with double rotation around the longitudinal axis? This issue does not extend only to the competitive situation, but also on the procedure of learning and mastering these gymnastics elements. Thus, a relatively large number of authors have analyzed various characteristics of efficient execution of this gymnastic element (Bruggemann 1987., Hwang at al. 1990., Knoll 1993., Hong and Bruggemann 1993., Geiblinger at al. 1995., Cuk and Ferkolj 2000., Hraski 2002., Hraski and Mejovsek 2004., King and Yeadon 2004., Mkaouer at al., 2013.).

As an attempt to contribute to a better understanding of this issue, the goal of this study was to determine the functional connectivity and the hierarchical structure of kinematic and kinetic variables relevant for the successful execution in seven most typical, but significantly different types (according to the number of rotations and the position of the body) of backward somersaults.

Methods

The subject of this study was a highly ranked, world-class gymnast. According to his basic anthropometric measures (height 164 cm, mass 57.5 kg), he can be considered as a typical morphologic type of the elite gymnasts. Acquisition of the video data was made on the training organized for the purpose of this research. Successful single executions of seven different types of backward somersault have been subjected to further analysis: tuck, pike, layout, layout with twist (360°), double tuck, double layout and double tuck with twist (360°). All types of backward somersault are executed from the typical preparatory tumbling series: approach, round off, and back handspring. The collected video images (60 Hz) were digitized and processed with APAS system. Selected parameters of touch-down, take-off, flight phase and landing of each type of somersault are extracted. Angular momentums were calculated by customized software program written in Statistica 6.0. Functional relationships among selected variables were examined on the descriptive level by correlational analysis. Hierarchical structure of selected variables based on correlation coefficients of their interdependence was explored by cluster analysis.

Results and discussion

When performing somersault, the shape of the gymnasts CG trajectory, his vertical (D_y) and horizontal (D_x) transfer, is defined as a function of velocity (V), the take-off angle (α) and flight duration (T):

$$D_x, D_y = f(V, \alpha, T) \quad (1)$$

As the velocity of the gymnasts CG is formed by two components, it can also be written as:

$$D_x, D_y = f(V_x, V_y, \alpha, T) \quad (2)$$

The results of the correlation analysis are supporting both equations. According to them the maximum height of the flight is highly correlated with all biomechanical parameters that form the equation of the gymnasts CG trajectory (1, 2). It is important to note that, from the judges and coaches' point of view, the flight height is the most interesting parameter of the CG trajectory. In the case of this study the flight height is related with vertical velocity (.80), take-off angle (.82) and duration of the flight (.99) and negatively with horizontal velocity of take-off (-.81). In other words the trajectory of the gymnasts CG, while performing any type of backward somersault, will be higher with the greater vertical velocity of take-off, the greater take-off angle and, naturally, the longer duration of the flight. In the same time horizontal velocity of the take-off must be as low as possible. Since the vertical and horizontal component of the take-off velocity, generated through the last part of a back handspring, obtain their final values at the end of take-off, the transfer efficiency of the horizontal to the vertical impulse will depend on a number of factors, i.e., the angle of attack at touch down after back handspring and, of course, on the force of the take-off.

Furthermore, velocity of the gymnasts CG, represented through its horizontal and vertical component, depends on the velocity at touch-down (V_i) and change of the velocity during the take-off (ΔV):

$$V_x \ V_y = f(V_i, \Delta V) \quad (3)$$

In this study the equation (3) is confirmed with high correlation coefficient values of the horizontal (.89) and vertical (-.90) velocity of CG at the take-off with the CG velocity at the touch-down, as well as with the change of the CG velocity during the take-off. It should be noted that it primarily refers to the horizontal component of the initial velocity (-.91) and the change of the vertical component of velocity during the take-off (.96). It can be concluded that with the higher velocity change during the take-off, the greater will be the vertical and lower the horizontal component of the velocity at the take-off.

Furthermore, the angle of the take-off (α) is defined by the vectors of the velocity components at the end of the take-off (V_x, V_y):

$$\alpha = f(V_x, V_y) \quad (4)$$

This equation (4) has its understandable stronghold, whereby it should be emphasized that the correlation of the take-off angle with the vertical velocity (.99) dominates in regard to the horizontal velocity (.87) of the take-off.

Also, the angle of the take-off (α) is defined with all of the parameters responsible for the formation of the horizontal and vertical velocity components:

$$\alpha = f(V_i, \alpha_i, \bar{F}, T_k, m) \quad (5)$$

Consequently, the correlation coefficient of take-off angle and touch-down velocity is -.92. As the touch down velocity is almost fully formed with its horizontal component, its high correlation with the take-off angle (-.90), is understandable. Correlation of the take-off angle with the average force is somewhat lower (.67), and mass and duration of the contact are constants.

Additionally, the duration of the flight is determined by the speed of take-off velocity components (V_x, V_y), take-off angle (α) and the gymnasts mass (m):

$$T_{CT} = f(V_x, V_y, \alpha, M) \quad (6)$$

The results of the correlation analysis are confirming this equation (6). It is evident that the duration of the flight would be shorter with higher values of horizontal (-.77) and lower values of vertical (.72) velocity at the take-off.

Furthermore, since in everyday gymnastic practice, the most interesting and not enough examined question is: how to achieve the maximum height of the flight with sufficient rotation for successful execution of the specific somersault type, it is interesting to analyse the relations among basic values of angular momentum around the gymnast's transverse axis and kinematic parameters that determine the gymnast's CG trajectory. The basic values of angular momentum are considered as: angular momentum at touchdown, angular momentum at take-off and average angular momentum during the flight phase.

According to the results of the correlation analysis, the initial value of angular momentum (at touch-down) is related with CG height at touchdown (.82) and landing (-.88). Obviously, the initial value of angular momentum will be greater with the higher position of the gymnast's CG at the end of backward handspring, e.g. in the moment of the first foot contact with the floor. Also, the initial value of angular momentum is relatively highly related with horizontal speed at touch-down. The angular momentum around transverse axis at take-off is as well related with a series of variables which define the CG trajectory. It is also positively related with the CG velocity at the touch-down (.86), with specific reference to its horizontal component (.88). Afterwards, it is negatively related with velocity change during take-off (-.77) and take-off angle (-.80). Also, angular momentum at take-off is positively related with horizontal (.83), and negatively with vertical (-.77) component of velocity at take-off. During the flight phase, which is very important from the competitive point of view – maximization of the height, angular momentum at take-off is negatively related with maximal height of CG trajectory (-.87). It proves the theory that the creation of a larger amount of angular momentum necessarily spends a certain amount of the flight height. Angular momentum at take-off will be greater with greater velocity at touch-down. Since it is primarily formed by its horizontal component, high value of this correlation coefficient was expected (.88).

Furthermore, angular momentum at the end of take-off will be greater with the smaller change of velocity during take-off, as well as with the lower take-off angle. Consequently, the duration of the flight (relative to CG height) is negatively related with the angular momentum at take-off. In other words, the duration of the flight will be longer with the lower value of the angular momentum at the take-off, which is closely related with the previously described velocity components and take-off angles.

As previously mentioned, the relationships between selected parameters of the CG trajectory and average angular momentum during the flight phase are specifically interesting for coaches and gymnasts.

Thus, average angular momentum during the flight phase is related (.76) with angular momentum at touch-down. This means that greater angular momentum around the transverse axis of the gymnast's body, generated through preparatory elements, will produce the greater amount of average angular momentum at the flight phase. Moreover, average angular momentum during the flight phase will be greater with greater horizontal velocity at touch-down. Especially interesting is the high positive relationship with angle of CG at touch-down (.93). In other words average angular momentum during the flight phase will be greater with a higher position of CG at touch-down (attack angle). It can be presumed that high positioning of CG disables effective development of ground reaction forces necessary for the efficient transfer from horizontal to vertical take-off impulse. Changes of the values of selected parameters are also related with the average angular momentum registered through the flight phase. Furthermore, it is also related with the velocity change during the take-off (-.82), as well as with the take-off angle. The smaller the degree of the velocity loss during take-off, and the lower the take-off angle, the greater will be the average angular momentum during the flight. As it was the case with the angular momentum at take-off, average angular momentum during the flight phase is positively related with horizontal, and negatively with vertical take-off velocity, although, there was a stronger relationship with the vertical component (-.84). Average angular momentum during the flight will be greater with smaller vertical and greater horizontal CG velocity at take-off.

After analyzing the correlation of 23 selected kinematic and kinetic variables, it is interesting to look at their hierarchical structure, obtained by cluster analysis based on correlation coefficients of their interdependence (Figure 1).

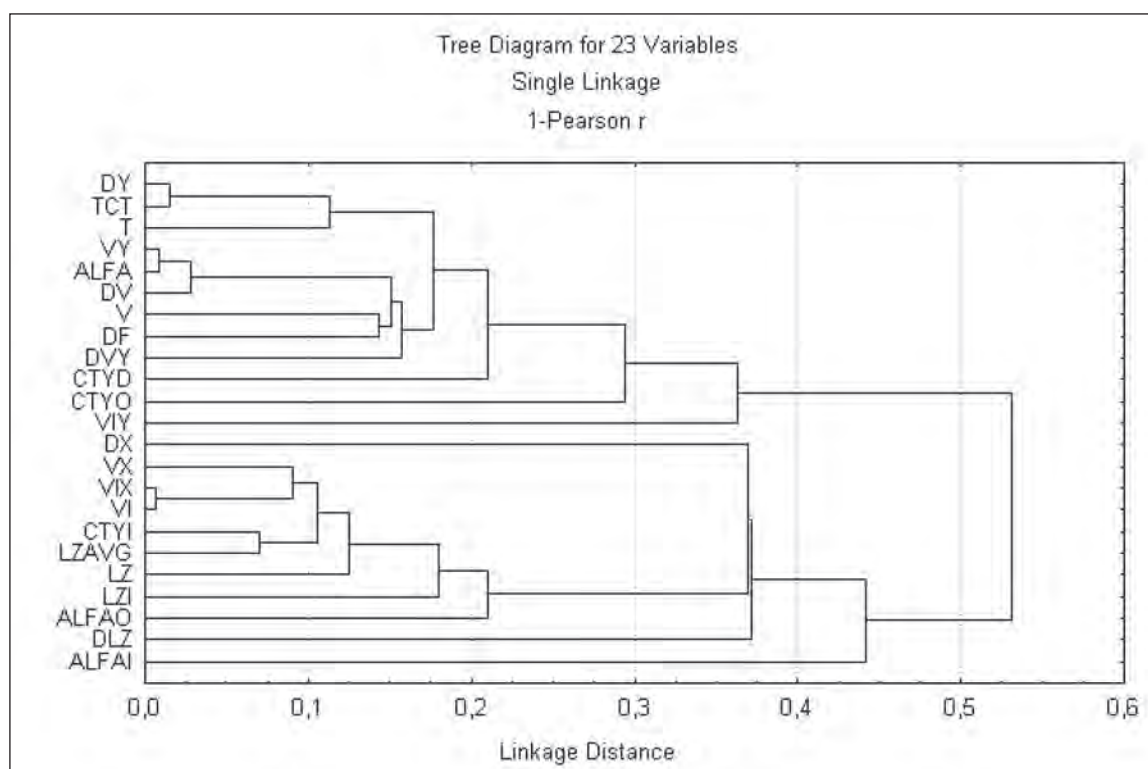

Figure 1: Hierarchical clustering of kinematic and kinetic variables

Despite the fact that most of the relations among selected kinematic and kinetic variables are already explained in the previous discussion, results of cluster analysis presented in Figure 1 points to a completely new aspect in the approach to the analysis of biomechanical parameters of backward somersaults. Namely, based on hierarchical clustering of their relationship, it is apparent, on the descriptive level, that all of the parameters can be separated in two groups, i.e. two factors.

The first factor consist parameters which, directly or indirectly, predominantly involve the vertical (y) component of movement, which is necessarily connected to the achievement of maximum flight height. In general, this group of parameters determines the vertical translation.

The second factor consist parameters in which dominates the horizontal component of motion (x), and in its formation a very significant role plays the angular momentum. Therefore, it can be concluded that this group of parameters determines the horizontal translation. As, however, the horizontal translation is not the goal of the performance, these parameters can be treated as parameters which are determining the rotation.

Obviously, in the case of the analysed somersault types, these two factors are in mutual contradiction. It can be concluded that their specific relationship defines the final characteristics of the biomechanical model of the backward somersault.

Conclusion

The results of correlation analysis applied on the biomechanical parameters extracted from the execution of seven different types of backward somersaults showed that the trajectory of the gymnasts CG will be higher with the greater vertical velocity of take-off and the greater take-off angle. The transfer efficiency of the horizontal to the vertical impulse will depend on a number of factors, i.e., the angle of attack at touch down after back handspring and, of course, on the force of take-off. Also it is concluded that the higher velocity change during the take-off, will produce the greater vertical and the lower horizontal component of the velocity at the take-off. The corellations with angular momentum showed that the average angular momentum during the flight depends on the smaller degree of the velocity loss during take-off, as well as on the lower take-off angle. Also, average angular momentum during the flight will be greater with smaller vertical and greater horizontal CG velocity at take-off. During the flight phase, which is very important from the competitive point of view – maximization of height, angular momentum at take-off is negatively related with maximal height of CG trajectory. It proves the theory that the creation of a larger amount of angular momentum necessarily spends a certain amount of the flight height.

References

1. Bruggemann, G. P. (1987). Kinematics and kinetics of the backward somersault take-off from the floor. In: Biomechanics VIII-B (ed. H. Matsui and K Kobayashi) pp. 793-800. Champaign, IL: Human Kinetics.
2. Cuk I., Ferkolj MS (2000). Kinematic analysis of some backward acrobatic jumps . Proceedings of the 18th International Symposium on Biomechanics in Sports.
3. Geiblinger H , Morrison WE , McLaughlin PA (1995). Take-off characteristics of double back somersaults on the floor . Proceedings of the 13 th International Symposium on Biomechanics in Sports.
4. Hong, Y. and G. P. Bruggemann (1993). The Mechanism of Twisting Somersault and its Application on Gymnastics Practice. In: Conference Proceedings of the First International Conference on Biomechanics in Gymnastics (ed. G.P. Bruggemann and J. K. Ruhl), pp. 357-366. Cologne: Bundesinstitut für Sportwissenschaft.
5. Hraski Z . (2002). Correlation between selected kinematic parameters and angular momentum in backward somersaults. Proceedings of the 20 th International Symposium on Biomechanics in Sports; pp. 167 – 170.
6. Hraski Z , Mejovsek M . (2004). Production of Angular Momentum for Backward Somersault. In: Hamza MM , editor. Biomechanics, IASTED International Conference on Biomechanics, Honolulu, Hawaii, USA, pp. 10-13
7. Hwang, I., Seo, G., Liu, ZC. (1990). Takeoff Mechanics of the Double Backward Somersault. International Journal of Sport Biomechanics. Vol. 6 Issue 2, p177-186.
8. King MA, Yeadon MR. (2004). Maximising somersault rotation in tumbling. Journal of Biomechanics. 7 (4):471-7.
9. Knoll (1993). Zum Biomechanischen Wirkungsmechanismus von Flugelementen aus Vorbereitenden Bewegungen und Ableitungen für Die Technik Von Rondat und Flic-Flack am Boden. In: Conference Proceedings of the First International Conference on Biomechanics in Gymnastics (ed. G.P. Bruggemann and J. K. Ruhl), pp. 115-126. Cologne: Bundesinstitut für Sportwissenschaft.
10. Mkaouer B, Jemni M, Amara S, Chaabène H, Tabka Z. (2013). Kinematic and kinetic analysis of two gymnastics acrobatic series to performing the backward stretched somersault. J Hum Kinet. 2013 Jul 5;37:17-26.

FUNCTIONAL DIMORPHISM OF DIFFERENT INDICATORS OF LEG EXTENSORS EXPLOSIVE FORCE REGARDING JUNIORS IN SPORTS GAMES

Jelena Ivanović¹, Milivoj Dopsaj¹, Saša Jakovljević², Milivoje Karalejić² and Aco Gajević¹

¹Serbian Institute of Sport and Sports Medicine, Belgrade, Serbia

²Faculty for Sport and Physical Education, Belgrade University, Serbia

Abstract

The aim of this paper was to evaluate functional dimorphism and model of different indicators for evaluating leg extensors explosiveness, being measured at 100 and 50% of the maximal force and at 100, 180 and 250 ms from the beginning of the muscle contraction in junior athletes in sports games. 65 well trained and healthy Serbian male national level athletes (basketball, football and water polo) who were competing in the Junior National team of Serbia performed a standardized “isometric leg press” test in order to assess the characteristics of isometric force from their leg extensors. The measurement range was defined by 5 variables regarding the contractile characteristics of the leg extensors isometric muscle force during unilateral and bilateral exertions – the indicator of basic (general) level of rate of force development – RFD_{BASIC} , the indicator of specific level of rate of force development – $RFD_{50\%}$, and three indicators for evaluating special level of the explosive force development, measured at 250ms – RFD_{250ms} , at 180ms – RFD_{180ms} and 100ms – RFD_{100ms} . In the function of the observed F-t characteristics no statistically significant functional dimorphism between dominant and non-dominant leg was determined, regarding the total sample of the examinees and all characteristics. For the sample tested the RFD functional dimorphism i.e. functional relationship between non-dominant and dominant leg, was established at the index level of 1.0070 for RFD_{max} , 0.9953 for $RFD_{50\%}$, 1.0416 for RFD_{100ms} , 1.0165 for RFD_{180ms} , 0.9991 for RFD_{250ms} . Since leg muscles represent significant, almost crucial active units, which are, together with bone-joint system, important for successful locomotion, and for other types of movement as well, some future studies should explore and examine the influence of longterm training efforts on natural level of functional dimorphism in different age categories in disciplines where one leg is used more dominantly.

Key words: neuromuscular function, rate of force development, dominant leg

Introduction

Considering the current theoretical thesis, the indicators of explosiveness, i.e. the explosive maximal force (RFD) have following analytical and diagnostical structure (Aagaard et al., 2002; Zatsiorsky and Kraemer, 2006; Ivanović et al., 2011): 1) RFD_{BASIC} – general or basic indicator of explosive force development determined at the level of maximal contractile potential, i.e. F_{max} and tF_{max} , 2) RFD_{SPEC} – specific indicator of explosive force development determined at 50% of maximal contractile potential i.e. 50% F_{max} and $t50\% F_{max}$, 3) RFD_{SPECIJ} – special indicator of explosive force development determined at the level of time necessary to conduct special competitive movement/movements, i.e. F_x and tF_x . From the previous researches on the specificity of moving structure in competitive conditions and on defining time parameters for realizing the most characteristic motoric tasks of the movement techniques, the following typical time intervals can be isolated: 250ms as time to conduct *stretch-shortening* cycle, 180ms as characteristic ground contact time during running in submaximal exertion regime, frequent changes of movement direction and vertical rebounds and 100ms as the ground contact time during running in absolute maximal intensity (Zatsiorsky and Kraemer, 2006; Čoh, 2010). From the aspect of theory and technology of the training, it is extremely important to determine all the characteristics of the relation between different physical property in control, untrained, as well as in different trained population regarding the gender, age, competitive level and different training stages. More important is to determine all the characteristics regarding the single physical property, for that is the way to develop basic and specific knowledge on training. On the other hand, from the aspect of anatomical or functional development of the extremities, human body has an adequate balance. Observed through the biomechanical body axis, the balance depends on normal ratio between upper and lower part of the body, frontal and posterior and right and left side of the body. The bigger anatomical or functional disproportion in certain muscle groups is, the possibility of damaging or injuring muscles or bone-joint system is stronger. The functional dimorphism represents the functional connection, i.e. numerical relation between maximal force of dominant and non dominant hand or leg (Schantz et al., 1989; Dopsaj et al., 2009; Ivanovic et al., 2009). In our previous work (Ivanovic et al., 2012) has defined functional dimorphism and model of different indicators for evaluating leg extensors force-time characteristics, in top level athletes and untrained males. Based on obtained results of that work, in the aspect of the functional relationship between non-dominant and dominant leg, it was concluded that athletes and untrained male are

adapted to demonstrate muscle force and its characteristics differently. Based on previous studies, we hypothesize that is extremely important to determine functional relationship between non-dominant and dominant leg in young athletes with different levels of fitness and training history especially in sports where muscle force and lower extremity strength have a significant influence on executing different technical–tactical demands. Because of that, the aim of this work was to evaluate functional dimorphism and model of different indicators for evaluation of the leg extensors explosiveness, measured at 100 and 50% of maximal force and at 100, 180 and 250ms from the beginning of muscle contraction in junior athletes in sports games.

Methods

Samples The subject sample included 65 well trained and healthy Serbian male national level athletes (basketball, football and water polo) who were competing in the Junior National team of Serbia. The collected basic anthropo-morphological characteristics were as follows: body height = 194.69 ± 6.97 cm, body mass = 85.47 ± 10.99 kg, body mass index = 22.32 ± 2.23 kg/m², age = 16.94 ± 1.04 years, Training period = 8.98 ± 1.93 years. All tests were conducted in the Laboratory for testing motoric abilities in The Serbian Institute for Sport, using the same standardised procedure and equipment. All the examinees – athletes were tested in the similar training stage, i.e. at the beginning of the main precompetative cycle in summer season 2012. That way we were able to execute unification of the examinees for the purpose of objective results.

Variables The isometric F-t characteristics of the leg extensors were evaluated using the 5 variables during unilateral (dominant – RFD_{DO} and non-dominant – RFD_{ND} leg) and bilateral exertions:

- The indicator of basic (general) level of rate of force development of leg extensors (RFD_{max}, expressed in N·s⁻¹) was measured by applying the following procedure (Zatsiorsky and Kraemer, 2006; Ivanović et al., 2011): $RFD_{max} = (F_{max} / tF_{max}) * 1000$. Where: F_{max} represents the maximal value of isometric leg extensors force achieved, in N; tF_{max} represents the time necessary to reach it, in ms.
- The indicator of specific isometric leg extensors explosive force or the S gradient of the leg extensors force, as a rate of force development measured at 50% of F_{max} (RFD_{50%}, expressed in N·s⁻¹) was measured by applying the following procedure: $RFD_{50\%} = (F_{50\%} / tF_{50\%}) * 1000$. Where: $F_{50\%}$ represents the value of isometric force achieved at 50% of F_{max} , in N; $tF_{50\%}$ represents the time necessary to reach it, in ms.
- The indicator of special level of leg extensors explosive force development, measured at 250 ms of tF_{max} (RFD_{250ms}, in N·s⁻¹) was measured by applying the following procedure (Zatsiorsky and Kreamer, 2006; Ivanović et al., 2011): $RFD_{250ms} = (F_{250ms} / tF_{250ms}) * 1000$. Where: F_{250ms} represents the value of isometric force achieved at 250 ms of tF_{max} , expressed in N.
- The indicator of special level of explosive force development, measured at 180 ms of tF_{max} (RFD_{180ms}, in N·s⁻¹) was measured by applying the following procedure (Ivanović et al., 2011): $RFD_{180ms} = (F_{180ms} / tF_{180ms}) * 1000$. Where: F_{180ms} represents the value of isometric force achieved at 180ms of tF_{max} , in N.
- The indicator of special level of explosive force development, measured at 100 ms of tF_{max} (RFD_{100ms}, in N·s⁻¹) was measured by applying the following procedure (Ivanović et al., 2011): $RFD_{100ms} = (F_{100ms} / tF_{100ms}) * 1000$. Where: F_{100ms} represents the value of isometric force achieved at 100ms of tF_{max} , in N.
- Functional dimorphism – functional relationship between of non-dominant and dominant leg of all analyzed isometric force-time characteristics (RFD_{xNd/Do}, in index value) was done by applying the following procedure (Schantz et al., 1989; Dopsaj et al., 2009; Ivanovic et al., 2009): $RFD_{xNd/Do} = RFD_{xND} / RFD_{xDO}$. Where: RFD_{xND} represents the value of rate of force development of non-dominant leg, expressed in N·s⁻¹; RFD_{xDO} represents the value of rate of force development of dominant leg, expressed in N·s⁻¹.

Measuring procedure Maximal isometric force was measured using a leg extension dynamometer (Serbian Institute for Sport and Sport Medicine, Belgrade). Subjects were seated on a bench, so that their hip angle was at 110°, knee angle 120°, and ankle angle 90°. After individuals had warmed up for five minutes and received an introduction to the measuring procedure, each subject made two attempts, with one minute of rest between trials. The subjects were instructed to exert their maximal force as quickly as possible. In order to assess the contractile characteristics of the isometric muscle force of leg extensors (during unilateral and bilateral exertions), standardized equipment was used, i.e. a metal device. A foot-platform fixed to the frame by strain-gauge transducers and a standardized “isometric leg press” test was used following the earlier described procedures (Dopsaj and Ivanović, 2011; Ivanović and Dopsaj 2013). Data was collected at 2000Hz using interface box with an analog to digital card (National Instruments, Austin, TX, USA). All data was recorded and analyzed using a specially designed software system (M_S_NI, Nikola Tesla Institute, Serbia, Belgrade). Thereafter, data was processed using a PC. During later off-line analysis the trials were selected and the force signal was filtered by a digital fourth order recursive low-pass filter, using a cutoff frequency of 50Hz.

Statistical procedure All the results were processed applying the descriptive statistics and Student’s t test (Hair et al., 1998). All statistical operations were carried out by applying the Microsoft ® Office Excel 2007 and the SPSS for Windows, Release 17.0 (Copyright © SPSS Inc., 1989–2002).

Results

The results of the descriptive statistics are shown in Table 1. Table 2 presents Functional dimorphism at the different explosiveness levels. The results of the of Student's test are shown in Table 3.

Table 1: Descriptive statistic analysis for the total sample tasted

		RFDF _{max} (N·s ⁻¹)	RFD _{50%} (N·s ⁻¹)	RFD _{100ms} (N·s ⁻¹)	RFD _{180ms} (N·s ⁻¹)	RFD _{250ms} (N·s ⁻¹)
bilateral	Mean	2916.24	10240.05	9782.95	9882.49	9224.19
	SD	1074.86	3911.31	3827.38	3333.70	2901.87
	cV%	36.86	38.20	39.12	33.73	31.46
	Min	684.60	3480.65	2177.80	4143.45	4081.92
	Max	6808.61	23072.93	22189.52	17756.89	17045.70
dominant	Mean	1673.39	5701.76	5218.29	5499.62	5184.32
	SD	846.00	2124.36	2126.05	1968.64	1721.43
	cV%	50.56	37.26	40.74	35.80	33.20
	Min	631.35	2457.21	1164.82	1331.21	1797.80
	Max	4778.48	11149.46	11239.64	10689.04	9516.73
non dominant	Mean	1518.52	5526.80	5125.62	5466.81	5114.01
	SD	760.78	2086.92	2016.06	1990.76	1745.92
	cV%	50.10	37.76	39.33	36.42	34.14
	Min	655.86	2065.87	1567.22	1236.02	1366.22
	Max	5859.64	10800.98	11450.21	10552.60	9279.47

Table 2: Functional dimorphism at the different explosiveness levels

index values	RFDF _{max} Nd/Do	RFD _{50%} Nd/Do	RFD _{100ms} Nd/Do	RFD _{180ms} Nd/Do	RFD _{250ms} Nd/Do
Mean	1.0070	0.9953	1.0416	1.0165	0.9991
SD	0.4066	0.2438	0.3345	0.2344	0.2016
cV%	40.38	24.50	32.12	23.06	20.18
Min	0.3269	0.3867	0.3695	0.5789	0.6220
Max	2.1186	1.6567	2.0991	1.7512	1.7160

Table 3: Results of Student's test

	Paired Differences	Mean	t	Sig. (2-tailed)
Pair 1	RFDF _{maxDO} - RFDF _{maxND}	154.86	1.698	0.094
Pair 2	RFD _{50%DO} - RFD _{50%ND}	174.95	0.984	0.329
Pair 3	RFD _{100msDO} - RFD _{100msND}	92.67	0.408	0.685
Pair 4	RFD _{180msDO} - RFD _{180msND}	32.80	0.225	0.823
Pair 5	RFD _{250msDO} - RFD _{250msND}	70.30	0.640	0.524

Discussion and conclusions

At the level of functional dimorphism no statistically significant difference was established in the examined explosiveness indicators (Table 3). For the sample tested the functional dimorphism was established at the index level of 1.0070 for RFDF_{max}, 0.9953 for RFD_{50%}, 1.0416 for RFD_{100ms}, 1.0165 for RFD_{180ms}, 0.9991 for RFD_{250ms}. In comparison to this paper, completely different results were obtained in some previous researches (Dopsaj et al., 2009; Ivanović et al., 2009; Ivanović et al., 2012). Unlike the junior players in this research, in 203 top level athletes from different sports branches statistically significant functional dimorphism between dominant and non-dominant leg was determined in RFDF_{max}, RFD_{50%}, RFD_{180ms}, RFD_{250ms} (Ivanović et al., 2012). Presumably, players' years of adaptation and the exertion during training and competition process have actually influenced on difference in functional relationship between non-dominant and dominant

leg between junior and senior players. Different training methods, overall intensity and the dimension and/or type of explosive and strength training during the training process, as well as differences in muscle tissue and maximal nervous activation of muscles during the specific training, i.e. adaptation to specific training, are possibly the reasons for athletes being adapted to demonstrate muscle force and its characteristics differently. Also, some of those researches defined influence of sports branches in regard to natural level of functional dimorphism. For example, observing the sample of 256 top level male athletes from the eleven sports branches – water polo, track and field, taekwondo, basketball, orienteering, volleyball, archery, boxing, judo, handball and body building (Ivanović et al., 2009), in the function of maximal isometric hand grip force $F_{\max}HG_{iso}$, functional dimorphism for the total sample was established between dominant and non-dominant hand and at the significance level for the dominant hand. Also, the multivariate statistical analysis determined general statistically significant difference between the observed subsamples *Sports branches* for all contractile characteristics. With the aim to define model characteristics of basic and specific indicators of explosive force and time parameters of hand grip in different trained population, from the aspect of power (Dopsaj et al., 2009), the maximal average values were measured in power lifting in regard to untrained persons. Different types of grasping, holding i.e. gripping the bar with both hands in power lifting, contributed the specific adaptation which stipulates in loss of functional dominance in one hand, i.e. it stipulates the equalization of ability to generate the level of maximal isometric force and the intensity of force increase ($RFD_{BASIC}HG$) in both hands. Whereas the examinees in the mentioned researches were differently trained athletes and untrained physically active persons, it was possible to state a hypothesis on influence of different sports branches on specific adaptation. On the other hand, in regard to tested muscle group, and because of its anatomic-functional and muscle-structural specific characteristics, the indicators of explosiveness have different level of functional dimorphism. Besides, it is possible to talk about the influence of takeoff leg under assumption that's not necessarily have to be dominant and/or stronger leg. In well trained and healthy Serbian male national level athletes (basketball, football and water polo) regarding the contractile characteristics of the leg extensors isometric muscle force during unilateral and bilateral exertions – the indicator of basic (general) level of rate of force development – RFD_{BASIC} , the indicator of specific level of rate of force development – $RFD_{50\%}$, and three indicators for evaluating special level of the explosive force development, measured at 250ms – RFD_{250ms} , at 180ms – RFD_{180ms} and 100ms – RFD_{100ms} no statistically significant functional dimorphism was determined. Based on obtained results, the ability of muscle force development in observed characteristics of leg extensors was equally developed. In other words, the $RFDF_{\max}$ of the non-dominant leg was at the level of 100.70% of the $RFDF_{\max}$ of the dominant leg, $RFD_{50\%}$ of the non-dominant leg was at the level of 99.53% of the $RFD_{50\%}$ of the dominant leg, RFD_{100ms} of the non-dominant leg was at the level of 104.16% of the RFD_{100ms} of the dominant leg, RFD_{180ms} of the non-dominant leg was at the level of 101.65% of the RFD_{180ms} of the dominant leg, RFD_{250ms} of the non-dominant leg was at the level of 99.91% of the RFD_{250ms} of the dominant leg. The results of numerous researches showed that muscle force, explosiveness and the power of lower extremities have significant influence on performing different technical-tactical demands in various sports. Due to this fact and the fact that leg muscles present significant, almost crucial active anatomic unit, which are, together with the characteristics of bone-joint system, important for successful locomotion, and for other types of movement, it's important to examine these assumptions in detail and to investigate the influence of longterm training efforts on natural level of functional and sexual dimorphism in sports branches where one leg is used more dominantly.

References

1. Aagaard, P., Simonsen, E.B., Andersen, J.L., Magnusson, P., & Poulsen, P.D. (2002). Increased rate of force development and neural drive of human skeletal muscle following resistance training. *Journal of Applied Physiology*, 93, 1318–1326.
2. Čoh, M. (2010). Biomechanical characteristics of take off action in high jump – a case study. *Serbian Journal of Sports Sciences*, 4(4), 127–135.
3. Dopsaj, M., Ivanović, J., Blagojević, M., Koropanovski, N., Vučković, G., Janković, R., Marinković, B., Atanasov, D., & Miljuš, D. (2009). Basic and specific characteristics of the hand grip explosive force and time parameters in different strength trained population. *Brazilian Journal of Biometricity*, 3(2), 177–193.
4. Dopsaj, M., & Ivanović, J. (2011). The analysis of the reliability and factorial validity in the basic characteristics of isometric F-t curve of the leg extensors in well trained serbian males and females. *Measurement Science Review*, 11(5): 165–172.
5. Hair, J., Anderson, R., Tatham, R., & Black, W. (1998). *Multivariate Data Analysis*. New Jersey, USA: Prentice - Hall, Inc.
6. Ivanović, J., Koropanovski, N., Vučković, G., Janković, R., Miljuš, D., Marinković, B., Atanasov, D., Blagojević, M., & Dopsaj, M. (2009). Functional dimorphism and characteristics considering maximal hand grip force in top level athletes in the Republic of Serbia. *Gazzeta Medica Italiana*, 168(5), 297–310.
7. Ivanović, J., Dopsaj, M., & Nešić, G. (2011). Factor Structure differences of indicators for evaluating isometric leg extensors explosive force in female volleyball athletes and different trained female population. *British Journal of Sports Medicine*, 45, 542.
8. Ivanović, J., Dopsaj, M., Koprivica, V., Jakovljević, S., & Radovanović, D. (2012). Functional dimorphism of leg extensors force-time characteristics regarding top level athletes and untrained males. In M. Dopsaj & I. Juhas (Eds.), *Proceedings of International scientific conference "Effects of physical activity application to anthropological status with children, youth and adults"*, (pp. 149-159). Belgrade: Faculty of Sport and Physical Education.

9. Ivanović, J., & Dopsaj, M. (2013). Reliability of force-time curve characteristics during maximal isometric leg press in differently trained high-level athletes. *Measurement*, 46 (7): 2146–2154.
10. Schantz, P.G., Moritani, T., Karlson, E., Johansson, E., & Lundh, A. (1989). Maximal voluntary force of bilateral and unilateral leg extension. *Acta Physiologica Scandinavica*, 136, 185–192.
11. Zatsiorsky, V.M., & Kraemer W.J. (2006). *Science and practice of strength training*. Champaign, IL: Human Kinetics.

Acknowledgement

The paper was realized as part of project III47015 sponsored by Ministry of science and technological development in the Republic of Serbia.

LONGITUDINAL MONITORING OF PERFORMANCE IN BIOMECHANICAL LABORATORY TESTS AIMED AT SKI JUMPING IN NORDIC COMBINED ATHLETES

Miroslav Janura¹, Lee Cabell² and Milan Elfmark¹

¹Palacky University, Faculty of Physical Culture, Czech Republic

²Seton Hall University, School of Health and Medical Sciences, United States

The purpose of this study was to observe longitudinal changes in selected movement skills of Nordic Combined (NC) athletes and compare them between groups with different ages. Male NC athletes ($n = 127$) were divided into two age groups (≤ 18 and > 18 yrs.). The maximal relative isometric force (MRIF), reaction time and angular displacement time for knee extension, and lower-extremity explosive force data were collected in a laboratory setting between 1992 and 2010. The statistically different results showed a reduced body mass index between both age categories. The MRIF and explosive force in lower extremities were greater for adult athletes compared to young athletes during the measured period. The group of adult competitors improved all values of the measured variables during this period.

Key words: *biomechanics, winter sports, strength, age*

Introduction

Nordic Combined (NC) is one of the traditional disciplines of classical skiing which consists of two sports events – ski jumping (explosive-strength sport) and cross country skiing (endurance sport) – which place on athletes different requirements necessary to maximize their performance. Competitors in both events must combine skills from both ends of the endurance-strength continuum (Rønnestad et al., 2012). During practice of individual sport disciplines, there is an influence of muscle strength and power (ski jumping) with minimal effects on $VO_2\max$ (cross-country skiing) and vice versa (Nader, 2006).

Ski jumping, as a rule, opens NC competitions, and in many cases decides the final outcome of the combined event. During the take-off, ski jumpers have approximately 0.3 seconds to produce a high angular momentum for optimal forward-rotation of the body, which is necessary for a successful ski jump (Müller, 2009). Even a small error in jump execution may have a significant effect on the length of the jump (Vodicar, Jost, 2010). It is also necessary to take into account the fact that jump execution is characterized by high inter-individual variability (Janura et al., 2007).

The fundamental prerequisite for a ski jumper's effective performance at the take-off phase is a large take-off force. The focus on explosive strength training or power training of the lower extremity muscle is typical for NC athletes (Pääsuke et al., 2001). Good balance, orientation in space, and appropriate morphological structure of a body is also necessary for accuracy of the take-off and for execution of further phases of a ski jump (Jošt, 2010).

Achieving an adequate level of these skills is a long-term matter which has been previously researched in the area of the development of muscle power at take-off (Sandler, 2005). Ski jumpers perform heavy strength training to increase their maximal strength with minimal hypertrophy (Hoff et al., 2001). A good-quality diagnostic analysis is necessary for the planning, management, and control of the training process in ski jumping (Hahn et al., 2005). Biomechanical diagnostic programs allow individualized training with respect to the abilities and skills of individual ski jumpers (Zatsiorsky, Kraemer, 2006). The abilities of a ski jumper could be measured with various motoric tests, which are the input for the hypothetical model of special motor behavior of athletes (Jošt, 2010).

The purpose of this study was to observe longitudinal changes in selected movement skills of NC athletes aimed at ski jumping and compare them between groups of different ages.

Methods

Subjects

The subjects of this study were Czech male NC athletes ($n = 127$) at various competitive levels who were divided into two time intervals for two groups based on the subjects' ages (≤ 18 and > 18 yrs.) (Table 1).

Table 1: Subjects' demographics

Group	Age (Mean \pm SD)	Time period	Number of subjects	Number of trials
1Y	16.44 \pm 0.99	1992–2000	39	64
1A	20.60 \pm 2.76	1992–2000	42	130
2Y	16.12 \pm 1.21	2001–2010	18	45
2A	21.06 \pm 2.85	2001–2010	28	111

Legend: Y – Youth (\leq 18 yrs. old), A – Adult ($>$ 18 yrs. old)

Experimental procedures

After assessing the subject's mass and height, the competitor's BMI was calculated from the formula $BMI = \text{mass (kg)} / \text{height}^2 \text{ (m)}$. The subcutaneous fat thickness was measured with the use of 10 skin hairs by a skinfold caliper.

Each subject was seated on a chair while the subject's thigh was horizontal and the angle between the thigh and shank was 120° . A piezoelectric load cell (type 9301A, Kistler, Winterthur, Switzerland) was attached to the ankle joint such that its axis was directed at a right angle to the shank's axis. The maximum isometric force (MIF) of the knee extension was collected. Maximal relative isometric knee extensor force was calculated as $MRIF = MIF \text{ (N)} / \text{mass (kg)}$.

While sitting on a chair, the subject's thigh was positioned horizontally with the knee bent at 90° . His Achilles tendon was touching a sensor constructed of a micro clamp (type DT, pressure for clamping 1.95–2.78 N, Palacky University, Olomouc, Czech Republic). The subject extended his knee as rapidly as possible. The reaction time measured was the time between the LED flash and the Achilles tendon leaving the sensor. The time of knee extension was measured between the release of the sensor and the instant the front of the shank crossed a photocell infrared beam positioned 0.30 m from the sensor.

Each subject was instructed to stand on a piezoelectric force platform (type 9261/A, Kistler, Winterthur, Switzerland) in an in-run position and perform a vertical jump take-off to achieve a maximal jump height. The vertical jump height was determined using equation $H = I^2/2gm^2$, where I is force impulse (Ns), m is mass (kg) and $g = 9.81 \text{ ms}^{-2}$ is gravity acceleration.

Statistical analyses

The data were analyzed using a two-way (age and time) ANOVA. A Fisher's least significant difference (LSD) procedure was applied for all post-hoc pairwise comparisons (STATISTICA Version 9.0, StatSoft, Inc., Tulsa, OK, USA). The statistical significance level was set to 0.05. The statistical power of the tests was stated 0.8 for the differences in the variables in this study.

Results

There is not a significant difference in the average age compared between the two groups of younger competitors. A similar conclusion also applies to comparisons of both groups of adult competitors. The values of the dependent variables of all four monitored groups are listed in Table 2.

Table 2: Values of monitored dependent variables (Mean \pm SD) for each group

	1Y	2Y	1A	2A
Mass [kg]	60.67 \pm 6.38	60.19 \pm 7.73	69.29 \pm 5.34	70.01 \pm 4.31
Height [cm]	172.4 \pm 5.47	173.8 \pm 7.74	177.6 \pm 4.87	179.6 \pm 5.12
BMI [$\text{kg}\cdot\text{m}^{-2}$]	20.36 \pm 1.39	19.84 \pm 1.40	21.97 \pm 1.39	21.72 \pm 1.13
Body Fat [%]	9.1 \pm 2.3	10.0 \pm 1.5	8.5 \pm 2.1	8.5 \pm 2.4
MRIF (R) [$\text{N}\cdot\text{kg}^{-1}$]	11.01 \pm 1.38	10.32 \pm 1.62	11.44 \pm 1.24	11.57 \pm 1.01
MRIF (L) [$\text{N}\cdot\text{kg}^{-1}$]	10.85 \pm 1.35	10.03 \pm 1.58	11.06 \pm 1.20	11.33 \pm 1.16
RT [ms]	165.2 \pm 13.4	168.4 \pm 16.6	161.9 \pm 12.6	159.4 \pm 10.6
RT_SD [ms]	9.71 \pm 3.31	9.47 \pm 1.22	8.91 \pm 2.56	8.43 \pm 1.81
ET [ms]	113.9 \pm 13.79	121.9 \pm 1.72	110.9 \pm 14.3	114.7 \pm 13.8
ET_SD [ms]	7.02 \pm 2.88	7.31 \pm 2.20	5.81 \pm 2.14	5.36 \pm 2.09
H [cm]	43.8 \pm 5.51	42.6 \pm 5.58	47.1 \pm 5.06	49.5 \pm 4.56

Legend: Y – Youth (\leq 18 yrs. old), A – Adult ($>$ 18 yrs. old), BMI – Body mass index, MRIF (R&L) – maximal relative isometric force of the knee extensors on the right (R) and left (L) leg, RT – reaction time, RT_SD – standard deviation of reaction time (out of 20 trials), ET – knee extension time, ET_SD – standard deviation of knee extension time (out of 20 trials), H – vertical jump height

The body mass of two groups of young competitors is significantly lower ($p < .001$) than the groups of adult competitors. There is a body height increase for both age groups during the observed time period. Group 1Y in comparison with groups 1A and 2A showed significantly lower body height ($p < .01$ and $p < .001$). We also noticed this significant difference when comparing groups 2Y and 2A ($p < .05$). The magnitude of BMI decreased for both age groups during the measured period (Figure 1A). Groups 1Y and 2Y had statistically lower values in comparison with groups 1A ($p < .001$) and 2A ($p < .01$).

During the monitored time period, there was an increase of the MRIF on both lower limbs only in a group of adult competitors; however, we noticed the reversed tendency in younger competitors. The difference in the MRIF on the right limb between group 2Y and groups 1A and 2A was significant ($p < .05$) (Figure 1B). The left lower extremity showed the MRIF for group 2Y significantly lower ($p < .05$) when compared to group 2A.

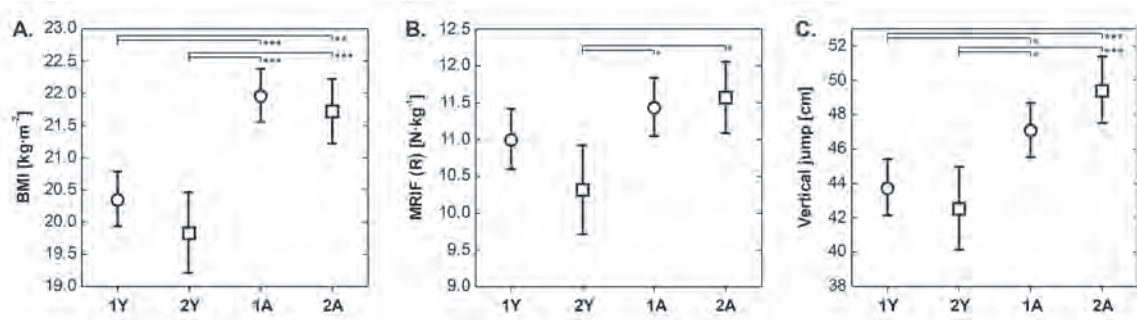

Figure 1: Comparison (Mean \pm 95% CI) of the BMI (A), the MRIF on the right lower limb (B), and the vertical jump height (C) among the four groups during the monitored time period.

Similarly, we found the same conclusions in the explosive muscle strength of the lower extremities. There was an increase of the vertical jump height in adult competitors; on the other hand, this value decreased for younger competitors during the observed time period (Figure 1C). The vertical height of a jump was significantly smaller for two groups of young competitors in comparison with group 1A ($p < .05$), and we also found a similar difference when comparing groups 1Y, 2Y with group 2A ($p < .001$).

The values of the reaction time as well as the knee extension time were lower for adult competitors in comparison with both groups of younger competitors. The differences between the groups were not statistically significant, however.

Discussion

The different nature of disciplines in NC (i.e., ski jumping and cross country skiing) requires a combination of several training methods. For the basic movement abilities (force, endurance) a major change (in the sense of increase or decrease), which is important in one discipline can have negative influence in the other discipline. This fact must be taken into account during creation and evaluation of laboratory biomechanical tests.

Changes in somatotype

Both age groups increased their body heights slightly and decreased their BMIs during the monitored time period. Younger competitors reduced their body mass. These trends are in line with the changes in ski jumping technique, when a body mass reduction of five kilograms could cause an increase in jump length of six to seven meters on jump hills with a large critical point (Müller, DeVaney, 1996). The value of somatotype variables is only one of the factors involved in the jump length, however. Müller (2002) did not find any significant correlations between BMI values and the competitors' placements during the 1999/2000 World Cup ski jumping season. In NC, we also need to take into consideration the requirements that are placed on body sizes in relation to cross country skiing. Bergh and Forsberg (1992) studied the influence of body mass on cross-country performance. The effects of body mass on cross-country skiing performance was small; however, there was a tendency that heavier skiers were more successful than light ones.

Changes in dependent variables

The young competitors decreased absolute and relative strength during the knee extension in both lower extremities (on the right 46.8 N, on the left 54.5 N). The older competitors had an opposite trend with a strength increase of 17.4 N on the right and 26.9 N on the left lower extremities. None of the differences were statistically significant. The value of MRIF was greater on both lower extremities in older competitors. This fact could be, besides others, explained by neuromuscular adaptations due to training (Pincivero et al., 2004), which seemed to play a greater role than muscle

hypertrophy (Häkkinen et al., 2000). In pubescent children there is a possible lack of efficient utilization of resources that are necessary for maximal strength production (Knežević, Mirkov, 2011). Long-term periodized strength and power training also influence qualitative muscle tissue adaptations (Baker, 2002).

The differences in MRIF were seen in the values of lower extremity explosive force (vertical jump height), which were smaller in a group of younger competitors. Meanwhile, the younger competitors reduced the jump height and the older competitors increased the jump height during the observed time period. However, neither change is statistically significant. Bruhn et al. (2002) also found a significant relationship between the maximal relative knee extensor force and lower extremity explosive force with inter-individual differences among competitors. To interpret the explosive-force test results, we need to take into consideration different conditions for take-off execution that exist both in the laboratory and in real conditions during a competition (Komi, Virmavirta, 2000).

Conclusions

In contrast to the younger competitors, the group of adult competitors showed improvements in all the measured variables during the observed longitudinal monitoring. This group also achieved better results in all tests than younger competitors. Younger athletes exhibited lower knee extensor strength and explosive power. In addition, the reduction of BMI in this group contributed to maintaining the level of ski jumping performance.

References

1. Baker, D. Differences in strength and power among junior-high, senior-high, college-aged, and elite professional rugby league players. *J. Strength Cond. Res.* 2002;16(4):581–5.
2. Bergh, U, Forsberg, A. Influence of body mass on cross-country ski racing performance. *Med. Sci. Sports Exerc.* 1992;24(9):1033–9.
3. Bruhn, S, Schwirtz, A, Gollhofer, A. Diagnose von Kraft- und Sprungkraftparametern zur Trainingssteuerung im Skisprung. [Diagnosis of power and jump power parameters of the training control in ski jumping]. *Leistungssport.* 2002;5(2):34–7.
4. Hahn, D, Schwirtz, A, Huber, A, Bösl, P. Discipline-specific, biomechanical diagnosis concept in ski jumping. In: E Müller, D Bacharach, R Klika, S Lindinger & H Schwameder, eds. *Science and Skiing III.* Oxford: Meyer & Meyer Sport; 2005, pp. 349–59.
5. Häkkinen, K, Alen, M, Kallinen, M, Newton, RU, Kraemer, WJ. Neuromuscular adaptation during prolonged strength training, detraining and re-strength-training in middle-aged and elderly people. *Eur. J. Appl. Physiol.* 2000;83(1):51–62.
6. Hoff, J, Berdahl, GO, Bråten, S. Jumping height development and body weight considerations in ski jumping. In: E Müller, H Schwameder, C Raschner, S Lindinger & E Kornexl, eds. *Science and Skiing II.* Hamburg: Verlag Dr. Kovacs; 2001, pp. 403–12.
7. Janura, M, Svoboda, Z, Uhlář, R. A comparison of ski jump execution in a group of the best jumpers. In: V Linnamo, PV Komi & E Müller, eds. *Science and Nordic Skiing.* Oxford: Meyer & Meyer Sport Ltd.; 2007, pp. 205–14.
8. Jošt, B. The hierarchical structure of selected morphological and motoric variables in ski jumping. *Hum. Movement.* 2010;11(2):124–31.
9. Knežević, O, Mirkov, D. Strength and power of knee extensor muscles. *Phys. Cult.* 2011;65(2):5–15.
10. Komi, PV, Virmavirta, M. Factors influencing the “explosiveness” of ski jumping take-off. In: E Müller, ed. eds. *Abstract book of the 2nd International Congress on Skiing and Science.* Salzburg University of Salzburg; 2000, pp. 164–5.
11. Müller, W. A scientific approach to address the problem of underweight athletes. A case study of ski jumping. *Med. Sci. Sports Exerc.* 2002;34(Suppl. 5):124.
12. Müller, W. Determinants of ski-jump performance and implications for health, safety and fairness. *Sports Med.* 2009;39(2):85–106.
13. Müller, W, DeVaney, TTJ. The influence of body weight on the ski jumping performance. In: S Haake, ed. eds. *The Engineering of Sport.* Rotterdam: Balkema; 1996, pp. 63–9.
14. Nader, GA. Concurrent strength and endurance training: From molecules to man. *Med. Sci. Sports Exerc.* 2006;38(11):1965–70.
15. Pääsuke, M, Ereline, J, Gapeyeva, H. Knee extension strength and vertical jumping performance in nordic combined athletes. *J. Sports Med. Phys. Fitness.* 2001;41(3):354–61.
16. Pincivero, DM, Campy, RM, Karunakara, RG. The effects of rest interval and resistance training on quadriceps femoris muscle. Part II: EMG and perceived exertion. *J. Sports Med. Phys. Fitness.* 2004;44(3):224–32.
17. Rønnestad, BR, Kojedal, O, Losnegard, T, Kvamme, B, Raastad, T. Effect of heavy strength training on muscle thickness, strength, jump performance, and endurance performance in well-trained Nordic Combined athletes. *Eur. J. Appl. Physiol.* 2012;112(6):2341–52.
18. Sandler, D. *Sports Power.* Champaign, IL: Human Kinetics; 2005, 243 p.
19. Vodicar, J, Jost, B. The factor structure of chosen kinematic characteristics of take-off in ski jumping. *J. Hum. Kinet.* 2010;23(1):37–45.
20. Zatsiorsky, VM, Kraemer, WJ. *Science and Practice of Strength Training.* Champaign, IL: Human Kinetics; 2006, 221 p.

Acknowledgments

This study was supported by the research grant No MSM 6198959221 of the Ministry of Education, Youth and Sport, Czech Republic.

COMPARATIVE KINEMATIC ANALYSIS OF AIRBORNE PHASE IN ACROBATIC ELEMENTS FROM “STUFF POSITION”

Tomislav Krističević, Kamenka Živčić Marković and Lucija Mudronja

Faculty of Kinesiology, University of Zagreb, Croatia

Abstract

Acrobatic rock 'n' roll is a blend of dance and acrobatics. The aim of this investigation was to determine differences in three acrobatic elements performed from stuff position in airborne phase. These three elements are simple stuff take off, tucked somersault forward and tucked somersault backward. The investigation was performed by acquisition video on the Masters tournament in Zurich. For the purposes of this research, the demonstration of techniques was performed by 20 dance couples who were referred on the competition into the quarter finals, semi finals and the finals of tournament. To determine the difference between acrobatics elements, it was used a nonparametric statistic method Kruskal-Wallis test for independent groups. To determine statistically significant difference between analyzed elements, it was carried out by use of discriminative analyzes. These analyses lead us to conclusion that there is a statistically significant difference in values of certain variables that describe airborne phase of all three elements of technique. The variable duration of airborne phase makes no difference between analyzed elements, the height of flight makes a difference between stuff take off and both of somersaults and all the other variables differ all three elements among each other.

Key words: airborne phase, acrobatic rock 'n' roll, stuff position

Introduction

Acrobatic rock 'n' roll is a sport that combines dance techniques and acrobatic elements. In acrobatic elements there are different groups of elements, but the most attractive and most common are elements with airborne phase. In this category there are different types of somersaults and the basic elements are tucked somersaults forward and backward. There are two types of take off in acrobatic rock 'n' roll. Take off from stuff position and betterini take off. Take off from stuff position is more often in use because from that type of take off some other acrobatic elements can be performed.

There are three phases in performing all acrobatics elements from stuff position: *preparation phase*, *take-off phase* and *airborne phase*, which is determined by previous two phases. Despite the fact that all the dancing couples perform the same element technique, almost every couple has small individual differences in the performance. These differences are sometimes noticeable only to experts, but no matter how small are these differences in the performance, they can affect on different values of biomechanical parameters that determine the subsequent phase of flight, in which acrobatics elements are performed.

Three basic elements from stuff position are simple stuff take off, tucked somersault forward and tucked somersault backward. These three elements are the first that are learned from dancing couples and included in their performances.

The aim of this study was to determine differences in three acrobatic elements performed from stuff position in airborne phase. These three elements are simple stuff take off, tucked somersault forward and tucked somersault backward. As it is understandable, these analyzed elements differ the most in previously mentioned airborne phase. Due to the fact that while performing simple take off from stuff position, there is no significant change of body position in airborne phase compared to the tucked somersaults, also there is no rotation of the body around any of axis, comparative analyze of airborne phase in first part was done using only kinematics variables that describe trajectory of CG. In second part of the study distribution of rotation in somersaults was compared.

Methods

For purposes of this research, the demonstration of techniques was performed by 20 dance couples who qualified into the quarter finale, semi finals and finale of tournament in Zürich.

The following elements of technique were objects of this study:

1. Take-off from “stuff position”
2. Tucked forward somersaults from “stuff position”
3. Tucked back somersaults from “stuff position”

Collecting videos for purposes of this research was performed with four VHS cameras with 50 pictures in second. Cameras were placed at an angle of 90° in relation to one other.

For the purpose of accurate calibration of space and satisfying preconditions for the possibility of three-dimensional analysis, all the cameras recorded the reference frame (180 x 180 x 90 cm), as well as so called “fix point” that had to be visible throughout the recording.

Data analysis for this study was performed using APAS (Ariel Performance Analysis System) procedures respecting all APAS's standards and specifics that are dictated by stereotypes that were the subject of this analysis. Video recordings were saved in *avi* format, then all of them were timed and selected sequences for the analysis.

Biomechanical model of female partner was determined by 18 anatomical points of the body, which define 14-segmental model of human body (Dempster, 1955). Beside 18 referent points of human body, that were digitalized, for each camera it was completed also a digitalization of 8 points that define referent frame which is necessary for further analysis of data.

Transformation in to a real three dimensional space, was completed by *DLT* (Direct Linear Transform) algorithm. Filtering of three-dimensional coordinates was carried out by Cubic Spline algorithm. Most of analyzed variables are calculated directly by APAS, and some by appropriate trigonometric functions using data collected by APAS.

The values of kinematics variables collected in this survey were processed by descriptive statistics which was used to calculate following parameters that are also used as a baseline to describe structure of movements in analyzed elements of techniques: mean, minimum value, maximum value, standard deviation, skewness, kurtosis.

To determine the difference between acrobatics elements, it was used a nonparametric statistic method Kruskal-Wallis test for independent groups.

Multiple comparative methods was used in the next step in order to determine between which of analyzed acrobatics elements there is a statistically significant difference in variables that were separate by previous procedure.

The last step of determination statistically significant difference between analyzed elements was carried out by use of discriminative analyzes.

Results and discussion

In first step of comparative analyzes preparation phase Kruskal- Wallisov test was used as nonparametric test of variance with aim to determine in which of variables there is a statistically significant difference. The level of statistical significant is determinate as $p < 0.05$.

Table 1: K-W test of airborne phase

NAME OF VARIABLE	Stuff take-off	Backward somersault	Forward somersault	p- level
Duration of airborne phase (s)	1,02	1,01	1,02	0,830
Max height of flight (cm)	320,42	306,38	305,70	0,000
Flight altitude from take off point	147,68	139,24	139,33	0,033
Time elapsed from take off to max height of flight(s)	0,30	0,30	0,35	0,002
Horizontal move CG in airborne phase (cm)	12,68	9,29	30,19	0,008

Performed analysis showed that the elements are statistically significantly different in all analyzed variables except for the duration of the airborne phases (Table 1).

Next step was to determine between which of analyzed elements there is a difference in previously extracted variables. That was performed by use of .multiple comparative method.

Max height of flight

Table 2: Multiple comparative analyze of p values for variable max height of flight

max h CG, N= 51; p =,000			
	1 stuff take-off	2 backward somersault	3 forward somersault
1		0,002	0,002
2	0,002		1,000
3	0,002	1,000	

The analysis of variable: The maximum flight altitude (Table 2) showed a statistically significant difference between the take off from stuff position and both somersaults (back $p = 0.002$; forward $p = 0.002$). This difference in the maximum altitude is the result of a different body position at the end of the take off phase

Flight altitude from take off point

Table 3: Multiple comparative analyze of p values for variable: Flight altitude from take off point

max h CG from take off point, N= 51; $p = .033$			
	1 stuff take-off	2 backward somersault	3 forward somersault
1		0,106	0,055
2	0,106		1,000
3	0,055	1,000	

This method was not able to determine the difference between the elements, although the previous analysis showed that this variable is statistically significantly differ analyzed elements.

Time elapsed from take off to max height of flight

Table 4: Multiple comparative analyze of p values for variable: Time elapsed from take off to max height of flight

t max h CG , N= 51; $p = .0021$			
	1 stuff take-off	2 backward somersault	3 forward somersault
1		1,000	0,007
2	1,000		0,010
3	0,007	0,010	

The analysis of this variables: (Table 4) showed a statistically significant difference between the take off from stuff position and forward somersaults ($p = 0.007$) and between somersaults forward and back somersaults ($p = 0.010$).

Horizontal move of CG in airborne phase

Table 5: Multiple comparative analyze of p values for variable: Horizontal move of CG in airborne phase

X of airborne phase, (N= 51); $p = .0082$			
	1 stuff take-off	2 backward somersault	3 forward somersault
1		1,000	0,034
2	1,000		0,016
3	0,034	0,016	

The analysis of this variable (Table 5) showed a statistically significant difference between the stuff take off and forward somersaults ($p = 0.034$) and between somersaults forward and back somersaults ($p = 0.016$).

This difference can be explained by the structure of elements. In the performance of stuff take off and back somersaults, female partner, after the airborne phase lands on the same side of male partner where preparation phase and take off phase were performed. While performing somersault forward, female partner during airborne phase flights over the male partner and lands on opposite side.

Discriminative analyze was used to determine general difference between each technical element that was object of this study and contribute of every single variable to this difference.

Table 6: Individual contributions of each variable in airborne phase to difference between elements. $p < 0,0000$

NAME OF VARIABLE	p-level
Duration of airborne phase (s)	0,001
Max height of flight (cm)	0,000
Flight altitude from take off point	0,000
Time elapsed from take off to max height of flight(s)	0,903
Horizontal move CG in airborne phase (cm)	0,010

In determining the individual contribution of each variable to the difference between elements in the phase of flight, there was a statistically significant contribution of fore variables (Table 6). The only variable that even at this stage did not show any discriminatory characteristic is the duration of the flight phase

By use of *backward stepwise* discriminative analyze, from 5 variables on the beginning, excluding in every next step variable with lowest f value on the end of optimization of model there was three variables that statistically significant contribution to these difference.(Table 7)

Table 7: Results of backward stepwise discriminative analyze $p=0,05$

NAME OF VARIABLE	p-level
Flight altitude from take off point	0,000
Time elapsed from take off to max hight of flight(s)	0,000
Horizontal move CG in airborne phase (cm)	0,000

Differences between groups are confirmed by Mahalanobis distance (Table 8) and related f – values 8 (Table 9). From table 10 it is evident that there are statistically significant difference The level of statistical significant is determinate as $p < 0.01$.

Table 8: Mahalanobis distance

	G_1:1	G_2:2	G_3:3
G_1:1	0,00	87,87	107,41
G_2:2	87,87	0,00	105,13
G_3:3	107,41	105,13	0,00

Table 9: F-values

	G_1:1	G_2:2	G_3:3
G_1:1		5,83	45,64
G_2:2	5,83		18,99
G_3:3	45,64	18,99	

Table 10: p-level of significant

	G_1:1	G_2:2	G_3:3
G_1:1		0,001	0,000
G_2:2	0,001		0,000
G_3:3	0,000	0,000	

What is noteworthy is the fact that the previous procedure extracted three discriminate variables (maximum height of center of gravity of the body from the point of take off, time elapsed from take off to max high of flight and horizontal move CG of the of the body in airborne phase), which significantly differ all three analyzed element.

Furthermore, all three elements that were analyzed statistically differ in the phase of flight. This conclusion was fully expected due to the fact that the stuff takes off, somersault forward and somersaults backward are structurally very different at this phase. During the airborne phase of the stuff take off, body at all times retains the position as it had in a moment of take off and slightly change it just before landing. While during a airborne phase of forward and backward somersaults, the body changes its position from the strait to tucked and back to strait while rotating around the transverse axis of the body. What distinguishes somersaults in flight phase is direction of rotation which causes different timing in, earlier mentioned, and changing the body position in space.

Comparative analysis of kinematic parameters of airborne phase in somersaults forward and backward

In earlier stage it was determined that the forward somersault and back somersault significantly differ, considering the trajectory CG in airborne phase. In this phase of analyze a comparative analysis of these phase was carried out, on the variables that describe the movement of CG in the airborne phase and the variables that describe the distribution of rotation, and changes body position. (Table 11.)

Table 11: Comparative analysis of airborne phase in somersaults forward and backward used. Mann-Whitney U test

NAME OF VARIABLE	p-level
Max height of flight	0,900
Flight altitude from take off point	0,789
Time elapsed from take off to max hight of flight	0,003
Duration of airborne phase	0,655
Horizontal move CG in airborne phase	0,005
Time elapsed from take off to hip angle < 90°	0,000
Height of CG at moment of hip angle < 90°	0,007
Lowest value of angle in hip joint	0,000
Height of CG at moment of lowest value of hip angle	0,307
Time elapsed from take off to lowest hip angle	0,013
Time elapsed from take off to hip angle >90°	0,000
Height of CG at moment of hip angle >90°	0,000
The biggest value of angle in hip joint	0,900
Height of CG at moment of biggest value of hip angle	0,000
Time elapsed from take off to biggest hip angle	0,000

A statistically significant difference between the forward somersaults and back somersaults was observed in almost all the parameters that describe the distribution of rotation in the airborne phase. The only two parameters that do not differ these elements are analyzed elements are: Height of CG at moment of lowest value of hip angle and The biggest value of angle in hip joint

The fact that there was no statistically significant difference in the height of CG at moment of lowest value of hip angle can be explained by the fact that at most of rotation in both somersaults was performed in the middle third of the trajectory of the flight, so while performing somersaults all the partners had the similar “tucked” position of the body in about the same stage of the airborne phase.

Also by the end of rotation in all the types of somersaults, after completing the rotation, body has to be prepared for landing phase in which all the forces that were developed during preparation phase, take off phase and airborne phase have to be amortize and controlled. Therefore after completing rotation (in any direction) legs are stretched and increase the angle of hip joint preparing that why for landing.

The correct body position while performing tucked somersaults is considered one when the angles in hip joint and knee joint are < 90°. It was detected that in performance of tucked somersault backward takes longer for the body to take that position, also it happened in higher point of flight. Furthermore in somersault backward body earlier start to prepare for the landing, and it take place higher in airborne phase than in somersault forward.

Due to the shorter time that body is in tucked position in somersault backward compare to the forward the angle in hip joint is significantly bigger in somersault backward.

Conclusion

Acrobatic rock ‘n’ roll is a sport that combines dance techniques and acrobatic elements. There are different groups of elements, but the most attractive are elements with airborne phase. These analyses lead us to a conclusion that there is a statistically significant difference in values of certain variables that describe airborne phase of all three elements of technique. The variable duration of airborne phase makes no difference between analyzed elements, the height of flight makes a difference between stuff take off and both of somersaults and all the other variables differ all three elements among each other.

Distribution of rotation in somersaults in acrobatic rock ‘n’ roll is similar, although the relative values of angles in hip and knee joints differ as well as timing of changing those angles during airborne phase. It was detected that in performance of tucked somersault backward takes longer for the body to take that position. In somersault backward the body starts earlier to prepare for the landing, and it takes place higher in airborne phase than in somersault forward.

References

1. Hay, J.G. (1985). *The Biomechanics of Sport Techniques*. Engelwood Cliffs: Prentice-Hall, Inc.
2. Krističević, T. (2001). Analiza nekih biomehaničkih parametara u izvedbama salta naprijed u različitim sportovima. Magistarski rad Kineziološki fakultet: Zagreb 2001.
3. Krističević, T., Knjaz, D., Antekolović, L.J. (2002).: Comparaison of two types of tucked forward somersault in acrobatic rock'n'roll. In: Proceedings book Kinesiology – New perspectives. (Eds. D. Milanović, F. Prot). Opatija 25-29. 9. 2002. pp. 222-225. Zagreb. Kineziološki fakultet
4. Krističević, T (2009). Kinematička efikasnost izvođenja zgrčenog salta u akrobatskom rock'n'rollu. Doktorska disertacija, Kineziološki fakultet: Zagreb 2009.
5. Mejovšek, M. (1989). Konstrukcija i evaluacija biomehaničkog N-segmentalnog modela za analizu gibanja muskuloskeletnog sistema ljudskog tijela. Doktorska disertacija. Fakultet za fizičku kulturu: Zagreb

COMPARATIVE ANALYSIS AND ADJUSTMENTS OF ANTHROPOMETRIC PARAMETERS ON SYSTEM FOR KINEMATIC MOVEMENT ANALYSIS AND 3D BODY SCANNER

Maja Mahnić¹, Filip Ujaković², Saša Janjić², Slavenka Petrak¹ and Vladimir Medved²

¹University of Zagreb, Faculty of Textile Technology, Croatia

²University of Zagreb, Faculty of Kinesiology, Croatia

Abstract

This paper presents a study performed with a purpose of connecting and upgrading measurement system for body kinematics and system for 3D body scanning, as a starting point for future development of articulated body model and new method for animation of human movement. Optoelectronic kinematic system for locomotion analysis and laser 3D body scanner primarily intended for anthropometric measurement for clothing design, were used for this purpose. According to performed comparative analysis of anthropometric landmarks and their positions defined in both methods, spatial coordinates of selected anthropometric measurement landmarks were determined, together with the surface coordinates of kinematic model, according to body markers defined in kinematic measurement process. Analysis of characteristic body cross-sections was also performed, as a base for determining positions of additional kinematic landmarks for measurement of upper limbs kinematic variables.

Key words: 3D body scanner, kinematic system, anthropometric landmarks, body segmentation

Introduction

Based on the anatomy as a science that studies shape and body parts distribution, we define body proportions. Anthropometric proportion analysis provides information of regularities and relationships of particular body parts, deviations from normal proportions or any presence of deformation (Karabegovic 2010). Results of anthropometric measurements are used in different industrial fields in which products are designed according to characteristics of human body (clothing and footwear design, furniture design, automobile industry, etc.). In last 15 years, different systems for 3D scanning and contactless measurement of anthropometric body characteristics were developed. Thereby, mathematical algorithms for automatic positioning of anthropometric measurement points are developed according to standards that proscribe ways of measuring human body for purpose of clothing design like International Standard ISO 7250 (Basic human body measurements for technological design) and ISO 8559 (Garment construction and anthropometric surveys - Body dimensions). Additionally, interactive computer processing of scanned body models enables defining of new anthropometric measurement landmarks and body dimensions relevant for particular field of application. Except precise body measurement on computer body model, advantage of 3D body application is in possibility to generate topology on measured body data where visualisation of 3D point cloud on screen gives clear interpretation of body shape (Petrak, 2007).

Since the computer 3D body models are progressively developed for different fields of application, present development stage of computer applications technology and virtual reality provides different static and dynamic models. Data on human movement, obtained by different motion-capture techniques are nowadays more and more used for body animation (Badler, 1993; Magnenant-Thalman, 2006). Optical motion capture systems for biomechanical analysis are based on capturing spatial positions of markers attached to the subject body, where number of markers depends on body part and movement that are captured. Measuring of human walk usually involves Davis protocol, developed especially for human locomotion analysis and presents standardisation for collecting kinematic data. Positions of body markers enable calculation of kinematic variables in centers of joints. Such systems are commonly used for analysis of musculoskeletal system and medical diagnostics (Medved, 2001). However, this systems find they application field in computer animation as base for development of kinematic inner model, i.e. virtual skeleton in multi-layered animations (Sun, 2001). Defining morphological and anthropometrical segmented surface model, which will provide smooth and realistic animation, greatly depends on dimension parameters of surface and inner model. In that sense, compatibility of measurement methods and systems used in development of such models is very important. Therefore, this paper presents research of anthropometric body characteristics in aspect of analysis and adjustment of anthropometric landmarks determined using system for 3D body scanning and generating surface model with positions of anthropometric landmarks important for body kinematics, as a starting point for development of new method for parametric kinematic model design.

Body kinematics measurement

System ELITE manufactured by Bioengineering Technology and Systems (BTS) includes 8 cameras and 8-canal telemetric surface electromyography that are connected to a computer. Spatial body movements are automatically registered at hundred times per second, with measurement spatial correctness in millimeters. Working area is 6 x 2 x 2 meters, which is enough for capturing locomotion activity like walking. System is based on capturing shape of reflective semi-spheric markers placed on subjects body. For body locomotion analysis markers are usually placed according to Davis protocol, fig. 1. Three nonlinear markers minimum are necessary to describe kinematic state of body segments. Measurement includes two phases, static and dynamic measurement. Static measurement results and input anthropometric parameters are presenting preparation on computing operations in dynamical measurement (Heimer, 2005).

11 anthropometric body measures of test subject are determined as input data for static measurement. Anthropometric measures together with captured spatial positions of body markers enable determination of imaginary joint centers spatial positions. Anthropometric measurement was performed with standard anthropometric instruments and points positions are determined by palpation. Static measurement was performed using optoelectronic system ELITE. During static measurement test subject stands in straight, relaxed position. Beside markers positioned according to Davis protocol, for the purpose of this study we captured additionally positioned markers characteristic for anthropometric measurement according to standards ISO 7250 and ISO 8559. Purpose of this methodology is to analyse compatibilities of ELITE system with 3D body scanner.

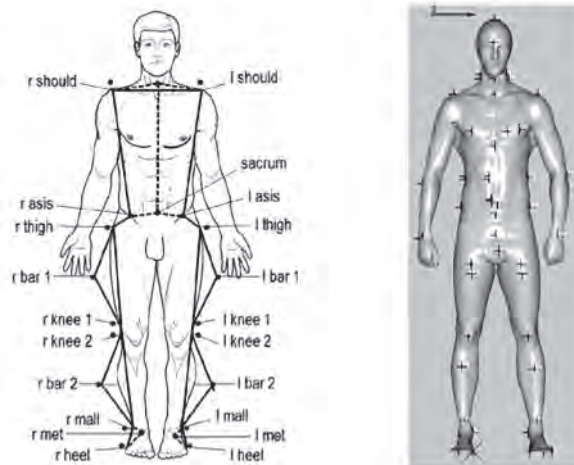

Figure 1: Anthropometric landmarks positions according to a) Davis protocol, b) ISO 7250 and ISO 8559

3D body scanning

The Vitus Smart 3D body scanner allows to scan an object in the area of 1,200 x 800 mm and 2100 mm in height. Scanning is performed by the system of 8 cameras and lasts 10 seconds, whereby 500,000 to 600,000 spatial coordinates of the scanned body are extracted. Data processing takes about 40 seconds, and then using the software package ScanWorx V 3.0.1. human body measurements are extracted. System also offers the possibility of correcting the obtained body measurements, as well as adding new ones (Petрак, 2012).

Body scanning of test subject was performed using 3D scanner VITUS Smart. By measuring dimensions between automatically defined anthropometric landmarks fig. 1, values of total 154 measurements are determined, where greater number of measures are determined separately for right and left side. Scanning proces was performed with body markers positioned on subject body according to Davis protocol in order to determine identical landmarks positions as in kinematic measurement protocol. Without body markers it would be difficult to determine right positions considering that characteristic joints positions usually consider palpation detection. Comparative analysis of both systems referent body landmarks and adjustment of namely same landmarks spatial coordinates was performed on scanned body model using ScanWorks 3.0.1. Positions of points that aren't determined by automatic measurement, but are important for movement kinematics, were defined according to body markers using interactive model processing. In that process, spatial coordinates of all necessary landmarks are defined, as shown in Results, fig. 4, tab. 1. Furthermore, analysis of characteristic body cross-sections was performed, whereby elbow and wrist cross-sections were analyzed in order to determine positions of additional referent points to expand Davis protocol on measurement of upper limbs.

Circularity function method is used in this analysis, which is defined to estimate similarity degree between a cross-section contour and circle (formula 1), with the assumption that close contours at the joints are irregular because the bones and muscles clearly reduce similarity degree of the contours to a circle (Yu, 2008). All joints positions except shoulders and thighs can be defined using circularity function method.

$$h(M_i) = \frac{4\pi \cdot s(M_i)}{c^2(M_i)} \quad (1)$$

M_i is a contour of the segment shape, s is the area of the contour, c is the perimeter of the contour and h is the circularity of the contour. When M is similar to a circle, h value runs to 1. Circularity function gains local minimum in the key contour whose center is a true joint because the key contour is more irregular than the others. In formula 2 M_j is the key contour that contained the joint, therefore the joint is the center of the contour M_j .

$$M_j = \arg \min(h(M_i)) = \arg \min\left(\frac{4\pi \cdot s(M_i)}{c^2(M_i)}\right) \quad (2)$$

Results

This section presents the results of positioning anthropometric landmarks according to Davis protocol and standards ISO 7250 i ISO 8559. Figure 2 shows stick kinematic models, where model on figure 2a contains 22 anthropometric markers according to Davis protocol, and on figure 2b additional positions of 11 anthropometric landmarks are presented, defined by standards ISO 7250 i ISO 8559. Values of spatial coordinates are determined for 22 markers defined by Davis protocol. However, this measurement protocol doesn't provide spatial coordinates of additional body landmarks.

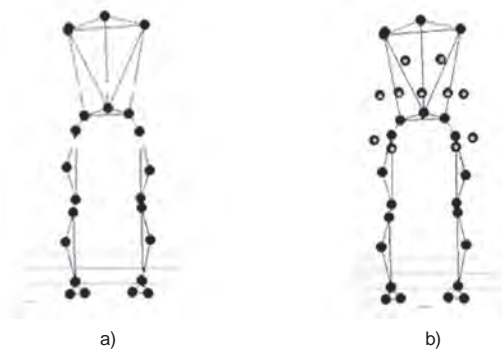

Figure 2: Stick figure model with anthropometric points: a) according to Davis protocol i b) with additional anthropometric landmarks according to standards ISO 7250 i ISO 8559

After 3D body scanning, with additionally positioned landmarks directly on subject, generated computer body model was used to perform comparative analysis of landmarks according to Davis protocol and automatically positioned landmarks according to standards ISO 7250 i ISO 8559. Initially analysis of landmarks overlaps was performed, comparing spatial coordinates and by visualisation on body model surface. Precise overlap was determined at position of anthropometric landmark C7, and at landmarks acromion right and left, slight differences in values of y coordinates were determined, fig. 3.

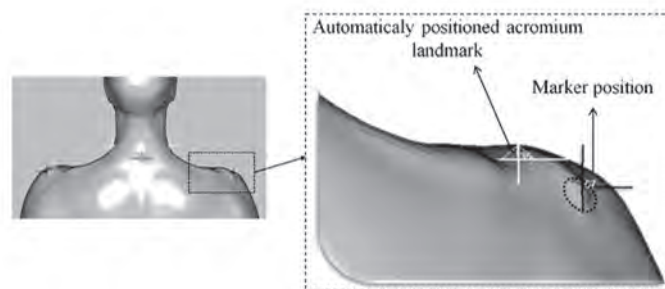

Figure 3: Body marker position compared to position of landmark defined by automatic measurement

Gathering the purpose of defining values of all anthropometric landmarks coordinates on body model, considered both methods, needed for body segmentation according to centers of skeletal joints, positions of acromion right and left determined by automatic measurement proces were adjusted on position defined by Davis. Furthermore, value of spatial coordinates of body markers positioned according to Davis protocol were defined using interactive measurement method, fig. 4, tab. 2, together with all landmarks coordinates according to standards ISO 7250 and ISO 8559. Determined coordinates for total of 76 body landmarks will be used in further research, for finding new method for body model surface segmentation and development of articulated kinematic model. 29 anthropometric measures that are in corelation with kinematic landmarks, and 4 measures for defining new points for upper limbs kinematics were selected from total of all landmarks coordinates. Computer analysis of joints cross-sections on upper limbs, fig. 5. according to circularity function (formula 1 and 2), can be used as a starting point for calculation of elbow and wrist joint positions and further expansion of movement measurement on upper limbs.

Table f: Spatial coordinates of landmarks on computer body model according to Davis protocol

Landmark	3D coordinates of kinematic landmarks			Landmark	3D coordinates of kinematic landmarks		
	x	y	z		x	y	z
C7	0.65344	-3.47810	-0.01948	knee_1_R	-0.45452	-3.69547	-0.19069
acrom_R	0.57311	1.68688	-0.23682	knee_1_L	-0.45951	-2.67840	0.18922
acrom_L	0.58177	2.23912	0.20470	knee_2_R	-0.53860	-7.82744	-0.20272
asis_R	4.46018	9.50140	-0.13451	knee_2_L	-0.53003	-7.12609	0.20023
asis_L	5.95260	0.10076	0.10699	mall_R	-0.95447	-9.51384	-0.18732
sacrum	7.91878	-0.10004	-3.81421	mall_L	-0.95281	-9.57249	0.21536
thigh_R	-0.02897	-1.20055	-0.18388	met_R	-1.01834	3.82413	-0.21702
thigh_L	-3.82853	-2.43606	0.17334	met_L	-1.02170	4.72458	0.26289

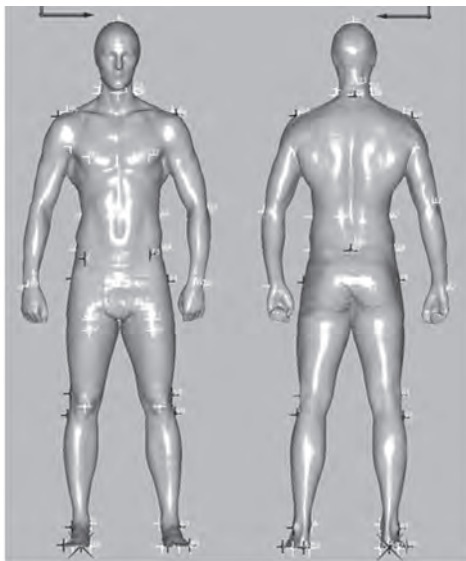

Figure 4: 3D body model with landmarks defined by Davis protocol and set of selected anthropometric points of ISO 7250 and 8559

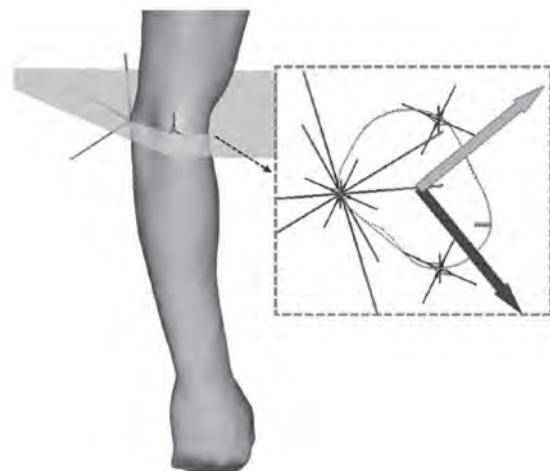

Figure 5: Elbow joint cross section with characteristic surface points

Discussion and conclusions

Differences between anthropometric landmarks positioning are the result of different purposes of systems. 3D body scanner is primary intended for anthropometric measurements for the needs of clothing design. Thus landmarks positioning on computer body model is based on standard which defines method for measuring anthropometric lengths of body segments. Measurement protocol of kinematic system for locomotion analysis define landmarks referent for body movement and determination of kinematic variables in centers of joints. It's evident that there are differences between anthropometric measurements in two systems and from those differences it is possible to determine relationships between surface body shape and inner skeleton model. To enable implementation of dynamic measurement kinematic variables it's very important to determine relationships between referent points for body shape segmentation and markers for gathering kinematic data in joints centers.

References

1. Badler N. (1993) *Simulating Humans: Computer Graphics, Animation and Control*, Oxford University Press, Oxford, New York
2. Heimer Z. (2005) Automated measurement of biomechanics and kinesiology of gait, MSc Thesis, University of Zagreb Faculty of electrical engineering and computing (in Croatian)
3. International Standard ISO 7250 Basic body measurements for technological design
4. International Standard ISO 8559 Garment construction and anthropometric surveys – Body dimensions
5. Karabegovic, I. (2010) Geometric properties and anthropometry of the human body, *Theoretical aspects and application of Carroatian Avthropometric System (CAS)*, chapter 4, p.p. 35-50, University of Zagreb, Faculty of textile technology, Croatia
6. Kasap, M & Magnenat-Thalmann, N 2011, Skeleton-aware size variations in digital mannequins, *Visual Computing*, 27, 263-274.
7. Magnenant-Thalmann, N. & Thalmann, D. (2006) *Handbook on Virtual Humans*, John Wiley & Sons, Ltd, England
8. Medved, V. (2001) *Measurement of human locomotion*, CRC Press, Boca Raton, FL.
9. Moeslund, T. et al. (2001) A survey of computer vision-based human motion capture, *Computer Vision and Image Understanding*, 81(3), 231-268
10. Petrak, S. (2007) The method of 3D garment construction and cutting pattern transformation models, PhD Thesis, University of Zagreb Faculty of textile technology (in Croatian)
11. Petrak, S., Mahnic, M. & Ujevic, D. (2012) Research of 3D body models computer adjustment based on anthropometric data determined by laser 3D scanner, *Proceeding of 3rd International Conference on 3D Body Scanning Technologies*, Hometrica Consulting, Switzerland, 115-126
12. Sun, J. et al. (2001) Layered animation of captured data, *The Visual Computer*, 17(8), 457-474
13. Yu, Y. et al. (2008) A Pose-Independent Method of Animating Scanned Human Bodies, *CGI 2008 Conference Proceeding*, 232-239

RELATIONS BETWEEN PRECISION, SPEED AND PERFORMANCE QUALITY OF HEAD AND FOOT INSTEP KICK AMONG FOOTBALL PLAYERS

Petra Mandić Jelaska¹, Durdica Miletić² and Igor Jelaska²

¹*Fitness Club "Pink Panther", Kaštel Stari, Croatia*

²*Faculty of Kinesiology, University of Split, Croatia*

Abstract

The aim of this study was to determine the correlation between the precision, speed and performance quality of head and foot instep kick as the basic technical elements of soccer game. Sample was consisted of 27 players (15±0.6 yr.) and they were measured in the variables: precision of foot instep kick, precision of head kick, foot instep kick technique, head kick technique, speed of the penalty kick, precision while measuring foot instep kick technique, speed of the ball while measuring foot instep kick technique, precision while measuring head kick technique, speed of the ball while measuring head kick technique, speed of the ball while measuring precision of the foot instep kick, speed of head kick while measuring precision. Canonical correlation analysis was applied. The correlation between sets of variables was identified (CanR=0.87, p=0.00). The results indicate a complex relationship and reciprocal conditionality of precision and speed with performance quality of basic football games technical elements.

Key words: motor control, motor learning, young football players, canonical correlation analysis, reliable estimation of football-specific motor knowledge

Introduction

Given the complexity and polistructurality of football game, surely there is no motor ability for which it can be sad that it is unnecessary in terms of success in football (Araujo et al., 2004; Ward & Williams, 2013). On the other hand, regardless of team sport game, not knowing the optimal biomechanical complex of movements that should be realized as part of the motor program usually results in non-optimal performance which as consequence generates a very high physiological response on load (Hart, 1999; Schmidt & Wrisberg, 2000). Also, improving of motor skills is directly reflected through increased accuracy of movement performance, reduction of energy consumption and sometimes minimization of the time required to perform a needed movement (Brady, 1998; Côté et al., 2003). In addition, it is important to emphasize that all anthropological potentials of players can be used optimally only when the motor knowledge comes into automation phase (Araújo et al. 2004; Mandić Jelaska, 2014). Researches suggest a positive correlation between variables of outstanding importance in football: the level of motor skill of head kick, level of motor skill of foot instep kick and accuracy (Mandić Jelaska et al., 2012). Furthermore, it is clear that quality players have the appropriate high level of football-specific motor knowledge which is manifested through performing skill of characteristic technical elements in football (Reilly et al. 2000). It should be noted that motor knowledge beyond the direct impact on the quality of the performance of specific motor tasks indirectly affects the dimensions of anthropological status (McCullagh & Weiss, 2001).

In a football game, head kick and foot instep kick are the basic technical elements. Certainly the quality of the realization of previously anticipated game tactics can be better if those main technical elements are realized optimally. It is important to say that kick (either foot or head) have to be achieved in a timely manner, accurately and powerfully, and perform relatively quickly (Davids et al., 2000; Mandić Jelaska, 2014). Foot kick is classified given which part of foot is used for its realization. Accordingly, we distinguish several types of foot kicks: kick with the ridge of the foot (middle, outer or inner part), kick with inner or outer side of the foot, kick with the top of the foot, kick with bottom of the foot and kick with the heel. The most commonly used in football is foot instep kick. In accordance with the foregoing, the aim of this research was to investigate the relations between various manifestations of ball speed, accuracy and performance quality of foot and head ball kick.

Methods

Sample in this research consisted of 27 football players (15 ± 0.6 yr.). Tested are only players who have been training for at least two years. Subjects were measured in variables: precision of foot instep kick (PFIK), precision of head kick (PHK), foot instep kick technique (FIKT), head kick technique (HKT) and speed of penalty shot (SPS). Also variables: achieved accuracy while measuring foot instep kick technique (AFIKT), speed of the ball while measuring foot instep kick technique (SFIKT), achieved accuracy while measuring head kick technique (AHKT), speed of the ball while measuring

head kick technique (SHKT), the speed of the ball while measuring accuracy (SA), speed of the ball while measuring precision of head kick (SPHK). All measurements were performed 3 times. Reliability and validity of used tests for the assessment of foot instep and head kick performance quality and precision have been previously tested on the same sample and tests were explained in details (Mandić Jelaska, Miletić & Jelaska, 2011). Two expert coaches and one first league player were judges who evaluated technique of motor skills according to defined criteria. Respondents during the measurement of foot instep and head kick performance technique did not know that precision is also measured. For all the variables parameters of descriptive statistics were calculated. Kolmogorov-Smirnov test was applied for testing of normality. Canonical correlation analysis between variables of foot and head kicking accuracy, precision ball head, foot instep kick technique, head kick technique and speed of the penalty kick with one hand, and all other variables on the other side was applied. Canonical correlation coefficient and coefficient of canonical determination, the value of Bartlett χ^2 test, the number of degrees of freedom and the associated significance level was calculated. Also given are the correlation coefficients of all the observed manifest variables with significant factors of only significant extracted canonical pair.

Results

In table 1 results of descriptive statistics and Kolmogorov-Smirnov test for all measured variables are presented.

Tablica 1: Descriptive statistics parameters of measured variables. Mean (AS), standard deviation (SD), coefficient of variation (CV%), minimal result (Min), maximal result (Max), skewness (Skew), kurtosis (Kurt), significance obtained by using Kolmogorov-Smirnov test (KS)

	AS	SD	CV%	Min	Max	Skew	Kurt	KS
HKT	8.11	2.81	34.59	3.00	14.00	-0.10	-0.28	>0.20
FIKT	9.30	2.23	24.02	4.00	13.00	-0.16	-0.05	<0.20
PHK	8.41	3.60	42.79	0.00	15.00	-0.11	0.02	>0.20
PFIK	10.04	3.80	37.84	2.00	15.00	-0.34	-1.04	<0.15
SPS	93.30	7.96	8.53	78.00	110.00	0.11	-0.38	<0.20
AFIKT	7.44	3.48	46.77	0.00	13.00	0.23	-0.86	<0.10
SFIKT	80.85	9.02	11.16	60.00	96.00	-0.28	-0.24	>0.20
AHKT	6.00	3.29	54.83	0.00	14.00	0.46	0.87	<0.05
SHKT	23.07	5.45	23.61	14.00	35.00	0.49	-0.35	>0.20
SA	84.22	10.28	12.20	65.00	103.00	-0.35	-0.73	>0.20
SPHK	24.07	5.53	22.39	14.00	35.00	-0.22	-0.54	>0.20

As expected, all variables of precision have a large relative variability and it can be seen trough coefficient of variation. Looking at speed of the ball variables, it can be seen that the maximum speed is achieved when measuring variable SPS. Skewness and kurtosis coefficients are consistently relatively low.

As previously stated, in order to analyze the structure of relations of measured variables, canonical correlation analysis was applied between variables and foot instep and head kicking accuracy, precision of foot instep and head kick, foot instep and head kick technique and speed of the penalty kick with one hand, and all other variables on the other side. In Table 2 are the canonical correlation coefficient, coefficient of canonical determination, the value of Bartlett χ^2 test, the number of degrees of freedom and the associated significance of extracted canonical pair and correlation coefficients of all the observed manifest variables with factors of extracted canonical pair.

Table 2: Results of canonical correlation analysis: factor structure matrix (Root1), coefficient of canonical correlation (CanR), coefficient of canonical determination (CanR²), value of Bartlett χ^2 test, degrees of freedom (df) and significance level (p)

	Root 1		Root 1
HKT	0.86	AFIKT	0.37
FIKT	0.92	SFIKT	0.70
PHK	0.29	SPHK	0.86
PFIK	0.39	SHKT	0.48
SPS	0.44	SA	0.47
		BRZPG	0.59
CanR= 0.87; CanR ² =0.75; p=0.00; χ^2 =55.09; df=30			

Results of canonical correlation analysis indicate the existence of only one significant canonical pair and that the observed correlation is relatively high (CanR = 0.87). Also in the table it can be seen that all the coefficients of correlation are positive and none is quite close to zero or completely negligible.

Discussion

From Table 1 it can be seen that all variables, except AHKT have distribution for which it can be concluded that does not deviate significantly from normal. In accordance with the foregoing, it is clear that all the variables are suitable for further parametric statistical analysis. Furthermore, after examining the minimum and maximum values of all speed of the ball variables, it can be seen that used sample is relatively homogeneous. On the other hand, while analyzing all variables of foot instep and head kick precision and techniques it can be seen that there is still possibility for improvement in these dimensions in the observed sample. It was expected that the variable precision, while primary foot or head kick techniques were measured have a larger variability and consequently non-normal distribution but due to relatively small sample only variable AHKT have distribution which significantly deviates from normal distribution.

Results clearly indicate a large and statistically significant canonical correlation between observed sets of variables (Table 2). Probably, existence of reciprocal and nonlinear interdependencies between all observed variables generates high canonical correlation. The first factor of significant canonical pair can be interpreted as a factor of technical performance quality. Measured variables of precision in second canonical factor were certainly of less important for respondents since main objective was to gain the performance quality and respondents did not know that accuracy is also measured. Therefore it is likely that those variables are closer to realization in football game than speed and accuracy when they are measured independently. Therefore, the second factor may be defined as a situational ball speed and situational accuracy. Accordingly, it can be said that a significant correlation between quality of performance and situational speed and precision of foot and head ball kick was identified. From the practical point of view, obtained results clearly indicate the necessity of intensification of technical segments during training of football players.

Foot and head kicks are the basic technical elements and creation of appropriate motor program has impact not only on situational variables of ball speed but also on other prominent technical elements of football games (for example, passing ball to a small/large distance by foot or head). Fully automated and properly learned motor programs certainly allow athletes to optimally structure other complex motions as well as minimizing energy consumption and optimum load of the musculoskeletal and nervous systems. Certainly there are reciprocal relations between the observed variables. For example, higher level of motor knowledge of each technical element will likely generate greater precision during situational performance while probably greater precision when performing a particular technique will likely generate more technique when performing the same. The results are consistent with previous research (Davids et al., 2000) which stated clearly state that although research on coordination and control of soccer skills is currently sparse, there are indications that the relationship between motor control and biomechanics could form a significant component of scientific programs in talent identification and skill development. Same authors state that further interdisciplinary work is needed to enhance understanding of coordination and control of soccer skills. In future studies of this type would be of outstanding importance to extend battery of tests of motor skills, but also to identify and to explain the relations between the variables for different age categories.

References

1. Araújo, D., Davids, K., Bennett, S.J., Button, C., & Chapman, G. (2004). Emergence of sport skills under constraints. In A. M. Williams & N. J. Hodges (Eds.), *Skill acquisition in sport: Research, theory and practice* (pp. 409–434). London: Routledge.
2. Brady, F. (1998). A theoretical and empirical review of the contextual interference effect and the learning of motor skills. *Quest* 50, 266–293
3. Côté, J., Baker, J., & Abernethy, B. (2003). From play to practice: A developmental framework for the acquisition of expertise in team sports. In J. L. Starkes & K. A. Ericsson (Eds.), *Expert Performance in sports: Advances in research on sport expertise* (pp. 89–114). Champaign, IL: Human Kinetics.
4. Davids, K., Lees, A., & Burwitz, L. (2000). Understanding and measuring coordination and control in kicking skills in soccer: implications for talent identification and skill acquisition. *Journal of Sports Sciences* 18(9), 703–14.
5. Hart, L. A. (1999). *Human Brain and Human Learning*. Kent, WA: Books for Educators.
6. Mandić Jelaska, P., Miletić, Đ., & Jelaska, I. (2011). Reliable Estimation of Soccer-Specific Motor Knowledge in Physical Education (In Croatian). 21th Summer School of Croatian Kinesiologists – Intensification of Exercise Process in Area of Education, Sport, Sport Recreation and Kinesitherapy. Zagreb: Tiskara Zelina, 207–212.
7. Mandić Jelaska, P., Miletić, Đ., & Jelaska, I. (2012). Measuring accuracy among young soccer players. (In Croatian) *Proceedings of the 4th International Conference “Contemporary Kinesiology”*, Miletić, Đ. et al., (Eds.). Split: Faculty of Kinesiology, Croatia, 195–202.

8. Mandić Jelaska, P. (2014). *Analysis of prescriptive and descriptive augmented feedback during learning of football-specific motor knowledge using newly constructed tests among younger school age children*. Dissertation. (In Croatian) Faculty of Kinesiology, Split.
9. McCullagh, P., & Weiss, M.R. (2001). Modeling: Considerations for motor skill performance and psychological responses. In R. N. Singer, H. A. Hausenblas & C. M. Janelle (Eds.), *Handbook of sport psychology* (2nd ed., pp. 205–238). New York: Wiley.
10. Reilly, T., Bangsbo, J., & Franks, A. (2000). Anthropometric and physiological predispositions for elite soccer. *Journal of Sports Sciences* 18, 669–83.
11. Schmidt, A.R., & Wisberg, C.A. (2000). *Motor Learning and performance*. Human Kinetics, Champaign.
12. Ward, P., & Williams, A.M. (2003). Perceptual and cognitive skill development in soccer: The multidimensional nature of expert performance. *Journal of Sport and Exercise Psychology* 25, 93–111.

GROUND REACTION FORCE IN PATIENTS AFTER TOTAL HIP ARTHROPLASTY REVISION – A PILOT STUDY

Eliska Martinaskova¹, Jiri Gallo², Petr Kaminek² and Miroslav Janura¹

¹Faculty of Physical Culture, Palacky University, Olomouc, Czech Republic

²Department of Orthopaedic Surgery, University Hospital, Olomouc, Czech Republic

Abstract

The aim of this pilot study was to determine ground reaction force (GRF) differences between operated and non-operated lower limb in patients after total hip arthroplasty (THA). An experimental group consists of patients after total hip unilateral arthroplasty revision, which was provided at least one year ago (5 men, age 60.2 ± 12.5 years, height 174.2 ± 7.4 cm, weight 85.8 ± 12.5 kg). For measuring ground reaction force during gait two force plates (Kistler Instrumente AG, Winterthur, Switzerland) were used. Three gait trials of each subject were evaluated. Differences between variables on affected and unaffected limbs were performed by effect size (Cohen's *d*). Large effect of THA was found for first and second vertical peak, propulsion vertical impulse and time of first vertical peak. The operated limb showed lower loading and earlier first vertical peak. The findings suggest asymmetry of the vertical loading, which can lead to uneconomic movement performance during the gait cycle.

Key words: total hip replacement, walking, vertical loading, stance phase

Introduction

The total hip arthroplasty (THA) is nowadays a common surgical procedure, thus for some people may seem as a trivial procedure. But it is necessary to consider it as a complex process that begins with the diagnosis of osteoarthritis and lasts practically throughout life (Palieri, 2011).

THA intervention may lead to asymmetric vertical loading of the bearing joints and cause the asymmetric overloading of the body segments (McRory, White & Lifeso, 2001). The most studies expected vertical loading symmetry after six months (van den Akker-Scheek, 2007; Bhargava, Shrivastava & Nagariya, 2007; Madsen et al., 2004; Slaven, 2012), however some research tested patients in full loading after four months (Billich et al., 2012) or conversely after two years after surgery (McRory, White & Lifeso, 2001).

Gait abnormalities may result in compensations in some patients (Whittle, 1996). The manifestation of these compensations occurs during the stance phase of the gait cycle thus in a closed kinematic chain (Vařeka & Vařeková, 2005). One of the basic walking tasks is an ability to minimize shock during the heel strike ("shock absorption"). Good shock absorption results in reduction of shocks and save large amount of energy, which can be used for the next movement (Perry & Burnfield, 2010).

Gait analysis of patients after total hip arthroplasty is necessary for an objective assessment of the THA effectiveness (Lamontagne et al., 2009; Slaven, 2012). There are several studies that indicate the necessity to deal with post-operative condition THA issue.

When the patient's age decreases for this type of surgery, the number of patients indicated to arthroplasty revision increases. Biomechanical parameters in the hip joint change significantly after the primary implantation of artificial replacement, and also after total hip arthroplasty revision, thus research in patients with THA revision is needed.

The aim of this study was to determine ground reaction force differences between operated and non-operated lower limb in patients after total hip arthroplasty revision and to assess the influence of period between operation and time of measurement.

Methods

Experimental group

A group consisting of 5 males after total hip unilateral arthroplasty revision, which was provided at least one year ago (age 60.2 ± 12.5 years, height 174.2 ± 7.4 cm, weight 85.8 ± 12.5 kg, time after surgery 5.3 ± 4.6 years).

Procedure

Three gait trials of each subject were evaluated. For measuring of GRF during gait two force plates Kistler 9286AA (Kistler Instrumente AG, Winterthur, Switzerland) were used.

Data processing

Analysis of vertical component of GRF was performed. Time variables were expressed in % of stance phase, GRF and force impulses were normalized by body weight. Following variables were assessed: first vertical peak (F1), second vertical peak (F2), time of the first vertical peak (t1), time of minimal vertical force (t2), time of the second vertical peak (t3), first vertical impulse (I1 – period from initial contact to minimal value between peaks), second vertical impulse (I2 – period from minimal value between peaks to toe off).

Basic statistical analysis was performed using Statistica version 12.0 (StatSoft, Inc., Tulsa, OK, USA). Comparison of mean values of variables on affected and unaffected limbs was performed by effect size (Cohen's d). The values smaller than 0.5 were considered as small effect, values between 0.5 and 0.8 as moderate effect and values higher than 0.8 as large effect.

Results

The results showed differences in the lower limbs loading during gait, particularly the asymmetry of the GRF vertical component.

The basic statistical characteristics of the experimental group are presented in Table 1, Table 2 and Table 3. Cohen's d test (effect size) confirmed some differences between affected and unaffected limbs.

Time variables

On the non-operated limb first vertical peak and minimal value between peaks comes earlier while the second vertical peak later.

Table 1: Comparison of time variables for operated and non-operated limbs

Variable	Operated		Non-operated		Cohen's d
	Mean	SD	Mean	SD	
t1	27.6	3	23.9	3.5	1.12***
t2	49.4	3.5	46.5	4.3	0.75**
t3	74	3.2	75.9	3.5	0.57**

Legend: SD – standard deviation, t1 – time of the first vertical peak [%], t2 – time of minimal vertical force [%], t3 – time of the second vertical peak [%], ** – moderate effect, *** – large effect

Normalized ground reaction forces

Higher values of force vertical peaks were founded for the non-operated limb.

Table 2: Comparison of force variables on operated and non-operated limbs

Variable	Operated		Non-operated		Cohen's d
	Mean	SD	Mean	SD	
F1	103.6	8	109.6	4.3	0.92***
F2	103	4.2	112.9	6	1.90***

Legend: SD – standard deviation, F1 – first vertical peak [N/kg], F2 – second vertical peak [N/kg], *** – large effect

Force impulses

First vertical force impulse was higher on the operated limb while second vertical impulse was higher on the non-operated limb.

Table 3: Comparison of force impulses variables for operated and non-operated limbs

Variable	Operated		Non-operated		Cohen's d
	Mean	SD	Mean	SD	
I1	5.6	0.5	5.3	0.2	0.65**
I2	5.8	0.6	6.5	1	0.82***

Legend: SD – standard deviation, I1 – first vertical impulse [Ns/kg], I2 – second vertical force impulse [Ns/kg], ** – moderate effect, *** – large effect

Discussion

To understand of gait in pathological stereotypes it is essential to understand physiological gait at first. However, it is necessary to bear in mind the great individuality embodiment. Any differences in patients gait in one case may not be undesirable in the second one (Whittle, 1996).

Time of the first vertical peak and time of minimal vertical force on non-operated limb compared with operated is lower. It could be due to slower loading transfer (weight acceptance) related with the natural uncertainty in operated limb loading and subsequently operated limb lightening. In practise it seems like symmetric muscle timing inability during heel strike, when operated limb is not able to create reliable shock absorber. Similar result presented also study of McRory, White & Lifeso (2001).

By contrast the time of the second vertical peak is slower in operated limb. It can be associated with toe off, i.e. operated limb's foot remains longer on the ground. Possible reason could be preparing for the next part of the gait cycle. It means that operated limb could perform shorter foot off than non-operated probably due to certainty in the impact of non-operated limb.

Increased values we found out both in the first vertical peak and the second vertical peak in the non-operated limb. These findings indicate more dynamic movement performance on non-operated limb, which could be warning because increased loading on limb may lead to overloading (Billich & Jelen, 2012), however in our case value about 110 % of body weight can be considered as physiological. Some authors assess also difference between first and second vertical peak (Bhargava, Shrivastava & Nagariya, 2007; McRory, White & Lifeso, 2001). They presented that difference between peaks was significantly smaller on non-operated limb.

The findings in force impulses suggest similarly as longer time of minimal vertical force that on the operated limb subjects move more slowly from braking to propulsion phase. It can be associated with lower certainty on this limb.

This project is only a pilot study. Authors are aware of the need for the complex assessment of THA revision symptoms similarly as study of Beaulieu, Lamontagne and Beaulieu (2010). They examined the influence of THA to pelvis, hip, knee and ankle kinematics on both operated and non-operated limb and also demonstrated a compensation variety of postoperative condition on the non-operated limb.

Conclusions

The findings suggest asymmetry of the vertical loading, which can lead to uneconomic movement performance during the gait cycle. This asymmetry manifests for a long time after the operation. Research investigation will be aimed at assessing the surgery effectiveness and the subsequent rehabilitation or different types of surgery in the future.

References

- van den Akker-Scheek, I. et al. (2007). Recovery of gait after short-stay total hip arthroplasty. *Archives of physical medicine and rehabilitation*, 88(3), 361-367.
- Beaulieu, M. L., Lamontagne, M., & Beaulieu, P. E. (2010). Lower limb biomechanics during gait do not return to normal following total hip arthroplasty. *Gait&Posture*, 32(2), 269-273.
- Bhargava, P., Shrivastava, P., & Nagariya, S.P. (2007). Assessment of changes in gait parameters and vertical ground reaction forces after total hip arthroplasty. *Indian Journal of Orthopaedics* 41(2), 158-162.
- Billich, R., & Jelen, K. (2012). Development of vertical ground reaction force after hip surgery. *Journal of Biomechanics* 45(Suppl 1).
- Lamontagne, M., Beaulieu, M. L., Varin, D., & Beaulieu, P. E. (2009). Gait and motion analysis of the lower extremity after total hip arthroplasty: what the orthopaedic surgeon should know. *Orthopaedic clinics of north America* 40(3), 397+.
- Madsen, M. S. et al. (2004). The effect of total hip arthroplasty surgical approach on gait. *Journal of orthopaedic research*, 22(1), 44-50.
- McCrory, J. L., White, S. C., & Lifeso, R. M. (2001). Vertical ground reaction forces: objective measures of gait following hip arthroplasty. *Gait&Posture* 14(2), 104-109.
- Palieri, G. et al. (2011). Surgical access and damage extent after total hip arthroplasty influence early gait pattern and guide rehabilitation treatment. *European journal of physical and rehabilitation medicine*, 47(1), 9-17.
- Perry, J., & Burnfield, J. M. (2010). *Gait Analysis: Normal and Pathological Function* (2nd ed.). Thorofare, NJ: SLACK.
- Slaven, E. J. (2012). Prediction of functional outcome at six months following total hip arthroplasty. *Physical Therapy*, 92(11), 1386-1394.
- Vařeka, I., & Vařeková, R. (2005). Patokineziologie nohy a funkční ortézování. *Rehabilitace a fyzikální lékařství*, 12(4), 156-166.
- Whittle, M. M. (1996). *Gait Analysis: an Introduction*. Oxford: Butterworth-Heinemann.

Acknowledgement

This paper was supported by the frame of project "Biomechanical gait analysis in patients with total hip arthroplasty" (Internal grant of Faculty of Physical Culture n.: FTK_2014:010).

KINEMATIC EFFICIENCY OF THE “MOZNIK” ELEMENT PERFORMANCE

Marijo Možnik and Željko Hraski

Faculty of Kinesiology, University of Zagreb, Croatia

Abstract

The aim of this research was to determine objective kinematics parameters of “Moznik” element which differ a successful performance from an unsuccessful one. For the purposes of this research twelve typical performances of the “Moznik” element were selected. Acquisition of kinematics parameters was done with the software system *DartFish* (*Video Analysis Solutions*). On the basis of the obtained data a set of 37 kinematics variables was formed. The results of this study showed that the angle of the hand in relation to the bar in a successful performance significantly differs from the one in an unsuccessful performance. It is evident that in the case of the successful performances, the so-called “whip” begins a bit later. It has also been found that after the release of the bar, the angles in the shoulders are considerably more open in successful performance than in an unsuccessful one.

Key words: *gymnastics, horizontal bar, biomechanics, angles, shoulders, hips*

Introduction

There are six apparatus in men artistic gymnastics. In all-around competitions, the horizontal bar is the last apparatus at which gymnasts compete. Horizontal bar is often considered as one of the most exciting gymnastics event due to the power exhibited by gymnasts during giant swings and spectacular flight elements and dismounts that often include multiple somersaults and twists. Known for its specificity, complexity and attractiveness, horizontal bar is popular called a “royal discipline”.

The standard height of the bar, measured from top of the mat, is 2.6 meters, or 2.8 meters measured from the floor. The horizontal bar routine consist of at least nine elements and the dismount. Skill complexity is evaluated by the International Gymnastics Federation Code of Points (FIG 2013.), using an ordinal scale, where ‘A’ is the least difficult and ‘G’ is the most difficult element. Each routine on the high bar must contain at least one element from each of the five different groups of elements, whereby it may contain a maximum of four elements from the same group. One of those groups is called “Flight Elements”, in which gymnast must release the bar, make a specific movement in the air, grasp the bar and continue with the routine. The gymnasts do connect elements through all exercise, and sometimes they connect two or three “Flight Elements” to achieve a bonus or bigger start value for the routine. Considering their attractiveness and the high skill level required, there has been comparatively much biomechanics researches of performance efficiency in elements from the “Flight Elements” group (Hraski 1992., Čuk 1992., Prassas et al. 2006., Hiley et al. 2007., Gittoes et al. 2013.).

In the gymnastics Code of Points every element has a detail description and some elements are named after the gymnasts who first registered and performed the element at the official FIG event - World Cup, World Championships, Olympic Games. The “Moznik” element belongs to the “Flight Elements” group, and was registered and performed for the first time at the World Championships in Stuttgart, 2007. It has an “E” value for difficulty. It was included in the FIG Code of Points from January 1, 2009, under the name “Moznik”, as the first element named after a Croatian gymnast. The full name of the “Moznik” element is – *Tkachev straight with ½ turn to mix grip uprise to handstand*. The specificity of its performance is manifested in the position of the head right before grasping the bar, where the head turns, disabling visual control with the bar. Due to this, as well as its extremely complex structure – the flight backwards over the bar with forward rotation of the body along with rotation due the longitudinal axis – the efficiency of its performance depends on a number of biomechanical details.

The aim of this research was to determine objective kinematic parameters of this element which distinguish a successful performance from an unsuccessful one.

Methods

The data of the “Moznik” element performances were collected from video materials, which were recorded at the same location, in an identical manner, during the two weeks of training right before the beginning of the competition season. The recordings was carried out with one single camera positioned in extension to the rotational axis (the bar) or vertical to the direction of the gymnast’s movement. The recording speed was 50 frames per second.

The subject of this study was a elite gymnast, 22 years old, 183 cm tall and weighs 80 kg. He is the first gymnast in the world who performed this element, which was therefore included in the FIG Code of points under his name.

From a large number of successful and unsuccessful recorded performances of the “Moznik” element, twelve typical performances were selected for the purposes of this research. The selection was done by a team of experts made out of one coach and two gymnastics judges. The main criterion for assigning a performance to the category of *successful* execution was whether the element, after the flight phase, was executed successfully by regrasping the bar and finished upright to handstand. A typical *unsuccessful* execution was classified as such according to the criterion of unsuccessful regrasping of the bar as a result of the gymnast’s too distanced position from the bar in the phase of regrasping the bar.

Acquisition of kinematics parameters was done with the software system *DartFish (Video Analysis Solutions)*. The space was calibrated by the markers positioned on and around the horizontal bar. For each of the 6 typical positions in each of the 24 video recordings, the reference points of the vertex, shoulders, hips and feet were manually marked. After that shoulders and hips angles were measured, as well as spatial positions of the palms, shoulders, hips and feet in relation to the bar. Determination of the reference points and the measurement of the kinematic parameters was done three times for each frame of the video, and the arithmetic mean of registered values was used for further analysis. On the basis of the obtained data, a set of 37 kinematic variables was formed, which was later processed (descriptive statistics, T-test) by means of the *Statistica for Windows* program. The selection of the variables was formed according to the structure of the analyzed element, i.e. on the fact that, during the execution of the “Moznik” element, the body of the gymnast moves by mutual interaction of the three segments of the body: the arms, trunk and legs. In this respect, in examination of six typical positions of the “Moznik” element execution, the set of kinematic variables consists of:

- F1 – Position of the last contact with the bar (*F1AA* - arms angle, *F1SA* - shoulders angle, *F1HA* - hips angle, *F1SH* - shoulders height, *F1HH* - hips height)
- F2 – Position right after releasing the bar (*F2AA* – arms angle, *F2SA* – shoulders angle, *F2HA* – hips angle, *F2SH* – shoulders height, *F2HH* – hips height)
- F3 – Position of the maximum flight height (*F3AA* – arms angle, *F3SA* – shoulders angle, *F3HA* – hips angle, *F3SH* – shoulders height, *F3HH* – hips height)
- F4 – Position at the beginning of rotation (*F4AA* – arms angle, *F4SA* – shoulders angle, *F4HA* – hips angle, *F4SH* – shoulders height, *F4HH* – hips height)
- F5 – Position of the first (left) hand contact with the bar (*F51HA* – first (left) hand angle, *F52HA* – second (right) hand angle, *F5PH* – palm height, *F5SH* – shoulders height, *F5HH* – hips height, *F5FH* – feet height, *F5SD* – shoulders distance, *F5HD* – hips distance, *F5FD* – feet distance)
- F6 – Position of the second (right) hand contact with the bar (*F61HA* – first (left) hand angle, *F62HA* – second (right) hand angle, *F6SH* – shoulders height, *F6HH* – hips height, *F6FH* – feet height, *F6SD* – shoulders distance, *F6HD* – hips distance, *F6FD* – feet distance)

Results

Last contact with the bar

According to the results, it is evident that significant difference between variables exist in the arms angle (*F1AA*), shoulders angle (*F1SA*) and hips angle (*F1HA*). The successful executions of the “Moznik” element in relation to the unsuccessful execution are characterised by a somewhat lower arm angle in relation to the bar (33° compared to 37°), and somewhat minor shoulders (173°/182°) and hips angles (208°/212°).

Releasing the bar

In the position after releasing the bar a significant difference between variables occurred only in terms of the height of the shoulders (*F2SH*) and it is amounted to 3 cm.

Maximum flight height

As in the first analyzed position *F1*, the significant difference between variables are shown in the arms angle (*F3AA*), shoulders (*F3SA*) and hips angle (*F3HA*).

Begging of turns around the longitudinal axis

In the position where the turn around the longitudinal axis begins significant difference between variables exists in four out of five arithmetic means of the analysed variables. The arm angle (*F4AA*) in successful performances of the “Moznik” element is 10° greater than in unsuccessful ones. Furthermore, the shoulders angle (*F4SA*) is 12° greater. In this position the shoulders height (*F4SH*) and hips height (*F4HH*) differ to a significant extent for the first time.

First (left) hand contact with the bar

In the successful performances, the angle of the hand which first comes into contact with the bar (F51HA) is greater than the one in unsuccessful performances of the “Moznik” element (149° compared to 124°). Differences between variables exist in the hips and the feet height as well. Also, a difference is shown in the height of the hips (F5HH) and of the feet (F5FH), which are 5 cm lower in the successful executions in the case of the hips, and 27 cm in the feet case. Finally, all the variables measuring the horizontal distance of the shoulders (F5SD), hips (F5HD) and feet (F5FD) from the bar are different and are logically less in successful than in unsuccessful performances.

Second (right) hand contact with the bar

In the position where the second hand comes into contact with the bar it is shown that a difference between variables exists in six out of nine analysed variables. In this position, as well as in the the previous one, the angle of the hand which first comes into contact with the bar is greater in successful than in unsuccessful executions (195° compared to 170°). Furthermore, the measurements which define the height of the body in that position are different to a relevant extent. The shoulders are 4 cm lower (F6SH), the hips 13 cm lower (F6HH) and the feet as much as 32 cm lower (F6FH) in the successful performances.

Discussion and conclusion

Last contact with the bar

The variations in arms, shoulders and hips angles in this phase can be explained in terms of premature hyperextension of the hips at the unsuccessful performances, which later resulted in the earlier opening of the shoulders angle, occurring as a consequence of an earlier realisation of the so called “*whip*” (*the fast hyperextension of the hips which is also followed by the opening of the shoulders angle*). The earlier realisation of “whip” causing premature release of the bar and that caused insufficient flight distance from the bar. The gymnast need enough distance from the bar for successful performance of turn, catch the bar and continue in back uprise to handstand, so this premature release caused unsuccessful performance of “Moznik” element.

Releasing the bar

Considering that the kinematic characteristics of the parable of the flight are defined during the last contact with the bar, it is not unusual that there are no statistically significant variations between successful and unsuccessful executions of the “Moznik” element during this early flight phase. In this connection, statistically significant 3 cm greater height of the shoulders in the unsuccessful performances was the consequence of the aforementioned premature hyperextension of the hips right before the release of the bar. Premature “whip” in unsuccessful performance caused flight direction of shoulders more vertical in this phase.

Maximum flight height

Compared to the overall comparative analysis of successful and unsuccessful performances of the “Moznik” element, the greatest variations were shown in this phase of the element performance. However, the highest values of standard deviations were registered as a result of the problematic position evaluation for the maximum flight height during manual digitalization of the reference points on the one hand and the fast opposite acts of arm and body movement during the flight phase on the other hand. The subsequent hyperextension of the hips at the moment of release results in faster opposite movement of some parts of the body in the flight phase – the arms and upper part of the trunk in a forward direction and the hips and legs backwards.

Begging of turns around the longitudinal axis

Obviously, the start of the turns arounds in successful performances begins by pronounced pushing the arms in a forward direction, along with a higher position of the shoulders (for 7.6 cm) and a somewhat lower position of the hips (for 3.2 cm).

First (left) hand contact with the bar

Pushing the arms in a forward direction or the opening of the shoulders angle is shown to be of great significance, and the hand which comes into contact with the bar is 25° more open in the successful than in unsuccessful performances.

Second (right) hand contact with the bar

In the most unsuccessful element performances, the second hand didn't reach the bar because the body was too far from the bar.

Finally, analysing the chosen kinematic parameters which determine the execution of the "Moznik" element, it is shown that in all positions the angle of the arms figures as a variable which distinctly distinguishes successful from unsuccessful executions (Figure 1). Considering that all spatial positions of the body are dominantly determined by the actions in the shoulders and hips, it is evident that in the case of the successful performance the so called "whip" begins somewhat later. It has also been found that after the release of the bar, the angles in the shoulders are considerably more open in successful performances than in unsuccessful ones (Figure 2). This is a consequence of a powerful forward shift of the arms which produces better conditions for the realization of turns around the longitudinal axis of the gymnast, as well as better conditions for achieving the grasp of the bar.

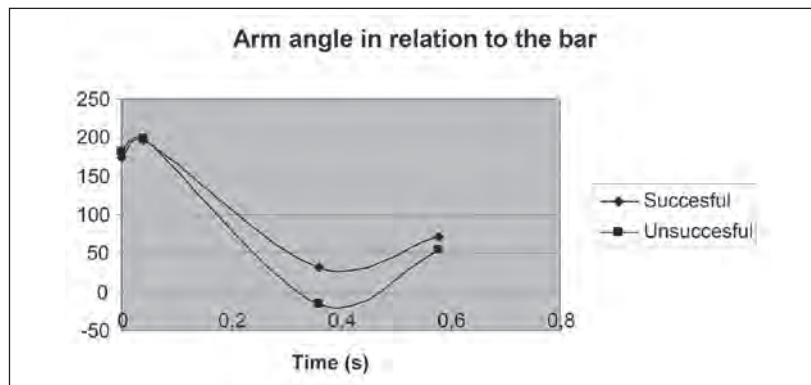

Figure 1: Arms angle in relation to the bar

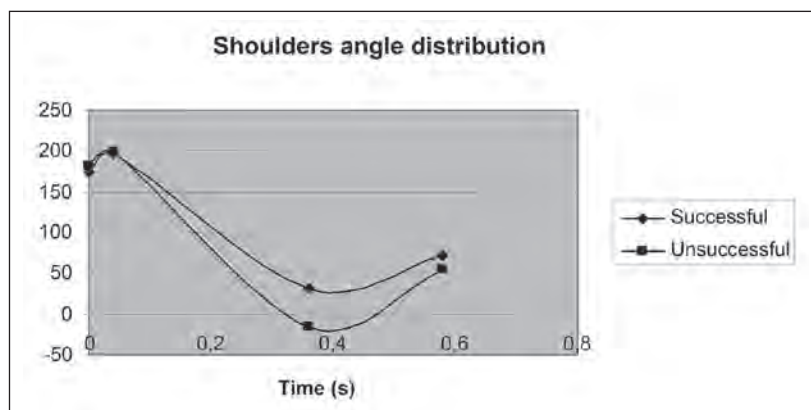

Figure 2: Shoulders angle distribution

The element "Moznik" was first performed in 2007. Due to the extremely complex structure of this element, the efficiency of its performance depends on a number of biomechanical details. The results of this study will directly help in the training process for the purpose of more focus detection and correction of mistakes in performance.

References

1. Čuk, I. (1992). Kinematic analysis of Gaylord I. *Biomechanics in Gymnastics*. Conference Proceedings, Köln, 1992. (15-25).
2. International Gymnastics Federation (2013). 2013 – 2016 Code of Points.
3. Gittoes, M.J.R., Irwin G., Kerwin, D.G. (2013). Kinematic landing strategy transference in backward rotating gymnastic dismount. *Journal of Applied Biomechanics*. 3, 253-260.
4. Hiley, M.J., Yeadon, M.R., Buxton, E. (2007). Consistency of performance in the Tkatchev release and re-grasp on high bar. *Sports Biomechanics*. 6, 119-128.
5. Hraski, Ž. (1992). Kinematics in different overgrip giant swings. *Biomechanics in Gymnastics*. Conference Proceedings. Köln, 1992 (15-25).
6. Prassas, S., Kwon, Y., Sands, W.A. (2006), Biomechanical research in artistic gymnastics: a review. *Sports Biomechanics*. 2, 261 – 291.

KINEMATICS OF HORSE AND RIDER INTERACTION DURING SIMULATED HORSE JUMPING

Petr Nemecek¹ and Lee Cabell²

¹Charles University, Czech Republic

²Seton Hall University, United States

Introduction

Jumping horses have been the focus of biomechanical research over the past 15 years.

Previous studies of horses involved linear kinematics, e.g., characteristics of gait [1], limb positions [2], [3]; the movement of Centre of Gravity (CoG) at jump take-off and landing [2], [4], [3], [5]; and the reaction of forces at take-off [1]. Clayton [4] briefly considered the importance of the horse's angular momentum that might improve athletes' technique. Other theorists have noted the importance of technique during the flying phase in successful jumping. To date, however, the impact of a variety of other factors, including rider posture, that may influence jumping results, remain unexamined.

The rider's influence on the horse has been researched only sporadically. Schöllhorn et al. [6] examined the interaction of horses and riders in the basic movements, and control, of the horse. The authors identified rider-horse interactions by means of data gathered via artificial neural nets, and analyzed in the time-continuous pattern. They concluded that their time course-oriented approach provided a sensitive tool for quantifying the interaction of rider and horse.

Galloux and Barrey [7] investigated the influence of the rider and the principal body segments of the horse on the total angular momentum of the horse-rider system. They concluded that the rider and the horse's trunk provided only a small contribution to total angular momentum; however, during the transfer of horse and rider's combined angular momentum in the jumping flight phase, the horse's forelimbs showed an increase, and its head and neck showed a decrease, in angular momentum [8].

Following this research, Powers and Harrison [9] examined the relative influence of the rider and specific segments of the horse body on the net angular momentum of the jumping horse. The authors found minimal rider influence on the moment of forces created by the jumping horse. The horse's trunk contributed less to the net angular momentum than did its head, neck, forelegs, or hind legs. Furthermore, the rider added little to the net angular momentum during the flight phase. The authors noted the transfer of the horse's angular momentum among the individual body segments during the flight phase, most obviously demonstrated in the angular momentum increase of the "chest" extremities corresponding to a decrease in the angular momentum of the horse's head and neck. The net angular momentum was found to be almost constant during the flight phase for the horse under conditions with, and without, a rider.

Our current study examines the role of the horse's head and neck in compensating for errors in rider position and balance. We hypothesized that nonzero angular momentum of the rider's body is created during rider movement backward (or forward) at horse take-off when the rider's CoG is misaligned with the horse's take-off force vector. In other words, when the rider moves incorrectly (i.e., movement that changes the common CoG), the horse compensates for the rider's shift by moving its neck and head in the opposite direction.

The purpose of the study was to demonstrate, through simulation, that the horse has more naturalistic jumping results when the rider adopts a balanced posture during the flight phase.

Materials and methods

Our simulation model was based on data gathered as follows. We recorded motion via retro-reflective markers attached unilaterally to specific anatomical [10], [11], [12] landmarks of each horse (chin, ear, withers, shoulder, elbow, tail root, knee, and stifle) and its rider (heel, knee, hip, shoulder, and top of head). We videotaped the horse and rider body positions using one panning digital camera (Sony DCR-TRV 110E, Tokyo, Japan) that allowed for two-dimensional (2-D) analysis [13] of their motions. The camera, with a sampling frequency of 50 Hz, moved 13 m distance from the horse and rider, and parallel to their movement. Eleven horses of different somatotypes, trained at the medium proficiency level, were used for data collection. The professional riders who participated in the study were asked to change their body postures to create visible "erroneous movements."

Each recorded jump trial began with a horse's one canter stride before take-off, continued through take-off and the "flight phase" over the obstacle and the landing, and concluded with one full canter stride after landing [4]. The horses were videotaped jumping over obstacles 0.8, 1.0, and 1.2 m in height and six separate recordings were taken of each horse (i.e., once over each of the three obstacle heights with and without a rider), for a total of 66 trials [14], [15], [16], [5]. In addition, the horizontal distance from a horse's take-off to its landing was measured by a tape measure and recorded.

The three obstacle heights were chosen to see whether the height did not influence the jumping style of the horse. At the end this concern was found not to be valid.

The video images were transferred to the Adobe Photoshop program (version 7.0 CE) to manually digitize the jumping sequences at time intervals of 0.1 s to allow for analysis of continuous movement via the simulation program. The analysis was two-fold: images of the horses alone were analysed, then the video images of each horse with its rider were overlaid onto the images of that same horse without a rider to compare the horse's neck position during flight during the two different testing states (i.e., with and without rider). Angles between body segments of the horse and rider were measured using a commercially available program (QuickPHOTO Industrial 2.3), and the video kinematic results were obtained in MATLAB and C++ software programs [17] used to calculate the basic simulation kinematic parameters, i.e., linear and angular velocities and accelerations of the horse and rider, to create our model.

Model of the Horse and Rider Body Systems and Their Simulation

The aim of these calculations was to build a numerical model that allowed us to simulate the

jump action of a horse with its rider. Through this simulation, we can model different rider positions with respect to horse positions and use this information to improve rider positions that may result in falls, injuries, or suboptimal jumping performance. Using video data from the real jumps, we constructed the following mathematical model to illustrate possible relationships between the rider's and horse's positions during the flight phase of the jump. In our calculations, the horse and rider were treated as two different rigid bodies, subject to the equations of motion.

Impulse-Momentum Theorem (a):

$$F = mdv/dt \quad (1)$$

$$v = dr/dt, \quad (2)$$

where, F = the average net force acting on the body, m = mass of horse and rider, r = the position vector of CoG, and v = linear velocity of horse and rider.

Impulse-Momentum Theorem (b):

$$dJ/dt = M, \quad (3)$$

$$J = Id\phi/dt, \quad (4)$$

where, J = momentum, t = time, M = moment of force, I = moment of inertia, and ϕ = the angle of the rider's body with respect to horse's neck.

The simulation is based on a numeric solution of these equations by the Euler method, which replaces derivation by differentiation. In the case of known linear velocity (v_n) and coordinate (r_n) in time (t), we calculated these values (with index $n+1$) in duration $t + h$ from relations (with known force F_a , which depends on r_n):

$$mv_{n+1} = mv_n + h.F_a \quad (5)$$

$$r_{n+1} = r_n + h.v_{n+1} \quad (6)$$

and similarly for the Impulse-Momentum Theorem (b):

$$J_{n+1} = J_n + h.M_a \quad (7)$$

$$\phi_{n+1} = \phi_n + h.J_{n+1}/I_n, \quad (8)$$

where, h = the integration step.

The value of integration (h) is calculated in the simulation program, using velocity data from several simulation views, i.e., selected as small as possible based on computer calculation. If the variables (r , ϕ) are given, then we use the above formulas to derive to the following values in arbitrary time ($t = n.h$): quantity of motion (p), velocity ($v = p/m$), angular momentum (J), and angular velocity ($\omega = J/I$ in duration $t = 0$ [initial value]). Force resultant (F_n), moment of forces (M_n), and moment of inertia (I_n) must be calculated for every stride.

There are two active forces in our model:

1. Gravitational force, which effects the horse's CoG, was measured by the methods of [18]. The rider has zero angular momentum, and the rider's force moment is calculated with respect to the horse's CoG. The force direction is along the y-axis, and the value $F_g = -mg$.
2. Interaction force (between horse and rider) has its point of action where the rider's knee meets the horse, and the force moment is generally non-zero. Because the calculation of this force is complex, a simulation model is beneficial. In this case, we used a spring model with a damping (Taylor's potential expansion), in which the rider's knees are connected to the saddle. The net (resultant) force is the sum of two vectors, one is proportional to the difference between position vectors, the other is proportional to the difference between the instantaneous velocities. A force acts, during the first approach, as a spring and is followed by a simple harmonic motion (Taylor's potential expansion).

Prior to this simulation process, it is necessary to know and input the initial conditions into the modelling program. These include the dimensions of the horse’s and rider’s body segments and their associated masses; the angles between the body segments; and the coordinates of the CoG of every segment. The net CoG of the horse [18] and the rider [19] are calculated by the following formula:

$$r_{net} = \frac{\sum m_i r_i}{\sum m_i} \quad (9)$$

where, r = radius of rotation, and m = mass of particular segments.

- The initial input values, determined by the positions of the individual body segments, were the following:
 - the initial angle of lean of the horse’s neck and rider’s trunk
 - the initial velocity of the horse’s and rider’s CoG, and the initial angular velocities of all segments.

We calculated the resultant (net) force (F), the linear momentum (M), and the moment of inertia (I). The coordinates (r, φ), together with the dimensions of body segments and the relative angles between them, are used for the calculation of the CoG for each segment.

The relative angles between body segments were not influenced by the external forces. To imitate the rider and horse actions, under the three conditions of the rider being in front, behind, or on the horse’s CoG, it is necessary to define the rider’s trunk position accordingly before calculating the net force, linear momentum, and moment of inertia. Specifically, change in the angle (θ) between the horse’s neck and rider’s trunk affects the moment of inertia of the horse and its angular velocity. Additionally, the angle of the horse landing is calculated at every step of the landing and is compared with the predicted angle of horse landing during the constant angular velocity. The moment of inertia and angular velocity of a horse change with each stride. Lastly, in response to the rider’s movements, the horse constantly changes its moment of inertia and angular velocity to land the jump at the

Results

Interpretation of the Model and its Visualization

We can differentiate between the effects of rider postures on horse jumping using a model created from data gathered from single jumps and rider asymmetries. Inherent in the validity of this tool is prior analysis of the horse’s jump without a rider because of the different modes and natural styles of the jump in each single case. Our model shows that, for all horses, only one segment, the horse’s neck, can correct the rider’s position errors relative to the horse’s CoG. The errors of rider position and effects of resulting asymmetries are illustrated in Figure 1, where the displacement of the rider’s CoG forward and backward against the horse’s CoG (when the rider’s body is not positioned parallel to the vector of the horse’s take-off) is depicted. The graph line of the horse’s neck CoG relative to rider’s trunk is almost identical to the graph line of the rider in the correct movement. The shift of the COG in space is created by the rider’s weight movement.

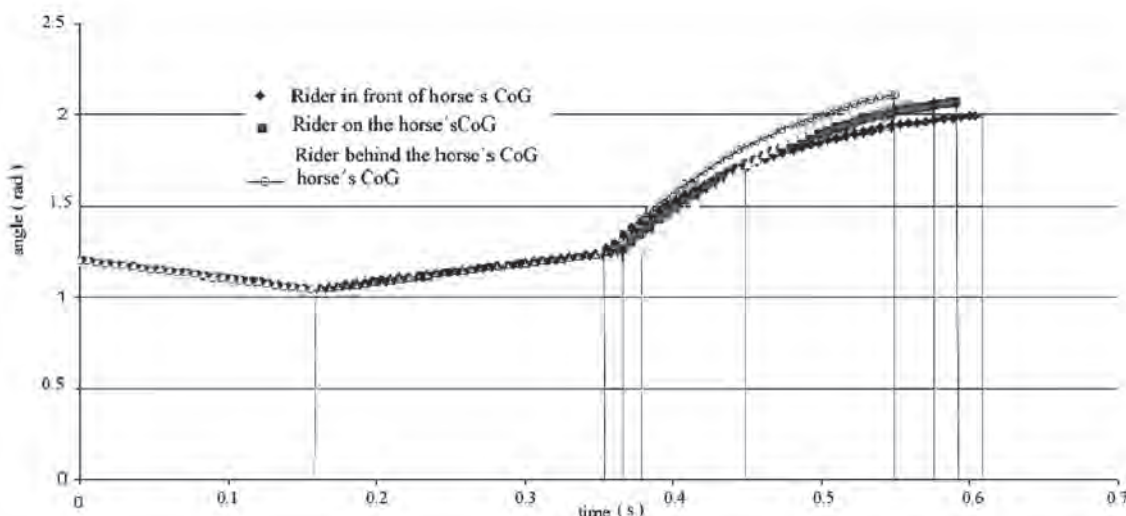

Figure 1: Relative angle between horse’s neck and trunk from take-off (time 0 s) to landing of the jump.

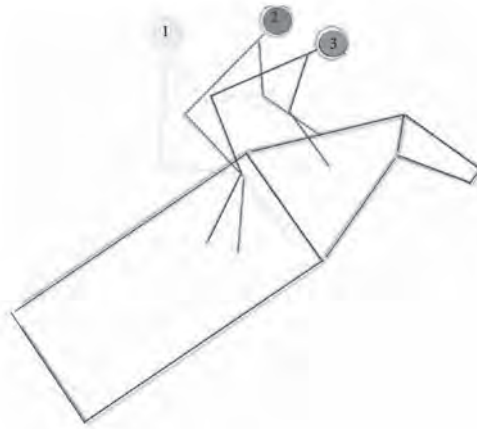

Figure 2a. Resulting model created by the simulation program: a horse with rider for each single faulty rider position. Take-off phase of the horse and rider

Rider behind the horse's CoG Rider on the horse's CoG Rider in front the horse's CoG

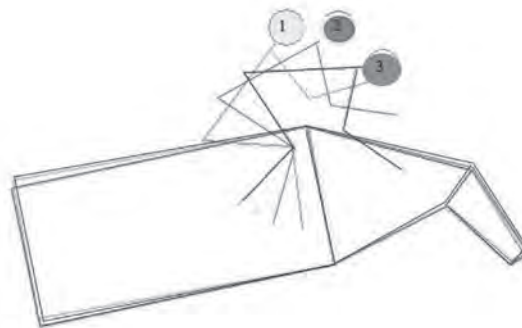

Figure 2b. Resulting model created by the simulation program: a horse with rider for each single faulty rider position. Mid-flight phase of the horse and rider

Rider behind the horse's CoG Rider on the horse's CoG Rider in front the horse's CoG

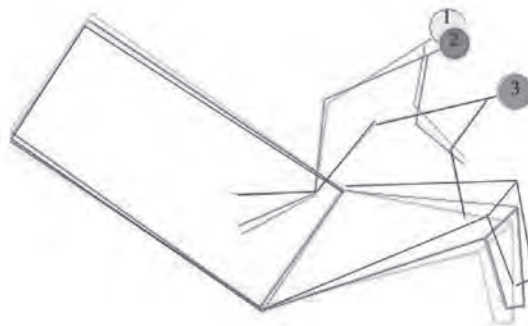

Figure 2c. Resulting model created by the simulation program: a horse with rider for each single faulty rider position. Initial landing positions of the rider and horse

Rider behind the horse's CoG Rider on the horse's CoG Rider in front the horse's CoG

We began each simulation scenario with the horse's body always in the same initial position, changing only the rider's posture to positions "in front of horse's CoG", "on the horse's CoG", or "behind the horse's CoG" in the simulation program. One advantage of our simulation software is that we were able to modify the anthropometry data of the horses and riders to match the actual segment body mass and length of real-life subjects.

Figure 3 shows inclination of the rider's trunk. Each rider's trunk position is depicted with comparisons to the jump of a horse without a rider. When the rider's trunk is "in front of the horse's CoG" position, the horse balances force by raising its head and neck, as seen in Figure 2. When the rider is positioned "behind the horse's CoG" position, the horse lowers its head and neck.

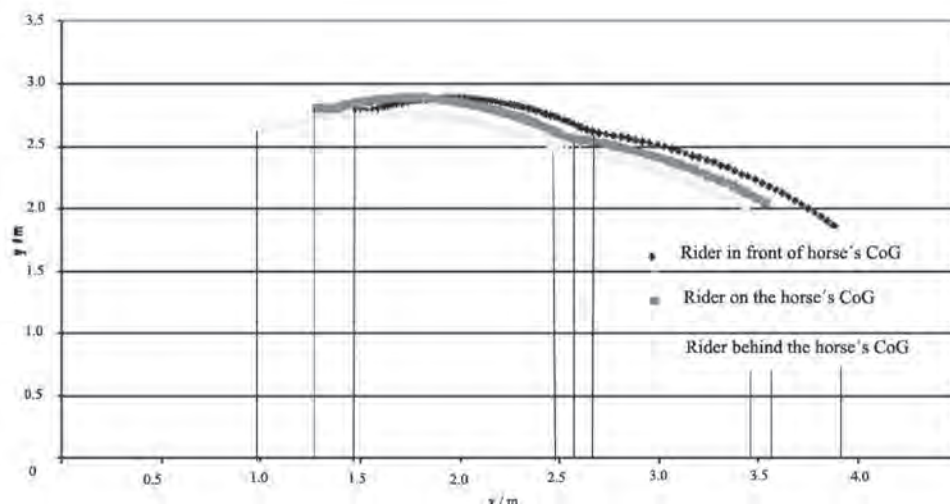

Figure 3. Positions of rider CoG in his postures

Discussion

This simulation model demonstrates relative angles between the horse's neck and trunk (Figure 3) as the horse balances the rider's movement using these two body segments to avoid faulty jumps or even falls. When the rider maintains a correct posture, the horse jumps almost as without a rider, which is its natural movement.

It is evident that not all jumps are the same [14], for example, different take-off conditions and velocities affect horse and rider movements, and it is challenging to identify horses' and riders' errors. Moreover, the mental and physical preparation of the horse and rider, and the trainer skills [3] also affect jump movements. A limitation of this model is that these parameters cannot be included in the software program. The positions of rider's arms and rein-holding parameters were also excluded from the study.

We can define the total numerical error (possible deviation in the simulation program) as the following: $e = h/t$, where t is the total duration of simulation ($t \approx 1$ s). The total approximate error is $0.001/1 = 0.1\%$, and the maximum relative error (E_{rel}) is 1%.

The accuracy of our simulation of the horse jump actually depends of two factors. First is the accuracy of the data describing initial conditions (such as the horse and rider's body dimensions and masses, angles between body segments, etc.); the condition values, given by the simulation program at take-off can be changed to reflect measured errors of the rider and horse. However, these values can influence only the total amount of the calculated phenomena, i.e., they cause only shifts of the curves along y-axis and have hardly any influence on the shape of the curve. The second factor in determining accuracy is more important: it is the inaccuracy inherently resulting from using mathematical calculations to simulate motion. The size of such an error depends on the size of the integration step used:

$$mv^{n+1} = mv^n + h.F^a \quad (10)$$

$$r^{n+1} = r^n + h.v^{a+1} \quad (11)$$

$$J^{n+1} = J^n + h.M^a \quad (12)$$

$$\varphi^{n+1} = \varphi^n + h.J^{a+1}/I^n \quad (13)$$

This step can also be set in the software program; in our model, the integration step $h = 1.024$ ms was used to obtain the graphs.

Conclusion

The calculations in the simulation model supported our hypothesis that the horse accommodates erroneous rider movement through its neck movement, i.e., the horse moves its neck in a specific direction to retain balance despite rider error. Due to the fact that only the horse's neck is the free moving segment, its mass and created internal forces are important. It is the only segment, which can balance the error made by the rider. Other segmental movements of horse's body, e.g., horse's lower extremities, are the results (or effects) of rider's body erroneous movements.

This simulation program allowed us to examine rider errors and asymmetries that cannot be seen clearly by the trainer's eye, or felt by a rider, and is also customizable to specific horses and riders because we are able to modify the anthropometry data of the horses and riders to match the actual real-life subject. The program also facilitates improved quality and effectiveness of the work with the horse and the horse's jumping potential, affords trainers better teaching methods, and potentially less trauma on horse's body [20], fewer falls, and improved safety.

References

- [1] Clayton, H., Leach, D., & Ormro, K. (1984). Standardized terminology for the description and analysis of equine jumping. *Journal of Equine Veterinary Science*, 16, 522–528.
- [2] Clayton, H. (1996). Time motion analysis of show jumping competitions. *Journal of Equine Veterinary Science*, 16, 262–266.
- [3] Dobeš J. (1986). *Jízda na koni: trénink jezdců a koně ve skokovém ježdění, všestrannosti a drezúře*. [Horse riding: training rider and a horse in jump riding, variety and dressage]. Prague, Czech Republic: Olympia.
- [4] Clayton H. (1989). Terminology for description of equine jumping technique. *Journal of Equine Veterinary Science*, 9, 341–348.
- [5] Paalman A. (1998). Skokové ježdění. [Jump riding]. Prague, Czech Republic: Brázda.
- [6] Schöllhorn, W.I., Pehamp, C., Licka, T., & Scheidl, M. (2006). A pattern recognition approach for the quantification of horse and rider interactions. *Journal of Equine Veterinary Science*, 38, 400–405.
- [7] Galloux, P., & Barrey, E. (1997). Components of the total kinetic moment in jumping horses. *Equine Veterinary Journal*, 23, 41–44.
- [8] Powers, P. (2004). Equine biomechanics – What does the rider do? Retrieved from http://www.irishscientist.ie/2001/contents.asp?contentxml=01p237a.xml&contentxsl=IS01pa_ges.xsl/
- [9] Powers, P., & Harrison, A.J. (2004). Influences of a rider on the rotation of the horse–rider system during jumping. *Equine Comprehensive Exercise Physiology*, 1, 33–40. [10] Kolda, J., (1936). Srovnávací anatomie zvířat domácích I, II. [Anatomical comparison of domestic animals I, II]. Brno, Czech Republic: Kolda's Publishing.
- [11] Kolda, J. (1950). Srovnávací anatomie zvířat domácích III, IV. [Anatomical comparison of domestic animals III, IV]. Prague, Czech Republic: SZN Praha.
- [12] Komarek, V. (1999). Koldův atlas veterinární anatomie. Prague, Czech Republic: Grada Publishing.
- [13] Janura, M. (1998). Application of a 3D videography in the analysis of gait – basic information. *Acta Universitatis Palackianae Olomucensis. Gymnica*, 28, 25–32.
- [14] Dušek, J. (1974a). Proměnlivost mechaniky pohybu koní při různém tvaru zkušební dráhy. [Variability mechanics of horse movement at a different test track shape]. *Živočišná výroba*, 5, 369–381.
- [15] Dušek, J. (1974b, May 15). Vliv různých zkušebních podmínek na mechaniku koní. [Influence of the various test conditions on horse mechanics]. *VŠCHK*, 17, 20–36.
- [16] Dušek, J. (1999). *Chov koní*. [Breeding horses]. Prague: Czech Republic: Brázda.
- [17] Cerny, M. (2002). Borland C++Builder (Version 6.0) [Computer software]. San Francisco, California: Embarcadero Technologies.
- [18] Buchner, H.H.F., Savelberg, H.H.C.M., Schamhardt, H.C., & Barneveld, A. (1997). Inertial properties of Dutch Warmblood Horses. *Journal of Biomechanics*, 30, 653–658. [19] Fredriksson, I., Gernandt, A., Hendlund, G., & Sederholm, L. (1976). Horses and Jumping. New York: Arco Publishing.
- [20] Denoix, J.M. (1991). Biomecanique et travail physique du cheval de sport. [Biomechanics and physical work of the horse in sport]. *L'avis du vétérinaire*, 89–92.

THE STATIC BALANCE ASSESSMENT IN BALLET DANCERS: THE EFFECT OF VISION AND LEG PREFERENCE

Marketa Prochazkova, Zdenek Svoboda, Michaela Blazkova and Lucie Tepla

Faculty of Physical Culture, Palacky University, Olomouc, Czech Republic

Abstract

The goals of this paper were to investigate the static balance in ballet dancers and to determine the effect of vision and the leg preference. Fifteen professional ballet dancers and thirteen non-dancers were asked to maintain balance in bipedal and single leg stance. Each posture was tested on dominant and non-dominant leg and in eyes-open and eyes-closed condition. Significantly lower values ($p < 0.05$) was achieved of standard deviation of centre of pressure (COP) movement and mean velocity of COP displacements in mediolateral (ML) direction in dancers, but in the anteroposterior (AP) direction ballet dancers obtained significantly higher values ($p < 0.05$) in both observed variables. Without vision during single leg stance the values of variables significantly higher ($p < 0.05$) in both groups. The leg preference was proved only in dancers group. These findings indicate that the ballet dancers are more stable in frontal and less stable in sagittal plane compared to controls and that the lateral preference plays role in dancers' balance. In the observed group the vision control affected the balance in single leg stance.

Key words: COP velocity, postural sway, specific balance training, vision conditions, leg dominance

Introduction

Dance is a specific manifestation of human motor behaviour (Hugel et al., 1999). It is known that ballet dancers possess “elite balance”. It remains a question if these balance abilities are affected by advanced training or by an intrinsic propensity (Hugel et al., 1999; Kiefer et al., 2007; Schmit et al., 2005). Dance involves integration between movement, postural balance and the multiple aspects involved with postural control (Costa et al., 2013) which depends on the vestibular sensory information, visual and somatosensory system (Costa et al., 2013; Vuillerme et al., 2001). For dancers and athletes in general, therefore, the good postural control is associated with the lower risk of injury (Mertz, Docherty, 2012).

Dance moves are usually performed on toe tips (*en pointe* or *demi-pointe* position) – thus the small base of support (Costa et al., 2013). Nevertheless the size and quality of the base of support, created with this area, represents the most important biomechanical limit on balance (Horak, 2006). It is known that dance on toe tips is unstable and it may lead to injuries due to falling (Shah, 2010). Three main types of movement strategies can be used to return the body to equilibrium in a stance position – ankle, hip and taking a step (Horak, 2006).

It is expected from ballet dancers to use lower limbs equally, so during practice both legs should be exercised evenly. However it is known that these ballet elements are practiced with a higher number of repetitions by one leg or by the frequent use of this limb as the swing leg. This preference, known as *lateral bias*, may contribute to the functional and physical differences between the limbs and therefore it could have negative consequences for the dancers, such as injury or chronic pain (Mertz, Docherty, 2012). There is a lack of information whether there is asymmetry before the initiation of dance training or whether this is the result of dance practice combined with dancer's functional dominance (Kimmerle, 2010).

One of the most discussed components of the dancers' postural control is vision. Some authors (Costa et al., 2013; Golomer et al., 1999b) suggested that vision plays a more important role in regulation of postural control in ballet dancers than other perceptual systems. These findings explain the fact that regular ballet specific strategies of balance training in front of mirror may lead to increased visual dependency of dancer. However, the results of Golomer et al. (1997, 1999a) suggested that regardless of the fact that vision plays an important role in postural control, dancers may, to a greater extent, rely on information from proprioceptive receptors and the vestibular system. These affect the attitudes to division of visual component of postural control in ballet dancers. The goals of the presented study were (1) to investigate ballet dancers' stability in standing posture, (2) to determine the vision effect and (3) leg preference effect on the balance in different postural tasks.

Materials and methods

Fifteen ballet dancers (BD) (5 males, 10 females; age 25.5 ± 5.9 years; height 168.8 ± 8.2 cm; weight 57.6 ± 9.8 kg) of the Moravian theatre ballet company in Olomouc participated in the presented study. Their ballet dance experience was 16.1 ± 4.8 years. All of them reported in the course of past 6 months they had not suffered from any acute articular injuries in lower limb.

The dancers were compared to 13 non-dancers (5 males, 8 females; age 23.5 ± 2.6 years; height 170.2 ± 10.1 cm; weight 66.2 ± 11.8 kg). None of the control group (CG) members had experience with ballet training, they did sport only as a recreational activity. Before testing the participants signed a written informed consent document and completed a dance, injury history and leg dominance questionnaire.

Postural stability data were obtained using a two force plates (Kistler Instrumente AG, Winterthur, Switzerland, 600 x 400 x 35 mm). The data were sampled at 200 Hz. Two variables for both ML and AP directions were used to describe the subjects' postural behaviour – the standard deviation of COP and the mean velocity of COP displacements. Each subject standing upright on the platform, barefoot, feet in the pelvis width apart, arms along the body was instructed to look straight ahead at the eye level.

Balance was tested in six postures:

- bipedal standing, eyes opened (EO),
- bipedal standing, eyes closed (EC),
- single leg standing, dominant limb, eyes opened (D_EO),
- single leg standing, non-dominant limb, eyes opened (nonD_EO),
- single leg standing, dominant limb, eyes closed (D_EC),
- single leg standing, non-dominant limb, eyes closed (nonD_EC).

For each experimental condition, the subjects performed one trial lasting 30 s. For statistical comparison (STATISTICA, Version 10.0, Stat-Soft, Inc., OK, Tulsa, USA) the Mann Whitney U test and Wilcoxon test were applied. The significance level was set at $p < 0.05$ for all tests.

Results

Means and standard deviations of observed variables and significance level are presented in Tables 1 – 3.

Comparison of BD and CG:

Our results showed significantly higher values ($p < 0.05$) in ML direction of standard deviation X_COP (SD_X) in CG in all postural conditions except D_EC. Likewise, the values of the mean velocity X_COP (Vx) were significantly higher ($p < 0.05$) in this group except the conditions of D_EC and nonD_EC.

On the other hand, in AP direction the values of the standard deviation Y_COP (SD_Y) were significantly higher ($p < 0.05$) in BD than CG in all balance conditions. Similarly, the mean velocity Y_COP (Vy) was significantly higher ($p < 0.05$) in BD except D_EO and D_EC conditions.

Significantly higher ($p < 0.05$) total velocity of COP (V) was found in BD under all conditions except D_EO and D_EC.

Vision effect:

Significant differences were found in bipedal standing in Vx in CG and V in BD, whereas in any other condition differences were not determined. In single leg conditions with and without vision our results showed significant differences in all observed parameters except SD_Y in controls in non-dominant single leg standing.

Leg preference effect:

The obtained results revealed no significant differences between stance on dominant and non-dominant leg in non-dancers. However, in dancers the leg preference was proved. Our results showed significantly higher values ($p < 0.05$) of the SD_Y in non-preferred single leg standing with and without vision. Furthermore, Vy and V was significantly higher ($p < 0.05$) in non-dominant single leg standing with OE.

Table 1: Variables of the balance assessment – comparison of BD and CG.

Balance conditions	Variable	Control		Ballet		Mann Whitney (p)
		Mean	SD	Mean	SD	
EO	SD_X (mm)	6.4	2.7	2.7	1.2	0.000
	SD_Y (mm)	20.5	11.8	37.6	0.8	0.000
	Vx (mm/s)	9.9	3.8	5.1	1.1	0.002
	Vy (mm/s)	26.2	12.4	44.4	1.3	0.000
	V (mm/s)	29.9	11.6	46.8	1.8	0.000
EC	SD_X (mm)	7.3	2.1	2.4	1.0	0.000
	SD_Y (mm)	18.6	10.9	37.7	0.7	0.000
	Vx (mm/s)	12.1	3.9	6.0	1.0	0.000
	Vy (mm/s)	24.6	11.7	45.5	2.0	0.000
	V (mm/s)	29.7	11.3	48.6	2.4	0.000
D_EO	SD_X (mm)	8.2	2.1	3.7	0.9	0.000
	SD_Y (mm)	19.4	11.7	35.0	0.9	0.041
	Vx (mm/s)	20.2	8.4	13.1	3.6	0.002
	Vy (mm/s)	37.5	15.2	50.8	5.3	0.065
	V (mm/s)	46.7	15.9	57.5	5.7	0.156
nonD_EO	SD_X (mm)	8.8	3.0	3.9	0.8	0.000
	SD_Y (mm)	22.7	12.3	40.5	0.9	0.001
	Vx (mm/s)	19.5	7.1	13.6	3.0	0.004
	Vy (mm/s)	40.3	14.0	56.3	4.6	0.019
	V (mm/s)	48.7	14.9	63.2	5.3	0.029
D_EC	SD_X (mm)	10.7	2.5	8.8	2.3	0.065
	SD_Y (mm)	22.2	11.0	39.3	6.2	0.001
	Vx (mm/s)	40.8	14.8	35.3	11.9	0.156
	Vy (mm/s)	61.3	16.4	79.8	24.5	0.052
	V (mm/s)	82.1	21.7	98.5	28.5	0.235
nonD_EC	SD_X (mm)	10.9	0.9	7.8	1.6	0.000
	SD_Y (mm)	20.3	9.0	42.4	3.4	0.000
	Vx (mm/s)	39.2	6.6	37.2	11.6	0.413
	Vy (mm/s)	61.5	14.8	81.8	10.4	0.001
	V (mm/s)	79.8	14.6	101.7	16.4	0.001

Legend: SD – standard deviation, EO – bipedal standing, eyes opened, EC – bipedal standing, eyes closed, D_EO – single leg standing, dominant limb, eyes opened, nonD_EO – single leg standing, non-dominant limb, eyes opened, D_EC – single leg standing, dominant limb, eyes closed, nonD_EC – single leg standing, non-dominant limb, eyes closed, SD_X – standard deviation X_COP, SD_Y – standard deviation Y_COP, Vx – mean velocity X_COP, Vy – mean velocity Y_COP, V – mean total velocity COP, p – significance level.

Table 2: Significance of the vision effect

Vision effect	Wilcoxon test (p)									
	SD X		SD Y		Vx		Vy		V	
	Control	Ballet	Control	Ballet	Control	Ballet	Control	Ballet	Control	Ballet
EO x EC	0.064	0.191	0.972	0.609	0.005	0.027	0.382	0.078	0.075	0.020
D_EO x D_EC	0.002	0.001	0.005	0.005	0.001	0.001	0.001	0.001	0.001	0.001
nonD_EO x nonD_EC	0.016	0.001	0.507	0.006	0.001	0.001	0.003	0.001	0.001	0.001

Legend: see Table 1.

Table 3: Significance of the leg preference effect

Leg preference Effect	Wilcoxon test (p)									
	SD X		SD Y		Vx		Vy		V	
	Control	Ballet	Control	Ballet	Control	Ballet	Control	Ballet	Control	Ballet
nonD_EO x D_EO	0.279	0.191	0.064	0.001	0.279	0.394	0.064	0.001	0.173	0.001
nonD_EC x D_EC	0.753	0.173	0.382	0.031	0.753	0.233	0.422	0.069	0.101	0.125

Legend: see Table 1.

Discussion

In the ankle postural strategy, the feedback from proprioceptive, visual or vestibular system is applied to a greater extent (Zemkova, 2008). Injuries of articular receptors of ligaments and joint capsules reduce proprioceptive stimuli which lead to a reduction of the response and deterioration of perception of joint position. In the feet area this can cause instability in the ankle, thus instability in the sagittal plane, because the ankle (above all plantarflexors) plays a significant role in postural correction in the AP plane (Rein et al., 2011; Boyas et al., 2003). In the presented study comparing the balance control of professional ballet dancers and non-dancers, it is shown that ballet dancers had better postural control in ML direction whereas in AP direction the subjects without dance experiences had better postural control. Repeated ankle sprains, as the most common ballet dancers' injury, may be the reason why the dancers are more stable when applying the hip strategy, applies in the MP plane, and not the ankle strategy (Rein et al., 2011; Zemkova, 2008; Boyas et al., 2003). Another explanation of this may be the demanding character of the ankle strategy (Zemkova, 2008), as the ballet itself puts extreme physical demands on the dancers' musculoskeletal system. Also the character of ballet dance, which is carried out on a narrow base of support (*demi-pointe, en-pointe*), can compel the dancers to the hip strategy use (Costa et al., 2013). As described in the literature, the hip strategy is used when standing on narrow or compliant surface. But when standing on a firm surface with low level intensity sway the ankle strategy is applied (Horak, 2006; Zemkova, 2008). Research describing excellent postural stability in professional ballet dancers (Bronner, 2012; Rein et al., 2011; Kiefer et al., 2007) are usually carried out among ballet dancers themselves, therefore testing only highly complex and challenging positions. Nevertheless, it has been discussed that specific balance training can have effect only during the demanding conditions of balance and cannot be transferred to less demanding balance conditions, such as in postural control in daily life activities (Schmit et al., 2005; Vuillerne et al., 2001; Costa et al., 2013). This confirms Henry's hypothesis (Henry, 1958) which denies existence of so-called automatic transfer between some capabilities or accepts its existence only on very low levels because these capabilities are specifically applicable to particular tasks. This means that a person with a good level of static balance may not be able to maintain stability while standing in dynamic conditions and vice versa (Vuillerne et al., 2001; Zemkova, 2008). According to Kiefer et al. (2007) it is very difficult to compare the dancers with different groups of athletes due to the fact of existence of differences in their practice.

The results of our study further revealed that in the case of low postural demands the vision is not relevant for maintaining balance, in both the dancers and the non-dancers. For more demanding conditions of balance, vision proved to be an important factor influencing the balance maintenance in both observed groups.

Our findings also showed that functional dominance had no impact on maintaining the balance in the general population in all postural conditions. However, the preference of the lower limb was indicated in the dancers in AP direction.

Conclusions

The results of the present study revealed that ballet dancers have better balance in frontal plane, but showed worse results in sagittal plane as compared with the subjects without dance experiences. These findings suggested that specific balance dance training is not transferable to less challenging balance conditions which are more representative of everyday life. Visual dependency was found only in challenging postural balance conditions, therefore in single leg stance in both groups. Finally, the lateral preference effect was found only in dancers group in sagittal plane. For more complex understanding of visual and lateral preference influence on ballet dancers' balance, further research of this nature is required.

References

1. Boyas, S., Hajj, M., Bilodeau, M. (2013). Influence of ankle plantarflexor fatigue on postural sway, lower limb articular angles, and postural strategies during unipedal quiet standing. *Gait Posture*, 37(4), 547–551.
2. Bronner, S. (2012). Differences in segmental coordination and postural control in a multi-joint dance movement: développ  arabesque. *J Dance Med Sci*, 16(1), 26–35.
3. Costa, M.S., Ferreira, A.S., Felicio, L.R. (2013). Static and dynamic balance in ballet dancers: a literature review. *Fisioterapia e Pesquisa*, 20(3), 292–298.

4. Golomer, E., Dupui, P., Monod, H. (1997). The effects of maturation on self-induced dynamic body sway frequencies of girls performing acrobatics or classical dance. *Eur J Appl Physiol Occup Physiol*, 76(2), 140–144.
5. Golomer, E., Cremieux, J., Dupui, P., Isableu, B., Ohlmann, T. (1999a). Visual contribution to self-induced body sway frequencies and visual perception of male professional dancers. *Neurosci Lett*, 267(3), 189–192.
6. Golomer, E., Dupui, P., Sereni, P., Monod, H. (1999b). The contribution of vision in dynamic spontaneous sways of male classical dancers according to student or professional level. *J Physiol Paris*, 93(3), 233–237.
7. Horak, F.B. (2006). Postural orientation and equilibrium: what do we need to know about neural control of balance to prevent falls? *Age Ageing*, 35 Suppl 2:ii7–ii11.
8. Hugel, F., Cadopi, M., Kohler, F., Perrin, P. (1999). Postural control of ballet dancers: a specific use of visual input for artistic purposes. *Int J Sports Med*, 20(2), 86–92.
9. Kiefer, A.W., Cummins-Sebree, S., Riley, M.A., & Hass, J. G. (2007). *Control of posture in professional level ballet dancers*. 14th International Conference of Perception and Action, Yokohama, Japan.
10. Kimmerle, M. (2010). Lateral bias, functional asymmetry, dance training and dance injuries. *J Dance Med Sci*, 14(2), 58–66.
11. Mertz, L., Docherty, c. (2012). Self-described differences between legs in ballet dancers. Do they relate to postural stability and ground reaction force measures? *J Dance Med Sci*, 16(4), 154–160.
12. Rein, S, Fabian, T, Zwipp, H, Rammelt, S, Weindel, S. (2011). Postural control and functional ankle stability in professional and amateur dancers. *Clin Neurophysiol*, 122(8), 1602–1610.
13. Schmit, J.M., Regis, D.I., Riley, M.A. (2005). Dynamic patterns of postural sway in ballet dancers and track athletes. *Exp Brain Res*, 163(3), 370–378.
14. Vuillerme, N., Danion, F., Marin, L., Boyadjian, A., Prieur, J.M., Weise, I., Nougier, V. (2001). The effect of expertise in gymnastics on postural control. *Neurosci Lett*, 303(2), 83–86.
15. Zemkova, E. (2008). Coordination skills diagnosis. Peter Mačura – PEEM, Bratislava.

Acknowledgement

This study was supported by the research grant [grant no. FTK_2014:020] “Evaluation of postural stability in professional dancers” of Faculty of Physical Culture in Olomouc.

BIOMECHANICS OF SKI TURN MOVEMENT IN DOWNHILL SKIING

Vladimir Psalman and Jozef Balaz

Pedagogical fakulty, South Czech University, České Budějovice, Czech Republic

Abstract

Purpose: Purpose of this paper is to describe ski turn movement in downhill skiing from biomechanics point of view.

Methods: Selected ski turns were analyzed and described by internal and external forces. Based on several case studies biomechanics of ski turn movement in downhill skiing was done.

Results: Movement of skier during the arc path consists of a system synergistically operating external (physical) and internal (muscle) forces. They described a complicated image of movement elements, which are changing depending on the complex conditions.

Conclusions: Ski arc is a complex psychomotoric activity in motion on an inclined plane. Complexity is based on a complicated set of elements in the synergistic action of internal management and control the movement and action of mechanical forces. Difficulty is determined by the need for a high level of coordination and strength abilities to manage and regulate complex synergistic level of the participating systems.

Key words: *biomechanical study, ski turn in downhill skiing*

Introduction

Movement on an inclined plane in downhill skiing is practiced primarily by two forces - gravitational and muscular. The movement creates an additional set of forces, which modifies all types of movements on the slope.

If we are going from direct downhill skiing, so the other movements are always making on the arc paths. Their trajectory may differ from various causes. The primary is always muscular force that will change the state of motion of the body segments, and then there are changes in the whole body.

The biomechanics have enough tools to describe this complex phenomenon. Changing the direction of motion - specific curves are used in theories of mechanics. These sufficiently and precisely describe the reasons for changes of motion trajectory. For a description of the biological forces - muscular force, are used physical descriptions of the characteristics of the fact that movement does not improve only by the interaction of two bodies, but by complex of physiological, biochemical and psychological processes. Therefore, to explain the phenomenon of changes in human movement were created previously the problems with determining relationships in the physical and biological variables.

Currently, the muscular force is integrated into synergy with physical forces. Movement is so explained very accurately.

Basic laws of driving in the curves in Alpine skiing

Driving in the curves, the skier is during trajectory in three positions. Twice in downhill oblique and once passing along the fall line in the straight downhill (Figure 1).

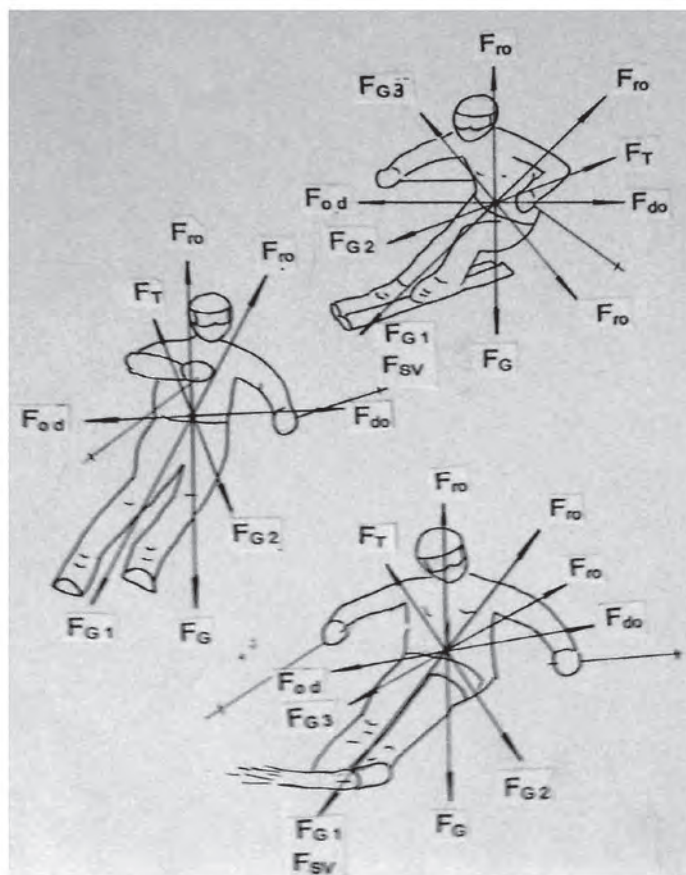

Figure 1: Activity of internal and external forces in three positions during the ski turn (indicated from center of gravity)

Skier is located in two dynamic situations that vary in states of forces and in technique of their utilization.

Alpine arc is from the aspects of biomechanics divided into three basic parts:

- Putting the ski and skier system on the arc path
- Regulating the movement during the arc path
- Putting the ski and skier system in linear motion on the opposite side

Biomechanical analysis of start of movement change from straight forward to curvilinear

Basis for changing the direction of movement is change in relative positions of body segments. It exists by influence of muscular force (F_{sv}), which is a set of segments - shins, knees and thighs inside the angle of the next arc. This movement is getting skis on their edges and starts operating system of external (physical) forces that cause change in motion of the skier (Figure 2).

Influenced by ski shape during edging, the friction (F_t) and ground reaction force (F_{ro}) are increasing on the both ends of skis. There is a momentum of rotation – angular momentum at different points of rotation (ski tip and tail), resulting in a transverse rotation axis at the level of segmental gravity of skis (Figure 2).

Legend to figures 1, 2 and 3:

- F_t, F_T – Force of friction
- F_{sv} – Muscular force, M_{sv} – Momentum of muscular force
- F_{ro} – Ground reaction force
- F_G – Force of gravity M_G – Momentum of gravity force
- F_Z – Force of inertia, M_Z - Momentum of force of inertia
- F_{od} – Centrifugal force
- F_{do} – Centripetal force

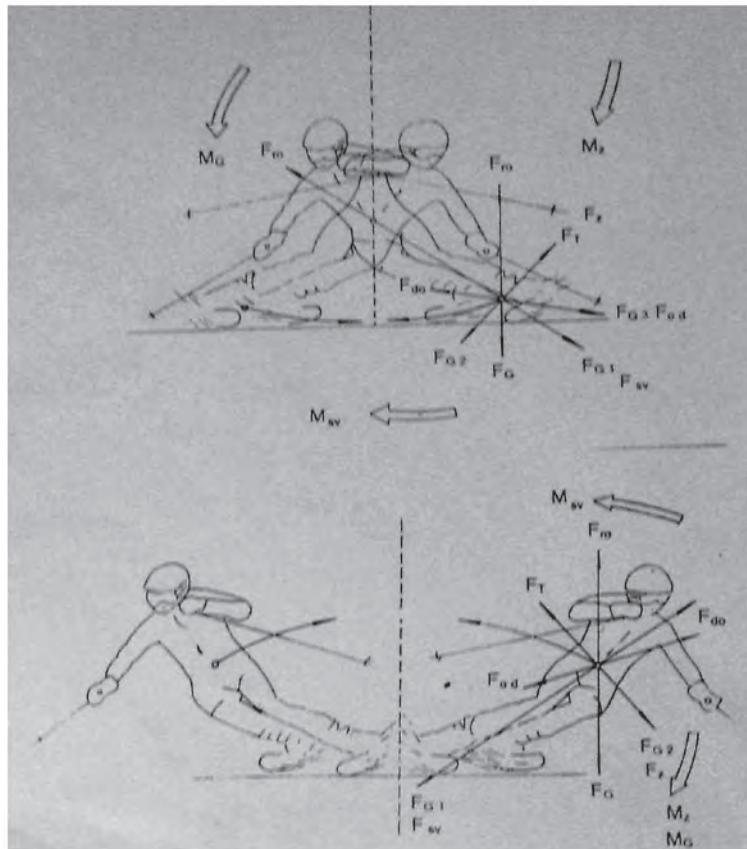

Figure 2: Biomechanical study of the alpine ski rotation during ski turn at the central (down in the picture) and segmental (up in the picture) center of gravity.

This situation is possible in the presence of centripetal forces caused by support of edging skis on snow. It also creates centrifugal force which acts from the segmental centers of gravity to the central point of the skier. Centrifugal force (F_{od}) is compensated by skier with the body shift toward inside the arc (Figure3).

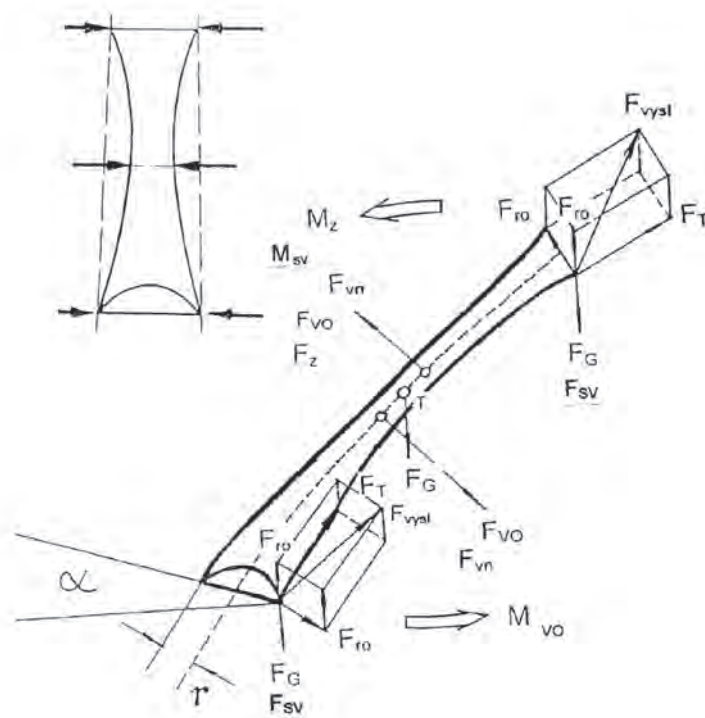

Figure 3: Applying more forces in front and back part of ski by using carving shape

Movement of skier during ski turn

Movement in the arc path is a synergy between muscular (internal) and physical (external) forces. They involve the reaction arranging body segments, as a result of the changes occurring during the ski turn (depends on the quality of snow, configuration of surface, speed and others). The ski turn is so coordinated action of skier which is based on evidence of changes in physical and internal conditions. It is a regulated activity.

The course of the curve with the respect to particular set of elements can be expressed with the help of dynamics of rotational movement:

$$L = I \cdot \omega,$$

where L is angular momentum, I is the momentum of inertia and ω is angular speed.

Regulation of movement in ski turn

Downhill skiing movement on different type of surface requires its regulation. Skier acts a serie of additional movements, which regulate the arc trajectory in coordination with the final structure:

- skier moves the center of gravity forward, backward, sideways in cases of need to increase or decrease the pressure on the front or back part of skies and in case of quantity during edging
- skier twist the trunk, bent it and perform the other additional movements with upper extremities and ski poles
- skier moves the knees forward and in lateral direction or moves the whole system of lower extremities
- skier makes corrections in posture and in cases of big deviations he creates a new tuning process with the aim to achieve excelent standard position

Finishing the movement

Sier returns the body segments into the positions like during the linear movement or acts the other movements which lead from one to other side of ski turn.

Conclusions

Ski turn is a complex psychomotoric activity in motion on the inclined plane. Complexity is based on a complicated set of elements in the synergistic action of internal management and control the movement and action of mechanical forces. Difficulty is determined by the need of a high level of coordination and strength abilities to manage and regulate the complex of synergistic levels of participated systems. Biomechanical studies allows to know the relationships of systems and their contribution is also in motor learning and training processes.

References

1. Baláž, J.: Biomechanika lyžovania. (Biomechanics of alpine skiing). Bratislava, PEEM, 2004.
2. Kalichová, M., Baláž, J., Bedřich, L., Zvonař, M.: Základy biomechaniky tělesných cvičení. (Basics of biomechanics of physical exercises). Brno, MU, 2011.
3. Pšalman, V.: Hodnotenie športovej techniky z aspektu biomechaniky. (Evaluation of sport technique from biomechanical point of view). Bratislava: ICM AGENCY, 2010. ISBN 978-80-89257-22-5.
4. Pšalman, V., Baláž, J.: Dynamics of balance during carving turns. Belgrade: Sport Medicine Association of Serbia, 2005.

DIFFERENCES IN PERFORMANCE OF ISOLATED ARM SWINGS IN ATHLETICS, VOLLEYBALL AND ARTISTIC GYMNASTICS

Ozren Radenović¹, Ljubomir Antekolović² and Ivan Jurak¹

¹University of Applied Health Studies, Zagreb, Croatia

²Faculty of Kinesiology, University of Zagreb, Croatia

Abstract

The objective of this paper is to determine if there is a difference in various variables in three different groups of athletes who conducted arm swing in isolated conditions. Sample consisted of 31 male athletes with experience in athletics (sprint and jumping disciplines), volleyball and artistic gymnastics. Sample of variables for validation of arm swing was ten kinematic, one kinetic and eighteen morphological variables. Statistically significant F-ratio was confirmed in three variables between the three groups of subjects divided by sport discipline: duration of arm swing (**DS**), fist mass (**FM**) and mass of forearm (**MFA**).

Key words: arm swing, ground reaction force, analysis of variance

Introduction

There are numerous researches in which different authors tried to explain how to achieve maximum effectiveness in performing vertical jump and on which external and internal factors depends its successful adoption and performance. Numerous authors tried to explain neuromuscular basis of movement as well as the adjustments that are occurring during the vertical jump performance (Harman and al., 1990). Although the jumps are moves which are requiring complex motor coordination of upper and lower body segments, numerous earlier researches explained the role of arm swing in vertical jump, and the development of explosiveness factors to jumping ability (Feltner and al. 1999; Lees and al. 1996). Vertical jump, as one of basic forms of human movement, is also vastly connected with arm swings, which in this basic motor form have the role of preserving the balance and allow the effective execution of movement (Carr and Gentile, 1994). The way of swing as well as characteristic running start on the skip, on the ground during execution of various different elements in sport gymnastics (Šadura, 1991), swing for preparation of volleyball player for jump in performing spike and reach for the ball in executing the block, (Đurković, 2008), and swings with crouch hands during jumps in some disciplines of athletics are in many ways connected with quality of execution of vertical jumps. To determine differences in execution of arm swing the research included three groups of subjects from different sports: athletics (ATL), volleyball (VOL) and artistic gymnastics (AG).

This paper will compare the differences of athletes in every particular sport (athletics, volleyball and artistic gymnastic) in kinematics, kinetic and four morphological variables.

Methods

Sample of subjects is compiled from 31 young and healthy males with training experience in sports which require quality exercise of arm swing for successful performance of elements or activity as a whole. Subjects are chosen as intentional sample from these sports: 10 subjects - athletics, average age 24.40 (± 5.14), 11 subjects - volleyball, average age 22.81 (± 3.18), and 10 subjects - artistic gymnastics, average age 22.10 (± 4.77). Athletics subjects are active in their field 7.92 (± 4.99) years in average, subjects in volleyball 9.68 (± 4.07), and in artistic gymnastics duration of active practice of sport was 11.92 (± 4.25) years. Average age of all subjects is 23.09 (± 4.36), and the average of active practice with sport activity is 9.83 (± 4.59).

Measurement protocol consisted from four parts: measuring of basic morphological features, performing vertical jump with an arm swing, performing vertical jump without an arm swing, and measuring ground relief with an arm swing in isolated conditions. Morphological measurements were comprised of seven body measures and were conducted in accordance with instructions of the International Biological Program (Mišigoj-Duraković, 2008). Eleven measures in total were conducted in accordance with instructions of the Regression model II (Mejovšek, 1989). Sample of variables for evaluation of kinematic values consisted of ten variables: maximum velocity of arm swing (**VmaxS**), path of arm deceleration in swing measured on the middle of the left wrist joint (**AD**), elbow joint angle (**EJdeg**), duration of arm swing (**DS**), duration of acceleration arm swing (**AtS**), duration of deceleration arm swing (**DtS**), vertical height of the

wrist joint in the moment of maximum velocity of arm swing (**vhmaxV**), vertical jump with an arm swing (**VJwhS**), vertical jump without the arm swing (**VJwtS**), and calculated difference of the vertical jump with and without the arm swing (**hdiffJUMP**). Sample of variables for evaluation of kinetic values is force of arm swing in isolated condition (**FIAS**) and sample of variables for evaluation of morphological values consider four variables which are calculated by Regression model II: mass of arm (**MA**), fist mass (**FM**), mass of upper arm (**MUA**) and mass of forearm (**MFA**).

Vertical jumps with and without the arm swing are measured according to “Bosco” measurement protocol (Bosco, 1997). Measuring equipment used in this research is consisted of anthropometric set (Larussport, Croatia), personal digital scales (“Silver Sense”, Soehnle, Austria), platform for measuring ground force reaction “Quattro Jump”, model 9290AD (Kistler, Switzerland), specifically designed seats and digital camera “EPIC 14MEGAPIXEL MYSTERIUM-X™” (RED, 34 Parker, Irving CA 96218, USA). Analysis of kinematic parameters of video was conducted with SkillsSpector 1.2.4. Software manufacturer Video4coach. Part of two-dimensional 6-segment connected model was used for this measurement (Ashby and al., 2002), and arm model signified as shoulder, wrist and elbow was digitalized on every picture. Analysis of kinetic parameters was performed with data obtained on the platform for ground forces reaction measurement “Quattro Jump”, model 9290AD (Kistler, Switzerland), and data analysis was performed with the help of application software Quatro Jump tip 2822A1-1, version 1.0.9.2.

Platform measurements covered the vertical ground force reaction values while the task, maximal arm swing in isolated condition, was performed.

Results

Basic descriptive parameters of the variables for assessing anthropometric characteristics are show in Table 1.

Table 1: Basic descriptive parametars of the assessing anthropometric characteristics (N=93)

variable	M	SD	min	max
ATHLETICS				
Height subjects (cm)	182.94	±8.21	169.80	200.00
Mass of subjects (kg)	81.24	±8.59	65.50	94.10
Mass of arm (kg)	9.10	±0.72	7.75	10.25
Mass fist (kg)	1.04	±0.90	0.89	1.18
Mass of forearm (kg)	2.33	±0.28	1.77	2.87
Mass of upper arm (kg)	5.72	±0.47	5.08	6.51
Arm length (cm)	74.20	±4.09	67.80	80.00
VOLLEYBALL				
Height subjects (cm)	192.00	±7.55	179.90	205.20
Mass of subjects (kg)	86.57	±9.28	74.20	105.40
Mass of arm (kg)	9.80	±0.81	9.04	11.48
Mass fist (kg)	1.19	±0.14	1.00	1.48
Mass of forearm (kg)	2.55	±0.35	2.14	3.26
Mass of upper arm (kg)	6.05	±0.42	5.56	6.91
Arm length (cm)	81.29	±3.56	75.10	87.40
ARTISTICS GYMNASTICS				
Height subjects (cm)	176.66	±7.26	168.00	189.00
Mass of subjects (kg)	72.99	±7.75	57.10	81.50
Mass of arm (kg)	9.53	±0.61	8.76	10.52
Mass fist (kg)	1.09	±0.91	0.93	1.19
Mass of forearm (kg)	2.32	±0.30	1.71	2.71
Mass of upper arm (kg)	5.59	±1.21	2.47	6.78
Arm length (cm)	75.45	±3.55	69.50	81.00

Purpose of analysis of variance was to check is there statistically significant difference between three chosen athlete groups in all measured variables. When normality of distribution was calculated by performing Kolmogorov-Smirnov test (K-S test), in Table 2., it was found no normality of distribution for the next variables: maximum velocity of arm swing (**VmaxS**), path of arm deceleration in swing (**AD**), difference in vertical jump height with and without the arm

swing (**hdiffJUMP**), mass of the upper arm (**MUA**) and execution of the vertical jump without the arm swing (**VJwts**), so these variables weren't used in the further process of data analysis.

Results of the analysis of variance are shown in the Table 3, and the results are as follow. In most variables there is statistically significant F-ratio, except for the next four variables: angle of the elbow joint during the maximum swing velocity (**EJdeg**), duration of deceleration (**DtS**), vertical height of wrist joint in the moment of the maximum swing velocity (**vhmaxV**), and vertical jump with an arm swing (**VJwhS**), in which no significant differences in the groups of athletes were found.

Table 2: Descriptive parametars of the mesured variables and the results of the K-S test (N=93)

variable	M	SD	min	max	max D
VmaxS (m·s ⁻¹)	11.00	0.93	8.49	12.86	0.55
AD (cm)	71.22	23.11	29.00	129.00	0.66
EJdeg (°)	12.17	17.38	83.80	168.13	0.05
DS (s)	0.32	0.04	0.25	0.42	0.10
AtS (s)	0.20	0.04	0.13	0.30	0.06
DtS (s)	0.12	0.03	0.05	0.20	0.09
hdiffJUMP (cm)	9.68	5.85	-8.30	19.70	0.20
MA (kg)	9.49	0.75	7.75	11.49	0.09
FM (kg)	1.11	0.13	0.89	1.46	0.13
MFA (kg)	2.41	0.32	1.72	3.26	0.10
MUA (kg)	5.80	0.77	2.47	6.91	0.20
vhmaxV (cm)	-18.91	0.23	-66.00	29.0	0.08
VJwhS (cm)	60.98	7.38	41.90	85.10	0.12
VJwts (cm)	51.30	7.56	35.10	81.30	0.18
FIAS (N)	2987.95	1033.91	973.00	5193.27	0.06

Value of K-S TEST $p_{<0.05}=0.139$

Note: Mean (M), Standard Deviation (SD), Minimal Value of Variable (min); Maximum Value of Variable (max), Maximum Deviation of Empirical and Relative Cumulative Function (max D)

Table 3: Analysis of variance results (N=93)

variable	sum of the squares	df	mean	F	p
EJdeg (°)	1025.75	2/90	512.87	1.72	.18
DS (s)	.03	2/90	.01	9.38	.00
AtS (s)	.01	2/90	.01	4.12	.02
DtS (s)	.00	2/90	.00	1.22	.30
FIAS (N)	7779961.10	2/90	3889980.55	3.87	.03
MA (kg)	7.81	2/90	3.91	7.91	.00
FM (kg)	.37	2/90	.18	15.35	.00
MFA (kg)	1.11	2/90	.55	6.02	.00
vhmaxV (cm)	.075	2/90	.04	.74	.47
VJwhS (cm)	133.69	2/90	66.84	1.23	.30

$p<0.05$

Note: Number of Degrees of Freedom (df), F ratio (F), Level of Significance (p)

To determine between which groups of athletes in chosen sports there is statistically significant difference in the arithmetic mean, post-hoc Scheffé test was conducted, which tests statistical significance between the couples of the arithmetic means in individual sports, and the results are shown in the Table 4.

Table 4: Descriptive results of post-hoc Scheffé analysis in individual sports (N=93)

variable	sport	M (SD)	min	max	sport	t	p
DS.	AG	.33 (±0.05)	.26	.41	ATL	.04(*)	.001
					VOL	.00	.801
	ATL	.29 (±0.03)	.25	.35	AG	-.04(*)	.001
					VOL	-.03(*)	.004
	VOL	.33 (±0.04)	.26	.38	AG	-.00	.801
					ATL	.03(*)	.004
AtS	AG	.22 (±0.05)	.14	.30	ATL	.03(*)	.029
					VOL	.00	.841
	ATL	.19 (±0.03)	.13	.25	AG	-.03(*)	.029
					VOL	-.023	.097
	VOL	.21 (±0.04)	.13	.28	AG	-.003	.841
					ATL	.023	.097
FIAS.	AG	2908.71 (±745.39)	1367.88	4411.00	ATL	-478,89	.187
					VOL	212.05	.705
	ATL	3387.60 (±1036.75)	1299.14	5193.27	AG	478,89	.187
					VOL	690.94(*)	.028
	VOL	2696.66 (±1163.00)	973.00	5089.84	AG	-212.05	.705
					ATL	-690.94(*)	.028
MA	AG	9.54 (±0.60)	8.77	10.53	ATL	.43	.063
					VOL	-.27	.325
	ATL	9.10 (±0.70)	7.75	10.26	AG	-.43	.063
					VOL	-.70 (*)	.001
	VOL	9.80 (±0.78)	9.04	11.49	AG	.27	.325
					ATL	.70 (*)	.001
MFA	AG	2.33 (±0.29)	1.72	2.71	ATL	-.01	.998
					VOL	-.23 (*)	.013
	ATL	2.33(±0.27)	1.78	2.87	AG	.01	.998
					VOL	-.23(*)	.016
	VOL	2.56 (±0.34)	2.14	3.26	AG	.23 (*)	.013
					ATL	.23(*)	.016
FM	AG	1.09 (±0.09)	.94	1.20	ATL	.05	.267
					VOL	-.10 (*)	.002
	ATL	1.04 (±0.09)	.89	1.18	AG	-.05	.267
					VOL	-.15(*)	.000
	VOL	1.19 (±0.14)	1.00	1.46	AG	.10 (*)	.002
					ATL	.15(*)	.000

(*) highlighted the significance level (p) up 0,05 **p<0.05**

Note: Artistic Gymnastics (AG), Athletics (ATL), Volleyball (VOL), Mean (M), The Minimum Value of Variable (Min), The Maximum Value of Variable (Max) Value of The T-Test (T), The Level of Significance (P)

Discussion

For duration of arm swing variable (**DS**), statistically significant differences between subjects was found between athletics (ATL) and the other two groups of subjects, artistic gymnastic (AG, post-hoc Scheffé: $t=-0,04$, $p=0,001$), and volleyball (VOL, post-hoc Scheffé: $t=-0,03$, $p=0,004$), while between subjects of artistic gymnastic and volleyball there was no statistically significant difference. According to the results of the analysis of variance it is clear that subjects that were practicing athletics (ATL), in average performed the shortest time of arm swing (0,29 s ±0,03). Also, duration of acceleration of arm swing (**AtS**) shows that there is statistically significant difference between the subjects practicing athletics (ATL), artistic gymnastics (AG), (post-hoc Scheffé: $t=0,03$, $p=0,029$), while differences in results of the other groups were not statistically significant.

Duration of acceleration of arm swing (**AtS**) is just a part of duration of an arm swing as a whole (**DS**). Results (Table 4.) show us that, for the subjects practicing athletics (ATL), acceleration was the shortest (0.19 s, ±0.03). Because of the smallest mean value of arm mass and the smallest mean value of arm length (Table 1.), subjects that were practicing

(ATL) needed shorter arm swing duration time, and shorter acceleration duration time to achieve maximum arm swing velocity ($11.26 \text{ m}\cdot\text{s}^{-1} \pm 0.58$).

Force of arm swing (**FIAS**) is statistically significant in subjects that were practicing athletics (ATL) and subjects that were practicing volleyball (VOL), (post-hoc Scheffé: $t=690,94$, $p=0,028$). Between the subjects practicing artistic gymnastics and volleyball no statistically significant difference was determined. In the group of variables measuring morphological characteristics of subjects, mass of arm (**MA**), fist mass (**FM**) and mass of forearm (**MFA**) were variables in which statistically significant difference was calculated regarding the group of subjects in dependence on the sport they were practicing. From the results shown in the Table 4. it is visible that subjects practicing volleyball (VOL) in variables fist mass (**FM**), and mass of forearm (**MFA**), statistically significant difference is determined regarding the other groups of subjects (AG post-hoc Scheffé: $t=0,10$, $p=0,002$; ATL post-hoc Scheffé: $t=0,15$, $p=0,000$). According to the results, mean value of fist mass (**FM**) in the volleyball subjects (VOL) is the largest and it is $1.19 \text{ kg} (\pm 0.14)$. With the subjects practicing athletics (ATL) the lowest mass of fist was measured and it amounts $1.04 \text{ kg} (\pm 0.09)$. Furthermore, mass of forearm variable (**MFA**), with volleyball subjects (VOL) was also achieving the largest values, and amounts $2.56 \text{ kg} (\pm 0.34)$, where the value of post-hoc Scheffé test towards the group of artistic gymnastics (AG) amounts $t=0,23$, $p=0,013$, and towards the athletics group (ATL), value of post-hoc Scheffé test was $t=0,23$, $p=0,016$.

In morphologic variable of mass of arm (**MA**), statistically significant difference is established between subjects practicing athletics (ATL) and subjects practicing volleyball (VOL), where the value of post-hoc Scheffé test was $t=-0,70$, $p<0,001$. According to results in Table 4. it is visible that the mass of arm (**MA**) of the athletics subjects (ATL) is the lowest ($9.10 \text{ kg} \pm 0.70$), in relation to artistic gymnastic subjects (AG, $9.54 \text{ kg} \pm 0.60$), as to the largest arm mass of the volleyball subjects (VOL, $9.80 \text{ kg} \pm 0.78$).

Conclusion

By comparing the results of the analysis of variance (Table 3.), as well as the results of conducted post-hoc Scheffé test (Table 4.), by which the statistical significance between couples in arithmetic means in individual sports was determined, it is clear that subjects that are practicing athletics (ATL) for the variable duration of arm swing variable (**DS**), are statistically significant differing from subjects that were practicing athletics (ATL) and the other two groups of subjects, artistic gymnastic (AG, post-hoc Scheffé: $t=-0,04$, $p=0,001$), and volleyball (VOL, post-hoc Scheffé: $t=-0,03$, $p=0,004$), while between subjects of artistic gymnastic and volleyball there was no statistically significant difference. Also, subjects practicing volleyball (VOL) in variables fist mass (**FM**), and mass of forearm (**MFA**), statistically significant differed from other groups of subjects (AG post-hoc Scheffé: $t=0,10$, $p=0,002$, (ATL post-hoc Scheffé: $t=0,15$, $p=0,000$). In all other variables significant differences are noted in only one of those two groups. It should be noted that athletics subjects (ATL) had the lowest mean value of arm mass ($9.10 \text{ kg} \pm 0.70$), and also the lowest mean value of arm length ($74.20 \text{ cm} \pm 4.09$) (Table 1.).

Based on the results of the analysis of variance, statistically significant differences were determined in individual variables (Table 3). Analysis confirms that in variable duration of arm swing (**DS**) exists statistically significant difference between groups of subjects (F-ratio $p<0.05$) divided by sport discipline. Also in two variables which measure morphological values (fist mass (**FM**) and mass of forearm (**MFA**) the results show statistical significant difference between all subject groups.

References

1. Ashby, B.M., and Heegaard, J.H., (2002). Role of arm motion in the standing long jump. *Journal of Biomechanics*, 35, 1631-1637.
2. Bosco, C. (1997). Evaluation and planning condition training for alpine skiers. U: Science and skiing, E&FN Spoon London (ur. E. Muller, H. Schwameder, E. Kornexl, C. Raschner), str. 229-250.
3. Carr, J.H., and Gentile, A.M., (1994). The effect of arm movement on the biomechanics of standing up. *Human Movement Science*, 13, 175-93.
4. Đurković, T., (2008). Razlike među skupinama odbojkaša u morfološkim, motoričkim i funkcionalnim obilježjima obzirom na kvalitetu, ekipni status i uloge u igri. Prijedlog projekta doktorske disertacije, Kineziološki fakultet, Zagreb.
5. Feltner, M.E., Frascetti, D.J., and Crisp, J.R., (1999). Upper extremity augmentation of lower extremity kinetics during countermovement vertical jump. *Journal of Sport Sciences*, 17, 449-466.
6. Harman, E.A., Rosenstein, M.T., Frykman, P.N., and Rosenstein, R.M., (1990). The effects of arms and countermovement on vertical jumping. *Medicine and Science in Sport and Exercise*, 22, 825-833.
7. Lees, A., Vanrenterghem, J., and De Clercq, D., (2004). Understanding how an arm swing enhances performance in the vertical jump. *Journal of Biomechanics*, 37, 1929-1940.
8. Mejovšek, M., (1989). Konstrukcija i evaluacija biomehaničkog n-segmentalnog modela za analizu gibanja muskuloskeletnog sistema ljudskog tijela. (Doktorska disertacija, Sveučilište u Zagrebu). Zagreb: Fakultet za fizičku kulturu Sveučilišta u Zagrebu.
9. Mišigoj-Duraković, M., (2008). Kinantropologija - biološki aspekti vježbanja. Kineziološki fakultet, Zagreb.
10. Šadura, T., (1991). Gimnastika. Fakultet za fizičku kulturu Sveučilišta u Zagrebu, Zagreb.

VARIABILITY OF CENTRE OF PRESSURE MOVEMENT IN STATIC AND DYNAMIC CONDITIONS IN MIDDLE-AGE WOMEN

Zdenek Svoboda¹, Lucia Bizovska¹, Zuzana Kovacikova¹, Patrik Kutilek² and Ales Gaba¹

¹Faculty of Physical Culture, Palacky University, Olomouc, Czech Republic

²Faculty of Biomedical Engineering, Czech Technical University in Prague, Kladno, Czech Republic

Abstract

The aim of this study was to assess the correlations between the centre of pressure (COP) movement variability during bipedal stand and one-leg stand, and during the various gait cycle phases. Twenty two healthy women of age 55.8 ± 4.4 years participated in this study. The subjects performed two trials of bipedal stand, one trial of one leg stand for each limb and five walking trials. The COP movement was recorded using two force plates (Kistler Instrumente, Winterthur, Switzerland) at sampling rate of 200 Hz. The relationships between the variables in different conditions were assessed by the Pearson's correlation coefficient. Results showed positive significant relationships between gait variables and bipedal and one leg stand variables only for the terminal stance. No significant correlation was found between bipedal and one leg stands. These results suggest that COP excursion in bipedal stand, one leg stand and gait reflect different properties of human stability.

Key words: postural stability, ground reaction force, gait, stand

Introduction

Time behaviour measurements of the centre of pressure of a person positioned on a force plate is one of the most commonly used tool to investigate complex balance system. Postural sway observed in quiet standing represents an integrated output of the complex interactions between the balance systems (Ruhe et al., 2011). However, balance evaluation during static conditions has some limitations. For healthy subjects, this measurement is insufficiently sensitive. Quiet standing requires very little muscular activity, making it a poor evidence of postural instability concurrent with aging (Panzer et al., 1995). Making the stance task more difficult by removing visual and feet proprioceptive feedbacks during quiet standing has been claimed as a mean to identify a deficit in stability, (Fujimoto et al., 2012). The difference between static conditions in stability tests and dynamic conditions in fall can result in the fact that the differences in the COP excursions during standing when compared between subjects with and without a history of falls in static balance assessment are insignificant for most of the traditional COP variables (Muir et al., 2013). These authors found significant differences only for maximal COP displacement. Other authors (Melzer et al., 2010) found significant differences for average COP range in the medial-lateral direction and the mean sway area, and non-significant differences for average COP range in the anterior-posterior direction and the mean velocity.

Talbot et al. (2005) presented walking as the most frequently cited cause of fall. Weirich et al. (2010) suggest that measurements of strength, flexibility, physical activity, body composition, and bone health, which are often considered as balance predictors, correlate more significantly when balance is assessed dynamically rather than statically. The application of procedures often used for static balance evaluation to-gait can reveal interesting information describing stability (variability) during gait.

COP excursions for stability assessment during gait in subjects with knee osteoarthritis were used by Esrafilian et al. (2013). They evaluated the maximal excursion and the mean velocity of COP in the medial-lateral direction, and the margin of stability (the excursion of the distance between the location of COP and lateral malleolus with respect to the laboratory coordination system). Significant difference between patients and control group was found only for the margin of stability. Maximal excursion of COP in medial-lateral direction during gait as the potential predictor of fall risk was assessed also in pregnant women (McCrory et al., 2011). The results did not show any significant difference in COP movement between trimesters or between pregnant fallers and non-fallers.

In our study we wanted to know if the traditional static measurement of stability in bipedal stance reaches similar conclusions as the dynamic measurement of stability in gait; however, during gait different movement behaviour at various gait cycle phases would be taken into consideration in view of the fact that some gait cycle phases would be associated more with stabilization and some more with progress tasks.

The aim of this study was to assess the correlations between the COP movement variability during bipedal stand, one leg stand and the various phases of the gait cycle.

Methods

Observed group

A group of middle-age healthy women participated in this study ($n = 22$, age 55.8 ± 4.4 years, height 161.9 ± 5.1 cm, weight 68.5 ± 13.6 kg, BMI 26.1 ± 5.0 kg.m⁻²). The participants were chosen as individuals with various sedentary jobs who were in moderate physical condition.

Experimental setup and methods

The subjects performed in random order two trials of bipedal standing, one trial for each limb for one leg stand and 5 trials of barefoot walking along an eight meters walkway at self-selected speed. The mean walking speed was 1.22 ± 0.11 m.s⁻¹.

The ground reaction force (GRF) and COP movement were recorded using two force plates (Kistler Instrumente, Winterthur, Switzerland) at sampling rate of 200 Hz.

The study was approved by the Institutional research ethics committee, and the participants provided written informed consent.

Data analysis

The duration of all stand trials was 30 s. Data was filtered using the fourth order lowpass Butterworth filter with a cut-off frequency of 7 Hz in the Matlab software (MATLAB R2010b, Mathworks, Inc., Natick, MA, USA). Standard deviations of COP movement in the medial-lateral (ML) and anterior-posterior (AP) directions were computed for each trial. The values of two trials (bipedal stand) or two limbs (one leg stand) were averaged and considered as stability indicators during bipedal and one-leg stands.

During gait, the lower limit of the vertical ground reaction force (vGRF) was determined as 5% of the subject's body weight. The data was filtered using the Matlab software (MATLAB R2010b, Mathworks, Inc., Natick, MA, USA). The third order lowpass Butterworth filter with a cut-off frequency of 6 Hz was used. According to the behaviour of vGRF, each stand phase was divided into four subphases: loading response (LR), midstance (MSt), terminal stance (TSt) and preswing (PW). The vGRF during the stance phase was described in detail by Ayyappa (1997). The subphases were identified as follows: LR – time interval between heel strike and the first vGRF peak, MSt – time interval from the first vGRF peak to the minimum vGRF in the middle of the stance phase, TSt – time interval between the minimum vGRF in the middle of the stance phase and the second vGRF peak, PW – time interval between the second vGRF peak and the toe-off. The displacement of COP movement in the medial-lateral and anterior-posterior directions was computed for each subphase. The standard deviations of the variables in each subphase were computed separately for both limbs and then averaged across limbs and five trials. This value was considered as the stability indicator during gait.

Statistical analysis was performed using Statistica version 12.0 (StatSoft, Inc., Tulsa, OK, USA). The Kolmogorov-Smirnov test was used to verify normality. The relationships between the variables were assessed by the Pearson's correlation coefficient. The level of significance was set at 0.05.

Results

The basic statistical characteristics of the observed variables are presented in Table 1. Kolmogorov-Smirnov test confirmed normal distribution for all the variables.

Correlations between gait and stand variables

The values of correlation coefficients are presented in Figure 1. Positive significant relationships between bipedal and one leg stand were found only for the terminal stance. Correlations higher than 0.3 (however, non-significant) were found also for loading response (bipedal stand) and the midstance (one leg stand) gait phases. Negative significant correlation was found between the values in the medial-lateral direction during midstance and one leg stand.

Correlation between bipedal and one leg stand variables

Between bipedal and one leg stand, no significant correlation was observed. The correlation was higher than 0.3 only for sways in the anterior-posterior direction.

Table 1: Mean and standard deviation of the observed variables [mm]

Conditions (phase)	Direction	Mean	SD
Bipedal stand	ML	2.41	1.12
	AP	4.75	1.27
One leg stand	ML	9.51	4.99
	AP	7.56	1.30
Loading Response	ML	1.66	0.29
	AP	1.86	0.79
Midstance	ML	0.15	0.07
	AP	0.57	0.18
Terminal Stance	ML	0.11	0.03
	AP	0.60	0.24
Preswing	ML	1.35	0.34
	AP	2.73	1.14

Legend: SD – standard deviation, ML – medial-lateral direction, AP – anterior-posterior direction

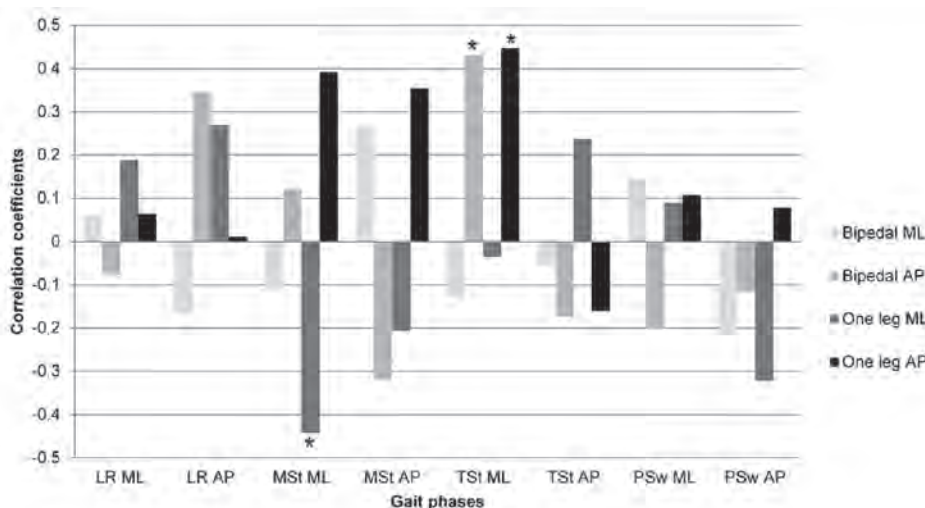

Figure 1: Correlation coefficients between gait and stand variables (ML – medial-lateral direction, AP – anterior-posterior direction, LR – loading response, MSt – midstance, TSt – terminal stance, PSw – preswing, * – significant correlation)

Discussion

The absence of a consistent pattern of correlations between the stand and gait variables across all gait cycle phases or directions suggest that the observed variables during gait and stand reflect different properties of human stability (variability). The lack of correlation between COP excursions analyzed in static (one-leg stand task evaluated by standard deviation of the COP components) and dynamic (one-leg landing task evaluated by Dynamic Postural Stability Index) measurements was confirmed by Sell (2012).

Some authors suggest that for assessing dynamic gait stability, it is desirable to consider different procedures than the traditional calculation of standard deviations. Hurmuzlu and Basdogan (1994) used the analytical method for assessing the dynamic stability of human locomotion based on the Floquet theory, which was developed to investigate the stability of nonlinear oscillators. To characterize the ability of humans to maintain steady gait patterns, they developed a quantitative stability index. Dingwell et al. (2001) presented that the traditional measurements of variability poorly predict local stability. To determine the local dynamic stability of the kinematic data, they used maximum finite-time Lyapunov exponents that reflect different properties of the dynamics of walking (Bruijn et al., 2009).

Besides the positive, we also found some negative correlations. It shows that in some gait phases, higher COP movement variability is better considered as higher level of functional abilities than low level of stability. A similar result was presented by Heitmann et al. (1989). They found small but statistically significant negative relationships between balance performance during stand (sharpened Romberg test, one-leg stand) and the variability of step width.

As regards the gait cycle phase, larger correlation to stand tests of COP movement variability was found for the midstance and the terminal stance. This finding can be explained by similar position of the foot completely on the ground

as during the stand. For loading response and preswing, the correlations are lower; however, the mean values of COP movement variability is considerably larger in comparison to other gait cycle phases. It suggests that loading response and preswing could play a key role in stability during gait.

The limitations of this study includes mainly the number of trials for standing tests (two trials in bipedal standing and one trial for each limb in one-leg standing) and the duration of the standing trials (30 s), which are relatively low for obtaining good reliability (Ruhe et al., 2010); however, we took into account the possible fatigue factor of the subjects that can influence the balance tests results (Nardone et al., 1997).

References

1. Ayyappa, E. (1997). Normal human locomotion, part 2: motion, ground reaction force and muscle activity. *J Prosthet Orthot*, 9, 42–57.
2. Bruijn, S.M., van Dieën, J.H., Meijer, O.G., & Beek P.J. (2009). Is slow walking more stable? *J Biomech*, 42(10), 1506–1512.
3. Dingwell, J.B., Cusumano, J.P., Cavanagh, P.R., & Sternad, D. (2001). Local dynamic stability versus kinematic variability of continuous overground and treadmill walking. *J Biomech Eng*, 123(1), 27–32.
4. Esrafilian, A., Karimi, M.T., Amiri, P., & Fatoye, F. (2013). Performance of subjects with knee osteoarthritis during walking: differential parameters. *Rheumatol Int*, 33(7), 1753–1761.
5. Fujimoto, C., Murofushi, T., Sugasawa, K., Chihara, Y., Ushio, M., Yamasoba, T., & Iwasaki, S. (2012). Assessment of postural stability using foam posturography at the chronic stage after acute unilateral peripheral vestibular dysfunction. *Otol Neurotol*, 33(3), 432–436.
6. Heitmann, D.K., Gossman, M.R., Shaddeau, S.A., & Jackson, J.R. (1989). Balance performance and step width in noninstitutionalized, elderly, female fallers and nonfallers. *Phys Ther*, 69(11), 923–931.
7. Hurmuzlu, Y., & Basdogan, C. (1994). On the measurement of dynamic stability of human locomotion. *J Biomech Eng*, 116(1), 30–36.
8. McCrory, J.L., Chambers, A.J., Daftary, A., & Redfern, M.S. (2011). Ground reaction forces during gait in pregnant fallers and non-fallers. *Gait Posture*, 34(4), 524–528.
9. Melzer, I., Kurz, I., & Oddsson, L.I. (2010). A retrospective analysis of balance control parameters in elderly fallers and non-fallers. *Clin Biomech*, 25(10), 984–988.
10. Muir, J.W., Kiel, D.P., Hannan, M., Magaziner, J., & Rubin, C.T. (2013). Dynamic parameters of balance which correlate to elderly persons with a history of falls. *Plos one*, 8(8), e70566.
11. Nardone, A., Tarantola, J., Giordano, A., & Schieppati, M. (1997). Fatigue effects on body balance. *Electroencephalogr Clin Neurophysiol*, 105(4), 309–320.
12. Panzer, V.P., Bandinelli, S., & Hallet, M. (1995). Biomechanical assessment of quiet changes associated with aging. *Arch Phys Med Rehabil*, 76(2), 151–157.
13. Ruhe, A., Fejer, R., & Walker, B. (2010). The test–retest reliability of centre of pressure measures in bipedal static task conditions – A systematic review of the literature. *Gait Posture*, 32, 436–445.
14. Sell, T.C. (2012). An examination, correlation, and comparison of static and dynamic measures of postural stability in healthy, physically active adults. *Phys Ther Sport*, 13(2), 80–86.
15. Talbot, L.A., Musiol, R.J., Witham, E.K., & Metter, E.J. (2005). Falls in young, middle-aged and older community dwelling adults: perceived cause, environmental factors and injury. *BMC Public Health*, 5, 86.
16. Weirich, G., Bembien, D.A., & Bembien, M.G. (2010). Predictors of balance in young, middle-aged, and late middle-aged women. *J Geriatr Phys Ther*, 33(3), 110–117.

Acknowledgment

The study was supported by a research grant from the Czech Science Foundation (grant no. 13-32105S) “Analysis of health-related benefits of walking: assessment of walking intervention in sedentary adults”.

THE ROLE OF DYNAMIC SYSTEMS IN MOTOR DEVELOPMENT RESEARCH: JUST A METAPHOR OR A NOTABLE REALITY?

Ivan Šerbetar

Faculty of Teacher Education, Zagreb, Croatia

Abstract

In present article an application of the new theory of motor control in context of motor development theories and research have been discussed. In brief overview of traditional theories of motor development neuro-maturational theory is mentioned along with the two prominent proponents – McGraw and Gesell. Bernsteins' fundamental insights in motor control was emphasized, such as concepts of degrees of freedom and synergies, along with his contribution to the measurement technology and quantification. Basic principles of dynamic systems theory and common concepts such as self-organization, patterns, attractors or non-equilibrium systems are briefly described.

In a main part, example of research in motor development, carried out in dynamical perspective was introduced. The chosen example was the body of research done by Thelen et al. (1982, 1984, 1990) on newborn stepping. Distinction between maturational perspective, in which all the sequences of motor development are the result of maturation of nervous system, and dynamic perspective in which development is seen as a mutual interaction between a number of body systems, including neural and muscular systems, which continuously affect the movement although none of them dominate (Kamm et al., 1990) has been made.

Key words: motor development, self-organization, patterns, motor control

Traditional view of motor development

Clark and Whittall (1989) in their historical overview of the field of motor development mention that the earliest studies in motor development had begun in the 18th century but according to the most textbooks of motor development (e.g. Gabbard, 2000; Payne & Isaacs, 2001; Haywood & Getchell, 2001) the first relevant theories have come from a body of research done by Arnold Gesell and Myrtle McGraw in 1930s and 1940s.

Gesell (as cited in Gabbard, 2000) based his theory on a belief that development is the result of inherited factors and that no requirements or stimulation from the environment are needed. In his view, ordered genetic sequences exist, and they determine the growth of tissue and body structures but also behavior, which means that movements are the product of changes in neural formations. Similarly, McGraw (1943, as cited in Haywood & Getchell, 2001) related changes in the motor behavior to the development of nervous system. For example, McGraw associated an infant's ability to lift the head to the newly established control of the cervical region (Kamm et al., 1990).

The heritage left by the maturationists, which is still in use, are the developmental norms or milestones which a child has to attain in his or her motor development.

After the neural maturational perspective, some other theories have appeared on the scientific scene, among the latest were information processing and ecological perspectives. A common aim, in many motor development studies, disregarding theoretical perspective was the understanding of the relationships between the neural structure and behavior, which here means the acquisition of motor skill. It is the skill that can be considered "central dogma for kinesiology" as well, since the famous lecture by McCloy (1940) up to the present time (Zelaznik and Harper, 2007; Clark, 1995).

Developmental biodynamics

Development of the motor skill (e.g. changes in motor behavior) was also central to the new developmental paradigm that arrived on the scene, the theory in which the development is seen as a mutual interaction between a number of body systems, including neural and muscular systems, which continuously affect the movement although none of them dominate (Kamm et al., 1990). The new perspective, called by some theorists "developmental biodynamics", was grounded on the dynamic systems theory which had already influenced many disciplines and had made impact on the research concepts in chemistry, biology, but also in social sciences.

Although system thinking in the developmental sciences, or broader – in biology, has a long tradition (Waddington, 1957), real conceptualization and research was possible when legacy of the Nicolai Aleksandrovich Bernstein was introduced to western science in late 1960s.

Bernstein was a Soviet physiologist who studied human movement and wondered – how human movement system which is composed of such a large number of components (in Bernstein words – 10^2 joints, 10^3 muscles and 10^{14} neurons) could control multiple degree's of freedom in producing skilled action (Bernstein, 1967). Bernstein proposed that the motor system is organized by formation of synergies, e.g. units defined over the motor apparatus that automatically adjusts to each other and to the changing field of external forces (Gelfand et al., 1971) or, explained more directly related to the movement synergy refers to the “muscle linkage or coordinative structure, defined as a group of muscles often spanning several joints that is constrained to act as a single functional unit” (Tuller et al., 1982, p.253). Bernstein rejected the idea of one-to-one relations between neural codes and produced movement patterns and he assumed that movements can come out of different muscle contraction patterns and in the same way that certain muscle contraction pattern does not have to produce identical movements every time. He believed that while body moves, different forces arise (e.g. centripetal and inertial) and gravity should also be taken into account. Thus, while movement happens, the field of forces continually changes and the same muscle contractions may have different outcomes. Besides developing the theory, Bernstein also enhanced research in motor control and therefore motor development research as well by introducing new methods of movement quantification. Along with the new theoretical concept he has put forward kinematic analysis which allowed spatial and temporal description of movement (a broader technical historical description of Bernstein's contribution to the measurement technology can be found in Medved, 2002). Together with the electromyography, kinematic data provided much better insight in movement organization than the traditional, solely neural explanation.

Principles of dynamic systems approach

Human surroundings, animate and inanimate world is full of patterns which evolve over time but how the order is achieved from such a complexity or, in other words, how the patterns are formed is not entirely understood. Dynamic systems perspective offers a view in which human behavior is governed by generic processes of self-organization, which is the spontaneous formation of patterns and their change in the open, non-equilibrium systems (Kelso, 1995). That refers to the systems which are far from (thermal) equilibrium and exchanging energy, matter or information with their environment, and which cannot sustain without those sources. Self-organization can be found in numerous physical, chemical or biological systems but also in the inanimate world. A very suitable example for this particular article is the human brain which is in the context of self-organization as explained by Haken “the most complex system we know in the world. It is composed of up to 100 billions neurons (and Glia cells) which are strongly interconnected. For instance, a single neuron can have more than 10,000 connections to other neurons. The central question is: who or what steers the numerous neurons so that they can produce macroscopic phenomena such as the coherent steering of muscles in locomotion, grasping, vision i.e. in particular pattern recognition, decision making etc” (2008, p. 2555). A description of the collective or coordinated behavior of complex systems, among them living things, requires rather abstract variables and physical-mathematical notions such as collective variables (sometimes called order parameters), attractor, stability, phase space and so on. Avoiding technical jargon and equations of motion which are in the the heart of dynamical systems theory, a brief description related to motor behavior will be given.

Collective variables define coupling or coordinated behavior of a complex system. In case of walking, for example, someone could describe the system on the level of many individual components such as muscles, tendons, neural pathways, metabolic processes. On that level of observation, system can behave in extremely complex fashion but if the cooperative behavior among the parts exists - system can be described by alternating cycles of swings and stance of the feet (Thelen & Smith, 2006). Also, other collective variables like muscle firing or torque forces etc, are possible. Attractor states are a further important property of self-organization.

Attractor may be explained simply as a preferred state or a point in the phase space of the system. Open systems could exhibit almost an infinite number of patterns of behavior, but they usually tend to only few of them or even to just one and when they settle in that pattern (mode of behavior) they tend to stay in it. If they are perturbed, they tend to return back to that attractor. Again, walking could serve as a simple example. In the coupled alternative movement of walking, legs are in a so-called anti-phase or 180 degree out of phase relation. Other relations are also possible in a state space but people prefer the anti-phase relationship which is in that case an attractor of 180 degrees out of phase (Thelen & Smith, 2006).

Stability is one of the core concepts of motor control, i.e. technically related it is a system facility in accommodating perturbations (Newell & Corcos, 1993). However, when several attractors exist with different basins of attraction, what appears is multistability, which is a coexistence of several collective states for the same value of control parameter and an essential characteristic of biodynamics. When the control parameter changes smoothly, attractor also changes and at one critical point the attractor may change even qualitatively (Kelso, 1995). In physics this phenomenon is called non-equilibrium phase transition. Another important idea for the movement organization, is that movement is softly assembled, expressed for a first time by Kugler and Turvey (1987), is also grounded on Bernstein's premise that motor actions have to be programmed on a very high abstract level, otherwise the control of many parts acting on local level along with their interactions and continually changing forces may prove to be overwhelming for CNS. Softly-assembled indicates that parts which are included in motor action should be organized in regard to their properties, interactions and context

(Turvey, 1990). In other words, neuroanatomical components are selected naturally in a way that their organization is adaptive, flexible, task specific and that (soft) assembly may quickly reorganize themselves according to the changes in task demands.

Dynamic systems theory in developmental research

One of the most prominent examples of the use of dynamic systems paradigm in motor development is the work of Ester Thelen on newborn stepping (Thelen & Fisher, 1982; Thelen et al., 1984, Kamm et al., 1990). The behavior emerges when an infant is held upright and slightly leaning forward with the feet touching the ground. In this position an infant performs alternating leg movements in a manner similar to walking. In view of neural-maturation and reflex-based theories, that behavior was considered a primitive reflex which disappears after 4-6 weeks as a consequence of brain maturation.

Thelen and colleagues' (1982, 1984) compared the stepping and kicking of infants using kinematics and EMG, and what they found was a remarkable similarity in the number of measures between these two patterns. EEG records showed phasic activation of tibialis anterior and rectus femoris in flexion while extension was passive. Temporal organization of movement was also very similar and the authors concluded that stepping and kicking in infants is isomorphic. Significantly, they also found some differences, a range of motions for kicking was greater than for stepping and during supine kicking, hip extension was longer with smaller extensions. The differences were explained by the changes in biomechanics of the movement with the changes in posture related to gravity. Lying supine, infants' hip flexion is assisted by gravity when the thigh passes the 90 degree angle, and when it is held upright, gravity assists the extension during the entire movement. Authors concluded that external forces were modeling and shaping spontaneous leg movement. They also assumed that the weight gain caused a decrease in number of steps produced by infants thus suggesting that the gain of strength is slower than the gain of weight which inhibited walking. Additionally, Thelen et al. (as cited in Kamm, 1990) manipulated weight in two ways first by adding the small weights to the infants' legs – which suppressed stepping and second, by submerging the legs in warm water until their feet touched the bottom, which increased stepping dramatically. The hypothesis was that the “disappearing” reflex could arise not by design present in the brain but by the interdependence of heavy legs and biomechanically demanding posture (Thelen, 1995), manipulations with mass “restored” or “inhibited” reflex.

In above example body weight and composition were in the role of the control parameter which can cause disappearance of newborn stepping response. Growth of the tissue affected the system and caused qualitative shift in behavior. The way behavior changed suggests effect of *non-linearity* – even small change in control parameter at critical value may cause qualitative shift (Thelen, 1995).

In the study of the infants' kicking movements, Thelen et al. (1984) emphasized that none of the contributing factor to the behavior (e.g. arousal of the infant, gravity, neuromuscular system) has advantage over the systems in determining the description of the kick. Gravity contributed to the topology, torques varied with gravity and vigor, and adapts to each change, while the whole system varied with arousal. The coordination and timing in the kicking movements were the emergent properties, which were not specified by the neural signals alone. There was no program for the kick in any of the subsystems, the behavior emerged as product of interaction of the components concerned to the action. Thus, while the behavior was not specified than emergent, the system was *self-organized*. Organisms in development are complex because they are constituted of very many components, these components are in continuous interaction among themselves and with the environment which produces changes in components and in the system in whole. That effect is called the *multicausality*. Coherence among patterns of emerged behavior is achieved by interaction between organismic components and constraints which has been set by environment and without causal priority (Thelen & Smith, 2006). One of the most important features of complex systems i.e. patterns of behavior is their index of stability. Crawling, for example, is behavioral pattern which is very stable in his temporal and kinematic characteristics. Infants use that behavior for locomotion when certain level of strength and coherence of hands-to-knee posture is developed but the strength and balance still not allow upright locomotion (Thelen & Smith, 2006). Crawling remains stable for several months and then gives way to standing or upright walking which is next stable behavior, in that transition variability increases and system becomes unstable (Clark, 1995).

The crawling was also not prespecified by genes or wired in nervous system (Thelen & Smith, 2006) but self-organized in task-context of moving through the space, and later replaced by a efficient locomotor pattern. “Development can be envisioned as a series of evolving and dissolving patterns of varying dynamic stability, rather than an inevitable march toward maturity” (Thelen & Smith, 2006).

Conclusion

Pioneer developmentalists were interested in infant' development of control over movements; however, they assumed that motor milestones and the emergence of motor skills reflects only brain maturation and genetically driven overall development. Dynamic systems theory in motor control aims to explain the behavior of complex systems in

the physical or biological sphere, and it could be comprehended as a conceptual guide, research program or a formal theory. In dynamic systems perspective central nervous system is not exclusively responsible for movements, they are rather product of biomechanical and energetic properties of the body, environment and specific demands of the task. Relations between components are not hierarchical – top down, but rather non-linear, self-organizing and flexible. Research in dynamic perspective has undoubtedly managed to reveal the richness and complexity of development as a multiple, mutual, and continuous interaction of all the levels of the developmental system (Thelen & Smith, 2006). In the words of Ilya Prigogine (2012), a Nobel chemist (awarded in 1977 for his work in non-equilibrium thermodynamics which included self-organization) “...instead of emphasizing stability and permanence, science should emphasize change and adaptation...non-equilibrium can produce coherence, structures and very complex patterns which permit us to see, to understand much better a type of structures that we see in the world around us”.

References

1. Clark, J. (1995). On becoming skillful: Patterns and constraints. *Research Quarterly for Exercise and Sport*, 66(3), 173–183.
2. Haken, H. (2008). Self-organization of brain function. *Scholarpedia*, 3(4):2555.
3. Kamm, K., Thelen, E., & Jensen, J. (1990). A dynamical systems approach to motor development. *Physical Therapy*, 70, 763–775.
4. Kelso, J.A.S. (1995). *Dynamic Patterns: The self organization of brain and behavior*. Cambridge MA: MIT Press.
5. Thelen, E. & Smith, L.B. (2006). Dynamic Systems Theories. In: Damon, W., Lerner, R.M. (Eds.) *Handbook of Child Psychology, Vol.1, Theoretical Models of Human Development, 6th Edition*, pp 258-312.

DEPENDANCE OF THE SHOT PUT PERFORMANCE ON THE SELECTED KINEMATIC PARAMETERS OF THE TECHNIQUE

Martin Vaváček and Marek Hardoň

Faculty of sport studies, Masaryk University, Brno, Czech Republic

Abstract

The paper aims to define, by means of correlation analysis, the dependency between the achieved performance and selected kinematic parameters of the technique of top shot putters at the level of 17 - 23 meters, and also after dividing them with discriminant analysis to weaker (17 - 20 m) and better (20 - 23 m) performances. On the basis of biomechanical analyses of the performances in shot put, and with the help of correlation analysis, we determined the dependence of selected parameters on performance, which essentially determine the length of the shot put. Hypothesis No. 1 has been confirmed as the relationship between the power and velocity of the shot at the moment of release in the whole group of putters was at 1% level of statistical significance ($r = 0.68$). Correlation between the performance and take-off angle was not statistically significant. The dependence of the performance on speed components of the shot in the moment of release in our study was statistically significant at 5% level only in the horizontal component ($r = 0.55$). The dependence of release height in the whole group went to 1% level of significance ($r = 0.64$), thus confirming this parameter to be one of the limiting factors of shot put technique. In the group of 20 - 23 m, the dependence of the angle of take-off was insignificant, with a correlation coefficient $r = -0.07$, confirming the hypothesis No 2 that assumed the group with better performances will have larger dependence on the release velocity than on the parameter of the angle of take-off. Further research is needed because this work deals only with selected performance parameters and these results do not provide sufficient basis for complex recommendations for comprehensive training.

Key words: shot put, dependence, kinematic parameters, correlation analysis

Introduction

The quest for maximum performance, one of the most important attributes of sport, is evident especially where it is possible to measure the performance objectively. Without a doubt we can consider shot put to be one of those, as there exists a prediction equation (Leško, 2000) and it is directly determined by measured results.

$$l = \frac{v_0^2 \cos \alpha}{g} \left(\sin \alpha + \sqrt{\sin^2 \alpha + \frac{2hg}{v_0^2}} \right)$$

l - shot put length
v₀ - release velocity
α - release angle

g - gravitational acceleration
h - release height

Shot put is one of the technically most demanding athletic disciplines. A number of factors determine the performance and from the biomechanical point of view, we are dealing with a complex of forces different to all the other athletic disciplines.

To achieve high performance is a priority in every sport, while it is important to focus on the individual factors limiting the performance. It is important to know and pay attention to the conditions helping to reach maximum sports performance. In general, these conditions are well known. Above all, they include the dispositions of a particular athlete for a given sports activity and mastery of an optimum technique. Top performance requires solution of the problem of optimization of the technique, especially in disciplines where the biomechanical parameters of the movement pattern determine achieving top performances. This biomechanical approach is based on application of the mechanical principles while taking into account the biological characteristics of an athlete's body and his or her individual predispositions.

In an attempt to improve the training process and the technique of an athlete, means using modern technical equipment and procedures are used increasingly. The experienced eye of a coach is often no longer adequate to define the deficiencies in an athlete's technique, and in many cases, kinogram analysis is the only means to capture and analyze the movement pattern.

What creates the basis of this study is the examination, comparison and especially finding the relationships and dependencies between individual measured values of selected kinematic parameters of the technique of top shot putters from available literature and bibliographical sources.

Objective, hypotheses and tasks

Objective

The aim is to find and define, by means of correlation analysis, the dependency between the achieved performance and selected kinematic parameters of the technique of top performances in the shot put at the level of 17 - 23 meters.

A partial objective is to find and compare the relationships of individual parameters at different performance levels.

Hypotheses

H1: We assume that the dependence of selected kinematic parameters will be different depending on the performance level.

H2: We assume that in the better performance group the dependency of performance on the overall shot release velocity will be greater compared to the parameter of the shot release angle.

Aims

1. To make a research on selected kinematic parameters of the technique of top shot putters from the available top competitions.
2. To determine the relationship between the performance and selected kinematic parameters of the technique of top competitors.
3. To display graphically the dependences of the performance on selected kinematic parameters of the technique globally, as well as according to the various performance levels.

Methods

This is an ex post facto research design. The group of subjects consisted of 43 top performances in the shot put using rotational technique in male category. The performances were subjected to 2D or 3D biomechanical analysis. On the basis of these analyses, we collected selected kinematic parameters of the technique, then we organized the acquired empirical data into tables and we used mathematical and statistical methods to evaluate the data, with the help of a computer program EXCEL. Some of the analyzed performances do not contain all the parameters. The selected parameters and their distribution are displayed in Tab. 1.

The dependency between variables were determined by means of pair correlation analysis with calculation of pair correlation coefficient r according to Pearson (Wallace, Snedecor, 1931), while the dependency was observed globally - i.e. in the whole group and separately, in the group of weaker performances with 17 - 20 m and in the group of better performances with 20 - 23 m. These groups were created on the basis of discriminant analysis.

The statistical significance was assessed on the level of 1% (**) and 5% (*). The results of the research were subjected to logical analysis and synthesis with the use of deductive and inductive reasoning.

Table 1: Selected kinematic parameters and their number depending on the performance

Parameter	the overall number	the number of 17 - 20 m	the number of 20 - 23 m
performance	43	18	25
release height	28	12	16
release angle	43	18	25
overall velocity	28	12	16
horizontal velocity	14	8	6
vertical velocity	14	8	6
Phase 6	13	7	6
1 st step	16	10	6
2 nd step	16	10	6

Results and discussion

From the physical point of view, shot put is an angled throw and it is given by its length, which is conditioned by the following factors: release velocity, optimum release angle and release height.

The initial velocity of the shot, which substantially determines the length of the put, depends on the trajectory on which the shot putter acts on the shot from the moment of taking the release position. Even though the dependence between performance and release velocity was confirmed at 1% level of statistical significance in all the puts (Fig. 1), the statistical significance of the same factor was only at 5% level in the group of 20 - 23 m. (Fig. 2). In the group of performances between 17 and 20 meters, the dependence of the performance on the overall initial velocity of the shot was not confirmed as significant (Fig. 3).

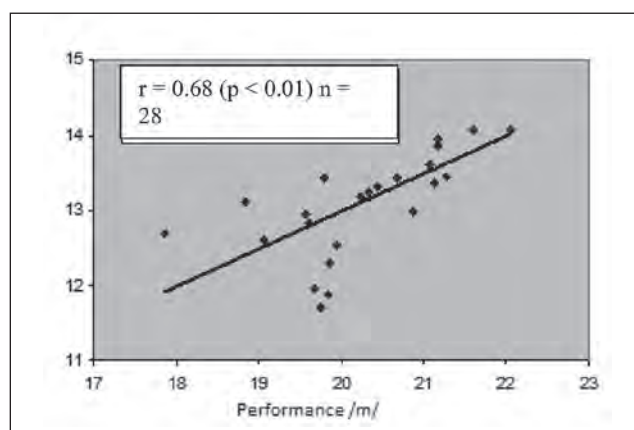

Figure 1: The dependence of the performance on the overall release velocity in the group of 17 - 23 m.

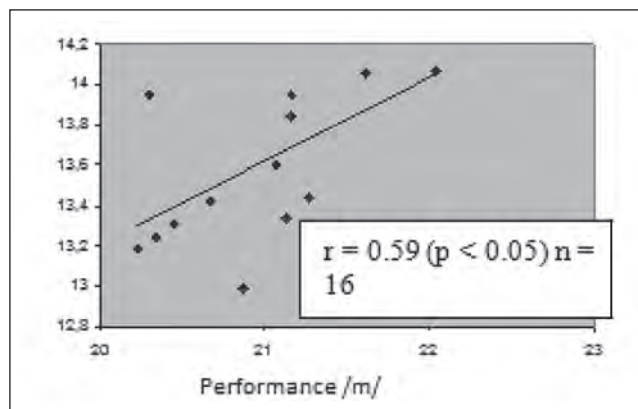

Figure 2: The dependence of the performance in the shot put using rotational technique on the overall release velocity in the group of 20 - 23 m.

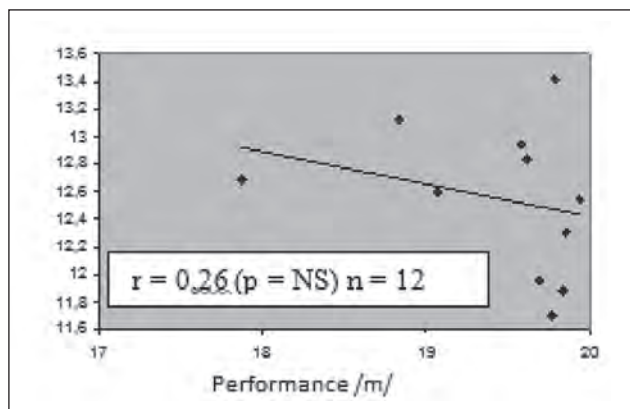

Figure 3: The dependence of the performance in the shot put using rotational technique on the overall release velocity in the group of 17 - 20 m.

The release angle is one of the key parameters of the performance. The angle is formed by the intersection of two straight lines. The first one forms a tangent to the trajectory of the shot in the moment of release and the other straight line is parallel with the ground, or the area of the circle and it crosses the centre of gravity of the shot in the last position, when the shot is still in contact with the shot putter's hand.

According to Tutevič (1969), the optimum release angle in a performance of 20 m is about 42,5°. The foreign study of Bartonietz and Borgston (1995) also brought an interesting finding. By means of 2D analysis, they examined the finalists of the World Cup in athletics in Gotenborg. In this competition, J. Godina, M. Halvari and R. Barnes were between those shot putters who used rotational technique. The authors stated, according to calculations, an optimum angle of 40 - 42° for them. However, not even one reached such values. J. Godina, in his best performance 21,47 m, achieved a release angle of 31°, M. Halvari, in a shot put 20,93 m long, had a 35° angle and R. Barnes, in an attempt of shot put 20,41 m long, had a release angle of only 30°. The authors further stated that if the release angle was closer to the optimum values, the shot put could be lengthened by up to one metre.

According to other sources (Putnam, 1993 and Linthorne, 2001), in elite shot putters at the level of 20 m, the optimum release angle ranges between 30° - 40°.

In fact, this was also our case, as no statistically significant dependence between the performance and release angle was confirmed based on calculations, not even in one of the three groups of performances. In the entire set of 43 performances, the correlation of the performance and release angle was at the level of -0,11, in the group of 17 - 20 m (n = 18), the correlation coefficient value was $r = 0,02$, and in the group of 20 - 23 m (n = 25) $r = -0,07$. The explanation can be found in the relative stability of this parameter, which is not changing significantly with the changing performance, and thus there is no concurrence, which can be identified by correlation coefficient.

Winter (1990) says that the larger the angle, the more effort must the shot putter make to overcome the weight of the shot, which is, however, at the expense of the horizontal component of the force and the subsequent acceleration of the shot. As he states further, the structure of the body is more designed to overcome resistance rather in horizontal than in vertical plane, what we can see in an example of a comparison of force of only the upper body part, where most of the athletes overcome greater weight in bench press than in standing military press or clean and jerk.

Regarding the extent of dependence of horizontal and vertical component of the shot release velocity, only the dependence of the performance on the horizontal component of shot release velocity in the set of 14 performances was significant at 5% level of statistical significance. In other cases, the dependence of the performance on these parameters, also after dividing them into 2 groups, was statistically insignificant.

Since the entire set consists of performances of shot putters using only rotational technique, it has been confirmed that these shot putters use more of the horizontal component of the velocity compared to the shot putters using back technique. This is due to the more efficient use of the spring mechanisms, even if the shot stops at a certain phase, there is an enormous initial tension resulting from the contradictory twisting of the pelvic axis towards the axis of the shoulders. Apart from accumulated elastic energy of the strain system of the muscle-tendon apparatus, proprioceptive stimulation of the reflex response after a quick stretch is also used (myotatic reflexes facilitate). This makes it possible, with proper timing, to biomechanically use myofascial chains more effectively, especially in the horizontal direction, which results in better sports performance. In the back technique, the shot putters have to put more force on the shot in the vertical plane, because they use rotational strain system less effectively.

The height of the centre of gravity of the shot in the moment of release (**h**) is the length of the vector perpendicular to the base between the centre of gravity of the shot in the last position, when it touches the hand and the base.

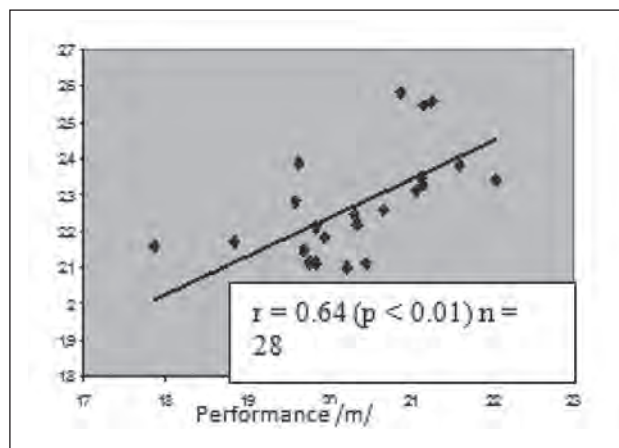

Figure 4: The relationship between the performance in the shot put using rotational technique and release height.

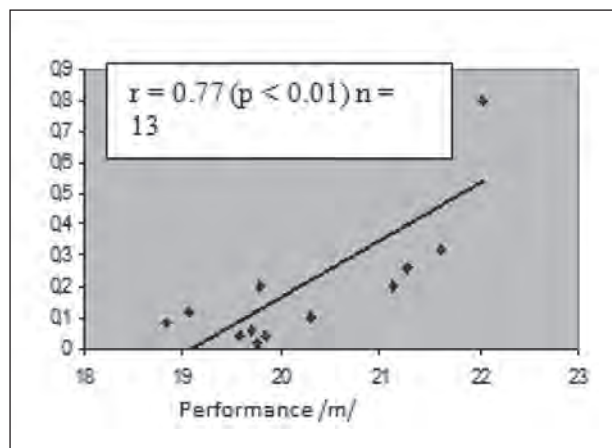

Figure 5: The relationship between the performance in the shot put using rotational technique and the time of the 2nd double-support phase of the release.

The dependence of the performance on the release height (Fig. 4) was statistically significant (1%) in the entire group, which confirms this parameter to be one of the limiting factors of technique. In the performance level of 20 - 23 m, this parameter is significant at 5% level of statistical significance; in performances of up to 20 m this parameter appears to be statistically insignificant. Therefore, in the weaker and smaller shot putters there must be different compensatory mechanisms improving the final performance.

The release height and some external factors (side wind) influence the size of the take-off angle, but in shot put it is to a much smaller extent than in discus or javelin throw.

The relationship between the performance and the time of the 2nd double-support phase of the release (Fig. 5) is significantly limiting for the performance in shot put, statistically significant at 1% level of significance. This seems to

be the key factor for proper technical performance of the shot put. Based on the results we can conclude that the longer the time of the impact on the shot in the second double-support phase, the better the chance to impact on the shot at a longer distance, which probably results in higher values of operating forces and thus also into a better sports performance. From the practical point of view, this is a common phenomena when coaches often point out late landing of the left foot (in right-handed athletes), or early rotation of the axis of the shoulders towards the direction of the shot put. For a broader interpretation of the effect of this parameter it would be more than appropriate to analyze also the relationships of factors such as peripheral speed, action angle of vault and release, as these complete the overall picture of the distance and time acting on the shot.

The parameters of the length of the 1st and 2nd step in relation to the performances were statistically insignificant globally, as well as in individual groups based on discriminant analysis.

Conclusions

Hypothesis 1 has been confirmed as the dependence and statistical significance of selected kinematic parameters was different depending on the level of performance in these parameters:

- The initial velocity of the shot, which substantially determines the length of the put, has been confirmed to be statistically significant at 1% level between the performance and initial velocity of the shot in the entire set of puts ($r = 0.68$), however in the group of 20 - 23 meters, this factor achieved only 5% level of statistical significance ($r = 0.59$) and in the performance group of 17 - 20 meters, the dependence of the performance on overall initial velocity of the shot has not been confirmed as significant ($r = -0.28$).
- In the entire set of 43 performances, the correlation of the performance and release angle was at the level of -0.11 , in the group of 17 - 20 m ($n = 18$), the correlation coefficient value was $r = 0.02$, and in the group of 20 - 23 m ($n = 25$) $r = -0.07$. Neither of these cases represents statistical significance.
- The extent of horizontal and vertical component of the velocity of shot release in our group was statistically significant, namely at 5% level, only between the performance and horizontal component of release velocity in the group of 14 performances ($r = 0.55$). In other cases, the dependence of the performance on these parameters, also after dividing them into 2 groups, was statistically insignificant.
- The dependence of the performance on the release height in the entire group was significant at 1% level ($r = 0.64$), which confirms this parameter to be one of the limiting factors of the technique. In this parameter, at the performance level of 20 - 23 m, there was a dependence with the values of sports performance at 5% level of statistical significance ($r = 0.54$), in performances of up to 20 m this parameter appears to be statistically insignificant ($r = 0.14$).

In the set of performances between 20 and 23 meters, the dependence of the performance on the overall release velocity at 5% level of statistical significance has been found with $r = 0.59$. In the same group of 20 - 23 m, the dependence of the performance on the take-off angle was insignificant, with correlation coefficient $r = -0.07$, which confirmed the 2nd hypothesis. The angle appears to be a relatively fixed parameter of the technique of these shot putters, the difference between the performances is determined especially by the parameter of the overall release velocity. The paper deals only with selected performances and parameters, therefore it is not possible to give relevant and complex recommendations for training and sports practice. Therefore, we suggest continuing with the research.

References

- Bartonietz, K.E. – Borgstom, A.: The throwing events at the World Championships in Athletics 1995, Gotenborg – Technique of the world's best athletes. Shot put and hammer throw. In: New studies in athletics. 1995, s. 43-63.
- Leško, M.: Optimalizácia odvrhového uhla vo vrhu guľou. In: Zborník prác z vedeckej konferencie. Bratislava: FTVŠ UK, 10. 12. 2002, ISBN 80–89075–12–6. s. 126-128
- Linthorne, N. P. (2001). Optimum release angle in the shot put. *Journal of Sports Sciences*, 19, s. 359-368.
- Putnam, C. A.: Sequential motions of body segments in striking and throwing skills: descriptions and explanations. *Journal of Biomechanics*, 1993, 26(1), s. 125-135.
- Tutevič, V.N. : Teorija sportivnych metanij. Moskva: FiS, 1969.
- Wallace, H. A. - G. W. Snedecor. Correlation and machine calculation. Iowa State College, Ames, 1931, 30(4) : 71 pp.
- Winter, D.A. Biomechanics and motor control of human movement (2nd Ed.), New York, NY: John Wiley & Sons, Inc. (1990), s.32-61.

EVALUATION OF REHABILITATION INFLUENCE ON STATIC PARAMETERS OF FOOT IN FLATFOOT DIAGNOSIS

Lucie Vorlickova^{1,2} and Pavel Korvas¹

¹Faculty of Sports Studies, Department of Kinesiology, Masaryk University Brno, Czech Republic

²Privat clinic Logo, Brno, Czech Republic

Abstract

The flexible flatfoot diagnosis in childhood belongs to the most frequent diagnosis in orthopedic and physiotherapist clinics. The aim of this research is to evaluate the influence of rehabilitation on the foot arch. The Emed platform was used for measurement of plantar pressure distribution and contact area. The static print of soles was made using the Podocam equipment. The research group consisted of four participants (aged 6.8 ± 3.4 years) with the flat foot diagnosis. Statistical analysis of mean pressures found an increasing of these pressures in the midfoot region after the rehabilitation. Similarly, a significant decrease of contact area was found in the region of the midfoot. The Chippaus-Smirak index was used for footprint evaluation. After rehabilitation the index decreased in cases of all participants. These four case studies indicate the effect of rehabilitation on foot arch in childhood.

Key words: foot arch, plantar pressure, Podocam, rehabilitation of flat foot

Introduction

The prevalence of flexible flatfoot is high in preschool-aged children. Current treatment of this deformity consists of wearing good shoes, stimulation of soles in daily life, wearing orthopedic inserts and rehabilitation therapy. Authors agree with wearing good shoes and with stimulation of soles in daily life, but orthopedic inserts and rehabilitation are questionable. The aim of this research is to evaluate the influence of rehabilitation on the values of plantar mean pressures and contact area in the flatfoot diagnosis.

Material and methods

Participants

The research group consisted of four participants (3 boys, 1 girl) with the flexible flat foot diagnosis. The average age was 6.8 ± 3.4 years, the average weight was 24.8 ± 9.3 kg. The informed consent was signed by parents of participant prior to data collection. Procedures

The measurements with the Emed and Podocam systems were performed before and after the rehabilitation exercises. The five week interval was performed between the first and the second measurements. The Emed platform was used for static measurements of plantar pressures distribution and for monitoring of foot contact area. The measurement was performed three times for each foot in standing position and took twenty seconds. The static printfoot of soles was made using the Podocam system. Then, the rehabilitation therapy started. The 45 minutes-long rehabilitation exercises were performed twice a week during next five weeks. The Propriofoot concept was used as a rehabilitation tool. The Propriofoot concept consists of four special balance plates and offers 17 different stability exercises for segmental sensomotoric feet activation, activation of let muscles and stabilization of foot arch.

Analysis

For analysis of mean pressures and contact areas, the sole was divided into five areas with the Multimask evaluation software. The areas were marked as follows: heel, midfoot, forefoot, thumbs and 2nd, 3rd, 4th, 5th toes. Especially, we were interested in the region of midfoot. This area was chosen for evaluation of changes of the foot arch height. The resulting mean pressures and contact areas were taken as the average values of three measurements of each sole. However, due to small research group, the statistical evaluation of rehabilitation included only the comparison of the averages and standard deviations of mean pressures and contact areas.

The Chippaux-Smirak index (CSI) was used for evaluation of footprints from Podocam system. The ratio of CSI was determined as the smallest width of the midfoot (MF) to the greatest width of the forefoot (FF), i.e. MF/FF. Both dimensions were measured on the perpendicular to the lateral tangent of footprint (figure 1).

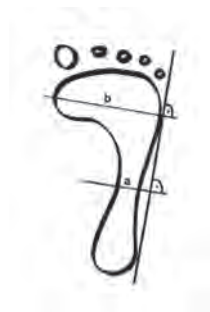

Figure 1: Representation of straight line segments used to calculate the CSI

Results

The mean pressures of midfoot from all participants are shown in table 1. The analysis of mean pressures found that the increase of these pressures was significant for all participants. This is shown in figure 2 for left and right foot. The values of contact area for all participants in midfoot are shown in table 2. Similarly, the decreasing of contact area was found in midfoot in all four cases, as you can see in figure 3 for left and right foot.

Table 1: Plantar mean pressures before and after rehabilitation

Participant	Therapy	Mean pressures [kPa]	
		Left	Right
First	Before	27.5 ± 1.6	31.1 ± 0.1
	After	35.9 ± 2.1	49.9 ± 3.1
Second	Before	23.2 ± 6.2	21.6 ± 0.6
	After	51.6 ± 1.8	48.4 ± 7.4
Third	Before	18.4 ± 2.7	25.4 ± 3.0
	After	37.0 ± 2.1	35.3 ± 5.4
Fourth	Before	30.0 ± 0.3	33.8 ± 0.7
	After	37.0 ± 9.3	34.6 ± 1.3

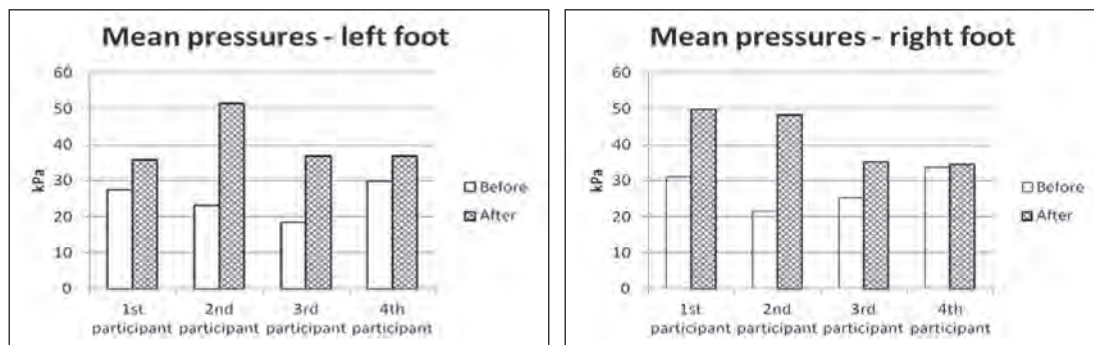

Figure 2: Mean pressures on feet before and after therapy

Table 2: Contact area before and after rehabilitation

Participant	Therapy	Contact area [cm ²]	
		Left	Right
First	Before	21.0 ± 3.5	22.8 ± 6.7
	After	17.3 ± 1.8	19.3 ± 0.4
Second	Before	19.0 ± 2.1	23.0 ± 1.6
	After	17.3 ± 3.9	20.5 ± 2.8
Third	Before	13.8 ± 0.4	15.0 ± 2.1
	After	8.8 ± 0.4	9.8 ± 0.4
Fourth	Before	16.3 ± 0.4	16.5 ± 0.0
	After	13.3 ± 0.4	14.0 ± 0.7

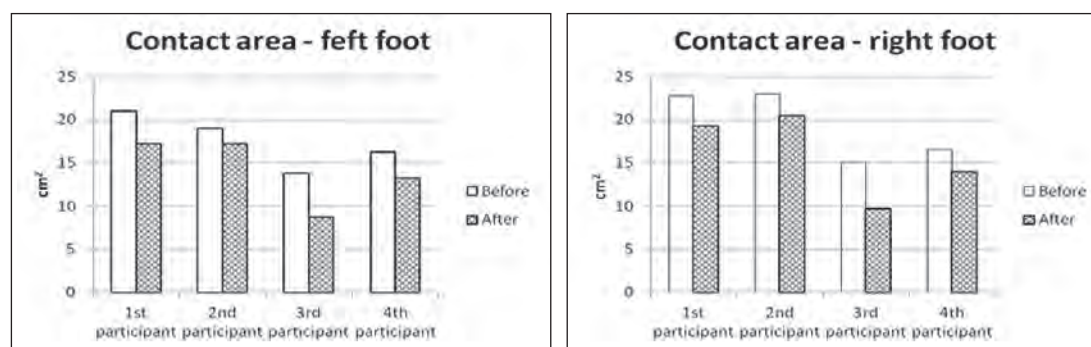

Figure 3: Contact area on feet before and after therapy

The values of CSI are shown in table 3. A higher value of CSI indicates low foot arch. In all cases the CSI decreases after the therapy.

Table 3: Chippaux-Smirak index

Participant	Therapy	Chippaux-Smirak index		Evaluation of CSI	
		Left	Right	Left	Right
First	Before	0.64	0.64	strongly flat	strongly flat
	After	0.35	0.35	normally arched	normally arched
Second	Before	0.36	0.71	normally arched	strongly flat
	After	0.34	0.38	normally arched	normally arched
Third	Before	0.35	0.57	normally arched	moderately flat
	After	0.34	0.33	normally arched	normally arched
Fourth	Before	0.63	0.36	strongly flat	normally arched
	After	0.31	0.31	normally arched	normally arched

Discussion

The prevalence of flat foot diagnosis is 44 % in childhood (Pfeiffer et al., 2006). Authors have different views on rehabilitation treatment of flat foot diagnosis (Evans, 2008). For example Rose (2007) is for flat foot treatment, on the other hand Adamec (2005) describes in his article that rehabilitation has no treatment effect. The aim of this research is to evaluate the influence of rehabilitation on the foot arch.

The evaluation of plantar pressure distribution of feet is commonly used in assessing of foot orthopedic defects, which includes flat feet too. These data provide us with the view of plantar loading during functional activities such as standing. Plantar pressure measurement can be a useful way to clinically track static foot function in children (Oladeji et al., 2008). The CSI was chosen for evaluation of the longitudinal arch, because it correlates very well with the results of radiographic examination and it can be simply determined (Maes, Andrianne, & Burny, 2004).

In this study the plantar pressure distribution, contact area and the Chippaux-Smirak index were evaluated in midfoot area before and after the rehabilitation therapy for monitoring of foot arch. The analysis of mean pressures found the increase of these pressures and decrease of contact area in midfoot for all participants. Especially, the decrease of contact area in midfoot indicates the increase of foot arch height. After the therapy the CSI decreases in all cases. The lower values of CSI indicate the increase of foot arch height after the rehabilitation. These results could be caused by activation of muscles that stabilize foot arch.

Conclusions

The Propriofoot concept is a rehabilitative approach to activate the foot arch. This method uses four special balance plates in standing on one leg position. We used the Emed platform system for plantar pressure and contact area measurement. These four case studies confirm the increase of mean pressures and decrease of contact area in midfoot for all participants. This study indicates the effect of rehabilitation on foot arch in childhood, but for more accurate results the research group should be extended.

References

1. Adamec, O. (2005). Flat foot in childhood – diagnostic and therapy. *Pediatrics in practice*, 4, 194-196.
2. Evans., A. (2008). The Flat-footed Child – To Treat or Not to Treat. What Is the Clinician to Do? *Journal of the American Podiatric Medical Association*, 5, 386-393.
3. Maes, R., Andrienne, Y., & Burny, B. (2004). Retrospective study of the correlation between foot print parameters and the Djian0Annonier angle for studying the plantar vault: Results in 158 feet. *The Journal of Bone and Joint Surgery*, 86, 35.
4. Oladeji, O., Stackhouse, C., Gracely, E., & Orlin, M. (2008). Comparison of the two-step and midgait methods of plantar pressure measurement in children. *Journal of the American Podiatric Medical Association*, 98, 268-77.
5. Paris, L., & Baicry, J. *Propriofoot concept*. Retrieved from the <http://www.propriofoot.com>
6. Pfeiffer, M., Kotz, R., Lendl, T., Hanser, R., & Sluga, M. (2006). Prevalence of Flat Foot in Preschool-Aged Children. *Pediatrics*, 118, 634-639.
7. Rose, Ch. (2007). Flat feet in Children: When should they be treated? *The Internet Journal of Orthopedic Surgery*, 6 (1).

COMPARISON BETWEEN KNEE JOINT KINEMATICS IN LABORATORY SKIING SIMULATION AND IN REAL SKIING WHILE USING SKIES OF DIFFERENT WIDTH

Martin Zorko^{1,2}, Blaž Lešnik¹, Bojan Nemeč⁴, Jan Babič⁴ and Matej Supej^{1,3}

¹University of Ljubljana, Faculty of Sport, Ljubljana, Slovenia

²University Medical Centre Ljubljana, Clinical Institute of Occupational, Traffic and Sports Medicine, Ljubljana, Slovenia

³Faculty of Mathematics, Natural Sciences and Information Technologies, University of Primorska, Koper, Slovenia;

⁴Department of Automation, Biocybernetics and Robotics, Jožef Stefan Institute, Ljubljana, Slovenia

Abstract

The aim of the study was to determine the knee joint kinematics in the ski turn while using skies of different waistwidth. We captured the kinematic parameters both in laboratory skiing simulation by using optical motion capture system and in real skiing situation by using inertial motion capture suit and Global Navigation Satellite System. It was discovered that the abduction and external rotation increase with increasing ski width in simulated skiing in laboratory environment. In real skiing, we noticed only increase of external rotation with increase of the ski width. The arbitrary knee joint flexion in real skiing makes some difficulty in the direct comparison of the results obtained in simulated environment and real skiing, respectively.

Key words: *biomechanics, giant slalom, knee joint position, flexion, abduction, external rotation*

Introduction

Alpine skiing is a complex sport in an outdoor environment. Recent evolution of the skis resulted in an increase of the ski waist width, i.e. the width of the skis under the ski boot. In a turn, the ski is in a contact with the snow primarily on the inside edge. Therefore, there is a shift of the point of application of the ground reaction force to the more loaded/external leg inward compared to skiing in a straight line. The wider the ski the bigger the mediolateral shift of the ground reaction force application can be expected. Therefore, the evolution of skis that have increased the waist width would either change the torques that affects the knee joint or more probably the kinematics of the knee. The aim of the study was to analyse how the kinematics of the knee joint change while using the skies of different waistwidth both in simulated skiing conditions and in the real skiing situation.

Methods

The methodology was divided into two parts: laboratory test and alpine skiing field measurements. The first part of the measurements took place in the laboratory, where we simulated the ski slope inclination and the external forces acting on the skier (Figure 1). One physically well prepared subject without alpine skiing experience was measured standing on specially built setup that simulated skiing on the edge of a ski. The first position was with the ski set flat on the ground following the ski set on the inside edge that simulated ski waistwidth of 6, 8 and 10 cm, respectively. The knee flexion angle was set on 50° and the subject maintained this position by using real time visual feedback system. Knee flexion, relative abduction and relative external rotation were calculated in real time based on position measurements using a contactless motion capture system (NDI Optotrak 3D Investigator). For the analysis, averages of 6 s long measurements at a sampling rate of 10 Hz were used.



Figure 1: Simulated skiing condition

In the second part of the experiment, three study subjects performed three runs using skis with the width under the boot of 6.5, 8.8 and 11 cm (Figure 2). Each ski had the same declared side cut. Each run included ten equal giant slalom turns. The skiers wore an inertial motion capture suit (MVN BIOMECH, XsensTechnologies) which directly measured 3D accelerations, 3D angular velocities and 3D orientation at a sampling frequency of 120 Hz. The reference trajectory of the skier was measured using the Real Time Kinematics Global Navigation Satellite System (RTKGNSS; LeicaGeosystems, series 1200) as explained in more detail elsewhere (M. Supej, 2010). Four standard phases of the turn were defined: initiation, steering 1, steering 2 and completion phase based on the previous studies (Müller et al., 1998; M. Supej & Holmberg, 2010). The angles in the knee joint were measured in the sagittal, frontal and transversal planes (flexion/extension, abduction/adduction, internal/external rotation) according to International Society of Biomechanics.



Figure 2: Capturing the skier's kinematics

Results

In laboratory conditions, the external rotation and abduction increased while the subject changed the position from the ski set flat on the ground to the ski set on the inside edge that simulated the ski width of 6 cm. The external rotation increased further with ski width of 8 cm and remained on the same level when the ski width increased to its maximum of 10 cm. In this position the external rotation was about 6° higher than at the starting (ski flat) position. The abduction increased even more constantly with the lowest value at the ski flat position and the highest value at the inside edge position with the maximum width of 10 cm. In this position the abduction was about 27° higher than at the starting (ski flat) position.

In real skiing the knee flexion in the turn was largest with the most narrow ski. In comparison to skiing straight the abduction increased in the turn with each of the skies with the most increment with the narrowest ski (Figure 3). The internal rotation increased in the turn with each of the skies as well but again the most so with the narrowest ski (Figure 4).

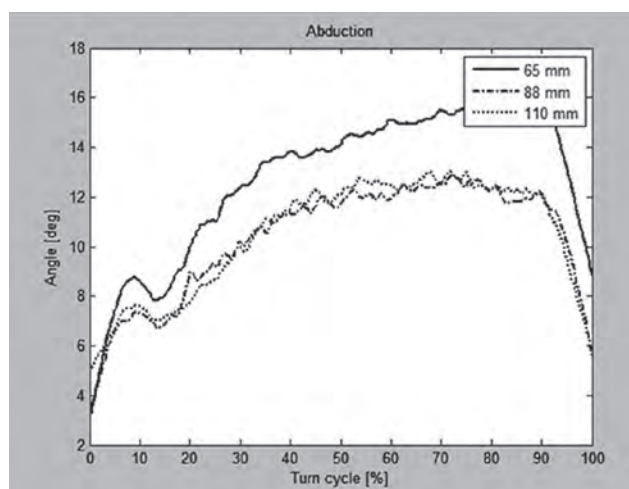

Figure 3: Knee joint abduction in the ski turn with skies of different width

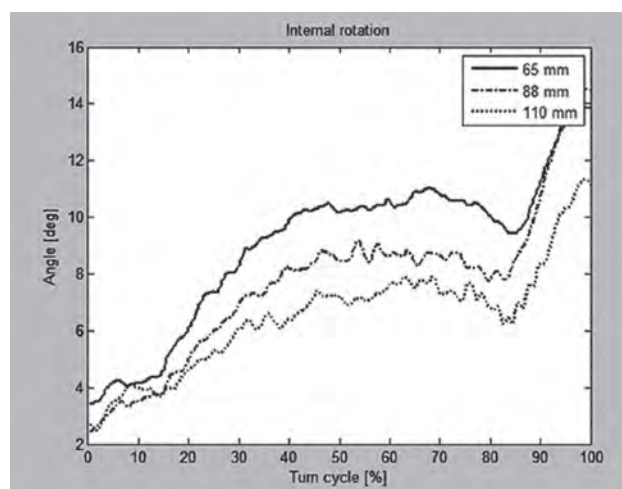

Figure 4: Knee joint internal rotation in the ski turn with skies of different width

Discussion

The increment of abduction while changing the position from skiing flat to setting the ski on the edge both in the laboratory and in the real skiing situation was most probably the result of the active skier's effort to move the knee joint inward and towards the ground reaction force vector. The increment of external rotation with wider ski, as it was discovered in the laboratory settings, most probably serves to the same purpose. In the real skiing conditions the increment of internal rotation in the turn apparently contrasts the laboratory findings. However, the knee joint flexion angle was arbitrary in the real skiing condition while it was fixed in the laboratory conditions. From this point of view one must take in to the account that the abduction and internal rotation of the knee joint are partly function of its flexion (Lu, Tsai, Kuo, Hsu, & Chen, 2008). Without mediolateral force application both parameters decrease while flexion increases. From this point of view the less internal rotation of knee joint with wide skies could be interpreted as the actual appearance of external rotation. The appearance of external rotation in the ski turn was confirmed also in other studies (Yoneyama, Kagawa, Okamoto, & Sawada, 2000).

Conclusion

The results indicate that wider skis may cause larger external rotation and abduction angles in the knee joint. This could lead to an increased injury risk particularly in dynamic situations such as skiing. The comparison of knee joint kinematics between laboratory and real skiing situations is somewhat difficult because in real skiing it is not possible to control the knee joint flexion angle and there might also be influence of some additional parameters (for example vibrations) that are hard to reconstruct in laboratory environment.

References

1. Lu, T. W., Tsai, T. Y., Kuo, M. Y., Hsu, H. C., & Chen, H. L. (2008). In vivo three-dimensional kinematics of the normal knee during active extension under unloaded and loaded conditions using single-plane fluoroscopy. *Med Eng Phys*, 30(8), 1004-1012.
2. Müller, E., Bartlett, R., Raschner, C., Schwameder, H., Benko-Bernwick, U., & Lindinger, S. (1998). Comparisons of the ski turn techniques of experienced and intermediate skiers. *Journal of Sports Sciences*, 16(6), 545-559.
3. Supej, M. (2010). 3D measurements of alpine skiing with an inertial sensor motion capture suit and GNSS RTK system. *J Sports Sci*, 28(7), 759-769.
4. Supej, M., & Holmberg, H. C. (2010). How gate setup and turn radii influence energy dissipation in slalom ski racing. [Evaluation Studies Research Support, Non-U.S. Gov't]. *J Appl Biomech*, 26(4), 454-464.
5. Yoneyama, Kagawa, Okamoto, & Sawada. (2000). Joint motion and reacting forces in the carving ski turn compared with the conventional ski turn. *Sports Engineering*, 3(3), 161-176.

CASE STUDY: VERIFYING THE EFFECT OF SPECIFIC ORTHOPAEDIC INSOLES AND BIOMECHANICAL SHOES ON PLANTAR PRESSURE

Martin Zvonar and Katerina Kolarova

Masaryk University, Czech Republic

Abstract

The aim of this paper is to present specific orthopaedic insoles and biomechanical shoes manufactured in the Czech Republic in cooperation with Faculty of Sport Studies and, most importantly, objective data which were obtained during analyzing the effect of the orthopaedic means on distribution of plantar pressure in two selected probands. Immediate effect on the sole inside the shoe was measured through plantographic insoles; long-term effect on a bare foot was measured on a plantographic platform. The results of the proband, who was testing orthopaedic insoles and the one who was testing biomechanical shoes, were quite different. With orthopaedic insoles, both plantographic methods proved majority of the proclaimed positive effects, whereas the effects of biomechanical shoes were both positive and negative. A common feature was immediate reaction towards a change, which is positively manifested only after long-term use.

Key words: *orthopaedic insoles, biomechanical shoes, plantography*

Introduction

Orthopaedic insoles or shoes are used to fix and cure deformations of foot skeleton, which may be either innate or caused by muscle weakening, overload or injury. The insoles can change the distribution of forces applied on the sole, thus relieving painful or overloaded areas, easing blood circulation in the foot, supporting plantar arch and regulating take-off. They are divided into active insoles, which activate foot muscles, and passive, which affect foot posture and support the arch (M.S.Ortoprotetika s.r.o., 2012). On the market, there are available many kinds of orthopaedic insoles and shoes designed e.g. for diabetics, athletes or people with usual feet deformations. A large number of medical surgeries commonly offer fitted orthopaedic insoles. However, not all such means meet the aim they have been designed for (Perry et al., 1995). Therefore, the effect of orthopaedic aids is checked in various studies (e.g. Villa et al., 2010; Hodgson et al., 2006; Brown et al., 2004; Stephan et al., 2003; Raspovic et al., 2000). The Faculty of Sports Studies was asked by a manufacturer of specific orthopaedic insoles and biomechanical shoes to check the claimed effects of their products. The insoles are manufactured by pressing natural cork; their most distinctive features are a depression in the area of the big toe knuckle and lowered hindfoot area (Fig. 1). The depression under the big toe knuckle should assist in involving all the toes in walking evenly. This should support stimulation of muscles and ligaments of the foot arch. The shape of the heel should act as a stimulus for correct posture of the heel bone and longitudinal foot arch. According to the manufacturer, the insoles are meant to produce healthy feet and movement by distributing body weight in a suitable way, activating muscles, tendons and ligaments of the foot, support its vascular and lymphatic systems and stimulate reflection points on the foot.



Figure 1: Tested orthopaedic insoles



Figure 2: Tested biomechanical shoes

Apart from the orthopaedic insoles (covered with leather) described above, biomechanical shoes (Fig. 2) contain other features supporting the correct function of the feet and their structures. They are stripes of flexible leather incorporated into the top part of the shoe, in the area of instep and heel. This provides space for the operation of longitudinal foot arch in the area of the instep; the heel stripes make it possible to change the posture of the heel bone and together with the lowered heel should stimulate correcting the posture of the heel bone. Using the available instruments, the task was to check the effects of orthopaedic insoles on body weight distribution, i.e. forces with which the sole inter-reacts with the surface. Another observed plantographic parameter was plantar pressure and its time integral representing the overall

load of the respective part of the sole during a step. The aim of this study was either to verify or falsify the claimed effects of orthopaedic insoles and biomechanical shoes in selected probands.

Methods

This case study examines selected parameters in two men aged 26 (proband No. 1) and 39 respectively (proband No. 2); 183 cm/83 kg and 185cm/85 kg respectively). The tests were carried out in the biomotor laboratory at the Faculty of Sports Studies between April and December 2012. To validate the acquired data, body weight of the probands was also observed; during the period, the weight ranged by $\pm 1\%$. The probands completed three measuring cycles. First two cycles had taken place before they started to use orthopaedic insoles or biomechanical shoes; the third cycle took place after a four-month period during which they were attempting to wear the tested shoes exclusively. Measurements followed the protocol below. Before the first measurement, proband lied relaxed on a chaise with stretched lower extremities without shoes. The heels were not supported against the chaise. After that, the proband put on shoes equipped with measuring plantographic insoles and performed 5 minutes of walking at the speed of 4-5 kph on a treadmill (Zháněl, J., Lehnert, M., & Černošek, M. 2005). To acquire plantographic data, the following systems were used: German Pedar-x System by Novel GmBH Company, which measures the immediate effect of orthopaedic insoles on a foot inside a shoe, and Emed-at, i.e. plantographic platform that measures the long-term effect on the foot through measuring a bare foot. Within one measurement, about 260 footprints of each foot were recorded with the Pedar system; the average value was analysed. Similarly, measurement with the plantographic platform was dynamic as well, i.e. while walking. During measurement the method of the third step was used (Bus, de Lange, 2005). This means that the proband stepped onto the platform with the third step after initiating walking. The subsequent analyses always used the average of three (Rosenbaum, 2006) measurements for each foot of the proband. Plantographic data were processed using Multimask Evaluation. The sole was divided into 10 areas (Fig. 3), (M01 – hindfoot; M02 – midfoot; M03 - the first, M04 – the second, M05 – the third, M06 – the fourth, M07 – the fifth metatarsus; M08 – big toe; M09 – second toe; M10 – toes 3&5; see Fig. 3). The size of the contact area, maximum force, peak pressure and pressure time integral (PTI) were measured.



Figure 3: Division of the sole into areas

Results

First, it is necessary to say that the tables with results manifest certain differences between the changes on the right and left feet. Therefore, we focused mainly on such changes that are common for both feet.

Table 1: Values measured inside the left shoe 1) in regular shoes 2) during first-time use of orthopaedic insole, 3) after long-term use

proband	Maximum Force			Peak pressure			PTI		
	[N]			[kPa]			[(kPa)*s]		
1	1	2	3	1	2	3	1	2	3
left	1	2	3	1	2	3	1	2	3
Total	911.3±59.5	1053.5±72.2	910.4±24.5	222.9±20.8	324.9±65.6	267.5±54.3	91.0±6.0	141.1±38.2	104.3±9.1
M01	447.8±87.5	567.3±96.5	604.5±47.6	169.5±43.6	302.0±66.9	178.9±14.9	39.0±8.6	118.4±47.9	51.6±8.3
M02	227.4±31.8	237.6±32.9	320.0±28.2	137.6±31.8	142.0±31.4	140.6±20.3	54.7±12.0	60.4±14.3	64.8±11.2
M03	86.6±22.5	85.3±23.4	73.4±25.0	186.0±22.7	143.1±32.2	138.8±24.2	54.2±8.1	43.6±7.8	39.3±8.3
M04	56.2±6.6	43.4±7.1	48.9±8.5	198.9±21.6	241.8±24.6	163.2±12.3	58.4±7.0	70.8±7.8	47.3±5.1
M05	60.1±6.4	65.7±6.5	55.9±3.4	196.8±22.4	241.8±24.6	162.7±9.9	58.0±6.8	70.8±7.8	51.4±5.6
M06	68.7±8.4	72.1±8.6	69.9±6.5	209.3±24.7	241.2±28.1	173.1±16.0	66.2±8.0	67.2±9.3	57.0±8.0
M07	88.0±17.6	108.8±19.2	97.0±16.6	170.9±29.9	192.4±26.5	160.9±19.8	57.3±9.9	57.6±11.4	56.4±9.8
M08	164.3±29.2	194.2±40.2	203.0±33.3	192.9±37.0	273.5±66.5	266.1±56.2	46.3±10.9	64.5±14.1	51.7±10.3
M09	67.9±8.0	84.7±11.0	90.6±5.2	151.8±21.9	172.0±19.2	163.2±9.8	40.9±6.8	48.3±5.9	40.1±5.3
M10	147.8±16.1	167.9±19.6	185.9±16.7	166.8±21.2	175.8±19.3	134.6±10.8	40.6±5.2	44.3±4.9	39.4±3.7

Table 2: Values measured inside the right shoe

proband	Maximum Force			Peak pressure			PTI		
1	[N]			[kPa]			[(kPa)*s]		
right	1	2	3	1	2	3	1	2	3
Total	858.5±70.2	984.8±69.9	899.1±20.5	251.1±36.5	427.5±92.6	313.4±47.7	98.5±5.3	131.1±19.4	116.6±10.7
M01	591.2±99.8	601.1±122.0	618.5±44.5	200.3±46.2	224.9±59.6	194.2±14.9	43.6±4.8	50.1±9.6	48.7±6.0
M02	215.7±32.6	211.1±28.2	284.0±26.5	114.4±30.3	110.8±21.9	131.5±22.9	46.9±12.4	49.5±11.5	56.7±8.6
M03	79.7±18.2	75.9±19.4	88.8±24.7	154.6±25.3	131.2±31.0	139.0±32.7	46.7±7.8	42.9±11.2	44.3±10.7
M04	56.5±3.8	42.5±6.6	61.8±8.0	182.8±12.7	137.0±25.1	160.2±19.3	53.7±6.5	40.5±9.7	49.0±6.0
M05	63.3±7.7	57.5±6.5	61.1±5.2	202.5±24.4	197.1±24.4	182.1±16.4	59.6±8.6	62.3±11.1	52.2±4.7
M06	63.9±11.9	64.6±11.1	72.6±11.2	200.1±33.7	203.5±34.5	194.0±25.2	63.9±11.6	62.8±12.8	58.5±8.3
M07	80.0±22.4	99.2±25.1	91.7±24.9	153.9±37.3	186.7±38.2	163.4±37.5	54.8±12.9	60.1±13.8	50.9±12.0
M08	166.3±31.0	256.3±486	258.7±36.8	236.7±50.2	426.3±96.0	312.3±49.3	51.2±10.6	98.7±27.7	67.6±18.7
M09	62.0±7.7	86.1±11.9	64.4±3.0	172.6±16.8	263.6±50.8	282.0±40.6	44.7±5.1	57.4±9.1	61.5±15.8
M10	138.6±24.5	180.6±26.4	132.4±15.5	174.8±21.7	205.2±26.1	128.3±10.8	43.9±4.7	58.2±9.0	32.8±3.2

Maximum force inside the shoe (Table 1, 2) - the immediate effect of orthopaedic insoles was increasing the maximum force under the hindfoot, lateral metatarsi and all toes. The effect for toes and hindfoot usually even increased after long-term use. Peak pressure inside the shoe - orthopaedic insoles had an immediate effect mainly on the left foot, increasing peak pressures in all areas except for one – the area of the first metatarsus (under the big toe knuckle). In this area, maximum pressure decreased and after long-term use, it decreased even more. After long-term use, pressure decreased again in most areas, in the area of all metatarsi and lateral toes even below the value measured in the original shoe. Values for big toes and second toes remained higher in comparison with original values. Pressure Time Integral inside the shoe - the trend here was the same as above – initial increase in nearly all areas. After long-term use, the values decreased again. The area of the first metatarsus was again an exception – this area manifested decrease from the very beginning. The value remains higher under the hind part of both feet, the midfoot and under the big toe.

Table 3: Plantographic values for left bare foot

proband	Contact Area		Maximum Force		Peak pressure		PTI	
1	[cm,]		[N]		[kPa]		[(kPa)*s]	
left	pre	post	pre	post	pre	post	pre	Post
Total	160.21	159.68	990.05	989.10	450.00	435.00	216.42	215.52
M01	38.69	38.01	594.46	555.55	375.00	355.00	95.21	94.48
M02	36.60	36.69	234.72	288.82	180.00	190.00	65.77	77.55
M03	14.11	14.32	130.59	105.10	220.00	240.00	68.87	79.91
M04	11.72	11.95	217.93	225.15	435.00	435.00	134.12	134.83
M05	13.85	14.02	249.80	261.82	440.00	435.00	137.22	136.20
M06	10.73	10.83	157.22	180.54	310.00	350.00	105.03	114.55
M07	6.51	6.93	61.81	73.21	310.00	330.00	96.76	98.61
M08	15.10	13.36	153.81	125.04	450.00	305.00	99.34	65.94
M09	4.95	5.62	29.29	46.06	145.00	205.00	32.37	55.90
M10	7.24	7.49	16.66	24.04	85.00	125.00	22.73	41.73

Table 4: Plantographic values for right bare foot

proband	Contact Area		Maximum Force		Peak pressure		PTI	
1	[cm ²]		[N]		[kPa]		[(kPa)*s]	
right	pre	post	pre	post	pre	Post	pre	post
Total	151.46	168.69	921.92	1003.60	830.00	605.00	313.91	278.09
M01	38.00	40.60	572.43	626.19	450.00	440.00	116.77	125.67
M02	32.73	37.61	150.13	208.07	115.00	150.00	42.31	51.13
M03	14.72	15.26	126.46	144.55	215.00	210.00	77.05	72.18
M04	11.52	11.92	190.97	213.68	410.00	430.00	147.44	146.52
M05	13.98	14.17	254.98	275.08	485.00	475.00	160.19	156.94
M06	11.08	11.62	152.67	176.72	375.00	405.00	126.56	131.96
M07	6.55	7.53	40.56	62.18	255.00	275.00	89.06	85.55
M08	13.54	13.27	192.00	201.86	830.00	605.00	209.15	123.51
M09	4.14	5.34	12.45	25.29	65.00	120.00	10.35	20.06
M10	4.53	10.87	7.61	27.23	45.00	75.00	8.13	13.18

Contact area while walking barefoot (Table 3, 4) - in nearly all masks, the contact area grew larger; there was a bigger growth with other toes of the right foot. On the other hand, there was a bigger decrease in right midfoot and a smaller decrease in the contact area with both big toes. *Maximum force while walking barefoot* - with the right foot, the maximum force increased in all aspects. In both feet, there was a significant increase in the area of the midfoot. Maximum force decreased in left hindfoot, the first metatarsus and the big toe. *Peak pressure while walking barefoot* - the values of peak pressure decreased significantly under the hindfoot and toes; there was a smaller decrease in the third metatarsi. On the other hand, there was a significant increase in the second toes and the other toes and a certain increase in peak pressure in the fourth and fifth metatarsi. *Pressure time integral while walking barefoot* - The rate of overall load of individual parts of the left foot reflects the changes in peak pressure; there are smaller differences in the right foot. In both feet, toes are loaded more except for the big toes. The load of big toes decreased significantly. The midfoot and the areas of the fourth metatarsus are loaded more.

Table 5: Values measured inside the left shoe

proband	Maximum Force			Peak pressure			PTI		
2	[N]			[kPa]			[(kPa)*s]		
left	1	2	3	1	2	3	1	2	3
Total	921.0±367.1	996.3±61.4	906.5±39.8	281.3±103.5	394.3±83.1	268.4±28.0	143.7±107.3	175.8±30.8	134.8±18.7
M01	528.6±208.7	651.7±70.0	610.6±48.9	157.2±37.2	267.5±28.6	239.8±19.7	83.3±66.9	79.0±13.2	65.0±17.2
M02	290.9±122.6	221.4±44.3	224.5±40.8	81.9±35.6	120.5±44.4	105.0±34.1	48.3±32.0	56.5±19.8	49.1±15.3
M03	79.1±38.1	101.9±29.7	116.2±29.2	124.4±55.0	162.9±26.8	170.5±42.2	54.0±37.2	63.7±18.5	67.8±23.4
M04	41.3±18.1	48.8±7.1	59.6±10.4	126.1±54.5	230.1±26.7	192.5±23.2	53.3±35.9	89.3±11.9	72.7±13.0
M05	34.7±15.2	66.4±6.9	66.2±7.6	112.8±49.8	230.1±26.7	192.3±23.9	46.2±30.7	89.2±11.7	72.7±13.2
M06	42.7±20.0	68.3±13.8	67.2±13.0	117.0±54.2	199.3±36.9	170.8±30.3	54.9±36.4	80.8±14.6	67.4±13.7
M07	52.7±28.1	83.4±29.4	75.9±25.3	90.9±45.1	141.0±40.4	117.6±33.9	46.52±30.9	63.4±18.0	51.0±15.5
M08	178.9±82.4	188.9±43.6	188.4±38.2	269.6±126.7	387.8±94.3	259.1±42.0	100.1±76.0	126.6±41.7	82.4±20.5
M09	65.9±28.3	48.7±4.1	58.2±7.6	120.4±52.0	129.8±13.7	120.4±13.9	48.7±33.2	48.2±7.3	43.2±6.4
M10	168.7±80.2	197.0±33.7	146.1±28.2	118.1±55.4	175.3±18.6	117.4±14.6	50.7±36.0	67.8±9.2	42.5±6.7

Table 6: Values measured inside the right shoe

proband	Maximum Force			Peak pressure			PTI		
2	[N]			[kPa]			[(kPa)*s]		
right	1	2	3	1	2	3	1	2	3
Total	1094.6±48.1	1052.1±96.1	954.3±23.8	256.3±47.5	401.7±78.7	251.1±37.8	119.5±19.9	181.0±27.0	135.8±14.2
M01	597.8±57.7	576.7±71.4	545.9±44.0	180.2±18.4	241.8±26.4	223.1±20.4	61.0±19.4	76.5±16.6	60.0±8.7
M02	356.3±20.7	297.6±46.4	324.4±42.2	116.6±25.5	204.2±51.3	196.7±62.3	60.5±13.7	101.3±24.6	90.5±24.3
M03	82.7±20.3	76.3±23.4	83.8±25.7	133.1±27.9	126.9±31.8	125.7±34.2	54.9±13.9	53.6±12.7	47.9±12.5
M04	57.2±7.7	48.0±9.4	54.3±9.5	156.1±19.8	138.4±26.3	132.2±23.1	59.8±10.8	51.7±9.9	45.6±8.8
M05	54.5±5.7	69.0±9.8	72.3±6.8	168.6±19.4	220.8±33.9	180.5±18.6	62.9±7.9	81.9±10.7	65.9±5.5
M06	66.4±9.6	80.2±14.6	74.1±13.7	178.4±23.9	233.1±40.2	183.6±31.4	70.5±10.2	89.2±12.9	66.9±9.8
M07	97.7±21.5	128.0±30.3	103.6±28.1	160.0±29.0	210.4±51.5	165.7±44.9	69.2±13.3	98.9±23.0	69.9±17.1
M08	176.6±34.4	211.1±45.9	187.9±46.7	248.3±57.8	395.9±90.2	209.2±45.7	78.1±27.9	132.4±36.0	70.9±22.1
M09	60.3±5.5	43.0±6.3	45.7±4.8	121.7±11.6	113.8±17.8	86.2±11.4	43.2±8.5	39.9±10.1	26.8±4.9
M10	183.4±28.7	177.5±31.3	129.1±22.0	136.5±16.0	159.7±26.0	110.0±11.4	47.61±9.7	56.7±11.2	35.6±3.9

Contact area while walking barefoot (Table 5, 6) - in all areas of the left foot, the contact area grew slightly larger, the most in the big toe and the second toe. In the right foot, the contact area grew larger only in the area of the first metatarsus. There are only minimum differences in the other areas. *Maximum force while walking barefoot* - maximum force decreased nearly in all areas of both feet; it increased only in the areas of the first metatarsi. There is an interesting disaccord in the area of the big toes: in the left foot, there was a significant increase in maximum force in comparison with the right foot where maximum force decreased significantly. *Peak pressure while walking barefoot* - for this parameter, there is only a minimum similarity between the left and right foot, namely in the decrease in peak pressure in the second and third metatarsi and the second toes. In the big toes, there is again significant disaccord, just like in the fourth metatarsi and midfoot. *Pressure time integral while walking barefoot* - similarly, there is only a minor resemblance of the right and left foot. What is in accordance is the decreased load in hindfoot, in the areas of the second and third metatarsi and the other toes. There is a significant decrease in the load of the right big toe; in the left big toe, the load increased.

Discussion

The increase in maximum force and load in the hindfoot can be explained by lower position of the heel when compared with the rest of the foot. Thus, when the foot lands, hindfoot is affected by a greater bump than when wearing regular shoes. Greater involvement of toes was expected due to depression of the insole under the first metatarsus, which transfers load and conditions in order to involve other structures. What was unexpected, it is the increased load of midfoot, i.e. the longitudinal arch. As its function was improved, we would expect decrease in load. This could also be possibly explained by the lower position of hindfoot and the depression under the first metatarsus, which results in having the rest of the insole closer to midfoot than in regular shoes. Enlargement of the contact area was expected only in the sense of more involving toes, while walking barefoot. Similarly, we expected reducing the contact area in midfoot due to estimated improvement of the function of the longitudinal arch. However, the increase in maximum force and pressure time integral in this area is not in compliance with this. Decrease in maximum forces and pressures under areas, which are usually loaded the most, may be a proof of more balanced forces distribution.

Conclusion

After profound plantographic examination of orthopaedic insoles and biomechanical shoes, it can be stated that these orthopaedic means caused immediate significant changes in the values of many tested parameters right after their first use; including both positive and negative changes. After long-term use, the changes in values were less dramatic and most of the original negative changes tended to improve.

The improvement was more obvious in the proband, who was testing orthopaedic insoles, i.e. better overall distribution of forces, bigger involvement of toes in walking, smaller contact area of midfoot and improving heat transmission after long-term use of orthopaedic insoles.

In the case of testing of orthopaedic shoes, the function of the longitudinal arch improved. Involvement of toes in walking got worse after first use. On the basis of our measurements, positive effects of the tested orthopaedic insoles could be verified; however, the effects of biomechanical shoes could be questioned.

References

1. Brown D. et al., 2004. Effect of rocker soles on plantar pressures, *Arch Phys Med Rehabil.* 2004 Jan; 85(1):81-6
2. Bus, S. A., De Lange, A., 2005. A comparison of the 1-step, 2-step and 3-step protocols for obtaining barefoot plantar pressure data in the diabetic neuropathic foot, *Clinical biomechanics vol. 20.* Amsterdam: University of Amsterdam, 2005. ISSN 0268-0033
3. Hodgson et al., 2006. The Effect of 2 Different Custom-Molded Corrective Orthotics on Plantar Pressure. *J Sport Rehabil.* 2006, 15, 33-44 2006 Human Kinetics, Inc.
4. Perry J. E. et al., 1995. The use of running shoes to reduce plantar pressures in patients who have diabetes, *The Journal of Bone and Joint Surgery*, The center for locomotion studies, Pennsylvania State University, University park, 1995
5. Praet F. E. et al., 2003. The Influence of Shoe Design on Plantar Pressures in Neuropathic Feet. *Diabetes Care.* 2003 Feb; 26(2):441-5.
6. Rasporic et al., 2000. Effect of customized insoles on vertical plantar pressures in sites of previous neuropathic ulceration in the diabetic foot. *The Foot.* 2000 10 (3):133–8.
7. Rosenbaum D., 2006. Plantar pressure distribution measurements for the assessment of foot function: Technical Background, Recommendations for Data Collection and Processing, and Clinical Applications *In Emed scientific meeting*, München
8. Villa A. et al., 2010. Study of plantar pressure distribution in shoe with curved sole: A comparative preliminary pilot study. *In ANDESCON, 2010*
9. Electronic resource:
10. M.S.Ortoprotetika, 2012. Ortopedické vložky [online] 10. 4. 2012 [cit. 30.1.2013] available on www <http://www.ms-protetik.cz/view.php?cisloclanku=2006100015>
11. Zháněl, J., Lehnert, M., & Černošek, M. (2005). Diagnostika ve sportu. *Telesná výchova & šport*, 3, 48-51.

POSTURAL ADJUSTMENTS OF LEANING DURING STANCE ON INCLINED SURFACE

Kristina Buckova, Zuzana Hirjakova and Frantisek Hlavacka

Laboratory of Motor Control, Slovakia

Purpose

The voluntary, maximum inclined posture reflects the self-perceived limits of stability. The aim of the study was to investigate the magnitude of anticipatory postural adjustments (APAs) in body lean initiation. Limits of stability influenced by standing on inclined surface were also evaluated.

Methods

Eleven young healthy volunteers (6 female, mean age 28.1 ± 4 years, mean height 170.8 ± 5.2 cm, mean weight 63.1 ± 12.2 kg) participated in the study. Subjects stood on support surface with variable slope angle which was placed on force platform. Accelerometer (Xsens Technologies, B.V., Netherlands) was placed on the level of fifth lumbar (L5) vertebra. Retro-reflective marker was attached on the accelerometer. Kinematic inclination parameter was automatically recorded by motion capture system (BTS Smart DX, Italy), with sampling frequency of 100 Hz. Participants were instructed to make a maximal voluntary forward inclination, using ankle strategy, and persist in this position 10 seconds. Each trial was repeated 3 times, under 4 conditions: eyes open – flat surface (EOH), eyes closed – flat surface (ECH), eyes open – slope angle 20° (EO2), eyes closed - slope angle 20° (EC2). We evaluated the final displacement of center of pressure (CoP) and amplitude of L5 tilts and the magnitude of APAs in AP direction.

Results

We observed that the lifting of surface slope angle up resulted in decrease of CoP final amplitude. Data from accelerometer placed at L5 had a similar trend. Magnitude of APAs in AP direction evaluated from CoP and L5 accelerometer was decreased due to elevated support surface significantly.

Conclusion

The present study showed that the functional limit of stability and anticipatory postural adjustments in forward direction are influenced by elevated of support surface. Thereafter the decline of functional limit of stability could lead to higher risk of falls and injures.

Supported by VEGA grants No. 2/0138/13 and No. 1/0744/14

THE ROLE OF RELATIVE MOTION INFORMATION DURING OBSERVATIONAL LEARNING IN SPORTS

Saeed Ghorbani¹ and Andreas Bund²

¹*Institute of Sport Sciences, University of Oldenburg, Germany*

²*EMACS Research Unit, University of Luxembourg, Luxembourg*

Purpose

The purpose of present study was to investigate the relative effects of observing video, stick-figure and point-light model demonstrations on performing a Baseball pitch.

Methods

41 novice adults performed 5 familiarization trials, three blocks of 10 training trials with three times of model demonstrations prior to each block, and two retention tests of 5 trials in 10 min and one week later. Kinematic pattern and time of global movement and movement phases were measured as dependent variables.

Results

Results revealed no significant differences between demonstration groups and control group. Analysis of movement phases showed a significant improvement in stride phase from pretest to acquisition blocks in all variables.

Conclusions

Results are discussed in terms of theoretical and methodological aspects.

Key words: *Observation, model demonstration, Baseball pitch*

ANALYZING INDIVIDUAL COORDINATION PATTERNS OF FOREHAND TOPSPIN TABLE TENNIS STROKES DURING FATIGUE USING PCA

Michaela Hassmann¹, Mario Heller¹, Arnold Baca¹, Miran Kondrič² and Kerstin Witte³

¹University of Vienna, Austria

²University of Ljubljana, Slovenia

³University of Magdeburg, Germany

Due to the short time between two ball hits table tennis is deemed to be the fastest racket sport. Anaerobic intervals lead to progressive fatigue of players. Considerable differences of selected kinematics but similar time courses of resulting racket velocity arise the hypothesis of coordinative changes during fatigue. A standardized protocol with up to 24 sequences of 12 strokes against a ball machine at 48 balls / minute was created for quantification of neuromuscular fatigue. 6 subjects of international top level (male, 26.5 ± 6.4 years, right-handed) participated in this study. Subjects were advised primarily to hit balls at maximum speed and topspin, secondly precision should be maintained. The setup comprises heart rate monitor (Polar), force plate under the right leg (Kistler, 1000 Hz), 3D Plug-in-Gait whole body marker set plus 3 racket markers (VICON, 8 cameras, 200 Hz), surface EMG of striking arm (Delsys, 2000 Hz) and hit rate. Kinematic data of 47 Euler joint angles were calculated and normalized by stroke cycles and z-score standardized using Matlab R2013a. For each sequence the 8 most similar cycles in terms of racket velocity and center of mass time courses were automatically selected by k-means clustering and averaged. Principal component analysis (PCA) was implemented for dimensionality reduction of this large data set to separate global and residual pattern. Only first and second principal component PC1 and PC2 were retained to reconstruct the global coordination pattern, all further components were regarded as noise. Variables with squared nonrotated factor loadings ≥ 0.5 were considered as relevant contributions to PCs. PC1 and PC2 summed up 79.6 ± 3.5 % of cumulative variance for all subjects and sequences. 31 ± 3 out of 47 joint angles contribute to PC1 at a large degree as one would expect from whole body motion. Results support the idea of non-linear changes of global coordination pattern, as individual joint angles show largely different trends while PCs do not show significant changes throughout all sequences. PCA is capable of giving an overall description of coordination patterns and individual strategies coping fatigue.

VISUAL BIOFEEDBACK MAGNIFICATION FOR STANCE CONTROL IN YOUNG AND ELDERLY

Zuzana Hirjakova, Jana Lobotkova and Frantisek Hlavacka

Institute of Normal and Pathological Physiology, Slovak Academy of Sciences

Purpose

The purpose of this study was to determine the effect of magnified visual biofeedback (VBF) of the CoP (centre of foot pressure) position displayed on monitor for improving stance control in two age groups: young and elderly.

Methods

Twenty healthy young adults (9 men; mean age 26,5 years) and 20 healthy elderly (8 men; mean age 74 years) participated in the study. The body sway was recorded by force platform (CoP) and two accelerometers attached on lower (L5) and upper (Th4) trunk. The balance was assessed during stance on firm / foam surface with eyes open and with VBF presented at 2 magnifications: 2x (Gain2) and 5x (Gain5). VBF was presented as moving red point on monitor controlled by CoP position. Evaluated parameter was root mean square (RMS).

Results

In young group, providing of VBF led to a reduction of CoP in both gains comparing to control conditions during stance on both types of surface. Decrease of lower trunk tilt occurred in Gain2 condition on foam surface and in Gain5 condition on both types of surface. Reduction of upper trunk tilt was observed only in Gain5 condition on firm surface. In elderly group, VBF led to a reduction of CoP, lower and upper trunk tilt in both gains on foam surface and to a reduction of CoP and lower trunk tilt during Gain5 condition on firm surface.

Conclusion

Our results suggest that both magnifications (2x and 5x) provide meaningful additional information for postural stabilization in young and elderly healthy population. CoP-based VBF had the greatest influence on reducing CoP position. Higher magnification and standing on foam surface led to a greater decrease of RMS. This suggests greater reliance on vision in situation with altered proprioceptive information.

Supported by VEGA grants No. 2/0138/13 and No. 1/0373/14

Key words: *visual biofeedback; balance control; accelerometer; force platform*

SKELETAL MUSCLE'S CONTRACTILE PARAMETERS DIFFER WHEN MEASURED FROM LONGITUDINAL THAN FROM TRANSVERSAL TWITCH DEFORMATIONS

Katja Koren¹, Boštjan Šimunič^{1,2}, Enrico Rejc^{3,4}, Stefano Lazzer³ and Rado Pišot^{1,2}

¹*University of Primorska, Science and Research Centre, Institute for Kinesiology Research, Koper, Slovenia*

²*University of Primorska, Faculty of Education, Department of Primary School Teaching, Koper, Slovenia*

³*University of Udine, Department of Medical and Biological Sciences, Physiology, Italy*

⁴*University of Louisville, Department of Neurological Surgery, Louisville, Kentucky, USA*

Abstract

Contractile properties of skeletal muscle are studied for various purposes and mainly by means of force or torque twitch responses. This study compares contractile properties estimated from isometric longitudinal and transversal vastus lateralis twitch mechanical actions, using torque and tensiomyography as assessment methods, respectively. We calculated delay time (Td), contraction time (Tc), sustain time (Ts), half relaxation time (Tr) and peak amplitude (Am) from graded twitch response of both methods in 19 healthy males (age 46.1 ± 17.8 years). Results indicate an exponential relation of Am at increasing stimulating impulse amplitude. Furthermore, shorter Td and Tc were found when calculated from transversal actions, shorter Tr was found when calculated from longitudinal actions, while no differences in Ts. Td and Tc did not correlate when compared between longitudinal and transversal actions, however, Ts and Tr did. In conclusion, different mechanisms affect longitudinal and transversal twitch skeletal muscle deformations and it seems that tensiomyographic response of skeletal muscle's transversal actions reflects more intrinsic contractile properties.

COMPARISON ANALYSIS OF FINSWIMMING WITH RIGID AND SOFT MONOFINS

Vladimir Kunitson¹, Kristijan Port¹ and Tatjana Gnezdilova²

¹Tallinn University, Estonia

²SK Fortuna, Estonia

Abstract

Purpose: of the study was to analyse the impact of rigidity of fin in finswimming on the rhythm of swimming represented as variability in stroke tempo. While the selection of suitable rigidity of fins in competitive finswimming is regarded commonly as a non-trivial and significant criterion, the impact of the selection on the swimming performance is lacking empirical evidence. The choice between softer and more rigid monofins was investigated with 9 elite level athletes (European champions and national team members) (age: 19,2±3,67; height: 174,9±5,53; weight: 70,7±7,21) in random order of 4 times 50 meters with soft and rigid monofin. Rest interval between swimming bouts was 15 minutes. Repeats were filmed with a moving underwater camera on the rails at sampling frequency of 50 frames/second. Custom video analysis program was used for analysis registering following parameters: swimming time, stroke rate, distance per stroke, speed per stroke.

Results: Analysis of variation revealed that stroke rate decreased statistically significantly ($p < 0.05$) near stroke 19 (CI: 16-26) that was not dependent on the rigidity of the monofin. However, on the average the tempo computed as strokes per minute per every registered stroke with more rigid monofin was regularly higher ($p < 0.05$) by 2.6 beats/min (CI: 0.76-4.57) throughout the 50m distance.

Conclusion: Pattern of fatigue as a fall in stroke rate was similar in both types of fins, however the tempo of the stroke seems to be dependent on the rigidity of monofin that may need to be taken into account for example in the context of individual underwater swimming style or core strength.

Key words: Finswimming, monofin, stroke rate, rigidity

POSTURAL ADJUSTMENTS IN GAIT INITIATION DETECTED BY INERTIAL SENSORS

Jana Lobotková and Kristína Bučková

Institute of Normal and Pathological Physiology, Slovak Academy of Sciences, Slovakia

Purpose

In laboratory conditions, postural strategies during walking are traditionally measured by force platforms and assessed by parameters like ground reaction forces, center of pressure (CoP) displacement or centre of mass velocity. Recently, small and accurate body-worn sensors such as accelerometers and gyroscopes have been used to quantify gait and postural sway. Objective of this study was to evaluate anticipatory postural adjustments (APAs) of gait initiation in different step length conditions using inertial sensors.

Methods

Nine young adults (5F; mean age 27.3 ± 1.4 yrs) were instructed to start walking with their right leg. They executed first two steps to move forward in three conditions: taking normal, shorter and longer steps. Kinematic parameters of trunk motion in anteroposterior (AP) and mediolateral (ML) directions were measured by two MTx sensors (Xsens) located on sternum and lower back (L5), CoP from force plate was used as gold standard. We evaluated angular velocity and changes of linear velocity at upper and lower trunk in AP and ML planes. As the main characteristics, amplitudes of APAs (maximal trunk acceleration and angular velocity from each sensor) were compared.

Results

Postural changes during anticipatory phase of gait initiation were reliably detected by both inertial sensors. Trunk tilt in AP plane was variable between subjects and conditions, however mediolateral kinematics of trunk was very similar to CoP displacement. All parameters revealed significant differences through tested conditions. Trunk motion during anticipatory phase was consistent with CoP in direction of movement, only the angular velocity of upper trunk tilt in ML plane was contrary to CoP shift. By inertial unit attached to L5, we observed two different kinds of anticipatory adjustment of lower back.

Conclusions

These results suggest that feasibility of inertial sensors is improved through the significant differences in gait initiation parameters which can distinguish between variant postural tasks, even in such a slight different conditions like the normal, shorter and longer steps are. Data analysis from body-worn sensors on the trunk could be promising source of information about changes in motor behaviour during the initiation of walking.

Supported by VEGA grants No. 2/0138/13 and No. 1/0373/14

ONLINE STEP ADJUSTMENTS DURING UNEXPECTED TRIPPING

Zrinka Potocanac¹, Jaap van Dieën², Sabine Verschueren¹, Jacques Duysens¹ and Mirjam Pijnappels²

¹*KU Leuven, Belgium*

²*VU University Amsterdam, Netherlands*

Purpose

With an aging society it is increasingly important to understand why older people fall. Tripping over obstacles is one of the main causes of falls and older adults have been shown to have an impaired ability to reduce the forward angular momentum that the body obtains from impact with the obstacle. Tripping response adjustments have been shown to occur when a trip is anticipated (Wang et al. 2012) 11-cm in height, in the path of over ground walking during the mid-to-late left swing phase. Although none of the subjects fell on the first of eight unannounced, consecutive trips, all of them had to rely on compensatory step with a step length significantly longer than their regular to reduce their instability. In the subsequent trials, they were able to rapidly make adaptive adjustments in the control of their center-of-mass (COM), but were never studied systematically. This is important however as it may occur that after tripping one needs to avoid landing on a dangerous surface. We therefore aimed to investigate the ability of young adults (YA) to adjust their recovery foot landing position after an unexpected trip by avoiding a virtually presented forbidden landing zone (FZ). We hypothesized that YA would be able to adjust their recovery steps, and that the rate of successful FZ avoidance would improve over trials. Additionally, we evaluated the characteristics of the adjusted steps and their consequences for balance recovery.

Methods

Sixteen healthy YA (25±3 years) walked at their comfortable speed over a walkway equipped with 14 hidden obstacles. Subjects were tripped 10 times in between a random number of normal walking trials. Five of the trips included a presentation of a FZ at trip onset, positioned at the subject's preferred recovery foot landing position, hereby forcing subjects to adjust their response in order to avoid landing on the FZ. RESULTS: Subjects succeeded to avoid the FZ in 80% of trials, using either shortened steps (84%) or stepping to the side of the FZ (16%). Their performance improved over trials, and some subjects even switched strategies over trials. These step adjustments had only minor effects on the body's angular momentum at and following recovery foot landing. CONCLUSIONS: YA are able to adjust their tripping responses without negative consequences on balance recovery. Future studies should address these issues in older adults to indicate possible clinical implications for fall prevention training.

References

1. Wang T-Y, Bhatt T, Yang F, Pai Y-C (2012) Adaptive control reduces trip-induced forward gait instability among young adults. *J Biomech* 45:1169–75.

EFFECTS OF SUGGESTED EXERCISES OF SENSITIVE – MOVEMENT REALIZATION DEVELOPMENT AND RESPONSE SPEED IN PERFORMANCE ACCURACY OF SOME OVERHEAD KICKS FOR YOUTH BADMINTON

Wisam Salah and Talib Hussein

Karbala University, Iraq

Abstract

The problem of research has been centralized in that most youth players are suffering from a weakness in some special realization of badminton game (realizing of dimension, time , strength and direction), and the speed of movement response, whom in return are effecting the accuracy of attacking skills performance in Badminton , because that the identifying and realizing of motives help the player to prepare movement programs inside the brain which lead to a fast response, the aim of research is to prepare exercises for the developing of sensitive – movement realizing and the speed of response in the accuracy of some attacking skills for youth in badminton. And identifying the effects of suggested exercises for the developing of sensitive – movement realizing and the speed of response in the accuracy of some attacking skills for youth in badminton. The two researcher used the experimental course in designing of (the two efficient groups with the pre and post test) since it fits the nature of the problem and to achieve the goals of research. The sample of research has been represented by whole research group whom are youth Team players of Babylon Governorate for the season 2011 – 2012, they are (6) players in ages of (13-15) years. The conclusions of research have been as follows:

The exercises of sensitive – movement realization helped to develop the accuracy of most overhead kicks in badminton. The exercises of response speed helped to develop the accuracy of most overhead kicks in badminton and that the exercises of sensitive – movement realization and response speed helped the individuals of experimental group to understand and realize most motives regarding badminton game and the speed of movement response availability of these motives. The exercises of sensitive – movement realization and speed of response helped experimental group individuals to provide the greatest number of movement programs for a skill which led to the easiness of facing most playing conditions and response to them.

THE IMPORTANCE OF A WELL BALANCED STRENGTH TRAINING PROGRAM IN DIFFERENT SPORTS IN YOUTH FOR LOWER EXTREMITIES

Andi Spahi, Juel Jarani and Agron Kasa

Sports University of Tirana, Albania

Isokinetic dynamometry offers diverse advantages, in the evaluation and treatment of muscle performance and helps athletic trainers setting suitable targets for appropriate strength programs. The aims of this study were: to evaluate the isokinetic parameters of maximal power for the knee extensor (KE) and flexor (KF) muscle in different sports groups of youth male: to judge whether it is a significantly differences between left and right extremities in three sports. Seventy four youth males (age = 17.4 ± 0.6 years, height = 1.76 ± 0.07 m, mass = 69.4 ± 7.8 kg) were tested for isokinetic strength of knee flexors and extensors using a Easytech (primaDOC) isokinetic measuring maximal power for the left and right foot. The group of players was splited according to sport into 3 subgroups – football (n = 26); basketball (n = 29); taekwondo (n = 19). The parameter evaluated was the isokinetic maximal power (MP).

The ANOVA results demonstrate that there was a significant difference in MP within the three group of players during both flexion and extension (right foot (dominant); $p < 0.001$ and left foot (non dominant); $p < 0.001$). The difference in MP among each sport categories between extremities was significant for non dominant leg flexors for basketball; $p < 0.001$, football; $p < 0.001$ and taekwondo; $p < 0.001$ compared to right flexors (dominant). However, no significant differences in MP among groups (sports) were observed for leg extensors.

In conclusions this results will contribute to the deepening of knowledge about changes in strength within sports and confirm the importance of applying well prepared strength program during systematic long-term sport preparation especially for non dominant extremities (flexors).

Key words: *maximal power, muscle balance, strength, flexors and extensors*

USING 6-POINT SCALE FOR ASSESSMENT OF HIP JOINT STRENGTH AND BALANCE ABILITIES IN PATIENTS TREATED WITH BIRMINGHAM HIP RESURFACING

Michał Wychowski¹, Jan Gajewski¹, Jacek Laskowski², Piotr Pietrzak¹, Michał Udvardy¹ and Andrzej Wit¹

¹Joseph Pilsudski University of Physical Education in Warsaw, Faculty of Rehabilitation, Poland

²Carolina Medical Center, Warsaw, Poland

Introduction

Hip replacement is most commonly used to treat joint failure caused by osteoarthritis. Birmingham Hip Resurfacing (BHR) resurfaces just 1 cm of bone, preserving the femoral head. In Carolina Medical Center, BHR method has been routinely used for 11 years.

The aim

Develop a unitless method for assessment of hip joint muscle force and balance control abilities.

Material

Reference data was obtained from a group of healthy, non-competitive students, without previous limb or spinal injuries, from the Joseph Pilsudski University of Physical Education in Warsaw. Patients surgically treated with BHR were tested on the apparatus for hip joint muscle strength measurement and tested on a stabilographic platform.

Methods

Force measurements were conducted on a self-made instrumented arm chair-apparatus with two strain gauge torque transducers. Hip joint muscle capacity was quantified in the main directions of flexion/extension, internal/external rotations and abduction/adduction. The TL of the COP was measured on the HUR made platform according to own protocol in a standing position, eyes open, eyes shut, standing on one foot (left and right), eyes open, then shut, every task lasting 30 s. We proposed the following requirements for the universal scale: several levels of evaluation, a simple verbal description of each level, names understandable for everyone, same method of evaluation for any parameters distribution. Model distribution obtained from young, healthy, population in the period of their best physical abilities (age 18 – 30 years).

Results

Mechanisms of postural control in patients operated with BHR were significantly weakened comparing to the group of healthy young people. There were no significant changes in balance abilities measured before surgery, 6 weeks later and 6 months after surgery. A low level of muscle strength in tested male subjects was observed.

Final remarks

Proposed method of assessing the human motor system is routinely used in Orthopaedic and Sport Medicine Clinic CMC for about 7 years. Using this six-point universal scale to assess functional parameters can be very useful in clinical practice and research.

Acknowledgement

Project “Biomechanical assessment of the human lower extremities function after surgical treatment of the hip joint” financed by NCN contract: UMO-2011/01/B/NZ7/05369



Physical Education

7th INTERNATIONAL SCIENTIFIC CONFERENCE ON KINESIOLOGY

FUNDAMENTAL
AND APPLIED
KINESIOLOGY – STEPS
FORWARD

Editors:
Prof. Boris Neljak, PhD
Dario Novak, PhD

Peer Reviewers:
Prof. Branislav Antala, PhD
Prof. Romana Caput Jogunica, PhD
Prof. Boris Neljak, PhD



SELF-MADE MATERIALS IN PHYSICAL EDUCATION CONTEXTS: AN INNOVATIVE COMPLEMENT TO INSTRUCTIONAL MODELS

Antonio Méndez-Giménez

University of Oviedo, Spain

This conference reviews the structural elements of an approach based on self-made materials and how it can foster and complement three of the most well-known instructional models in the physical education context: Tactical Games Model, Cooperative Learning, and Sport Education.

Over the last four decades, different authors have supported the idea of employing used or old materials to create equipment for physical education or re-creation. Pearson (1973) called them “inexpensive and innovative”. Others have described them as “improvised” (Bradtke, 1979), “low-cost” or “inexpensive” (Jackson & Bowerman, 2009; Werner & Simmons, 1990), but most of them refer to them as “homemade material or equipment” (Davis, 1979, Walkwitz, 2005). All these authors were talking about “found” (Davis, 1979), “thrown away” (Corbin & Corbin, 1983), “non-traditional” (Maeda & Burt, 2003) or “recycled” materials (Grigg, 2009) that are not difficult to adapt and use in physical education (Moss, 2004).

Many authors believe that homemade equipment should be constructed by those teachers who feel that they need extra materials to enhance their physical education programmes (Bradtke, 1979; Cowart, 1973; Davis, 1979; Jackson & Bowerman, 2009; Kozub, 2008; Maeda & Burt, 2003; Moss, 2004; Spire, Boggan, Rowen-Disedare & Kelley, 1995, Walkwitz, 2005). Other authors consider that these materials could be constructed both by teachers and students alike depending on how difficult the construction process seems to be (Corbin & Corbin, 1983; Grigg, 2009; Marston, 1994; Pearson, 1973; Werner & Simmons, 1990). In line with this perspective, our proposal moves from homemade to self-made materials. The rationale behind this change relies in the conviction that students, with the help of their teachers, peers or families if it is required, can benefit them at the physical, cognitive, affective and social levels actively participating in the construction process. Such involvement is in keeping with the Constructivist Theory of Learning.

From our point of view, there are six structural elements defining our self-made materials approach:

- a) *Constructionism*. The constructionist view of learning (e.g., Papert & Harel, 1991), a theory derived from the constructivist framework of Piaget, emphasizes the relevance of action in the process of learning, “learning by doing”. Papert (1987) argues that the construction of “artifacts”, either physical objects (such as soap sculptures or sand castles) or digital software is a facilitator of learning. Students forge their knowledge creating, experimenting with, modifying and analyzing the potentialities of these artifacts. Constructionism gives learners an active role in their learning. When the students attempt to design and build their objects, they face the dilemmas to resolve and make meaningful decisions. Historically, children have built their own toys from discarded objects they found around them. However, in today’s consumer society this traditional behavior has been replaced by the purchase of marketed toys, that unfortunately in too many cases, are sedentary. Compared to what happened with conventional material, the use of self-made materials develops deeper relationships and positive affects with the artifact, aspects that teachers can use to promote sport and physical activity.
- b) *Holistic process*. The self-made materials approach has got the potential to challenge the learner as a whole, and to develop the different dimensions of the person (cognitive, physical, artistic, affective and social) within a same integral project. Therefore, we find here an interesting via to address interdisciplinary projects, as well as multiple key competences (eg, learning to learn, social and civic, or autonomy and personal initiative).
- c) *Functionality*. This perspective also helps to solve a prevalent problem in physical education classes: the lack or scarcity of resources due to limited budgets. Nowadays, when the economic crisis is hitting hard, this framework is very useful and profitable for teaching. Unfortunately, this level of precariousness is found in many areas around the world. Hardman (2008) has reported that 50% of the teachers evaluated worldwide considered that the quantity of their physical education materials was “limited” or “insufficient”. In Africa (66%), Asia (53%), Central/Latin America (87%) and the Middle East (57%), the majority of teachers regarded their equipment as deficient. Authors such as Robinson and Melnychuk (2006, p. 8) consider that “activities are often inequitably chosen due to the absence of material resources”, which, in turn, affects students and their movement experiences. Therefore, the quantity and quality of a school’s equipment can detrimentally influence the excellence of its physical education curriculum.

Moreover, O'Really, Tompkins and Gallant (2001, p. 219) have observed that “for these teachers, the restrictions imposed by...insufficient equipment...were constant sources of frustration”. In many cases, large classes and/or the lack of enough equipment prevent children from having enough time to practice and improve their psychomotor skills. Furthermore, discipline and behavioral problems often appear when students have to wait in line for long periods of time because of a limited number of resources (Werner & Simmons, 1990). Nevertheless, as Maeda and Burt (2003, p. 32) have stated “costly equipment is not a prerequisite to elicit purposeful movement in children, nor is it a prerequisite for an effective movement program”.

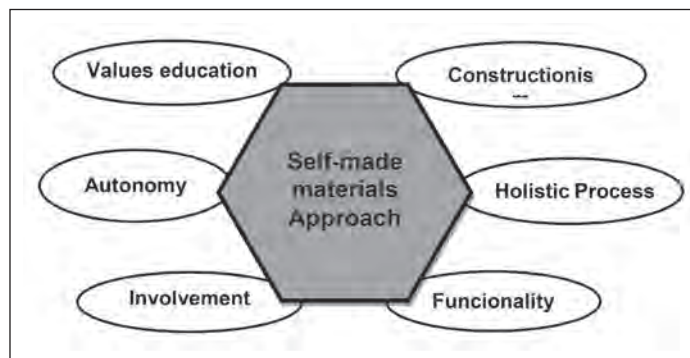

Figure 1: Structural elements of the self-made materials approach

- d) *Involvement*. The constructivist paradigm emphasizes the need to involve students in their own learning process (see the three tenets of constructivism: active, social, and creative learner in Perkins, 1999). Research shows that this active participation leads students to a greater retention, a deeper understanding, and a more active usage of knowledge (Perkins, 2006). Consequently, searching for the needed elements as well as building their own equipment for physical education, activates the students mentally, positively predisposes them toward its use, and also motivates them to become more active in and out of the school's setting. Students must be involved in construction tasks adjusted to their developmental level in order to increase their enjoyment, interest, mental activation, and predisposition to use the self-made materials. In addition, self-made equipment will allow each student to have his/her own piece of equipment. Thereby, maximizing involvement and participation, since every student will have many opportunities to explore a wide variety of movement patterns, and experience many different physical activities in and out of school.
- e) *Autonomy*. Having enough materials can help students increase their motor experiences in PE class but, at par, prolong free and autonomous physical activity practice in the school context. Indeed, one of the challenges of Physical Education is how to promote extracurricular physical and sport activities that require equipment (e.g., intercrosse, hockey, sticks ...) if practice depends on the available resources of the schools. Too many times learners face many difficulties to practice these games in formal or leisure time due to the lack of materials. The self-constructed materials approach breaks the dependency's cycle of school materials and enables students with resources to undertake extracurricular activities.
- f) *Values education*. Finally, this approach is supported on educational intentions and the development of values and attitudes is pretended. Values such as recycling, respect for the environment, respect for own and other goods, consumer education, or the promotion of an open mind to share artifacts are emphasized in this model. The idea of raising ecological awareness in the school's community (i.e. students, teachers and parents) through the recycling of materials and their use in class is also promoted. As Marston (1994, p. 46) has clearly pointed out: "If children learn to make a connection between improvised equipment and their enjoyment of movement, they may become more sensitive, and responsible, to environmental concerns". Thus, the goal would be to increase the students' consciousness of the physical environment, so they could become sustainability orientated (Grigg, 2009).

In short, the use of self-made materials in educational contexts holds many different advantages: they can increase students' participation time, they can be adapted to fit each student's needs, they are low cost, they promote students' creativity, they motivate students, they engage students and their families in the students' learning process, and they allow for multidisciplinary projects (Fernández-Río & Méndez-Giménez, 2011). However, this type of resources also presents some obstacles: extra space is needed to store the products, safety can also be an issue when using any type of resources, and extra time is needed to construct the self-made materials (Méndez-Giménez, 2003).

Ways to link instructional models with the approach based on self-made materials in Physical Education

In this part of the conference, we present several ways to connect three prominent instructional models (Metzler, 2005) with our approach based on self-made materials:

1. Hybridization between Tactical Games Model (TGM) and the Self-made Materials Approach (SMM).

Griffin, Mitchell and Oslin (1997; 2006) simplified the Teaching Games for Understanding model established by Bunker and Thorpe (1982). They proposed a three-step model called Tactical Games Games. In their proposal, students are faced with an initial modified game that provides them a positive experience. In the second stage, teachers try to develop the students' tactical awareness through reflexive tasks (questions and answers). In the third step, the students try to improve their performance through specially designed tasks. Finally, the learned skills are used in the initial game or an evolution of it through vertical transference. From our point of view, the key elements of the TGM are the following:

1. *The usage of a game classification with methodological and curricular implications.* This taxonomy includes 4 categories: target, striking/fielding, net/wall, and invasion games (Almond, 1986). It gives students a common reference that identifies similarities and differences among different games. Games belonging to the same category share similar tactical principals. Their understanding helps students transfer their game performance from one game to the other. Furthermore, teachers can show students how to transfer the knowledge obtained in a game to another game of the same category. For example, basketball and soccer are invasion games that share tactical principles with ultimate. Schools should let students experience each category throughout their school years. Nevertheless, teachers must also develop modified games to design developmentally appropriate activities for their students.
2. *Representation.* Modification/representation means that the games developed contain the same basic structure of the original adult game, but it is played with adaptations to fit the students' age, size and skill (Thorpe, Bunker y Almond, 1986). The key of the whole process is to design reduced and simplified games that represent a tactical problem, and motivates the students, too.
3. *Exaggeration.* When students have problems finding the solution to the modified game set by the teacher, it is possible to create a task where the tactical principle to learn is exaggerated to show it clearly to the students. For example: playing badminton in a long, but narrow court exaggerates the tactical problem of defending and attacking long and short shots such as the drop and the clear.
4. *Tactical complexity.* Games with a lesser tactical complexity should be the starting point for the development of a comprehensive games curriculum. Target games are the less complex, followed by the net/wall games, the striking/fielding games, and the invasion games, that should be introduced last to the students (Werner, Thorpe y Bunker, 1996). Children can move in and out of these categories developing an understanding of their tactical complexity. Nevertheless, there is a strong relationship between tactical complexity and exaggeration. A complex game can always be simplified tactically through exaggeration.
5. *Modified games as authentic contexts for assessment.* Students' assessment while playing a game is the most significant way of giving them formative feedback, while helping them develop skill and competency. Oslin, Mitchell, and Griffin (1985) designed and validated the *Game Performance Assessment Instrument* (GPAI) as a comprehensive tool that can be adapted to the different games of the taxonomy.

The SSM approach can strengthen and complement the Tactical Games Model in several ways;

Modification-representation. First, it is possible to produce materials that fit the developmental needs of students even better than marketed materials (smaller, lighter, softer, and so on). Therefore, teachers can modify adult sports and create games that represent the main tactical aspects within a particular category, but at the same time, simplifying the technical demands.

Diversification. Second, SMM approach allows the diversification of games from the same tactic category which will facilitate tactical learning generalization (Méndez-Giménez, 2003). For example, building hoops with cardboard and adhesive tape, and implementing a teaching unit for practicing ultimate could be a good way to address the generic invasion tactical principles that will be review later in a learning unit of basketball. Also, in a divided court games unit, PE teachers could start with some lessons or activities using cardboard paddles and paper balls before progressing to a more complex racquet unit.

Inventing games. Third, self-made materials could complement the framework of inventing games suggested by the Tactical Game Model and provide a more relevant range of experiences through low-cost materials (Méndez-Giménez & Fernández-Río, 2012). Deeping on this idea, students could also be challenged to invent different uses and/or games with these new available resources. In a recent research project on games invention, Hastie and André (2012, p.181) found that: "...having to construct equipment gave students a better understanding...about the interrelationship between, and functionality of various pieces of equipment". This newly acquired knowledge allows students to produce or invent games

that could fit their needs or interests. In the same investigation, Hastie and André (2012, p. 181) found that: “the requirement of equipment design provided a value-added element to the game design process”. Certainly, self-made materials seem to foster students’ creativity, which, in turn, can benefit the physical education class.

2. Hybridization between Cooperative Learning (CL) and the self-made materials (SMM) approach.

Johnson y Johnson (1999) pointed out five key elements in the cooperative learning model:

Face to face promotive interaction: it is crucial that teachers create a class climate that allows direct interaction among all group members.

Positive interdependence: this element emerges when students perceived that they need each other to reach the goals set for the group.

Individual accountability: each group member must be conscious of his/her responsibility within the group task. Without every person’s contribution, the group will be harmed.

Interpersonal skills: nowadays, it is evident that many students lack basic social relationship skills such as learning to listen to others, take turns, praise group-mates, share ideas... cooperative learning allows teachers to work on these skills.

Group processing: students must reflect on what has happened during the task, once it is completed. These reflexive experiences give them the opportunity to assess the strengths and weaknesses of the group to be successful.

Two papers (Fernández-Río & Méndez-Giménez, 2012; Méndez-Giménez y Fernández-Río, 2012) explore the use of self-made materials as a resource to enhance the possibilities of the Cooperative Learning Model. In our view, the process of construction and sharing equipment foster the five structural elements of Cooperative Learning in physical education.

Face-to-face promotive interaction. When students are challenged to build their own equipment in small groups (i.e., a cardboard “ringo”), they are encouraged to engage in a face-to-face interaction process that promotes communication, and the development of social skills at three different times: during the construction process, during the assessment of the materials, and while using them.

Positive interdependence. The essence of cooperative learning lies in the necessity of linking personal success with the success of partners either through common goals, shared resources, or complementary roles. Regarding this last issue, students can perform many different roles while constructing self-made equipment (i.e. information searcher, equipment manager, builder, presenter, or reviewer), and all of them lead to positive interdependence among group members.

Individual accountability. The challenge of cooperating to construct equipment develops each student’s individual accountability, because they have to create low-cost, safe, and efficient equipment for their group. If the final product is ineffective, the group will be penalized, and no one wants to hurt his/her group.

Interpersonal skills. Social skills such as learning to transmit information, listening carefully, making eye contact with the speaker, sharing ideas and decisions, working together, or giving and receiving feedback can be taught to students and practiced through the construction or the evaluation process.

Group processing. Students should systematically reflect on the quality of the equipment they have developed, and teachers must create opportunities for this to happen. It is important that students have the opportunity to share ideas, to discuss possible solutions, or to brainstorm problems that the group has faced while constructing and/or using the materials that they have made. Teachers and students should also decide if the material has been worn out during the sessions, and decide if it must be repair *in situ* or after the session. Finally, those teachers who have used self-made equipment in their physical education classes highlight the potential of these materials to extend physical activity “beyond the gates of the school”. Certainly, this is very important if we want our school subject to survive in this digital age.

3. Hybridization between Sport Education (SE) and the self-made materials (SMM) approach.

Sport Education is an instruction model designed to provide authentic, educationally rich sport experiences for students in the context of school physical education (Siedentop, Hastie, & van der Mars, 2004). Six are the key elements in this model:

Season. Siedentop (1994) argued that a curricular learning unit should represent a sport season. Therefore, it should last longer than traditional units. This way, the students could learn more contents, and they could have extra time to become competent sportspeople.

Affiliation. Students must work in persisting teams and small groups through the entire season. They wear team uniforms and develop their own team name and identity. Being an active member of a team allows the students to benefit from the opportunities of social development that it drives.

Formal competition. It is presented at the beginning of the learning unit, and it is developed interconnected with practical activities and tasks. Its goal is to allow students to participate in a championship within the physical education class. Learning tasks are more relevant to them, because they help students prepare the competition.

Record keeping. Siedentop (1998) believed that there are several reasons for registering students’ performance in matches: motivation, feedback, assessment, awareness of standards and traditions... The goal is to enhance students’

excitement, and help them establish new goals. Possible records include: percentage of shots on goal, number of assists, rebounds or steals, points scored by the team or each player... The usage of non-traditional roles such as journalist or statistician, and evaluation procedures such as co-assessment or shared assessment allow for a better record keeping.

Festivity. Sport seasons should be fun. Teacher and students should try to celebrate students' success. Possible ideas that could be used to create a festive atmosphere are: colorful uniforms, unique greetings for each team, an award ceremony, music everywhere, picture exhibition...

Culminating event. A final event (championship) must be organized at the end of the season in order to recognize students' achievements.

Finally, we think that the construction of materials can reinforce the Sport Education Model in three ways: First, in the development of small-sided games that fit the needs of the participants (see what I commented on the Tactical Games Model). Second, students could also make pets, flags, shields, banners, or shirts representing their team during the season. All these actions reinforce the feeling of *team affiliation*. And third, it can enhance the representative *festive atmosphere* of this model. For instance, each group could build a trophy that will be awarded at the end of the unit to emphasize different individual or collective values: fair play, sportsmanship, effort, companionship...

References

- Almond, L. (1986). Reflecting on themes: a games classification. En Thorpe, D., Bunker, D., y Almond, L. (Eds). *Rethinking Games Teaching*. Loughborough: Loughborough University, pp. 71-72.
- Bradtke (1979). Adaptive devices for aquatic activities. *Practical Pointers*, 3(1), 1-17.
- Bunker, D. y Thorpe, R. (1982). A model for the teaching of games in secondary schools. *Bulletin of Physical Education*, 18(1), 5-8.
- Corbin, E.C., & Corbin, C.B. (1983). Homemade play equipment for use in physical education class. *Journal of Physical Education, Recreation & Dance*, 54(6), 35-36-38.
- Davis, K.R. (1979). *Homemade equipment that can be used in teaching physical education classes*. Unpublished manual. 1-48.
- Davison, B. (1998). Creative physical activities and equipment. Building a quality program on a shoestring budget. Champaign, IL: *Human Kinetics*.
- Fernandez-Rio, J., & Méndez-Giménez, A. (2011). Self-made materials as a resource to enhance the cooperative learning model. In B. Dyson (coord.) Symposium: Cooperative learning in physical education: An international perspective. AIESEP International Conference, Limerick, 22-25th, June.
- Fernandez-Rio, J., & Méndez-Giménez, A. (2012). Cooperative Learning in Spain: Innovative Practice through Self-Made Materials. In B. Dyson & A. Casey (eds.) *Cooperative learning in physical education. A research-based approach* (pp. 42-56). London: Routledge.
- Griffin, L.L., Mitchell, S.A. & Oslin, J.L. (2006, 2nd ed.). *Teaching Sport Concepts and Skills. A tactical Games Approach*. Champaign: IL: Human Kinetics.
- Grigg, A. (2009). Trash balls, *Physical & Health Education Journal*, Autumn, 24-26.
- Hardman, K. (2008). Physical Education in schools: a global perspective. *Kinesiology*, 40(1), 5-28.
- Hastie, P.A., & André, M.H. (2012). Game appreciation through student designed games and game equipment. *International Journal of Play*, 1(2), 165-183.
- Jackson, D.J., & Bowerman, S.J. (2009). Development of Low Cost Functional Adaptive Aquatic Equipment. *TAHPERD Journal. Fall Issue*, 8-10.
- Johnson, D. W., & Johnson, R. T. (1999). *Learning together and alone: Cooperative, competitive, and individualistic learning* (5th ed.). Boston: Allyn & Bacon.
- Maeda, J.K., & Burt, T. (2003). Inexpensive equipment preschool movement activities. *Teaching Elementary Physical Education, March*, 32-34.
- Marston, R., (1994). Constructing equipment from recycled materials. *Journal of Physical Education, Recreation & Dance*, 65(8), 44-46.
- Méndez-Giménez, A. (2003). *Nuevas propuestas lúdicas para el desarrollo curricular de Educación Física. Juegos con material alternativo, juegos predeportivos y juegos multiculturales*. Barcelona: Paidotribo.
- Méndez-Giménez, A., & Fernández-Río, J. (2010a). Efectos del uso de materiales autoconstruidos sobre la satisfacción, el aprendizaje, las actitudes y las expectativas del alumnado de magisterio de la asignatura Juegos Tradicionales. *Proceedings International Congress AIESEP*, A Coruña 26-29th, October.
- Méndez-Giménez, A. & Fernández-Río, J. (2010b). The use of homemade materials to enhance constructivist learning within the Sport Education-Tactical Games Model: the case of an ultimate learning unit. *Proceedings International Congress AIESEP*, A Coruña, 26-29th, October.
- Méndez-Giménez, A. & Fernández-Río, J. (2011). Homemade equipment as an educational tool in a group of students enrolled in a physical education teacher education program. *Proceedings AIESEP International Congress*, Limerick, 22-25th, June.

21. Méndez-Giménez, A., Martínez-Maseda, J., & Fernández-Río, J. (2010). Impacto de los materiales autoconstruidos sobre la diversión, aprendizaje, satisfacción, motivación y expectativas del alumnado de primaria en la enseñanza del paladós. *Proceedings International Congress AIESEP*, A Coruña, 26-29th, October.
22. Metzler, M.W. (2005). *Instructional models for physical education* (2nd ed.). Scottsdale, AZ: Holcomb Hathaway.
23. Moss, D. (2004). *Sports and Physical Education equipment you can make yourself*. Ontario, Canada: Physical Education Digest.
24. O'Really, E., Tompkins, J. & Gallant, M: (2001). They Ought to Enjoy Physical Activity, You Know? Struggling with Fun in Physical Education. *Sport, Education and Society*, 6(2), 211–221.
25. Oslin, J. L., Mitchell, S. A. & Griffin L. L. (1998). The Game Performance Assessment Instrument (GPAI): Development and Preliminary Validation. *Journal of Teaching in Physical Education*, 17(2), 231-243.
26. Papert, S. (1991). Situating Constructionism. In I. Harel & S. Papert (eds.) *Constructionism* (pp. 5-23). Norwood, NJ: Ablex.
27. Papert, S. y Harel, I. (1991). *Constructionism. Chapter 1: Situating Constructionism*. New York: Ablex Publishing Corporation.
28. Pearson, L.R. (1973). *Guide for homemade innovative play equipment for activities in physical education and recreation for impaired, disabled, and handicapped participants*. Washington, D.C: American Association for Health, Physical Education, and Recreation.
29. Perkins, D. (1999). The many faces of constructivism. *Educational Leadership*, 57, 6-11.
30. Perkins, D. (2006). Constructivism and troublesome Knowledge (Chapter 3). In Jan Meyer & Ray Land (Eds.) *Overcoming barriers to student understanding: Threshold Concepts and Troublesome* (pp. 33-47), Routledge, Taylor & Francis Group.
31. Robinson, M., & Melnychuk, S. (2006). A call for physical education consultants and specialists: Let's get serious about implementing quality physical education. *Physical & Health Education, Autumn*, 6-11.
32. Spire, R., Boggan, J., Rowen-Disedare, R., & Kelley, D.R. (1995). Need equipment? Organize a make-it/take-it workshop. *Journal of Physical Education, Recreation and Dance*, 66(7), 10-13.
33. Thorpe, R., Bunker, D. & Almond, L. (Eds.). (1986). *Rethinking games teaching*. Loughborough: University of Technology.
34. Werner, P., Thorpe, R, & Bunker, D. (1996). Teaching games for understanding: Evolution of a model. *JOPERD*, 67, 28-33.
35. Werner, P., & Simmons, R. (1990). *Homemade play equipment*. Reston, VA: American Alliance for Health, Physical Education Recreation and Dance.

INTERNATIONAL ORGANISATIONS AND NETWORKS AND THEIR INFLUENCE TO THE DEVELOPMENT OF PHYSICAL EDUCATION IN THE WORLD

Branislav Antala

*Comenius University in Bratislava, Faculty of Physical Education and Sports, Slovakia
FIEP Europe President*

The paper will be separated in three parts:

Sedentary lifestyle and physical inactivity as a global problem

Intensified competition in world markets, religious conflicts, issues of war and peace, violations of fundamental human rights and freedoms, corruption, unemployment, natural disasters, pollution of the natural environment, lack of food and drinking water, extreme nationalism, terrorism, increased violence and crime, drugs and non-communicable diseases - these are the most serious global problems of today's world. The explosion of information and the development of information and communication technologies contribute to other serious worldwide problems – sedentary life styles and physical inactivity of people, all with related health, economic and social consequences.

Global physical education projects and networks

The last 30 years have seen the publication of a plethora of international documents concerned with school physical education and sport: Charters (UNESCO *International Charter of Physical Education and Sport*, 1978; Council of Europe's *European Sports Charter*, 1992; and PANHALON *Charter of Children's Sport Laws*, 1995); Declarations (EUPEA's *Declaration of Madrid*, 1991; UNESCO Conference of Minister's *Declaration of Punta del Este*, 1999, *Berlin Declaration*, 2013); Manifestos (FIEP *World Manifesto of Physical Education*, 2000); Resolutions (European Parliament's *Resolution on the Role of Sport in Education*, 2007); Policy and Position Statements (European Commission's *White Paper on Sport*, 2008, ICSSPE *Position Statement on Physical Education*, 2010);

Physical education and school sport has also been and will be the main theme of different international events: International Conferences of Ministers and Seniors Officials Responsible for Physical Education and Sport - MINEPS (Paris, 1976; Moscow, 1988; Punta del Este, 1999; Athens, 2004; Berlin, 2013); World Summits on Physical Education (Berlin, 1999; Magglingen, 2005) at which findings of two UNESCO Worldwide School Physical Education Surveys; World Forums of Physical Education (Havana, 2010; 2012; 2014); Global Forums on Physical Education Pedagogy (USA, 2010; Germany, 2012, South Africa 2014); International Forums of Physical Education and Sport Science (India, 2013)

Good examples of international networks are also different international projects (for ex. "Brain Breaks" of HopSports) or publications (for ex. "Physical Education and Health – Global Perspectives and Best Practice", Sagamore Publishing, 2014).

International organisations and its contribution to the development of cooperation and understanding in today's world

International organizations are actively addressing these current problems of the world. There is cooperation between sports organizations and federations (IOC, FIFA and others), those working in the field of physical education (PE), sport education and physical activity promotion, especially for children and youth. Example could be ICSSPE. ICSSPE occupies a position, as an umbrella organization bringing together 300 international and national bodies. ICSSPE activities are include publication of scientific books (Directory of Sport Science; Sport Science Studies) and journal (Bulletin ICSSPE); organisation of multi-disciplinary congresses and conferences serving both scholars and practitioners (eg MINEPS V, 2013; Communities and Crisis, 2013); making scientific awards to researchers and scholars (The Philip Noel-Baker Research Award); preparing policy documents (International Position Statement on Physical Education 2010; Berlin Declaration, 2013); supporting research projects (eg Quality of Physical Education and Sport).

Good example of successful cooperation between international bodies is ICSSPE's International Committee of Sport Pedagogy (ICSP). It brings together representatives of six world's largest organizations from the field of PE (FIEP, IFAPA, IAPESGW, ISCPES, AIESEP and ICCE). ICSP worked on several common projects such as preparation of the "International Position Statement on Physical Education", international "Benchmarks for Physical Education" and assistance for UNESCO's Guidelines on Quality Physical Education for Policy Makers; and 4 of the organisations participated in the project "Global Voices on Quality of Physical Education and Sport".

In 2012, Nike, ICSSPE and ACMS launched a global report "Designed to Move" (DTM) (www.designedtomove.org) which focused on the need to increase levels of physical activity among children and young people. DTM has two principal aims: to create early positive experiences with movement activities for children; and to integrate physical activity into everyday life.

DIFFERENCES IN MOTOR ABILITIES OF PUPILS ACCORDING TO NUTRITIONAL STATUS

**Marko Badrić¹, Goran Sporiš¹, Ivan Prskalo¹, Zoran Milanović², Ivan Krakanić¹, Zlatko Šafarić¹,
Zvonko Miljković³ and Saša Pantelić²**

¹*Faculty of Teacher Education, University of Zagreb, Zagreb, Croatia*

²*Faculty of Sport and Physical Education, University of Niš, Niš, Serbia*

³*Mechanical Engineering Faculty in Slavonki Brod, J. J. Strossmayer University of Osijek*

Abstract

The level of motor abilities strongly affects optimum growth and development of children, as well as their health. In order for the motor abilities to reach an optimum level, children need to have regular and continual physical exercise. Therefore, the aim of this study was to determine differences in motor abilities of pupils with regard to their nutritional status. The sample of subjects was composed of 434 primary school boys aged 11-14. Subsamples defined by age were divided into two subsamples: 11-12 years (11.77 ± 0.69) 224 pupils, 13-14 years (13.66 ± 0.64) 210 pupils. Sample of variables in this study consisted of 15 motor ability tests. Two morphological anthropometry tests were used to measure the body height and body weight of each pupil. Based on the calculated body mass index (BMI), subjects were classified into three groups according to the nutritional status: normal body weight, overweight and obese. The results showed that over 28% of pupils were overweight. Looking at the age of the subjects, it can be seen that the prevalence of obesity is higher at a younger age group (15%) compared to the older boys (8%). Significant differences in motor abilities were measured in both subsamples between the three groups of subjects of different nutritional status. Research results indicate that boys who are obese have less developed motor abilities. The biggest differences were measured with respect to the abilities that require mobility of the body, including the lifting of the body or moving the body.

Key words: body mass index, school, physical activity, pupils, motor abilities

Introduction

Obesity is one of the main causes of numerous health conditions. Recent research has shown the trend of the increase in obesity from an early age (Chinn & Rona, 2001; Krebs & Jacobson, 2003; Ogden, Flegal, Carroll, & Johnson, 2002; Wang, Monteiro, & Popkin, 2002), and a number of studies have found a negative correlation between the level of physical activity and obesity (Bordin, De Giorgi, Porqueddu, Zanon, & Rigon, 1995; González-Gross et al., 2003; Lazzer et al., 2003; Moreno, Mur, & Fleta, 1997; Mota, Santos, Guerra, Ribeiro, & Duarte, 2002). Obesity has become one of the greatest challenges facing the public health sector and the strategies for the prevention and elimination of obesity have become one of its top priorities (Hill & Wyatt, 2005). The increase in the prevalence of overweight and obese children in developed countries (Bundred, Kitchiner, & Buchan, 2001; Ebbeling, Pawlak, & Ludwig, 2002; Lobstein, Baur, & Uauy, 2004), in combination with the growing proportion of children who do not meet the minimum physical activity level recommendations are a cause for concern in the public health sector (Lopes, Lopes, & Pereira, 2009).

Sedentary lifestyle is one of the main factors of the surge in obesity (Andersen, 1999). Sedentary lifestyle typically involves extended periods of viewing television and using computers and other ICT gadgets. Obesity is one of the main causes of the type 2 diabetes in children (Wang & Lobstein, 2006) and a risk factor in the development of coronary diseases, high cholesterol level and high blood pressure (Westcott, 2006). In order to understand obesity and address this problem it is necessary to be familiar with the concept of energy balance. Weight gain eventually leading to obesity is the result of the energy imbalance (Zahner et al., 2006) in which energy intake exceeds energy expenditure over a period of time. Similarly, the loss of weight can only be achieved if the expenditure of energy is higher than the intake of energy over a period of time. Finally, when there is a balance between energy intake and expenditure, the body weight remains constant (Hill & Wyatt, 2005). Body mass index (BMI), defined as the individual's body mass divided by the square of their height, is used in the epidemiological approach as an obesity measure unit for children and adults, adopted by the World Health Organization (Barlow & Dietz, 1998; Cole, Bellizzi, Flegal, & Dietz, 2000; Mišigoj-Duraković, Borms, Duraković, & Matković, 2008). A large body of research has proven a correlation between a high BMI in childhood and a high BMI in adolescence (Campbell et al., 2001; Janssen et al., 2005).

Physical activity has remained a crucial stimulus required for the maintenance of the organ and body structures and functions. Most, if not all, adaptive changes caused by physical activity of a certain regularity and intensity have a positive effect on health, improving the structural and/or functional abilities of the corresponding organ (Vuori, 2004).

Insufficient level of physical activity of any form has an effect on the individual's health status (Mišigoj-Duraković, 1999). When starting school, children are adopting a lifestyle involving a reduced level of physical activity. Physically inactive children face the risk of a reduced level of motor and functional abilities as well as an increased body mass and the body fat proportion. Physical inactivity, especially the time children spend watching television, playing video games and sitting in front of e-media, are all important factors in obesity development (Mišigoj-Duraković & Duraković, 2005).

The level of motor abilities strongly affects optimum growth and development of children, as well as their health. In order for the motor abilities to reach an optimum level, children need to have regular and continual physical exercise. Such physical activity would help boost the level of motor abilities as well as other abilities and characteristics to the level necessary to maintain health (Badrić, 2011).

Considering the significant role physical exercise has in the body mass regulation and the development of functional and motor abilities in children, and in the light of the fact that people whose functional abilities were higher in adolescence remain relatively more active in adulthood, we become aware of the role that physical education in school, and in the period before school, has in the development of, primarily, a positive attitude to exercise and the habit of regular exercise, as well as in the development of functional and motor abilities (Mišigoj-Duraković et al., 2008).

The aim of this study was to determine the differences in motor abilities of pupils of different nutritional status.

Methods

Participants

The sample of 434 primary school boys was used. The sample was divided into two subsamples based on subjects' age: 224 subjects aged 11 – 12 (mean 11.77±0.69) and 210 subjects aged 13-14 (mean 13.66±0.64). For the age group 11 – 12 the average values for the height were 155.18±9.22, the body mass 49.53±13.99, and the body mass index 20.31±4.32. For the age group 13 – 14, the average values for the height were 166.55±8.05, the body mass 59.33±13.09, and the body mass index 21.28±3.94. All of the pupils were healthy. The research was conducted in accordance with the Ethical Codex for Research with Children, a document compiled by the Council for Children, an advisory body of the government of the Republic of Croatia. A signed parental consent for the participation in the research was obtained for each subject. The sample comprised pupils from the Primary School "Dragutin Tadijanović" and the 1st Primary School in Petrinja, and the Primary School "Braća Ribar" and the Primary School "Ivan Kukuljević Sakcinski" in Sisak.

Procedure

The sample of variables consisted of 15 motor ability tests and two measurements of morphological characteristics. Body mass index was calculated by dividing the body mass by the square of the body height. Based on the calculated body mass index and the International Obesity Task Force body mass index tables (Cole et al., 2000), the subjects were divided into three categories with respect to their nutritional status: normal body mass, overweight and obese. In the domain of morphological anthropometrics, the body height and mass of each pupil were measured. All measurements were carried out using standard procedures as described in the guidelines for the International Biological Programme. *Motor abilities* were measured using the 15 motor ability tests. The following tests were used to measure *simple movement speed*: 1) Hand-tapping 2) Foot-tapping 3) Foot-tapping against the wall. The following tests were used to measure *explosive power*: 1) Horizontal jump; 2) Medicine ball throw while lying on the back; 3) 20 meter sprint from the standing position. The following tests were used to measure *repetitive power*: 1) Sit-ups; 2) Back extensions; 3) Squats. The following tests were used to measure *coordination*: 1) Obstacle course – backwards; 2) Side steps; 3) Zigzag run. The following tests were used to measure *flexibility*: 1) Sit and reach; 2) Forward bend on the bench; 3) Back reach along the pole. The measurements for each test were repeated three times, with the exception of repetitive power tests, which were performed only once. A detailed description of the tests is available in the doctoral thesis (Badrić, 2011).

Statistical analysis

The obtained data were analysed using the programme STATISTICA (data analysis software system), version 7.1. The basic descriptive parameters for all tested variables were calculated: the arithmetic mean (AM) and the standard deviation (SD). The normality of variable distribution was tested using the Kolmogorov-Smirnov test. The significance of the differences between subsamples was tested using the multivariate analysis of variance (MANOVA). Statistical significance of the differences was tested at the significance level $p < 0.05$.

Results

Table 1 shows the percentage of pupils in each of the three nutritional status categories. Results show that there were more pupils of normal body mass in the older age group, whereas the percentage of obese pupils was higher in the younger age group (14.73%) as compared to the older age group (8.09%). In the total sample of pupils aged 11 – 14, more than 28% of pupils were overweight.

The multivariate analysis of variance (MANOVA) in Table 2 shows a statistically significant difference in the multivariate space of analysed variables of both subsamples in motor abilities between the three nutritional status groups. Table 3 shows descriptive parameters for pupils aged 11 – 12. The results indicate that the pupils with a normal mass achieved better results in almost all measured motor abilities than the overweight and obese pupils. The results of the univariate analysis of variance (ANOVA) show statistically significant differences between the three nutritional status groups of pupils for almost all variables, with the exception of flexibility variables (sit-reach, forward bend on the bench and back reach test) and the hand-tapping variable. In the med-ball-throw variable, measuring the explosive power of the arms and shoulders, the obese pupils achieved significantly better results.

Table 4 shows descriptive parameters for pupils aged 13 – 14. The results suggest that the pupils with the normal mass achieved better results in almost all measured motor abilities than the overweight and obese pupils. As in the younger age group, the results of the univariate analysis of variance (ANOVA) do not show statistically significant differences between the three nutritional status groups of pupils only in the variables measuring flexibility (forward bend on the bench and back reach test), the hand-tapping variable and the med-ball-throw variable, measuring the explosive power of the arms.

Table 1: Percentage of pupils according to nutritional status

	Normal body mass	%	Overweight	%	Obese	%
Age 11 and 12	155	69.20	36	16.07	33	14.73
Age 13 and 14	156	74.29	37	17.62	17	8.09
TOTAL	311	71.66	73	16.82	50	11.52

Table 2: Results of multivariate analysis of variance (MANOVA) in motor abilities according to nutritional status of pupils

	Wilks' Lambda	F	Effect df	Error df	p-level
Age 11 and 12	0.3803	8.5786	30	414	0.0000
Age 13 and 14	0.4288	6.7823	30	386	0.0000

Table 3: Descriptive statistical parameters for pupils aged 11 – 12 and the results of the univariate analysis of variance (ANOVA)

	Normal N=155		Overweight N=36		Obese N= 33		ANOVA	
	Mean	SD	Mean	SD	Mean	SD	F	p
Obstacle course - backwards	13.10	2.93	15.89	3.50	19.15	5.54	44.03	0.00
Side steps	10.76	1.35	11.31	1.30	11.85	1.67	9.33	0.00
Zigzag run	7.69	0.58	8.31	0.57	8.73	0.82	46.31	0.00
Forward bend on the bench	21.86	6.20	20.31	6.43	19.85	7.68	1.85	0.16
Sit-reach	52.75	10.78	50.61	13.29	50.97	13.78	0.68	0.51
Back reach test	24.37	8.74	27.69	7.74	25.27	7.02	2.33	0.10
Hand-tapping	28.90	3.52	29.72	3.90	28.06	3.27	1.89	0.15
Foot-tapping	21.87	2.27	21.36	2.55	20.42	1.85	5.74	0.00
Foot-tapping against the wall	22.98	4.19	22.08	2.74	20.79	3.84	4.45	0.01
Horizontal jump	174.31	21.39	159.50	23.20	145.39	21.37	27.23	0.00
20m run	3.87	0.31	4.23	0.30	4.34	0.44	38.38	0.00
Med-ball-throw	655.90	139.39	715.81	138.16	753.61	104.52	8.68	0.00
Sit-ups	38.46	7.36	33.14	7.90	30.12	7.77	20.80	0.00
Squats	41.83	11.37	31.39	13.12	26.91	12.10	28.55	0.00
Back extensions	37.49	12.92	30.08	15.80	21.91	12.91	20.19	0.00

Table 4: Descriptive statistical parameters for pupils aged 13 - 14 and the results of the univariate analysis of variance (ANOVA)

	Normal N=156		Overweight N=37		Obese N= 17		ANOVA	
	Mean	SD	Mean	SD	Mean	SD	F	p
Obstacle course - backwards	11.23	2.50	12.09	2.15	17.28	4.67	39.35	0.00
Side steps	10.27	1.44	10.74	1.31	11.70	1.19	8.83	0.00
Zigzag run	7.57	0.63	7.92	0.64	8.66	0.64	24.96	0.00
Forward bend on the bench	23.12	7.91	25.16	6.20	21.00	7.75	1.92	0.15
Sit-reach	58.19	12.73	57.49	12.55	50.24	10.77	3.08	0.05
Back reach test	34.37	9.69	33.57	7.45	33.41	10.86	0.16	0.85
Hand-tapping	32.80	4.13	32.65	3.47	31.47	3.37	0.86	0.42
Foot-tapping	23.17	2.33	22.73	2.24	20.88	1.90	7.85	0.00
Foot-tapping against the wall	26.13	4.52	26.38	3.46	22.24	2.28	6.88	0.00
Horizontal jump	197.04	23.94	182.24	23.31	154.41	25.49	27.27	0.00
20m run	3.69	0.34	3.87	0.50	4.41	0.40	29.58	0.00
Med-ball-throw	894.72	192.68	957.73	158.13	901.71	196.87	1.69	0.19
Sit-ups	41.54	9.82	38.54	11.01	34.06	7.57	5.19	0.01
Squats	41.96	12.32	35.27	14.37	29.59	10.83	10.28	0.00
Back extensions	43.92	13.60	40.00	13.60	29.59	15.03	8.88	0.00

Discussion

The results point to significant differences in motor abilities of male pupils aged 11 – 14 of different nutritional status. Differences were observed both in the younger age group (11 – 12) and the older age group (13 – 14). The study showed that a relatively high percentage of male pupils aged 11 – 14 (28%) are either overweight (17%) or obese (11%). Similar results were obtained by the other studies (Casajús, Leiva, Villarroya, Legaz, & Moreno, 2007; Delaš, Tudor, Ružić, & Šestan, 2008; Mamalakis, Kafatos, Manios, Anagnostopoulou, & Apostolaki, 2000; Wang & Lobstein, 2006). Smaller percentages of obese boys were identified in the large number of studies (Antonić-Degač, Kaić-Rak, Mesaroš-Kanjški, Petrović, & Capak, 2004; Huerta et al., 2010; Khasnutdinova & Grjibovski, 2010; Koezuka et al., 2006; Lazzeri et al., 2008; Planinšec & Fošnarič, 2009). When comparing the two age groups, the percentage of obese pupils is higher in the younger group (15%) compared to the older group of male pupils (8%). The results of multivariate analysis of variance for both age groups show significant differences in motor abilities of the three nutritional status groups, i.e. significantly poorer results in motor ability tests of overweight and obese pupils. Considering the partial differences in motor abilities, the univariate analysis shows significant differences in tests of coordination, explosive power, repetitive power, and partially in the simple movement frequency tests, whereas no significant differences were observed in flexibility tests. As expected, the overweight and obese pupils did not score well in tests requiring mobility and lifting of one's own body. Similar results were obtained by Graf et al. (2003) and Casajús et al. (2007). The results for the age group 13 – 14 clearly show that the overweight and obese male pupils achieved significantly poorer results in coordination and repetitive power tests, and in some of the explosive power tests. It is interesting to notice that, as in the younger age group, the overweight and obese boys in the older age group also achieved better results in the medicine ball throw test, measuring the explosive power of arms. The pupils with a higher body mass achieved better results in this test, probably due to the fact that the lower part of the body remains still during this test and only the arms are employed in the performance of the test. As in the age group 11 – 12, no significant differences among the three nutritional status groups were observed in flexibility tests (Casajús et al., 2007; Deforche et al., 2003; Tokmakidis, Kasambalis, & Christodoulos, 2006).

The results obtained in this research confirm that the pupils of a normal body mass generally have a higher level of motor abilities than the overweight and obese pupils. Similar results were obtained in other studies carried out on these age groups (Deforche et al., 2003; Mak et al., 2010; Mamalakis et al., 2000). These results clearly suggest that everyday physical exercise is a predictor of the increase of the motor ability level, which in turn positively correlates with the body mass index (Biddle, Whitehead, O'Donovan, & Nevill, 2005; Koezuka et al., 2006; Wrotniak, Epstein, Dorn, Jones, & Kondilis, 2006). Therefore, everyday physical exercise is crucial in the body mass reduction, and this equally applies to both children and adults. Developing the habit of everyday physical exercise at an early age is a major factor in the preservation of health. Children who have a high level of motor abilities are more likely to be physically active in adolescence (Barnett, Van Beurden, Morgan, Brooks, & Beard, 2009; Raudsepp & Päll, 2006; Wrotniak et al., 2006). Taking up an additional physical activity has an unquestionable positive effect on the motor ability level (Casajús et al., 2007; Koutedakis & Bouziotas, 2003).

All of the above supports the argument that physical exercise has a vital role in the body mass regulation. It is clear that the improvement of motor and functional abilities cannot be achieved without regular everyday physical exercise. The development of motor skills is most intense in childhood, the period during which the basis for further motor development in adolescence is built. If a healthy habit of everyday exercise is developed in childhood, it is more likely that the person will continue to regularly exercise in adulthood.

Conclusion

The analysis shows that the obese boys achieved poorer results in motor ability tests. The differences in motor abilities were observed in both the younger and the older groups of male pupils. The biggest differences were measured with respect to the abilities involving the mobility of the body; whether the test required lifting the body or moving it. Finally, the study draws attention to the need for placing an emphasis on the early development of motor abilities and encouraging obese children to engage in physical activities as early as possible in order to preserve their health.

References

1. Andersen, R. E. (1999). Exercise an active lifestyle and obesity. *The Physician and Sportsmedicine*, 27(10), 41-43.
2. Antonić-Degač, K., Kaić-Rak, A., Mesaroš-Kanjski, E., Petrović, Z., & Capak, K. (2004). Stanje uhranjenosti i prehrabene navike školske djece u Hrvatskoj. *Paediatrica Croatica*, 48(1).
3. Badrić, M. (2011). *Povezanost kinezioloških aktivnosti u slobodnom vremenu i motoričkih sposobnosti učenika srednje školske dobi: doktorski rad*. M. Badrić.
4. Barlow, S. E., & Dietz, W. H. (1998). Obesity evaluation and treatment: expert committee recommendations. *Pediatrics*, 102(3), e29-e29.
5. Barnett, L. M., Van Beurden, E., Morgan, P. J., Brooks, L. O., & Beard, J. R. (2009). Childhood motor skill proficiency as a predictor of adolescent physical activity. *Journal of Adolescent Health*, 44(3), 252-259.
6. Biddle, S. J., Whitehead, S., O'Donovan, T. M., & Nevill, M. E. (2005). Correlates of participation in physical activity for adolescent girls: A systematic review of recent literature. *Journal of Physical Activity & Health*, 2(4), 421-432.
7. Bordin, D., De Giorgi, G., Porqueddu, Z. G., Zanon, A., & Rigon, F. (1995). Obesity, overweight and physical activity in elementary school children. *Minerva Pediatrica*, 47(12), 521.
8. Bundred, P., Kitchiner, D., & Buchan, I. (2001). Prevalence of overweight and obese children between 1989 and 1998: population based series of cross sectional studies. *BMJ*, 322(7282), 326.
9. Campbell, P. T., Katzmarzyk, P. T., Malina, R. M., Rao, D., Pérusse, L., & Bouchard, C. (2001). Stability of adiposity phenotypes from childhood and adolescence into young adulthood with contribution of parental measures. *Obesity Research*, 9(7), 394-400.
10. Casajús, J. A., Leiva, M. T., Villarroya, A., Legaz, A., & Moreno, L. A. (2007). Physical performance and school physical education in overweight Spanish children. *Annals of Nutrition and Metabolism*, 51(3), 288-296.
11. Chinn, S., & Rona, R. J. (2001). Prevalence and trends in overweight and obesity in three cross sectional studies of British children, 1974-94. *BMJ*, 322(7277), 24-26.
12. Cole, T. J., Bellizzi, M. C., Flegal, K. M., & Dietz, W. H. (2000). Establishing a standard definition for child overweight and obesity worldwide: international survey. *BMJ*, 320(7244), 1240.
13. Deforche, B., Lefevre, J., Bourdeaudhuij, I., Hills, A. P., Duquet, W., & Bouckaert, J. (2003). Physical fitness and physical activity in obese and nonobese Flemish youth. *Obesity Research*, 11(3), 434-441.
14. Delaš, N., Tudor, A., Ružić, L., & Šestan, B. (2008). Povezanost djece 5-8. razreda osnovne škole i nekih motoričkih sposobnosti *Hrvatski športskomedicinski vjesnik*, 23(1), 35-44.
15. Ebbeling, C. B., Pawlak, D. B., & Ludwig, D. S. (2002). Childhood obesity: public-health crisis, common sense cure. *The lancet*, 360(9331), 473-482.
16. González-Gross, M., Ruiz, J., Moreno, L., De Rufino-Rivas, P., Garaulet, M., Mesana, M., et al. (2003). Body composition and physical performance of Spanish adolescents: the AVENA pilot study. *Acta Diabetologica*, 40(1), s299-s301.
17. Graf, C., Koch, B., Kretschmann-Kandel, E., Falkowski, G., Christ, H., Coburger, S., et al. (2003). Correlation between BMI, leisure habits and motor abilities in childhood (CHILT-project). *International Journal of Obesity*, 28(1), 22-26.
18. Hill, J. O., & Wyatt, H. R. (2005). Role of physical activity in preventing and treating obesity. *Journal of Applied Physiology*, 99(2), 765-770.
19. Huerta, M., Zarka, S., Bibi, H., Haviv, J., Scharf, S., & Gdalevich, M. (2010). Validity of childhood adiposity classification in predicting adolescent overweight and obesity. *International Journal of Pediatric Obesity*, 5(3), 250-255.
20. Janssen, I., Katzmarzyk, P. T., Srinivasan, S. R., Chen, W., Malina, R. M., Bouchard, C., et al. (2005). Utility of childhood BMI in the prediction of adulthood disease: comparison of national and international references. *Obesity Research*, 13(6), 1106-1115.
21. Khasnutdinova, S., & Grjibovski, A. (2010). Prevalence of stunting, underweight, overweight and obesity in adolescents in Velsk district, north-west Russia: a cross-sectional study using both international and Russian growth references. *Public Health*, 124(7), 392.

22. Koezuka, N., Koo, M., Allison, K. R., Adlaf, E. M., Dwyer, J. J., Faulkner, G., et al. (2006). The relationship between sedentary activities and physical inactivity among adolescents: results from the Canadian Community Health Survey. *Journal of Adolescent Health, 39*(4), 515-522.
23. Koutedakis, Y., & Bouziotas, C. (2003). National physical education curriculum: motor and cardiovascular health related fitness in Greek adolescents. *British Journal of Sports Medicine, 37*(4), 311-314.
24. Krebs, N. F., & Jacobson, M. S. (2003). Prevention of pediatric overweight and obesity. *Pediatrics, 112*(2), 424-430.
25. Lazzer, S., Boirie, Y., Bitar, A., Montaurier, C., Vernet, J., Meyer, M., et al. (2003). Assessment of energy expenditure associated with physical activities in free-living obese and nonobese adolescents. *The American journal of clinical nutrition, 78*(3), 471-479.
26. Lazzeri, G., Rossi, S., Pammolli, A., Pilato, V., Pozzi, T., & Giacchi, M. (2008). Underweight and overweight among children and adolescents in Tuscany (Italy). Prevalence and short-term trends. *Journal of preventive medicine and hygiene, 49*(1), 13.
27. Lobstein, T., Baur, L., & Uauy, R. (2004). Obesity in children and young people: a crisis in public health. *Obesity reviews, 5*(s1), 4-85.
28. Lopes, L., Lopes, V. P., & Pereira, B. (2009). Physical activity levels in normal weight and overweight portuguese children: an intervention study during an elementary school recess. *International Electronic Journal of Health Education, 12*, 175-184
29. Mak, K.-K., Ho, S.-Y., Lo, W.-S., Thomas, G. N., McManus, A., Day, J., et al. (2010). Health-related physical fitness and weight status in Hong Kong adolescents. *BMC Public Health, 10*(1), 88.
30. Mamalakis, G., Kafatos, A., Manios, Y., Anagnostopoulou, T., & Apostolaki, I. (2000). Obesity indices in a cohort of primary school children in Crete: a six year prospective study. *International journal of obesity and related metabolic disorders: journal of the International Association for the Study of Obesity, 24*(6), 765.
31. Mišigoj-Duraković, M. (1999). Tjelesno vježbanje i zdravlje. *Zagreb: Fakultet za fizičku kulturu Sveučilišta u Zagrebu.*
32. Mišigoj-Duraković, M., Borms, J., Duraković, Z., & Matković, B. (2008). *Kinantropologija: biološki aspekti tjelesnog vježbanja*: Kineziološki fakultet.
33. Mišigoj-Duraković, M., & Duraković, Z. (2005). Zdravstveni aspekti korištenja kompjutera, gledanja tv-a i videa u školske djece i mladeži. *Hrvatski kineziološki savez.*
34. Moreno, L. A., Mur, L., & Fleta, J. (1997). Relationship between physical activity and body composition in adolescents. *Annals of the New York Academy of Sciences, 817*(1), 372-374.
35. Mota, J., Santos, P., Guerra, S., Ribeiro, J. C., & Duarte, J. A. (2002). Differences of daily physical activity levels of children according to body mass index. *Pediatric Exercise Science, 14*(4), 442-452.
36. Ogden, C. L., Flegal, K. M., Carroll, M. D., & Johnson, C. L. (2002). Prevalence and trends in overweight among US children and adolescents, 1999-2000. *JAMA: the journal of the American Medical Association, 288*(14), 1728-1732.
37. Planinšec, J., & Fošnarič, S. (2009). Body mass index and triceps skinfold thickness in prepubertal children in Slovenia. *Collegium Antropologicum, 33*(2), 341-345.
38. Raudsepp, L., & Päll, P. (2006). The relationship between fundamental motor skills and outside-school physical activity of elementary school children. *Pediatric Exercise Science, 18*(4), 426-435.
39. Tokmakidis, S. P., Kasambalis, A., & Christodoulos, A. D. (2006). Fitness levels of Greek primary schoolchildren in relationship to overweight and obesity. *European Journal of Pediatrics, 165*(12), 867-874.
40. Vuori, I. (2004). Physical inactivity is a cause and physical activity is a remedy for major public health problems. *Kinesiology, 36*(2), 123-153.
41. Wang, Y., & Lobstein, T. (2006). Worldwide trends in childhood overweight and obesity. *International Journal of Pediatric Obesity, 1*(1), 11-25.
42. Wang, Y., Monteiro, C., & Popkin, B. M. (2002). Trends of obesity and underweight in older children and adolescents in the United States, Brazil, China, and Russia. *The American journal of clinical nutrition, 75*(6), 971-977.
43. Westcott, W. L. (2006). Childhood obesity. *Strength Cond. J.*
44. Wrotniak, B. H., Epstein, L. H., Dorn, J. M., Jones, K. E., & Kondilis, V. A. (2006). The relationship between motor proficiency and physical activity in children. *Pediatrics, 118*(6), e1758-e1765.
45. Zahner, L., Puder, J. J., Roth, R., Schmid, M., Guldimann, R., Pühse, U., et al. (2006). A school-based physical activity program to improve health and fitness in children aged 6–13 years. *BMC Public Health, 6*(1), 147.

COHERENT CHILD CRAWLING PATTERN IN EARLY CHILDHOOD

Urška Čeklić

UP Pedagoška fakulteta in Znanstveno raziskovalno središče, Koper, Slovenia

Introduction

Child's motor development begins very early in the prenatal period when the fetus begins to move spontaneously and thereby develops muscles, joints and the nervous system. Soon after birth, the period that is most important for child development, is early childhood. This period lasts from birth until the age of eight (Malina, Bouchard and Bar-Or, 2004: 7). In early motor development, fundamental motor patterns (FMPs) are important because they enable a child to interact with the environment. FMPs belong to an organized series of related developments in a specific temporal-spatial sequence. Furthermore, FMPs interact closely with body development, especially with the development and maturation of the brain and the central nervous system (CNS) (Pišot and Planinšec, 2005: 21-23, Blakemore and Frith, 2005: 18-36), and consequently on the development of the locomotor system (Pišot and Jelovčan, 2006: 50).

Many researches suggest the importance of the acquisitions of FMP, especially crawling (Adolph, Vereijken and Denny, 1998; Adolph, 2003; Kimura-Ohba et al., 2011). This pattern influences on coordinated movement, coordinated linkage between two hemispheres of the brain (Gillman, 2010) and normal body development (the creation of spinal curvature, development of muscle strength) (Freedland and Bertenthal, 1994; Sañudo Diez, 2008). Child's first attempt to crawl is at around 6 months, when his/her ligaments, bones and joints are developed well. Many authors classify crawling, sitting and walking into three most important milestones in child development (Adolph et al., 1998; Adolph, 2003; Freedland and Bertenthal, 1994). Furthermore, crawling allows a child first independent and effective movement in the environment (Adolph et al., 1998; Adolph, 2008; Campos et al., 2003; Gibson, 1988; Piaget, 1954; in Kretch, Franchak and Adolph, in press; Kimura-Ohba et al., 2011). Moreover, many authors are of the same opinion regarding the coherent crawling pattern, i.e. moving the opposite arm and leg simultaneously. They also agree about non coherent pattern that can appear in the form of a child dragging one leg behind him/her, pulling the body with both hands and creeping.

Moreover, crawling pattern is discussed during the infant or baby period. But in early childhood there is no evidence about researching the pattern of crawling. Some researchers suggest that when a child starts walking, s/he stops crawling, because walking is more efficient.

The aim of our research is to analyze the appearance of the coherent crawling pattern in the period of three years. In doing so, we will take into account the influence of gender, body compositions and age. We hypothesized that children will statistically improve quantitative and qualitative measures of crawling performance with age. Furthermore, we were interested in the correlation between coherence and the speed of crawling.

Method

The data we present has been collected in the on-going basic research project J5 - 2397 entitled "Analysis of Fundamental Motor Pattern Skeletal Muscle Adaptation and Sedentary Lifestyle on Specific Factors Amongst 4 to 7 Years Old Children", funded by the Research Agency of the Republic of Slovenia. Project sponsor, the University of Primorska, Institute of Kinesiology Research and the responsible researcher of the project is prof. dr. Rado Pišot.

Participants

The total sample includes 80 children (34 boys) initially from kindergartens in the coastal region. Later on they were included in elementary schools in the same geographical district. Children were collected according to the chronological age criterion. They were born in 2005. Before starting the measurements we had obtained the consent of the National Medical Ethics Committee of the Republic of Slovenia and parental written consents. Children were measured for the first time in 2009 (they were in the kindergarten) and in 2011, they were already in the 1st grade of an elementary school.

Instruments

The measurement contained morphological characteristics, such as body height, mass, body mass index, and muscle and fat mass (Table 2), which were measured using standard tools and bioimpedance (Bioscan 916S, Maltron UK). The measurements of crawling time were made for 6 m distance. Every child repeated the task for two times and the best results were taken for further analysis. In addition, several qualitative criteria of crawling were used in order to explain the coherence of crawling techniques used (Table 1).

Table 1: Model of coherent crawling pattern

Acronym	Variable name	Never	Sometimes	Always
COORDINATION	Coordinated movement			
VIEW	View into direction of movement			
SUPPORT	Use a support with arms and legs			
DIAGONAL	Use of diagonal reciprocal innervation			

Data analysis

The data were analyzed with the SPSS 20.0 statistic package for Windows. We used the standard descriptive statistics method, *Fleiss kappa for reliability analysis*, 2-way RM ANOVA for age and gender effects in morphological variables and also in all qualitative variables and the speed of crawling.

Results

Table 2 shows the changes in morphological variables (body height, weight, BMI, muscle mass and fat mass) in the three year period. The results show that variables such as body height, weight and muscle mass reach high statistical significance ($p < .001$). Variables BMI reach $p = .002$ and fat mass reach $p = .001$ significance.

Table 2: Basic morphological data

	Age 4	Age 5	Age 6	p
N	80 (34 boys)			
Body height/cm	107.8±4.4	115.5±5.19	121.9±5.6	< .001
Body weight/kg	18.4±2.7	21.0±3.4	23.8±4.1	< .001
BMI/kg m ²	15.7±1.5	15.6±1.7	16±1.9	.002
Muscle mass/kg	5.4±0.8	6.2±1.0	7.2±1.2	< .001
Fat mass/%	15.7±2.7	16.1±3.8	20.0±14.6	.001

* $p < 0.05$; ** $p < 0.001$

In addition we used the *Model of coherent crawling pattern* that consists of four qualitative variables, such as coordinated movement, view into the direction of movement, using support with arms and legs, the use of diagonal reciprocal innervation. We used Fleiss Kappa for reliability and coordinated movement ($K = .65$), view into direction of movement ($K = .84$), using support with arms and legs ($K = .50$), use of diagonal reciprocal innervation ($K = .52$).

The effect of age on qualitative variables shows statistical significance for the variables of support and diagonal reciprocal innervation ($p < .001$). While in the three year period the effect was not statistically significant for the other two variables, coordinated movement ($p = .245$) and view ($p = .801$). Age also has a statistically significant effect on the speed of crawling ($p < .001$). The results are shown in the table below (Table 3).

Table 3 also shows the gender-related results. Moreover, gender does not have a statistically significant effect on the speed of crawling ($p > .05$) and on qualitative variables, except on diagonal reciprocal innervation ($p = .027$).

In the last column of Table 3, we conclude with the impact of gender and age on our variables. Results show no statistical significance for the speed of crawling ($p = .335$), neither for the qualitative variables ($p > .05$).

Table 3: Effect of gender and age on the speed of crawling and qualitative variables of coherent pattern

	Boys			Girls			P _{AGE}	P _{GENDER}	P _{AGE x GENDER}
	4 years	5 years	6 years	4 years	5 years	6 years			
Speed of crawling/ m/7	0.41±0.16	0.44±0.12	0.51±0.13	0.34±0.14	0.41±0.12	0.48±0.15	<.001	.104	.335
Coordination	2.2±0.6	2.3±0.6	2.2±0.5	2.2±0.6	2.3±0.6	2.3±0.7	.245	.960	.917
View	2.9±0.2	2.8±0.5	2.9±0.4	2.8±0.5	2.9±0.4	2.9±0.4	.801	.815	.207
Support	2.1±0.8	1.9±0.8	2.5±0.6	1.9±0.7	1.9±0.8	2.2±0.8	<.001	.150	.531
Diagonal	1.9±0.9	2.6±0.7	2.6±0.8	1.8±0.9	2.2±0.9	2.2±1.0	<.001	.027	.449

* $p < 0.05$; ** $p < 0.001$

In doing so we did correlation analysis of individual qualitative variables in the three year period. No variable has statistically significant correlation in an individual year of measurement ($p > .05$) (Table 4).

Table 4: Correlation between age and qualitative variables

	P _{CORRDIANTION}	P _{VIWE}	P _{SUPPORT}	P _{DIAGONAL}
Crawling_4	.572	.287	.163	.374
Crawling_5	.063	.144	.210	.680
Crawling_6	.284	.720	.055	.102

* $p < 0.05$; ** $p < 0.001$

Discussion

We considered some qualitative variables that define the *Model of coherent crawling pattern* (coordinated movement, view into the direction of movement, using support with arms and legs, use of diagonal reciprocal innervation). We used Fleiss Kappa for the reliability of individual qualitative variables. The Kappa was from .50 to .84.

On the basis of the success of the model we verified the effect of age on the qualitative variables. For the variables of support and diagonal reciprocal innervation, the effect was statistically significant ($p < .001$). While for the other two, the effect was not significant ($p = .245$) for coordinated movement and ($p = .801$) for the view. The effect of gender on the afore mentioned variables was no statistically significant ($p > .05$), besides the diagonal reciprocal innervation ($p = .027$). The effect of age (period of three years) shows statistical significance ($p < .001$) on the speed of crawling, while the effect of gender has no significance regarding the speed of crawling ($p > .05$). Additionally, we analyzed if both gender and age have an effect on the speed of crawling and on qualitative variables. The results show no significance on any qualitative variable ($p > .05$) and neither on the speed of crawling ($p = .335$).

As we already saw the results were statistically significant for age and qualitative variables, we did some further correlation analyses between qualitative variables and individual year of measurement. The correlation between an individual year of crawling and individual qualitative variable was not statistically significant ($p > .05$).

In a more detailed interpretation of the above mentioned results we can conclude that the improvement in coherence of crawling was in every year. But differences between boys and girls are not present in our research. Previous analyses in the three year period show an improvement by 24.35% in the speed of crawling. In order to crawl effectively and fast, child's movement must be coordinated. Previous research show that children that were faster also used diagonal reciprocal innervation (Čeklić, Plevnik and Pišot, 2010). In our research we did not find any differences in the coherence of the crawling pattern between boys and girls, when they were in kindergarten and also later in the first grade. This can be explained. Children in early childhood differ in motor skills between genders, but this differences are not significant. The second explanation refers to the infancy period when a child starts crawling on their belly. Not all children go through the phase of crawling, some of them just skip it and continue to the next phase. The pattern of crawling can differ in children. So far there has been no evidence of any research which would discuss the effect of intervention on the improvement of the coherence of the crawling pattern.

Conclusions

We considered some qualitative variables that define the *Model of coherent crawling pattern* (coordinated movement, view into the direction of movement, using support with arms and legs, use of diagonal reciprocal innervation). We used Fleiss Kappa for the reliability of individual qualitative variables. The Kappa was from .50 to .84.

On the basis of the success of the model we verified the effect of age on the qualitative variables. For the variables of support and diagonal reciprocal innervation, the effect was statistically significant ($p < .001$). While for the other two, the effect was not significant ($p = .245$) for coordinated movement and ($p = .801$) for the view. The effect of gender on the afore mentioned variables was no statistically significant ($p > .05$), besides the diagonal reciprocal innervation ($p = .027$). The effect of age (period of three years) shows statistical significance ($p < .001$) on the speed of crawling, while the effect of gender has no significance regarding the speed of crawling ($p > .05$). Additionally, we analyzed if both gender and age have an effect on the speed of crawling and on qualitative variables. The results show no significance on any qualitative variable ($p > .05$) and neither on the speed of crawling ($p = .335$).

As we already saw the results were statistically significant for age and qualitative variables, we did some further correlation analyses between qualitative variables and individual year of measurement. The correlation between an individual year of crawling and individual qualitative variable was not statistically significant ($p > .05$).

In a more detailed interpretation of the above mentioned results we can conclude that the improvement in coherence of crawling was in every year. But differences between boys and girls are not present in our research. Previous analyses

in the three year period show an improvement by 24.35% in the speed of crawling. In order to crawl effectively and fast, child's movement must be coordinated. Previous research show that children that were faster also used diagonal reciprocal innervation (Čeklić, Plevnik and Pišot, 2010). In our research we did not find any differences in the coherence of the crawling pattern between boys and girls, when they were in kindergarten and also later in the first grade. This can be explained. Children in early childhood differ in motor skills between genders, but this differences are not significant. The second explanation refers to the infancy period when a child starts crawling on their belly. Not all children go through the phase of crawling, some of them just skip it and continue to the next phase. The pattern of crawling can differ in children. So far there has been no evidence of any research which would discuss the effect of intervention on the improvement of the coherence of the crawling pattern.

References

1. Adolph, K. E., Vereijken, B. and Denny, M. A. (1998). Learning to crawl. *Child Development*, 69(5), 1299– 1312.
2. Adolph, K. E. (2003). Learning to keep balance. *Advances in child development and behavior*, 30, 1–40.
3. Blakemoore, S. J. and Frith, U. (2005). The learning brain: lessons for education. *The developing brain* (str. 18–36). Blackwell publishing.
4. Čeklić, U., Plevnik, M in Pišot, R. (2010). Analiza elementarnih gibalnih vzorcev - plazenja, 4-letnih otrok. In R. Pišot e tal. (ed.), *Otrok v gibanju: prispevki*. Koper: Univerza na Primorskem, Znanstveno-raziskovalno središče, p. 65–67.
5. Freedland, R. L. and Bertenthal, B. I. (1994). Developmental changes in interlimb coordination: Transition to Hands-and Knees Crawling. *Psychological Science*, 5(1), 26–32.
6. Gillman, C. (2010). Crawling is crucial for development. *Living healthy*, December 1.
7. Kimura-Ohba, S., Sawada, A., Shiotani, Y., Matsuzawa, S. et al. (2011). Variation in early gross motor milestones and in the age of walking in Japanese children. *Pediatrics International*, 53, 950–955.
8. Krech, K.S., Franchak, J.M. and Adolph, K. E. (in press). Crawling and walking infants see the world differently. *Child Development*.
9. Malina, R. M., Bouchard, C. and Bar-Or, O. (2004). Growth, Maturation, and Physical activity. In J. P. Wright (ed.), *Chronological age and age groups* (p. 7). Champaign: Human Kinetics.
10. Pišot, R. and Planinšec, J. (2005). Struktura motorike v zgodnjem otroštvu. V V. Rožac Darovec (ed.), *Nekatere značilnosti otrokovega razvoja v predšolskem in zgodnje šolskem obdobju: Motorični razvoj in zorenje centralnega živčnega sistema – nevrofiziološki dejavniki, ki vplivajo na motorični razvoj* (p. 21–23). Koper: Univerza na Primorskem, Znanstveno-raziskovalno središče, Inštitut za kineziološke raziskave, Založba Annales.
11. Sañudo Diez, B.R. (2008, December 1). Baby Crawling: How important it really is. *Movement and Learning*, 20, 1-2. Obtained from, <http://icpa4kids.org/Wellness-Articles/baby-crawling-how-important-it-really-is.html>.

Acknowledgements

The authors want to express their gratitude to the Public Research Agency of the Republic of Slovenia for funding the research project “Analysis of Natural Movement Patterns and Adaptation of Skeletal Muscles in Some of the Factors of Modern Lifestyle of Children between 4 and 7 years of age”. We are grateful to all children and their parents, who allowed us to carry out such an important project. At the end, we would like to express our gratitude to other researchers and students who assisted at the project.

THE EFFECT OF GENDER ON CHILDREN'S RHYTHMIC GYMNASTICS SKILLS

Tina Erceg and Ana Kezić

Faculty of Kinesiology, University of Split, Croatia

Abstract

The main aim of current research was to determine gender differences in specific rhythmic gymnastics rope skills in 6 year old children. Seventy preschool children participated (30 girls and 40 boys). Overall, 5 rope skills tests were constructed: rope swings, front scale rotation, jumping through the rope, throwing and catching and rope winding. Statistically significant difference occurred only in 3 out of 5 tests: *Front scale Rotation*, *Jumping through the Rope* and *Rope Winding*. When *Front scale Rotation* element is concerned, it is probable that severe lack in flexibility of boys resulted in lower scores. Girls turned out to have significantly better results in *Jumping through the Rope* test. The most of the differences between the genders probably occurred because of the different type of activities that boys and girls practice in their free time, gender-based activities.

Key words: *aesthetic activities, rope skills, gender differences, preschool children*

Introduction

Speaking of rhythmic gymnastics (RG) as a competitive sport, we can say that it requires, at first glance, two diametrically opposite features. First are power and explosiveness, and second flexibility and rhythm. And it is precisely optimal relationship between these parameters what makes this sport complex, but interesting. In complete contrast to the competitive sphere is the beginner's RG program. This program is equally focused on entertainment, active participation and enjoyment. In such environment, this sport is not determined by gender, and both girls and boys are equally involved (Božanić & Miletić, 2011).

Generally, the differences between genders become noticeable in preschool period already. Boys' higher values of triceps muscle tissue and shoulder/hip ratio are well-known. Furthermore, boys score better at motor strength and endurance tests, as well as at running and jumping tests. On the other hand, girls outperform boys at rhythm-based and flexibility tests. As a rule, girls outperform boys at precise motor actions such as drawing, typing and tapping. They are also better at reaction speed (Burton & Miller, 1998), while the boys have an advantage in running, jumping and punching. Božanić et al. (2011) also proved the advantage of girls in fine motor precision tests. The authors stated that the differences probably occurred because of different type of activities that boys and girls practice in their free time.

Gender differences might also be an important factor in motor performance, especially in motor learning (Dorfberger et al., 2009). Therefore, differences between boys and girls might also occur for technical mastery in rhythmic gymnastics. The reason rhythmic gymnastics is unique is because it requires mastery of two motor tasks at the same time: using the body and handling apparatus (Jastrjemskaia & Titov, 1999). So, it could be interesting to find out if boys and girls differ in such complex motor manifestations in such young age.

According to previously mentioned, the main aim of current research was to determine gender differences in specific rhythmic gymnastics rope skills in 6 year old children.

Methods

Seventy preschool children participated (30 girls and 40 boys; mean age 6 ± 0.5). All of them were chosen randomly and they all gave their informed consent, as their parents gave official written consent. The study included children with no health problems or significant motor disorders. Their average body height was 122.5 ± 5.0 cm, with average body weight of 24.49 ± 3.78 kg, average body mass index being 16.28 ± 1.71 . Those children who were involved in RG outside the preschool institution were not included in the investigation.

Selection of tests for specific rope skills assessment was done according to existing rope techniques in Federation Internationale de Gymnastique (FIG) Code of Points in such way that one test for each technique was designed. Overall, 5 rope skills tests were constructed. Qualitative approach that was based on fundamental motor skills assessment ("Test of Gross and Motor Development") (Ulrich, 2000) was used for evaluation of each skill. Thus, each test was divided into three phases (segments) and each stage had to meet certain criteria. If the respondent met the criteria he was assigned the score 1, and if he did not meet the criteria, he received a score 0. The maximum number of points that the respondent

could get on a single test was 6 because each test was repeated twice. Based on primary rope techniques (swings, rotations, passing through the rope, throwing and catching, and rope manipulation) the following tests were constructed: Rope Swings (RS), Front Rotation (FR), Jumping through the Rope (JR), Throwing and Catching (TC) and Rope Winding (RW).

Specific rope skills assessment was done after 9 weeks of the treatment, since the children's initial level of such skills at the beginning of the program was zero. Each child was tested throughout one session and all participants were tested in the range of one week. All skills were videotaped and later assessed individually by three experienced RG teachers and coaches according to the procedures described above.

Data were analyzed using the Statistica for Windows 11.0 package and statistical significance was set at $P < 0.05$. Basic descriptive statistics were calculated for all variables and for every judge individually (mean values and standard deviations). For determining the reliability of the specific rope skills tests Cronbach's alpha coefficients (CA) were calculated; Kolmogorov-Smirnov test was used for determining the normality of the distribution (K-S). Finally, the differences between the genders were investigated with the use of ANOVA and nonparametric Mann-Whitney test.

Results

Table 1. Descriptive statistics for all measured variables (Mean; SD – Standard Deviation); reliability analysis (CA – Cronbach Alpha coefficient); Kolmogorov-Smirnov tests for normality (K-S)

	Mean±SD	CA	K-S
RS1	4.51±1.24		
RS2	4.14±1.05	0.94	0.11
RS3	3.91±1.47		
FR1	3.37±1.22		
FR2	3.39±1.46	0.97	0.07
FR3	3.89±1.41		
JR1	3.21±1.58		
JR2	3.30±1.84	0.97	0.11
JR3	3.49±1.57		
TC1	3.33±1.41		
TC2	3.14±1.31	0.97	0.15
TC3	3.34±1.25		
RW1	4.27±1.93		
RW2	4.74±1.62	0.98	0.19
RW3	4.54±1.77		

Legend: RS – Rope Swings, FR – Front scale Rotation, JR – Jumping through the Rope, TC – Throwing and Catching, RW – Rope Winding; 1,2,3 – indicates the number of the judge; $d < .16$ (for $N=70$)

Table 2. Descriptive statistics for measured variables (Mean; SD – Standard Deviation); ANOVA and Mann-Whitney test (M-W) for differences between the groups (p value)

	BOYS Mean±SD	GIRLS Mean±SD	ANOVA/M-W (p value)
RS	3.98±1.05	4.48±1.15	0.06
FR	3.13±1.22	4.10±1.11	0.01
JR	2.87±1.37	3.96±1.67	0.00
TC	3.13±1.34	3.45±1.09	0.28
RW	4.13±1.82	5.03±1.43	0.01

Legend: RS – Rope Swings, FR – Front scale Rotation, JR – Jumping through the Rope, TC – Throwing and Catching, RW – Rope Winding

The results of the reliability analysis revealed high reliability in all applied specific rope skills tests according to CA coefficients (Table 1). Students performed the *Rope Winding* test on the highest level, while *Jumping through the Rope* was the most difficult task. Kolmogorov – Smirnov test for normality proved all tests to be normally distributed, except for Rope Winding test, where results were generally saturated on the right side of the distribution. According to this occurrence, for later analysis of this test nonparametric statistics were used.

Considering the mean values separately by gender (Table 2) girls outperform boys in practically all tests for rope skills. However, statistically significant difference occurred only in 3 out of 5 tests: *Front scale Rotation*, *Jumping through the Rope* and *Rope Winding*; based on the results of analysis of variance and Mann-Whitney test.

Discussion and conclusions

Basic rope technical elements must be mastered at an early age, so that the child enriches its motor memory by the time of entering into the first competitions. Early mastering the basic rope techniques becomes more important by the fact that the rope is one of the apparatus which is firstly introduced in the competitions of younger age categories.

High values of CA coefficients demonstrated a high reliability of the tests. Normally authors investigating qualitative performance (assessed by independent judges) register somewhat lower reliability coefficients (Miletić, 2003) than those gained by this research. Considering that the performance of specific rope skills tests was assessed by judges, high values of between-subjects reliability coefficients demonstrate well-set criteria. A one's technical mastery is determined by what she or he is capable of performing and whether she or he conforms to the standard (or model) for each technique (Jastrjemskaia & Titov, 1999). The participants demonstrated the highest level of technical mastery in *Rope Winding* test. This probably happened as this skill doesn't include body technique but only rope technique (manipulation). On the other hand, *Jumping through the Rope* was the most difficult task for the children in general. This skill, more than any other applied, demands the synchronization of body and apparatus technique. Miletić (2003) reports similar conclusions on a population of school children (also beginners).

Although rhythmic gymnastics skills include techniques of body movements and apparatus, they also include fitness, grace and artistic presentation (Jastrjemskaia & Titov, 1999) and, the lack of the latter in the boys is probably one of the reasons why their performance was inferior in all tests. Similar results were found in students as well (Božanić & Miletić, 2011). When *Front scale Rotation* element is concerned, it is probable that severe lack in flexibility of boys resulted in lower scores. Females tend to be more flexible than males (Gabbard & Tandy, 1988) and this could explain why boys have difficulty performing basic body elements (like front scale) since amplitude and a defined form are needed. Also, girls turned out to have better significantly better results in *Jumping through the Rope* test. This certainly could have something to do with girl's daily activities which are completely different than males'. Girls from this region spend the most of their outdoor free time in a traditional game of "rope jumping" which can be the reason of better test results.

Besides anthropometric features and motor abilities, girls and boys differ in their technical mastery of handling rhythmic gymnastics apparatus. It can be concluded that most of the differences between the genders probably occurred because of the different type of activities that boys and girls practice in their free time, gender-based activities, respectively. Such statement should be investigated more thoroughly by inspecting children's daily activities and recording their overall physical activity.

References

1. Božanić, A., & Miletić, Đ. (2011). Differences between the sexes in technical mastery of rhythmic gymnastics. *Journal Of Sports Sciences*, 29(4), 337-343. doi:10.1080/02640414.2010.529453
2. Božanić, A., Delaš Kalinski, S., & Žuvela, F. (2011). Changes in fundamental movement skills caused by a gymnastics treatment in preschoolers. In: Proceedings Book 6th FIEP European Congress, Poreč: 89-94.
3. Burton, W.A., & Miller, E.D. (1998). *Movement skill assessment*. Champaign, IL: Human Kinetics.
4. Dorfberger, S., Adi-Japha, E., & Karni, A. (2009). Sex differences in motor performance and motor learning in children and adolescents: an increasing male advantage in motor learning and consolidation phase gains. *Behavioural Brain Research*, 198, 165-171.
5. Gabbard, C., & Tandy, R. (1988). Body composition and flexibility among prepubescent males and females. *Journal of Human Movement Studies*, 14(4), 153-159.
6. Jastrjemskaia, N., & Titov, Y. (1999). *Rhythmic gymnastics*. USA: Human Kinetics.
7. Miletić, Đ. (2003). *Analiza usvajanja motoričkih znanja u ritmičkoj gimnastici* [Analysis of acquisition of rhythmic gymnastics motor skills. In Croatian.]. Doctoral disertation, Zagreb: Faculty of Kinesiology.
8. Ulrich, D.A. (2000). *Test of Gross Motor Development*. Austin: Pro-Ed Publishers.

EFFICIENCY OF A PHYSICAL ACTIVITY TREATMENT ON MOTOR PROFICIENCY AMONG PRESCHOOLERS

Marijana Hraski, Vatroslav Horvat and Igor Bokor

Faculty of Teacher Education, University of Zagreb, Croatia

Abstract

The study assessed the effects of physical activity treatment on development of motor abilities in preschool children. The research was conducted on sample of 143 children at the age of six. The experimental group, who participated in physical activity program, was consisted of 68 children, while the control group was made of 75 preschoolers. A set of six motor tests was used for access motor abilities and twelve anthropometric measures were taken. The conducted results of analysis of variance show that there is statistically significant difference between experimental and control group in repetitive strength, coordination, frequency of movement and explosive strength. This study demonstrated that children who participated in physical activity treatment produced better outcomes than children who did not included in intervention program of exercise.

Key words: motor abilities; physical activity program; six-year old children

Introduction

Physical fitness level, which comprises the development of motor abilities, from an early age is considered to yield substantial health benefits later in life. Research conducted in the last decade has provided evidence that physical fitness, respectively motor abilities, are an important marker of health in children and adolescents (Ortega et al., 2008; Gisladdottir, Haga, & Sigmundsson, 2013). Regular participation in physical activity has been clearly established as being integral to health and wellbeing from childhood to adolescence and adulthood. Thus, recent research has begun to focus on the importance of physical activity in the preschool years (Oliver, Schofield, & Kolt, 2007). Physical activity and motor skills acquisition play a key role in childhood development especially during the preschool period (Adaškevičiene, 2000; Kretschmer, 2001). Engaging in a variety of motor tasks stimulates the neuromotor system and enables the child to rely on a large and stable store of experiences and to adjust it to new situations (Clearfield, & Thelen, 2001). Promotion of physical activity and motor skills gain more and more importance in today's kindergartens (Roth et al., 2010). Acquired motor skills and developed motor abilities are fundamental factors of a child's motor competence (Pišot et al., 2010) on the bases of which it can be monitor harmony and deviations in a child's motor development (Pišot & Planinšec, 2010). The development of motor competence during childhood is depended upon and influenced by the growth and maturity characteristics (Hills, King, & Armstrong, 2007). The environment in which a child is reared is also important. Environmental opportunities and restraints for movement interact with the biological substrates of growth and maturation to determine the motor repertoire of the child (Malina, 2004) and also are reflected in the cognitive, affective and social development of children (Sanders, 2002). Since that, regular physical activity provides a versatile motor development and affects the better health status of the child, it is important from an early pre-school age to ensure the prerequisites to motor development went smoothly and as favorable (Trajkovski Višić, Zebić & Hrvoj, 2010). Highly professional motor skill learning program and guided physical activity process can prevent or mitigate the effects of deficits resulting in other areas of child's development, also professionally planned and conducted preschool physical education represents a highly significant element on developing children's motor abilities (Videmšek et al., 2003). Since preschools offer high potential for intervention it is necessary to known and to explore the possible outputs of well structured programs of physical activity for children. The aim of this study was to determine the effects of systematic physical activity program on development of motor abilities in six-year old preschool children.

Methods

For the purpose of this study the subject was composed from a population of children from three Kindergartens in city of Zagreb (Iskrica, Potočnica and Vrbik). The research was conducted on sample of 143 preschool children at the age of six. The experimental group, who participated in physical activity program over three years, was consisted of 68 children, while the control group was made of 75 preschoolers.

The research variables were obtained on the basis of a set of six motor tests for accessing motor abilities: polygon backward (PBW) for establish coordination, sit and reach (SAR) for flexibility, standing long jump (SLJ) for explosive

strength, arm plate taping (APT) for frequency of movement, standing with one leg on the cube (SOL) for balancing and sit-ups (SUP) for assess repetitive strength. Twelve anthropometric measures were taken (body height, arm length, sitting height, body mass, arm circumference, forearm circumference, elbow diameter, shoulder width, hip width, triceps skinfold, subskapular skinfold, suprapatellar skinfold). The measurement was conducted in the morning after the children's arrival. For all children involved in measurements was collected parents' consent.

All tests were performed in standard conditions, using standard apparatuses and under the supervision of the authors of this paper. All obtained results were calculated by statistic package Statistics for Windows 7.0. The basic statistic parameters were calculated for all variables. For determine the effects of the physical activity treatment on development of motor abilities in six-year old preschool children the analysis of variance was used. Also the analysis of variance was conducted in the set of anthropometric variables to determine that the children who belong to two different samples are from the same population of children in terms of anthropometry. All found differences between experimental and control group are significant at $p < 0.05$.

The program in the experimental group has been developed jointly by a student of Faculty of Teacher Education guided by kindergarten teacher and professor from Department of kinesiology education on Faculty of Teacher Education. The children from experimental group participated in physical activity program from the age of three years. The program constitutes two lessons a week. Each lesson took 35 minutes of exercising. The goals and the contents of the program were clearly defined and were developmentally appropriate for preschool children. The fundamental goal of the physical activity treatment is that children acquire as many and as various movement experience as possible. The emphasis is on developing basic and modified biotic motor skills, implementation of content in order to overcome the area, barriers, changes of direction and manipulation of objects. Also, acquiring some basic movement concepts, conventional kinesiology activities and learning various elementary games. The control group worked according to the usual program which is developed by a kindergarten teacher and over three years the control group did not have the opportunity to participate in organized kinesiology activities, caused primarily, because a lack of appropriate space. The guided physical activity treatment have not influenced on the program of control group in any way.

Results

The obtained results of descriptive statistics of all anthropometric variables for preschool children in experimental and control groups are shown in table 1.

Table 1: Descriptive statistics and analysis of variance between experimental and control group in anthropometric characteristics

	Group	M	SD	F	p
Body height (cm)	E	123,87	4,98	1,18	0,27
	C	122,91	5,38		
Arm length (cm)	E	51,78	5,60	0,10	0,75
	C	51,55	2,78		
Sitting height (cm)	E	67,07	3,06	3,94	0,04*
	C	65,97	3,44		
Body mass (kg)	E	25,34	4,15	0,12	0,72
	C	25,09	3,91		
Arm circumference (cm)	E	18,52	1,87	0,06	0,80
	C	18,60	2,09		
Forearm circumference (cm)	E	17,99	1,55	0,31	0,57
	C	17,85	1,39		
Elbow diameter (cm)	E	4,78	0,45	1,06	0,30
	C	4,85	0,35		
Shoulder width (cm)	E	27,85	2,32	3,58	0,06
	C	27,16	2,03		
Hip width (cm)	E	20,99	1,56	4,34	0,30
	C	20,41	1,75		
Subskapular skinfold (mm)	E	6,81	3,03	0,27	0,60
	C	7,08	3,03		
Triceps skinfold (mm)	E	10,85	3,98	1,07	0,30
	C	10,24	3,10		
Suprapatellar skinfold (mm)	E	11,38	6,05	4,02	0,05*
	C	9,74	3,43		

Legend: E-experimental group, C-control group, M-arithmetic mean, SD- standard deviation, F- F value, P- level of significance, *-statistically significant difference

Table 2: Descriptive statistics and analysis of variance between experimental and control group in motor abilities

	Group	M	SD	F	p
Sit-ups	E	15,17	4,63	3,956	0,05*
	C	13,74	3,89		
Poligon backward (sec)	E	11,83	3,48	5,783	0,02*
	C	13,63	5,30		
Sit and rich (cm)	E	4,57	7,66	2,07333	0,15
	C	2,98	6,10		
Arm plate taping	E	13,76	1,81	5,431	0,02*
	C	12,92	2,39		
Standing long jump (cm)	E	117,12	15,45	13,283	0,00*
	C	106,49	19,18		
Standing with one leg on the cube (sec)	E	10,28	6,77	3,2997	0,07
	C	12,71	8,96		

Legend: E-experimental group, C-control group, M-arithmetic mean, SD- standard deviation, F- F value, P- level of significance, *-statistically significant difference

The arithmetic mean and standard deviations of majority anthropometric characteristics point out that the samples of preschool children are constitutionally very similar and they are randomly chosen from the same population of preschool children. Based on these data it can be concluded, further in the article, about possible differences in motor skills which are therefore caused by different lifestyles. From table 2. it can be seen that in motor tests experimental group in all measurements have better results than control group of children except in balancing (SOL) where control group produce superior outcome.

The conducted results of analysis of variance, which was used to establish whether the two groups statistically significantly differed in motor abilities, show that there is statistically significant difference between experimental and control group in repetitive strength, coordination, frequency of movement and explosive strength (Table 1.). For the experimental group physical activity treatment proved to be more effective than the control group program.

Discussion

In this study the physical activity treatment demonstrated significant changes in majority motor abilities among preschoolers. No significant changes occurred in flexibility and balancing. Although experimental group achieve better results in motor test sit and reach, while the control group produced better result in balancing. These findings suggest that three years physical activity treatment (35 minutes, 2 days per week) was adequate for enhancing motor abilities referring to repetitive strength, coordination, frequency of movement and explosive strength among preschoolers. This indicates that physical activity intervention must be complemented with exercises that affect the development of flexibility and balancing, and as such will have positive impact also on those abilities in children. As well, it should have be note that motor development is complex process in which a child acquires motor abilities and knowledge in interaction with genetic and environmental factors (Latash, 2008). Pišot et al. (2010) in their study highlights that the development of motor abilities is continuous over a period of time although occasional periods of stagnation and even decline in abilities are typical. They comment that some motor abilities reach their highest level sooner and some later. Early childhood is characterized by a very intensive development of some abilities such as speed and coordination, whereas the development of others, such us balance, strength, flexibility and endurance is a bit slower (Malina et al., 2004).

Few intervention studies examined motor abilities outcomes among children. Bellows et al. (2013) assessed the efficacy of an intervention on motor skill performance, physical activity and weight status of preschoolers. Their study demonstrated that children who participated in the Mighty Moves program showed an increase in motor skill performance but did not affect child factors such as BMI. Williams et al. (2008) also examine the relationship between motor skill performance and physical activity in preschool children. They concluded that children with poorer motor skills were less active than children with better developed motor skills. Wrotniak et al. (2006) also reported an association between motor abilities and time spent in physical activity. The authors concluded that motor proficiency is positively associated with physical activity and inversely associated with sedentary activity in children. In a review by Ward et al. (2010) of child based physical activity interventions, the studies targeting motor abilities outcomes were identified. All five of the studies had positive effects on some aspect of children's motor abilities. As in this research, in Ward et al. (2010) review it was suggested that 90 min of weekly structured physical activity seems to be sufficient to achieve improvements in motor abilities. The dose of structured physical activity provided by Mighty Moves in Bellows et al. (2013) research, 60-80 min per week also was sufficient to improve motor performance and feasible for kindergarten teachers to incorporate into program.

Conclusion

This study demonstrated that children who participated in structured physical activity treatment three years in a row, 35 minutes a day, two times per week, produced better outcomes in most of measured motor abilities than children who did not included in intervention program of exercise. This research supports the small but growing body of evidence that points to an important relationship between level of motor performance and children's participation in physical activity. Also the evidence from our study supports the assertion that the level of development of motor abilities may be an important factor in promoting a physical active lifestyle in preschool children.

References

1. Adaškevičiene, E. (2000). Modern Education System and Healthy Kindergarten. *Sportas*, 1(34), 5-15.
2. Bellows, L. L., Davies, P. L., Anderson, J., & Kennedy, C. (2013). Effectiveness of a Physical Activity Intervention for Head Start Preschoolers: A Randomized Intervention Study. *The American Journal of Occupational Therapy*, 67(1), 28-36.
3. Clearfield, M. W., & Thelen, E. (2001). Stability and flexibility in the acquisition of skilled movement. In C. Nelson, & M. Luciana (Eds.), *Handbook of development of cognitive neuroscience* (pp. 253–266). Cambridge, MA: MIT Press.
4. Gisladottir, P., Haga, M., & Sigmundsson, H. (2013). Physical fitness Measures Among Adolescents With High and Low Motor Competence /on line/. Retrieved on 24th January 2014 from: <http://sgo.sagepub.com/content/3/3/2158244013500282.full-text.pdf+html>
5. Hills, A. P., King, N. A., & Armstrong, T. P. (2007). The Contribution Of Physical Activity And Sedentary Behaviours To The Growth And Development Of Children And Adolescents. *Sports Medicine*, 37(6), 533-545.
6. Kretschmer, J. (2001). Changes in Childhood and Children's Motor Development. *International Journal of Physical Education*, 38(3), 114-126.
7. Latash, M. L. (2008). *Neuropsychological basis of movement*. Champaign, IL: Human Kinetics.
8. Malina, R. M. (2004). Motor Development During Infancy And Early Childhood: Overview And Suggested Directions For Research. *International Journal of Sport and Health Science*, 2, 50-66.
9. Oliver, M., Schofield, G. M., & Kolt, G. S. (2007). Physical Activity in Preschoolers. *Sports Medicine*, 37(12), 1045-1070.
10. Ortega, F. B., Ruiz, J. R., Castillo, M. J., & Sjörström, M. (2008). Physical fitness in childhood and adolescence: A powerful marker of health. *International Journal of Obesity*, 32, 1-11.
11. Pišot, R., & Planinšec, J. (2010). Motor structure and basic movement competences in early child development. *Annales Kinesiologiae*, 1(2), 145-165.
12. Pišot, R., Šarabon, N., Jelovčan, G., Plevnik, M., Pišot, S., Čeklić, U., Volmut, T., Dolenc, P., Geržević, M., Mohorko, N., Koren, K., & Šimunič, B. (2010). Fundamental motor patterns in children aged 4-7 years. In M. Kovač, G. Jurak & G. Starc (Eds.), *5th International Congress Youth Sport* (pp 81-93). Ljubljana: Fakulteta za šport Univerza v Ljubljani.
13. Roth, K., Mauer, S., Obinger, M., Ruf, K. C., Graf, C., Kriemler, S., Lenz, D., Lehmacher, W., & Hebestreit, H. (2010). Prevention Trough Activity In Kindergarten Trial (PAKT): A Cluster Randomised Controlled Trial To Assess The Effects Of An Activity Intervention In Preschool Children / online/. Retrived on 24th January 2014 from: <http://www.biomedcentral.com/1471-2458/10/410/prepub>
14. Sanders, S. W. (2002). *Active for Life: Developmentally Appropriate Movement Programs for Young Children*. Washington, DC: NAEYC.
15. Trajkovski Višić, B., Zebić, O., & Hrvoj, Z. (2010). Utjecaj Kineziološkog programa na poboljšanje eksplozivne snage i agilnosti u četverogodišnjaka [The influence of Kinesiology program on improving explosive strength and agility in four-year old children]. In I. Jukić, C. Gregov, S. Šalaj, L. Milanović & T. Trošt-Bobić (Eds.), *8th international conference "Kondicijska priprema sportaša –trening brzine, agilnosti i eksplozivnosti"* (pp. 477-480). Zagreb: Faculty of Kinesiology, University of Zagreb.
16. Videmšek, M., Karpljuk, D., Štihec, J., & Kropelj, V. L. (2003). Comparison Of Efficiency Of Two Training Programmes For Developing Selected Motor Abilities Of Children In Kindergarten. *Kinesiologia Slovenica*, 9(2), 67-73.
17. Ward, D. S., Vaughn, A., McWilliams, C., & Hales, D. (2010). Interventions for increasing physical activity at child care. *Medicine and Science in Sport and Exercise*, 42, 526-534.
18. Williams, H. G., Pfeiffer, K. A., O'Neill, J. R., Dowda, M., McIver, K. L., Brown, W. H., & Pate R. R. (2008). Motor skill Performance and Physical Activity in Preschool Children. *Obesity*, 16(6), 1421-1426.
19. Wrotniak, B. H., Epstein, L. H., Dorn, J. M., Jones, K. E., & Kondilis, V. A. (2006). The Relationship Between Motor Proficiency And Physical Activity In Children. *Pediatrics*, 118(6), 1758-1765.

THE CURRENT LEVEL OF HEALTH AND SKILLS RELATED FITNESS INDICATORS IN ALBANIAN CHILDREN; REFERENCE VALUES FROM A COUNTRY IN TRANSITION

Juel Jarani¹, Keida Ushtelena² and Andi Spahi³

¹*Department of Organizations and Management, Faculty of Physical Activity and Recreation, Sports University of Tirana, Albania*

²*Department of Social Sciences and Education, Faculty of Movement Sciences, Sports University of Tirana, Albania*

³*Department of Movement and Health, Faculty of Physical Activity and Recreation, Sports University of Tirana, Albania*

Abstract

The aims of this study were to (a) estimate the prevalence of overweight and obesity in Albanian children (b) compare Albanian children with their European counterparts for anthropometric variables and gross motor coordination (GMC). Data consisted of a cross-sectional study of 1176 children (618 boys and 558 girls) aged 7-10 years old.

Body mass, body height and level of GMC were assessed. The prevalence of overweight and obesity was 10.2% and 3.2%. Significant differences were observed between boys and girls regarding prevalence of obesity (5.7% boys and 2.2% girls, $P \leq 0.05$). Overall, Albanian children showed lower values in weight compared to Portuguese children and equal weight compared to Belgian children and were shorter than their European younger counterpart. The results from this investigation study reveal strong evidence that children in Albania show motor difficulties in everyday skills (moderate motor disorder-31.2% and severe motor disorder-8%). To be concerned were the number of children that fell into the level of severe motor disorder (8%) that will be the focus of future studies to be evaluated for having probably motor coordination disorder.

Key words: *gross motor coordination, body mass index, overweight*

Introduction

Data from several sources have identified the increased incidence of obesity in children, due to excessive consumption of calories (Roberts et al., 2000), low level of physical activity (Boreham et al., 2004; Venn et al., 2007) and cardiorespiratory fitness (Lobstein et al., 2004; Janssen et al., 2005; Katzmarzyk and Tremblay, 2007). There is an increasing prevalence of overweight and obesity among children in Europe (Ogden et al., 2006) especially Eastern Europe and Middle East region that had the highest prevalence of overweight children (Kelishadi, 2007). Referring to BMI reference values, in Greece, Italy, Spain and Portugal the prevalence of overweight is above 15% while in Croatia, Hungary, FYROM, and Serbia the prevalence varies between 10- 15% (Ostojic et al., 2011; Janssen et al., 2005). It appears that gross motor coordination plays a crucial role in children's participation in physical activity. Results from a study of Bouffard et al. (1996) indicated that children lacking gross motor coordination are at risk of being less physical active which later will hamper opportunities for developing good motor competence and is directly related to sedentary activity (Wrotniak et al., 2006). Albania, is a country in Southeast Europe, emerged in 1990 from the most isolated communist regime (Nuri and Tragakes, 2002; Rechel and McKee, 2003). In the following decade the country opened up rapidly to Western influences, experiencing a major social and political transition process. The paucity of literature on the prevalence of overweight and obesity in Albanian children points out the need for reliable and consistent data in this field. Knowledge of the current issues is thus important, particularly as the prevalence of obesity seems to have increased sharply in recent years (Ogden et al., 2006; Janssen et al., 2005). The present study was designed to (a) estimate the prevalence of overweight and obesity in Albanian elementary school children (aged 7-10 yrs), (b) compare Albanian children with their European counterparts for anthropometric variables and gross motor coordination level.

Materials and Methods

Study participation

This study is a cross sectional and is part of a project in Tirana where children will be monitored in health related variables, fitness components, gross motor coordination at baseline (year 2012) followed up annually over five consecutive years (till 2016). Data presented in this study are from year 2012. A total of 1176 children between first and fourth grade of elementary school (618 boys and 558 girls, aged 7-10 years old participated in this study (see Table 1 for gender and age distribution).

Table 1: Main descriptive statistics for mean age and gender distribution of children participated in the study

	1 st Grade		2 nd Grade		3 rd Grade		4 th Grade	
	N	Mean	N	Mean	N	Mean	N	Mean
Total	366	6.8	228	8	226	9.1	356	9.8
Boys	192	6.9	118	8.1	118	9.1	190	9.9
Girls	174	6.8	110	8	108	9.1	166	9.7

The elementary schools (N=6) were randomly selected from 52 schools located in the city of Tirana (Regional Education Directorate of Tirana 2011). Schools and classes were selected to be represented by age/ gender and geography. Tirana as the capital city of Albania represents 1/3 of the national population. Data for body height, mass, and gross motor coordination on European children were collected from three studies (Chiodera et al., 2008; Vandorpe et al., 2011; Lopes et al., 2012) in order to compare with those of Albanian children. A brief overview of the studies taken into consideration for comparison reasons described on the Table 2. Institutional Review Board of the University approved this research. Informed consent forms were obtained from both parents and children prior to study participation.

Table 2: Characteristics of the studies obtained for country comparison

Study	Place	Measurement	Age range	N-total
(Chiodera et al., 2008)	Italy	weight, height, BMI	6-10 yr	4500
(Vandorpe et al., 2011)	Belgium	weight, height, BMI, KTK	6-12 yr	2470
(Lopes et al., 2012)	Portugal	weight, height, BMI, KTK	6-14 yr	7175

Study design

Body height and body mass were measured. BMI was calculated using usual formula (kg/m^2). Children were considered overweight or obese based on age-specific BMI European reference guidelines (Flodmark et al., 2004). Gross motor coordination was evaluated using Kiphard and Schilling (1974, 2007) body coordination test (KTK).

Body height and body mass were measured using a Health O Meter 402 KL professional physician beam scale. Values were recorded to the nearest 0.1 cm and 100 g, respectively. Body mass index was calculated using the usual formula; $\text{BMI} = \text{body mass (kg)} / \text{body height (m)}^2$. To assess gross motor coordination we used Body Coordination Test for Children (KTK) (Kiphard and Schilling, 1974, 2007) using a final score (MQ- motor quotient). It consists of four subtests (*balancing backwards test, transference of platforms, lateral jumping, jumping on one leg test*) where each value of a subtest is converted in a motor quotient score. All four values are summed up and converted into a final score.

Statistical analysis

Descriptive statistics (mean and standard deviation) were calculated for the variables assessed in this study. Unpaired T tests were used for the comparison between Albanian children and other European counterparts separately. Means, SD and N of the two samples compared for each age group and country were used for analysis. P-values of ≤ 0.05 were considered statistically significant. All analyses were performed using the statistics software SPSS 17.0.

Results

Table 3 presents' main descriptive data results by gender, for children's categorization of gross motor coordination level obtained from KTK test and BMI percentile classification.

Table 3: Classification of gross motor coordination level and BMI percentile ranking

GMC (%)	high/good	normal	moderate motor disorder	severe motor disorder
Mean	1.5	59.3	31.2	8
Boys	1.5	65.6	27.1	5.8
Girls	1.4	52.4	35.8	10.4
BMI (%)	underweight	healthy weight	overweight	obese
Mean	5.2	80.8	10.2	3.8
Boys	2.3	81.6	10.4	5.7
Girls	8.3	79.5	10	2.2

Notes: Mean values refer to percentage of children by gender. BMI percentile ranking for weight status; underweight = less than 5th percentile, healthy weight = 5th percentile to less than 85th percentile, overweight = 85th percentile to less than 95th percentile, obese = equal to or greater than the 95th percentile.

Abbreviations: GMC - gross motor coordination; BMI - body mass index

The children who were categorized at normal level represented only 59.3% of the entire sample, while almost 39% of the participants in the study were categorized below the normal level, having probably moderate motor disorder (31.2%) and severe motor disorder (8%). Boys (65.6%) showed significantly better results than girls (52.4%) in the normal category ($p \leq 0.05$). The motor quotient for the category of severe motor disorder for boys was 5.8% and for girls was 10.4% ($p \leq 0.05$).

The prevalence of overweight was 10.2% and did not change among boys and girls (10.4% and 10% respectively). Significant differences were observed between boys and girls regarding prevalence of obesity (5.7% boys and 2.2% girls, $p \leq 0.05$). The prevalence of obesity was 3.2% for the entire sample of elementary school children (aged 7-10 yrs old).

The comparisons of our results with those related to European children (Portugal, Belgium and Italy) are reported in Table 4. Overall, Albanian children in four age groups showed lower values in weight compared to Portuguese children (7 yrs: $t=5.91$, $p=0.00$; 8 yrs: $t=2.72$, $p=0.01$; 9 yrs: $t=3.65$, $p=0.00$; 10 yrs: $t=0.56$, $p=0.56$ NS) while comparing with Belgian children mean values showed an equal weight with the exception of age 7 years old where Albanian children had a lower weight (7 yrs: $t=3.66$, $p=0.00$).

Table 4: Comparison between Albanian children and European counterparts for body mass, height, BMI and gross motor coordination values

		7 years			8 years			9 years			10 years		
		mean	SD	P	mean	SD	P	mean	SD	P	mean	SD	P
B-Mass (kg)	Albania	25.1	4.6		29.5	6.2		32.1	5.9		36.3	8.5	
	Portugal	27.5	6.4	0.00	31.1	7.5	0.01	34.4	8.5	0.00	36.7	9.1	0.56
	Belgium	26.3	4.6	0.00	29.5	5.8	1.00	32.1	6.0	1.00	36.0	7.2	0.61
B-Height (cm)	Albania	122.8	5.2		128.2	5.7		134.2	5.8		139.6	6.1	
	Portugal	125.1	6.3	0.00	130.8	6.7	0.00	135.6	7.5	0.01	139.3	7.6	0.58
	Belgium	126.7	5.6	0.00	132.3	5.5	0.00	137.3	6.1	0.00	142.7	6.5	0.00
BMI (kg/m ²)	Albania	16.6	2.3		17.8	2.7		17.7	2.7		18.5	3.4	
	Portugal	17.4	3.0	0.00	18.0	3.2	0.43	18.6	3.4	0.00	18.7	3.5	0.46
	Belgium	16.3	2.1	0.55	16.7	2.5	0.00	16.9	2.4	0.00	17.6	2.7	0.00
	Italy	16.3	2.3	0.07	16.9	2.5	0.00	17.2	2.6	0.03	17.9	3.1	0.01
KTK (sum MQ)	Albania	89.4	11.7		90.2	12.0		90.3	12.7		86.3	12.4	
	Portugal	84.6	15.2	0.00	84.2	16.1	0.00	81.4	15.3	0.00	83.0	15.1	0.06
	Belgium	99.0	13.9	0.00	97.9	14.4	0.00	95.3	14.0	0.00	92.4	13.1	0.00

Abbreviations: T- t values and P- p values. This data are obtained from Unpaired T tests analysis

Significant body height differences were found on four age groups where the results showed that Albanian children were shorter than their European younger counterpart (Portuguese and Belgian children). Comparing the overall results on BMI, the Albanian children had lower mean values than Portuguese children (7 yrs: $t=4.11$, $p=0.00$; 8 yrs: $t=0.79$, $p=0.43$ NS; 9 yrs: $t=3.47$, $p=0.00$; 10 yrs: $t=0.74$, $p=0.46$ NS), higher mean values than Belgian children (7 yrs: $t=1.92$, $p=0.55$ NS; 8 yrs: $t=5.34$, $p=0.00$; 9 yrs: $t=4.06$, $p=0.00$; 10 yrs: $t=3.91$, $p=0.00$), and higher mean values than Italian children (7 yrs: $t=1.8$, $p=0.07$ NS; 8 yrs: $t=4.02$, $p=0.00$; 9 yrs: $t=2.18$, $p=0.03$; 10 yrs: $t=2.54$, $p=0.01$). The children in the Albanian sample scored generally higher on the total KTK (mean MQ in four age groups) than the Portuguese children (7 yrs: $t=4.86$, $p=0.00$; 8 yrs: $t=4.89$, $p=0.00$; 9 yrs: $t=7.56$, $p=0.00$; 10 yrs: $t=3.07$, $p=0.06$ NS), and scored lower than Belgian children (7 yrs: $t=10.43$, $p=0.00$; 8 yrs: $t=7.01$, $p=0.00$; 9 yrs: $t=4.64$, $p=0.00$; 10 yrs: $t=6.38$, $p=0.00$).

Discussion

The children that were categorized at normal level represented only 59.3% of the entire sample, while almost 39% of participants in the study were categorized below the normal level, having probably moderate motor disorder (31.2%) and severe motor disorder (8%). These results are consistent with those from the study of Qose (2012) who investigated the prevalence of DCD (development coordination disorder) in 100 elementary school children in Tirana. Results of the study showed that the prevalence of development coordination disorder among children was 45%.

Boys (65.6%) showed significant ($p \leq 0.05$) better results than girls (52.4%) in the normal category for the level of gross motor coordination. The motor quotient for the category of severe motor disorder was 5.8% for boys and 10.4% for girls respectively. In contrast to the results of our study, boys-girls ratio in the study of (Qose, 2012) ranges from 1: 0.7 regarding children classified with developmental coordination disorder to 1: 0.8 concerning children classified at borderline. Boys with DCD according to test results outnumbered girls. The results from both studies reveal strong evidence that children in Albania show motor difficulties in everyday skills. The prevalence of overweight was 10.2% and did not change among boys and girls (10.4% and 10% respectively). The prevalence of obesity was 3.2% for the entire sample of elementary school children (aged 7-10 yrs).

Albania is situated on the eastern shore of the Adriatic Sea bordering Italy, with Montenegro and Serbia to the north, Macedonia to the east, and Greece to the south. It is encouraging to compare the data from the current study with those established by Janssen et al. (2005) and Ostojic et al. (2011). The prevalence of overweight in Albanian children (10.2%) is low compared to Italy (15%) and Greece (15%) and almost the same with Macedonia (10.5%).

However, the findings from the study of Janssen et al. (2005) must be interpreted with caution because body weights and heights values taken into consideration to calculate BMI were self-reported. Significant differences were observed between boys and girls regarding prevalence of obesity (5.7% boys and 2.2% girls, ($p \leq 0.05$)). This finding is in agreement with Krassas et al. (2001) findings where boys had higher values compared to girls in the prevalence of overweight and obesity. However, these results differ from a published study by (Al-Nakeeb et al., 2007) in which it was reported higher prevalence of overweight and obesity in girls.

Overall, Albanian children in four age groups showed lower values in weight compared to Portuguese children while comparing with Belgian children mean values showed an equal weight with the exception of age 7 years where Albanian children had a lower weight. The results showed that Albanian children were shorter than their European younger counterpart (Portuguese and Belgian children). Comparing the overall results on BMI, the Albanian children had lower mean values than Portuguese children and higher mean values than Belgian and Italian children. The children in the Albanian sample scored generally higher on the total KTK (mean MQ in four age groups) than the Portuguese children and scored lower than Belgian children.

Conclusion

The results from this investigation study reveal strong evidence that children in Albania show motor difficulties in everyday skills (moderate motor disorder-31.2% and severe motor disorder-8%). To be concerned were the number of children that fell into the level of severe motor disorder (8%) that will be the focus of future studies to be evaluated for having probably motor coordination disorder (possible DCD).

References

1. Al-Nakeeb Y, Duncan M J, Lyons M and Woodfield L (2007). Body fatness and physical activity levels of young children., *Ann Hum Biol* 34(1), 1–12.
2. Boreham C, Robson P J, Gallagher A M, Cran G W, Savage J Mand Murray L J (2004). Tracking of physical activity, fitness, body composition and diet from adolescence to young adulthood: The Young Hearts Project, Northern Ireland., *Int J Behav Nutr Phys Act* 1(1), 14.
3. Bouffard M, Watkinson E, Thompson L, Causgrove, Dunn J and Romanow S (1996). A test of the activity deficit hypothesis with children with movement difficulties., 13, 61–73.

4. Chiodera P, Volta E, Gobbi G, Milioli M A, Mirandola P, Bonetti A, Delsignore R, Bernasconi S, Anedda A and Vitale M (2008). Specifically designed physical exercise programs improve children's motor abilities., *Scand J Med Sci Sports* 18(2), 179–187.
5. Flodmark C E, Lissau I, Moreno L A, Pietrobelli A and Widhalm K (2004). New insights into the field of children and adolescents' obesity: the European perspective., *Int J Obes Relat Metab Disord* 28(10), 1189–1196.
6. Janssen I, Katzmarzyk P T, Boyce W F, Vereecken C, Mulvihill C, Roberts C, Currie C, Pickett Wand H B (2005). Comparison of overweight and obesity prevalence in school-aged youth from 34 countries and their relationships with physical activity and dietary patterns., *Obes Rev* 6(2), 123–132.
7. Katzmarzyk P T and Tremblay M S (2007). Limitations of Canada's physical activity data: implications for monitoring trends., *Can J Public Health* 98 Suppl 2, S185– S194.
8. Kelishadi R (2007). Childhood overweight, obesity, and the metabolic syndrome in developing countries., *Epidemiol Rev* 29, 62–76.
9. Kiphard E and Schilling F (1974). kÄrperkoordinationstest fÄjr Kinder.
10. Kiphard E and Schilling F (2007). KÄrperkoordinationstest fÄjr Kinder. 2. ÄIJbearbeitete
11. und ergaÄl nzen Auflage.
12. Krassas G E, Tzotzas T, Tsametis C and Konstantinidis T (2001). Prevalence and trends in overweight and obesity among children and adolescents in Thessaloniki, Greece., *J Pediatr EndocrinolMetab* 14 Suppl 5, 1319–26; discussion 1365.
13. Lobstein T, Baur L, Uauy R (2004). Obesity in children and young people: a crisis in public health., *Obes Rev* 5 Suppl 1, 4–104.
14. Lopes V P, Stodden DF, Bianchi MM, Maia J A R and Rodrigues L P (2012). Correlation between BMI and motor coordination in children., *J Sci Med Sport* 15(1), 38–43.
15. Martins D, Maia J, Seabra A, Garganta R, Lopes V, Katzmarzyk P and Beunen G (2010). Correlates of changes in BMI of children from the Azores islands., *Int J Obes (Lond)* 34(10), 1487–1493.
16. Nuri B and Tragakes E (2002). Health care systems in transition: Albania.
17. Ogden C L, Carroll MD, Curtin L R, Mc Dowell MA, Tabak C J and Flegal KM (2006). Prevalence of overweight and obesity in the United States, 1999-2004., *JAMA* 295(13), 1549–1555.
18. Ostojic S M, Stojanovic MD, Stojanovic V, Maric J and Njaradi N (2011). Correlation between fitness and fatness in 6-14-year old Serbian school children., *J Health Popul Nutr* 29(1), 53–60.
19. Qose G (2012), 'Development coordination disorder in Albanian children'. Master thesis
20. Rechel B and Mc Kee M (2003). Healing the crisis: A prescription for public health action in South Eastern Europe.
21. Vandorpe B, Vandendriessche J, Lefevre J, Pion J, Vaeyens R, Matthys S, Philippaerts R and Lenoir M (2011). The KurperkoordinationsTest fur Kinder: reference values and suitability for 6-12-year-old children in Flanders., *Scand J Med Sci Sports* 21(3), 378–388.
22. Venn A J, Thomson R J, Schmidt MD, Cleland V J, Curry B A, Gennat H C and Dwyer T (2007). Overweight and obesity from childhood to adulthood: a follow-up of participants in the 1985 Australian Schools Health and Fitness Survey., *Med J Aust* 186(9), 458–460.
23. Wrotniak B H, Epstein L H, Dorn J M, Jones K E and Kondilis V A (2006). The relationship between motor proficiency and physical activity in children., *Pediatrics* 118(6), e1758–e1765.

PUPILS PHYSIOLOGICAL LOAD IN THE LESSON OF PHYSICAL EDUCATION IN THE COMBINED AND THE STANDARD CLASSROOMS

Srna Jenko Miholic, Ivan Prskalo and Marina Prebila

Faculty of Teacher Education, University of Zagreb, Croatia

Abstract

Combined classes are formed by merging several classes of different ages groups. The aim of this study was to determine whether there is a statistically significant difference in the physiological load in the PE lessons for pupils in combined classes compared to pupils in standard classes. For purposes of this study a sample of 174 pupils was collected. The sample of variables consisted of five heart-rate according to the parts of the lesson. Sample of pupils in the combined classes was compared with those in the standard classes from first to fourth grade in primary education. The results showed differences in the age group of first grade, in second grade there was no significant difference, while in the third and fourth grade differences were observed only in some parts of the PE lesson. This study has shown that despite so to say an attempt to equalize the implementation of the teaching process in combined and standard classes differences still exist.

Key words: load in the lecture; primary education; testing the differences

Introduction

Teaching is a well-planned part of an organized educational process which consists of a specific tasks and goals. According to Prskalo from 2004 teaching process is important for achieving the goals and tasks of physical education, it is complex process with its principles and direction, duration and structure. Important role in successful accomplishment of the educational process belongs to class structure and organization who in the end support the effects of teaching physical education.

The basic organizational form of teaching physical education is a class lesson provides a systematic and planned influence on the anthropological status of the pupils. Load in the PE depends on: the selection and order of exercises, intensity and frequency of exercises, tempo and rhythm of the exercises performed and the internal factors (pupils age, the number of students in the class, working conditions), as well as external factors (location and time in the day, air temperature, other atmospheric and climatic conditions, etc. (Findak, 2003). Studies has shown that implementation of appropriate methodical organizational work forms under the condition of preparedness for a specific work generate greater physiological load (Prskalo, 2002; Findak, Prskalo, Pejčić, 2003).

According to Bognar and Matijević from 2005 teaching process is organized labor process in mastering the prescribed content and the acquisition of knowledge, skills and habits as preparing pupils for further permanent work. The components of the educational system are: pupil, teacher, teaching content, working conditions (space and equipment), and relationships among class participants. Classes are held in schools, which are organized as an elementary school with its branch school. One elementary school may have a few of its branch school in which are usually performed classes from first to fourth grade and could be organized as the standard or combined classes, depending on the number of the pupils.

Teaching in primary schools takes place in classrooms and basically these are the standard classes. Number of students in one class varies from 14 to 28 pupils. In one standard classroom with pupils work one teacher. in that case load of physical education classes can be freely adapted to the class. Beside the standard classes sometimes there is a need for the combined classes that typically arise in regional schools with fewer students. Combination classrooms are classroom settings in which students at two grade levels learn and work together with one teacher. Combo classes could be arranged as two-grade, three-grade or even a four-grade combination. In combined classes is harder to work than in a standard classroom because the teacher has to devote to more grade pupils at the same time. In teaching PE occurs even bigger problem because usually it is about a relatively small schools who most often do not have a school sports hall. When most often two, sometimes three or four classes are working together at the same time practice comes to issues of diversity curriculum topics. Teachers usually organizes lessons in the way all the pupils work the same opening, preparatory, B-part and final part of a class and in the main A-part of the lesson they work in the specific organizational forms where every form group is performing tasks according to their age. All this could be very demanding, so some teachers decide for even the same lesson for all but in the higher or the lower level of performance.

The aim of this study was to determine whether there was a statistically significant difference in the physiological load of pupils in the PE lessons for the pupils in combined classrooms compared to pupils in the standard classrooms.

In accordance with the study, four null hypotheses are set. The first hypothesis is as follows: In PE classes first grade pupils at physiological load in combined classes will not be significantly different from those in the standard classes when performing identical instructional content. Second hypothesis is set as: In PE classes of the second grade pupils at physiological load in combined classes will not be significantly different from those in the standard classes when performing identical instructional content. The third hypothesis is: In PE classes of the third grade pupils at physiological load in combined classes will not be significantly different from those in the standard classes when performing identical instructional content. Last fourth hypothesis is set as: In PE classes of the fourth grade pupils at physiological in combined classes will not be significantly different from ones in the standard classes when performing identical instructional content.

Research methodology

Examinee sample. The sample was composed of the pupils from two primary schools which in its organization have a branch schools with combined classes-Elementary School “Great Trgovišće” with its local branch “Strmec” and elementary school “Krapinske Toplice” with its local branch “Gregurovec” and “Little Erpenja”. The study included a total of 174 pupils in lower grades of elementary school as shown in Table 1. All the pupils of the combined classes are included and the sample in the standard classes made up of an equal number of pupils as well as the combined class using a randomized sample.

Table 1: Number of examinee to the combined and standard classes according to the age

	Name of the school	Grade →	1.	2.	3.	4.	TOTAL
COMBINED CLASSES	“Veliko Trgovišće” – Strmec		7	10	8	6	31
	“Krapinske Toplice” – Gregurovec		5	7	9	6	27
	“Krapinske Toplice” – Mala Erpenja		9	10	6	4	29
STANDARD CLASSES	“Veliko Trgovišće”		7	10	8	6	31
	“Krapinske Toplice”		5	7	9	6	27
	“Krapinske Toplice”		9	10	6	4	29
	TOTAL		42	54	46	32	174

Variables sample. Variables sample consisted of five heart rates as shown in Table 2. Heart rates were measured in all five parts of the lesson. Based on the collected frequency averaged hart rate was calculated for all parts of the lesson.

Table 2: Variables sample

Term	Abbreviation	Mesure unit
Heart rate in the opening part of a lesson	FsO	The number of repetition
Heart rate in the preparatory part of a lesson	FsP	
Heart rate in the main A part of a lesson	FsA	
Heart rate in the B part of a lesson	FsB	
Heart rate in the final part of a lesson	FsF	

Data analyses. Data were collected during regular PE classes. 3rd grade and 4th grade pupils were measured hart-rate for themselves, while the adults instructed examiners were measured hart-rate for pupils in 1st and 2nd grade. In each class, the class hart-rate was measured twice to cover the total number of students and verify the authenticity of the information. The collected data are processed by basic descriptive statistics and Kolmogorov-Smirnov test (KS test) was made to test the normality. For statistical analysis of the data, the statistical program “Statistica 10” was used and in the finaly Student’s t-test was applied for differences between groups at the level of significance of 95% ($p < 0.05$).

Specific curriculums were planned for the each lesson. The following Table 3. displayed briefly preparation for the lessons used in classes that participated in this study.

Table 3: Used lesson plans

Lesson parts	first grade	second grade	third grade	fourth grade
Opening	Running with the tasks			
Ppreparatory	General preparatory exercise with hoops			
Main A	1. Forward roll down the slope 2. Skipping a short rope in place	1. Forward roll 2. Skipping a short rope in motion	1. Pulling and suppression partner in different ways without aids 2. Cyclic movement of a different pace up to 3 minutes 3. "Children" jumps	1. Connecting roll forward and roll backwards 2. Speed run up to 50 m from the semi-high start 3. Dance
Main B	Obstacle course			
Final	Faking ball			

Results and Discussion

The results are shown by the table to subsamples defined by the grade. Table 4 presents the basic descriptive indicators for certain grade relating to standard and combined classes.

Tablica 4: Basic descriptive statistic for 1st to 4th grade pupils in combined and standard classes

		N	M	Min	Max	SD	Skew	Kurt	Max D	K-S test
FIRST GRADE										
combined classes	FsO	21	121,19	80	153	20,24	-0,30	-0,96	0.22	p>.20
	FsP	21	114,90	102	146	10,85	1,26	2,07	0.17	p>.20
	FsA	21	127,05	91	142	12,33	-1,15	2,17	0.14	p>.20
	FsB	21	137,81	79	158	15,99	-2,60	9,16	0.12	p>.20
	FsF	21	99,72	84	114	7,93	-0,44	-0,38	0.18	p>.20
standard classes	FsO	21	101,57	69	137	15,19	0,54	1,73	0.17	p>.20
	FsP	21	99,24	65	146	18,06	0,22	1,65	0.17	p>.20
	FsA	21	111,14	69	130	14,58	-1,25	2,17	0.16	p>.20
	FsB	21	121,24	68	158	21,47	-1,15	1,40	0.16	p>.20
	FsF	21	88,48	62	107	13,63	-0,55	-0,79	0.16	p>.20
SECOND GRADE										
combined classes	FsO	27	100,85	75	127	11,59	-0,36	0,79	0.14	p>.20
	FsP	27	110,70	89	133	12,27	0,29	-0,86	0.11	p>.20
	FsA	27	120,96	102	151	12,92	0,76	-0,8	0.17	p>.20
	FsB	27	141,19	105	170	1,61	-0,25	-0,29	0.09	p>.20
	FsF	27	100,48	81	129	10,60	0,44	0,91	0.11	p>.20
standard classes	FsO	27	105,74	84	130	12,36	0,09	-0,72	0.13	p>.20
	FsP	27	110,96	100	130	9,26	0,75	-0,75	0.15	p>.20
	FsA	27	123,44	94	153	13	0,28	0,61	0.14	p>.20
	FsB	27	136,07	100	164	16,41	0,01	-0,38	0.10	p>.20
	FsF	27	97,00	61	115	13,11	-0,59	0,53	0.9	p>.20
THIRD GRADE										
combined classes	FsO	23	117,91	90	151	17,96	0,48	-0,74	0.15	p>.20
	FsP	23	112,22	84	139	14,59	0,07	-0,98	0.14	p>.20
	FsA	23	128,43	86	166	18,77	-0,64	0,97	0.14	p>.20
	FsB	23	144,91	120	180	15,35	0,43	-0,14	0.14	p>.20
	FsF	23	96,70	76	121	10,07	0,14	0,69	0.14	p>.20
standard classes	FsO	23	104,74	85	124	12,03	-0,17	-1,22	0.13	p>.20
	FsP	23	113,96	93	127	9,21	-0,61	-0,42	0.11	p>.20
	FsA	23	126,17	100	142	9,93	-0,69	0,81	0.10	p>.20
	FsB	23	140,22	121	159	10,64	0,22	-0,67	0.08	p>.20
	FsF	23	102,87	82	119	9,60	-0,76	0,07	0.15	p>.20

FOURTH GRADE										
combined classes	FsO	16	116,94	102	160	15,59	1,77	3,12	0,21	p>.20
	FsP	16	112,18	90	132	15,72	-0,07	-1,76	0,15	p>.20
	FsA	16	134,69	114	161	15,34	0,14	-1,17	0,13	p>.20
	FsB	16	138,19	100	163	18,47	-0,95	0,56	0,16	p>.20
	FsF	16	94,00	82	103	6,59	-0,22	-1,10	0,12	p>.20
standard classes	FsO	16	101,75	87	127	10,51	1,01	1,11	0,17	p>.20
	FsP	16	105,88	90	130	11,82	0,61	-0,62	0,18	p>.20
	FsA	16	117,81	102	133	7,93	-0,42	0,36	0,18	p>.20
	FsB	16	128,56	112	148	10,97	-0,09	-0,91	0,14	p>.20
	FsF	16	93,88	80	109	9,45	0,12	-1,10	0,11	p>.20

Legend: number of subjects (N), mean (M), the minimum value (Min), maximum value (Max.) standard deviation (SD), coefficient of skewness (Skew), coefficient of curvature (Kurt), Kolmogorov-Smirnov test (KS test), FsO-heart rate in the opening part of a lesson, FsP-heart rate in the preparatory part of a lesson, FsA-heart rate in the main A part of a lesson, FsB-heart rate in the B part of a lesson, FsF-heart rate in the final part of a lesson

Data were tested with Kolmogorov-Smirnov test which showed that the results are subject to normal distribution in all grades in all combo and all the standard classes.

Table 5. Determining the difference in between the combined and the standard classes by grades with t-test at the significance level of 95% ($p < 0.05$)

grade	FsO		FsP		FsA		FsB		FsF	
	t-test	p	t-test	p	t-test	p	t-test	p	t-test	p
1 st	4,15*	0,0002	3,41*	0,0015	4,38*	0,0001	3,90*	0,0004	3,27*	0,0022
2 nd	-1,50	0,1398	-0,09	0,9305	-0,70	0,4848	1,10	0,2750	1,07	0,2884
3 rd	2,92*	0,0054	-0,48	0,6310	0,51	0,6122	1,20	0,2344	-2,13*	0,0389
4 th	3,23*	0,0029	1,28	0,2089	3,91*	0,0004	1,79	0,0832	0,04	0,9656

Legend: FsO-heart rate in the opening part of a lesson, FsP-heart rate in the preparatory part of a lesson, FsA-heart rate in the main A part of a lesson, FsB-heart rate in the B part of a lesson, FsF-heart rate in the final part of a lesson

Student's t-test at significance level of 95% ($p < 0.05$) was made to determine the differences as shown in Table 5. In the first grade it has been proved statistically significant difference in all stages of the lesson: opening part ($p < 0.0002$), preparatory part ($p < 0.0015$), main A part of the lesson ($p < 0.0001$), B-part ($p < 0,0004$) and final part ($p < 0.0022$). Therefore, according to the results first set of hypotheses has been rejected – there are no statistically significant differences in the physiological load on teaching PE to first grade pupils in combined classes in relation to those in the standard classes.

Applying the t-test to second grade classes it could be seen that there is no statistically significant difference between the pupils in the combined and standard classes in any stage of teaching: an opening part ($p < 0.1398$), preparatory part ($p < 0.9305$), A-part ($p < 0.4848$), B-part ($p < 0.2750$), and the final part ($p < 0.2884$). So the second null hypothesis has been accepted - there are no differences between the physiological load of pupils who attend combined classes and those who attend standard classes in the second grade of primary schools.

Statistical analysis of the heart-rate data during PE lessons in the third grade in the combined and standard classes indicate the results of existence statistical significance difference in the opening part ($p < 0.0054$) and in the final part of the lessons ($p < 0.0389$). The other three parts of the lessons did not show statistical significance: the preparatory part ($p < 0.6310$), the main A-part ($p < 0.6122$), the B-part ($p < 0.2344$). Therefore, the third hypothesis was partially accepted.

In fourth grade also has been observed a significant difference in the opening ($p < 0.0029$), but in this age group it has been noted significant difference in the main A-part of the lesson ($p < 0.0004$). In the rest of the lesson there were no difference: the preparatory part ($p < 0.2089$), the main B-part ($p < 0.0832$) and the final part ($p < 0.9656$). The fourth hypothesis was also partially accepted - as a physiological load in the PE lessons does not distinguish between standard and combined classes in the fourth grade.

Physiological load is precondition for desirable transformation process specifically in childhood when it leaves significant consequences and affects the harmonious growth and development. This is especially important in preparing today's pupils for life in circumstances where movement is marginalized. Contemporarily understanding of successfulness is less linked to motor behaviour and more on an intellectual level. Modern living conditions caused by stressful situation has been noticed already in children and depression becomes the everyday life of modern man. Fatigue, in the labour population, is associated with psychological consequences (Bultmann et al., 2002).

Conclusion

Based on data collected in the PE classes about physiological load to pupils in the combined classes and their comparison with those in the standard classes, it needs to be said, for the final conclusion it should conduct further research on larger and more representative samples.

This research has shown that the majority of students resulted with high-frequency heart rate at a given load. Pursuant to the hypotheses, the first hypothesis, which says that there is no statistically significant differences in the physiological load on teaching physical education to pupils in combined classes and those in standard classes was rejected. Based on the obtained results and the absence of differences in the physiological load during physical education lessons the second hypothesis was accepted. The third hypothesis of no statistically significant differences in the physiological load on teaching physical education to pupils in the third grade in between the combined and standard classes was partially accepted due to lack of difference between the three of the five measured variables. Similar results were also obtained in the fourth grade, so the fourth hypothesis was also partially accepted. Statistically significant difference in all parts of the PE lessons was obtained only in the first grade and it can be explained by the transition from kindergarten to school, and in the first grade it is still ongoing process of adjustment. The results obtained are in favour of teachers who demonstrate a satisfactory level of preparation and good work with children, considering that the work in combined classes among teacher's population is not popular and requires greater efforts in planning and teaching by teachers. For more quality planning of teaching process for the teacher is extremely important feedback on the current state of pupils and their transformation process during the school year what leads to a clear space for diagnostic in the teaching process, which can easily be implemented by measuring the heart rate.

References

1. Andrilović, V. (1996): *Psihologija učenja i nastave*. Zagreb, Školska knjiga.
2. Bognar, L., Matijević, M. (2005): *Didaktika*. Zagreb, Školska knjiga.
3. Bültmann, U., Kant, I., Kasl, S.V., Beurskens, A. J.H.M., Van den Brandt, P.A. (2002). Fatigue and psychological distress in the working population Psychometrics, prevalence, and correlates. *Journal of Psychosomatic Research*. 52(6), 445– 452.
4. Findak, V. (1996): *Tjelesna i zdravstvena kultura u osnovnoj školi: priručnik za učitelje razredne nastave*, Zagreb: Školska knjiga.
5. Findak, V. (2003): *Metodika tjelesne i zdravstvene kulture*. Zagreb, Školska knjiga.
6. Findak, V., Metikoš, D., Mraković, M. (1992): *Kineziološki priručnik za učitelje*. Zagreb, Hrvatski pedagoško-književni zbor.
7. Findak, V., Prskalo, I., Pejčić, A. (2003). Additional exercise as an efficiency factor in physical education lessons. *Kinesiology*. 35(2), 143-154.
8. Gomerčić, S., Kovačević, Ž., Emeljanovas, A. (2011): Opterećenje vježbanja tijekom provedbe različitih sadržaja pripremnom dijelu sata tzk. In I. Prskalo, D. Novak (Eds.), *Proceedings book 6. kongres FIEP-a Europa, Poreč*, (pp. 169-175). Zagreb, Hrvatski kineziološki savez.
9. Kolić, S., Šafarić, Z., Babić, D. (2011): Analiza opterećenja vježbanja tijekom provedbe različitih sadržaja u završnom dijelu sata. In V. Finak (Ed.), *Proceedings book 20. ljetne škole kineziologa RH, Poreč*, (pp. 430-436). Zagreb, Hrvatski kineziološki savez.
10. Prskalo, I. (2002). Physiological workload and additional exercising in physical education lessons. In D. Milanović, F. Prot (Eds) *Proceedings book 3 rd international scientific conference, Kinesiology - New perspectives*. (pp.102–104). Zagreb, Faculty of Kinesiology, University of Zagreb.

COMPARISON OF DIFFERENT REGRESSION MODELS BETWEEN COORDINATION AND SELECTED VARIABLES OF ANTHROPOLOGICAL STATUS

Marino Krespi¹, Igor Jelaska² and Petra Mandić Jelaska^{2,3}

¹Ph.D. Student of Kinesiology, University of Split, Croatia

²Faculty of Kinesiology, University of Split, Croatia

³Fitness Club "Pink Panther", Kaštel Stari, Croatia

Abstract

The aim of this study was to apply and compare linear, parabolic and logarithmic regression models between coordination as criteria and the selected variables of anthropological status. The subject sample included 40 male fourth grade primary school pupils (age 10.3 ± 0.5 years) who were measured in the following variables: obstacle course backwards (MPOL), seated straddle stretch (MPRR) and triceps skinfold (ANN). All the applied regression models indicate a positive correlation between the ANN variable and the MPOL variable, with the MPOL variable being negatively scaled. In the parabolic model, the regression parameter of ANN variable, although non-significant, has negative sign. Also the MPRR variable has a negative coefficient only in the parabolic model, more precisely in the linear term, while it has a positive coefficient in all other models. Finally, the results indicate the fact of complex and non-linear correlations between the selected variables and point to the necessity of development and application of non-standard methodological tools as a very important aspect of kinesiological science.

Introduction

In various scientific areas, there have been numerous studies with the aim of thoroughly analysing and understanding the complex processes of functioning and development of the human organism as a whole as well as of its integral parts. In the area of kinesiology, the analysis of transformational effects of physical activity on some human characteristics as well as the analysis of correlation between different biomotor dimensions is an important scientific problem (Malina & Bouchard, 1991). The aforementioned especially refers to motor abilities and morphological traits. An important motor ability, "motor intelligence" yet, is coordination. Movement coordination is often considered as fast and efficient performance of complex and various motor tasks in complicated and unpredictable situations (Malacko & Doder, 2008). Furthermore, in scientific and professional literature movement coordination is often defined as the ability to efficiently solve complex motor problems in terms of synchronising reciprocal, non-linear and interactive relations between cognitive and motor abilities (Kirkendall & Gruber, 1970). Furthermore, coordination is considered one of the most complex motor abilities and in most sports, research on correlation between coordination abilities, morphological characteristics and basic motor abilities is of great importance. It is important to emphasize that a certain type of body build may directly interfere with the realisation of a kinetic programme in a certain motor situation, while the same body build can be extremely advantageous in another motor situation (Hošek-Momirović, 1981). The aforementioned additionally indicates the complexity of the problem of correlation of morphological variables and variables manifesting coordination. On the other hand, regression models, whether linear or non-linear, are one of the most effective methodological tools of applied sciences (Rencher, 2002; Jelaska, Maleš & Kuna, 2011). Thus, the main aim of this study was to compare the appropriateness and limitations of different regression models between coordination and the selected variables of anthropological status. More precisely, variables of seated straddle stretch and triceps skinfold, as appropriate representatives of latent dimensions of flexibility and subcutaneous fat tissue, were selected as predictors.

Methods

In the present study the subject sample included 40 male fourth grade primary school pupils (10.3 ± 0.5 years) who were measured in the following variables: obstacle course backwards (MPOL), seated straddle stretch (MPRR) and triceps skinfold (ANN). All measurements were taken 3 times. The following descriptive statistics parameters were calculated for all variables and items: mean, standard deviation, coefficient of variation, minimum and maximum result and coefficients of skewness and kurtosis; while significance of the Kolmogorov-Smirnov test was calculated to test the normality of distribution of the variables. Also, regression models were presented graphically. Three regression models (parabolic, logarithmic and linear) between the criterion variable (MPOL) and predictor variables MPRR and ANN were calculated.

Parabolic model: $MPOL = b_1MPRR^2 + b_2MPRR + b_3ANN^2 + b_4ANN$

Logarithmic mode (natural logarithm): $MPOL = b_0 + b_1Log(MPRR) + b_2Log(ANN)$

Multiple regression –linear model: $MPOL = \beta_1Log(MPRR) + \beta_2Log(ANN)$

Proportion of variance accounted for was calculated for non-linear models, while the coefficient of multiple correlation and the coefficient of multiple determination were calculated for the linear model. The Gauss-Newton method was used to calculate the model parameters.

Results

The results of descriptive statistics and the results of distribution normality testing are presented in Table 1.

Table 1: Results of descriptive statistics. Mean±standard deviation (M±σ), Median (Med), minimum result (Min), maximum result (Max), skewness (α₃), kurtosis (α₄), significance of Kolmogorov-Smirnov test (KS-p)

	M±σ	Med	Min	Max	CV.	α ₃	α ₄	KS-p
ANN	11.23±4.88	9.50	5.00	24.00	43.48	1.16	0.72	<0.20
MPOL	173.88±44.95	170.50	120.00	330.00	25.85	1.35	2.61	>0.20
MPRR	58.05±16.35	62.50	23.00	80.00	28.16	-0.58	-0.82	>0.20

By reviewing the results in Table 1 it can be concluded that this is a relatively homogenous sample. Furthermore, it is clear that all the variables have normal distribution. By examining the relative variability of variables of the observed sample described by the coefficient of variation, it can be seen that the ANN variable had the highest variability. Furthermore, parameters of regression models of correlation between the selected variables are presented in Table 2.

Table 2: Coefficients β of the applied regression models, related significance and proportion of variance accounted for: $MPOL = \beta_1MPRR + \beta_2ANN$, $MPOL = b_1*MPRR^2 + b_2*MPRR + b_3*ANN^2 + b_4*ANN$ and $MPOL = b_0 + b_1*Log(MPRR) + b_2*Log(ANN)$

Model: $MPOL = \beta_1MPRR + \beta_2ANN$			
	β	t	p
MPRR	-0.44	-3.79	0.00
ANN	0.50	4.26	0.00
Intercept		8.08	0.00
R=0.70 R ² =0.49 p=0.00			
Model: $MPOL = b_1*MPRR^2 + b_2*MPRR + b_3*ANN^2 + b_4*ANN$			
	b	t	p
MPRR	4.08	2.76	0.01
ANN	12.01	2.10	0.04
MPRR ²	-0.05	-3.04	0.00
ANN ²	-0.21	-0.99	0.32
R=0.59 R ² =0.35			
Model: $MPOL = b_0 + b_1*Log(MPRR) + b_2*Log(ANN)$			
	b	t	p
Log(MPRR)	-62.65	-3.89	0.00
Log(ANN)	50.71	3.80	0.00
Intercept	306.85	3.98	0.00
R = 0.70 R ² =0.49			

Graphic presentations of applied non-linear models are presented in Graph 1 and 2.

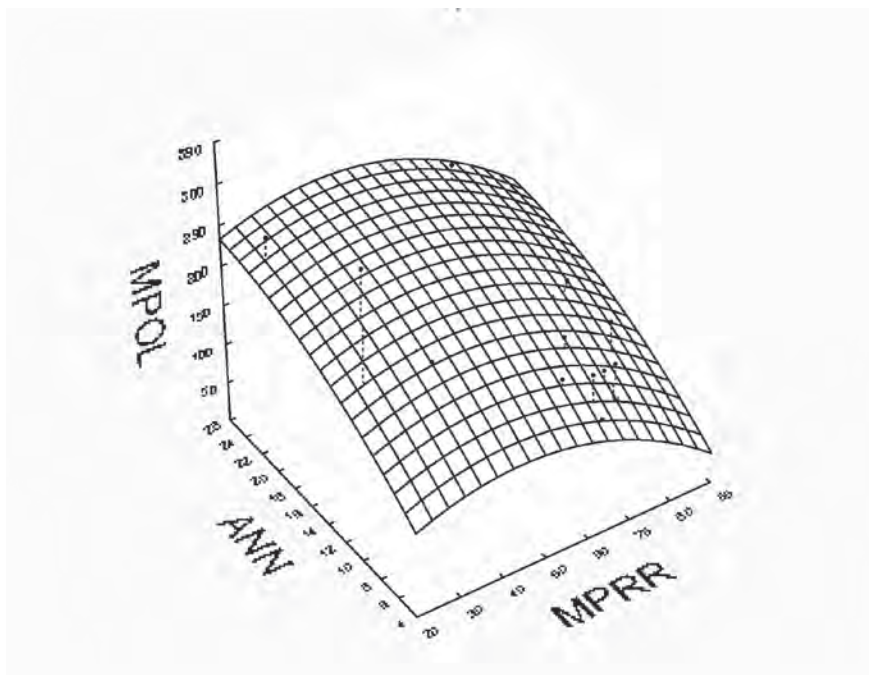

Graph 1: $MPOL = b_1 * MPRR^2 + b_2 * MPRR + b_3 * ANN^2 + b_4 * ANN$

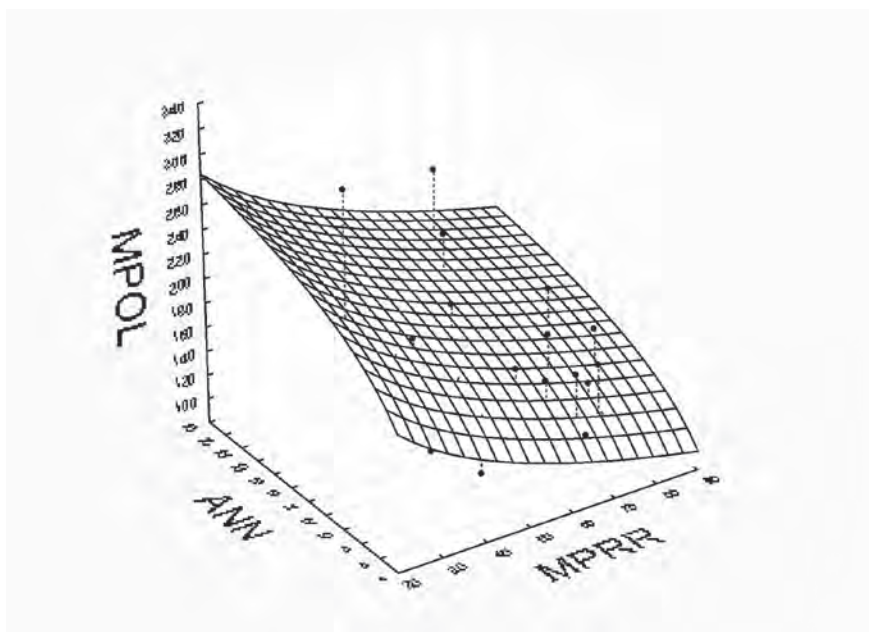

Graph 2: $MPOL = b_0 + b_1 * \text{Log}(MPRR) + b_2 * \text{Log}(ANN)$

Discussion and conclusion

First of all, it must be noted that all parameters except for square in the ANN variable in the parabolic model were statistically significant and the applied logarithm and linear models had equal amount of the explained variability of the criterion variable. The aforementioned unambiguously indicates the appropriateness of applying all regression models. As expected, all regression models indicate a positive correlation between the ANN and the MPOL variable, with the MPOL variable being negatively scaled. In the parabolic model, the parameter standing by the ANN variable, although non-significant, indicates a negative correlation, which further indicates structural complexity of the observed correlation between the criterion variable and the predictors. Given the known effect of the logarithm function, the logarithm model had the highest coefficients in absolute value. Additionally, the correlation of different shape than that in the parabolic

model can be seen in the graph. The MPRR variable had a negative coefficient only in the parabolic model, namely in the linear term, while in all other models it had a positive coefficient. Also from Graph 1 and Graph 2 it can be seen that obtained model are geometrically different. That is probably due to latent and complex interaction between used set of variables. Finally, the results indicate the fact of complex and non-linear correlations between the selected variables and point to the necessity of development and application of non-standard methodological tools as a very important aspect of kinesiological science. Surely, the fact that coordination as a prominent motor ability is conditioned by various variables of morphological status is very significant for clearer and deeper understanding of complex biomechanical systems responsible for manifestation of different motor abilities and skills.

References

1. Hošek-Momirović, A. (1981). *Correlation between morphological taxa and manifest and latent dimensions of coordination* [In Croatian] *Kineziologija* 4(11), 5-108.
2. Jelaska, I., Maleš, B., & Kuna, D. (2011). Influence of learning process on the relation between chosen anthropometric dimensions via linear, parabolic and cubic relation model. *Croatian Journal of Education* 13(1), 76-98.
3. Kirkendall, D.R., & Gruber, J.J. (1970). Canonical relationships between the motor and intellectual achievement domains in culturally deprived high school pupils. *Research Quarterly* 41(4), 496-502.
4. Malacko, J., & Doder, D. (2008). *Technology of sport training and recovery* [In Serbian]. Novi Sad: Pokrajinski zavod za sport.
5. Malina, R.M., & C. Bouchard (1991). *Growth, maturation and physical activity*. Human Kinetic Books.
6. Rencher, A.C. (2002). *Methods of Multivariate Analysis*. 2nd ed. John Wiley & Sons, Inc.

THE INTERACTION BETWEEN THE MORPHOLOGICAL CHARACTERISTICS AND MOTOR SKILLS OF BOYS AND GIRLS AGED 7 TO 11

Julijan Malacko¹, Aleksandra Pejčić² and Braco Tomljenović³

¹University of Novi Sad, The Faculty of Sport and Physical Education, Novi Sad, Serbia

²University of Rijeka, Teacher Training College, Rijeka, Croatia

³University of Zadar, Department of Studies Education in Gospić, Croatia

Introduction

The increasingly severe warnings of the official and wider social environment about the unacceptably low effectiveness and efficiency of physical education classes represent a motive for the onset and choice of focus of modern kinesiological research. The focus of education on learning, that is, acquiring a vast body of knowledge and skills, which today is characteristic of most schools, offers very few guarantees for the basic aim of any teaching process (Findak, 1999; Malacko, 2002).

This merely confirms the previous conclusion that the single-sided favorization of the educational component is essentially incorrect, especially if we know that many motor skills, knowledge and habits could be acquired even later, while the missed opportunity for the timely development of certain relevant anthropological features and characteristics cannot be compensated (Pejčić & Malacko, 2005; Pejčić et. al., 2008).

In the case of the morphological characteristics and motor skills of boys and girls, first through fourth graders, who are the subject matter of this research, we must take into consideration the fact that they are to a greater or lesser extent genetically conditioned, which means that even the effects of guided influence to a great extent depend on the coefficient of genetically determined development (Malacko, 2009).

The aim of the research consists, on the one hand, of determining the interaction between the morphological characteristics and motor skills of boys and girls attending first to fourth grade, on the basis of their interactions within the genders, and on the other hand, the way in which the obtained results of the research can in a satisfactory fashion be applied both in specific educational and/or sports practice, especially in the case of forming rational procedures for sports orientation and selection, in the planning and programming of educational content, and the developmental of relevant motor skills, as well as their control.

The method

A standard battery of measuring instruments consisting of 11 variables was applied on a sample of 148 male and female elementary school students from the Ivan Goran Kovačić elementary school from Delnice (73 boys and 75 girls), aged 7 to 11 (first through fourth grade). Today this battery is used in the educational system of Croatia, and it consists of 4 morphological variables and 7 variables of motor skills.

In the morphological space, the following latent, that is, manifest variables (anthropometric measures) were applied: *the longitudinal skeleton dimension* - body height (ABH), *the weight of the body* - body weight (ABW), *body volume* - forearm volume (ACF) and *subcutaneous fatty tissue* - upper-arm skin fold (AUS).

In the area of motor abilities, the following latent, that is, manifest variables were applied: *the speed of frequency* - hand tapping (MHT), *explosive strength* - the standing long jump (MLJ), *body coordination* - the polygon backwards (MPB), *repetitive strength* - sit-ups (MSU), *flexibility* - hanging pull-ups (MPH) and *static strength* - straddle forward bend (MFB) and *aerobic endurance* - the 3 min run (F3).

When processing the data, a canonical correlation analysis was used. First of all, the cross-correlation matrix was calculated for the interconnection between the component variables, and then by solving the characteristics of the equations, the characteristic roots of those equations were obtained (I). Using Bartlett's χ^2 -test at the $p=.000$ level, the statistical significance of the coefficients of the canonical correlation were tested (Rc), which explain the linear combinations between the groups of variables. The squares of the canonical correlation (Rc^2) were also calculated, all of which explain the common variance between the two groups.

The results

From table 1, which shows the cross-correlations of the morphological and motor variables, we can clearly see that in the case of the boys and girls there are statistically significant correlations between the morphological variables and the motor variables at the $p=.000$ and $p=.005$ level.

Table 1: The cross-correlation between the variables of morphological characteristics (A) and motor abilities (M)

Variables	boys (N=73)				girls (N = 75)				
	ABH	ABW	ACF	AUS	ABH	ABW	ACF	AUS	
MHT	.501**	.334**	.379**	.167	.066	.300**	.331**	.059	
MLJ	.445**	.089	.093	-.112	.102	-.154	-.081	-.282**	
MPB	-.187	.102	.072	.202	-.039	.212	.178	.468**	
MSU	.299**	.054	.067	-.100	-.091	-.240*	-.107	-.214	
MPH	.438**	.391**	.410**	.299**	.266*	.235*	.244*	-.041	
MFB	.063	-.258*	-.252*	-.382**	-.029	-.257*	-.202	-.370**	
F3	.399**	.050	.025	-.085	.114	.042	.083	-.222*	
λ	Rc	Rc ²	χ^2	p	Rc	Rc ²	χ^2	p	
1	.335	.742	.551	99.794	.000*	.681	.465	79.326	.000*
2	.405	.682	.465	46.921	.000*	.556	.309	36.783	.005*
3	.450	.256	.065	5.529	.853	.327	.107	11.587	.313
4	.433	.125	.015	1.042	.903	.234	.055	3.859	.425

Legend: *Morphological variables*: ABH – body height, ABW – body weight, ACF – forearm volume, AUS - upper-arm skin fold; *Motor variables*: MHT – hand tapping, MLJ – the standing long jump, MPB – the polygon backwards, MSU – sit-ups in 60 sec; MPH – hanging pull-ups, MFB – straddle forward bend, F3 - the 3 min run; Statistical parameters: λ - Wilk's Lambda, Rc - canonical correlation, Rc² – canon R – square, χ^2 – Bartlett's Chi-square test; p – level of significance; * P_{.05}, ** - P_{.01}, Nb = 73, Ng = 75

Table 2: The structure of the canonical factors (Fc) of morphological characteristics (A) and motor abilities (M)

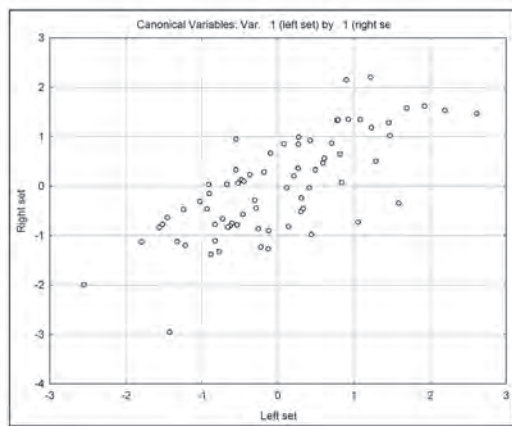

Graph 1: boys

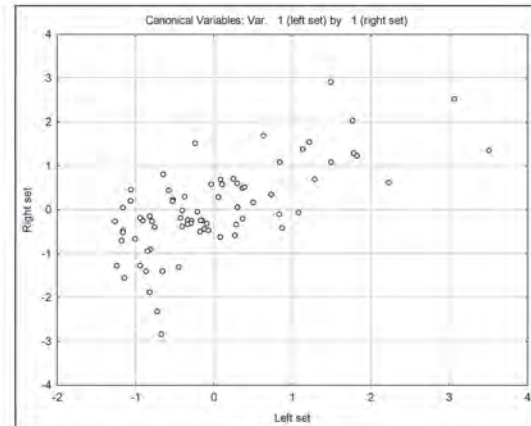

Graph 2: girls

Variables	boys		girls	
	Fc-1	Fc-2	Fc-1	Fc-2
ABH	-.240	.914*	.095	.424*
ABW	.370	.885*	.857*	.513
ACF	.379	.909*	.759*	.508
AUS	.597	.680*	.909*	-.214
	Fc-1	Fc-2	Fc-1	Fc-2
MHT	-.358	.753*	.169	.718*
MLJ	-.765*	.496	-.448*	.371
MPB	.636*	-.166	.638*	-.567
MSU	-.541*	.341	-.471*	.130
MPH	-.068	.694*	.048	.710*
MFB	-.730*	-.088	-.571*	.277
F3	-.711*	.394	-.264	.690*

Legend: Fc - 1 = the first canonical factor; Fc - 2 = the second canonical factor

In the case of the boys, the morphological variable ABH - body height has the greatest number of statistically relevant correlations with the motor variables at the $P_{.01}$ level (MHT - hand tapping, MLJ – the standing long jump, MSU - sit-ups in 60 sec, MPH – hanging pull-ups, F3 - the 3 min run), ABW - body weight and MHT - hand tapping, MPH – hanging pull-ups and MFB - straddle forward bend, ACF - forearm volume and MHT - hand tapping, MPH – hanging pull-ups and MFB - straddle forward bend at a level of $P_{.05}$, a AUS - upper-arm skinfold and MPH – hanging pull-ups and MFB - straddle forward bend at the level of $P_{.01}$.

In the case of the girls, the morphological variable ABH - body height had a statistically significant correlation at the $P_{.05}$ level with the motor variable MPH – hanging pull-ups, then ABW - body weight and MHT - hand tapping at the $P_{.01}$ level and MSU - sit-ups in 60 sec, MPH – hanging pull-ups and MFB - straddle forward bend at the $P_{.05}$ level ACF - forearm volume and MHT - hand tapping at the $P_{.01}$ level and MPH – hanging pull-ups at the $P_{.05}$ level, then AUS - upper-arm skin fold and MLJ – the standing long jump, MPB – the polygon backwards and MFB - straddle forward bend at the $P_{.01}$ level and F3 - the 3 min run at the $P_{.05}$ level.

When determining the interaction between the morphological and motor variables using Bartlett's Chi-square test (χ^2), it was determined that in the case of the boys there are statistically significant correlations at the .000 level ($p=.000$) for the first pair of canonical factors, with a value of .742 ($R_c=.742$), while for the second pair a canonical correlation of .682 was determined ($R_c=.682$), which is also statistically significant at the .000 level ($p=.000$). In the case of the girls, statistically significant correlations were determined at the .000 level ($p=.000$) for the first pair of canonical factors ($R_c=.681$), and for the second pair ($R_c=.556$) at the level of .005 ($p=.005$).

On the basis of the determined matrices of the structure of the canonical factors in the space of the morphological variables (Table 2), it is evident that in the case of the boys, the structure of the first canonical factor cannot satisfactorily be interpreted, while the second canonical factor consists of the following variables: ABH - body height, ABW - body weight, ACF - forearm volume and AUS - upper-arm skin fold, and can be interpreted as an integral canonical factor of growth and development. Since the structure of the first morphological canonical factor in the case of the girls consists of the variables ABW - body weight, ACF - forearm volume and AUS - upper-arm skin fold, it can also be interpreted as an integral canonical factor of growth and development, while the second canonical factor can only partially be interpreted as the longitudinal dimensionality of the skeleton, since it is only defined by ABH - body height.

In the space of motor skills, the first canonical factor in the case of the boys and girls can be interpreted as the integral canonical factor of motor skills, since in the case of the boys it is defined by the variables MLJ – the standing long jump, MPB – the polygon backwards, MSU - sit-ups in 60 sec, MFB - straddle forward bend and F3 - the 3 min run, and in the case of the girls MLJ – the standing long jump, MPB – the polygon backwards, MSU - sit-ups in 60 sec and MFB - straddle forward bend. The second canonical factor in the case of the boys and girls cannot satisfactorily be interpreted since in the case of the boys it is defined only by two variables MHT - hand tapping and MPH – hanging pull-ups, and in the case of the girls by MHT - hand tapping, MPH – hanging pull-ups and F3 - the 3 min run.

Discussion and conclusion

During the interpretation of the canonical correlation analysis, the standard methodological rule was adhered to, that the linear increase in the values of the resulting vector of variables of the canonical factor from the first anthropological space is proportional to the linear growth of the values of the resulting vector of variables of the canonical factor from the second anthropological space, and vice versa, under the condition that there is a statistically significant correlation between the two studied systems of variables in the different spaces.

What this precisely means in this study is that on the basis of the first pair of canonical factors, the boys achieved satisfactory values in the speed of movement frequency, explosive strength, body coordination, repetitive strength, static strength and aerobic endurance, irrespective of the values of the variables of morphological characteristics. Based on the obtained results in the second pair of canonical factors, it is evident that the boys scored a high correlational value between the motor variables and all of the applied morphological variables, which was interpreted as an integral factor of growth and development. The motor variables include MHT - hand tapping and MPH – hanging pull-ups. What this means is that boys at this age, with increased morphological values, achieve higher values for the speed of movement frequency and flexibility.

Out of the four morphological variables, in the case of the girls, three (ABW - body weight, ACF - forearm volume and AUS - upper-arm skin fold) have a high correlational value with the morphological canonical factor of growth and development, significantly related to the following motor variables MLJ – the standing long jump, MPB – the polygon backwards, MSU - sit-ups in 60 sec and MFB - straddle forward bend. This specifically means that girls at this age with increased morphological values achieve higher values for explosive strength, body coordination, repetitive and static strength. In the second pair of canonical factors it is evident that girls with increased body height achieve higher values for the variables of MHT - hand tapping, MPH – hanging pull-ups and F3 - the 3 min run, that is, for speed of movement frequency, flexibility and endurance.

From a summary of the obtained results, we can clearly discern that among the boys and girls, aged 7-11, there are significantly high and statistically significant interactions between the integral morphological canonical factors of growth and development and integral motor canonical factors of motor skills.

The canonical correlation analysis of the boys and girls determined two of each canonical factors at the $p=.000$ and $p=.005$ level. The second canonical factor in the morphological space of the boys and the first in the space of the girls is defined as an integral canonical factor of growth and development, and in the motor space the first canonical factor between the boys and girls is defined as an integral canonical factor of motor skills. In addition, the results indicated that on the basis of the first pair of canonical factors, the boys achieved satisfactory values for the variables of integral canonical factors of motor skills, irrespective of the values of the variables of morphological characteristics. In the second pair of canonical factors, the morphological integral factor of growth and development had a statistically significant relation with the speed of motion frequency and flexibility, which specifically means that boys at this age with increased morphological values achieve higher values in speed of movement frequency and flexibility and vice versa. In the case of the girls, the integral factor of growth and development is statistically related to the integral factor of motor skills (explosive strength, body coordination, repetitive and static strength). In the second pair of canonical factors, the girls with increased body height achieve higher values in speed of movement frequency, flexibility and aerobic endurance.

The general conclusion is that boys and girls, aged 7-11 (first to fourth grade students), are more successful in terms of motor skills and have higher values of morphological characteristics and vice versa, which generally at this age confirms the existence of the desired anthropological integrity.

References

1. Findak, V. (1999). Planning, programming, implementation and control of the process of exercise. *Proceedings Book 2nd International scientific conference "Kinesiology for the 21st century"*, 109-112. Zagreb: Faculty of Kinesiology, University of Zagreb.
2. Malacko, J. (2002). Relations of coordination, morphological characteristics and motor abilities. *Proceedings Book 3rd International scientific conference "Kinesiology-new perspectives"*, 291-295. Zagreb: Faculty of Kinesiology, University of Zagreb.
3. Malacko, J. (2009). Interaction between genetic and non-genetic potentials in function of creation and development of sportsmen individuality. *Sport Science*, 2(2), 36-40.
4. Pejčić, A., Malacko, J. (2005). The ontogenetic development of morphological characteristics and motor abilities of boys and girls in early elementary school. *Kinesiologia slovenica*, 11(2), 42-55.
5. Pejčić, A., Malacko, J., Tomljenović, B. (2008). Relations between morphological and motor-functional variables and their effects on aerobic capacity of boys and girls in the first class of elementary school. *Proceedings Book 5th International Scientific Conference on Kinesiology "Kinesiology research trends and applications"*, 532-535. Zagreb: Faculty of Kinesiology, University of Zagreb.

GENDER DIFFERENCES IN OBJECT CONTROL SKILLS OF THE YOUNGER SCHOOL AGE CHILDREN

Ivana Nikolić¹, Snježana Mraković¹ and Dražen Rastovski²

¹Faculty of Teacher Education, University of Zagreb, Croatia

²Faculty of Teacher Education, University of Josip Juraj Strossmayer in Osijek, Croatia

Abstract

The aim of this study was to determine significant differences between boys and girls in the first and third grade of primary school in object control skills and to determine the differences between children who are involved in organized sports activities and those who are not involved. The survey covered a total of 132 children (67 boys and 65 girls), 7-10 years old. All children were tested on selected items from the Object Control subtest of the Test of Gross Motor Development 2 for age 3-10 years. There were 68 children aged 7-8 (34 boys and 34 girls) and 64 children aged 9-10 (33 boys and 31 girls). Significant differences between boys and girls were obtained in all variables in the first grade, while in the third grade were not, except in the variable stationary bounce in favor of boys. The differences are significant in all variables in children who are involved in organized sports compared to those who are not.

Key words: motor skills, manipulative skills, primary school

Introduction

Biotic motor knowledge is an important factor in a human being's formation during the phylogeny and ontogeny, and they enable effective mastering of space, obstacles, resistance, and perform manipulation of various sizes and shapes (Findak et al., 1998). The aforementioned also have much greater significance during childhood and adolescence whereby parents and all educational institutions play a crucial role. Motor programs such as catching, passing and throwing, dribbling and juggling are used in the manipulation of objects (Sekulić & Metikoš, 2007). Object control is a skill requirement in game and sport forms commonly available to children both at school and in the community (e.g. basketball, handball, football). It has been shown that children must master object control before they can use specific manipulative skills successfully in game strategies (Turner & Martinek, 1992). Same authors report that mastery of basic manipulative skills enables children to attempt more specialized and complex movements that are part of the more dynamic game and play, and mastery of advanced skills is typically required if adolescents are to be retained in youth sports.

Research indicates that childhood object control motor skill proficiency contributes to greater adolescent physical activity participation (Barnett et al., 2009) and higher fitness (Barnett et al., 2008b). Other authors have also found that object control skill proficiency was correlated with physical activity (Raudsepp & Päll, 2006) and fitness (Okely et al., 2001). These studies provide evidence that proficiency in fundamental motor skills performance during the early primary grades is likely to contribute to increases in habitual and organized physical activity participation, thus preventing unhealthy weight gain among children and adolescents (Gabbard, 2007).

Barnett et al. (2008a) showed that being able to perform object control skills (such as catching, throwing and kicking) competently in childhood may be significant and influential in building a positive perception of sports competence, in turn increasing adolescent physical activity engagement and fitness levels.

Object control skills competence has been shown to be influenced by gender. Research indicates that boys have more developed object control skills than girls in preschool and early school age (Robinson, 2010; van Beurden et al., 2002).

The aim of this research was to determine significant differences between boys and girls in the first and third grade of primary school in object control skills and to determine significant differences between children who are involved in organized sports activities and those who are not involved. In accordance with the set goals it was hypothesized that boys would show greater quality of object control skills than girls in both age groups (at the ages of 7-8 and 9-10 years). Also, according to research, we hypothesized that children who are involved in organized sports will show better values compared to those who are not.

Methods

Children who participated in this study were sampled from one elementary school in Čakovec, Croatia. Participants were 132 children (67 boys and 65 girls), 7-10 years old. All children were tested on selected items from the Object Control subtest of the Test of Gross Motor Development 2 (TGMD-2) (Ulrich, 2000) for age 3-10 years. There were 68

children aged 7-8 (34 boys and 34 girls; mean height 126,30±4,93; mean weight 27,47±5,42; mean BMI 17,14±2,72) and 64 children aged 9-10 (33 boys and 31 girls; mean height 136,57±6,27; mean weight 32,95±8,16; mean BMI 17,53±3,42).

Children's participation in sports was measured in two categories (nonparticipation or participation in organized sports during a minimum of two times per weeks in the last 6 months) according to information provided by their parents. All children were tested individually by the same experienced tester.

TGMD-2 is a process-oriented measure, assessing the components in each skill rather than the outcome or product of skill execution. The original version of the test includes locomotion and control skills while in this study were included control skills. Of the total of five object control skills excluded was the two handed strike, because it is not in the curriculum of physical education in Croatia. The stationary bounce has three components and the catch, overhand throw and kick have four components. The child performs each skill three times and each criterion is given a score of 0 or 1. An item score 0 is given if the criterion is observed on fewer than two of three trials. The performance of children was digitally video-recorded and afterwards evaluated by one observer.

According to previous research (Catenassi et al., 2007; Simons et al., 2008) this test is valid and reliable among school children and therefore was used in this study. These skills were chosen because they are an integral part of the official plan and program of physical education from the first grade and they are recognized as integral to the development of more sports-specific skills (e.g. development of overhand throw for the overhead smash in tennis or overhead serve in volleyball) (van Beurden et al., 2003).

Differences between genders were calculated using the analysis of the variance for four dependent variables and their total score and the resulting level of significance was checked with the Bonferroni post hoc test. Differences between children who are involved in sports and those who are not involved were calculated with the nonparametric Mann-Whitney U test.

Results

The significant gender differences were conducted separately for boys and girls at ages 7-8 and 9-10 years (table 1). In the first grade, looking at the overall result, the lowest average value was obtained from the stationary bounce ($M=2,80$), and the highest in the catch ($M=5,75$). Higher average values were obtained from boys in all variables and overall scores when compared to girls. Also, the standard deviation values in girls show greater dispersion of the results in variables stationary bounce ($SD=2,02$) and overhand throw ($SD=1,83$). Levene's test was used to check the homogeneity of variances. With the analysis of the variance and the Bonferroni post hoc test ($p=0,01$) statistically significant difference between genders in the first grade (7-8 years) was obtained in all variables in which boys achieve better performance: stationary bounce ($F=20,35$; $p=0,00$), catch ($F=14,15$; $p=0,00$), overhand throw ($F=53,48$; $p=0,00$), kick ($F=66,28$; $p=0,00$) and total score ($F=76,42$; $p=0,00$).

In the third grade, boys and girls have the lowest average value in the stationary bounce variable ($M=5,34$), and the highest in the catch ($M=6,51$). In all variables according to average values boys show better performance. Given the values of the Levene's test that indicate a significant deviation of the homogeneity of the variance in the variables of the stationary bounce, overhand throw and total score, the obtained level of significance was tested with the nonparametric Mann-Whitney U test. With the analysis of the variance a statistically significant difference was obtained only in the variable of the stationary bounce ($F=5,99$; $p=0,01$) with the p values of the Mann Whitney U test ($p=0,00$). No significant differences were found between genders in other variables.

Table 1: Means (M) and standard deviations (SD) subscale scores at the TGMD-2 for boys and girls separately and total at ages 7-8 and 9-10 years

		7-8 years			Anova		9-10 years			Anova		
		Total (N=68)	Boys (N=34)	Girls (N=34)	F	p	Total (N=64)	Boys (N=33)	Girls (N=31)	F	p	
Stationary bounce	M	2,80	3,88	1,74	20,35	,00	M	5,34	5,70	4,97	5,99	0,01
	SD	(2,22)	(1,90)	(2,02)			SD	(1,23)	(1,02)	(1,35)		
Catch	M	5,75	6,41	4,74	14,15	,00	M	6,51	6,67	6,35	0,90	0,35
	SD	(2,00)	(1,67)	(1,99)			SD	(1,31)	(1,02)	(1,56)		
Overhand throw	M	3,19	4,88	1,50	53,48	,00	M	5,86	6,27	5,42	3,08	0,08
	SD	(2,54)	(1,98)	(1,83)			SD	(1,97)	(1,38)	(2,41)		
Kick	M	3,79	5,41	2,18	66,28	,00	M	5,91	6,09	5,71	0,87	0,35
	SD	(2,30)	(1,71)	(1,57)			SD	(1,63)	(0,91)	(2,15)		
Total score	M	15,36	20,59	10,15	76,42	,00	M	23,62	24,73	22,45	4,28	0,04
	SD	(7,17)	(4,34)	(5,44)			SD	(4,51)	(2,92)	(5,55)		

Out of a total of 132 children, 40 of them (31,8%) are not engaged in organized out-of curriculum and out-of school physical activities in leisure time, while 90 (68,2%) have been engaged in them at least twice a week in the last six months (table 2). The Mann Whitney U test showed statistically significant differences in favor of the children who are engaged in sports both with regards to object control skills and total score ($p=0,01$ stationary bounce; $p=0,05$ catch, $p=0,00$ overhand throw, kick and total score).

Table 2: Mann - Whitney U test: values of all dependent variables in relation to the participation in sport

Variables	Participation in sport	N	Mean Rank	Sum of Ranks	Mann-Whitney U test	p
Stationary bounce	Yes	90	71,92	6472,50	1402,500	0,01
	No	42	54,89	2305,50		
Catch	Yes	90	70,79	6371,50	1503,500	0,05
	No	42	57,30	2406,50		
Overhand throw	Yes	90	72,59	6533,00	1342,000	0,00
	No	42	53,45	2245,00		
Kick	Yes	90	73,69	6632,50	1242,500	0,00
	No	42	51,08	2145,50		
Total score	Yes	90	73,91	6652,00	1223,000	0,00
	No	42	50,62	2126,00		

Discussion and conclusions

It was expected that the boys in the first and third grade would achieve a higher level in the object control skills than girls. The results, however, showed that there were significant differences between genders obtained in all object control skills only in first grade. Taking into account that the test was conducted at the beginning of the school year where the first graders actually come from different preschools, and it is unknown whether they had organized physical activities, the results represent their knowledge of preschool age. Thus, the obtained results where boys scored higher in ball skills compared to girls is in line with previous findings (Giagazoglou et al., 2011; Hardy et al., 2010) supporting the notion that the nature of the difference emerged might be attributed to the different kind of games that the two genders play. Ball skills tend to be less frequent and typical for preschool girls than for boys, and girls may therefore show poorer performance or that girls are not exposed reinforcing or provided with opportunities to develop object control skills (Hardy et al., 2012). Garcia (1994), however, states that gender differences in motor skills at preschool age are more likely to be associated with the children's socialization which is influenced by family, peers and teachers. Low competency in object control skills of first grade girls indicates that physical exercise in preschool institutions needs to more intensively target girls.

In the third grade, gender differences are not significant, except in the stationary bounce. The obtained results are not consistent with studies of primary school children (Okely & Booth, 2004; Cooley et al., 1997) where boys achieved better results than girls in the object control skills. It is assumed, however, that the differences in relation to other research are also partly caused by a different curriculum of physical education. One of the reasons for the obtained results of this study could be explained with the curriculum of physical education since the content such as throwing, catching, hitting the ball with feet and dribbling the ball in different ways are intensively conducted from the first grade for both genders, whereby the girls have mastered the basic technique performing the skill. As another possible reason for the specificity of the school where the study was conducted, namely the school offers a number of different sports within out-of curriculum (school sports clubs) and out-of school sports activities such as handball, athletics, basketball and football in which girls participate as well.

Differences in motor skills in relation to sport activities and participation are consistent with the results of previous research (Krombholz, 2006; Giagazoglou et al., 2011) in which children who participate in organized physical activities display a higher level of skills when compared to non-participants. Thus, according to Griffiths & Billard (2013) mastery in object control skills may benefit and be influenced by sports specialization at a young age. Positive support for children to participate in physical activities could facilitate normal development and help young children to improve their motor performance (Giagazoglou et al., 2005).

In conclusion, the results suggest that more attention to monitoring the level of development of fundamental motor skills should be paid at the preschool age and given information on gender differences which could help preschoolers and parents to identify which skill should be targeted so that boys and girls are given the opportunity to practice and learn skill basics before starting primary school. Continuous monitoring and information should be conducted by educators in kindergartens and primarily through lessons of physical education, followed by free play. At primary school, knowing the

level of development of motor skills and gender differences gives the teacher feedback on the effect of his work and thus he will be able to properly plan and program lessons for the pupils because learning other more specific skills depends on the proficiency of fundamental motor skills.

References

1. Barnett, L.M., Morgan, P.J., van Beurden, E., & Beard, J. (2008a). Perceived sports competence mediates the relationship between childhood motor skill proficiency and adolescent physical activity and fitness: a longitudinal assessment. *International Journal of Behavioral Nutrition and Physical Activity*, 5:40.
2. Barnett, L.M., van Beurden, E., Morgan, P.J., Brooks, L.O., & Beard, J.R. (2009). Childhood motor skill proficiency as a predictor of adolescent physical activity. *Journal of Adolescent Health*, 44(3), 252-259.
3. Barnett, L.M., van Beurden, E., Morgan, P.J., Brooks, L.O., & Beard, J.R. (2008b). Does childhood motor skill proficiency predict adolescent fitness? *Medicine and Science in Sports and Exercise*, 40(12), 2137-2144.
4. Catenassi, F.Z., Marques, I., Bastos, C.B., Basso, L., Ronque, E.R.V. & Gerage, A.M. (2007). Relationship between body mass index and gross motor skill in four to six year-old children. *Revista Brasileira de Medicina do Esporte*, 13(4), 227-230.
5. Cooley, D., Oakman, R., McNaughton, L., & Ryska, T. (1997). Fundamental movement patterns in Tasmanian primary school children. *Perceptual and Motor Skills*, 84(1), 307-316.
6. Findak, V., Metikoš, D., Mraković, M., Neljak, B., & Prot, F. (1998). *Primijenjena kineziologija u školstvu - motorička znanja*. Zagreb: Fakultet za fizičku kulturu Sveučilišta u Zagrebu.
7. Gabbard, C. (2007). *Lifelong motor development* (5th ed.). San Francisco, CA: Benjamin Cummings.
8. Garcia, C. (1994). Gender differences in young childrens interactions when learning fundamental motor skills. *Research Quarterly for Exercise and Sport*, 65(3), 213-225.
9. Giagazoglou, P., Tsimaras, V., Fotiadou, E., Evaggelinou, C., Tsikoulas, J., & Angelopoulou, N. (2005). Standardization of the motor scales of the Griffiths Test II on children aged 3 to 6 years in Greece. *Child: Care, Health and Development*, 31(3), 321-330.
10. Giagazoglou, P., Kabitsis, N., Kokaridas, D., Zaragas, C., Katartzis, E., & Kabitsis, C. (2011). The movement assessment battery in Greek preschoolers: The impact of age, gender, birth order and physical activity on motor outcome. *Research in Developmental Disabilities*, 32(6), 2577-2582.
11. Griffiths, G., & Billard, R. (2013). The fundamental movement skills of a year 9 group and gifted and talented cohort. *Advances in Physical Education*, 3(4), 215-220.
12. Hardy, L.L., King, L., Farrell, L., Macnivan, R., & Howlett, S. (2010). Fundamental movement skills among Australian preschool children. *Journal of Science and Medicine in Sport*, 13(5), 503-508.
13. Hardy, L.L., Renten-Reynolds, T., Espinel, P., Zask, A., & Okely, A.D. (2012). Prevalence and correlates of low fundamental movement skill competency in children. *Pediatrics*, 130(2), 390-398.
14. Krombholz, H. (2006). Physical performance in relation to age, sex, birth order, social class, and sports activities of preschool children. *Perceptual and Motor Skills*, 102(2), 477-484.
15. Okely, A.D., & Booth, M.L. (2004). Mastery of fundamental movement skills among children in New South Wales: prevalence and socio demographic distribution. *Journal of Science and Medicine in Sport*, 7(3), 358-372.
16. Okely, A.D., Booth, M.L., & Patterson, J.W. (2001). Relationship of cardiorespiratory endurance to fundamental movement skill proficiency among adolescents. *Pediatric Exercise Science*, 13(4), 380-391.
17. Raudsepp, L., & Päll, P. (2006). The relationship between fundamental motor skills and outside-school physical activity of elementary school children. *Pediatric Exercise Science*, 18(4), 426-435.
18. Robinson, L.E. (2010). The relationship between perceived physical competence and fundamental motor skills in preschool children. *Child: Care, Health and Development*, 37, 589-596.
19. Sekulić, D., & Metikoš, D. (2007). *Osnove transformacijskih postupaka u kineziologiji - Uvod u Osnovne Kineziološke Transformacije*. Split: Sveučilište u Splitu.
20. Simons, J., Daly, D., Theodorou, F., Caron, C., Simons, J. & Andoniadou, E. (2008). Validity and reliability of the TGMD-2 in 7-10-year-old Flemish children with intellectual disability. *Adapted Physical Activity Quarterly*, 25(1), 71-82.
21. Turner, A., & Martinek, T. (1992). A comparative analysis of two model for teaching games; Technique approach and game-centered (tactical focus) approach. *International Journal of Physical Education*, 19, 131-152.
22. Ulrich, D.A. (2000). *Test of Gross Motor Development (TGMD-2)* (2nd ed.). Austin, TX: PRO ED, Inc. Preuzeto 15. siječnja s http://www2.pef.uni-lj.si/srp_gradiva/tgm.pdf
23. van Beurden, E., Barnett, L.M., Zask, A., Dietrich, U.C., Brooks, L.O., & Beard, J.R. (2003). Can we skill and activate children through primary school physical education lessons? „Move it Groove It“ - a collaborative health promotion intervention. *Preventive Medicine*, 36(4), 493-501.
24. van Beurden, E., Zask, A., Barnett, L.M., & Dietrich, U.C. (2002). Fundamental movement skills - How do primary school children perform? The “Move it Groove it” program in rural Australia. *Journal of Science and Medicine in Sport*, 5(3), 244-252.

GENDER DIFFERENCES IN THE MORPHOLOGICAL CHARACTERISTICS AND MOTOR SKILLS OF FIRST- FOURTH GRADE ELEMENTARY SCHOOL CHILDREN

Aleksandra Pejčić¹, Julijan Malacko² and Helena Muvrin³

¹University of Rijeka, Teacher Training College, Rijeka, Croatia

²University of Novi Sad, The Faculty of Sport and Physical Education, Novi Sad, Serbia

³Ivan Goran Kovačić Elementary School, Delnice, Croatia

Introduction

Children during their early childhood and youth should satisfy their need for movement, and their schools should enable them to do so, so that they could maintain and develop their entire anthropological status (morphological, motor, functional, intellectual, psychological, social, etc.). The interaction between individual anthropological segments, which are considered integral parts of the human personality, does not allow the establishment of any kind of hierarchy between them. Thus, within the group of problems of the overall anthropological status of children, the problems regarding gender differences are important both for scientific research and everyday life (Malacko, et al., 2011).

What this actually means is that as during physical education classes, the anthropological laws of development, which unambiguously indicate that human abilities and characteristics can most successfully be developed over a period of time when it is objectively possible, must not be disturbed (Pejčić & Malacko, 2005; Gudelj, et. al., 2009). In that sense, it is well-known that based on natural laws we realize the most significant tempo of development of certain abilities or characteristics of an individual, increase adaptive possibilities in relation to the environmental factors and enable the specially favorable assumptions for the formation of certain abilities and habits, and thus the acquisition of information of a certain type (Trajkovski-Višić, et. al., 2011). We start from the assumption that the human body during this period, more than during others, is more susceptible to external influences (transformations), if their focus is on the basic tendencies of the genetic course of morphological and motor changes (Malacko, 2009).

The aim of this research is to determine the statistically significant gender differences between the means of the applied system of morphological and motor variables among children aged 7-11, so that we could achieve the optimal decrease in the differences, with the aim of modelling, diagnosing, planning, programming and realizing control over the teaching process.

The method

A standard battery of measuring instruments consisting of 11 variables was used on a sample of 148 male and female elementary school students from the Ivan Goran Kovačić elementary school from Delnice (73 boys and 75 girls), aged 7-11 (first - fourth graders). Today that battery is used in the education system in Croatia, and consists of 4 morphological variables and 7 motor skills variables.

In the morphological space the following latent, that is, manifesting variables (anthropometric measures) were applied: the *longitudinal dimension of the skeleton* - body height (ABH), *the weight of the body* - body weight (ABW), *body volume* - forearm volume (ACF) and *subcutaneous fatty tissue* - upper-arm skin fold (AUS).

In the area of motor abilities the following latent, that is manifest, variables were applied: *the speed of frequency* - hand tapping (MHT), *explosive strength* - the standing long jump (MLJ), *body coordination* - the polygon backwards (MPB), *repetitive strength* - sit-ups in 60 sec (MSU), *flexibility* - hanging pull-ups (MPH) and *static strength* - straddle forward bend (MFB) and *aerobic endurance* - the 3 min run (F3).

In order to determine the difference in the means of the applied variables between the boys and girls, we used a statistical method of the multivariate and univariate analysis of variance (MANOVA/ANOVA). The multivariate testing of the null-hypothesis which states that the group centroids were equal to the common centroid (GENERAL MANOVA) was carried out using 1 - Wilk's Lambda test, the F - test and p - the level of statistical significance ($p > .05$). The univariate statistically significant difference between the arithmetic means of the values obtained for the boys and girls was calculated using the F - test and p - level of statistical significance ($p > .05$).

The results

Based on the data shown in table 1 and 2 and chart 1 and 2, where we find the results the boys and girls scored for the morphological and motor variables, it is evident that between the boys and girls in terms of the composition of morphological and motor variables, there are multivariate statistically significant differences in the means, for the first

graders at the level of $p = .001$, for the second graders at the level of $p = .015$, for the third graders at the level of $p = .017$ and for the fourth graders at the level of $p = .004$.

Out of the 4 morphological and 7 motor variables (Table 1) the first grade boys scored better values for two of the morphological (ACF - forearm volume, AUS - upper-arm skin fold) and four of the motor variables (MPB – the polygon backwards, MSU - sit-ups in 60 sec, MFB - straddle forward bend, F3 - the 3 min run), the second grade boys scored higher values for one of the morphological variables (AUS - upper-arm skin fold) and six of the motor variables (MHT - hand tapping, MLJ – the standing long jump, MPB – the polygon backwards, MSU - sit-ups in 60 sec, MFB - straddle forward bend, F3 - the 3 min run). The first grade girls scored higher values for two of the morphological (ABH - body height, ABW - body weight) and three of the motor variables (MHT - hand tapping, MLJ – the standing long jump, MPH – hanging pull-ups), the second grade girls scored higher values in three of the morphological (ABH - body height, ABW - body weight, ACF - forearm volume) and one motor variable (MPH –hanging pull-ups).

Table 1: The multivariate and univariate (MANOVA/ANOVA) significance of the differences (p) between the arithmetic means of the male (Mb) and female (Mg) first and second graders in anthropometric and motor variables

Variables	Mb	Mg	F	p
First graders (N = 17)		(N = 19)		
ABH – body height	1265.94	1295.00*	2.458	.126
ABW – body weight	265.00	269.17*	.084	.773
ACF – forearm volume	185.31*	183.17	.145	.706
AUS – upper-arm skin folds	8.81*	11.33	4.344	.045*
MHT – hand tapping	18.44	18.50*	.102	.752
MLJ – the standing long jump	114.19	116.83*	.798	.378
MPB – the polygon backwards	227.31*	254.50	1.789	.190
MSU – sit-ups in 60 sec	27.13*	26.89	.006	.940
MPH – hanging pull-ups	39.62	45.94*	10.046	.003*
MFB – straddle forward bend	20.31*	9.78	7.809	.008*
F3 – the 3 min run	401.88*	383.89	.090	.766
$\lambda = .335$ F = 4.339 p = .001*				
Second graders (N = 15)		(N = 19)		
ABH – body height	1293.93	1315.83*	.299	.588
ABW – body weight	279.29	310.56*	.448	.508
ACF – forearm volume	193.93*	196.11*	.004	.951
AUS – upper-arm skin folds	9.21*	12.67	4.732	.037*
MHT – hand tapping	20.14*	19.72	.671	.419
MLJ – the standing long jump	137.64*	116.06	4.273	.047*
MPB – the polygon backwards	196.79*	237.89	4.262	.047*
MSU – sit-ups in 60 sec	25.79*	25.44	.015	.903
MPH – hanging pull-ups	39.86	43.56*	2.720	.109
MFB - straddle forward bend	21.21*	19.44	.012	.914
F3 - the 3 min run	566.43*	518.89	6.322	.017*
$\lambda = .405$ F 2.942 p = .015*				

Legend: Mb - mean value of the boys, Mg - mean value of the girls; ANOVA: F - test, p - level of significance > .05; MANOVA: λ - Wilk's Lambda, R - Rao's R, p - significance level > .05

The third grade (Table 2) boys scored higher values for four of the morphological (ABH - body height, ABW - body weight, ACF - forearm volume, AUS - upper-arm skin fold) and six of the motor variables (MHT - hand tapping, MLJ – the standing long jump MPB – the polygon backwards, MSU - sit-ups in 60 sec, MFB - straddle forward bend, F3 - the 3 min run) and the fourth graders scored higher values for one morphological (ACF - forearm volume) and five motor variables (MLJ – the standing long jump, MPB – the polygon backwards, MSU - sit-ups in 60 sec, MFB - straddle forward bend, F3 - the 3 min run). The third-grade girls did not score significant values for any of the morphological variables (MPH – hanging pull-ups) and the fourth-grade girls scored higher values for three of the morphological (ABH - body height, ABW - body weight, AUS - upper-arm skin fold) and two of the motor variables (MHT - hand tapping, MPH – hanging pull-ups).

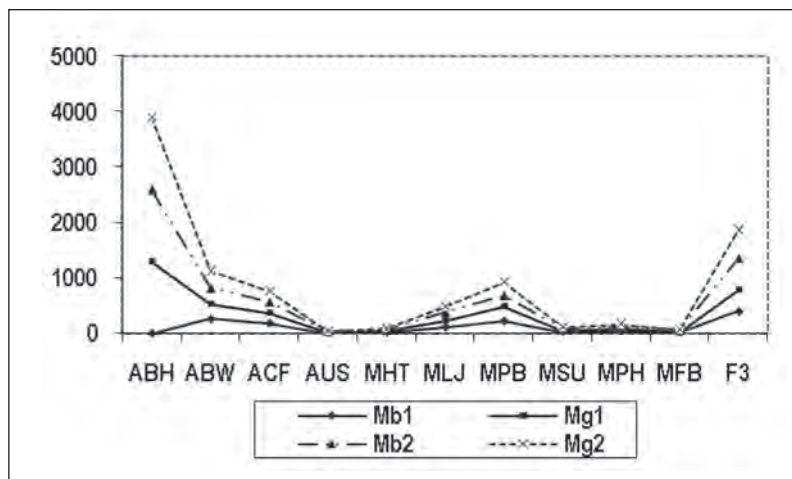

Graph 1: Boys and girls - first and second graders

Table 2: The multivariate and univariate (MANOVA/ANOVA) significance of the differences (*p*) between the arithmetic means of the male (*Mb*) and female (*Mg*) third and fourth graders in anthropometric and motor variables

Variables	Mb	Mg	F	p	
Third graders	(N=20)	(N = 17)			
ABH – body height	1416.05*	1293.13	3.142	.085	
ABW – body weight	380.26*	359.69	.885	.353	
ACF – forearm volume	207.11*	203.44	.458	.503	
AUS – upper-arm skin fold	12.42*	14.50	.850	.363	
MHT – hand tapping	23.89*	22.19	3.461	.071	
MLJ – the standing long jump	143.21*	138.88	.244	.625	
MPB – the polygon backwards	189.63*	246.50	6.464	.016*	
MSU – sit-ups in 60 sec	34.89*	29.63	7.030	.012*	
MPH – hanging pull-ups	43.26	46.81*	1.481	.232	
MFB – straddle forward bend	28.58*	20.94	.321	.574	
F3 – the 3 min run	574.74*	498.75	5.141	.030*	
			$\lambda = .450$	$F = 2.773$	$p = .017*$
Fourth graders	(N=21)	(N = 20)			
ABH – body height	1428.45	1447.37*	.619	.436	
ABW – body weight	399.25	399.47*	.002	.966	
ACF – forearm volume	213.50*	211.05	.145	.705	
AUS – upper-arm skin fold	14.30	11.79*	2.100	.155	
MHT – hand tapping	23.30	23.42*	.018	.895	
MLJ – the standing long jump	148.45*	138.26	2.081	.157	
MPB – the polygon backwards	152.60*	180.53	2.799	.102	
MSU - sit-ups in 60 sec	30.35*	28.95	.321	.574	
MPH – hanging pull-ups	52.90	58.21*	3.360	.074	
MFB - straddle forward bend	17.05*	13.53	.826	.369	
F3 - the 3 min run	603.50*	555.26	1.727	.197	

 $\lambda = .433$ $F = 3.452$ $p = .004*$

Legend: Mb - mean value for the boys, Mg - mean value for the girls; ANOVA: F - test, p - level of significance > .05; MANOVA: λ - Wilk's Lambda, R - Rao's R, p - level of significance > .05

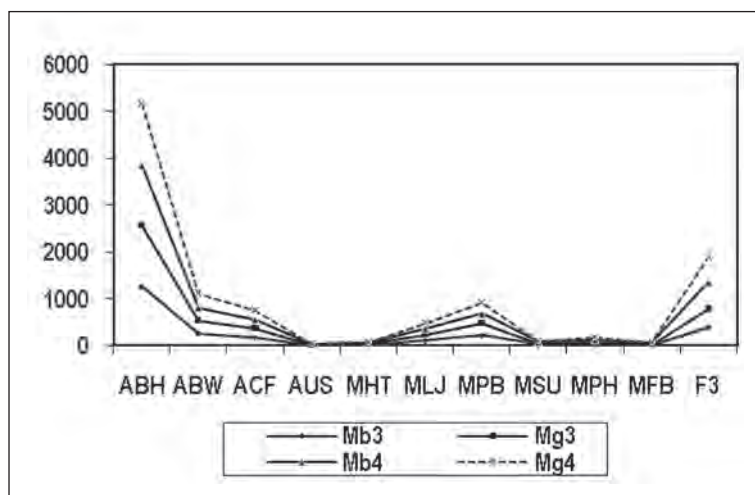

Graph 1: Boys and girls - third and fourth graders

Discussion and conclusion

By analyzing the results in the morphological and motor space, shown in table 1 and chart 1, we can clearly see that the first-grade boys had increased values for body volume (ACF - forearm volume) and subcutaneous fatty tissue (AUS - upper-arm skin fold), with the addition that the differences were statistically significant at the $p=.045$ level for only the AUS - upper-arm skin fold variable in favor of the boys, since they showed lower values. The girls had increased values for the longitudinal dimensionality of the skeleton (ABH - body height) and body mass (ABW - body weight). In the motor space, the girls had greater values for speed of movement frequency (MHT - hand tapping), explosive strength (MLJ - the standing long jump) and flexibility (MPH - hanging pull-ups) at the $p=.003$ level of significance, and the boys for body coordination (MPB - the polygon backwards), repetitive strength (MSU - sit-ups in 60 sec), static strength (MFB - straddle forward bend) at the $p=.008$ level of significance and for aerobic endurance (F3 - the 3 min run). Based on the presented data we can see that gender differences begin at the multivariate level of statistical significance of $p = .001$ in favor of the boys as early as in the first grade.

In the second grade the gender difference is also statistically significant in a multivariate sense at the $p = .015$ level in favor of the boys in the morphological variable of subcutaneous fatty tissue (AUS - upper-arm skin fold) at the $p = .037$ level of statistical significance, as well as the motor variables of speed of movement frequency (MHT - hand tapping), explosive strength (MLJ - the standing long jump) at the $p=.047$ level, body coordination (MPB - the polygon backwards), also at the $p=.047$ level, repetitive strength (MSU - sit-ups in 60 sec), static strength (MFB - straddle forward bend) and aerobic endurance (F3 - the 3 min run) at the $p=.017$ level.

From table 2 and chart 2 we can see that in the third grade, gender differences are statistically significant in a multivariate sense at the $p = .017$ level, in favor of the boys, for 4 of the morphological and 6 of the motor variables, but in only one variable (MPH - hanging pull-ups) in favor of the girls. Based on the obtained results we can clearly see that the greatest gender differences in favor of the boys occurred in the third grade, in the case of the variables of body coordination (MPB - the polygon backwards) at the $p=.016$ level, repetitive strength (MSU - sit-ups in 60 sec) at the $p=.012$ level and aerobic endurance (F3 - the 3 min run) at the $p=.030$ level.

Gender differences are statistically significant in the fourth grade at the $p = .04$ level, in favor of the boys, for the morphological variable of body volume (ACF - forearm volume) and the motor variables of explosive strength (MLJ - the standing long jump), body coordination (MPB - the polygon backwards), repetitive strength (MSU - sit-ups in 60 sec), static strength (MFB - straddle forward bend) and aerobic endurance (F3 - the 3 min run). In the morphological space, the girls scored higher values of longitudinal dimensionality of the skeleton (ABH - body height), body mass (ABW - body weight) and subcutaneous fatty tissue (AUS - upper-arm skin fold), as well as the motor variables of speed of movement frequency (MHT - hand tapping) and flexibility (MPH - hanging pull-ups). Based on the presented results, we can see that in all four grades the boys had greater values for 29 variables (8 morphological and 21 motor), and the girls in 15 variables (8 morphological and 7 motor).

The conclusion is that in the morphological space of children from the first to the fourth grade, the developmental processes based on gender differences and genetic determination are closely related (8:8), while gender differences in motor space are significantly more pronounced in favor of the boys (21:7), probably due to the increased additional activities which the boys participated in during their leisure time. Gender differences in motor space are more pronounced in favor of the boys, most probably as a result of the influence of a greater involvement in sports activities which led to the boys becoming more coordinated, stronger, having greater explosive strength, and increased endurance, while the girls are

more flexible and quicker in the performance of movement frequency and flexibility, usually as a result of the existence of conducive genetic potential. The recommendation is that during physical education classes from the first through the fourth grade, special attention needs to be paid to working with girls, with special emphasis on the development of strength (explosive, repetitive and static) and aerobic endurance.

References

1. Gudelj, I., Milat, S., Retelj, E., Zagorac, N., Ljubičić, M. and Katić, R. (2009). Sex differences in morphological dimensions in twelve-year-old children from Imotska Krajina. *Collegium Antropologicum* 33(1), 131–138.
2. Malacko, J. (2009). Interaction between genetic and non-genetic potentials in function of creation and development of sportsmen individuality. *Sport Science*, 2(2), 36-40.
3. Malacko, J., Pejčić, A., Trajkovski, B. (2011). Sexual differentiation of morphological characteristics and motor abilities of 11-year-old children. *Proceedings Book*, 6th International Scientific Conference on Kinesiology, 251-255. Zagreb: University of Zagreb, Faculty of Kinesiology.
4. Pejčić, A., Malacko, J. (2005). The ontogenetic development of morphological characteristics and motor abilities of boys and girls in early elementary school. *Kinesiologia slovenica*, 11(2), 42-55.
5. Trajkovski-Višić, B., Malacko, J. and Tomljenović, B. (2011). The differences between pre-primary school girls and boys regarding their morphological and motor abilities *Acta Kinesiologica*, 5(1), 53-56.

DOCTORAL DISSERTATIONS ON PHYSICAL EDUCATION: CROATIAN CASE

Vilko Petrić¹, Ana Čuić Tanković² and Dario Novak¹

¹Faculty of Kinesiology, University of Zagreb, Croatia

²Faculty of Tourism and Hospitality Management, Opatija, University of Rijeka, Croatia

Abstract

The purpose of this study was to determine how many doctoral dissertations in Croatia has dealt with the physical education field according to all the three categories (teaching, teacher education, curriculum) and to analyse the area of interest with respect to targeting the topic of doctoral dissertations and the publication of scientific papers. In this study was used a content analysis. The basic data sources were the *ON – LINE catalogue of the Library of the Zagreb Faculty of Kinesiology, Centre for online databases and the Croatian scientific*. From then until today, six scientists have received their doctorates in the category of teaching, one in the category of curriculum and none in the category of teacher education. We noticed that only one out of seven authors has published the thesis from his doctoral dissertation. We can conclude that in the Republic of Croatia the frequency of doctoral dissertations on physical education is very modest in almost all categories, but most notably on teacher education and curriculum. It points to insufficient market studies in order to target the topic properly and finally to position the scientific achievements at the international level, that's why the implication of economy, especially marketing was needed.

Key words: *teaching, teacher education, curriculum, scientific publication, marketing, targeting*

Introduction

The doctoral dissertations in the area of social sciences, the kinesiology field and the physical education branch represent the basis of the exploratory part of this study, because the authors, who have just received their doctoral degrees, possess a complete and comprehensive knowledge of a particular subject and offer an objective review of the current situation. By proposing the guidelines for new researches, they present a certain vision of theirs of the future that should be respected (Caffarelle, 1999). Many scientists have studied this field by analysing the literature and doctoral dissertations (Kulinna et al. 2009; Silverman & Manson, 2003; Pallas 2001; Cleary, 2000; White, 1997; et al.). In the last decades, physical education has been developing very dynamically in all the three research categories: teaching, teacher education, and curriculum. From the 60's of the last century until today, there have been many successful attempts to summarize scientific papers and doctoral dissertations in review articles that have always provided comprehensive insights into the field of physical education and offered many new significant data (Kulinna, 2009). Every new study of this topic contributes to the further development of the research interest.

Doctoral education is central to both the production of knowledge and the reproduction of disciplines, because it produces the next generation of researchers. The number of doctoral dissertations and PhD research projects is growing, since the number of postgraduate and PhD students has increased as well. From these facts arises the importance of presenting the so far defended doctoral dissertations from a specific area in order to determine the trends of the scientific interest and if they cover all aspects of a specific scientific branch. In marketing, the targeting strategy represents the selection of potential buyers or users to whom we want to offer and sell a particular product or service. The targeting strategy comprises three separate moments: the market segmentation, the selection of a target market and the positioning of a particular product or service. Kotler (2001) defines the term "market" as a former physical place where buyers and sellers gathered to exchange goods. Now marketers view the sellers as the industry and the buyers as the market. In the specific example of this paper, we will use the term "target topic" with the aim of processing the analysis of the three categories of interest in the research part: teaching, teacher education, and curriculum. Dowling et al. (2012) examine the importance of a doctoral dissertation resulting with a thesis defence for the publication of relevant research papers, because "scientific publications are a key indicator of development in any country and most of these products are produced in universities by postgraduates". It is just through the publication of doctoral dissertation theses that we can see their positioning on the target market and the target market for every doctoral student and future scientist are the scientific journals.

The aim of this study is to determine how many doctoral dissertations in Croatia has dealt with the physical education field according to all the three categories (teaching, teacher education, curriculum) and to analyse the area of interest with respect to targeting the topic of doctoral dissertations and the publication of scientific papers.

Methods

The sample of this study are the doctoral dissertations defended in the Republic Croatia, which deal with the field of physical education. The basic data sources were the *ON – LINE catalogue of the Library of the Zagreb Faculty of Kinesiology, Centre for online databases and the Croatian scientific*.

Selection

We found a total of 190 doctoral dissertations from the Croatian language area from the said database. According to the criterion of a research conducted on a population of pre-school children, pupils or students, 35 dissertations were singled out. The next step in the analysis was to classify the dissertations into three categories of this area: teaching, teacher education, and curriculum (Kulinna et. al., 2009). Teaching includes all the researches related to the educational process, teacher education those related to the education of teachers, while curriculum consists of researches that are related plans and programs. The first category comprises the dissertations of which the dependent variable of research is associated with the educational process, the second to the teacher education and the third to the work programs (Silverman, 1987). Based on the previously mentioned criteria, only 7 doctoral dissertations that really fall into physical education were singled out.

Coding

By taking the new sample of 7 doctoral dissertations into account, we created a total of three variables: the frequency of doctoral dissertations that fall into category (1) teaching; (2) teacher education; and (3) curriculum. Subsequently, through the *Centre for online databases and the Croatian scientific bibliography*, we investigated if doctoral dissertations resulted with research papers.

Data Analysis

The first methodology used in this study was a content analysis. The use of content analysis enabled the researcher to identify major constructs within the dissertation research and to classify these constructs. All dissertations (i.e., teaching, teacher education, and curriculum) were reported for yearly trends. Computer analyses produced frequencies for each category and dissertations were analysed across years.

Results

In the Table 1 we can see that the first doctoral dissertation dates 2002, while the last one covered by the analysis is from 2013. From then until today, six scientists have received their doctorates in the category of teaching, while only one in the category of curriculum. However, the alarming fact is that in the category of teacher education none doctoral dissertation has been defended until today.

Table 1: Teaching, teacher education, and curriculum dissertation by year

Year	Area			Total
	Teaching	Teacher Education	Curriculum	
2002.	1	0	0	1
2007.	1	0	0	1
2010.	1	0	0	1
2011.	1	0	0	1
2012.	1	0	0	1
2013.	1	0	1	2
Total	6	0	1	7

Source: processed by authors

It can be concluded that in most doctoral dissertations the research objectives are based on the teaching process; there is only one focused on the evaluation of particular programs and none related to teacher education.

The Table 2 shows the classification of doctoral dissertations in the subfield of physical education, the year of their defence and the information on existing or non-existing of a published thesis from a doctorate. After finding the published research papers of the authors of the analysed doctoral dissertations, we compared the titles and the contents. We noticed that only one out of seven authors has published the thesis from his doctoral dissertation.

Table 2: Doctoral dissertations with the thesis published in a scientific article

Category	Year	Scientific article
Teaching	2002.	No
	2007.	No
	2010.	No
	2011.	No
	2012.	No
	2013.	No
Teaching education	/	/
Curriculum	2013.	Yes

Source: processed by authors

Discussion and conclusion

It is the author's common opinion that doctoral dissertations are the basis of studies on physical education (Caffarelle, 1999). Consequently, we can say that in the Republic of Croatia this field has begun to develop at the scientific level only in 2009 with the defence of the first doctoral dissertation in this scientific branch. Therefore, we can conclude that the physical education field in our parts is still in its initial development. In the Republic of Croatia, the year 2010 is emerging as very important, because in each subsequent year, a doctoral dissertation was successfully defended, which certainly contributes to new ideas and the progress in this field.

Compared with global trends, we recognize that the number of dissertations on physical education is generally deficient: based on the analysis, we can notice statistically significant differences in frequencies between teaching, teacher education and curriculum. The results show that the absence of any defence of dissertation on teacher education and only one on curriculum is particularly problematic. One of the reasons for the lack of studies on teacher education and curriculum can be explained by the fact that there are no experts in Croatia with a narrow specialty in this subfield that could be mentors. On the other hand, it points out to the demand of this kind of topic targeting for further studies and doctoral dissertations, since there is no offer at all, but the demand is present. In the world, all the three areas are almost equally represented by doctoral dissertations so that 548 dissertations were defended from 1985 to 1999; 201 doctoral dissertations on teaching, 160 on teacher education and 187 on curriculum (Silverman & Manson, 2003). The same authors reported that the smallest number of defended dissertations published in Dissertation Abstracts International in a year was 26 and the biggest 50. Moreover, the studies focused on the comprehensive literature indicate that, in the world, there is significantly most published literature focused on the teaching field, even 65,31%, the curriculum is represented by 19,24% and the teacher education with only 15,45% (Kulinna et al., 2009).

A large gap arises in the science needs to comprehensively describe and examine the physical education. Until now, most dissertations on physical education in the Republic of Croatia were dedicated to teaching and, as we mentioned before, the lack of dissertations in the areas of teacher education and curriculum indicates a lack of correct targeting of the areas of interest of young scientists. Without doctoral dissertations, it is very difficult to expect a significant progress in science and thus the development of the physical education field in school education.

Based on the obtained results showing that only one dissertation resulted with a scientific paper, we can recognize the need for a better positioning of our efforts in the international scientific community by publishing studies. In this way, a wider scientific and non-scientific public, especially in foreign speaking areas, may benefit from the proven theses with the aim of a continuous contribution to science. According to the literature study published by Roudbari et al. (2012), only 5% of postgraduate studies in Iran in the period from 1997-2000 obtained at least one citation; 17% of doctoral dissertations in France in the period from 1993-1998 were published in indexed journals and the majority of doctoral theses did not obtain an approval for publishing in indexed journals.

Since most doctoral dissertations remain unpublished, the relevance of theses in the positioning segment is examined through a new term: "PhD by publication". According to the cited Robins & Kanowski (2008) in the study of Dowling et al. (2012), "the PhD by publication" consists of an unspecified number of stand-alone published or "publishable papers". This approach is very important for all doctoral students, PhDs and the wide scientific market, because the scientific articles, indexed in relevant journals, are the ones contributing to the scientific community, but also representing a benefit for individual scientists to advance in their profession.

Based on the analysis of the obtained data and the discussion, we can conclude that in the Republic of Croatia the frequency of doctoral dissertations on physical education is very modest in almost all categories, but most notably on teacher education and curriculum. It points to insufficient market studies in order to target the topic properly and finally to position the scientific achievements at the international level. Since there are no such doctoral dissertations, it is impossible to position the studies from this field in journals, both domestic and international, and therefore in this aspect, Croatia is behind considering the contribution at the global level. Further researches should take into account the published results

and think out the ways to encourage young scientists to work on this area, with the possibility of studying the future implications of new concepts especially in the teacher education and curriculum subfields and the association of these achievements in practice.

References

1. Caffarella, E.P. (1999, Feb.). The major themes and trends in doctoral dissertation research in educational technology from 1977 through 1998. Paper presented at National Convention of the Association for Educational Communications and Technology, Houston.
2. Cleary, R.E. (2000). The public administration doctoral dissertation reexamined: An evaluation of the dissertations of 1998. *Public Administration Review*, 60, 446-455.
3. <http://www.online-baze.hr/baze?q=&p=5> Centre for online databases – databases for the research and the academic community.
4. <http://kif.zaki.com.hr/pagesResults/rezultati.aspx?&action=search¤tPage=1&searchById=1&sort=3&spid0=1&spv0=Di> sertacija The on-line catalogue of the Library of the Zagreb faculty of Kinesiology.
5. Kulinna, H.P., Scrabis-Fletcher, K., Kodish, S., Phillips, S. and Silverman, S. (2009). A Decade of Research Literature in Physical Education Pedagogy. *Journal of Teaching in Physical Education*, 2009, 28, 119-140.
6. Pallas, A.M. (2001). Preparing education doctoral students for epistemological diversity. *Educational Researcher*, 30(5), 6-11.
7. Silverman, S. (1987). Trends and Analysis of Research on Teaching in Doctoral Programs. *Journal of Teaching in Physical Education*, 1987, 7, 61-70.
8. Silverman, S. and Manson, M. (2003). Research on Teaching in Physical Education Doctoral Dissertations: A Detailed Investigation of Focus, Method, and Analysis. *Journal of Teaching in Physical Education*. 22, 280-297.
9. White, R. (1997). Trends in research in science education. *Research in Science Education*, 27, 215-221.
10. Dowling, R., Gorman-Murray, A., Power, E. (2012). Critical Reflections on Doctoral Research and Supervision in Human Geography: The 'PhD by Publication', *Journal of Geography in Higher Education*, 36, 293–305.
11. Kotler, Ph. (2001). *Marketing management*, Millenium Edition, Prentice Hall, New Jersey.
12. Roudbari, M., Fard, Z. M., Vazirinasab, H. (2012). Paper publication ratios by postgraduates based on theses and dissertations in Tehran University of Medical Sciences. *Pak J Med*, 28 (5), 830-834

PRIMARY SCHOOL CHILDREN DIAGNOSED WITH ADHD AND PHYSICAL ACTIVITY PREFERENCES

Ingrid Ružbarská¹ and Erika Chovanová²

¹International School of Management ISM Slovakia, Prešov, Slovakia

²University of Prešov, Faculty of Sports, Prešov, Slovakia

Abstract

Children with Attention Deficit Hyperactivity Disorder (ADHD) experience negative outcomes in personal, educational, and social domains that usually negatively affect their adaptation throughout the life. Sport and physical activity could be beneficial for a number of cognition-related variables. This study is a preliminary part of the research project supported by the Research Grant Academy of the Slovak Republic no. 1/0769/13 with the title: Efficiency of physical and educational activities for correcting of the behaviour in children with ADHD. The aim of the study is to analyse physical activity preferences of children with ADHD. A total of 103 children with ADHD (54 boys, 49 girls) took part in the study with an average age of 9.5 ± 1.2 years (ranging from 7 to 10). Results show on tendency for preferring vigorous and cooperative games in boys. Girls prefer rather individual activities, but do not deny vigorous and cooperative games such as football.

Key words: school aged children, attention deficit hyperactivity disorder

Introduction

The clinical criteria for ADHD have evolved over the last 25 years. Attention Deficit Hyperactivity Disorder (ADHD) affects several general and specific mental functions: intellectual function, impulse control, sustaining and shifting attention, memory, control of psychomotor functions, emotion regulation, cognitive flexibility, time management, insight, and problem solving. At the level of activities, ADHD may cause limitations in learning and applying knowledge, including reading, writing, and calculation, managing stress and frustration (Barkley, 1990; Loe & Feldman, 2007).

Barkley (1990) reported some impairments likely to be associated with ADHD concerning motor development and motor skill performance: delayed motor coordination (up to 52%), more neurological “soft” signs related to motor coordination, poor self-regulation of emotion, and sluggish gross motor movements.

A growing body of studies has suggested that sport and exercise could be of benefit for a number of cognition-related factors (Hillman, Erickson, & Kramer, 2008).

Potential changes in cognition may be linked to psychological mechanisms such as self-esteem, attitudes following physical activity programs (Etnier et al., 1997). There is a lack of studies dealing with the effect of physical activity on specific domains of child development. This is especially true for children with mental health conditions such as ADHD (Hillman, Erickson, & Kramer, 2008). However, conclusions on the impact of variable physical activities on behaviour or cognitive functions are few and divergent for children with ADHD (Tomprowski, 2003)

Children with ADHD who participated in sports displayed significantly fewer anxiety and depression symptoms than those who did not participated in sport activities. Results suggest that active sport participation may be associated with a reduced expression of anxiety or depression in children with ADHD (Kiluk et al., 2009).

Parish-Plass and Luffi (1998) supported the therapeutic value of a combination of physical activity and social skills training in children with behavioural disorders. There has long been a consensus that physical activity is good for children with Attention Deficit Hyperactivity Disorder (ADHD) because these children are constantly moving. Physical activity has a positive impact on behaviour and cognitive functions of children with ADHD. Positive, significant behavioural changes are reported by parents and teachers for social problems, thought problems, and attention problems (Verret et al., 2012).

Methods

The study is a preliminary part of the research project supported by the Research Grant Academy of the Slovak Republic no. 1/0769/13 with the title: “*Efficiency of physical and educational activities for correcting of the behaviour in children with ADHD*”. The aim of the study is to analyse physical activity preferences among children with ADHD. The data collection was in 2013/January – March.

A total of 103 children diagnosed with ADHD (54 boys, 49 girls) took part in the study with an average age of 9.5 ± 1.2 years (ranging from 7 to 10). They were recruited from 12 primary schools in the Region of Kosice, in the Slovak

Republic. They attended regular primary classrooms but had self-centred learning plan. Only children with parental consent were included into data collection. There was applied a non-standardized questionnaire consisting of 6 open-ended and 2 closed-ended questions. In this study we present partial results only. Children were asked in the closed-ended questions to make a sequence of the activities according to popularity. One question was oriented to the school program activities; the other one was oriented to the outdoor activities during their leisure time. The sequential numbers represented the points for the following analysis. Then the sum of points (score) was calculated for every activity. Accordingly, activity with the smallest number of points represents the most popular one.

Results

The study results regarding the gender-related differences are illustrated graphically in tables 1 and 2. Within this preliminary study girls reported as the most popular physical activities swimming and badminton. It seems that they prefer rather individual sport activities. Surprisingly, less popular than swimming but still popular are football, gymnastics, dancing and ice-hockey. On the contrary, the most popular sport activities at boys are dynamic team sports such as ice-hockey, football, and dodgeball. It is obvious, that athletics, basketball are in the margin of the popularity in both examine groups. These results suggest that technically more demanding sport activities are not popular for children. Other reasons for this may be their negative experience, experience without the strong emotional load, or none experience with these activities.

Table 1: Physical activity preferences (School educational programs)

GIRLS (N=49)		BOYS (N=54)	
Activity rank by popularity	Score (points)	Activity rank by popularity	Score (points)
Swimming	62	Football	74
Badminton	108	Ice-hockey	78
Football	165	Dodgeball	111
Gymnastics/Dancing	176	Swimming	134
Ice-hockey	185	Badminton	199
Ringo	220	Athletics	218
Dodgeball	245	Ringo	258
Athletics	266	Gymnastics/Dancing	303
Basketball	337	Basketball	324

There are very similar preferences for outdoor physical activities in girls and boys. Definitely the most popular activities for children are cycling and skating, which is not surprising. It copies the trends in children without ADHD. It is obvious that these results are determined by children's experience, their socio-economic status, psychological status, and family backgrounds, which should be necessary to study so that we could make a deeper insight into preferences of children with ADHD.

Generally, outdoor activities may be supposed to be satisfactory for children with ADHD concerning their cognitive, psychological and social profile.

Table 2: Physical activity preferences (Outdoor activities)

GIRLS (N=49)		BOYS (N=54)	
Activity rank by popularity	Score (points)	Activity rank by popularity	Score (points)
Cycling	81	Cycling	104
Skating/Inline skating	125	Skating/Inline skating	126
Water attractions	173	Water attractions	135
Skiing	202	Skiing	226
Hiking	215	Hiking	254

Children with ADHD are always on the move, constantly talking, and in perceptual motion. This may be often reflected in rather poor behaviour reports, evaluation, exhausted teachers and parents. However, physical education lessons provide an opportunity “accept” to some extent their hyperactivity, but they need patient and understanding help in slowing and calming down, relaxing and regulating their emotions.

Discussion and conclusion

Results of this study are in some parts consonant with the other studies. Harvey et al. (2009) reported that boys with ADHD presented a greater preference for and participation in individual activities (e.g. bicycling, swimming, and roller – blading) than their peers without ADHD. In addition, the boys with ADHD reported to spend approximately 30 min less time in daily physical activity than boys without ADHD. Boys without ADHD reported their skills to be the same or better when compared with their peers while the boys with ADHD reported their movement and sport skills were better when compared with other children in PE class. It seems that boys may have overrated their skills.

Children may lack the ability to regulate their skill performance in different movement settings. Children may have the difficulties in self-regulation. Parents and teachers of children with ADHD suggested the children have poorer movement and sport skills (Harvey et al., 2003). Many children with ADHD may be affected by a developmental skill-learning gap, where children with less physical skill may have limited opportunities to become involved in physical activities and experience success. Results of this study do not suggest minor preference for cooperative games mostly in boys.

Attention Deficit Hyperactivity Disorder (ADHD) is a serious public health problem affecting a large number of children. It includes a combination of problems, such as difficulty sustaining attention, hyperactivity and impulsive behaviour. Problems in school are a key feature of attention-deficit/hyperactivity disorder. Children with ADHD also may struggle with low self-esteem, troubled relationships and poor performance in school. Early diagnosis and treatment can make a big difference in outcome. While treatment won't cure ADHD, it can help a great deal with symptoms. Treatment typically involves medications and behavioural interventions. Many schools are including exercise in their curricula to help kids do better in the classroom.

In conclusion, even though the study is limited in its power to generalize, it outlined the preliminary knowledge about physical activity preferences of children with ADHD. It may help in designing appropriate and more effective school programs to meet specific children's needs.

References

1. Barkley, R. A. (1990). *Attention deficit hyperactivity disorder: A handbook for diagnosis and treatment*. New York: Guilford Press
2. Etnier, J. L., Salazar, W., Landers, D. M., Petruzzello, S. J., Han, M., and Nowell, P. (1997). The influence of physical fitness and exercise upon cognitive functioning: A meta-analysis. *Journal of Sport and Exercise Psychology*, 19, 249 – 277.
3. Harvey, W. J. & Reid, G. (2003). A review of fundamental movement skill performance and physical fitness of children with ADHD. *Adapted Physical Activity Quarterly*, 20, 1 – 25.
4. Harvey, W. J., Reid, G. Bloom, G. A., and Staples, K. (2009). Physical activity experiences of boys with and without ADHD. *Adapted Physical Activity Quarterly*, 26, 131 – 150.
5. Hillman, C. H., Erickson, K. I., and Kramer, A. F. (2008). Be smart, exercise your heart: Exercise effects on brain and cognition. *Nature Reviews*, 9, 58 – 65.
6. Kiluk, B. D., Weden, S., and Culotta, V. P. (2009). Sport participation and anxiety in children with ADHD. *Journal of Att. Dis.*, 12(6), 499 – 506.
7. Loe, M. I., and Feldman, H. M. (2007). Academic and educational outcomes of children with ADHD. *Journal of Pediatric Psychology*, 32(6), 643 – 654.
8. Parish-Plass, J. & Lufi, D. (1998). Combining physical activity with a behavioural approach in the treatment of young boys with behavioural disorders. *Small Group Research*, 28, 357 – 369.
9. Tomporowski, P. D., Davis, C. L., Miller, P. H., and Naglieri, J., A. (2008). Exercise and children's intelligence, cognition, and academic achievement. *Educational Psychology Review*, 20, 11 – 131.
10. Verret, C., Guay, M. C., Berthiaume, C., Gardiner, P., and Bliveau, L. (2012). A physical activity program improves behaviour and cognitive functions in children with ADHD: An exploratory study. *Journal of Attention Disorders*, 16(1), 71 – 80.

Acknowledgement

This research was supported by the Research Grant Academy of the Slovak Republic no. 1/0769/13 awarded to the authors.

TEST – RETEST RELIABILITY OF THE BENT ARM HANGING TEST FOR THE EVALUATION OF THE MUSCULAR STRENGTH OF PRESCHOOL CHILDREN

Zvonimir Tomac¹, Biljana Trajkovski² and Josipa Dolibašić³

¹Faculty of Teacher Education, University of Osijek, Croatia

²Faculty of Teacher Education, University of Rijeka, Croatia

³Kindergarten „Lojtrica," Velika Gorica, Croatia

Abstract

The aim of this study was to determine the reliability of the endurance test in the bent arm hanging test in order to estimate the static power among preschool children, as well as possible gender differences and the influence of gender on the reliability of the test. 70 children, 34 girls and 36 boys aged 5,5 to 6,5 from the pre-school institutions in Zagreb participated in the study. The measuring instrument was a test of endurance in the bent arm hanging test, and the measurement was conducted in three series that were repeated every 2 days. The results showed that the test of endurance in the bent arm hanging test is appropriate for the estimation of the static hand strength of children, but at least one trial attempt is recommended.

Key words: *test of endurance in the bent arm hanging test, static arm and shoulder strength, preschool children*

Introduction and study problem

During the last twenty years we have been witnessing a significant progress in the development of technology that has inevitably changed people's lives. In the consumer world, and due to the fast pace of life, fewer people care about their own health and the health of their loved ones, including their children. In the absence of time and due to great pressure in the race for progress, and the need to prove oneself in the business world, a very small number of parents apply a healthy lifestyle by conducting physical activity and by consuming a healthy diet. Unfortunately, this is also reflected on the children since they adopt the wrong habits of healthy living from an early age as well as get sick faster and more often than was the case in the not so distant past. On the contrary, an increasing number of children are beginning to spend their free time indoors, watching television and playing video games, sitting for hours. By staying indoors they do not have the opportunity to develop the dimension of strength through different movements which are provided for children who spend their free time playing various outdoor games (pulling the rope, climbing the rope, climbing ladders, jumping in sacks, dodgeball, etc.). Since no kinanthropological dimension is developed independently, but they are all closely intertwined, it is of utmost importance for the optimal child growth and development to develop all of them equally, as well as the dimension of strength in all three of its forms (repetitive, explosive and static strength).

The child is developing from the beginning, from the first movement, by clenching the fists, reaching out for objects, raising the body, through crawling, to the strength required to be raised to the standing position, and then the first steps and running. For a proper motor development it is of great importance to create opportunities for children in which they will, guided by their own internal urge, develop the strength dimension by determining the pace and intensity of its development. This way, the muscular fitness components of health are developed that through their manifestations of strength, intensity and endurance can help reduce the incidence of locomotor disorders. A higher level of these dimensions allows the reduction of the burden of joint surfaces by increasing their stability, greater blood flow through muscles at the same levels of force, and which allows for the delay of fatigue and the increase of endurance (Mišigoj - Duraković et al., 1999). One of the most widely used measuring instruments for assessing muscle strength and endurance is the bent arm hang test, which is an integral part of the EUROFIT battery of tests, and is often used in the assessment of physical activity or physical performance as well as its relationship with anthropometric characteristics and obesity measures. Ruiz et al. (2006) point out that the importance of the measurement of this test is strongly associated with the amount and percentage of body fat, because obese people have significantly poorer results in this test as opposed to the handgrip test in which they usually achieve better results than the non-obese. Thus, Ara et al. (2007) found significant differences in physically active and physically inactive boys aged 7-12, connection between physical fitness, subcutaneous adipose tissue and results in the bent arm hang test. Also, a negative correlation between body fat and bent arm hang test was established by Woods, Pate and Bourges (1992). In addition, Orjan, Kristjan and Bjorn (2005) found gender differences in the muscle strength in children aged 10-13 in favor of boys, but also a gradual improvement of the results during growing up.

For a quality assessment of muscle strength it is necessary to use reliable measurement instruments. The psychometric characteristics that are not at the level of psychological tests (Netelenbos, 2001) are mentioned as the most common

deficiencies of motor tests. While with the composite measuring instruments, which are intended for the qualitative assessment of motor abilities, the reliability is determined by using the internal consistency, the test-retest method is used for the assessment of the static strength due to the high load during the measurement reliability. Thereby Hopkins (2000) mentions the need for a minimum of three measurements per number of respondents greater than 50. With these settings, the reliability analyses of the composite measurement instruments for preschool children and younger school-age children have generally shown a satisfactory level of reliability with Cronbach α values between 0,700 and 0,950 for the assessment of the explosive strength of the throw and jump type (Caput - Jogunica, De Privitellio and Lončarić, 2009), coordination, explosive strength and frequency of movement (Bala, 1999; Zurc, Pišot, Strojnik, 2005) and flexibility (Patterson et al., 1996) using the internal consistency. Due to the volume load that occurs during the power endurance tests it is not possible to construct a composite measurement instrument so that its reliability is determined by the test-retest method. A great variability of the results in repeated measurements has been determined by the research results in tests of explosive strength (Duncan, Al - Nakeeb, Nevill, 2005).

Study objective

The aim of this study was to determine the test-retest reliability of the measuring instrument for the assessment of the static arm and shoulder strength among preschool children, and to identify possible gender differences and the influence of gender on the reliability of the test.

Methods

Sample

70 children, 34 girls and 36 boys, aged 5,5 to 6,5 participated in the study. During the conducting of the study all children were healthy and fully aware of the study content (measurements) and a written consent of a parent / guardian was received for each child in order for them to participate in the study, which is in accordance with the Code of Ethics prepared by the Council for Children as an advisory body of the Croatian Government.

The sample of variables

The sample of variables represented a test to evaluate the static strength of arms and shoulders endurance in the bent arm hanging test. The results were collected in three series of measurements that were repeated every two days with one measuring of the static force per day.

Methods of data processing

The normality of distribution was tested by the Kolmogorov-Smirnov test, and the reliability between sets of measurements was calculated by the Interclass correlation coefficient (ICC). With the Mann - Whitney U-test, differences by gender were determined in individual series of measurements. To determine the systematic errors of measurement and gender differences the two-factor analysis of variance for repeated measures (ANOVA) was used, and subsequent Fisher LSD post hoc to determine the difference between series of measurements. Random error was measured by the coefficient of the variation (CV).

Results and discussion

Table 1: Descriptive indicators of the results in the entire sample (AS-mean; MIN-lowest score; MAX-highest score, SD-standard deviation, Skewness-curvature; Kurtosis-flattening, CV-random error; KSD-normality of distribution)

	AS	Min	Max	SD	Skewness	Kurtosis	CV	K-S d
1. series	14,74	2,00	60,30	11,67	2,07	4,90	79,16	0,197*
2. series	16,83	2,10	43,30	8,92	1,00	0,70	53,00	0,130*
3. series	17,83	3,10	50,50	9,64	1,15	1,31	54,05	0,150*

* Distribution differs significantly from the normal

The results indicate that with the endurance test in higher pull-ups there is a significant deviation from normal distribution (K-S d, Skewness, Kurtosis), which impairs the sensitivity as an important metric characteristics of the measuring instrument and a high coefficient of the variation is also emphasized. However, in subsequent measurements there exists a significant reduction of these coefficients as well as their stabilization. The deviation from the normal distribution toward poorer results was observed in some other studies in this test (Trajkovski, 2004, 2011), whereby it can be concluded that this test is too difficult and not suitable for children of preschool age.

Results of the MW test for independent samples, whereby gender differences were determined, are shown in Table 2.

Table 2: Descriptive indicators and gender differences

		N	AS	Min	Max	SD	CV	Ske	Kurt	U	Z	p
1. series	M	35	17,32	5,00	52,90	11,65	67,28	1,81	3,18	376,0	2,62	0,00*
1. series	F	34	12,07	2,00	60,30	11,23	93,02	2,79	10,12			
2. series	M	33	18,98	7,90	36,80	7,71	40,64	0,74	-0,25	355,5	2,57	0,01*
2. series	F	34	14,74	2,10	43,30	9,61	65,18	1,53	2,28			
3. series	M	33	19,90	4,90	50,50	9,87	49,59	1,39	2,08	385,5	2,03	0,04*
3. series	F	33	15,71	3,10	37,20	8,91	56,72	0,98	0,16			

N - number of respondents; AS mean; MIN - lowest score; MAX - highest score, SD - standard deviation, Ske - Skewness, Kurt - Kurtosis, CV random error, U - U value, Z - value; p - significance level)

The results show that in all measurement series there exists a statistically significant difference between boys and girls with boys demonstrating better results in the strength test, which has been determined before among older children (Orjan, Kristjan i Bjorn 2005). Some authors have already noted that in some tests of explosive strength (Morris et al. 1982, Bala 2003; Zurc, Pišot, Strojnik 2005; Bala and Katić 2009), and the differences are particularly apparent among school-age children (Trajkovski 2011). However, in the research of endurance in the bent arm hanging test Krombholz (2006), and Bala and Thunderbird (2009) did not find significant differences.

Results of the test-retest reliability of the endurance test in the bent arm hanging test on the entire sample indicate that there was no statistically significant effect of the repeated measurements on the results of the test ($F = 2.97$, $p = 0.06$), and therefore there is no statistically significant difference between individual series of measurements. Nevertheless, the subsequent post - hoc test (Fisher LSD) showed that there are still significant differences between the first and third series of measurements ($p = 0.01$), while there was no significant difference between the second and third series ($p = 0.40$).

Intraclass correlation coefficient is therefore $ICC = 0.784$ and ranges in the 95% confidence interval (0.672 to 0.862). Slightly higher interclass correlation coefficient, but on the older sample (19, 4 years), were determined Tsigilis, Douda I Tokmakidis (2002) and amounted to 0, 89, 95% CI 0, 84 - 0, 93. However, these results can be considered as a restriction to the research because it is stated that the values ICC from 0,7 to 0,8 are of questionable significance, while only values above 0,9 are considered relevant (Artero et al., 2010).

Table 3: Differences by gender and repeated measurements

	SS	Degr. of Freedom	MS	F	p
Intercept	53224,23	1,00	53224,23	257,42	0,00
GENDER	1126,02	1,00	1126,02	5,45	0,02*
MEASUREMENT	286,29	2,00	143,14	2,97	0,06
MEASUREMENT*GENDER	22,98	2,00	11,49	0,24	0,79

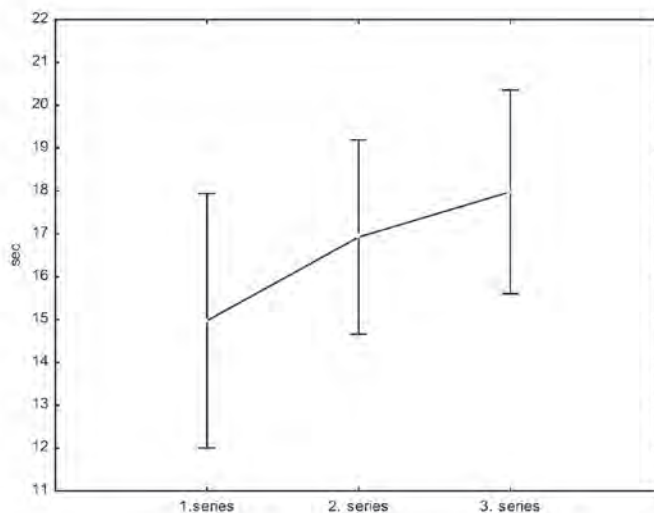

Figure 1: Curve of the results of the entire sample in the test

By analyzing the reliability of the test separately by gender it was observed that neither among boys ($F = 0.24$, $p = 0.79$) nor among girls ($F = 2.79$, $p = 0.07$) was there a statistically significant difference in the results of repeated measurements. Also, interclass correlation coefficient is at a questionable level in boys it is $ICC = 0.706$ (95% CI 0.466 to 0.848), and satisfactory level in girls $ICC = 0.814$ (95% CI 0.669-0.902). Table 3 shows the results of the two-factor analysis of the variance for repeated measures (ANOVA) for determining the systematic error of measurement and gender differences.

From the table it is clear that there is no significant effect of gender on repeated measurements of endurance in the bent arm hanging test ($F = 5.45$, $p = 0.02$). Although, generally speaking, there are significant differences by gender (in all three measurements in total), though there was no statistically significant interaction between gender and repeated measurements. So, neither was a statistically significant effect of measurements obtained, nor an interactive effect of measurements and gender.

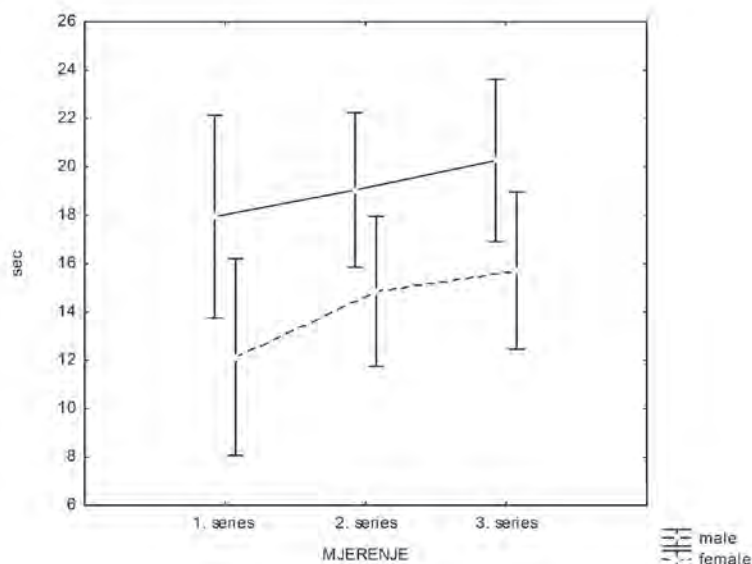

Figure 2: The curve results by gender during a series of measurements in the test bent arm hang.

Results indicate that with the endurance of higher pull-ups in the first series of measurements there exist significant deviations in distribution from the normal (K-S d, Skewness, Kurtosis), which impairs the sensitivity as an important metric characteristics of the measuring instrument and has also expressed a high coefficient of variation. Nevertheless, in subsequent measurements a significant reduction of these coefficients and their stabilization was noticeable. However, significant differences between the first and third measurement series were determined with the post-hoc test, and at least one series of measurements before using the results is recommended. Marković et al. (2004) also suggest this in some tests of the explosive force. Also the level of reliability of the test is questionable because the entire sample and the sample of boys ICC are at a questionable level, while it is at a satisfactory level only among girls. Although Tsiglis, Douda and Tokmakidis (2005) received a satisfactory value of the ICC among the elderly population, the authors emphasize that it is possible that the test is too demanding because the standard deviation value is very large, and the value of the coefficient variation is CV 18.6%.

Conclusion

In this study, with a sample of 70 children from kindergartens in Rijeka, the static strength of arms and shoulders was assessed by means of the endurance test in higher pull-ups whereby the test's reliability and applicability among preschool age was determined as well.

With the results of measurements and the statistical analysis of data processing it has been established that there is a relatively satisfactory level of reliability, and sex differences in muscle strength and endurance have been determined, but at the impact of gender is not interacting with the results of repeated measurements and does not cause a systematic measurement error as determined by Ortega et al. (2008).

Therefore we can state that the endurance test in the bent arm hanging test is reliable and applicable to the assessment of muscle strength of arms and shoulders among preschool children, after at least one test attempt before the measurement.

Muscular strength and endurance is very important in the man's overall ability of the mobility area, therefore it is necessary to provide the opportunity for children to develop it by means of programmed kinesiological activities, and this is only possible with reliable indicators of the level of their abilities.

References

1. Ara, I., Moreno, L.A., Leiva M.T., Gutin, B. & Casajus, J.A. (2007). Adiposity, Physical Activity, and Physical Fitness Among Children From Arago'n, Spain. *Obesity*, 15 (8), 1918 – 1924.
2. Bala, G. & Katic, R. (2009). Sex Differences in Anthropometric Characteristics, Motor and Cognitive Functioning in Preschool Children at the Time of School Enrolment. *Collegium Antropologicum*, 33(4), 1071 – 1078.
3. Bala, G. (1999). Some Problems and Suggestion in Measuring Motor Behavior of Preschool Children. *Kinesiolgia Slovenica*, 5(1-2), 5 – 10.
4. Bala, G. (2003). Quantitative Differences in Motor Abilities of Preschool Boys and Girls. *Kinesiolgia Slovenica*, 9 (2), 5 – 16.
5. Caput – Jogunica, R., De Privitellio, S. & Loncaric, D. (2009). Children S Achievements In Composite Measurement Instruments For Explosive Strength. *Acta Kinesiologica*, 3 (2), 38 -42
6. Duncan, M.J., Al – Nakeeb, Y. & Nevill, A.M. (2005). Influence of Familiarization on a Backward, Overhead Medicine Ball Explosive Power Test. *Research in Sports Medicine*, 13 (4), 345 – 352.
7. Hopkins, W.G. (2000). Measures of Reliability in Sports Medicine and Science. *Sports Medicine*, 30(1), 1 -15.
8. Jeffrey A. Woods, J.A, R.R. & Burgess, M.L (1992). Correlates to Performance on Field Tests of Muscular Strength. *Pediatric Exercise Science*, 1992, 4, 302-311
9. Krombholz, H. (2006). Physical Performance in Relation to Age, Sex, Birth Order, Social Class, and Sport Activities of Preschool Children. *Perceptual and Motor Skills*, 102 (2), 477 – 484.
10. Marković, G., Dizdar, D., Jukić, I. & Cardinale, M. (2004). Reliability And Factorial Validity Of Squat And Countermovement Jump Tests. *Journal of strength and conditioning research*, 18(3), 551- 555.
11. Mišigoj – Duraković i sur. (1999). Tjelesno vježbanje i zdravlje. Kineziološki fakultet, Sveučilište u Zagrebu.
12. Morris, A.M., Williams J.M., Atwater, A.E. & Wilmore, J.H. (1982). Age and Sex Differences in Motor Performance of 3 Through 6 Year Old Children. *Research Quarterly for Exercise and Sport*, 53(3) 214 – 221.
13. Netelenbos, J.B. (2005). Teachers Ratings of Gross Motor Skills Suffer from Low Concurrent Validity. *Human Movement Science*, 24(1), 116 – 137.
14. Orjam, E., Kristjan, O. & Bjorn, E. (2005). Physical performance and body mass index in Swedish children and adolescents. *Scandinavian Journal of Nutrition*, 49 (4): 172 – 179.
15. Ortega F.B., Artero E.G., Ruiz, J.R., Vicente-Rodriguez, G., Bergman, P., Hagströmer, M., Ottevaere, C., Nagy, E., Konsta, O., Rey-López, J.P., Polito, A., Dietrich, S., Plada, M., Béghin, L., Manios, Y., Sjöström, M. & Castillo, M.J. (2008). Reliability of health-related physical fitness tests in European adolescents. The HELENA Study. *International Journal of Obesity* 32, S49–S57
16. Patterson, P., Bennington, J. & De La Rosa, T. (2001). Psychometrics Properties of Child – and Teacher – Reported Curl- Up Scores in Children Ages 10 – 12 Years. *Research Quarterly for Exercise and Sport*, 72(2), 117 -124.
17. Ruiz, J.R., Ortega, F.B., Gutierrez, A., Meusel, D., Sjoström, M. & Castillo, M.J. (2006). Health-related fitness assessment in childhood and adolescence: a European approach based on the AVENA, EYHS and HELENA studies. *Journal of Public Health* 14, (5) 269-277.
18. Trajkovski Višić, B. (2004). Utjecaj sportskog programa na promjene morfoloških i motoričkih obilježja djece starosne dobi četiri godine. (magistarski rad). Zagreb. Kineziološki fakultet u Zagrebu Sveučilišta u Zagrebu.
19. Trajkovski, Biljana (2011). Kinantropometrijska obilježja djece predškolske dobi i njihova povezanost s razinom tjelesne aktivnosti roditelja. Kineziološki fakultet Sveučilišta u Zagrebu (doktorska disertacija).
20. Tsigilis, N., Douda, H. & Tokmakidis, S.P. (2002). Test-Retest Reliability Of The Eurofit Test Battery Administered To University Students. *Perceptual and Motor Skills*, 95 (3) , 1295-1300.
21. Zurc, J., Pišot, R. & Strojnik, V. (2005). Gender Difference in Motor Performance in 6.5 year old Children. *Kinesiolgia Slovenica*, 11(1), 90 – 105.

DIFFERENCES IN MEASURES OF THE SUBCUTANEOUS FAT AMONG CHILDREN WITH REGARDS TO THEIR INCLUSION IN A SPORTS PROGRAM AT PRESCHOOL AGE

Biljana Trajkovski¹ and Marjeta Mišigoj-Duraković²

¹Faculty of Teacher Education, University of Rijeka, Croatia

²Faculty of Kinesiology, University of Zagreb, Croatia

Abstract

The aim of this study was to determine the differences in the dimensions of the subcutaneous fat between boys and girls according to age groups and groups (control, experimental involved in a sports program). The study included 414 children aged 4, 5 and 6. The experimental group consisted of 158 children (105 boys and 55 girls), and the control group of 256 children (184 boys and 122 girls). The children were monitored in skin fold measures (skin fold of the upper arm, back skin fold and lower leg skin fold). It was found that in the control group boys differ from girls among four-year-olds in the subscapular skin fold, among five-year-olds in the measurements of the skin fold of the upper arm and lower leg skin fold and among six-year-olds in all three skin folds in favor of larger dimensions among girls. In the experimental group, however, boys and girls do not differ significantly in these measures.

Key words: skin folds, sports program, preschool children

Introduction and study problem

The modern way of life among adults which lacks motor activity not only leaves a negative effect on their health, but unfortunately the health of children and youth. Adults carry over their lifestyle to their child so that the family environment often doesn't have the conditions (time and space) to meet their genuine needs for exercise and play. Therefore, lack of motor activity in preschool age will not only adversely affect the development of skills and the acquisition of motor skills, but the consequences of a lack of movement have a negative impact on the health status of the child, and will lead to the first occurrence of being overweight. The data suggests that 4 million children aged 6-11, and more than 5 million children between the ages of 12-19 are overweight (Westcott, 2006). Even among preschool children an increase in the share of overweight children and changes in body composition with higher amounts of fat component is noticeable (Horvat et al., 2009). Physical activity is the most natural way to maintain optimal body weight and body composition. Therefore, it is necessary to ensure that children have time and space for activities already from preschool age. Studies are in favor of the fact that preschool children who are physically active have lower levels of blood lipids, higher values of the protective lipoprotein HDL (high density lipoprotein), greater cardiorespiratory ability, better motor skills as well as better motor and functional abilities (Parizkova, 2008). Intervention exercise program and the involvement of children in sports programs have proven to be effective in improving body composition and aerobic physical fitness in overweight and obese children as well as normal weight children (Carrel et al., 2005; Eliakim et al., 2007, Carrel et al., 2009). By studying the morphological space among four-year-old children attending a sports program and those who do not attend, the initial and final testing for a period of nine months showed significant changes between girls in the experimental and control groups in measures of the subcutaneous adipose tissue (Trajkovski Višić et al., 2008).

Study objective

The aim of this study was to determine whether there are differences in dimensions of the subcutaneous fat between boys and girls according to age groups and with regards to their inclusion in a sports program already in preschool age.

Study methods

The sample

414 children from kindergartens from the city of Rijeka, Croatia participated in the study. During the test all subjects were healthy without special documentation for a physical illness. The experimental group consisted of a total of 158 children aged 4, 5 and 6 (105 boys and 55 girls) who participate in a kinesiology program four times a week for 45 minutes in the morning hours (Pejčić, 2003). According to age this group consisted of 12 four-year-olds (6 boys and 6 girls), 66

five-year-olds (43 boys and 23 girls), 80 six-year-olds (54 boys and 26 girls). The control group consisted of a total of 256 children aged 4, 5 and 6 (184 boys and 122 girls). According to age this age group consisted of 100 four-year-olds (59 boys and 41 girls), 93 five-year-olds (51 boys and 42 girls) and 63 six-year-olds (24 boys and 39 girls).

The sample of variables

The sample of variables measured in the children make three measures of subcutaneous adipose tissue (upper arm skin fold, subscapular skin fold and lower leg skin fold) measured according to the standard procedure of the International Biological Program (Weiner and Lourie, 1969, Mišigoj - Duraković, 2008).

Methods of data processing

For the purposes of this study basic descriptive parameters were calculated, t - test for independent samples and the Mann - Whitney U - test by subgroups according to age and gender.

Results and discussion

The t-test for independent samples and the Mann-Whitney U-test verified the differences in anthropometric dimensions of the subcutaneous fat between boys and girls according to age groups and belonging to a group (control, experimental) to determine which dimensions make the girls differ significantly from the boys.

The results of the t-test for independent samples for girls and boys aged 4, 5 and 6 in the control and experimental group and a significant difference between the control and experimental groups are shown in Tables 1, 2 and 3.

Table 1: Measures of skin folds (mm) in the control group of girls and boys aged 4 (XF±SD - mean girls; XM±SD - mean boys, t=result of t-test for independent samples, z=score of the Mann-Whitney U-test, p=significance level)

SKIN FOLDS	4 YEARS OF AGE				
	GROUP	XM±SD	XF±SD	t or z	p
UPER ARM	CONTROL	5,8±2,6	5,6±2,5	0,467	0,641
SUBSCAPULAR	CONTROL	4,1±2,1	5,1±2,0	-2,311	0,023
LOWER LEG	CONTROL	6,6±2,0	7,3±2,2	-1,766	0,081

*Mann-Whitney U-test

Results obtained from the t-test for independent samples among four-year-olds (boys and girls) in the control group showed significant differences between boys and girls in the measured skin folds (4.1±2.14 vs. 5.1±1.98; p=0.02) whereby girls have a bigger skin fold than boys. Although we cannot find significant differences in body size and body height (107.6±4.4 - boys and 106.4±4.9 - girls) and body mass (18.5±2.4 - boys and 18.4±3.0 - girls) such a result indicated the existence of significant differences in the body composition (Trajkovski, 2011).

Table 2: Measures of skin folds (mm) in the control and experimental groups of girls and boys aged 5 (XF±SD - mean girls; XM±SD - mean boys, t = result of the t- test for independent samples, z score = Mann - Whitney U - test, p = significance level)

SKIN FOLDS	5 YEARS OF AGE				
	GROUP	XM±SD	XF±SD	t or z	p
UPER ARM*	CONTROL	5,7±1,94	7,0±3,21	-1,969	0,049*
	EXPERIMENTAL	5,1±2,0	4,7±1,9	0,876	0,384
t or z		1,300	3,135*		
p		0,197	0,002*		
SUBSCAPULAR	CONTROL	4,4±1,58	6,0±3,67	-1,779	0,075*
	EXPERIMENTAL	4,5±2,0	4,6±1,9	-0,107	0,915
t or z		-0,328	1,269*		
p		0,744	0,204*		
LOWER LEG	CONTROL	6,2±2,14	9,2±3,65	-4,593	0,000*
	EXPERIMENTAL	6,2±2,7	6,3±1,7	-0,189	0,851
t or z		0,019	3,745*		
p		0,984	0,000*		

*Mann-Whitney U-test

Among five-year-olds, in the control group, the differences between boys and girls were established with the Mann-Whitney test for nonparametric tests and statistically significant difference in the skin folds of the upper arm (5.7 ± 1.94 as opposed to 7.0 ± 3.21 , $p=0.049$) and lower leg skin fold (6.2 ± 2.14 as opposed to 9.2 ± 3.65 , $p=0.000$) in larger sizes among girls were identified. The results obtained by the t-test for independent samples among five-year-olds (boys and girls) in the experimental group show that there were no statistically significant differences between five-year-old boys and girls when compared to the control group. The results show that the five-year-old girls differ in the extent of the upper arm skin fold (7.0 ± 3.2 vs. 4.7 ± 1.9 , $p=0.002$) and lower leg skin fold (9.2 ± 3.6 vs. 6.3 ± 1.7 , $p=0.000$) in favor of smaller skin folds in girls participating in the kinesiology program. The five-year-olds (boys and girls) statistically significant differences were found in the upper arm skin fold and the lower leg skin fold in favor of larger dimensions among girls. At this age the differences between boys and girls in skin fold measures are even more emphasized. Similar differences were obtained by some other authors (Bala and Katić, 2009). It is interesting to note that among boys and girls who have been participating in the sports program for one year no difference in skin folds were observed as they were in the control group. With increasing age girls and boys in the control group significantly differ in the amount of subcutaneous fat while such differences were not obtained in the experimental group. Although we cannot conclude with certainty on the basis of the results of the cross-sectional study, the results support the claim that girls who participate in the sports program do not increase the size of the skin fold as the girls in the control group do. This is supported by the results of studies comparing the control and experimental group in the initial and final checking of four-year-old children (Trajkovski Višić et al, 2008). Research conducted by Eliakim et al. (2007) has indicated positive effects of the intervention programs of exercise and the control of eating habits.

Table 3: Measures of skin folds (mm) in the control and experimental group of girls and boys aged 6 ($XF \pm SD$ - mean girls; $XM \pm SD$ - mean boys, t = result of the t-test for independent samples, z score = Mann-Whitney U-test, p = significance level)

		6 YEARS OF AGE			
SKIN FOLDS	GROUP	$XM \pm SD$	$XF \pm SD$	t or z	p
UPPER ARM*	CONTROL	$5,6 \pm 2,3$	$7,7 \pm 2,9$	-3,071	0,003
	EXPERIMENTAL	$5,8 \pm 3,6$	$6,4 \pm 3,0$	-0,822	0,413
t or z		-0,221	1,763		
p		0,826	0,083		
SUBSCAPULA	CONTROL	$4,3 \pm 2,2$	$5,6 \pm 2,8$	-2,006	0,049
	EXPERIMENTAL	$5,4 \pm 3,2$	$5,8 \pm 2,4$	-0,647	0,519
t or z		-1,490	-0,247		
p		0,140	0,806		
LOWER LEG	CONTROL	$6,4 \pm 3,0$	$8,7 \pm 2,8$	-3,08	0,003
	EXPERIMENTAL	$7,6 \pm 3,5$	$8,0 \pm 2,9$	-0,464	0,643
t or z		-1,426	1,049		
p		0,158	0,298		

*Mann-Whitney U-test.

Among six-year-olds in the control group (boys and girls) statistically significant differences in all three skin folds in favor of larger dimensions in girls were obtained, which once again underlines the gradual increase in the difference in the amount of subcutaneous body fat between girls and boys of preschool age. Similar trend of increasing differences in subcutaneous adipose tissue is reported by some other authors (Pejčić and Malacko (2005). As with the five-year-olds, here as well the girls at the age of six, which are in the experimental group, did not differ from the boys in measures of skin folds as opposed to six-year-old girls in the control group. The results, however, showed that the six-year-old girls in the experimental and control groups in the area morphological characteristics did not differ significantly in any of the variables.

Conclusion

A gradual increase is noticed in the difference in the amount of subcutaneous body fat in the body of girls versus boys from preschool age. The results show differences between the two groups in measures sensitive to external effects, especially physical activities such as the skin fold in girls. In girls who participate in the sports program, unlike the girls in the control group, the ratio of body fat and muscle is changed so that the skin folds are reduced. Applying a well programmed kinesiology content can affect individual morphological characteristics and help prevent obesity. By increasing the content of sport in the daily life of a child from the preschool age can help increase the likelihood that the child will accept physical activity and exercise as a permanent value.

References

1. Bala, G., Katić, R. (2009). Sex Differences in Anthropometric Characteristics, Motor and Cognitive Functioning in Preschool Children at the Time of School Enrolment. *Collegium Antropologicum*. Vol. 33(4), 1071-1078.
2. Carrel AL, Clark RR, Peterson SE, Nemeth BA, Sullivan J, Allen DB. (2005). Improvement of fitness, body composition, and insulin sensitivity in overweight children in a school-based exercise program: a randomized, controlled study. *Arch PediatrAdolesc Med*. 159 (10): 963-8.
3. Carrel AL, McVean JJ, Clark RR, Peterson SE, Eickhoff JC, Allen DB. School-based exercise improves fitness, body composition, insulin sensitivity, and markers of inflammation in non-obese children. *J PediatrEndocrinolMetab*. May;22(5), 409-15.
4. Eliakim A, Nemet D, Balakirski Y, Epstein Y. The effects of nutritional-physical activity school-based intervention on fatness and fitness in preschool children. *Journal of Pediatric Endocrinology and Metabolism*. 2007 Jun; 20(6), 711-8.
5. Horvat V, Misigoj-Duraković M, Prskalo I. Body size and body composition change trends in preschool children over a period of five years. *CollAntropol*. 2009 Mar; 33(1), 99-103
6. Mišigoj-Duraković, M. (2008). *Kinantropologija. Biološki aspekti tjelesnog vježbanja*. Zagreb. Kineziološki fakultet Sveučilišta u Zagrebu.
7. Parizkova, J. (2008). Impact of education on food behaviour, body composition and physical fitness in children. *Br. J. Nutrition. Suppl 1*, 26-32
8. Pejčić, A., Malacko, J. (2005). Ontogenetski razvoj morfoloških karakteristika i motoričkih sposobnosti dječaka i djevojčica u prva četiri razreda osnovne škole. *Kinesiologia slovenica*. (11) 2, 42-55.
9. TrajkovskiVišić, B., Mišigoj-Duraković, M., Živčić, K., Plavec, D. (2008). Effects of sport-activity programs in reducing subcutaneous fat in four-year-olds. In 5th International scientific conference on kinesiology. Zagreb, 570-573.
10. Trajkovski, Biljana (2011). *Kinantropometrijska obilježja djece predškolske dobi i njihova povezanost s razinom tjelesne aktivnosti roditelja*. Kineziološki fakultet Sveučilišta u Zagrebu (doktorska disertacija).
11. Weiner, JS.,Lourie, JA. (1969). *Human Biology*. A guide to field methods. IBP Handbook. Vol. 9. Blackwell, Oxford.
12. Westcott, W. L. (2006). Childhood Obesity. *Strength Cond. J*. Position statement about childhood obesity.

PERCEPTIONS OF NON-PE-MAJOR TEACHERS ON THE IMPLEMENTATION OF MALAYSIAN SECONDARY SCHOOL PE PROGRAM

Eng Hoe Wee

Tunku Abdul Rahman University College, Malaysia

Abstract

In Malaysia, PE is a compulsory subject taught in all secondary schools. However, its status remains controversial as many issues related to non-PE-major teachers are not resolved. This study examines the perception of non-PE-major teachers on the implementation of the Malaysian secondary school PE program in terms of teaching ability, class distribution, non-human factors, and PE program administration. A total of 1388 non-PE teachers were surveyed. Eighty per cent of teachers perceived that they could manage PE classes but fifty percent had adequate PE knowledge, were able to teach game skill, detect and correct students' weaknesses. Eighty five per cent were assigned to teach PE without PE qualifications. Majority felt that facilities was inadequate, administrators assumed PE unimportant and did not organize courses for PE teachers. The issue of non-PE-major teaching is prevalent in Malaysia thus it is imperative to examine the perceptions of non-PE-major PE teachers.

Key words: *physical education, teaching ability, class distribution, non-human factor*

Introduction

In Malaysia, even though Physical Education (PE) is a compulsory subject taught in all primary and secondary schools and considered important by the Ministry of Education Malaysia (Wee, 2013), its status remains controversial in the light of numerous issues encountered in the implementation of the PE program. Those issues are both teacher-related (PE teachers' teaching ability) and institution-related (distribution of PE classes, non-human factors, administration of PE program).

An earlier report by deVries (1975) noted that as a non-examination subject, PE in Malaysia is always considered the least important subject when making important decisions in schools (scheduling of PE classes, allotment of financial resources, assigning PE teachers). Qualified PE teachers are often assigned to teach 'more important' subjects (deVries, 1975) or subjects with more academic value (Frederick, 1998). Thus, PE is taught by *non-PE-major* teachers. According to Umi Kalsum and Gusti Mgurah (2013) 'the issue of 'out-of-field' teaching is prevalent in Malaysia, with the numbers dramatically increasing in a rapidly expanding school system' (p.5).

Issues regarding PE teacher competency, assigning teachers to teach PE is serious according to Malaysian researchers. Sebastian (2006) found only 20.9 percent of PE teachers were PE majors when comparing secondary schools in two urban areas. Despite schools having many *non-PE-major* PE teachers, school heads did not organize PE and sport related courses to ensure some quality in the teaching of PE (Wee, 2006 & 2009).

The lack of PE pedagogical knowledge (Noreha & Julisma, 2009) is accompanied by a lack of dedication (Wuest & Fissette, 2012) and creativity. It was found that PE teachers faced difficulties in managing students and was also unable to maximize the usage of equipment during PE lessons (Tan & Lee, 2004). PE teachers also faced a lack of facilities and equipment (often due to spoilt equipment that were salvageable but not repaired (Chong & Norlena, 2010), lack of coordination of outdoor facilities due to the shortage of indoor facilities, and lack of proper financial planning for the procurement of PE equipment (MOEM, 1994/1995).

The issues faced by PE teachers in Malaysian secondary schools are not widely researched, thus there is a need to further examine these issues, beginning with PE teachers' perceptions on the implementation of PE programs in schools.

Aims and tasks of research

Although PE has been taught in Malaysian schools for decades, its teaching leaves much to be desired. Its status as a non-examination subject has made it an expendable subject to be replaced under various circumstances in school. Majority of the PE teachers in Malaysian secondary schools were non-PE majors as reported by the Secondary School Inspection Report [SSIR] (2007)(67.6 percent), Wee (2005)(84.9 percent) and Sebastian (2006)(79.1 percent). Other observations reported that PE teachers lack pedagogical knowledge (Sarkawi & Jani, 2006), 62 percent female PE teachers lack knowledge and sport skills (MOE, 1982). SSIR (2007) reported that of the 67.6 percent non-PE major teachers, only

48.5 percent could teach according to teaching progression, 42.6 percent could detect and correct students' weaknesses, and 54.4 percent could provide feedback to students. The inadequacy of non-PE major teachers teaching PE in schools has aroused the interest in studying their perceptions on the implementation of PE in schools.

Thus this study examines the perception of non-PE-major teachers on the implementation of the Malaysian secondary school PE program in terms of teaching ability, class distribution, non-human factors, and PE program administration. In addition the aim of the study is to determine whether differences in the perception towards the implementation of PE program among non-PE major teachers exist according to gender, age, teaching experience and experience in teaching PE.

Research methodology

Sampling

This study was carried out in selected secondary schools in Peninsular Malaysia. The schools selected were all government aided secondary schools and they offer the same secondary curriculum which is prepared by the Curriculum Development Centre, Ministry of Education, Malaysia.

The target population for this study was non-PE major teachers from randomly selected schools. A total of 290 schools were selected from a list of schools provided by the Educational Planning and Policy Research Division, Ministry of Education, Malaysia. This sample size of 290 schools is 23.3 percent of the total number of secondary schools in Peninsular Malaysia. This sample size is considered adequate at the 95 percent confidence level with results within 5 percent of the true percentage in the population (Mitchell & Jolley, 2004; Baumgartner, 2006). The non-PE major teachers were selected using the cluster sampling. A total of 1388 of the 1637 PE teachers were selected which made up 84.8 percent of the response rate.

Instrumentation

In order to gather data, a special questionnaire on The Implementation of PE Programme [IOPEP] was developed by the researcher. After discussions with the panel of eight experts, a total of 25 items were identified for the study. These items were classified into four dimensions as shown in Figure 1.

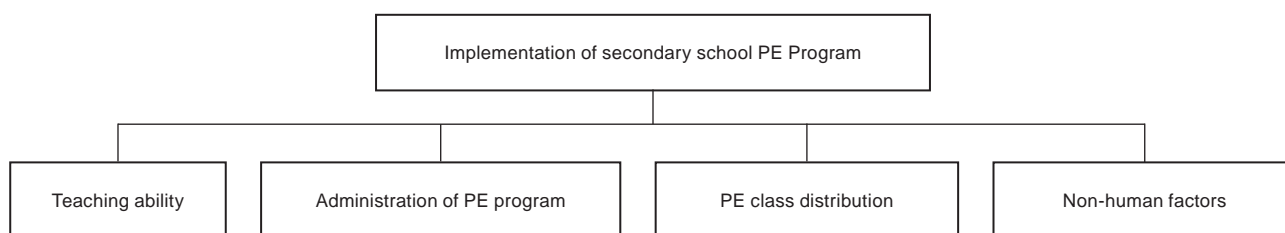

Figure 1: The four dimensions of the Implementation of PE Program

The dimensions were Teaching Ability (7 items, Table 1), Administration of PE Program (7 items, Table 4), PE Class Distribution (5 items, Table 2) and Non-human Factors (6 items, Table 3). The internal consistency for the IOPEP was calculated using the alpha coefficient: Teaching Ability (Alpha = .762), Administration of PE Program (Alpha = .726), PE Class Distribution (Alpha = .702) and Non-human Factor (Alpha = .848). The alpha coefficient for the whole instrument was 0.838 (25 items).

Data collection

The collection of data was through mailing of questionnaires to randomly selected schools. After the identification of the schools through stratified random sampling, questionnaires were mailed to the 290 schools. A total of 267 schools responded and questionnaires were returned within the stipulated deadline. The school administrators then administered the questionnaires to all PE teachers in their respective schools.

Two sets of data were collected from the study: demographic data (gender, age, academic qualification, teaching experience, experience in teaching PE) and data from the IOPEP. For the questionnaire on the IOPEP, a Likert scale from Strongly Agree to Strongly Disagree was used. In addition, items on the administration of the PE program were weighed on a priori weighting method from Almost Always (5) to Almost Never (1).

Data analysis

Two types of statistical techniques were used to analyse the data, namely, descriptive and inferential statistics. Descriptive statistics such as means, standard deviations, percentages were used to report the demographic variables and the data from IOPEP. The two statistical techniques were used for the analysis of the demographic variables of the sample and the four dimensions of the IOPEP (Teaching ability, Administration of PE program, PE class distribution and Non-human factors).

Inferential statistics such as t-test, and analysis of variance (ANOVA) were used. T-tests were computed to determine whether differences existed in the perception mean scores for each sub-domain according to gender. Several one-way ANOVA were used to determine whether differences existed in the perception mean scores for each IOPEP sub-domain according to age, teaching experience and experience in teaching PE. All t-test and ANOVA in this study were carried out using SPSS for Windows (version 18). All tests of significance were at the .05 level. For the one-way ANOVA, where F-tests were significant, a post-hoc test using the Tukey-HSD test was employed.

Research procedures

After getting the approvals from the Research and Planning Unit of the Ministry of Education Malaysia and the State Education Department, the research questionnaires were mailed to the 290 secondary schools in Peninsular Malaysia. The schools were identified through stratified random process. Stamped self-addressed envelopes were provided to ensure a better return rate.

The Heads of Physical Education Department of each school were requested to administer the questionnaires to all non-PE major teachers. Each respondent was given one questionnaire each, which consisted of two sections, namely the demographic section and the IOPEP section. The teachers were asked to complete the questionnaire in the order of demographic section, followed by the IOPEP section.

After the completion of the survey, the Heads of Physical Education Department of the schools posted the questionnaires to the researcher. Reminder letters were sent to ensure a better return rate.

Results and discussion

Sample demographics

A total of 1388 out-field PE teachers were surveyed (654 males, 47.1percent; 734 females, 52.9 percent). Seventy nine percent (n=1094) of PE teachers were below 40 years old and 21.2 percent (n=334) was 40 years old and above. Thirty five percent (n=483) of the participants were Language majors, 2.5 percent (n=33) were Art/Music Majors, 20.5 percent (n=284) were Mathematics/Science majors, 3.7 percent (n=52) were Religious Studies majors, and 38.6 percent (n=536) were other majors. In terms of teaching experience, 28.4 percent (n=394) had below 5 years of experience, 31.8 percent (n=441) had 5-9 years, 15.3 percent (n=213) 10-14 year experience, 13.6 percent (n=189) 15-19 year experience, and 10.9 percent (n=151) 20 year and above experience. As for experience in teaching PE, 23.6 percent (n=328) had no experience teaching PE, 53.1 percent (n=737) had below 5 year experience, 14.3 percent (n=199) had 5 to 9 year experience, 4.3 percent (n=99) had 10 to 14 year experience, 2.7 percent (n=38) had 15 to 19 year experience, and 1.9 percent (n=27) had 20 year and above experience.

Perception of PE teachers on their ability to teach PE

Table 1: Extent of agreement on statements of ability to teach PE

Statements	Extent of Agreement (%)					Mean	SD
	SA	A	U	D	SD		
I have knowledge to teach PE	5.3	41.4	18.7	24.5	10.2	3.07	1.129
I can manage students in my class	13.6	66.5	12.5	5.5	1.9	3.84	0.794
I can teach games skills	7.5	38.4	24.7	21.3	8.1	3.16	1.094
I can detect my student' weaknesses	6.5	44.7	29.4	14.8	4.7	3.34	0.964
I can correct my students' weaknesses	5.5	43.8	30.4	15.3	5.0	3.29	0.961
I need to attend PE course before handling PE subject	3.6	9.3	9.3	41.2	36.6	2.02	1.075
I needed exposure on PE through Staff Training Program	2.3	7.6	9.4	45.5	35.1	1.97	0.979

Notes: SA = Strongly Agree; A = Agree; U = Undecided; D = Disagree; SD = Strongly Disagree

The data in Table 1 indicated that 80.1 percent of the respondents 'agreed' and 'strongly agreed' that they can manage their students but only 46.7 percent of the respondents agreed that they 'had knowledge to teach PE', 45.9 percent 'can teach games skills', and 51.2 percent 'can detect' as well as 49.3 percent 'can correct students' weaknesses'. Despite their lack of teaching ability, only 12.9 percent and 9.9 percent of the respondents 'strongly agreed' and 'agreed' that they need to attend PE courses and need exposure through Staff Training Program before handling the subject respectively. The 1994/1995 Federal Inspectorate of Schools Report found in the observation of 153 teachers performances that 65.4 percent of them were rated 'average' and 'weak'. In another study, Romina (2002) revealed that 70 percent of PE teachers from 34 schools lacked knowledge about PE curriculum content and 55 percent of them could not effectively perform their teaching duties.

The lack of interest in attending courses by PE teachers was reported by Wee (2006) where 89 percent of them has never attended any PE courses since becoming a qualified teacher. In fact McNeill et al. (2009) suggested that the poor response on attending courses in PE may be due to the perceived importance of PE in the curriculum and other teaching demand was considered more important than PE.

When competencies of PE teachers were examined according to gender, results revealed significant differences in perceptions on teaching ability ($t=9.616$, $p < 0.05$). Male PE teachers mean scores (mean = 25.91, SD = 4.21) were higher than that of the female teachers (mean = 23.66, SD = 4.43). This is supported by MOEM's report (1982) that 62 percent of female PE teachers lack knowledge and in skills in sport. Similarly Wee and Raj (2010) in a study of 111 (60 males and 51 females) PE teachers from the urban area secondary schools of Shah Alam area reported that male teachers performed better (having higher mean scores) than females teachers. However there were no significant differences in competencies in terms of age groups.

Significant differences were also found when PE teachers' overall teaching experience ($F(4, 1383) = 3.386$, $p < 0.005$) and experience in teaching PE ($F(5, 1382) = 27.241$, $p < 0.05$) were compared. In both cases the more experience teachers had higher mean scores. The higher mean scores for older teachers might be due to the learning process achieved over the years.

Physical Education teachers' perception of the distribution of PE classes in PE program

Table 2: Extent of occurrence in the class distribution practice of PE classes

Class Distribution Practice	Extent of Occurrence (%)					Mean	SD
	N	RLY	OLY	FLY	AL		
Class given based on discussion with administrators	29.6	16.6	25.4	18.2	10.2	2.63	1.343
Class given based on interest	37.4	18.6	23.0	14.5	6.6	2.34	1.287
Class given based on PE qualification	50.8	16.8	17.9	11.0	3.5	2.00	1.202
Class given without teacher's knowledge	13.3	16.8	23.6	18.0	28.3	3.31	1.383
Class given to make-up the number of teaching periods	33.9	27.7	19.7	8.9	9.7	2.33	1.287

Notes: N = Never; RLY = Rarely; OLY = Occasionally; FLY = Frequently; AL = Always

Table 2 shows that PE classes were given to teachers without considering their qualification (85.5 percent responded 'never', 'rarely' and 'occasionally') and their interest towards PE (79.0 percent responded 'never', 'rarely' and 'occasionally'). In fact, only 18.6 percent (responses as 'frequently' and 'always') of the respondents agreed that PE classes were given to teachers in order to fulfil the number of teaching periods required. The results are in contrast with the belief that administrators consider PE less important than the other subjects.

The data in Table 2 also reveals that administrators did not practice consensus in allocating PE classes (71.6 percent responded as 'never', 'rarely' and 'occasionally'). However, only about 53.7 percent (responses as 'never', 'rarely' and 'occasionally') of the teachers admitted that they were not consulted before being assigned PE classes by administrators. This is contrary to the situation which was revealed in a local study (Normar, 1998) where 95.5 percent of PE teachers were appointed by the principals and only 4.5% of the teachers really applied to teach the subject. The assignment of non-PE-major teachers has undoubtedly confirmed the marginalization of PE in schools (Liang, Walls & Lu, 2005; Wright, McNeill & Schempp, 2005).

Inferential statistics on gender revealed significant differences in the perceptions on class distribution ($t=5.217$, $p < 0.05$). Male PE teachers mean scores (mean = 13.77, SD = 3.15) were higher than that of the female teachers (mean = 12.93, SD = 2.83). Significant differences were found on the perception of class distribution based on teaching experience ($F(4, 1383) = 3.677$, $p < 0.05$) as well experience in teaching PE ($F(5, 1382) = 9.228$, $p < 0.05$). In both cases the more experience teachers had higher mean scores.

Perception of PE teachers on non-human factors in PE program

Table 3: Extent of agreement on statements of non-human factors as perceived by PE teachers (N = 1388)

Statements	Extent of Agreement in percentage					Mean	SD
	SA	A	U	D	SD		
The facilities for PE class are adequate	5.3	37.9	16.9	33.4	6.5	3.02	1.088
Financial allocation for PE is adequate	5.1	31.2	41.0	18.2	4.5	3.14	0.926
Equipment for PE class is adequate	5.0	34.4	17.9	36.5	6.1	2.96	1.075
PE reference books in the school library are adequate	3.9	31.1	34.5	26.4	4.1	3.04	0.945
PE reference books are suitable	3.2	37.2	40.3	17.4	1.9	3.23	0.836
The PE reference books in national language in the library are adequate	3.2	28.7	41.1	23.6	3.4	3.05	0.885

Notes: SA = Strongly Agree; A = Agree; U = Undecided; D = Disagree; SD = Strongly Disagree

Table 3 indicates that facilities and equipment for PE were inadequate (43.2 percent of respondents ‘agree’ and ‘strongly agree’). This is supported by inadequate financial allocation, only 36.3 percent ‘agreed’ and ‘strongly agreed’ on the statement “financial allocation for PE is adequate”. However, Federal Inspectorate of Schools differed on the issue of inadequacy of facilities. In their 1994/1995 report, they reported that the inadequacy of facilities may be due to lack of planning for use of facilities and equipment. Often, different classes converge together and use the same facilities and equipment, thus creating an artificial shortage. The report also revealed that there was no timetable for facilities usage. The results in Table 3 also indicate that only 35.0 percent of the respondents agreed that PE books in the school library are suitable while 44.6 percent disagreed.

If the responses of ‘strongly agree’ and ‘agree’ were scrutinized, the percentage ranges from 31.9 percent to 43.2 percent. This is supported by research findings from Singapore schools where 42 percent of PE teachers felt that PE facilities in their schools were adequate or more than adequate (McNeill et al., 2009).

Inferential statistics on gender and age groups showed no significant differences in the perceptions on non-human factors. However, significant differences were found on the perception of non-human factors based on overall teaching experience ($F(4, 1383) = 3.219, p < 0.05$) as well as experience in teaching PE ($F(5, 1382) = 2.688, p < 0.05$). Statistical analysis on teaching experience revealed significant differences between 5-9 years group (mean = 18.05) and 10-14 years group (mean = 19.08). Although significant differences were found in terms of experience in teaching PE, no post-hoc results were computed.

PE teachers’ perceptions of the administration of PE program in school

Table 4 reveals teachers’ perceptions on the administration of PE programme in secondary schools. It was found that only 32.0 percent of the administrators ‘frequently’ and ‘always’ assumed that PE is important. This is supported by the fact that only 30.1 percent of the administrators ‘frequently’ and ‘always’ had discussions with teachers before assigning them to teach PE. Similarly, it was noted that administrators ‘never’, ‘rarely’ and ‘occasionally’ discuss with teachers on factors affecting the teaching and learning of PE (84.1), organise staff development programmes (91.5 percent), observe teaching of PE (78.8 percent) and as well as ‘frequently’ and ‘always’ allow PE classes to be used for other academic subjects (47.1 percent). Further more, only 42.2 percent of administrators ‘frequently’ and ‘always’ provide adequate facilities for the teaching of PE.

The high incidence regarding the lack of observation and supervision of PE lessons by Principals was reported by Malaysian researchers (Tan & Lee, 2004; MOEM, 2007; Wee, 2007, Wee, 2008). Tan and Lee (2004) reported no observations took place, while Wee (2007) reported that only about half of principals ‘frequently’ and ‘always’ conducted observations. In fact, there was no observation plan by the PE Curriculum Committee (Wee, 2008). The MOEM (2007) revealed from a study of 46 secondary schools that only 18.5 percent (8 schools) carried out the mandatory supervision at the school level.

On the issue of the importance of PE, only 42 percent of the administrators ‘frequently’ and ‘always’ assumed PE to be important. In terms of allowing PE classes to be used by other subjects (eg mathematics and science), 47.1 percent of the administrators ‘frequently’ and ‘always’ allow that to happen. This is supported by Chong and Norlena (2010) and Wee (2009).

This study reported over 90 percent of administrators did not organize Staff Training Program even though the Ministry of Education Malaysia made it compulsory for the schools to plan, administer and evaluate school STP (MOEM, 1998). However, Sebastian (2006) reported that almost 31 percent of the schools never organized STP and almost 63 percent organized STP 1-3 times annually. MOEM (2007) reported 29.4 percent secondary school organized STP.

Table 4: Extent of occurrence in the administration of PE program as perceived by teachers (N = 1388)

Statement	Extent of Occurrence in Percentage					Mean	SD
	N	RLY	OLY	FLY	AL		
Administrators have discussion before deciding PE teachers	26.9	19.1	23.9	18.1	12.0	2.69	1.354
Administrators assume that PE is important	10.5	18.5	29.0	24.6	17.4	3.20	1.228
Administrators allow PE class to be used for other subjects	6.1	12.0	34.7	19.7	27.4	3.50	1.186
Administrators observe teaching	15.5	23.6	39.7	16.1	5.0	2.72	1.067
Administrators provide adequate facilities for PE	4.9	19.8	33.1	31.0	11.2	3.24	1.047
Administrators organise Staff Development Training Course for PE	42.1	25.6	23.8	6.8	1.6	2.00	1.036
Administrators discuss with teachers concerning factors affecting the teaching and learning of PE	25.9	26.6	31.6	12.4	3.6	2.41	1.107

Notes : N = Never; RLY = Rarely; OLY = Occasionally; FLY = Frequently; AL = Always

Inferential statistics revealed significant differences in perceptions on administration of PE program only in terms of gender ($t=4.551$). Male PE teachers mean scores (mean = 19.35) were higher than that of the female teachers (mean = 18.21). Significant differences were found on the perception of the administration of PE program based on teaching experience ($F(4, 1383) = 5.366, p < 0.05$) as well experience in teaching PE ($F(5, 1382) = 3.870, p < 0.05$). Generally for both, longer year of service had higher perception mean scores.

Conclusion

Majority of the non-PE major teachers were below 40 years old. Thirty five percent of them were Language majors. Almost 60 percent of the teachers had less than ten years of teaching experience and a quarter of them had no PE teaching experience. Apart from being able to manage students in PE classes, only half of the teachers agreed that they had knowledge to teach PE, can teach game skill, can detect and can correct students' weaknesses. However, only a third of them agreed that they needed training in the teaching of PE. Male teachers perceived that they were more capable in term of teaching as compared to the female counterparts. The results also showed that teaching ability increase with more experience and PE teaching experience.

As for the distribution of PE classes, almost half of the teachers surveyed agreed that administrators 'frequently' and 'always' assigned PE classes without their knowledge. And only a fifth of the teachers agreed they were 'frequently' and 'always' assigned to teach based on their interest. On human factors of the PE program, majority of the teachers 'agreed' and 'strongly agreed' that facilities and equipment, financial allocation and reference books were inadequate. On the issue of the administration of PE program, data analysis showed that only about a third of the teacher perceived that administrators assumed PE important and had discussion with teachers. And majority of the teachers agreed that administrators did not organize courses for them, let alone observing their teaching.

In short, the issues of non-PE majors teaching PE must be handled with appropriate shortterm measures; in house training must be organized regularly before more qualified PE teachers are assigned to teach PE in schools.

References

- Baumgartner, T.A. & Hensley, L.D., 2006. *Conducting and reading research in health and human performance*. NY: McGraw-Hill.
- Chong, A. L. & Norlena, S., 2010. The implementation of physical education in secondary school: A preliminary study. *Proceedings of the International Seminar Comparative Studies In Educational System Between Indonesia & Malaysia, 15-16 June*. University of Education Indonesia, Bandung, pp.955-971.
- DeVries, L.A., 1975. *A procedure for developing purpose for a national curriculum in physical education for Malaysian schools*. Ed.D. thesis, Columbia University Teachers College.
- Frederick, F., 1998. Making physical changes at school. *Sunday Times*, 8 Feb. pp. 6-8.
- Liang, G., Walls, R. T., & Lu, C., 2005. Standards and practice for physical education in China. *J Physical Education, Recreation and Dance*, 76(6), 15-19.
- Littlefield, R., Green, B., Forsyth, S. & Sharp, B, 2003. Physical education in Scottish schools: A national case study. *European Jrl. of PE*, 8, 211-227.
- Mitchell, M. & Jolley, J., 2004. *Research Design Explained* (4th ed.). Orlando, Florida: Holt, Rinchart & Winston, Inc.
- McNeill, M., Lim, B.S.C., Wang, C.K.J., Tan, W.K.C., & MacPhail, A., 2009. Moving towards quality physical education: Physical education provision in Singapore. *European physical education review*, 15, 201-223.

9. Ministry of Education, Malaysia, 1982. *Reports on the teaching of physical education in schools in Klang District, Selangor* (In National Language of Malaysia). Kuala Lumpur: Federal Inspectors of Schools.
10. Ministry of Education Malaysia [MOEM], 1994/95. *Report on the Teaching of Physical Education in Secondary School*. (In National Language of Malaysia). Kuala Lumpur: Federal Inspectorate of Schools [FIS].
11. Ministry of Education Malaysia, 2007. *Secondary School Inspectorate Report*. (In National Language of Malaysia). Kuala Lumpur: FIS.
12. Ministry of Education. (2008). *Secondary School Inspectorate Report* (In National Language of Malaysia). Kuala Lumpur: Federal Inspectorate of Schools, Ministry of Education.
13. Ministry of Education Malaysia, 1998. *Letter of professional service.No.2/1998* (In National Language of Malaysia). Kuala Lumpur: Author.
14. Noreha, S. & Juslimah, J., 2009. *Pedagogical content knowledge of Form Four physical education teachers in four districts in Ulu Kinta, Perak*. Paper presented at the physical education conference 2009 Malaysia, Faculty of Educational Studies, University Putra Malaysia. 13-15 February 2009.
15. Normar, A., 1998. *Identifying the effectiveness of teaching and learning of physical and health education in secondary schools in Marang District, State of Terengganu*. Unpublished Research, Batu Rakit, Kuala Terengganu, Kuala Terengganu Teacher Training College.
16. Romina, L.D., 2002. *Level of implementation of physical education subject in secondary schools in Miri town area, Sarawak* [In national language of Malaysia]. Undergraduate Dissertation, National University of Malaysia.
17. Sebastian, B.A.S., 2006. *Comparative study of the implementation of Physical Education Programme in Bintulu and Shah Alam secondary schools*. Undergraduate Project, Uiniversiti of Teknologi MARA, Shah Alam, Selangor.
18. Tan, S. E., & Lee, F. K., 2004. Reviving physical education in schools: A small dosage of management and commitment from the educational leaders. *The Jrl. of Administrative Science*, 14(1), 45-52.
19. Umi Kalsum, M.S. & Gusti Ngurah, D., 2013. Differences between In-Field and Out-of-Field History Teachers Influence on Students Learning Experience in Malaysian Secondary Schools. *Creative Education*, 4 (9), 5-9
20. Wee, E.H., 2005. Management of physical education programme: An exploratory study of physical education in Malaysian secondary schools. *Jrl. of management and educational leadership*, 15(2), 9-32.
21. Wee, E.H., 2006. *Staffing issues in Malaysian Secondary schools' physical education programme*. Proceedings of The 3rd National HRM Conference, 26-28 Nov. Faculty of Human & Social Development, University Utara Malaysia, pp. 265-273.
22. Wee, E. H., 2008. Physical Education in Malaysia: A case study of fitness activity in secondary school PE classes. In UNESCO, *Innovative Practices in Physical Education and Sports in Asia*. Bangkok: UNESCO Asia and Pacific Regional Bureau for Education, pp. 21-44.
23. Wee, E.H., 2009. Management and leadership issues in the implementation of an academic program: A case study of Physical Education Program. *The J Administrative Science*, 6(2), 27-45.
24. Wee, E.H., 2013. Contemporary issues in the teaching of PE in Malaysia. *Jrl. of physical activity, sport and exercise*, 1(1), 17-20.
25. Wee, E.H. & Raj, S., 2010. Comparing the perceptions on teaching abilities of US and Malaysian physical education teachers: A preliminary study. *Pan-Asian Journal of Sports & Physical Education*, 2 (1), 25-39.
26. Wright, S.C., McNeill & Schempp, P.G., 2005. Standards and practice for K-12 physical education in Singapore. *JOPERD*, 76(7), 23-27.
27. Wuest, D.A. & Fisette, J.L., 2012. *Foundations of physical education, exercise science and sport*. NY: McGraw-Hill.

TRI-AXIAL ACCELEROMETER USAGE IN PEDAGOGICAL PROCESS IN CZECH ELEMENTARY SCHOOL

Tomáš Vespaľec and Jindřich Pavlík

FSpS MU Brno, Czech Republic

Abstract

Hypoactivity and sedentary lifestyle are pandemic problems across all population groups and regions. The objective is to describe current trend of physical activity (PA) and to integrate motivational factors to everyday life.

The aim of the study is to find, discover or establish algorithm how to evaluate PA characteristics and give pupils, their parents, and their teachers a fast feedback about daily PA by using modern digital technologies.

We designed a method that can provide well-timed information about the activity of a child, which is useful especially for their parents to help them prevent children from negative impacts of PA insufficiency. The method also provides data that can help the pedagogical process to be more active and to change stereotypes in schoolchild behaviour. The research is focused on pupils at the age of 7 – 9 years and the method will be used in a post-doctoral project to collect data from elementary schools in the Czech Republic.

Key words: physical activity, accelerometer, pedagogical process, bone health

Introduction

PA of all age and social groups is currently being discussed in the whole society. Mainly its relation to the trends of obesity and hypokinesia in the whole population are alarming not only in North America where this trend occurred first but also in the regions familiar to Czech population. Based on the current research, this issue has also emerged in the regions which did not suffer from this problem before. Authors point out this new phenomenon mainly in context with dynamic development of economics in Asian countries.

In many studies, intentional PA is suggested as a key preventing factor in civilization effects of the decrease in PA. There is a frequent demand to restore original natural spectrum of physical activities with respect to a decrease in both work and leisure organism loading as well as a shift to sedentary way of working and use of means of transport.

It is of course important to target preventive and educational projects on the whole population without making age differences. However, from pedagogical point of view, the most important group seems to be younger school age, i.e. the age range from 6 to 11. This ontogenetic period still manifests bigger natural need of PA which is a logical consequence of games connected to PA in the pre-school period. At the same time, individuals in this age range are faced with the start of compulsory school education, which brings about the need to conform to a new pace and schedule of the day. Even though there are modern trends in the pedagogical process to provide more varied range of activities, entering school education means a radical change in PA for children mainly with respect to spending day in a sedentary way. Moreover, it is assumed that habits built in this developmental period leave long-term tracks in memory and affect the need for PA of an individual in succeeding developmental periods.

More opportunities of PA for children in this age period are usually offered in physical education lessons at school and the activities that take place outside school. However, the role of the teacher is quite limited and the parents should take the main motivational role. A frequent problem is parents' insufficient knowledge of needs of their children with respect not only to evaluation and results at school but mainly with respect to the complex physiological development of a young organism.

All the above-mentioned factors initiated the idea to offer a more complex tool and form of feedback for both teachers and parents.

From the point of view of a teacher and pedagogical process, the most important thing is to evaluate the time spent doing PA, its intensity during the time spent both at school and in individual lessons, and effectiveness of teaching physical education etc.

Similarly, it is good to give parents a tool which could easily provide information about the amount of PA done by children during the day. At the same time, it could show them the difference between the results of their child and the recommendations on adequate PA during the day in longer time periods.

Further, it seems beneficial to make PA monitoring available and more detailed, namely monitoring measured data which could enable to assess the influence on other physiological indicators and risk factors, with a suitable database tool.

A less discussed topic is the influence of PA on the structure of bone tissue. Some studies (for all Hindt & Burrows, 2007 or Mackelvie et al., 2002) have shown that sufficient intensity of PA affects the structure of bones to a considerable extent, mainly the structure of child bones.

After a longer examination, a possible optimal method seems to be using a tri-axial accelerometer functioning in the form of an autonomous device with a possibility to store data in a built-in memory via wireless transfer into the storage database for analysis.

Material and methods

In the first stage, it was necessary to select a suitable device and diagnostic methods as well as the way of transferring, storing and assessing data.

The device had to meet the following requirements:

- as big autonomy as possible without the necessity of user interaction (minimizing possible effect on the results through interaction of the tested person with the device)
- as long battery life as possible without the necessity of regular recharging (minimizing loss of data caused by forgetting to recharge the battery)
- ability to store data with sufficient frequency for a long time
- possibility for the tested person to wear the device comfortably on the body (low weight, ergonomic shape)
- adequate price (to make it possible to examine a large number of people at the same time)
- easy data transfer without the interaction of the user (wireless data readers or mobile phone connection)
- mechanical resistance and, if possible, water resistance

During planning, we declined all devices functioning on the principle of monitoring heart rate because they usually require using breast monitoring belt which can result in subjectively-perceived worsened breathing with some people. Further, it is necessary to download data regularly through connecting it to PC.

Another possibility is devices functioning on the principle of GPS. However, in this case, monitoring in roofed buildings is complicated. The devices are also too energy consuming.

Yet another possible category is pedometers. The devices are usually quite simple and user-friendly. However, for the purpose of our work, they do not provide sufficient sensitivity and precise data.

An ideal option seems to be devices functioning on the principle of tri-axle accelerometer. Still, there are again more possibilities. The easiest would be using 3D sensor from a mobile phone which is nowadays owned by all school children. However, the result of a previous research showed (Fedrová, 2013) a disadvantage in different location for placing the device on the tested person and different sensitivity of used chips. Another complication is that when using such device at school, it is not possible to carry the phone during some activities, e.g. in physical education lessons. Therefore, we chose the option which seemed the most practical – using autonomous accelerometer in the form of a small device with its own battery and incorporated memory. Apart from the benefit of relatively long battery life, the device can also be easily placed on the body of the tested person which does not limit the person during common PA. In accordance with the previous studies, the location for the device was chosen to be the left or right hip at the back of the person (for all Rowlands & Stiles, 2012).

Moreover, such accelerometers can be bought also in commercial make, e.g. Actigraph, Tritrac, or Actiwatch. Further, similar devices are also produced as personal training and monitoring units. The disadvantage, however, is high price starting at approx. \$ 100.

Still, last year we succeeded in initiating cooperation with UIIL Champaign, Department of Kinesiology and Human Health. The result is the development of a device which meets all the required criteria and the price would be less than \$ 50. At present time, we already have pre-production samples which are being tested and software is being adjusted.

The method of fastening the device is shown in the following figure.

The device, which is carried by the individual on the hip on an elastic stripe, is supplied with a high-capacity battery that ensures the functionality for a minimum of one month. After the start of measuring, the device stores accelerometric data with the frequency of 100Hz in the incorporated memory. During the detection of telemetric scanner, a wireless module activates and during a short time it transfers the stored data from the device to the central storage on the server. At the same time it deletes the memory of the device. Data can be transferred also via Bluetooth into a mobile phone and then from the mobile phone to the server.

Then the data can be accessed online from a webpage and they are accessible to the research team, teachers and parents, following the settings (figure 1).

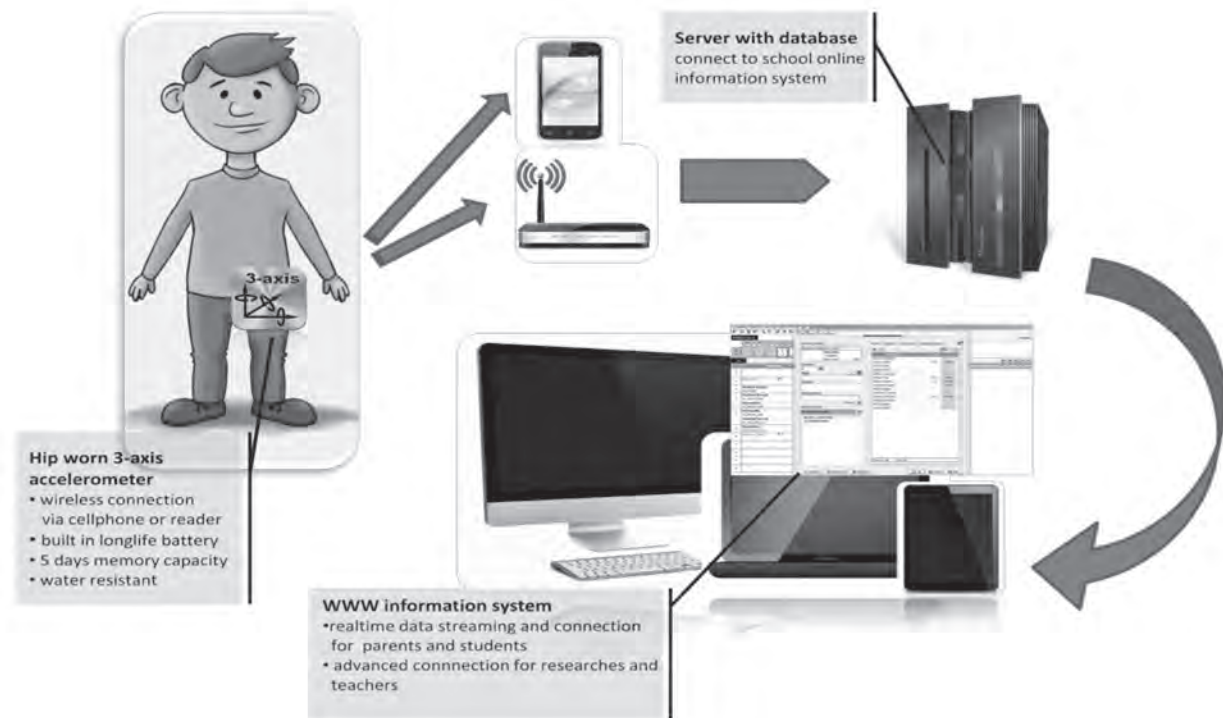

Figure 1: Algorithm of data recording, transfer and evaluation

Method of measuring and data processing

The measuring itself as well as the information output can be divided into three categories.

PA monitoring

PA monitoring provides data about the PA amount and intensity of a tested person during the whole day. It records physical activity through the so-called epochs, each lasting for 5 seconds, whereas PA is divided into categories: low, moderate and vigorous. This type of recording makes it possible to evaluate whether the tested person has reached the desired level of PA during one day. It also allows displaying the entire PA for a longer period, it alerts on insufficient PA etc. The method of dividing PA into categories shall be set similarly to the ActiGraph device so that the results could be compared with other studies.

The limiting criteria are assumed to be the recommendations of WHO, EU Sport Ministers and ACSM to perform at least 30 minutes of moderate PA every day. This shall be then verified in a pilot study.

Another method of data monitoring shall make it possible to evaluate the effectiveness of pedagogical process, whereas it will be possible to tell with a considerable level of precision the amount of effectively used time during one lesson. The distribution of PA during one lesson can be evaluated quite precisely, which gives the teacher precise feedback about the real use of time of the lesson.

Another possibility is to create a motion profile of each individual with respect to the parts of the day, days of the week and other time periods. This method will help to assess the amount and duration of static positions which the tested person takes during the day and on the basis of this information to set precautionary measures.

The influence of PA on the quality and structure of bone tissue

This type of monitoring uses RAW data from the device which makes it possible to reveal and diagnose practically any deviations in acceleration and bursts. Within the diagnostic output we are solving incorporating this factor on the basis of the work of Ahola (2010) whom, together with the research team, specified the formula for calculating the score of the influence on bone tissue. However, we realized that this tool is objective only with regard to the vertical part of motion and does not take into consideration the horizontal application of force on the organism. This area shall be further subject to a possible adjustment in cooperation with our partner in order to create a diagnostic tool which would enable

objective and complex application on the organism and elude a suitable index. This would serve as a quantitative value assessing the sufficiency of PA during the day as the influence on the quality of bone tissue.

Further outputs from the device and their use

The output of “RAW data” can be further used in the area of safety and injury prevention. The database allows filtering data which exceed the set factor. The factor can be the size of acceleration, frequency of acceleration, its duration etc. In this way, the risky parts of the PA of the tested person can be diagnosed and help reveal risk activities or areas and time. This can be considered a relatively objective tool for preventing school and outside-school injuries, thus making greater the possibility of feedback of the pedagogical unit. It is easy to reveal possible risk activities during a lesson and also alert on individual specific dangers of each tested person, for example by doing the given activity in a wrong way.

Conclusion

The testing carried out by the authors as well as the previous studies suggested that the tri-axle accelerometer could be an optimal device for monitoring quality and quantity in school and outside-school practice. As long as it is possible to solve the problem of high price of the device so that it could be used on a large scale with a larger number of school children, this method can bring about large amount of precise data describing the quantity and quality of PA, not only with school children. With respect to some alarming data about children obesity and hypokinesia, it is necessary to discover and know the real composition of motional habits of this population group.

Of no less importance is the possibility of feedback on the quality of pedagogical process; easily accessible qualitative and quantitative data about the PA of school children make it possible for the teacher to adjust the lesson with respect to effectiveness.

There is a growing importance of the necessity of training and checking sufficiency of substitute PA of individuals in such a way that insufficient PA caused by the sedentary way of life could be compensated. PA insufficiency can be manifested on a long-time scale in regressive physiological changes of organism. In this area, there is also space for education and motivation of the youngest population group to ensure at least minimal recommended PA. Accelerometry together with qualitative and simple interpretation software can be a suitable tool for this.

Naturally, the set of data collected in this study has a potential for further use; whether in the area of injury prevention and safety at schools or the data can be further analysed using modern technology of “big data” and “data mining”.

All these activities have been incorporated into one of the postdoctoral program of one of the authors and shall be practically employed in the summer and autumn periods of 2014 within a pilot measuring at an elementary school in Brno.

References

1. Ahola, R. (2010). Measurement of bone exercise (osteogenic features of loading). *Acta Universitatis Oulensis*, 1073, 112p.
2. Hind, K., & Burrows, M. (2007). Weight-bearing exercise and bone mineral accrual in children and adolescents: a review of controlled trials. *Bone*, 40(1), 14-27.
3. Fedrová, A. (2013). *Možnost využití zařízení typu smartphone pro monitoring pohybové aktivity*. (Master's thesis, Masarykova Univerzita, Brno, Czech Republic).
4. Mackelvie, K. J., McKay, H. A., Petit, M. A., Moran, O. & Khan, K. M. (2002). Bone mineral response to a 7-month randomized controlled, school-based jumping intervention in 121 prepubertal boys: associations with ethnicity and body mass index. *Journal of Bone and Mineral Research*. 17(5), 834–844.
5. Rowlands, A. V., & Stiles, V. H. (2012). Accelerometer counts and raw acceleration output in relation to mechanical loading. *Journal of Biomechanics*. 45(3), 448–454.

LEARNING OUTCOMES OF SELF-DEFENSE TEACHING IN HIGH SCHOOL PHYSICAL EDUCATION

Michal Vít, Martin Bugala and Jan Šenkýř

Masaryk University, Faculty of Sport Studies, Brno, Czech Republic

Abstract

The article deals with learning outcomes in self-defense teaching. Participants were high school students in the Czech Republic ($n = 26$) with a mean age of 16.4 years. Based on in vivo observations and qualitative data analysis of the survey, instrument learning outcomes of students after a one-day self-defense course were assessed. Although the students are able to describe the legal definition and boundaries of self-defense theoretically and at the same time to assess whether a particular case maintained within these boundaries, it is problematic for them to break free from problem assessment tinged with emotions. The teacher should be aware of these facts and take them into account in the self-defense teaching practices. This fact should be reflected in teaching self-defense. Recommendation for practice is to use model situations using stress conditions. This approach may lead students to deeper understanding of their own reactions to the attack and the distinction between conscious assessment of the situation and their own instinctive reactions.

Key words: education, combatives, reasonable defense, qualitative analysis, Atlas.ti

Introduction

Although many people think of self-defense as a kind of specialized training for a specific group of people, in fact, the issue of self-defense affects us all. However, it depends on what people imagine under this term. Many people feel that self-defense is something remote or unnecessary, because they do not admit the existence of threats that are actually present. As Niccolo Machiavelli already said the basic human weakness is that the person does not predict the storm when the weather is nice.

Self-defense is commonly associated with activities of the reactive nature, i.e. as a way to ward off an attack that has already occurred. Good strategists, however, know that the most effective way of resolving conflicts is a proactive approach. This was reflected in the creation of Framework Education Programmes that provide curriculum for primary and secondary schools in the Czech Republic. Self-defense training is included as one of the topics of physical education in these documents. Primary and secondary school teachers choose different strategies for implementation of self-defense. In our previous work, we studied various concepts of self-defense and learning outcomes in the affective, cognitive and psychomotor domain (Vít, Reguli & Čihounková, 2011). This article is dedicated to the learning outcomes of secondary school students in the cognitive area in self-defense teaching realized in the form of a one-day crash course.

Methods

The research design has been inspired by a grounded theory and employment of text encoding. It is a qualitative analysis of data obtained by interviewing respondents. The data were analysed using the Atlas.ti 6.2.28 software. For the purpose of the study a research tool was compiled which uses thematic story that introduce the respondent into the problem and then asks for their opinion on the solution of the problem. The data are valuable on educational outcomes of respondents in the cognitive area according to Bloom's taxonomy.

The research group

The research was conducted at a selected secondary school in the Czech Republic. The school management decided to implement self-defense teaching through a one-day crash course within the sport week at the school. The research group was a group of secondary school students ($n = 26$) aged 16.4 on average, which was represented by boys ($n = 9$) and girls ($n = 17$). The composition of the research sample is shown in Table 1.

Table 1: Research group

Subjects	Number	Average age
Boys	9	16,4
Girls	17	16,3
Totally	26	16,4

Characteristics of the course

The aim of the one-day crash course in self-defense was to introduce students into the issue, inform on theoretical bases of self-defense, familiarize them with the basic principles and teach them basal skills suitable for the layman defense. Time allocation of the course was four hours. The curriculum of the course included:

1. Warm up with specific combative exercises
2. Basic combat technique (postures, relocation, blocks, strikes, etc.)
3. Combat games (getting rid of the shame of physical contact)
4. Defense (physical mastery of common attacks)
5. Theory of self-defense (strategy, tactics, legal definition of necessary self-defense).

Due to the length of the course it was not possible to expect significant learning outcomes in the psychomotor domain, as the time allocation does not allow fixation of learned motor skills. The teacher therefore focused primarily on the education of students through experience and information about possible threats. The expected learning outcomes were in cognitive areas according to Bloom's taxonomy (knowledge, comprehension, application etc.).

Results and discussion

Course of the course

The beginning of the course was characterized by concentration and atmosphere of expectations. Students were curious about what to expect, and in the initial discussions most of them stated that they did not have any practical or theoretical experience with self-defense. Three subjects reported that they practised martial arts in their free time. During the warm-up and practice of basic combat technique the students were fully concentrated and were watching their movements in the mirror. Basic skills were trained without a partner.

During the following practice of combative games, the students were confronted with different kinds of physical contact (grip, clasp, punch, kick etc.). By in vivo observing, it was found out that some students perceive a close physical contact with another person as problematic. At the beginning of the course negative emotions associated with the loss of intimate distance (shame, fear of the unknown) were present. This mental block in students subsided in the moment they fully and unconditionally started to practise combative games. Positive experience of playful exercises led to immersion in activity and loss of shyness. When exercising the students were showing joy (laughter, whoop, shouting etc.), the atmosphere in the classes changed and other exercise was performed in an atmosphere of friendly combat.

Defense training was led according to a problem-based learning. The teacher explained the self-defense situation involving physical assault and a tactical concept of the defense. The students were asked to experiment with movement so as to find the right way out of the situation. Then the teacher showed the optimal solution and led the students to technically correct implementation of defense. The atmosphere of defense training was concentrated, the students tried to find out biomechanical principles of defenses. In this phase of teaching they involved their imagination, they were thinking over a wide range of possible attacks and defenses, asking many questions about how to deal with such situations. The teacher led the students to a rational assessment of the situation and the act of the defense within their technical, physical and mental capabilities.

One question of adequacy of defense as one of the issues was already raised during the defense training. The students realized that every technically correct defense may not be adequate and in accordance with the law. However, their knowledge did not allow assessment of where the boundaries of adequacy are. While searching the answer to this question the training smoothly changed to the interpretation of the legal framework of self-defense. The students became familiar with the concept of necessary self-defense pursuant to the Criminal Code of the Czech Republic and specific examples were provided. Next a diverse discussion followed during which the students gave their own examples of self-defense which they had read or heard about and asked about possible solutions. The practical part of the course was concluded with a series of amusing combative games. The technical part of the course resulted in a debate over the issue of adequacy of defense and interpretation of the theory of self-defense.

Learning outcomes

Psychomotor domain

The practical part of the course yielded the following learning outcomes in the psychomotor domain. The students imitated the movements of the teacher and struggled for correct technical implementation (imitation phase). Within the problem learning the students followed instructions and sought their own solutions to situations (manipulation phase). After correcting the errors by the teacher, the students were able to refine their activity and eliminate shortcomings in the implementation of defense (precision phase). Time allocation of the course did not allow further progress to the stage of articulation and naturalization.

Cognitive domain

After completion of the motion part of the course, the students were provided with a research tool in which they commented on the issue of self-defense and their views on three self-defense situations. The first question asked about was very broad: “Tell me something about the concept of the necessary defense.” This question investigated what kind of information the students need to memorize about defense.

Responses showed that all students understood the definition of the necessary defense. They were given different interpretations of the legal status of the necessary defense, including specific examples. It turned out that on the basis of the interpretation and demonstration of specific defenses the secondary school students were able to understand the circumstances in which they may perform an act which would otherwise be considered criminal. Most students also mentioned the issue of adequacy and some of them were able to explain it in their own words, for example: “Necessary defense is a defense that is needed to overcome the attack so that the consequences of injury were approximately equal to the attack.” At the same time the students realize that for successful defense the balance of forces must be asymmetric and in favour of the defender. Adequacy is correctly understood in the way that the ratio of the consequences of the defense to the effects of the impending attack is relative: “Necessary defense can be more offensive than the force of the attacking aggressor.” The students also gained important knowledge that the defense may be initiated at the time when an attack is imminent, i.e. it has not come yet: “The defense which we use to protect our health and life. It already begins with approaching or hint of a possible attack of the aggressor and ends with the end of the attack.” Learning outcomes in the cognitive area at the first two levels of Bloom’s taxonomy (knowledge and comprehension) were very good. For the objectivity of the research it is to be noted that the subjects were provided with the research instrument immediately after completion of the course. Therefore we investigated the ability to acquire and understand knowledge, and not keeping the knowledge or applying it after longer period of time (retention). In the second part of the research instrument the students were provided with thematic story inducing situation in which the violent behaviour occurred. The story demonstrated revenge:

Brother

Marek was funny, handsome and gregarious young man, and thus it is no wonder that he was lucky with girls. Whenever he came to have fun at Saturday’s party, he could choose from many nice dancers. Once he met Jitka in the club, and he was dancing and chatting with her for a few hours; he did not know that Igor liked Jitka very much. Igor was an able-bodied athlete and known bully, and because of his violent nature girls rather avoided him – even Jitka knew him only by sight. When Jitka went home and Marek still remained in the club, Igor, strengthened by alcohol, waited for him in the corridor, and without warning attacked and injured him badly. Marek barely dragged himself home, washed and went to sleep, but the next morning his older brother Luke saw him and coaxed what happened out of him. Marek did not want to go to the doctor or the police, everything happened without witnesses, but his teeth knocked out, his black eye and a chipped ribs did not let his brother Luke sleep. He spoke to his friend, who had some unsettled business with Igor from the past, they waited for Igor the next evening at his house, and punished him so that he fared as badly as Marek before.

The students were asked to comment on two fundamental aspects of the conflict situation:

1. To evaluate the act of the defender or their close person
2. To assess the defender or their person whether the act was in the necessary defense.

Via these questions we investigated the learning outcomes of the students in the cognitive area at higher levels according to Bloom’s taxonomy (application, analysis, synthesis, evaluation).

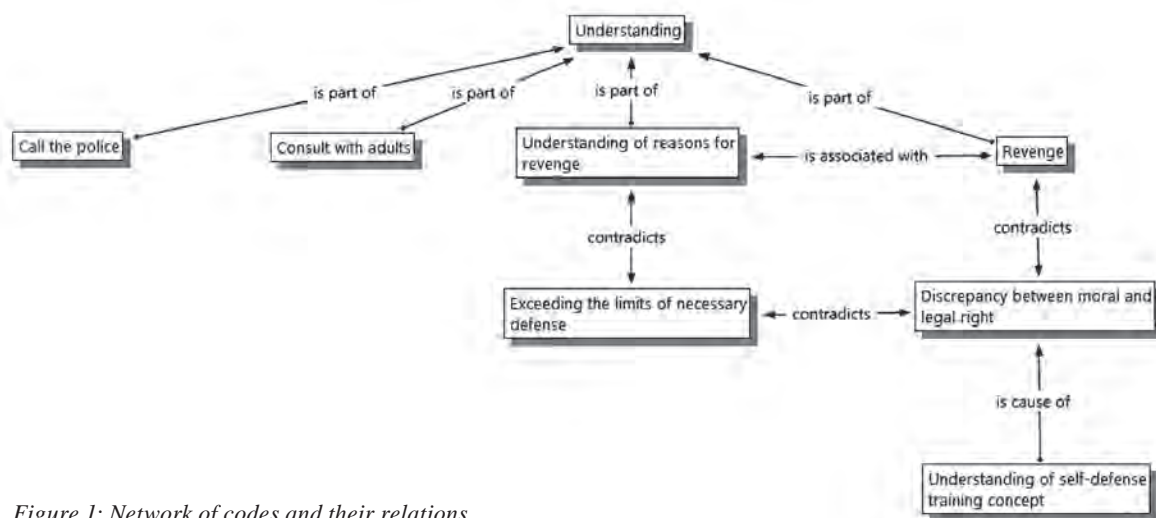

Figure 1: Network of codes and their relations

Through the process of open and axial coding a network of codes was created (see Fig. 1). The analysis clearly showed the strength of some codes and from their interrelationships the following findings resulted. Students perceive the situation objectively and assess correctly what action should be right. According to students the correct solution in this case should be calling the police or reporting violence to an adult or parents. At the same time, however, many of them understand reasons for revenge and feel that they identify with the defender's behaviour, and they would act in the same way being in their place. In the responses of the students we often observe one common and serious topic: discrepancy between the moral and legal right. Students are already at such an intellectual level that they can discern right from wrong, they can assess the situation in terms of legal norms, but also realize that in a real situation they would be influenced by their emotions and could act contrary law.

Although the students are able to describe the legal definition and boundaries of self-defense theoretically and at the same time to assess whether a particular case maintained within these boundaries, it is problematic for them to break free from problem assessment tinged with emotions. On the one hand, students understand that revenge is not in accordance with the law; however, they admit that in cases of causing harm to their siblings they would not often hesitate to violate the law. This observation is clearly illustrated by the following students' responses: "I can understand their conduct. From the moral point of view they were right, but from the legal point of view they were not." "I can fully understand, the desire for revenge is sometimes strong in people, especially when it comes to someone close." "I would not like to do it in such a way, but when I imagine that someone would beat my sister, I might want to take revenge somehow."

A difference between the responses in cognitive and affective domains can be deduced from the above mentioned. Students admit that they would have a tendency to succumb to their emotions and exceed the limits of necessary defense. A statement of one student not only demonstrates understanding of this fact, but also its importance for the understanding of the whole concept in self-defense training: "I think that this all could have been avoided if people pondered the consequences of their actions in advance and acted calmly and rationally. But the fact is that in a stressful situation it is difficult to do so. Therefore, people should know something about it, study what can happen when acting in a particular way, if it is a crime ... That may help them to decide on better."

Conclusion

The students are capable of objective assessment of self-defense situation, when they have the opportunity to comment on the theoretical example demonstrated on another person. Both theory and practice show that human behaviour under stress is strongly influenced by hormonal changes associated with the alarm reaction according to concept of stress by Selye. If these processes are controlled by amygdala, the decision-making process is completely free from conscious choice of reaction. These internal processes lead to instinctive behaviour intended primarily to protect the life and health. The teacher should be aware of these facts and take them into account in the self-defense teaching practices. Learning outcomes in the cognitive area are especially important in theoretical preparation. It involves acquisition, understanding and application of knowledge to a concrete example. With regard to the practical level of self-defense it can be stated that under stress reactions influenced by hormonal control and emotions prevail. This fact should be reflected in teaching self-defense. Recommendation for practice is to use model situations using stress conditions. This approach may lead students to deeper understanding of their own reactions to the attack and the distinction between conscious assessment of the situation and their own instinctive reactions. Only this way of teaching self-defense can provide the student with comprehensive information about the processes that set off in a real attack.

References

1. Vít, M., Reguli, Z., & Čihounková, J. (2011) *Use of scenario training in high school self-defence teaching*. Studia sportiva. (pp. 339-344). Brno.

ANALYSIS OF THE QUALITY CHILDREN'S PLAYGROUNDS TO BE USED FOR LEARNING BASIC GYMNASTIC CONTENT

Kamenka Živčić Marković, Lucija Milčić and Dan Lanc

Faculty of Kinesiology, University of Zagreb, Croatia

Abstract

The aim of this study is to assess the quality of children's playgrounds in the neighbourhood Trnje in Zagreb with reference to the possibilities of use in implementing certain gymnastics topics, as well as a part of curriculum of Physical education in primary school classes. The study was conducted on 43 children's playgrounds. Analysis of quality of playground equipment on playgrounds was performed using two criteria: safety and usability. Results showed different levels of quality of individual equipment but, considering their safety, it can be concluded that the possibility of realization of gymnastic topics on children playgrounds is possible, considering the prescribed curriculum of Physical education in primary school classes.

Key words: playgrounds, artistic gymnastics, playground equipment, teaching curriculum, lower primary school

Introduction

Children's playground is defined as open space equipped with the necessary equipment that is intended for recreation and sports for children and youth (ACT Government, 2008, Wikipedia, 2008). They are usually located in the vicinity of pre-schools and schools, in parks, and in particular, designated open spaces. Nowadays, they are increasingly more present in indoor areas of commercial and sales centers in the form of playrooms and sports and recreation centers in the areas of local communities. Playgrounds, regardless of type and purpose, must be designed to ensure smooth and safe play (Kramarić, Kiš, Švagelj, 2008). Modern playgrounds contain equipment such as seesaws, toboggans, swings, climbing frames, sandstone, carousels, hanging bars and the like. Apparatus and equipment for playgrounds help children in developing fitness levels or the development of basic motor skills such as coordination, balance and basic forms of strength. Some researches (Badić et al., 2012, Bučar Pajek et al., 2010, Turšić, 2007) have shown that in some schools there is a lack of equipment for successful implementation of the curriculum of Physical Education, planned topics and artistic gymnastics, especially from a group of heights and stronghold at the apparatus. In schools that possess the necessary equipment, it is usually outdated and therefore unsafe for implementation in the process of education. Close to a large number of schools, there are specially decorated children's playgrounds, as well as individual apparatus, which can partly replace the existing deficiencies in equipment in some schools. For this reason, it can be assumed that the basic topics of artistic gymnastics can be partially or fully implemented in the open air playgrounds.

Therefore, the aim of this study is to assess the quality of children's playgrounds in the neighbourhood Trnje in Zagreb with reference to the possibility for use in the implementation of some topics in artistic gymnastics, as well as part of the curriculum of Physical Education in primary school classes.

Methods

The sample of examinees consisted of 43 children's playgrounds in the area neighbourhood Trnje - Zagreb. Trnje encompasses 7.365 km² in the southern part of central area in Zagreb, with a permanent population of 42,282 (according to the census from 2011th year), and with eight primary schools. Data collection on the safety and quality of children's playgrounds and equipment was carried out in the form of a questionnaire "Criteria for assessing the quality of children's playgrounds" (Čuk et al., 2007). Data collection was performed on: a combined apparatus, swings, hanging bars, apparatus for balance and hung, toboggans, carousel and playgrounds in full, taking into consideration their security and usability. Quality and safety are evaluated on Likert scale of 1 to 5.

For evaluation purposes of quality of the apparatus in individual children's playground, an analysis of the basic descriptive indicators was performed. The connection between safety and quality of individual apparatus on playgrounds was calculated with Pearson's correlation coefficient, in order to establish the statistical significance analysis of variance for independent samples with significance $p < 0.05$ was performed.

Results

Table 1: Descriptive parameters characteristic for children’s playgrounds

Elements	N	Min.	Max.	Mean	SD
Substrate between apparatus	44	1,00	5,00	3,88	1,61
Fence	43	1,00	5,00	2,48	1,79
Possibility of traffic	44	1,00	5,00	3,31	1,11
Age usability	43	1,00	5,00	4,32	0,24
Swings	40	1,00	5,00	1,87	1,41
Balance apparatus	17	1,00	5,00	3,70	1,21
Combined apparatus	15	3,00	5,00	4,06	1,03
Toboggan	30	3,00	5,00	4,06	1,01
Climbing frames	33	1,00	5,00	3,66	1,19
Apparatus for hanging	8	3,00	5,00	3,50	,92
Carousel	31	1,00	5,00	2,22	1,33
Toilet	43	1,00	5,00	1,69	1,50
Garbage removal	44	1,00	5,00	3,11	1,40
Glass	44	1,00	5,00	1,40	1,18
Benches and tables	44	1,00	5,00	3,54	1,24
Food and Beverage	43	1,00	5,00	1,65	1,49
Parking 1.	43	1,00	5,00	3,76	1,64
Parking 2.	44	1,00	1,00	1,00	,00

Results of descriptive indicators of characteristics (Table 1) show that most of the playgrounds use adequate surface under and around the apparatus (Mean = 3.88). Their security is low because they are generally not fenced (Mean = 2.48), and, in terms of accessibility, bicycles are mostly allowed as means of transportation on playground surfaces (Mean = 3.31). Their usage in consideration with children age shows that they are mainly usable (Mean=4,32) for all age groups (0-3; 4-6 and 7-11age). Results of general characteristics of the swings indicate that they are in the worst condition of all playground apparatus (Mean=1,87). The following are carousels (Mean=2,22), and, in somewhat better conditions are hanging apparatus (Mean=3,50), climbing frames (Mean=3,66) and balance apparatus (Mean=3,70). Best characteristics were obtained by analyzing the quality of the combined apparatus (Mean=4,06) and toboggans (Mean=4,06). Assessment of the presence of toilets on playgrounds in most cases showed that they there are no toilets (Mean=1,69). Garbage disposal near children’s playgrounds is typically conducted once a week, but there exists a tendency of its conduction several times in a week (Mean=3,11), while specially marked garbage dumps for glass are rarely cleaned (Mean=1,40). There generally are benches and tables on children’s playgrounds, although, the tables are less frequent in their appearance (Mean=3,54). There are seldom restaurants, mostly they do not exist (Mean=1,65). Parking places in vicinity of children’s playgrounds mostly consist of marked parking lots with capacity for up to 10 cars (Mean=3,76), while parking for bikes and motorcycles is omitted (Mean=1,00).

Table 2: Correlation coefficient between safety and usage of apparatus

Usage	Safety of swings	Safety of combined apparatus	Safety of climbing frames	Safety of balance apparatus	Safety of hanging apparatus	Safety of toboggans	Safety of roundabouts
swings	,640(**)						
combined apparatus		,173					
climbing frames			,497(**)				
balance apparatus				,303			
apparatus for hanging					,215		
toboggans						,380*	
carousel							,281

** Correlation is significant at 0,01 * Correlation is significant at 0,05.

Correlation coefficients (table 2) indicate that there exists a statistically significant correlation ($p < 0,01$) between safety and usage of toboggans (,380), swings (,640) and climbing frames (,497) with significance $p < 0,05$. Combined apparatus, balance apparatus, apparatus for hanging and carousels did not show any statistically significant correlation between safety and their usage.

Table 3: Analysis of differences in the basics parameters of safety with regard to the type of apparatus

Characteristic	Apparatus	N	M	SD	F	df	p
Substratum	Combined apparatus	43	3,62	1,02	3,061	7/43	$p < 0,05$
	Swings	43	3,35	,68			
	Climbing frames	43	3,01	1,25			
	Balance apparatus	43	3,58	1,17			
	Apparatus for hanging	43	3,74	,89			
	Toboggan	43	3,55	1,35			
	Carousel	43	3,17	1,64			
The size of the substrate	Combined apparatus	43	3,89	1,76	2,895	7/43	$p < 0,05$
	Swings	43	2,15	1,95			
	Climbing frames	43	2,31	1,77			
	Balance apparatus	43	3,05	1,24			
	Apparatus for hanging	43	3,61	,60			
	Toboggan	43	2,75	1,19			
	Carousel	43	2,79	,94			
Possibility of hitting	Combined apparatus	43	2,64	1,34	1,521	6/43	$p > 0,05$
	Swings	43	2,95	1,10			
	Climbing frames	43	2,05	1,58			
	Balance apparatus	43	2,83	,59			
	Apparatus for hanging	43	3,10	,92			
	Toboggan	43	2,98	,95			
	Carousel	43	2,84	1,15			

Analysis of individual characteristics of playgrounds (table 3) with apparatus taken into consideration indicate that there exists a statistically significant difference between apparatus regarding their type and size substrate ($p < 0,05$), while the possibility of hitting the device did not show any significant differences ($p > 0,05$).

Discussion

From the performed analysis of the quality of playgrounds, it can be seen that there exist poor hygienic conditions, with most playgrounds not having toilets, garbage is usually collected once a week at most, and most playgrounds do not have a sign that prohibits glass. Assessment of the quality of children's playgrounds was done on the basis of two criteria: safety and usability of the apparatus, and their quality (ACT Government, 2008, Čuk et al., 2007, Kramarić et al., 2008). Safety was estimated based on the type of substrate between apparatus and under the apparatus, size of the substrate, possibility of hitting, the instructions for handling devices, fence, and the possibility of traffic with bicycles, motorcycles and cars. Based on these analyzes, values of substrates between apparatus indicate that the average substrates are graded 3-4 on the scale, which states that they mostly consist of sand, hard macadam, and sometimes tartan and artificial substrates, although, on most playgrounds, substrates consist of natural ground. Under each apparatus, substrate of a different kind is used. Combined apparatus have the best type of substrates, which are mainly artificial surfaces such as, for example tartan. Toboggans, equipment and hanging apparatus, balance apparatus also have sufficient elastic artificial surface, but sometimes there is only natural ground beneath them. Differences considering types of substrates are also noticeable in the swing, climbing bars and carousel that do not satisfy the criteria of safety substrates around the device while possessing relatively satisfactory surface under the equipment. Lower quality substrates under these apparatus could assume their frequent usage in relation to other apparatus, which causes faster damage. By analyzing the size of substrates around the apparatus, it can be seen that the areas around combined apparatus and hanging apparatus are appropriate for normal playing conditions, and in some cases, even smaller than the predicted surface. Swings, climbing bars, balance apparatus, toboggans and carousel show differences in the size of substrates compared to the hanging apparatus and combined

apparatus. At balance apparatus and toboggans, size of the substrates is within the planned area (ACT Government, 2008, Čuk i sur., 2007), while with the carousel, swings and climbing bars, size was reduced and generally corresponds to the size of the input and output devices. The possibility of hitting, as one of the criteria of safety indicates that there are no significant differences between individual apparatus and that they were made of suitable materials with rounded edges. The best values were obtained with hanging apparatus, swings and toboggans, and the worst results at climbing apparatus. There are no guidelines for handling the devices on playgrounds. Analyzed playgrounds are mostly surrounded by a hedge or fence, and a small number of them is not fenced or enclosed so that the playgrounds can close the door. Obtained data indicates that most playgrounds allow traffic on bike, but on individual playgrounds that have a good fence, traffic is prohibited for any vehicle.

Conclusions

From analyzing safety and quality of 43 playgrounds in neighbourhood Trnje, Zagreb, it can be concluded that they differentiate when considering these two criteria. For this reason, they can be used in the realization of basic gymnastic facilities, which are related to teaching in primary school (Živčić, Breslauer, 2011), applied to a different level of quality, with different levels of security and usability of apparatus for specified age of children, and therefore, different applicability in certain gymnastic topics on apparatus on the playground. In less classroom teaching, in first to fourth grade of elementary school, of total 106 teaching topics and units that are designed and represented in the curriculum PE, 47 themes include various gymnastic topics. This means that of the total numbers of sports facilities, which are related to other sports, about 44.4% are gymnastic movement structures (Živčić, 2010). Topics that are related to the gymnastic sports, and in accordance with its main characteristics and its associated disciplines, can be divided into four groups: the basics of acrobatics, basic vaults, basics heights and stronghold on apparatus, and fundamentals of balance positions on narrow surfaces (Živčić, 2007).

Teaching topics that contain certain structures of gymnastic movements could be very successfully realized on playgrounds. This especially applies to the content and use of heights and stronghold on apparatus that can be realized on various climbing bars and apparatus for hanging, their characteristics are reminiscent of the devices in the halls, where there is a dominant influence on coordination and strength of arm and shoulder belt. Also, the contents which are related to the balance positions can be realized on narrow surfaces, edges of sidewalks and sandstone, various benches, stone walls, tree trunks, and on different types of seesaw and bridges, which are extensively represented on most playgrounds, dominantly influencing the development of static and dynamic balance. Swings, with carousel also help in development of balance and orientation in space as one of the dominant capabilities of a large number of gymnastic movement structures (Novak et al., 2008, Živčić, 2007). Toboggans, as one of the most popular playground equipment, enable different types of climbing, pulling within the basic forms of movement and thus the basic preconditions for learning gymnastic elements and techniques. On a combined apparatus, realization of different types of strong holding, walking, crawling, pulling, descending and skipping is possible, which are a part of a large number of gymnastic elements at the gymnastics all-apparatus event. Considering the conducted analysis, it is necessary to point out that more efforts should be invested in equipping and improving the quality of children's playgrounds. There are visible differences that are going in a positive direction, considering previous research (Čuk et al., 2007, Kramarić et al., 2008). Parameters that should definitely be monitored are their correctness, increase in the number of apparatus and diversity between different apparatus, use of imagination and an increase in apply to younger children, so they can enjoy games which develop skills and acquire new knowledge and ability. Also, this kind of approach allows children to spend more time in the open air which affects the improvement of their health status (Videmšek et al., 2007), and at the same time both the children and teachers develop creativity and imagination.

References

1. ACT Government (2008). Design standards for urban infrastructure-15 playgrounds and playground equipment. /on-line/. Retrieved September 15, 2013 from: www.tams.act.gov.au/
2. Badić, A., Živčić Marković, K., Sporiš, G., Milanović, Z., Trajković, N. (2012). Implementation of gymnastics contents in the classroom teaching at elementary schools of osijek - baranja county. *Acta kinesiologicala*, 1(6): 60-65.
3. Bučar Pajek, M., Čuk, I., Kovač, M., Jakše, B. (2010). Implementation of the gymnastics curriculum in the third cycle of basic school in slovenia. *Science of Gymnastics Journal*, 3(2), 15-27.
4. Čuk, I., Bučar Pajek, M., Bricelj, A., Videmšek, M. in Hosta, M. (2007). Značilnosti igral na slovenskih igriščih. *Šport*, 55(1), 29- 37.
5. Kramarić, M., Kiš, D., Švigelj, K. (2008). Sigurnost na igralištima za djecu kao društvena odgovornost. In Josip Tarad (Eds.), *Zbornik radova III Znanstveno stručne konferencije, Čakovec, 2008, "Management integralne sigurnosti"* (pp. 331-791). Zagreb: Hrvatsko društvo inženjera sigurnosti.
6. Ministarstvo znanosti, obrazovanja i športa (2006). HNOS- Nastavni plan i program za osnovnu školu. Zagreb: Ministarstvo znanosti, obrazovanja i športa
7. Novak, D., Kovač, M., Čuk, I. (2008). *Gimnastična abeceda Ljubljana: Fakulteta za šport Univerze v Ljubljani*.

8. Turšič, B. (2007). Izpeljava gimnastičnih vsebin k so v učenem načrtu tretjega triletja osnovne šole. (Magisterska naloga, Ljubljana) Ljubljana: Fakultet za šport pri Univerzi v Ljubljani.
9. Videmšek, M., Hosta, M., Bučar Pajek, M. in Čuk, I. (2007). Pomen otroškega igrišča za otrokov razvoj. Šport, 55(1), priloga, 3–5.
10. Wikipedia The Free Encyclopedia (2008). Playground. /on-line/. Retrieved January 15, 2014 from: www.en.wikipedia.org/wiki/Children's_playground.
11. Živčić Marković, K. (2010). Uloga i značaj sportske gimnastike u razrednoj nastavi. Zbornik Međimurskog veleučilišta u Čakovcu, 2(1). Čakovec: Međimursko veleučilište u Čakovcu.
12. Živčić Marković, K., Breslauer, N. (2011). Opisi nastavih tema i kriteriji ocijenjivanja-tjelesna i zdravstvena kultura u razrednoj nastavi. Zagreb: LIP PRINT, Međimursko veleučilište u Čakovcu
13. Živčić, K. (2007). Akrobatska abeceda u sportskoj gimnastici. Zagreb: Kineziološki fakultet Sveučilišta u Zagrebu.

ANALYSIS OF SELECTED MOTOR CHARACTERISTICS IN RELATION TO PHYSICAL ACTIVITY IN PRIMARY SCHOOL AGE CHILDREN

Vlado Balaban¹ and Gorica Bilak-Moconja²

¹*Faculty of Physical Culture, Palacky University, Olomouc, Slovakia*

²*Bosnia and Hezegovina*

Main aim of research was the analysis of correlations between fundamental motor skills, motor abilities and intensity of physical activity (PA). The research was conducted on a sample of 60 third to fifth grade of primary school students in the Moravian county in Czech Republic who attended regular physical education classes (2 hours per week). All subjects were tested in the same environment. Children's fundamental motor skills were assessed with Test of Gross Motor Development (second edition) via 12 motor skills tests and Fitnessgram 10 was used to asses motor abilities via 5 motor abilities tests. The Actigraph was used to measure PA (data were expressed as percent of time spent in low, moderate – vigorous and vigorous PA). Correlation between motor characteristics and physical activity was confirmed by using Pearson's correlation coefficient with $p < .05$. The results of research showed that fundamental motor skills and motor abilities in primary school children are significantly related to intensity of PA. Relationship between motor skills, motor abilities and PA could be important to the health of the children, particularly in obesity prevention.

EXPRESSION OF PSYCHOLOGICAL FUNCTIONING DIFFICULTIES FOR PHYSICALLY ACTIVE AND PHYSICALLY INACTIVE 16-18-YEAR-OLD ADOLESCENTS IN THE PERIODS OF AUTUMN AND SPRING

Vida Cesnaitiene and Justina Kairyte

Lithuanian Sports University, Lithuania

Purpose

Studies analysing the effects of seasonality on changes in psycho-emotional conditions often include the contingent of elderly people, but there is a lack of such studies that are subject to young people. Research aim was to establish the expression of psychological functioning difficulties for physically active and physically inactive 16-18-year-old schoolchildren in the periods of autumn and spring.

Methods

The instantaneous questionnaire survey was carried out twice, i.e. in October, 2012 and repeatedly in March, 2013 in Kaunas city secondary schools. Totally, there were 358 schoolchildren. The schoolchildren were given a questionnaire which was composed of International Students' Health and Lifestyle Survey questions about physical activity (HBSC, 1982), and psychological functioning difficulties questionnaire (Pakrošnis and Čepukienė, 2009).

Results

The results showed that physically active subjects had statistically significantly fewer psychological problems in the area of self-evaluation - 1.45 points (spring - 1.55 points) than physically inactive - 1.98 (in spring - 1.81) points, ($p = 0.013$). The average score of school adjustment difficulties for physically active respondents was 3.27 points in spring (in autumn - 2.52), for physically inactive respondents - 4.06 points (in autumn - 2.76 points), ($p = 0.034$). The average score of self-assessment difficulties for physically active respondents was 1.68 points in spring (in autumn - 1.8 points), for physically inactive it was 2.12 points (in autumn - 1.78 points), ($p = 0.036$).

Conclusions

1. Spring time has a positive effect on adolescent physical activity, but at this time adolescents experience more psychosocial difficulties in the areas of social exclusion, maladaptive behaviour, emotional and self-esteem problems than in autumn.
2. In autumn and spring boys are more physically active than girls. Girls encounter psychosocial difficulties in self-assessment more than boys, and boys experience them in the field of social exclusion regardless of the season. The expression of encountered psychosocial difficulties increases with age.
3. Family composition (parents are divorced or not) does not affect the expression of experienced psychosocial difficulties.

EFFECTS OF ALPINE SKI SCHOOL ON ATTITUDE TOWARD ALPINE SKIING

Vjekoslav Cigrovski¹, Ivan Radman², Bojan Matković¹, Gurmeet Singh³ and Hrvoje Podnar¹

¹Faculty of Kinesiology, University of Zagreb, Croatia

²University of Vienna, Institute of Sport Science, Austria

³Panjab University, Chandigarh, Dept. of Physical Education, India

Purpose

Interest in skiing is growing, but there is space to popularize the sport and attract new skiers through influencing attitudes toward it. Sometimes people have formed attitudes toward sport before participating in one, and mentioned are influenced by various factors. We investigated the impact of alpine ski school as a structured way of alpine ski learning on attitude toward alpine skiing in alpine ski naïve young population.

Methods

Research was anonymous and included 136 ski beginners (41 females and 95 males) who fulfilled a previously validated 26-item Lickert scale-type questionnaire related to attitude toward skiing twice during the research; just before and at the end of the seven-day ski school program. For statistical analysis of differences between initial and final testing on attitude toward alpine skiing ANOVA was applied. The level of statistical significance was considered if $p \leq 0.05$.

Results

Male participants had initially more positive attitude toward skiing than females (106.6 vs. 100.7), but after completion of ski school program, both participants attitude became more positive (113.7 vs. 109.4) (Table 1).

Table 1: Differences between initial and final test of attitude toward alpine skiing

ANOVA				
Attitude	IN (mean±sd)	FIN (mean±sd)	F	p
All participants	104.8±14.4	112.4±14.4	18.7	0.00
Male	106.6±14.6	113.7±13.7	11.8	0.00
Female	100.7±13.5	109.4±15.7	7.4	0.01

IN = initial testing; FIN = final testing; SD = standard deviation

In Table 1 differences between initial and final attitude testing for all participants, as well as separate results for females and males are presented. Statistically significant differences in attitude were determined after completion of alpine ski school.

Conclusions

Our results confirm that alpine ski school can help attitude improvement. Moreover, when ski instructors know the attitudes, and expectations of ski beginners in advance, they can adjust program of alpine ski school accordingly and increase interest in skiing. Therefore, they are in powerful role to influence beginners both positively and negatively. Studying instructors' impact on ski beginners' activity choices is an important research area to explore further, especially as a part of plan for eliminating sedentary lifestyles of young people.

ASSESSMENT OF HEALTH-RELATED FITNESS IN HUNGARY: THE NETFIT, AS THE HUNGARIAN FITNESSGRAM INITIATIVE

Tamas Csányi¹, István Karsai¹, Mónika Kaj¹, Orsolya Marton¹, Ferenc Ihász¹, Gregory Welk², Weimo Zhu³, Pedro Saint-Maurice², Kelly Laurson⁴ and Kevin Finn⁵

¹*Hungarian School Sport Federation*

²*Iowa State University/Cooper Institute*

³*University of Illinois at Urbana-Champaign/Cooper Institute*

⁴*Illinois State University/Cooper Institute*

⁵*University of Northern Iowa/Cooper Institute*

Abstract

The Cooper Institute (CI) team assisted the Hungarian School Sports Federation (HSSF) in designing a comprehensive study to evaluate the status of fitness in Hungarian youth and to directly evaluate the utility of FITNESSGRAM standards in this population.

This symposium will share some of the preliminary findings from this project. The research group would like to propose 5 different individual presentations as symposium that will cover 1) the purpose and scope of this initiative, 2) Cross-validation of aerobic fitness and body fat standards for Hungarian youth, 3) the development of norm-referenced standards for muscular fitness, namely, Hand Grip and Standing Broad Jump Test, 4) distribution of health-related fitness of Hungarian youth and, 5) school-based correlates of recommended levels of health-related fitness.

In Session 1 we will provide an overview of this initiative. The HSSF project involved lab and field testing of fitness on children ages 10-18 years enrolled in Hungarian schools. A sample of 43 schools was randomly selected for the field testing from all regions of Hungary. This was a comprehensive initiative that involved the field assessment of ~2500 students and a subsample of 500 students that were randomly selected to conduct laboratory testing at one of five regional laboratories.

Session 2 will describe cross-validation procedures used to determine if the FITNESSGRAM standards for body fat and aerobic fitness developed in U.S. children and adolescents are predictive of health status in Hungarian youth. Session 3 will summarize the process used to determine norm-referenced standards for hand grip and standing broad jump tests. The norms presented provide the basis for the determination of the proposed age and sex specific standards for national Hungarian assessments.

The culminating two sessions (Session 4 & 5) will 4) share the distribution and determinants of health-related fitness in Hungarian youth and 5) share preliminary data on school policy correlates of health-related fitness in youth while taking into account possible individual and school level confounders.

Acknowledgements

The Hungarian National Fitness Assessment Program (NETFIT) is implemented in the frame of a Priority Project (TÁMOP 3.1.13-12-2013-0001) of the Hungarian School Sport Federation with the financial support of the Hungarian Government and the European Union.

EFFECTS OF HOPSPORTS ON-LINE-STREAMING BRAIN BREAKS INTERVENTION PROGRAM IN PRIMARY SCHOOL

Arunas Emeljanovas¹, Brigita Mieziene¹, Laura Tumynaite¹, Dovydas Mikalauskas¹, Magdalena Mo Ching Mok² and Ming-kai Chin³

¹Lithuanian Sports University, Kaunas, Lithuania

²The Hong Kong Institute of Education, Tai Po, Hong Kong

³HOPSports, Inc., Las Vegas, USA

Abstract

The aim of the study was to investigate the effects of providing On-Line-Streaming Brain Breaks (OLSBB) video lessons during class breaks on children's perceptions of, attitudes towards, motivation for physical activity, physical self-confidence and specific academic knowledge in primary school. **Methods.** Study included 181 primary schoolchildren from grade 1 to grade 4, 93 (51.4%) in experimental and 88 (48.6%) in control group ($M_{age} = 8.24$, $SD = 1.10$). The effects of OLSBB were measured by Questionnaire on Physical Activity (QPA) at pre- and post-class. Eight factors (scales) were derived during exploratory factor analysis procedure: Relationship with Language, Art, Music and Culture, Physical Self-confidence, Personal Best, General Knowledge, Effectiveness of Physical Activity to Promote Health, Exercise Motivation, Exercise Knowledge and Importance of Doing Exercise as Habit. All scales showed good internal consistency (Cronbach $\alpha_s > .79$). Experimental group received OLSBB intervention every school day, 5-9 minutes BB video per day for three months during class breaks, supervised by classroom teachers. Each interactive learning BB video provided motor skills learning or practice. Motor skills instructions in video were held in the context of health and nutrition education, social learning, environmental stewardship, specific knowledge on mathematics, writing skills, language, art, music and culture. **Results.** A repeated measure ANOVA with Time as within subject factor determined that experimental group showed higher and control group reported lower scores on four scales (Personal Best, General Knowledge, Exercise Motivation and Importance of Doing Exercise as Habit) at post-class comparing to baseline. A repeated measure ANOVA with group (experimental vs. control) as between subject factor showed significant effect for Time X Group interaction for each scale indicating elevated mean scores in experimental whereas lower scores in control group for QPA scales across time. **Conclusion.** Video exercise training program for three months elicits improvement in children's perceptions of, attitudes towards, motivation for physical activity and specific academic knowledge. It may be concluded that Brain Breaks intervention program contributes to physical, health and general education of primary school children.

Key words: *physical activity, exercise motivation, academic knowledge*

THE INFLUENCE OF MOTOR EXPERIENCE ON MOTOR CREATIVITY (FLUENCY) OF PRESCHOOL CHILDREN

Nataša Sturza Milić

Preschool Teacher Training College „MihailoPalov“ Vrsac, Serbia

Abstract

The relation between motor experience (motor skills and knowledge) and motor creativity in the case of preschool children is significant, but insufficiently studied issue in theory and practice, especially in the field of education. According to contemporary creativity theories, experience and knowledge have an important role to play in forming of a critical level below which creativity is not possible. The aim of the paper is to consider the relation between motor creativity (fluency) and motor experience in preschool children. Estimation of motor performance (motor testing - validated battery of 7 motor tasks) and motor creativity (Torrens TCAM test) has been carried out in Vrsac on the sample of 154 preschool children aged 6 to 6,5. The results show that motorically more able children have made better results in TCAM test tasks (with the variable fluency - CFLU). The highest correlation with CFLU (fluency) is shown in the case of motor task Standing long jump – SLO ($r = .454$; $p = .000$), Polygon with obstacle backwards - POB ($r = -.438$; $p = .000$) and Running 20 m - R20 ($r = .378$; $p = .000$). Due to the fact that the results of the research show a correlation between success of children in the performance of certain motor tasks and motor creativity manifestation, it can be concluded that system of positive influences on physical activity can have a decisive role, both in the development of motor success and in the development of motor creativity.

Key words: motor creativity (fluency), preschool children



Kinesiological Recreation

**7th INTERNATIONAL
SCIENTIFIC
CONFERENCE ON
KINESIOLOGY**

**FUNDAMENTAL
AND APPLIED
KINESIOLOGY – STEPS
FORWARD**

Editors:

**Prof. Mirna Andrijašević, PhD
Danijel Jurakić, PhD**

Peer Reviewers:

**Prof. Mirna Andrijašević, PhD
Prof. Herman Berčić, PhD
Prof. Sanja Ćurković, PhD
Danijel Jurakić, PhD
Prof. Maja Pori, PhD
Prof. Donald Roberson, PhD
Marija Rakovac, PhD
Sanela Škorić, PhD**



HEALTHY LIFESTYLE OF THE SLOVENIAN POPULATION AND CERTAIN FACTORS DISCUSSED IN INDIVIDUAL STUDIES

Herman Berčič and Maja Pori

University of Ljubljana, Faculty of Sport, Ljubljana, Slovenia

Abstract

Purpose: This contribution deals with the healthy lifestyle of the Slovenian population and some positive factors which promote it to a certain extent. **Methods:** The focus of this contribution is on the results and findings of research conducted by a large number of authors from the Faculty of Sport and the Medical Faculty of the University of Ljubljana studying the correlation between adult Slovenians' (N = 856; average age 39±13.73 years) engagement in sport and their experience of stress and their personal evaluation of satisfaction with life. The correlations between variables were evaluated using Spearman's correlation coefficient and general linear models. **Results:** The results indicated that sport activity is a significant predictor of satisfaction with life when controlled for age, gender and education. Only the least active category (less than 2 times per week) was found to be also at a significantly higher risk of more stress. **Conclusions:** Based on the results, it was established that those adult Slovenians who are more physically active suffer less stress and are more satisfied with their life.

Key words: Sport activity, stress, satisfaction with life

Introduction

In recent times, a healthy lifestyle of various population groups has been receiving ever more attention of different experts, researchers and scientists. They generally agree that a healthy lifestyle is defined by a large number of interrelated and interdependent factors. These include regular physical or sport-recreational activity, a balanced and wholesome diet, a rich emotional life, good interpersonal relations as well as a mental and spiritual balance, which are all essentially positive factors. Negative factors include physical inactivity, obesity, smoking, excessive alcohol drinking, consuming of various drugs and psychoactive substances, addiction as well as negative psychological states resulting from different types of stress. Stress is a particularly detrimental factor which is why it was given special attention in this contribution in terms of engagement in sport and satisfaction with life.

While the physiological benefits of physically active leisure are well established (Seefeldt, Malina and Clark, 2002; Penedo & Dahn, 2005), less is known about the emotional benefits and costs of sport activity. Therefore, the aim of the study was to investigate the relationship between sport activity, experience of stress and life satisfaction evaluation among adult Slovenians.

Strong evidence suggests that sport activity can reduce indices of stress among adults (Fleshner, 2005) and helps improve resistance to negative effects of stress (Penedo and Dahn, 2005). The more physically active have revealed themselves to be less stressed (Hamer, Stamatakis and Steptoe, 2009; Craike, Coleman and MacMahon, 2010; Hawker, 2012). Studies have shown that the frequency of physical activity is correlated to greater satisfaction with life (Fox, Stathi, McKenna and Davis, 2007; Stubbe, de Moor, Boomsma, and de Geus, 2007). Researchers have also stated that more physically active people are happier (Thogersen-Ntoumani, Fox and Ntoumanis, 2005). The more active are also more optimistic, in a better mood overall (Penedo and Dahn, 2005), and evaluate the quality of their lives in general higher (Wendal-Vos, Schuit, Tijhuis and Kromhout, 2004). Thogersen-Ntoumani et al. (2005) stated that being sport active at least once a week leads to a higher evaluation of one's life satisfaction.

The main part of the present paper focuses on the relationship between sport activity and the incidence of signs of stress and satisfaction with life. We wanted to establish the differences in stress and satisfaction with life among people engaging in sport activity with different frequencies, controlled by age, education and gender. The broader research has been presented by Planinšek, Škof, Leskošek, Žmuc Tomori and Pori (2014).

Which part of the population leads a healthy lifestyle and how they achieve this can be evaluated and concluded based on findings of individual studies. Therefore, with the longitudinal study entitled "Sport-recreational activity of the Slovenian population", which encompassed several cross-sectional studies in individual developmental periods (already published in several publications and journals) (Petrović et al., 2001; Berčič, 2002; Pori & Sila, 2010; Berčič & Sila, 2011), the Faculty of Sport in Ljubljana identified the sports habits of Slovenians and established how sport intertwines with their lifestyles; moreover, the findings indirectly revealed their attitude to recreational sport in general.

The findings of individual studies show that, during the research period covering several years (1974–2010), the attitude of male and female residents of Slovenia to sport-recreational activity has improved and that the share of people regularly practising sport has increased. Results of the most recent study (Sila, Doupona Topič, & Pori, 2010; Sila & Berčič, 2011) show that 63.9% of the Slovenian population is physically active in one way or another. The sport-recreational activity of girls and women has gone up considerably and there are no longer any statistically significant differences between men and women. All studies reveal that engagement in sport activity decreases with age, although the respective age threshold has been gradually rising, already reaching 60 years in the last study. The main reasons include knowledge and experience gained with the years, a well-settled and action-packed lifestyle enriched with sport and different movement patterns, as well as regular habits. Education is to some extent still a factor of social stratification, including in terms of sport engagement, although its influence has gradually decreased. The most popular sports remain traditional sports and/or aerobic motor activities such as walking, swimming and cycling. The findings essentially demonstrate that ever more Slovenians are leading a healthy lifestyle, thereby improving the quality of life of the entire population.

Stress as a negative factor of health and quality of life

The negative factors which accompany a modern lifestyle and work and indirectly affect the population's health include different types of stress. Stress is detrimental to a healthy lifestyle because it negatively affects a person's psychological balance and the balance between them and their living environment. It is a fact that work (including life) has become increasingly stressful. This means there is a lack of balance between the nature of work and the nature of the worker. An indicator of such imbalance is an excessive workload which is a pathophysiological phenomenon a worker experiences as stress (Berčič, 2011; Molan, Arnerić, Belović, Berčič, Bohm, Ratkajec, & Rus Makovec, 2006). Stress usually occurs when someone is no longer capable of adapting to the specific circumstances at work or outside it. At work, such a situation occurs when a person can no longer perform the tasks required of them. Most often the pressure is too strong, causing stress with mild or serious consequences. These days, the term "managerial stress" has been gaining ground (Meško Štok, Meško, Videmšek, & Karpljuč, 2009). The most important factors of exposure to an excessive workload and the resulting stress include a lack of control over the situation and the unpredictability of events that a person considers very important.

Methods

Subject sample: The data were collected through a survey on a representative sample of 856 adult Slovenians (average age 39±13.73 years).

Variable sample: We determined sport activity with the incidence of any sport activity – times per week. To establish a stress experience, respondents marked how often the nine signs of stress (sleeplessness, body weight fluctuation, pessimism, fear, failure, anger, nightmares, lethargy, and fatigue) had appeared within the previous month. A 1–4 response scale was used where 1 stood for *never*, 2 *seldom* (up to 3 times per month), 3 *often* (1–6 times per week), and 4 *regularly* (every day). To determine how satisfied they were with their lives, items of the Satisfaction with Life Scale (SWLS) were used (Diener, Emmons, Larsen, & Griffin, 1985). The SWLS consists of five statements to which respondents agree or disagree using a 1–5 scale where 1 means *strongly disagree*, 2 *disagree*, 3 *neither agree nor disagree*, 4 *agree*, and 5 *strongly agree*.

Statistical methods: Scores on the first component of stress and satisfaction with the life scale were computed using the Anderson-Rubin method. The correlations between variables were evaluated using Spearman's correlation coefficient and general linear models. Controlling variables for computing the relationship between sport activity and stress and the SWLS were age, gender and level of education.

Results

The results indicate that 86% of the respondents do some kind of sport activity at least once a week (Table 1).

Table 1: Frequency of sport activity of the study sample of Slovenian adults

Parameter	F (%)
Sport activity= never	8
Sport activity <1x per week	6
Sport activity =1–2x per week	45
Sport activity =3–4x per week	22
Sport activity =5x or more per week	19

f – frequency of responses

Most respondents selected response 1 (never) or 2 (rarely, i.e. up to three times per month) for most of the stress items (Table 2); most often (at least once per week) they encounter exhaustion ($Me = 2.01$; $IQR = .86$) and anger ($Me = 1.86$; $IQR = .78$). Answers 3 (neither agree nor disagree) or 4 (agree) were most frequently selected for the satisfaction scale items. Respondents mostly agreed with the item "I am satisfied with my life" ($Me = 3.51$; $IQR = .97$).

Table 2: Principal component weights and distribution statistics for stress and the satisfaction with life scale of the study sample of Slovenian adults

Scale	Item	n	a	Me	IQR	f (%)				
						1	2	3	4	5
Stress	Sleeplessness	821	.53	1.49	.71	62	29	7	2	
	Body weight fluctuation	802	.44	1.37	.65	71	23	4	2	
	Pessimism	792	.71	1.40	.63	66	29	4	1	
	Fear	794	.70	1.42	.62	65	29	5	1	
	Failure	791	.71	1.42	.62	64	30	5	1	
	Anger	807	.63	1.86	.78	36	45	16	3	
	Nightmares	794	.53	1.19	.46	84	13	2	0	
	Lethargy	810	.73	1.61	.70	50	40	9	4	
	Exhaustion	816	.64	2.01	.86	31	41	22	5	
Satisfaction with life	In most ways my life is close to my ideal	852	.88	3.44	.85	2	11	38	41	9
	The conditions of my life are excellent	852	.80	3.51	.97	2	13	34	36	16
	I am satisfied with my life	853	.87	3.57	.91	1	7	27	44	20
	So far I have gotten the important things I want in life	846	.79	3.48	.97	2	13	33	37	14
	If I could live my life over, I would change almost nothing	849	.72	3.14	1.12	9	18	30	32	10

n–number of cases; *a*–weight on first principal component; *Me*–Grouped median; *IQR*–inter quartile range; *f*–frequency of responses

General linear models were constructed in order to evaluate the effect of sport activity on stress and satisfaction, controlling for age, gender and education (Tables 3 and 4).

Table 3: General linear models for the prediction of stress and satisfaction with life by sport activity, age, gender and education

Parameter	Stress ($R^2 = 0.040$; $p < .001$)			Satisfaction with life ($R^2 = 0.068$; $p < .001$)		
	F	p	$\eta^2_{part.}$	F	p	$\eta^2_{part.}$
Intercept	1.874	.163	.002	1.662	.182	.002
Sport activity	4.77	.195	.007	1.74	.002	.020
Age	15.14	.029	.006	10.09	.115	.003
Gender	4.44	.000	.018	4.18	.188	.002
Education	1.52	.001	.021	2.49	.000	.046

F – F-test value; *p* – statistical significance; $\eta^2_{part.}$ – partial Eta squared

In the model for the prediction of stress (Tables 3 and 4, left part), a set of predictors (activity, age, gender, education) has a small but significant effect (adjusted $R^2 = .040$, $p < .001$). Education is the strongest predictor of stress ($\eta^2_{part.} = .021$, $p = .001$); statistically significant predictors are also gender and age. Males have a quarter of the z-value ($\beta = -.265$) lower stress than females and for every year older the expected stress score is lower by .006 z-values. The effect of sport activity on stress is not significant when controlled for age, gender and education; only the "1–2 times per week" group has a significantly ($p = .016$) lower expected score for stress than the most active group.

Table 4: Parameters of general linear models for the prediction of sport activity on stress and life satisfaction, controlled for age, gender and education level

Parameter	Stress (R ² = 0.040; p< .001)				Satisfaction with life (R ² = 0.068; p< .001)			
	β	SE	p	η ² _{part.}	β	SE	p	η ² _{part.}
Intercept	-.084	.158	.596	.000	.370	.155	.017	.007
Sport activity= never	.192	.152	.207	.002	-.572	.150	.000	.017
Sport activity <1x per week	.190	.166	.254	.002	-.236	.094	.012	.008
Sport activity =1-2x per week	.230	.095	.016	.007	-.117	.164	.474	.001
Sport activity =3-4x per week	.116	.105	.271	.001	-.102	.104	.325	.001
Age (years)	-.006	.003	.029	.006	.004	.003	.115	.003
Gender=male	-.265	.068	.000	.018	.088	.067	.188	.002
Education level=I	.513	.130	.000	.018	-.744	.128	.000	.039
Education level=II	.250	.137	.068	.004	-.483	.135	.000	.015
Education level=III	.281	.117	.017	.007	-.305	.116	.008	.008
Education level=IV	.142	.165	.387	.001	-.296	.162	.068	.004

The reference category for sport activity is 5 (5x or more/week) and for education level it is V (university degree or more).

β – beta coefficient; SE–standard error; p – statistical significance; η²_{part.} – partial Eta squared

In comparison with the model for stress, in the model for predicting satisfaction (Tables 3 and 4, right part), a set of predictors (activity, age, gender, education) has a higher significant effect (adjusted R²=.068, p<.001). The effect of activity (η²_{part.}=.020, p=.002) is positive for satisfaction; being active less than 1x per week leads to lower satisfaction with life compared to the reference (most active) group. The strongest predictor of satisfaction with life is education (η²_{part.} = .046, p<.001); all groups but the “IV level of education” group have a significantly lower expected score for satisfaction with life than the reference group. The effect of age and gender are not significant for the prediction of satisfaction with life.

Discussion and conclusions

The results indicated that sport activity is a significant predictor of satisfaction with life when controlled for age, gender and education. Only the least active category (less than 2 times per week) was found to be also at a significantly higher risk of more stress. Similar results were found by Hassmen et al. (2000) where engaging in SA at least twice a week was reflected in participants’ lower stress. Moljord et al. (2011) also reported that lower stress was found in a group which participated in PA 2 or 3 times per week compared to those who were active 1 day or less per week. When controlling for activity, age and education, women experience a higher mean for stress than men. Sex differences with respect to stress were also reported by Fleshner (2005) and Moljord et al. (2011), showing that females were more responsive to stressful situations. Women seemed to be more emotionally sensitive and experienced more interpersonal stress. They have less free time than men and are almost twice as likely to be under time pressure (Gunthorpe and Lyons, 2004). Further, the mean level of stress in our case decreases with age. A possible explanation is that older respondents have decreased stress levels because they do not have to meet as many obligations as younger ones (Horgas, Wilms and Baltes, 1998).

We also found that those people who were more active in sports were more satisfied with their lives. The most active groups were found to be significantly more satisfied with life. Our results extend the findings of other researchers where no significant difference was reported on happiness between those who were physically active 2 or 3 times per week and those who were active almost every day (Moljord et al., 2011). In our case, engaging in sport activity for at least one time per week seemed to lead to greater satisfaction with life. Similar results were obtained in previous studies, showing that individuals who engaged in sports activity at least twice a week reported significantly better overall satisfaction with life (Hassmen et al., 2000). Blace (2012) suggested that those who are more active might have better functional ability, which may play a role in their better health status and greater life satisfaction. The strongest predictor for life satisfaction in our case was education. Associations between life satisfaction and both income and education were also reported in earlier studies (Brown and Frankel, 1993). Higher education can probably lead to a better working position and higher salary. Some investigations have stated that people who are more satisfied are also more successful in other areas of life; they attain more important work positions and have better salaries (Lyubomirsky, King and Diener, 2005). The results also support the conventional wisdom which states that income and education are major contributors to overall satisfaction.

References

1. Berčič H. Analysis of recreational sports activity of Slovenes. In: Milanović, D., Prot, F. (eds.). *Kinesiology New Perspectives*, Proceedings book. 2002: 394-397. Zagreb, Faculty of Kinesiology, University of Zagreb.
2. Berčič H. Doživetja preobremenjenosti na delovnem mestu in njihovo obvladovanje. *Šport*. 2011; 61 (1-2): 40-48.
3. Berčič H, Sila B. Findings from the research studies on sports recreational activities of Slovenian people. In: Milanović, D., Sporiš, G. (eds.). *Integrated Power of Kinesiology*. Proceedings book. 2011: 31-36. Zagreb, Faculty of Kinesiology, University of Zagreb.
4. Blace NP. Functional ability, participation in activities and life satisfaction of the older people. *Asian Soc Sci*. 2012; 8: 75-87.
5. Brown BA, Frankel BG. Activity through the years: Leisure satisfaction and life satisfaction. *Sociol Sport J*. 1993; 10: 1-17.
6. Craike MJ, Coleman D, MacMahon C. Direct and buffering effects of physical activity on stress-related depression in mothers of infants. *J Sport Exerc*. 2010; 32: 23-38.
7. Fleshner M. Physical activity and stress resistance: Sympathetic nervous system adaptations prevent stress-induced immunosuppression. *Exerc Sport Sci Rev*. 2005; 33: 120-126.
8. Fox KR, Stathi A, McKenna J, Davis M. Physical activity and mental well-being in older people participating in the Better Ageing Project. *Eur J Appl Physiol*. 2007; 100: 591-602.
9. Gunthorpe W, Lyons KD. A predictive model of chronic time pressure in the Australian population: Implications for leisure research. *Leisure Sci*. 2004; 26: 201-213.
10. Hamer M, Stamatakis E, Steptoe A. A dose-response relationship between physical activity and mental health: The Scottish Health Survey. *Br J Sports Med*. 2009; 43: 1111-1114.
11. Hassmen P, Koivula N, Uutela A. Physical exercise and psychological well-being: A population study in Finland. *Prev Med*. 2000; 30: 17-25.
12. Hawker CL. Physical activity and mental well-being in student nurses. *Nurse Educ Today*. 2012; 32: 325-331.
13. Horgas AL, Wilms HU, Baltus MM. Daily life in very old age: Everyday activities as expression of successful living. *Gerontologist*. 1998; 38: 556-568.
14. Lyubomirsky S, King L, Diener E. The benefits of frequent positive affect: Does happiness lead to success? *Psychol Bull*. 2005; 131: 803-855.
15. Meško Štok Z, Meško M, Videmšek M, Karpljuk D. Športne aktivnosti in stresne obremenitve pri menedžerjih v slovenskih podjetjih. *Šport*. 2009; 57 (1-2): 62-67.
16. Molan M, Arnerić N, Belovič B, Berčič H, Böhm L, Kožuh M, Ratkajec T, Rus Makovec M. Čili za delo. Obvladovanje preobremenjenosti (zvezek 7). 2006. Ljubljana: Klinični center Ljubljana, Klinični inštitut za medicino dela, prometa in športa.
17. Moljord IEO, Eriksen L, Moksnes UK, Espnes GA. Stress and happiness among adolescents with varying frequency of physical activity. *Percept Mot Skills*. 2011; 113: 631-646.
18. Penedo FJ, Dahn JR. Exercise and well-being: A review of mental and physical health benefits associated with physical activity. *Curr Opin Psychiatry*. 2005; 18: 189-193.
19. Petrovič K, Ambrožič F, Bednarik J, Berčič H, Sila B, Doupona Topič M. Športnorekreativna dejavnost v Sloveniji 2000. *Šport*. 2001; 49 (3): 1 - 48.
20. Planinšek S, Škof B, Leskošek B, Žmuc Tomori M, Pori M. Povezanost športne dejavnosti s stresom in zadovoljstvom z življenjem pri odraslih Slovencih. *Zdrav Var* 2014; 53: 1-10.
21. Rimmele U, Seiler R, Marti B, Wirtz PH, Ehlert U, Heinrichs M. The level of physical activity affects adrenal and cardiovascular reactivity to psychosocial stress. *Psychoneuroendocrinology*. 2009; 34: 190-198.
22. Seefeldt V, Malina RM, Clark MA. Factors affecting levels of physical activity in adults. *Sports Med*. 2002; 32: 143-168.
23. Sila B, Doupona Topič M, Pori M. Športnorekreativna dejavnost Slovencev 2008. *Šport*. 2001; 58 (1-2): 89-114.
24. Stubbe JH, de Moor MHM, Boomsma DI, de Geus EJC. The association between exercise participation and well-being: A co-twin study. *Prev Med*. 2007; 44: 148-152.
25. Thøgersen-Ntoumani C, Fox KR, Ntoumanis N. Relationships between exercise and three components of mental well-being in corporate employees. *Psychol Sport Exerc*. 2005; 6: 609-627.
26. Wendal-Vos GCW, Schuit AJ, Tjehuis MAR, Kromhout D. Leisure time physical activity and health-related quality of life: Cross-sectional and longitudinal associations. *Qual Life Res*. 2004; 13: 667-677.

THE MOST COMMON PHYSICAL RECREATION AND SPORT ACTIVITIES: CROSS-SECTIONAL STUDY IN CROATIAN GENERAL POPULATION

Ana Đerek, Ana Lenard and Danijel Jurakić

Faculty of Kinesiology, University of Zagreb, Croatia

Abstract

The main goal was to identify the most common physical recreation and sports activities in Croatian general population as well as to determine gender differences in participation in those activities. Survey was conducted on a total of 1,032 randomly selected individuals (51.6% female) which were asked to answer an open-ended question: “What type of activities do you usually do?”. Frequency analysis showed that the most common activity is Football/soccer which was reported by 20.82% of exercisers (EX) i.e. 6.88% of general population (GP). Other popular activities are: Walking (19.35% of EX and 6.40% of GP), Resistance training (gym) (16.72% of EX and 5.52% of GP), Aerobics (10.56 of EX and 3.49% of GP), and Running and jogging (9.83 of EX and 3.10% of GP). Results of Chi-Square test showed significant gender differences ($p < 0.05$) for several activities. Since most of popular activities among Croatians are usually performed in informal settings i.e. without professional leadership, there is strong need for inclusion of education of participants in physical activity promotion interventions and strategies.

Key words: *physical activity, exercise, sport, interests, population-based study*

Introduction

It is well known that physical activity has a positive influence on human health. Many previous researches have shown that physical activity reduces the risk of developing chronic diseases, such as type 2 diabetes (Albright, et al., 2000), cardiovascular diseases (Sesso & Paffenbarger, 2000), osteoporosis (Borer, 2005) and obesity (Rippe & Hess, 1998; Hill & Wyatt, 2005). Not only does the physical activity effect our physical health, it also significantly improves our psychological well-being (Fox, 1999). In such a manner it has been shown that physical activity has a positive effect in the prevention and treatment of depression and anxiety (Paluska & Schwenk, 2000), as well as that people who exercise regularly have increased their self-esteem (Elavsky, 2010), enhanced stress responsivity and elevated mood state (Scully, et al., 1998). However, despite of all the positive aspects of physical activity and regular exercise, there is considerable portion of people who don't exercise as frequently as they should. According to World Health Organization there are around 31% of insufficiently active adults globally (World Health Organization, 2014) which makes physical inactivity one of most important public health concerns. Population-based study in Croatia revealed that there are around 59% of people who don't exercise at all, and only 16% of those who exercise three or more times per week (Greblo, et al., 2008).

With the intention to increase physical activity level of the population, many countries have been developing physical activity interventions and strategies. In order to develop efficient interventions and strategies it is crucial to have comprehensive understanding of population physical activity level, interests, needs and habits. For this purpose, we conducted the study with the main goal to identify the most common physical recreation and sports activities in Croatian general population as well as to determine gender differences in participation in those activities.

Methods

Survey was conducted in November, 2007 on a total of 1,032 individuals (51.6% female). The sample for this study included randomly selected participants aged 15 years and more, only Croatians citizens who live on the territory of Republic of Croatia. We did not include people living in institutions, such as hospitals, nursing-homes etc. All examinees have voluntarily participated in this research and have given their written consent before had been interviewed. We used a method of face-to-face interviews led by trained interviewers. More detailed description of sample has been published previously (Jurakić, Pedišić & Andrijasević, 2009).

To determine types of physical recreation and sports activities among Croatians, the examinees were asked to answer an open-ended question: *What type of activities do you usually do?* Examinees had an option to choose up to three activities. Since there were more than 30 activities reported overall, we grouped some activities in joined categories. Specifically, category *Other activities* included low represented activities such as: dog walking, diving, horseback riding, home exercising, trekking. Category *Therapeutic exercise* included following reported activities: back exercise, medical

gymnastics, corrective exercise, exercise for osteoporosis prevention and gymnastics. Category *Cardio fitness* included following responses: cardio fitness, stationary cycling, rollerblading.

Statistical analyses were performed by STATISTICA 7.1 (StatSoft, Inc., 2005). In order to determine portion of participants in specific activities we conducted frequency analyses separately for whole sample and for participants who answered above mentioned question. In following text, category of participants who answered question about participation in specific activity we will address as Exercisers. Further frequency analysis was performed to determine portion of females and males exercisers included in specific activities. The Yates's chi-square test was performed in order to determine gender differences in physical recreational activities and sports among exercisers.

Results

Among total of 1,032 participants, 341 (33,0%) answered the question about activity they usually participate in (47% women). As mentioned earlier, in further text we will address this group of participants as Exercisers. Frequency analysis revealed that the most common activity is Football/soccer which was reported by 20.82% of exercisers i.e. 6.88% of general population. Among top five most common activities are also: Walking (19.35% of exercisers and 6.40% of general population), Resistance training (gym) (16.72% of exercisers and 5.52% of general population), Aerobics (10.56 of exercisers and 3.49% of general population), and Running and jogging (9.83 of exercisers and 3.10% of general population) (Table 1.). The most common activities among male exercisers are Football/soccer (38.67%), Resistance training (22.65%), Walking (14.36%), Running and Jogging (9.39%) and Cycling (7.73%). On the other hand, female exercisers are more interested in activities such as Walking (25.0%), Aerobics (22.5%), Therapeutic exercise (11.88%), Cycling (10.00%), Resistance training (10.00%).

Table 1: Portion of participants in sports and physical recreation activities and test of gender differences

	Female (%)*	Male (%)*	Total (%)*	Total in GP (%)**	Chi Square	p
Football/soccer	0.63	38.67	20.82	6.88	49.24	<0.001
Walking	25.00	14.36	19.35	6.40	3.61	0.057
Resistance training (gym)	10.00	22.65	16.72	5.52	6.29	0.012
Aerobics	22.50	0.00	10.56	3.49	34.66	<0.001
Running and jogging	9.38	9.39	9.38	3.10	0.03	0.857
Cycling	10.00	7.73	8.80	2.91	0.23	0.629
Other activities	10.63	5.52	7.92	2.62	1.98	0.160
Therapeutic exercise	11.88	1.66	6.45	2.13	12.86	<0.001
Swimming	4.38	6.08	5.28	1.74	0.18	0.672
Racquet sports	3.13	7.18	5.28	1.74	1.81	0.178
Cardio fitness	5.63	4.97	5.28	1.74	0	0.990
Dance	8.75	1.10	4.69	1.55	8.51	0.004
Pilates	8.75	0.55	4.40	1.45	10.60	0.001
Basic exercise (stretching and toning)	6.25	2.76	4.40	1.45	1.52	0.217
Other recreational sports (handball. volleyball. water polo)	3.13	5.52	4.40	1.45	0.59	0.442
Basketball	0.63	6.08	3.52	1.16	5.49	0.019
Martial arts	1.25	2.21	1.76	0.58	0.06	0.804
Bowling	1.25	2.21	1.76	0.58	0.06	0.804
Yoga	2.50	0.55	1.47	0.48	1.04	0.308

Note. * Portion of participants in specific activity among exercisers. ** Portion of participants in specific activity in general population

The most unattractive activities for men were Aerobics, Pilates and Yoga, while women showed smallest interest in Football/soccer, Basketball and Martial arts.

Results of Chi-Square test showed significant gender differences ($p < 0.05$) for following activities: Football/soccer, Aerobics, Resistance exercise (gym), Therapeutic exercises Dance, Pilates and Basketball (Table 1.).

Discussion and Conclusion

The main goal of this paper was to identify the most common physical recreation and sports activities in Croatian general population as well as to determine gender differences in participation in those activities. The results showed that the most common activities in Croatia general population are: Football/soccer, Walking, Resistance training (gym), Aerobics, and Running and jogging. While Walking, Resistance training (gym), Aerobics, and Running and jogging are expectedly ranked very high (Canadian Fitness and Lifestyle Research Institute, 1998; Australian Bureau of Statistics, 2012), it was somewhat unexpected that Football, as team sports activity, will be ranked first in general population. To the best of our knowledge, there is no research that identifies any of team sports as the most common activity among general population of some country. There are several facts that may help in explanation of this phenomenon. Firstly, football has been the most popular, most promoted, and certainly most represented sport in mass media in Croatia during the past several decade. Secondly, considering great tradition that football has in Croatia, it is not rare phenomenon that children, especially boys, are being taught football skills by their parents which makes significant impact for their later choice of recreational activity. Thirdly, there is significant number of suitable sport facilities (school playgrounds) in Croatia where football can be played free-of-charge. In context of physical activity promotion, it is important to recognize injury risks of football because musculoskeletal injuries were identified as one of primary reasons for stop exercising (Hootman, et al., 2002).

Since it was shown by recent Eurobarometer data (European Commission, 2010) that most preferable setting for physical activity and sports are Parks and Other outdoor environment, it was expected that Walking and Running and jogging will be ranked in the top 5 favorite activities. Although there has been proven numerous health benefits of above mentioned activities and thus this kind of activities are being promoted, education about this activities is usually neglected. Since these activities are usually performed in informal settings i.e. without professional leadership, the need for education of participants about potential health risks, proper technique, intensity, duration, and frequency of exercise is obvious.

Resistance exercise (gym) and Aerobics are also very popular among male and female exercises, respectively. Since these activities are usually performed in fitness center, we could assume that somewhat more than 25% of exercisers in Croatia are members or uses fitness center, which is considerably higher than average in European Union (EU) (11%) (European Commission, 2010). If we compare Croatia to specific EU countries, exercise in fitness centers is more popular only in Sweden where 31% exercisers use fitness centers (European Commission, 2010). According to same source, exercise in fitness centers, among EU countries, is least popular in France (2%) and Hungary (2%) (European Commission, 2010).

Regarding gender differences, as expected men participate significantly more often in team sports (Football and Basketball) and Resistance exercise in the gym while women more often engage in Aerobics, Dance, Pilates, and Therapeutic exercises. This finding is in accordance with most of previous studies, according to which, men more often participate in team sports while women more frequently perform expressive activities (eg. dance, aerobics) (Canadian Fitness and Lifestyle Research Institute, 1998; Australian Bureau of Statistics, 2012). Possible explanations for this difference could lie in different motives for engagement in sports and physical recreation between women and men (Koivula, 1999). For example, it has been proven that women value competition less than men (Gill, et al., 1996). Furthermore, social incentives and health improvement are valued more by females than by males (Flood & Hellstedt, 1991; Caglar, Canlan, & Demir, 2009). In line with above mentioned, gender differences should be taken into consideration when creating physical activity promotion intervention and strategies.

To conclude, we determined the most common physical recreation and sports activities that people in Croatia engage in. The most performed activities in Croatia general population are: Football/soccer, Walking, Resistance training (gym), Aerobics, and Running and jogging. Since most of above mentioned activities are usually performed in informal settings i.e. without professional leadership, there is strong need for inclusion of education of participants in physical activity promotion intervention and strategies. Education of participants should include basic information about potential health risks, proper technique, intensity, duration, and frequency of specific activity. Finally, when creating physical activity promotion intervention and strategies gender differences should be taken into consideration.

References

1. Albright, A., Franz, M., Hornsby, G., Kriska, A., Morrero, D., Ullrich, I., & Varity, L.S. (2000). American College of Sports Medicine position stand. Exercise and type 2 diabetes. *Medicine and Science in Sports and Exercise*, 32(7), 1345-1360.
2. Australian Bureau of Statistics (2012). Sports and Physical Recreation: A Statistical Overview, Australia, 2012. /on-line/. Retrieved February 15, 2014 from: <http://www.abs.gov.au/ausstats/abs@.nsf/Products/8F88DA9AC6E141AACA257AD9000E2666?open document>
3. Borer, K.T. (2005). Physical Activity in the Prevention and Amelioration of Osteoporosis in Women. *Sports Medicine*, 35(9), 779-830.
4. Caglar, E., Canlan, Y. & Demir, M. (2009). Recreational Exercise Motives of Adolescents and Young Adults. *Journal of Human Kinetics*, 22: 83-89.
5. Canadian Fitness and Lifestyle Research Institute (1998). Popular physical activities. Progress in Prevention, Bulletin no. 32./on-line/. Retrieved February 15, 2014 from: <http://www.cflri.ca/media/node/177/files/pip32.pdf>

6. Elavsky, S. Longitudinal examination of the exercise and self-esteem model in middle-aged women. *Journal of Sport and Exercise Psychology*, 32(6), 862-880.
7. European Commission (2010). Special Eurobarometer 334 /Wave 72.3 – TNS Opinion & Social. Sport and Physical Activity./on-line/. Retrieved February 15, 2014 from: http://ec.europa.eu/public_opinion/archives/ebs/ebs_334_en.pdf
8. Flood, S.E., & Hellstedt, J.C. (1991). Gender differences in motivation for intercollegiate athletic participation. *Journal of Sport Behavior*, 14, 159-167.
9. Fox, K.R. (1999). The influence of physical activity on mental well-being. *Public Health Nutrition*, 2(3a), 411-418.
10. Gill, D.L., Williams, L., Dowd, D.A., Beaudoin, C.M., et al. (1996). Competitive orientations and motives of adult sport and exercise participants. *Journal of Sport Behavior*, 19, 307-318.
11. Greblo Z., Pedišić, Ž., & Jurakić, D. (2008). Relationship between exercise frequency and self-perceived mental health. In D. Milanović & F. Prot (Eds.), *Proceedings Book of 5th International Scientific Conference, Zagreb, 2008, "Kinesiology research trends and applications"* (pp. 814-817). Zagreb: Faculty of Kinesiology, University of Zagreb.
12. Hill, J.O., & Wyatt, H.R. (2005). Role of physical activity in preventing and treating obesity. *Journal of Applied Physiology*, 99: 765-770.
13. Hootman, J.M., Macera, C.A., Ainsworth, B.E., Addy, C.L., Martin, M., & Blair, S.N. (2002). Epidemiology of musculoskeletal injuries among sedentary and physically active adults. *Medicine & Science in Sports & Exercise*, 34, 838-844.
14. Jurakić, D., Pedišić, Z., & Andrijasević, M. (2009). Physical activity of Croatian population: cross-sectional study using International Physical Activity Questionnaire. *Croatian Medical Journal*, 50(2), 165-173.
15. Koivula, N. (1999). Sport participation: differences in motivation and actual participation due to gender typing. *Journal of Sport Behavior*, 22(3), 360-373.
16. Paluska, A., & Schwenk, T.L. (2000). Physical Activity and Mental Health: Current Concepts. *Sports Medicine*, 29(3), 167-180.
17. Scully, D., Kremer, J., Meade, M.M., Graham, R., Dudgeon, K. (1998). Physical exercise and psychological well being: a critical review. *Br J Sports Med*, 1998 Jun;32(2):111-20.
18. Sesso, H.D., & Paffenbarger, R.S. (2000). Physical Activity and Coronary Heart Disease in Men. The Harvard Alumni Health Study. *Circulation*, 102(9):975-980.
19. Statistica for Windows (2005). Version 7.1.30.0. Copyright StatSoft.Inc
20. World Health Organization (2014). Global Health Observatory (GHO). Prevalence of insufficient physical activity./on-line/. Retrieved February 15, 2014 from: http://who.int/gho/ncd/risk_factors/physical_activity/en/index.html

EXERCISING HABITS AND SUBJECTIVE QUALITY OF LIFE SELF-EVALUATION OF WOMEN ENROLLED IN GROUP FITNESS PROGRAMS

Gordana Furjan-Mandić¹, Mirna Strikinac² and Josipa Radaš¹

¹Faculty of Kinesiology, University of Zagreb, Croatia

²Sport centar "Vitruvius", Sesvete, Croatia

Abstract

The key goal of the research is to determine the characteristics of women enrolled in group fitness programs and to identify their exercising habits. Subjective health self-evaluation was determined using a questionnaire. 71 women took part in this survey, all of them participants of sports and recreation programs in the sports center 'Vitruvius Sport'. The highest percent of the participants are young female college students or graduates. They generally rated their health positively. When it comes to exercising habits, results show that 37% of the participants have been attending the sports center for less than a month, 23% of them for a period between 2 and 5 months. The survey shows 21% have been exercising at the center for more than 2 years. The majority takes part in the program 2-3 times a week. Most of them said they didn't feel tired and drained (70%), stating they generally got enough sleep. Also, 68% said they felt mentally and physically balanced.

Key words: fitness, women, health, physical exercise, self-evaluation

Introduction

Many researchers have shown correlation between regular physical activity and mental health alongside motoric and functional abilities (Greblo, Pedišić and Jurakić, 2008.). Also, interventions aiming to involve employees in physical activity during their free time (different exercising programs and other recreational activities) were found to be economically justifiable (WHO, 2008, according to Greblo, Pedišić and Jurakić, 2008), and how one spends their free time was found to be in direct correlation with indicators of the quality of life. (Perasović and Bartoluci, 2008, according to Greblo, Pedišić and Jurakić, 2008). For the above reasons it is necessary to spend free time in the best way possible, and adjust it to the needs and abilities of each person. One way of organizing free time is to take part in group fitness programs, upsides of which being they are programmed for all age groups and levels of training, and also adjustable and safe enough if being carried out by well-educated instructors. Particular fitness programs mostly involve one or two of these components and it is up to the participants to choose a program that is going to suit them best. The aim of the selection program should be to review the impact on the health of individuals who are most needy or neglected, and are essential for high-quality implementation of daily life or the specifics of the job.

Group Fitness Programs

Organized group programs have existed for over 50 years. Experience has shown that fitness programs are not attended only by healthy individuals, but also those with acute or chronicles minor health issues. Many researchers have determined correlation between the body mind programs yoga, pilates and taiji quan, and mood amelioration and better work efficiency (Netz and Lindor, 2003). Kennedy and Newton, 1997, have compared similar exercising styles with different intensities and found that persons that did exercises of greater intensity had a lower level of rage than persons that did exercises of lower intensity. Netz and Lindor, 2003, connect mood amelioration with activities of lower intensity. Despite some dissent over the correlation of exercising and emotional betterment, researchers have concluded that both activities of lower (pilates, yoga), (Netz and Lindor, 2003), and higher intensity (aerobics, step aerobics) give greater psychological and emotional betterment. Stated researches indicate that activities with greater intensity give greater psychological and emotional results.

The Quality of Life

Health issues caused by today's lifestyle have affected the quality of life in a negative way, thus causing significant economic losses (DeVol and Bedroussian, 2007, according to Jurakić, Andrijašević, Pedišić, 2010). A satisfactory level of quality of life can be hard to determine in an equal and objective manner because it is influenced by different preferences and the citizens choosing, but it is still reached by measuring a certain predetermined minimum for a particular level. (Svirčić Gotovac, 2006, 107).

In spite of an ever bigger awareness of health melioration due to taking part in recreation, exercisers must constantly be stimulated, motivated, continuously made aware, and they must be suggested programs best suited for the specific individual.

The Problem and Goal of the Research

The increasing inactivity in the female population is the cause of health status deterioration. Research should give answers about the amount of self-awareness i.e. taking care of one's health by participating in different physical activities.

The research also gives information about the age of the participants, their exercising habits and education.

The importance of this research is lies as well in the fact that it provides information about the found state at the Center, on which grounds planning and programming group fitness programs considering the participants' characteristics should be made easier. Further, the research can offer help in finding a program the Center could use to attract women of different age groups that haven't showed interest in physical activity so far.

Methods

Sample of respondents

The sample is constituted of 72 women, group fitness programs participants within the 'Vitruvius' sports center in Sesvete. Women aged 18 – 65 have answered the questionnaires voluntarily.

Variables

The first part of the paper consisted of five questions about age, education, health, duration and frequency of exercising. The questionnaire titled 'Physical activity promoting quality of life' is part of an international study that is being conducted.

It consists of 16 questions regarding subjective health self-evaluation.

The respondents have given answers on a scale of 4 levels where 1 means 'Never', 2 means 'Sometimes', 3 means 'Often', and 4 means 'Always'.

Data analysis methods

Descriptive data analysis

Results and discussion

Table 1: Number of participants of specific age groups

AGE	>19 years	20-34years	35-49years	50-64years	65+years
N	21	31	14	3	2

As one can conclude from the data from Table 1, mostly women from younger age groups attend the Vitruvius Sports Center, 44% of which aged between 20 and 34, 30% are 19 and younger, and 20% of the participants are between 35 and 49 years old.

Table 2: Number of participants compared with education rank

EDUCATION	High School Student	University Student	High school Graduate	Associate Degree	University Graduate	Master's / Doctor's Degree
N	6	20	15	8	20	2

Educational structure shows biggest figures for participants who are university students (28%) and university graduates (28%).

These results are also confirmed by research conducted by Martinez-González and associates (2001). As research method, they used the interview, and what was found was that participation in physical activities is more frequent in examinees with higher rank of education.

Table 3: Number of participants compared with health condition

HELATH	Bad	Satisfactory	Good	Very Good	Excellent
N	0	1	17	31	22

They generally assess their health positively, as expected, as this is a younger population whose health still hasn't been impaired.

44% of the participants assess their health as very good, 31% as excellent, and 24% as good.

Results of previous research show that the 3 oldest age groups state health as the most important motive in enrolling in physical activity. (J.C. Quindry, D. Yount, H. O'Bryant, M.E. Rudisill 2011)

Table 4: Number of participants compared with the duration of exercising at the Center

DURATION OF EXERCISE	0	>1 month	2-5 months	6-12 months	1-2 years	>2 years
N	2	26	16	7	5	15

When it comes to exercising habits, results read that 37% of the recreational have been exercising at the Center for less than a month, 23% of them have been exercising between 2-5 months, and 21% more than 2 years.

When asked how many times they have attended the Center in the last 7 days, one can see that the majority attends the program 2-3 times a week, which coincides with the examination of exercise quantity in the last month.

42% of the participants exercise 2 times a week, 30% of them exercise 3 times a week, and 20% exercise once a week, while the ones that exercise more than 3 times a week are a minority.

Experts consider these results to be satisfactory specifically because of the fact that the Sports Center enables a combination of programs.

A big number of women exercise, as said, in the period between 2 and 5 months and quit exercising for a period of time, then get back to it again. Most often, the participants quit during winter time, and continue exercising with spring, i.e. during March.

Table 5: Frequency of exercise in the past week

WEEK	1week	2week	3week	4week	5 >week
N	14	30	21	5	1

These answers show that the majority attends the program 2-3 times a week. 42% of the participants exercise 2 times a week, 30% of them exercise 3 times a week, and 20% exercise once a week, while the ones that exercise more than 3 times a week are a minority.

One could say these results are satisfactory for the particular reason that the Sports Center enables participants to combine programs.

Table 6: Caring for your own health

CARING FOR YOUR OWN HEALTH	NEVER	SOMETIMES	OFTEN	ALWAYS
When it comes to my health, always looking for another medical opinion	19	33	14	5
I always ask for an expert opinion as to take care of health	12	33	21	5
Inform always about healthy lifestyles through magazines and websites and	6	21	29	15
I look optimistically to the future	1	6	20	43
I manage to strike a balance between free time and commitment	1	10	38	22
I sleep enough	1	24	28	18
I regular follow educational programs on health	12	42	14	2
I take extremely care of their diet	8	38	20	5
I feel tired and drained	5	50	16	0
I'm worried about his poor physical condition	16	38	12	4
I accept the things in life you cannot change	9	29	25	7
It's important to me that I look good	0	13	32	26
I discuss about my problems with my close people	0	9	32	30
I think I'm mentally and physically in balance	0	23	34	14
I feel listless and without energy	16	48	7	0
I can say that I am satisfied with my life	0	5	34	32

Having analysed the claims that best describe the respondents, and deal with physical and mental health of the respondents, the results show the following:

When it comes to health care, results show that they rarely ask for a second physician's opinion or physician's advice on how to take proper care of their health. They rarely watch educational television shows about health, but they often get information through internet and magazines.

These results are in accordance with what was expected, which is also confirmed by researches that show that the outlays for health care were among the smaller expenses (2-3%) in the total of domestic outgoings, and outlays for sports and recreation are just above the health care outlays (around 6% of the total of domestic outgoings). (Svirčić, Gotovac, 2007, 57)

The respondents generally have a positive outlook on life. That is corroborated by the results which show that they perceive the future optimistically, and manage to find balance between their free time and obligations. The positive result is likely influenced by the fact that the sample is constituted of a younger population with a big share of student population and persons that live in a relationship, but haven't yet started a family.

The majority doesn't feel tired and drained (70%) stating they generally get enough sleep. Only part of the respondents (23%) often feels fatigue and exhaustion. It is suggested that these are women with professional and family obligations. We would also connect the information that suggests that 70% of the women generally gets enough sleep i.e. doesn't feel drained because they are still not burdened by family obligations, with the presence of daily exercise that helps keep the body balanced.

When it comes to exercise, they don't find that they are in bad shape and they are not worried about it. Also, one could say they are optimistic and flexible in the sense that they accept life situation they cannot change. The importance of the physical component is pointed out stating that physical appearance is important and very important to them (45%), and sometimes important (40%) what is expected considering continuous exercise. They discuss their problems often and always with their loved ones which indicates there is an openness and communication within the sample. Considering the results in this and some other variables, it can be said that the respondents have good social skills.

Moreover, 68% of the respondents often feel mentally and physically balanced and always while 32% sometimes feel mental and physical balance. The respondents show a conspicuously positive attitude towards life expressing satisfaction with their own lives and energy-filled feeling.

Conclusion

Observing and working as a group fitness instructor, it is important to notice group and individual needs and adapt to them, stimulate, encourage and, at the same time, educate them.

The carried out research has shown that the participants of the Vitruvius Sports Centre who are older women with poorer health are represented in the smallest number. That population is exactly the one that needs exercise the most, with the exception of illnesses where physical exercise is counter indicated. Because of that, the Center should work on designing programs that would attract this population as well as people with lower ranks of education. By organising different educational programs, population's awareness about the importance of exercising in promoting health preservation and improving quality of life should be risen.

By continuously introducing new and attractive programs that are adjusted to the characteristics of the participants, exercisers are motivated to exercise regularly and to stick to the chosen fitness center. The creativity of fitness instructors is the key and single most important characteristic that keeps the participants in a certain program.

References

1. Bize, R., R. C. Plotnikoff (2009). The relationship between a short measure of health status and physical activity in a workplace population. *Psychology, Health & Medicine* Vol. 14-1, pp. 53-61.
2. Fair, 2008. (str. 25 do 31). Zagreb: Faculty of Kinesiology, University of Zagreb Yannick Stephan, Julie Boiché, Christine Le Scanff, 2010., Motivation and physical activity behaviors among older women: a self-determination perspective. *Psychology of women quarterly* 34, 339-348.
3. Greblo, Z.; Pedišić, Ž. i Jurakić, D. (2008). Relationship between exercise frequency and self-percieved mental health, in: Milanović Dragan and Prot Franjo (Ur.). *Kinesiology Research Trends and Applications*. Zagreb: Faculty of Kinesiology, University of Zagreb.
4. Jurakić D., 2009., Taxonomic Characteristics of Employed Middle-Aged People as a Base for Designing recreational programs (ph.D. thesis), Zagreb: Faculty of Kinesiology, University of Zagreb.
5. Kennedy, M.N. and M. Newton, 1997. Effect of exercise intensity on mood in step aerobics. *J. Sports Med. Phys.*, 37: 200-204.
6. Martinez-Gonzalez MA, Martinez JA, Hu FB, Gibney MJ, Kearney J. (1999). Physical inactivity, sedentary lifestyle and obesity in the European Union. *Int J Obes Relat Metab Disord*; 23:1192-201.
7. Netz, Y. and Lindor, R. (2003). Mood alterations in mindful versus aerobic exercise modes. *Journal of Psychology* 137, 405-419.
8. Perasović, B. i Bartoluci, S. (2008). Free Time and the Quality of Life in the Young population. U M. Andrijašević (ur.), *Collected Works: Kinesiological Recreation and the Quality of Life*, 2008 (pg. 15>24). Zagreb: Faculty of Kinesiology.
9. Quindry JC, Yount D, O'Bryant H, Rudisill ME (2011). Exercise engagement is differentially motivated by age-dependent factors. *Am J Health Behav*. May; 35(3):334-45.
10. Svirčić-Gotovac, A, 2008., Sociological Aspects of the Quality of Life. U M. Andrijašević (ur.), *Kinesiological Recreation and the Quality of Life*, Zagreb.

SPORTS AND RECREATIONAL ACTIVITIES IN CROATIAN MINI CRUISER OFFER

Daniela Gračan and Marina Barkidija

Faculty of Tourism and Hospitality Management, University of Rijeka, Croatia

Abstract

The impaired quality of modern life, caused by stress and pollution, requires a revitalization of human psycho-physical abilities. Sports and recreation is becoming a strong antidote to the negative aspects of modern life and important factor in satisfying human needs. Active vacation is one of the measures of preventing social and physical fatigue, and spending spare time on floating hotels-cruisers is becoming an increasingly popular choice for tourists. In recent years Croatia has been developing domestic mini cruising which, unlike the world's mega cruising, excludes mass tourism and is thematically oriented. The rich offer of sports activities, such as cycling make it an attractive Croatian brand. This paper is based on theoretical principles with an emphasis on domestic mini cruising and sports tourism as its component.

Key words: cruising, cruising on domestic mini cruisers, sports and recreation, cycling

Introduction

The connection between cycling as an integral part of an active vacation and cruising tourism represents an interesting blend and a priority in the Croatian cruising offer. The increasing demand for a planned tour of the Adriatic Sea by boat and bicycle puts a new imperative before the visionaries of Croatian tourism in the future. While both mini-cruiser travelling and cycling are still developing in Croatia, the synergy of these forms of vacation increases their popularization. The aim of this paper is to show that cycling represents a good way of enriching the mini cruiser offer, and vice versa, since the combination of these two forms of tourism provides a quality leisure and activity. Besides cycling, the sun and the sea, the tourists can also choose among other sports and recreational activities.

Tourism and sport

As an integral part of a tourist offer, sports activities substantially fill the tourists' time and allow them a more active holiday in relation to their work environment. Sports activities fulfil the need for the sun, air and water and have a significant psychophysiological value. The contents involving physical exercise designed for an active holiday of tourists are known as sports recreation. "It represents physical human activity outside professional work, selected according to one's needs and wishes, and oriented toward one's rest, refreshment and entertainment" (Relac, Bartoluci, 1987, p. 24). As stated by Marc Auge (2010, p. 9), "the bicycle is part of everyone's history, but not only history, but also the present." In recent times, in addition to other sports and recreational activities, cycling has become a prominent way of attracting tourists to cruise the Adriatic on domestic mini cruisers.

Sports recreation and tourism are part of the leisure activities market. The development of specific forms of tourism, namely sports and nautical, interrelated these two phenomena. Sports recreation and tourism belong to the area of satisfying the so-called secondary human needs, and activities performed within these two sectors undoubtedly depend on the changes in society (Bartoluci, Škorić, 2009). Leisure is an important factor in the development of tourism and sports recreation.

Because of the special Croatian coast, ports and ships, it can be concluded that Croatian mini cruising is still a specific form of tourism. In Croatia, the last few years developed as a segment of mini cruisers. A "mini" does not have the same meaning as in the world of cruising. This name in the world means a time-limited travel to large ships while in Croatia, size, date available ships, as well as their capacity for receiving passengers imposed by this title just because it does not have the mega-cruisers.

Different forms of sports have led to new forms of interrelatedness with tourism (Relac, Bartoluci, 1987, p. 30). What makes Croatian cruising tourism distinctive are cruises with an emphasis on recreation that offer sports activities as an entertainment factor in two ways:

1. As a means of entertainment or recreation by sightseeing, in order to enrich the tourists' stay and break the monotony (cruising in combination with hiking and climbing)
2. As a means of active vacation, emphasizing the tourists' participation and the development of creative skills, whether through familiar sports activities that they are already engaged in in their place of residence, or through new sports activities (cruising in combination with intense cycling tours).

Tourist recreation with physical exercise or sports recreation outside of place of residence is an important, necessary and inseparable segment of sports recreation as a whole, enabling a continuation of familiar and known elements of sports entertainment during the tourists' vacation, when people have the biggest amount of free time at their disposal (Relac, Bartoluci, 1987, p. 25).

Croatian cruising on domestic mini cruisers

The knowledge that tourist travelling is important confirms that it matters where to go and where to spend one's spare time. As much as travelling and staying outside permanent residence is important in emotional, medical, recreational and educational sense, it also represents a significant expenditure. Therefore, evaluation of specific arrangement's quality is crucial in providing satisfaction and general well-being of the passengers, following the notion that "man is the measure of all things," assuming that everyone will find something to satisfy their taste and needs.

The English word cruising is being used to denote a relatively new type of tourist travel, i.e. one of the three basic types of nautical tourism. The Croatian - English dictionary (Filipović, Grgić, Cizey, 1998, p. 248) notes the word "cruise" and defines it as a voyage, an ocean trip (taken for pleasure). It can be local (domestic), with itinerary covering territorial waters of a single state, or international, with itinerary covering international waters of two or more countries. It takes place on the sea, rivers and lakes, and is considered part of nautical tourism since it is based on vessels and sailing.

Today, tourism is the world's third economic industry, right after oil and technical production, with the tendency to overtake the lead. Croatia is among the top Mediterranean, but also the world's tourist destinations, offering different types and forms of tourism. In recent years, cruising has become part of Croatian distinctive and recognisable offer.

Although cruising is considered to be a world phenomenon, it still represents a specific form of tourism. In recent years, due to its exceptional coast, ports and ships, Croatia has been developing cruising in the form of mini cruisers. Croatian Tourism Development Strategy until 2020 (p. 38) recognizes domestic Croatian cruising as one of the most desirable tourist products in Europe. Product quality has improved, including new ships scheduled for year-round business, while the rich and diverse offer meets the needs and wishes of tourists with distinctive tastes and requirements.

Even though the data on the current number of shipping companies and cruisers in Croatia is scarce, it is possible to create a statistical sample from which to draw general conclusions on the current situation. When searching the web for "Croatian domestic cruising", the first result offered is the term "Croatian cruise ships - Katarina-line.com." The agency is represented as one of the leading Croatian travel agencies, whose rich offer of domestic cruises makes it a good representative for an evaluation of Croatian mini cruising and its features.

Analysing the arrangements by the abovementioned agency, the travel offer can be categorized according to the main contents, most notably the following:

- Standard cruises;

Standard is a word that denotes the measure of quality accepted by the majority. In cruising offers, it denotes simple trips, visits to renowned destinations and the possibility of individual creation and exploration of offered contents.
- Tours with an emphasis on cultural, environmental and educational standards;

The concept is based on cruising to the destinations of the central and southern Adriatic, where the travellers visit a large number of beautiful islands, with preserved flora and fauna; both inhabited and uninhabited. The destinations are parts of the national parks: Kornati, Mljet, Lastovo, and Blue Cave (the island of Biševo). Sailing the beautiful archipelago of central and southern Adriatic, the visitors quickly fall in love with the picturesque small villages, sheltered coves and sea channels.
- Entertainment as the centre of the cruising tour;

This type of travel is particularly appealing to groups of young tourists; unencumbered by the level of comfort on board, or the cultural aspect of the cities. Their focus is on having fun while visiting the destinations offered, which include all the cities from the standard cruising trip, but with special focus on entertainment and night life.
- Cruising with an emphasis on sports and recreational tourism;

The moderate Mediterranean climate, diverse and well-preserved natural beauty, and the vicinity of mountain ranges with beautiful lookouts are the distinctive prerequisites for a rich offer and a successful implementation of sports activities.
- Deluxe cruising tours;

Cruising generally attracts tourists with greater purchasing power. Its popularization and the increased supply in the market lower the prices and make it accessible to a wider range of cruise enthusiasts. Those willing to pay more money for an eight-day journey by boat, enjoying high comfort on board and the inclusion of all shore excursions in the price, choose the Deluxe cruising tour for their vacation.

Cruising with an emphasis on sports and recreational tourism

Cruising with an emphasis on health, sports and recreational tourism offers several different arrangements. The five-day tour of the northern Adriatic islands is realized twice in the season, namely at the end of June and the beginning of September, and is intended for those individuals whose health conditions require morning workouts and diet food.

Those interested in long walks and hiking, choose the tours on the northern Adriatic, where they can enjoy visiting the highest peaks and the longest promenades. These destinations offer walking and hiking experiences lasting from two to seven hours, depending on the tourists' capabilities and stamina. Similar tours are also available on the islands of the southern Adriatic, taking place at the beginning or near the end of the cruising season (in April or October).

An especially prominent part of tours with recreational activities are cruising tours for bicyclists. On the Adriatic, bicycle tourism is part of cruising tourism, and can be defined as "visiting destinations by bicycle for leisure and relaxation" (Mišćin, Rigo, 2013). The main motive for these tours is the striving for a healthy life and spending time outdoors. Based on the importance and the amount of time cycling takes up during a tour, we can distinguish between passionate cyclists and those who take up cycling as only one of the activities during their holiday.

Depending on the part of the Adriatic, cycling enthusiasts can choose between different eight-day tours, adjusting the dates and prices depending on the selected destinations. The available routes, similarly to those with an emphasis on hiking, offer visits to the highest peaks that have access for cyclists.

Bicycle tourists can choose a cruising tour sailing into the ports of the North Adriatic: Opatija, Krk, Rab, Mali Lošinj and Cres, where they can take the biking trails in Punat, Vrbnik, Kamenjak hill, Straza, Komrčar Forest Park, Barbat, Palit, Tovarnele and Novalja. This tour is known as "light bike and hike."

Bicycle tourists with more stamina and physical fitness can choose the aforementioned destinations, but with a precise time schedule for cycling. Each port offers bicycle trails with a specified level of difficulty and mileage. On the island of Krk, the 16-kilometer trail (difficulty level 1) connects the city centre to Punat. The most demanding routes are on the island of Mali Lošinj where the 45-kilometer trail, marked with difficulty level 4, stretches to the fishing village Martinšćica on the island of Cres.

The eight-day cruising tour of the southern part of the Adriatic, starting with the embarkment in Split, offers visits to the ports of the island of Brač, Hvar, Korčula and Mljet, and the Pelješac peninsula. What distinguishes this tour are bike trails leading to the highest mountain peaks in the area. The most challenging, 43-kilometer track (level 5) on the island of Brač stretches from Milna to Bol, with the highest point at 570 meters above sea level. Cycling enthusiasts will equally enjoy the 33-kilometer track (difficulty level 3) on the island of Hvar, cycling from Jelsa to Starigrad.

When it comes to bicycle tourism, Croatian Tourism Development Strategy until 2020 (2013, p. 8) predicts as follows: in the European context, it is estimated that the ratio of tours with cycling as the main activity or the bicycle as the main mean of transportation will increase more than 10 percent in the next 10 years. Even more significant are the tourists that take up cycling as an important additional activity during their holiday.

The link between cruising and cycling

Although there is no statistical data on these forms of tourism in Croatia, "Strategy for the development of tourism in Republic of Croatia until 2020" puts great emphasis on their further development. Conclusions about their interconnectedness also can be drawn from the data on the age of cruiser- and bicycle tourists, published at the European level.

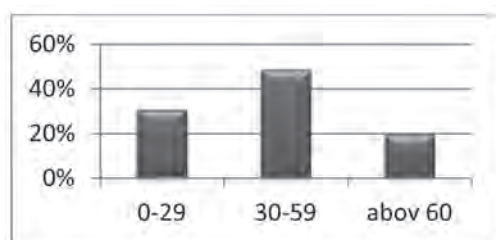

Source: By the authors according to P&O Cruises

Chart 1: The age distribution of the cruising tourist

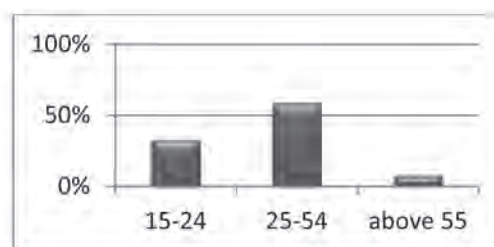

Source: By the authors according to Analysis of Cycling Potential, Policy Analysis Research Report (2010.)

Chart 2: The age distribution of the cycling tourist

Taking into account the age ranges of bicycle tourists and those who spend their holidays on cruisers, the similarities in the representation of age groups are easily discernible. The largest number of cruiser tourists (49%) is between 30 and 59 years old. 59% of bicycle tourists are within a similar age range, from 25 to 54 years of age. Comparing the tables, it can be concluded that the bicycle tourists and cruiser tourists are of similar age.

Conclusion

Several decades ago, a number of researches confirmed that an active holiday have certain advantages compared to the passive one. In Europe, travelling with cycling as the main activity or the bicycle as the main mean of transportation is expected to rise by 6 to 10% in the following years. Croatia is still not considered a “bike friendly” European country, such as Denmark, the Netherlands or Germany, but this type of tourist offer and a growing number of visitors will have a positive impact on investments in the cycling infrastructure in our country, as well as the popularization of domestic cruising and its contents. Bike tours within the cruising offer guarantee safety, ease of use, a diversity of routes and additional contents, reaching the quality level of domestic mini cruisers’ offer as a whole. The synergy of sports and cruising certainly has a bright future and could soon become one of the recognizable and distinctive features of Croatian tourism.

References

1. Analysis of Cycling Potential, Policy Analysis Research Report (2010.) /online/ <http://www.tfl.gov.uk/assets/downloads/analysis-of-cycling-potential.pdf.pdf> (14.02.2014.)
2. Auge, M. (2010.) *Pohvala biciklu*. Zagreb: Jesenki i Turk
3. Bartoluci, M., Škorić, S. (2009.). *Menadžment sportskog i nautičkog turizma*. Karlovac: Veleučilište u Karlovcu
4. Filipović, R., Grgić, B., Cizey, K. (1998.) *Englesko – hrvatski riječnik, 23. izdanje* Zagreb: Školska knjiga,
5. Katarina line /online/<http://www.katarina-line.com/cruises/bike-cruises/light-bike-hike-cruise-departures-from-opatija.html> (29.01.2014.)
6. Ministarstvo turizma Republike Hrvatske: *Strategiji razvoja turizma RH do 2020*. Zagreb
7. Mišćin, L., Rigo, R. (2013.) *Biciklistički turizam, potencijalni generator razvoja turističkih destinacija Hrvatske*, Eko etno trade show, Zagreb
8. P&O Cruises /online/ <http://www.pocruises.com.au/aboutus/pages/default.aspx> (14.02.2014.)
9. Relac, M., Bartoluci, M. (1987). *Turizam i sportska rekreacija – organizacija i ekonomika sportsko – rekreacijskih sadržaja u turizmu*. Zagreb: Informator.

INFLUENCE OF STEP LENGTH AND STEP FREQUENCY ON ENERGY CONSUMPTION WHILE WALKING ON THE INCREASE

Dražen Harasin and Petar Martinec

Faculty of Kinesiology, University of Zagreb, Croatia

Abstract

The aim of this study was to determine the difference between the energy consumption between the normal step length in walking on the rise and energy consumption in a shortened or prolonged length of steps in walking on the rise. The measured values of energy consumption in walking on a rising slope 12% rate of 5km/h, for a period of 10 minutes, 20% shorter stride length than normal and 20% increased length of steps differ from energy consumption at normal walking stride length. Based on the results of t-test can reject the hypothesis that changes in the length and frequency of steps will not affect the increase in energy consumption while walking on the rise. In line with this, the results of this study suggest that the most cost-effective steps to walk normal length.

Key words: *mountaineering, hiking, military, survival in nature, energy consumption*

Introduction

Walking is moving in an upright position, which is characterized by a series of uniform and alternating movement of legs, arms and torso. Since walking is certainly the most elementary form of motion with the aim of moving the body of a man in space, the subject is of interest to practitioners and researchers in different fields of science kinesiology and practices. Walking is one of the group of disciplines of athletics, and then talk about sports that walking is a specific way defined by the rules of the sport and the athletes sporting technique. As a form of motion that activates the muscles of the whole body, walking is a content interesting fitness trainers who want to give their athletes to develop aerobic capacity and durability. In particular, the development of these skills suitable walking on the rise, where, depending on the slope, you need to do a much bigger operation than when walking on the flat. Walking is a very important movement to hikers where walking is an integral part of the basic techniques of the sport. What mountaineer has better technique, there are more chances to successfully overcome climb and reach the top of the mountain. As the main method of moving a man walking in the area is interesting and every professional person (such as a professional soldier) that your body and various equipment must move in space, but also to each other, "ordinary" man who effectively must move your body or objects in nature (for example, a person who survives in nature). While walking in the fitness practice is not greatly important efficiency techniques anyway because the goal was to work at a higher load (it is only important that the technique is optimal compared to fewer opportunities for injury), when walking one professional soldiers, hikers, or the person who survives nature is extremely important to the efficiency of the techniques of walking. A better technique of walking with a professional soldier can mean a safer and easier to arriving at a certain elevation, and better concentration and access to more energy at the point must perform the task, mountaineer efficient walking technique can mean winning the top of the mountain, and the person who survives in nature effectively walking can mean staying alive. This is particularly evident in walking on the rise and walk with a large load when energy consumption is very high. And a smaller contribution to the development of techniques of walking would increase the efficiency of movement and action in these situations. During walking on a greater or lesser rising the changes in the position of the human body in relation to stroke on the flat (Lovejoy, 2005). To the man who walks on the rise remained in equilibrium position he must make compensation tilting forward fuselage (McIntosh at all., 2006). On this occasion, the center of gravity of the human body moves forward. The size of this shift depends on the rise, which is steeper climb by which the walk has to be bigger and shift the center of gravity forward and thus larger tilt forward fuselage. Result of tilting the hull forward and causes other changes in the structure of the steps, especially the changes in the movement of the lower limbs. The angle of inclination of the pelvis is higher in walking on rising than when walking on the flat. Increases and flexion of the hip, the knee joint, and are larger and motion in the joints and feet to the dorsal flexion and plantar flexion. Larger thigh lift at normal length of steps in walking on the rise leads to greater weight acting legs and shoes on the leg muscles to perform work (compared to less lifting legs in step).

It is assumed that the retention of normal step length when walking by the rise or even increasing step length because this led to greater fatigue. Larger shifts in the hip joints oppose the resistance of clothing (cut and clothing materials) which requires a larger operation at greater than raising the thigh at a smaller raise thigh. These changes in the structure of the steps open primary research question: Can a man by reducing the length of steps and increasing the frequency or increasing step length and step frequency by reducing the impact on energy consumption while walking at the same speed at the

same ascent. The aim of this study was to determine the difference between the energy consumption between the normal step length in walking on the rise and energy consumption in a shortened or prolonged length of steps in walking on the rise. Working objective of this study will be tested hypothesis H0: Energy consumption in the ten minute motion by the rise (12%) at the same speed (5 km/h) will remain unchanged regardless of changes in the length and frequency of steps.

Methods

The study included eight male subjects, aged 25-30 years, moderately active mountaineers. The subjects were healthy with no injuries or illnesses that could affect the implementation of the experiment. The variables of this study were: heart rate at rest (HR0), the average heart rate during normal walking stride length (HR1), the average heart rate while walking 20% greater length steps (HR2), the average heart rate while walking 20% smaller length steps (HR3), energy consumption during normal walking stride length (EC1), energy consumption while walking 20% greater length steps (EC2), energy consumption while walking 20% smaller length steps (EC3). Table 1. presents the data on the respondents who participated in the study.

Table 1: Details of the respondents who participated in the study, height (cm), weight (kg), age, normal stride length (SL) (cm), pulse rate at rest (HR)

Ispitanik	Visina	Težina	Dob	LS	HR
1	176	76	26	63,6	71
2	183	75	30	63,8	65
3	178	72	29	61,5	66
4	179	73	25	65,3	75
5	177	82	28	64,1	65
6	181	75	28	57,5	55
7	180	74	26	62,8	72
8	181	77	27	63,3	69
MEAN	179,6	75,5	27,4	63,5	67,3

The normal step length is defined as the average of the ten steps that respondent made walking on the flat. This length is added to 20% of the length of variable length greater steps or seized 20% of the length of the variable length reduced steps. Step length is limited to rubber, which is attached to the legs of the respondents so that their tension is a measure necessary step length and simultaneously prevents increase in step length. Calculation of energy consumption was performed based on the value of the average heart rate, duration of activity, and the age and weight of the respondents, the equation to calculate the energy consumption during submaximal exercise intensity that is derived by Keytela and associates (Keytel et al., 2005th). The relationship between heart rate and energy consumption is not considered to be reliable under exercise intensity that is less than 41% of VO₂max, respectively, which is less than 64% of maximum heart rate (Swan et al., 1998th). To test the hypothesis using the t-test for paired samples package for statistical data processing STATISTICA 7. Acceptance threshold hypothesis was $p < 0.05$.

Results

Table 2 shows the values obtained for each variable.

Table 2: The values of heart rate during normal walking stride length, and 20% higher and 20% lower length of steps, calorie consumption during normal walking stride length, 20% lower step length, and 20% higher than normal step length

Ispitanik	HR	HR1	HR2	HR3	EC1 (kcal)	EC2 (kcal)	EC3 (kcal)
1	71	137	140	142	124	128	131
2	65	125	128	130	107	112	115
3	66	144	145	147	134	135	138
4	75	126	145	149	126	134	140
5	65	155	157	162	155	158	165
6	55	139	143	146	127	133	138
7	72	131	134	138	114	118	124
8	69	135	137	141	122	125	131
MEAN	67,3	136	141	144	126	130	135

After the data obtained for heart rate and energy expenditure was carried out t-test for paired samples. T-test for paired variables are shown in Table 3. and Table 4.

Table 3: Showing results of t-test for paired variables energy consumption during normal walking stride length and 20% shorter length of step

Variable	MEAN	Std.Dv.	N	Diff.	Std.Diff.	t	df	p
EC2	130,375	13,783						
EC1	126,125	14,297	8	4,25	2,1213	5,6667	7	0,000761

Table 4: Showing results of t-test for paired variables energy consumption during normal walking stride length and 20% greater length steps

Variable	MEAN	Std.Dv.	N	Diff.	Std.Diff.	t	df	p
EC3	135,25	14,6165						
EC1	126,125	14,297	8	4,875	1,642081	8,39702	7	0,000067

Discussion and conclusions

After examining the results obtained can be observed an increase in heart rate when walking normal step length on the rise compared to the heart rate at rest. This increase is expected to 51%. Furthermore, one can observe an increase in heart rate of 2.04% for a shorter walking stride length in relation to heart rate during normal walking stride length. This increase was in line with expectations. Also notable is the increase in heart rate of 4.23% with 20% more walking the length of steps in relation to heart rate during normal walking stride length. This increase in heart rate with increasing length of walking steps was expected. Thus, it is possible to notice that the increase in heart rate when walking by default rising long stride though larger than walking pace shorter compared to walking on the rise at the normal step length. These data, and increasing the heart rate and with shorter steps, not fully anticipated. The obtained results show an increase in energy consumption when there is a change in the length of the steps in relation to the movement of a normal step length. The increase comes in shortening and extension in steps, however, there are differences in the amount of increase in energy consumption. When walking by default rising 20% shorter length of steps leads to an increase in energy consumption of 31.3% compared to walking on the upswing normal step length. When walking on the rise 20% greater length of steps leads to an increase in energy consumption for 6.77% compared to walking on the upswing normal step length. Although the expected decrease in heart rate and energy consumption reduction step length and increasing the heart rate and energy consumption increased step length, at least partly results indicate the correctness of reasoning outlined in the introduction to this work. Expected increased power consumption when walking greater stride length for greater action weight feet and footwear, as well as greater resistance of clothing that challenges the muscles to perform work in relation to the lower leg raise in turn. The measured values of energy consumption in walking on a rising slope 12% rate of 5km/h, for a period of 10 minutes, 20% shorter stride length than normal and 20% increased length of steps differ from energy consumption at normal walking stride length. Based on the results of t-test can reject the hypothesis that changes in the length and frequency of steps will not affect the increase in energy consumption while walking on the rise. In line with this, the results of this study suggest that the most cost-effective steps to walk normal length. This now should be taken with a grain of salt, because of the following. Windchill subjects such that they were the hardest to walk the length of a small step. This indicates that for shorter step length may applied short stride length. It is possible to make more optimal shorter length was 10% or 15% shorter than the normal length. Results would probably be different if the measurement was performed when walking on the rise with 5%, 10%, 15%, 20% 25% and 30% smaller step width, and from 5%, 10%, 15%, 20% and 25% 30% higher than normal step length at the same rise and same speed of movement. This analysis to determine the optimal stride length for walking a certain speed at a certain rise. In order to obtain practically useful result, this would be the length of the steps to be put in relation with the height of a man. Also, in the next experiment of this kind, as far as possible should standardize shoes and clothes that will be used in the experiment, in order to effect the cut pants, the material from which they are made and the weight of shoes as much as possible.

References

1. Dugandžić, M. (2012) Biomehanika hoda. (Diplomski rad) Zagreb: Kineziološki fakultet Sveučilišta u Zagrebu.
2. Keytel, L.R., Goedecke, J.H., Noakes, T.D., Hiiloskorpi, H., Laukkanen, R., van der Merwe, L., Lambert, E.V. (2005) Prediction of energy expenditure from heart monitoring during submaximal exercise. *Journal of sport science*. 2005, Mar, 23(3):289-97.
3. Lovejoy, C. (2005) The natural hosty od human gail and posture. *Gaiz and posture*, 21 (2005), 95-112.
4. McIntosh, A.S., Beatty, K.T., Dwan, L.N., Vickers, D.R. (2006) Gait dynamics on an inclined walkway. *Journal of Biomechanics*, 39 (2006), 2491-2502.
5. Medved, V., Kasović, M. (2007) Biomehanička analiza ljudskog kretanja u funkciji sportske traumatologije. *Hrvatski športskomedicinski vjesnik*, 221), 40-47.
6. Swain, D.P., Leutholtz. B.C., King, M.E., Haas, L.A., Branch, J.D. (1998) Relationship between % heart rate reserve in treadmill exercise. *Medicine and science od sport and exercise*, 1998, Feb., 30(2):318-21.

FUNCTIONAL ABILITIES IN WOMEN OF DIFFERENT AGE

Milena Mikalacki, Sandra Vujkov, Nebojsa Cokorilo and Darinka Korovljević

Faculty of Sport and Physical Education, University of Novi Sad, Novi Sad, Serbia

Abstract

Purpose: to determine the level of functional abilities in 36 women of different age, moderately physically active. Furthermore, to compare results with known parameters of aerobic capacities for gender and age, as well as to determine differences according to age of subjects.

Methods: subjects were divided according to age in three groups: N=9 (age 30-40), N=12 (41-50) and N=15 (age 51-65). Treadmill Bruce protocol with gas analyzer is used for measuring parameters of aerobic capacity.

Results: Statistically significant differences in parameters of aerobic capacities in women of different age were found with Manova and Anova in all three groups $p=0.001$.

Conclusion: in most applied variables, subjects of two younger group of women were found statistically better than the eldest group of subjects, as expected.

Key words: ageing, Bruce, aerobic capacity, moderate physical activity

Introduction

Physical activity (PA) is an essential component of a healthy and quality lifestyle, although there is a marked trend of decrease in PA of people in modern civilization. It is well known that the application of a dosed and regular PA has preventing effects in risks of cardio-vascular disorders, obesity, in fighting against cancerous diseases, diabetes, osteoporosis, stress, anxiety, depression and other disorders of modern civilization (Medved, 1980; Mišigoj-Duraković et al., 1999; Oman & Oman, 2003). Studies show that application of moderate PA reduces the risk of cardiovascular disease by 20%, and in people who are physically more active up to 27% (Lee et al., 2003; Williams et al., 2002).

Aerobic capacity represents best-accepted functional measure of cardiovascular system by physiologists. Commonly used indicators of aerobic fitness evaluation are absolute and relative oxygen consumption (VO_{2max} ml/min; VO_{2max} ml/min/kg), whereas, in assessing the intensity of exercise, maximum heart rate expressed as a percentage is commonly being used. Regular and directed physical activity can contribute to the improvement of cardiovascular fitness (ACSM, 2005). This improvement is reflected in the increasing ability of the heart and the rest of the cardiovascular system in the execution of their most important task - providing a sufficient amount of oxygen and energy to body (Tanaka et al., 2001). It has been determined that persons with higher aerobic capacity, with the same amount of oxygen consumption, has a lower heart rate values due to lower load of cardiovascular system.

Dynamic parameters of lung capacity are measured in order to investigate the ability of airflow to the lungs and the external environment. FVC (forced vital capacity) represents the amount of air that can be ejected from the lungs with maximal expiration after a maximal inspiration. When FVC (l) is correlated with depth of inspiration during exercise, we can receive valuable information on utilization of person's capacities during load. In other words, we can calculate ones percentage of lung capacity exploitation during exercise. The second dynamic parameter FEV1 is the amount of air that is ejected in the first second of forced expiration. This parameter can clearly be used to detect possible obstruction or limitation of the respiratory system, especially if it occurs only under load (Dikić, 2004). From adolescence through adulthood and to old age, female body goes through a number of different phases, which are mainly biologically caused (Mišigoj Durakovic, 2006). Aerobic fitness typically reaches its peak between 15 and 20 years of age, and after that, in healthy sedentary adults of both genders, this aerobic ability gradually decreases at approximate rate of 10% per decade (Heath et al., 1981; Buskirk i Hodgson, 1987; Tanaka et al., 1997; FitzGerald et al., 1997; Eskurza et al., 2002; Pimentel et al., 2003).

The aim of this study was to determine the level of functional abilities of women of different ages who are moderately physically active. Furthermore, authors wanted to compare the results obtained in this study with the standard norms of aerobic capacity indicators as well as to determine whether there are statistically significant differences in functional abilities between the subjects regarding their age. In line with previous research, it is assumed that there are differences in functional abilities of subjects, but considering that the analyzed sample of respondents practiced overall for one year, the authors wanted to know whether there has been a certain deviation compared to previous studies.

Material and methods

The subject sample was made of 36 women, averaged age 47,14±9,24 years, that were divided in three groups according to their age: 30-40 years (N=9), 41-50 (N=12) and 51-65 (N=15). The subjects were engaged in regular physical activity twice a week for 60 min in the last year continuously, conducted at the Faculty of Sport and Physical Education, University of Novi Sad. This targeted physical activity included Pilate's classes and combined training of Pilates and Aerobics. For gaining data on functional abilities, subjects underwent spiro-ergometric measurements in scientific laboratory of the Faculty. Dynamic parameters of lung function were measured over forced vital capacity (FVC) and forced expiratory volume in first second (FEV1), on the PFT Suite spirometer (Cosmed, Italy). Afterwards, subjects underwent Bruce protocol exercise test on the treadmill bar (T 1700), during which was measured all relevant ventilation parameters. Test was performed until voluntary exhaustion. Heart rate values were recorded with HRmonitor (Polar Vantage NV, Polar Electro, Finland).

Basic statistical descriptive parameters were obtained for each measured variable. Differences in functional abilities in female subjects of different age were determined through multivariate and univariate analysis of variance. The level of significance was set up at $p < 0.05$ and $p < 0.01$. The results are presented in tables.

Results

Descriptive statistics for entire sample are presented in Table 1. The distribution of the results for entire sample in most of the applied variables show a notable flattening curve, as indicated by a greater range of scores. This is probably a consequence of the heterogeneity of the sample subjects. However, there were no significant deviations from normal distribution of the applied variables.

Table 1: Descriptive statistics for overall sample

Variable	Min	Max	Mean	SD	Skew	Kurt
Age (years)	26.00	61.00	47.14	9.24	-.42	-.63
Height (cm)	154.00	184.00	166.54	6.75	.37	.39
Weight (kg)	46.50	77.50	64.65	6.30	-.53	.98
Total duration of test (min.sec)	3.31	10.10	7.16	1.89	-.17	-.70
Maximum achieved speed on test (km/h)	4.00	6.80	5.53	1.00	-.24	-.89
Maximum achieved Heart Rate (bpm)	143.00	194.00	173.75	13.90	-.95	-.08
HR at Maximum oxygen consumption (bpm)	139.00	189.00	168.50	14.65	-.72	-.57
HR at first minute of recovery (bpm)	110.00	182.00	154.42	15.27	-.94	1.46
Relative oxygen consumption (ml/min/kg)	20.37	41.42	28.15	5.48	.75	.12
Absolute oxygen consumption (l/min)	1.21	2.52	1.81	.32	.26	-.47
Forced Vital Capacity - FVC (l).	2.17	5.55	3.74	.66	.57	1.53
Forced Expiration Volume in 1 second – FEV1 (l)	1.41	4.52	3.02	.65	.36	1.06

Legend: Min-minimum values, Max- maximum values, Mean- mean values, SD - standard deviation, Skew – skewness, Kurt – kurtosis

Analysis of variance showed statistically significant differences of the entire space of applied variables between group of subjects ($F=3.023$), $p=0.01$. Analysis of differences between groups according to three different age-range (Table 2) shows that there are statistically significant differences in functional indicators at level $p=0.01$. A total of 48.2% of the variability between groups is caused by differences in the age of the respondents. Statistically most significant differences were observed in the variables: Total duration of test, HR at Maximum oxygen consumption, Maximum achieved Heart Rate, Forced Expiration Volume in 1 second ($p < 0.01$) and Forced Vital Capacity ($p < 0.05$). In most of applied variables, respondents of two younger age groups were significantly better than the eldest categories of respondents, as expected. Such differences, although not at a statistical significant level, also occurred in: HR at first minute of recovery Relative and Absolute oxygen consumption.

Table 2: Analysis of differences between subjects of different age groups

Variable	Group range	Mean	SD	f	p
Total duration of test (min,sec)	30-40	8.19	1.67	10.68	.00 ^a
	41-50	8.11	1.66		
	51-65	5.78	1.29		
Maximum achieved Heart Rate (bpm)	30-40	181.78	10.49	6.02	.01 ^a
	41-50	178.00	12.05		
	51-65	165.53	13.31		
HR at Maximum oxygen consumption (bpm)	30-40	176.78	10.63	6.87	.00 ^a
	41-50	173.75	11.71		
	51-65	159.33	14.37		
HR at first minute of recovery (bpm)	30-40	158.22	18.40	2.81	.07
	41-50	160.00	13.11		
	51-65	147.67	13.03		
Relative oxygen consumption (ml/min/kg)	30-40	29.85	6.23	2.03	.15
	41-50	29.51	6.23		
	51-65	26.04	3.76		
Absolute oxygen consumption (l/min)	30-40	1.82	.24	2.17	.13
	41-50	1.94	.34		
	51-65	1.69	.31		
Forced Vital Capacity - FVC (l)	30-40	4.24	.74	4.38	.02 ^b
	41-50	3.69	.47		
	51-65	3.49	.60		
Forced Expiration Volume in 1 second – FEV1 (l)	30-40	3.56	.58	6.22	.01 ^a
	41-50	3.00	.57		
	51-65	2.71	.57		

$$F = 3.023 \quad P = 0.001 \quad \text{Partial } \eta^2 = 0.482$$

Legend: ^a statistically significant $p < 0.01$; ^b statistically significant $p < 0.05$; Mean – mean values; SD – standard deviation; F – multivariate test; f – univariate test; P – alpha level of significance; Partial η^2 – effect size

Discussion

This research has been conducted on the sample of 36 female subject, different age groups that were included in prescribed PA two times per week for 60 minutes. The goal was to determine differences in functional abilities according to their age group. When observing obtained results in total duration of the test, it is evident that non of respondents in all three groups finished the test and arrived at the end applied protocol, while the eldest group of respondents (50-65 years) showed the worst results in comparison to the other two groups ($5.78 \pm 1, 29$). During the load test execution on a treadmill, there were some shortcomings identified that could be attributed to the poorer results of older group of women compared to younger ones. It was notable that older respondents had less experience in running on a treadmill, and therefore lack a certain routine during the run was noted.

Furthermore, differences occurred in maximum heart rate and heart rate at maximum oxygen uptake where the results showed values of HR 181.78 ± 10.49 ; 178.00 ± 12.05 and 165.53 ± 13.31 , respectively. Physically active women are showing a lower rate of decline in values of maximum heart rate during aging, however despite regular exercise, these values inevitably decline. This decline in heart rate values with age might be explained with a weakening of the heart stroke volume and the arterial-venous oxygen differences in the course of the aging process. Decrease in arterial elasticity and reduction of left ventricular (Julius et al., 1967; Rivera et al., 1989; Tanaka et al., 2001; Ehsani et al., 2003), increased amounts of connective tissue, as well as an increase in total peripheral resistance and a higher blood pressure. Consequently, heart has to work more to the same amount of blood pumped (Skinner, 1993). These facts represents the main reasons for decline in hear rate over the years. Results obtained in this research are in line with some previous studies (Ogawa et al., 1992; Mišigoj – Duraković, et al., 1999; Jacob – Johnson et al., 2001; Petrella i Paterson, 2004; Fleg et al. 2005; Mišigoj–Duraković, 2006; Zoller, 2008). Even though measurements of lung functions are not commonly used parameters in assessment of functional abilities, it has been proved that respiratory system can represent limiting factor during exercise, especially in elderly people. For young and healthy people, is common that up to 85% of FVC can be exhaled in first second (FEV1), whereas these values are about 70% in elderly. Subjects in first age group had values of FEV1 of 81%, while third age group

of women had their FEV1 results at 77%. Although statistically significant differences in FVC and FEV1 in subjects of different age groups emerged, these values are in normal range for age and gender. No statistical differences are showed in parameters of oxygen consumption, as an indicator of aerobic capacity, between groups in respect to age. However, if these results are compared with reference values from the World Health Organization, by Heyward (2006), respondents of all three age groups observed, were characterized by the average results of aerobic capacity.

A transversal study on functional abilities of women different age groups was done on a small number of subjects, which certainly presents a limiting effect of this research. The inclusion of a larger number of subjects per group, in addition to monitoring the effects of prescribed physical activity, and comparing results with sedentary group of women of the same age would certainly give clearer information on the functional abilities for women of different age groups in this region.

Conclusion

The decline in aerobic capacity could be reduced, and significantly slowed down, with systematic application of prescribed physical activity. Average values of relative oxygen consumption of the respondents obtained in this research could be attributed to a shorter duration of weekly activity than recommended. The recommendations for PA are for at least 5 times per week for 30-60 minutes, with additional strength training 2 times per week (Leon et al., 2005). PA should last for 150-180 minutes per week, in addition to individual adjustment to intensity. Intensity should be moderate. Recommendation for exercise intensity is 60-85% of maximum heart rate (ACSM, 2005).

The results of this study indicate the need for continued exercise of moderate aerobic activity, as well as monitoring their effects in order to improve the health and quality of life, as well as reducing the risk of cardiovascular disease in women of this region.

Acknowledgment

The research was completed through the funding of the Municipal Secretariat for Science and Technological Development as a part of the project called "The Influence of Physical Activities on the Risk Factors of Working Population" (114-451-2337/2011-01). We express our gratitude to all the participants for taking part in the research.

PHYSICAL ACTIVITIES VERSUS SEDENTARY SOCIETY: CZECH CONTEXT

Aleš Sekot

Faculty of Sport Studies, Masaryk University, Brno, Czech Republic

Abstract

Physical activity of people plays increasingly growing role in scientific interest regarding way of life of contemporary society and it is very important factor in the process of officiating of the level of healthy and active life style, quality of life and health in general. Indispensable role of physical activity in the course of human life is permanently scientifically confirmed also in context of prevention of obesity.

Purpose: The development of a sedentary life style is the result of a socialization process towards physical inactivity developed in youth and continued into adulthood. In this context we are involved in research of the tendency of growing tendency in our cultural setting: People are more and more individualized, involved in passive way of life lacking proper level of physical activities and active sport. **Methods:** To be properly informed on the level and relevant tendencies relating physical activities in Czech society we are searching for some preliminary data on physical activity of Czech population in description of specific relation of sport and sedentary society. **Results:** The Czech Republic is on the level of mass sport strongly influenced with the existence of new development of the city structure, including fitness centres, cyclo paths, roller skates stadiums, beach volleyball playing fields, golf courses. In general Czech people are typical part of European sedentary society **Conclusions:** The paper is concentrated on the question what Czech society expects from sport in given context of existing tendencies in mutual relation of sport and society.

Key words: *Physical activity, sport, obesity, sedentary society, socialization, built environment, nutrition*

Introduction

We are living a time when society, culture and science have become increasingly aware of the great importance of sport not only as a part of mass culture, but broadly understood, for individual and social health and well-being. Significant changes in the composition of the workforce transferred the economic and the social roles of men and women, but also affected matters of health, attitudes to physical activities and sport (McElroy, 2002). This new way of “public matters provision” started at the beginning of the 1990s and culminated in the period of 2000-2002. It is evident that for example given municipalities are differing by their geographical position and appearance, the number of inhabitants and their socio-economic characteristics and economic development: But the evident is: The sport policy making is not yet a common standard. (Slepičková, Staněk, 2007).

To summarize situation of *sport versus local authorities* in the Czech Republic the *financial limitations and political priorities* play very important role, as well as professional competence and personal preferences of particular councilors. The approach of the individual town areas to sport is very different and there are often original public policies in this field. A very diverse approach is also seen in the field of maintenance and development of the sports infrastructure and its utilization. In almost all of parts of the Czech Republic, the great importance is on renovation of school facilities. However, the access of the general public to the sport facilities often collides with the clearly commercial use of the facilities (Staněk, Flemr, 2007, 294-297).

The aim of the research is rooted in better understanding of specific features of way of life of our sedentary society in relevant context of proportion of physical activities in a broader frame of active life style and quality of life.

Materials and methods

To discuss crucial topic “Physical activities in the Czech sociological perspective” means to present some relevant research data on physical and sportive activities of Czech population. Above all, we must remind fundamental feature of *sedentary society*: strong *declination of physical activities in most professions, at home and in transportation*. Presented data and discussion reflect preliminary results of representative sociological research of 1 117 Czech adult respondent of all socio-economic strata, using data analysis of questionnaire on intensity of physical activity in work, leisure and personal transportation.

People prefer, in general, *passive form of leisure*, watching sport rather than doing sport. The sedentary living beset contemporary Czech society, as identically U.S. and plenty of European societies too. In such situation we are more and more confronted with pressing questions: “Why do people who know they should be more physically active still fail do so? What form the obstacles to achieving a more physically active lifestyle? And very pragmatic question is brought up to date: Is it in sedentary postmodern virtually oriented life possible to transform contemporary people into a more physical active society? Is it possible to overcome persistently questioned limitations found in many of the traditional approaches to promoting physical activity? Are we able to work effectively on the way of innovative strategy to increase physical activity at home, at school, and within the community” (Sekot, 2008)?

Results

Presented structure of attitudes to sport activities reflects given social and cultural situation in Czech post-reformation setting: People are not consistent enough to overcome their *laziness*, are too much busy, too much involved in everyday economic problems, not properly appreciated and enjoying refreshing impact of regular physical activities compensating many-sided stress of societal life. But we also take into account the fact, that people are prone to declare an absence of leisure as substitutional reason.

Relevant *recommendations* regarding physical activities in Czech context are accenting the need to prepare and to realize self-contained programs for active recreational sport for all groups of population and within school teaching of physical education contribute to long-life interest in active physical activities (Frömel, Bauman et al., 2006, p. 21). In addition it is necessary to mention that 2 hours of physical education per week for pupils and students is not resolutely enough. Also young people are recommended for active participation in tourism, recreation and sport, as the foundation of physical culture. Physical education in its humanistic version is understood as “an education of man for the care of the body”.

The research organized by Masaryk university, Brno “*Physical activity in the perspective of physical activity of Czech inhabitants*” being now in progress in the perspective of preliminary research data on sportive and physical activity in context of fundamental demographic indicators: sex, age, education, nature of occupation and domicile.

Table 1: Intensive physical activity during last seven days

		No activity	Less than 1 hour	1 - 3 hours	3 - 6 hours	More than 6 hours
sex	men	7,33%	19,21%	34,85%	18,81%	19,60%
	women	9,64%	28,27%	35,46%	14,87%	11,44%
age	18 - 29	6,10%	21,95%	35,37%	17,99%	18,60%
	30 - 39	8,43%	24,52%	34,10%	18,77%	14,18%
	40 - 49	9,33%	20,73%	40,93%	16,58%	12,44%
	50 - 59	5,44%	25,17%	37,41%	14,97%	17,01%
	60 - 69	14,06%	31,25%	28,91%	12,50%	13,28%
	70 - more	16,67%	28,33%	28,33%	13,33%	8,33%
Education	No education	0,00%	0,00%	0,00%	100,00%	0,00%
	Elementary	8,57%	40,00%	22,86%	8,57%	20,00%
	Workmen	14,17%	19,17%	32,50%	15,83%	17,50%
	High school	8,63%	23,01%	35,62%	17,48%	15,04%
	University	7,10%	25,44%	36,49%	16,57%	14,40%
Total		8,52%	24,22%	35,25%	16,68%	15,16%

Absence of physical activity decline in the course of senior age, most physically active are youngest respondents. Workmen are most physically active; high school and university educated are in this respect comparable; physical inactivity is typical for elementary educated respondents.

Question No. 2: Regular daily walking in hours

		No one	One hour	1 - 3 hours	3 - 6 hours	More than 6 hours
Sex	men	1,19%	28,91%	36,83%	23,56%	9,50%
	women	0,65%	18,14%	41,83%	24,84%	14,38%
age+	18 - 29	0,30%	19,82%	42,99%	24,70%	12,20%
	30 - 39	0,77%	22,99%	36,78%	26,82%	12,64%
	40 - 49	1,55%	25,39%	39,90%	22,80%	10,36%
	50 - 59	0,00%	24,49%	38,78%	21,77%	14,97%
	60 - 69	1,56%	21,88%	35,16%	28,13%	13,28%
	70 - more	3,33%	31,67%	43,33%	13,33%	6,67%
education	No education	0,00%	100,00%	0,00%	0,00%	0,00%
	Elementary	2,86%	25,71%	31,43%	22,86%	17,14%
	Workmen	0,00%	21,67%	30,00%	26,67%	21,67%
	High school	1,55%	21,68%	40,04%	23,67%	13,05%
	University	0,39%	24,06%	42,21%	24,46%	8,88%
Total		0,90%	22,96%	39,64%	24,30%	12,20%

Particular data of presented research supported hypothesis on growing popularity of leisure physical activities of more educated people, high level of preference of walking in senior age groups and general tendency to sedentary occupations and professions.

Discussions

Physical activity is a complex behaviour. Any activity can be described in terms such as intensity, frequency and duration, and these dimensions must be considered. An assessment methodology should also consider inactivity, such as time spent sitting. *Physical activity can be related to work, transportation, home and leisure time.* The activities at either of these domains may have specific health consequences, and advanced monitoring should also consider there. To present the most important results of above mentioned existing research data it is possible to conclude:

Growing age of population (men and women too) decreases number of week days and volume of time devoted to physical activity.

1. Men in general are more involved in physical activities comparing with women.
2. Growing age decreases existing differences in intensity of physical activity between men and women.
3. Medium level of physical activity and walking is distributed in age groups and gender groups relatively evenly.
4. Walking and cycling as personal active way of transportation to work is most popular in rural settings.
5. Young people of age 18 – 28 are interesting in walking and cycling predominantly as specific way of leisure sportive activities.
6. Walking is most frequent form of physical activity in Czech population.
7. Regular monitoring of level and tendencies of physical activity of population is integral part of monitoring of health situation and life style of population.

Conclusions

To discuss a phenomenon of physical activity means in such perspective to accent changing nature of lifestyles and leisure time activities that have adopted new forms, contents and meanings. The world of sport and physical activities is also changing all the time in numerous new sport disciplines and activities which are chosen by growing proportion of people. It could be expected that these changes would affect also the socialisation situations and environments of physical activity:

1. Presented structure of *attitudes to sport activities* reflects given social and cultural situation in Czech post-reformation setting: People are not consistent enough to overcome their laziness, are too much busy, too much involved in everyday economic problems, not properly appreciated and enjoying refreshing impact of regular physical activities compensating many-sided stress of societal life. Relevant data in general reflects in Czech population *growing tendency of passive attitudes to sportive activities.*

2. Phenomenon of physical/sportive activity is many-sided phenomenon connected with the concept of a *healthy life style*. Life style behaviours in general are significantly determined by social status, by professional position, by amounts of money and the quantity of property. Unhealthy behaviours, including sedentary lifestyles, are influenced by people's position within social groups and broad social forces in the general society.
3. *Recommendations to sport organizations* for the systematic promotion of physical activities needs full support of local, regional and national public authorities:
 1. To develop a membership strategy to include physically passive persons to sportive activities.
 2. To specify the profile target of sport clubs with accordance to focus on elite and competitive sport or recreational leisure sport activities.
 3. To improve coach and trainer standards of an inclusive social and pedagogical climate.
 4. To accent natural outdoor activities as grass roots centres for mass involvement in physical activities.
 5. To ensure and to enable high educational and pedagogical standards of voluntary and (semi)professional staff in sport clubs.
4. Phenomenon of physical activity and sport is closely related to *urbanisation of sports facilities*. In such context it is useful to describe and analyse the most important milestones in the history of city-planning (urbanisation) in the area of sport facilities. In this context new cyclopaths and walking areas are welcomed as an indispensable and very supportive means of active way of life from the perspective of healthy physical and sportive activities. The most critical policy area on physical/sportive activity is the sole fact of *sedentary nature* of contemporary society: Very high level of prestige of sport and sportive activities in Czech society is incompatible with very low level of practical regular physical or sport activities.

References

1. Formánková, S. (1998). Některé oblasti longitudinálního výzkumu zájmu žáků o pohybovou aktivitu. *Celostátní vědecká konference s mezinárodní účastí v oboru kinantropologie*. Olomouc: Hanex.
2. Fořt, P. (2004) *Stop dětské obezité*. Praha: Ikar.
3. Frömel, K. et al. (2004). Physical activity of men and women 18 to 55 years of age in Czech Republic. In: F. Vaverka (ed). *Movement and Health*. pp. 169-173. Olomouc: Univerzita Palackého.
4. Frömel, K. and bauman, A. et al. (2006). Intenzita a objem pohybové aktivity 15-69 leté populace České republiky. *Česká kinantropologie*. Vol. 10, č. 1, c. 13-27.
5. Mcelroy, M. (2002). *A Social Analysis of Inactivity*. Champaign, IL: Human Kinetics.
6. Project No. 044291 "Prevention of Obesity in Europe - Consortium of the prevention of obesity through effective nutrition and physical activity actions - EURO-PREVOB. (2008)
7. Rychtecký, A. (2007). Active Lifestyles of Young People – Benefits and Outcomes. *Obesity in Europe. Young People's Physical Activity and Sedentary Lifestyles*. Berlin, Oxford: Peter Lang. p. 199 - 218.
8. Rýgl, P. (2006). Tvorba školních vzdělávacích programů pro oblast tělesné výchovy na základní škole. *Česká kinantropologie*, Vol. 10, no. 2, pp. 29-45.
9. Říhová, M., Skálová L., Komárek, L. (2007). Health Behaviour of Young People. *School and Health 21*. p. 125-139. Brno: Masarykova univerzita a Paido.
10. Rzewnický, R. (2003). *Health Enhancing Physical activity. Measurement and determinant of daily activity at home, work, travel, and leisure*. Leuven: KU Leuven.
11. Sekot, A. (2006.) *Sociologie sportu*. Brno: Masarykova univerzita a Paido.
12. Sekot, A. (2008.) Physical Activity Versus Obesity. *Educatio Artis Gymnasticae*. vol.3, no. 3, p. 51 - 72 slepičková, i., Staněk, M. (2007). The impact of public administration reform on sport policy in Czech Republic. *Local Sport in Europe*. 4th eass Conference Proceedings.
13. Staněk, M., Flemr, L. (2007). The role of local authorities of Czech cities in support of sport: A case study of the capital city of Prague. *Local Sport in Europe. EASS 4th Proceedings*.

WELLNESS PROGRAMMING FOR OLDER ADULTS

Jana Stará and Michal Charvát

Masaryk University, Faculty of Sports Studies, Brno, Czech Republic

Abstract

Purpose: The purpose of this paper was to identify highlights for programming for older adults, programming that would support one's multidimensional health.

Methods: We have reviewed current database articles about wellness programming.

Results: We have identified four basic components of current wellness programs for seniors and these are education (educate to promote health and quality life), empowerment (use an interactive style that promotes participation), community (create social support networks through peer interaction) and long-term character of intervention programs that influence health by influencing behavior and environment.

Conclusions: We suggest providing long-term education about relevant topics in a form that is easily applicable into everyday life. Socialization and social support are central to participation in these programs, and interpersonal engagement is particularly important when programming for older adults.

Key words: *Seniors, wellness, education, empowerment, community, longterm intervention*

Introduction

The aging population is a growing topic in academic as well as nonacademic world. Eurostat (2011) explains this trend with the progressive decline to low levels of fertility and lower mortality rates among the European elderly in the second half of the 20th century. The post-World War II period when fertility increased and subsequently declined can be traced not only in European countries. This “baby boom” influences the demographic changes all around the world – the global 65-and-older population is expected to triple to 1,5 billion by mid-century. (United Nations, 2013)

This hard data draw attention to the topics of socioeconomic impact this trend will have in recent future. But not only healthcare systems need to adjust in terms of health care delivery systems and pressure to provide high-quality health care at an affordable cost. A significant step forward in this change process will be the recognition of the value of comprehensive health promotion and disease prevention. (Gordon & Harris, 1997)

In the context of health of seniors research focuses on the physiological changes associated with aging and its impact on quality of life. In his paper Mudrák (2013) summarizes current findings about the impact of aging on cognitive functions and proposes that physical activity may limit this impact. Abdulla (2001) finds physical activity to be improving various medical conditions and motivating to lifelong compliance. Bahutková (2005) agrees on the positive effect physical activity has on mental health.

But studies about healthy life with emphasis on its quality in the age above 65 take into account much broader perspective than only physical activity. Clark (1998, s. 351) listed following healthy behaviors pointing out that these do not differentiate with aging: “[Seniors] were active, regularly kept in touch with family and friends, were confident their environment was safe, obtained sufficient sleep and rest, and managed stress well. All but one attributed their quality of life and zest for living to remaining active, eating healthy food, exercising, pacing themselves, doing preferred activities, and reading the Bible, or “feeding the life of the mind.”” According to Miller and Iris (2002, s. 1) “being healthy incorporates multiple components, including functional independence, self-care and management of illness, positive outlook, and personal growth and social contribution. Being healthy is determined by self-evaluation in the context of chronic illness or disability and the social and/or physical environment.”

Older adults are a group with specific characteristics and due to current population trends it is necessary to focus on effective practices in promoting health and enhancing quality of life beyond the impact of physical activity. In this paper we describe findings from our literature review from the field of wellness programming for seniors.

Methods

We have reviewed database articles about health promotion for seniors, focusing on the wellness niche in this field. National Wellness Institute defines wellness as “an active process through which people become aware of, and make choices toward, a more successful existence,” and generally the concept of wellness perceives human health as a multidimensional state of living the full potential in all dimensions of health – physical, mental, social, and spiritual.

We assume programs that have word wellness in their description would follow this concept more likely than general health promoting programs, that might be effective as well, but tend to focus mainly on physical health and therefore do not align with the purpose of this study, which is to find highlights for programming that would support one's multidimensional health, one's wellness.

Results

The literature indicates senior citizens tend to be the age group most actively involved in health promotion activities. (Hawranik & Pangman, 2002) In context of nutrition and wellness Pogge and Eddings (2013) summarize that older adults are interested and capable of learning about these topics, but authors note that the impact of these programs on anthropometric measurements and blood pressure is unclear. This fact supports the shift in the design of wellness programs for seniors from segmented approach (physical activity and nutrition) to a holistic approach (physical, emotional, mental and spiritual) (Armbruster & Gladwin, 2001, s. 6)

A wellness program focuses primarily on assisting seniors in adopting healthy behaviors to lead healthier independent lives and Armbruster and Gladwin (2001, s. 8) suggest that "wellness programs should also include physical and lifestyle assessments, activities that enhance behavioral change (provide for goal setting and problem solving), health education, and methods to track individual progress and program success." M. Dunn (1985) adds topics like participants lifestyle education, clinical counseling, and peer support.

We have identified four basic components of current wellness programs for seniors and these are education (educate to promote health and quality life), empowerment (use an interactive style that promotes participation), community (create social support networks through peer interaction) and long-term character of intervention programs.

Education

Among older adults, education is positively related to one's self-efficacy and autonomy and lifelong learning may also prevent declines in cognitive function that are often associated with aging by providing mental stimulation. (C. C. Collins & Benedict, 2006)

The choice of teaching methods and educational content of the program is crucial for covering the holistic breadth of one's health and wellness. As mentioned in Lee (2011, s. 2180) "according to Administration on Aging, approximately 15,000 community senior centers provide a broad spectrum of programs and services for seniors that include, meal and nutrition programs; information and referral assistance; health and wellness programs; recreational opportunities; transportation services; arts programs; volunteer opportunities; educational opportunities; employee assistance; intergenerational programs; social and community action opportunities; financial benefits assistance; and special services addressing local needs." Miller and Iris (2002) add, that flexibility in choice and structure of programs contribute to seniors' sense of control over their health.

Empowerment

Wellness professional "should assist the patient in achieving high levels of wellness and in feeling empowered through their own participation in the process. [...] By utilizing the resources from the community, nurse, and patient in relation of interdependence appropriate to the patient situation at any one time, a higher level of wellness is achieved through therapeutic self-care." (Smith & Sorrell, 1989, s. 199)

Teaching methods should support an individual's belief that his or her choices and actions determine outcomes in his or her life (C. C. Collins & Benedict, 2006). Reviewed wellness programs presented messages that were simple, targeted, practical, limited in number, and reinforced; supported active involvement in determining goals of intervention; hands-on activity; and a focus on behavior modification based on theoretical models. (Pogge & Eddings, 2013) Lectures emphasized information that could be readily applied - converting abstract concepts into practical application (C. C. Collins & Benedict, 2006), provided time and room for reflection (C. Collins, 2005). Pogge and Eddings (2013) suggested including personal experience whenever possible and making sure that the program is tailored to the site or environment in which it is presented.

Community

An individual's social network has a strong impact on his health, especially in older age when one is at greater risk of social isolation after retirement. (Sundar, Oeldorf-Hirsch, Nussbaum, & Behr, 2011) Using community resources is necessary for sustaining quality life for seniors, but the value can be added on both sides – retired persons of special competence and in good health can return to active life within the community. (H. L. Dunn, 1959) Creating a community within the group of seniors or across different age groups allows participants to share their experiences and creates opportunities for peer education to decrease loneliness and stress. (C. C. Collins & Benedict, 2006)

Longterm intervention

Health promoting activities “attempt to influence health by influencing behavior and the surrounding social and physical environment that may impede or facilitate behavioral change” (Rabiner, 2006, s. 51) and this cannot be achieved by one-day seminar. Reviewed wellness programs lasted from several weeks – 12 weeks program Mindful Choices (Pogge & Eddings, 2013), 16 weeks Seniors CAN program (C. C. Collins & Benedict, 2006), to four months - The Time of Your Life (Kuczmariski & Cotugna, 2009). Evaluations showed that long-term programming, while challenging, can be a successful and sustainable format for senior health education. (Kuczmariski & Cotugna, 2009)

Conclusions

Findings of this paper can be used as general guidelines for programming health and wellness promoting programs for seniors. It is necessary to meet the needs of this age group, understand the dynamics of aging, the impact on health care costs, and the impact on quality of life. We suggest providing long-term education about relevant topics in a form that is easily applicable into everyday life. Socialization and social support are central to participation in these programs, and interpersonal engagement is particularly important when programming for older adults.

References

1. Abdulla, A. S. (2001). Prescribing exercise to seniors: A step-by-step guide to improving medical conditions. *Geriatrics Today: Journal of the Canadian Geriatrics Society*, 4(2), 82–86.
2. Anetzberger, G. J. (2002). Community resources to promote successful aging. *Clinics in Geriatric Medicine*, 18(3), 611–625.
3. Armbruster, B., & Gladwin, L. A. (2001). More Than Fitness for Older Adults: A “Whole-istic” Approach to Wellness. *ACSM's Health and Fitness Journal*, 5(2), 6–12+28.
4. Blahutková, M. (2005). *Pohyb a duševní zdraví*. Brno: Paido.
5. Clark, C. C. (1998). Wellness self-care by healthy older adults. *The Journal of Nursing Scholarship*, 30(4), 351.
6. Collins, C. (2005). Autobiography workshop: Personal narrative as a wellness tool for the elderly. *Journal of Extension*, 43(4).
7. Collins, C. C., & Benedict, J. (2006). Evaluation of a Community-based Health Promotion Program for the Elderly: Lessons from Seniors CAN. *American Journal of Health Promotion*, 21(1), 45–48.
8. Dunn, H. L. (1959). High-Level Wellness for Man and Society. *American Journal of Public Health and the Nations Health*, 49(6), 786–792.
9. Dunn, M. (1985). Senior wellness services--a concept for the 80s. *Health values*, 9(4), 14–17.
10. Eurostat, E. C. (2011). Population projections. *Population projections*. Dostupné z http://epp.eurostat.ec.europa.eu/statistics_explained/index.php/Population_projections
11. Gordon, C., & Harris, R. A. (1997). Health promotion for seniors: what is over the horizon? *Managed care quarterly*, 5(4), 34–42.
12. Hawranik, P., & Pangman, V. (2002). Perceptions of a senior citizens' wellness center: The community's voice. *Journal of Gerontological Nursing*, 28(11), 38–44.
13. Kuczmariski, M. F., & Cotugna, N. (2009). Outcome evaluation of a 3-year senior health and wellness initiative. *Journal of Community Health*, 34(1), 33–39.
14. Lee, Y. S., Basapur, S., Chaysinh, S., & Metcalf, C. (2011). Senior Wellness: Practices of Community Senior Centers. *CHI '11 Extended Abstracts on Human Factors in Computing Systems*, CHI EA '11 (s. 2179–2184). New York, NY, USA: ACM. Dostupné leden 21, 2014, z <http://doi.acm.org/10.1145/1979742.1979946>
15. Miller, A. M., & Iris, M. (2002). Health Promotion Attitudes and Strategies in Older Adults. *Health Education & Behavior*, 29(2), 249–267.
16. Mudrak, J., Slepicka, P., & Houdova, V. (2013). Kognitivnı funkce a nektere faktory aktivnıho ˇzivotnıho stylu a kvality ˇzivota u senioru. *ˇCeska kinantropologie: ˇcasopis Vedeke spolecnosti kinantropologie*, 17(4), 53–64.
17. Pogge, E. K., & Eddings, L. (2013). Effect of a 12-Week Nutrition and Wellness Program in Independent Living Seniors. *Journal of Nutrition Education and Behavior*, 45(5), 471–472.
18. Rabiner, D. J. (2006). Understanding the multidimensional nature of health promotion for older adults through the application of a conceptual framework. *Home Health Care Services Quarterly*, 24(4), 47–63.
19. Smith, J. M., & Sorrell, V. (1989). Developing wellness programs: a nurse-managed Stay Well Center for senior citizens. *Clinical nurse specialist CNS*, 3(4), 198–202.
20. Sundar, S. S., Oeldorf-Hirsch, A., Nussbaum, J., & Behr, R. (2011). Retirees on Facebook: Can Online Social Networking Enhance Their Health and Wellness? *CHI '11 Extended Abstracts on Human Factors in Computing Systems*, CHI EA '11 (s. 2287–2292). New York, NY, USA: ACM. Dostupné leden 21, 2014, z <http://doi.acm.org/10.1145/1979742.1979931>
21. United Nations, D. of E. and S. A. (2013, ˇcerven). World Population Prospects: The 2012 Revision. Dostupné z <http://www.pewglobal.org/2014/01/30/attitudes-about-aging-a-global-perspective/>

RECREATIONAL PHYSICAL ACTIVITY AND SELF-PERCEPTION OF HEALTH

Gordana Grozdek Čovčić, Lukrecija Jakuš and Marina Horvat

University of Applied Health Studies, Zagreb, Croatia

Abstract

Purpose

Taking into account the frequency of physical activity and the period of life in which recreational physical activity was carried out, this paper analyses the correlation between recreational physical activities during one's lifespan and self-perception of health.

Methods

The study was conducted on a convenient sample of 60 middle-aged and elderly women between the ages of 48 and 91, with an average age of 62.3. The Physical Activity Questionnaire (Ulrich et al., 1999), which assesses recreational physical activity in different stages of life, was applied for the purpose of this study. The self-assessment of health was measured by the two linear cumulative savings charts and statements about the number of chronic illnesses from which people suffer

The SPSS software version 15.0 was used for processing the data.

Pearson's or Spearman's correlation coefficient was used to determine the correlation between the observed variables. Correspondingly, Kolmogorov-Smirnov's test was used to check the degree of how normal the distribution of variables was. The results showed that the number of variables distributed was significantly different from the normal distribution; therefore, in this case, the nonparametric correlation coefficient was applied.

Results

The study has shown that recreational physical activity is positively correlated with self-perception of health. Self-perception of health showed a significant positive correlation only with recreational physical activity during childhood ($\rho = 0.29$, $df = 58$; $P = 0.027$).

There is a negative, moderate correlation ($r = -0.432$, $df = 59$, $P = 0.001$) of recreational physical activity and chronological age. The number of recreational activities decreased as the chronological age of the participants increased.

Conclusions

The above correlations indicate that self-perception of health is higher the more recreational physical activity a person had during her childhood. The number of recreational activities decreased with higher chronological age of the participants.

The results indicate the need to encourage regular recreational physical activity in childhood with an assumption that it affects an individual's physical activity in adulthood. Consequently, the conclusion of this paper is that regular recreational physical activity is an important component in the perception of good health.

Key words: *recreational physical activity, health, physical activity questionnaire*

MEANINGS OF LEISURE TO ADULTS WITH PHYSICAL DISABILITIES

Bulent Gurbuz¹ and Erman Oncu²

¹*School of Physical Education and Sport, Kırıkkale University, Kırıkkale, Turkey*

²*School of Physical Education and Sport, Karadeniz Technical University, Trabzon, Turkey*

Abstract

Purpose

This study was conducted for the assessment of what individuals with physical disabilities experienced when involved in leisure activities and examine the differences in meaning of leisure according to some demographic variables such as gender and age.

Method

The study was conducted on 71 female and 143 male adults with physical disabilities in Turkey. The average age of the participants were 29.14 years (SD=8.51). The Meaning of Leisure Time Scale (MLS) was administered on the participants. The scale consisted of 35 items and 8 subscales. All items were measured and sorted using a six-point Likert scale. Descriptive statistics were performed on all variables including means and standard deviations. Cronbach's alphas were calculated for the subscales and total scale in order to evaluate their internal consistency. Multivariate analysis of variance (MANOVA) was also used to determine differences between the scores acquired from the scale and some independent variables.

Results

The mean scores of the participants for the total scale was 3.98. The result of analysis indicated significant differences in perceived freedom, intrinsic motivation and relation to work subscales with regard to gender ($p < .05$). However, there was no significant difference between sport participants and nonsport participant and also among age groups ($p > .05$).

Conclusion

While the most agreed upon meaning was that leisure was social interaction, the least agreed upon meaning was active-passive. The understanding of meanings of leisure for peoples with disabilities may be important to encourage people's persistence in leisure activities. In this way, knowing perceptions of leisure may allow leaders to evaluate and re-examine their methods and to use appropriate motivational strategies in undertaking program planning and promotion. A number of limitations existed for this exploratory study such as its sample size and cross sectional. Future studies should consider the limitations of this study and should continue to examine this new concept for Turkish culture with larger samples, on different age groups, and with general populations.

Key words: *Meaning of leisure, physical disabilities, recreation*

THE RELATIONSHIP BETWEEN THE STATE OF HEALTH IN YOUNG ADULTS AND THE MODE OF THEIR IMPELLENT ACTIVITY

Sergii N. Ivaschenko

National University of the Physical Education and Sport of Ukraine, Kiev, Ukraine

Introduction

Extremely important scientific problem in our time is to study the features of impellent activity in young people. This is the conventional wisdom that the level of physical development of people and success of their profession actions depends on the level of their impellent activity in childhood and youth. The aim of this study was to examine the relationship between mode of impellent activity of children and adolescents and the indicators of their well-being, intellectual activity and mood.

Methods

In this study were used such methods: theoretical analysis of scientific information, testing and pedagogical experiment questionnaires, interviews, methods of evaluation the well-being, mental alertness and mood, statistical treatment methods.

Results

The participants of this investigation were 438 pupils (212 boys and 226 girls) in the age from 7 to 12 years old, who studied in four different secondary public schools, located in Kiev and region (Ukraine). It was found that 126 boys (59.4%) and 138 girls (61.1%) had the normal level of motor activity (average, typical for this age group). Moreover, it was found that 54 boys (25.5%) and 46 girls (20.4%) had insufficient motor activity (the level of their impellent activity was below the average level). Finally, it was found that 32 boys (15.1%) and 42 girls (18.5%), unlike others, had heightened level of impellent activity (much higher than the average). Was finding that parameters, characterizing the health of pupils in all components (well-being, intellectual activity and mood) is significantly higher in the group of pupils, where were the best mode of impellent activity and the nature of the motion was optimal.

Discussion

Given that the relationship between the regime of impellent activity during the formation of the body and health indicators in young adults has been established, it became apparent that one of the surest ways to protect the health of the young generation is to improve the state system of physical education of youth. Scientific data obtained in the course of this study, can be used in the process of scientific substantiation and development of modern improved system of the physical education of children and adolescents in our country and abroad.

Key words: *mode of motion activity, the younger age group, the level of physical development, intellectual state, kinesiology*

References

1. Andersen K.L. (1982). Habitual physical activity and health / K.L. Andersen, J. Ruttenfrants // *WHO regional publications. European series*. № 6, – pp. 12 – 19.
2. Clifford P. (2001). Muscular Christianity: Manhood and Sports in America at the end of nineteen's century. *Harvard Press*. - № 5 (12), – pp. 47 – 51.
3. Melicher, A. (2001). Physical education projects at primary and secondary schools. *Methodology of the school physical education, Bratislava*, № 2, – pp. 136 – 147.
4. Vatsaba O. (2001). Problems of the modern theory of physical education // *Pedagogy, Psychology and Medico-Biological Problems*. – № 13, – pp. 21 – 25.
5. Vylchkovsky J.E. (2006). Physical fitness of preschool children for the purpose of preparing to school *Physical culture, sports and health*. –№ 8, – pp. 36 – 52.

MOTIVES FOR EXERCISING IN GENERAL POPULATION OF CROATIA

Danijel Jurakić, Zrinka Greblo and Mirna Andrijašević

Faculty of Kinesiology, University of Zagreb, Croatia

Purpose

A solid body of empirical evidence shows that regular physical activity provides a long term protection against an array of physical and mental illnesses (Penedo & Dahn, 2005). However, recent study revealed that 59% of adult Croatian inhabitants don't exercise at all (Greblo et al., 2008). In order to create appropriate national promotion strategies aimed to increase the number of exercisers in Croatia, the aim of the current study was to determine gender differences in self-reported motives for exercising in general population.

Methods

The study was conducted on a sample of 1,032 Croatian inhabitants aged 15 years or more (51.6% women). The sample was representative of gender, age, and regional structure of Croatian adult population (for more details about the sample see Jurakić et al., 2010). In order to determine most important motives for exercising, participants were asked to rank (from 1 = most important to 7 = least important) the relative importance of seven possible exercise motives (losing weight, fitness improvement, muscle mass gain, relaxation, socialization, improved appearance, and medical conditions). T-test was used for analysis of gender differences.

Results

According to our results, relaxation and fitness improvement are two most important motives for exercising among men and women. At average, the least important motives for exercising were losing weight and muscle mass gain for men and women, respectively. Analyses of gender differences revealed that, fitness improvement ($t(969) = -2.80$; $p < 0.01$), muscle mass gain ($t(969) = -3.48$; $p < 0.01$), and improved appearance ($t(971) = -2.71$; $p < 0.001$) are more important among men. On the other hand, losing weight ($t(970) = 5.77$; $p < 0.001$), relaxation ($t(970) = 2.44$; $p < 0.05$), and medical conditions ($t(970) = 3.45$; $p < 0.01$) were more salient motives for regular exercising among women. Socialization motives were equally important for both genders ($t(971) = 0.34$; *ns*).

Conclusions

According to our results, the national campaign aimed to increase the level of physical activity among adult Croatian inhabitants should be gender specific and the interventions should promote exercise as a mean of fulfilment of above mentioned motives.

Key words: *physical activity, promotion, exercise, general population, Croatia*

PHYSICALLY ACTIVE YOUTH MORE MOTIVATED TOWARD PHYSICAL EXERCISE REPORT LESS PERCEIVED EXERCISE BARRIERS

Daniel Mayorga-Vega¹, Humberto Blanco Vega², José R. Blanco Ornelas^{2,3}, Martha Ornelas Contreras² and Jesús Viciana¹

¹University of Granada, Granada, Spain

²Autonomous University of Chihuahua, Chihuahua, Mexico

³Autonomous University of Nueva León, Nueva León, Mexico

Abstract

Purpose: The main purpose of the present study was to examine the influence of the self-determined motivation toward physical exercise on perceived exercise barriers among physically active youth. **Methods:** A sample of 533 university students (226 males and 307 females) of 18-36 years old (21.0 ± 2.6 years) participated in the present study. All the participants did physical exercise at least for 30 minutes two or three times per week. The participants completed the Spanish version of the questionnaires *Behavioral Regulation in Exercise Questionnaire-2* (BREQ-2) (Moreno, Cervelló, & Martínez, 2007) and *Self-report on Barriers to Exercising* (Niñerola, Capdevila, & Pintanel, 2006). Then, according to Vallerand and Ratelle (2002), the Self-determination Index was calculated. **Results:** The cluster analysis identified two profiles: “High motivation toward physical exercise” ($n = 408$) and “Moderate motivation toward physical exercise” ($n = 125$). Subsequently, the results of the one-way multivariate analysis of variance, followed by the one-way univariate analyses of variance, showed that the profile “Moderate motivation toward physical exercise” reported greater values of perceived barriers to exercising than the profile “High motivation toward physical exercise” (Table 1). **Conclusions:** Even among physically active young people, having a greater self-determined motivation toward physical exercise involves less perceived barriers to exercising. Because of the role that the self-determined motivation toward physical exercise plays on perceived exercise barriers, this should be a factor to consider in promoting physical activity among young people.

Table 1: Differences on the self-reported barriers to exercising scores between high and moderate motivation toward physical exercise profiles

	High motivation toward physical exercise ($n = 408$)	Moderate motivation toward physical exercise ($n = 125$)	F	p
			29.629	< 0.001
Body image/ Social physical anxiety	0.72 \pm 1.22	2.50 \pm 2.52	111.280	< 0.001
Fatigue/ Laziness	2.10 \pm 1.47	3.35 \pm 1.96	55.588	< 0.001
Duties/ Lack of time	3.32 \pm 2.49	4.08 \pm 2.47	8.150	0.004
Environment/ Sport facilities	1.34 \pm 1.60	2.26 \pm 2.03	26.145	< 0.001
Total	1.87 \pm 1.30	3.05 \pm 1.78	62.053	< 0.001

Acknowledgements

Thank Anna Szczesniak for the English revision. This study is part of a project funded by the *Secretaría de Educación Pública-Subsecretaría de Educación Superior-Dirección General de Educación Superior Universitaria de México* [Mexican Ministry of Education-Department of Higher Education-General Directorate of the University Education] (OF-13-6894). The first author is supported by a research grant from the Spanish Ministry of Education, Culture and Sport (AP2010-5905).

CHILDREN AND YOUTH INTERESTS IN THE CONTEXT OF PREVALENCE OF PHYSICAL ACTIVITIES AND SPORT

Ana Žnidarec Čučković and Katarina Ohnjec

Faculty of Kinesiology, University of Zagreb, Croatia

Abstract

Purpose

The results of qualitative research aimed at finding personal views of children and youth are presented in this paper. Research was conducted in consideration of children's surroundings: school, family and local community. The main objectives of the research were to establish main opinions from children and youth perspective about their generation problems, possibilities, solutions and ideas for these problems and situations. For the purposes of this study the *interests* of children were researched (ways of choosing activities of interest and the conditions that influences the selection were identified). The special objective of this research was to gain whether and to what extent the movement and the different aspects of physical activity are included in their overall structure of interest.

Methods

The target group for this study were children and young people aged 10 to 18. According to the spatial location, respondents come from schools in four counties in Croatia. The main research method is focus groups. For the purpose of this study we organized eight focus groups with a total number of 83 students, with a particular group comprised of 9 to 12 students. Furthermore, the research contains result analysis, which includes the collection of impressions, careful analysis of sets of transcripts and encoding of each group. Recorded audio recordings are transcribed, and the resulting transcripts are the basis for the result analysis. For the qualitative data analysis program MAXQDA, VERBI GmbH, Berlin, Germany was used.

Results

Frequency of appearance as well as the percentage of representation of certain codes in total cultivated transcripts indicate that the dominant representation has "*interests*" (396, 14.27%). "*The problem*" as the code in the researched population of students is presented as follows in the series representation (302; 10.88%), and it followed by a "*solutions*" (259; 9.33%) and "*ideas*" (252; 9.08%).

Conclusions

Registered dominant interests of students in elementary schools observed through the aspect of kinetic activities showed that the movement gets its own dimension separate from the context of games and entertainment, and were observed exclusively in relations with various organized sports activities. In the context of the practice of movement and physical activity for secondary school students, the results indicate that movement and physical activity play a key role in their interests, but practically are not implemented.

Key words: *children and youth perspective, interests, focus groups, prevalence of physical activities and sport*



Kinesiology of Top-level Sport

**7th INTERNATIONAL
SCIENTIFIC
CONFERENCE ON
KINESIOLOGY**

**FUNDAMENTAL
AND APPLIED
KINESIOLOGY – STEPS
FORWARD**

Editors:
Prof. Dragan Milanović, PhD
Sanja Šalaj, PhD

Peer Reviewers:
Daniel Bok, PhD
Prof. Milan Čoh, PhD
Prof. Nic James, PhD
Prof. Bojan Jošt, PhD
Prof. Marjeta Mišigoj-Duraković, PhD
Prof. Dragan Milanović, PhD
Prof. Erich Muller, PhD
Katarina Ohnjec, PhD
Prof. Sergej Ostojić, PhD
Prof. Damir Sekulić, PhD
Sanja Šalaj, PhD
Dario Škegro, PhD



PERIODIZATION TRAINING FROM ANCIENT PRECURSORS TO STRUCTURED BLOCK MODELS

Vladimir B. Issurin

Wingate Institute for Physical Education and Sport, Israel

Abstract

Periodization training is correctly considered to be one of the principal issues underlying the theory of athlete preparation. Its historical roots are associated with celebrated treatises by ancient philosophers while its later conceptualization is closely connected with the formation of the underpinnings of contemporary coaching sciences. The present-day classic version of periodization training was initiated with publications in the early 20th century and reached its culmination with the appearance of Matveyev's distinguished book, which is considered a landmark in training fundamentals. Further development of high-performance sport and the revelation of new facts, knowledge and technologies have affected later alternative versions of periodized training, some of which have been used by elite athletes in different sports with remarkable success. On the other hand, the appearance of alternative concepts, such as Block Periodization (BP), has aroused the interest of several researchers who have engaged in further studies. Since then a number of research projects have been conducted in various sports and their outcomes have demonstrated the benefits of BP models in enhancing metabolic, neuromuscular and sport-specific variables of athletic preparedness. The present review summarizes these elements, highlighting the contribution of the latest studies into the methodology of high-performance training.

Key words: training periodization, ancient roots, alternative planning concepts

SOMATOTYPES OF ELITE SERBIAN JUDOKAS FROM DIFFERENT WEIGHT CATEGORIES

Cristina Casals¹, Patrik Drid², Marko Stojanović², Miodrag Drapšin^{2,3} and Sergej Ostojić²

¹*Biomedical Research Centre, Faculty of Sport Sciences, University of Granada, Granada, Spain*

²*Faculty of Sport and Physical Education, University of Novi Sad, Serbia*

³*Medical Faculty, University of Novi Sad, Serbia*

Abstract

The aim of the present study was to determine the somatotype and anthropometric profiles of elite judokas comparing by weight categories. A total of 100 elite senior and junior judokas from Serbia participated in the study (34 females and 66 males from 7 weight categories). Anthropometrical variables were taken in order to calculate somatotypes and body fat percentage. The 1 way ANOVA test showed significant differences by weight categories for all anthropometrical variables in both males and females. The 2 way ANOVA analysis showed significant effects of sex and weight category, without a statistically significant interaction between both variables. The Fischer's LSD method was used for post hoc analysis. Results of this study suggests specific somatotypes for each weight category in elite judokas. Lightweight judokas are mesomorphic and ectomorphic, with an increase in the dominance of mesomorphic and endomorphic components in heavier weight categories. Judokas from heavier categories had also a higher body mass index, body fat percentage, and height than judokas from lighter categories. This study highlights the importance of distinguishing between categories during the training and selection processes, since judokas have a specific body composition in function of the weight category in which they compete. In addition, future research should attend to these differences to generate appropriated conclusions about the role of anthropometric characteristics in judo.

Key words: anthropometric profile, body composition, male and female, martial arts, skinfold thickness

Introduction

Judo is a high intensity sport in which the athlete tries to throw or to control the opponent during groundwork combat (Franchini, Nunes, Moraes & Del Vecchio, 2007). The singular characteristics of the combat, with many interruptions, make judo a sport with both anaerobic and aerobic physiological demands (Franchini et al., 2007), so these two components are determinants of success in judo competition.

In addition, it has been suggested that body composition is an important factor, which determines the achievement of top judo performance and impacts on the application of different techniques (Franchini et al., 2011; Krstulović, Žuvela & Katić, 2006). The body composition and somatotype components of judokas have been also associated with several physical attributes, such as anaerobic power, muscle torque, power output, strength, and judo-specific performance (Kim, Cho, Jung & Yoon, 2011; Lewandowska, Busko, Pastuszek & Boguszevska, 2011; Drid, et al, 2009). Additionally, several studies have pointed out specific anthropometrical parameters related to judo performance, such as body fat (Kubo et al., 2006), body circumferences, and bone diameters (Franchini, Takito, Kiss & Sterkowicz, 2005).

Surprisingly, though judo is a weight-classified sport, most researches usually do not analyse the somatotype and anthropometric profiles according to these categories. In judo competition, there are seven weight categories; for males: under 60 kg, 66 kg, 73 kg, 81 kg, 90 kg, 100 kg and plus 100 kg; for females: under 48 kg, 52 kg, 57 kg, 63 kg, 70 kg, 78 kg and plus 78 kg. Thus, it is likely that each weight category may require a specific anthropometrical profile.

Recently, the body composition of elite judo athletes according to 3 weight groups (lightweight, middleweight, and heavyweight) has been described, but only in female judo athletes (Stachon, Pietraszewska, Burdukiewicz & Andrzejewska, 2014). In addition, another recent study analysed the anthropometric profile in male judokas, but the sample consisted of only 14 athletes, and the somatotypes were not calculated (Jagiello, 2013). Thus, more studies describing somatotypes and body composition in elite judo athletes according to weight categories are needed.

For all that, the aim of this study was to describe the anthropometrical profile and somatotypes components of elite Serbian judo athletes grouped by weight categories. This information could be useful for coaches in adjusting the training program and it can improve the selection process. In addition, this study could also be interesting for researches since it can determinate if the weight category must be attended to generate appropriated conclusions about the role of anthropometric characteristics in judo.

Methods

The study was conducted on 100 elite senior and junior judokas (34 females and 66 males) from the Serbian National Judo Team belonging to all 7 weight categories. All participants volunteered to take part in the study and the anthropometrical evaluation was performed during November 2013 and December 2013.

Anthropometric variables were collected following the protocol developed by the International Society for Advanced of Kinanthropometry (ISAK) (Marfell-Jones, Olds, Stewart et al., 2006). Anthropometric variables included body mass, height, 5 skinfolds (triceps, subscapular, supraspinal, abdominal and medial calf), 3 girths (arm flexed and tensed, and medial calf) and 2 breadths (femoral and humeral epicondyles). Height was measured to the nearest 0.5 cm using a stadiometer (Holtain Ltd., UK). Weight was measured to the nearest 0.1 kg using a balance beam scale (Avery Ltd., Model 3306 ABV). Skinfold thickness was obtained using a Harpenden caliper (British Indicators Ltd., St. Albans, UK). The girths were performed using a Gulick anthropometric tape (Creative Health Products, Plymouth, USA), and the breadths were measured with an anthropometer (Lafayette Co., USA). Skinfolds were taken three times on each point in a rotation system, as described by Heyward (1977), and the mean of 3 measurements was used in the analyses. The same trained technician did all measurements. Body mass index (BMI) was calculated as weight/height² where weight was expressed in kilograms (kg) and height in meters (m). Somatotypes were determined according to the Carter and Heath method (1990). Body fat percentage was calculated using the procedures described by the ISAK.

For the statistical analysis, the Kolmogorov-Smirnov test was used to check the normality of distributions. Differences between the 7 weight categories in males and females were compared with a 1 way ANOVA. The effect of sex and category was tested by using a 2 way ANOVA statistic. The Fischer's LSD method was used for post-hoc analysis. As in this study only two female judokas from the 78 kg category, and one from the plus 78 kg participated, these three females were grouped into one category, presented in the tables as 78kg plus. All analyses were carried out using the SPSS statistical package (version 17.0; SPSS, Inc, Chicago, Illinois, USA), the level of significance was set at $p < 0.05$, and data are presented as mean \pm standard error of the mean (SEM).

Results

Table 1 shows the differences by weight categories in the anthropometric profile, table 2 shows these differences in somatotypes components, and the somatochart is represented in the figure 1. Sex and weight categories were statistically significant for all variables ($p < 0.001$), unlike interaction between variables in any case.

Table 1: Anthropometric profile of elite Serbian judokas by weight categories

	Height (cm)	BMI (kg/m ²)	Body Fat (%)	Number
Males				
Under 60kg	171.86 (5.15)	20.14 (1.19)*	10.29 (0.88)*	7
66kg	174.53 (5.46)*	22.01 (1.51)	11.60 (2.04)	11
73kg	178.44 (5.63)	22.83 (1.29)*	11.18 (1.27)	18
81kg	178.73 (3.13)	25.20 (0.76)	11.47 (1.69)*	11
90kg	183.33 (4.44)*	26.45 (1.07)*	13.92 (2.48)*	9
100kg	183.53 (4.12)*	29.10 (1.56)*	15.14 (2.09)*	7
plus 100kg	194.33 (5.13)	34.22 (6.79)	19.44 (7.24)	3
Females				
Under 48kg	159.15 (1.45)	18.47 (1.29)*	10.94 (1.76)*	4
52kg	161.67 (3.85)*	19.76 (1.28)	12.84 (1.95)	6
57kg	166.25 (3.11)	20.51 (0.99)*	12.46 (1.23)*	8
63kg	165.00 (1.73)	22.29 (0.80)*	14.52 (0.82)*	7
70kg	167.50 (5.75)*	24.15 (1.96)	16.05 (2.57)	6
78kg plus	179.67 (3.51)	25.08 (1.39)	17.14 (3.24)	3

*: $p < 0.05$ between the category and the next heavier category.

Table 2: Somatotypes fo elite Serbian judokas by weight categories.

	Endomorphy	Mesomorphy	Ectomorphy
Males			
Under 60kg	2.06 (0.58)*	3.87 (0.61)*	3.67 (0.86)*
66kg	2.50 (0.94)	4.19 (1.10)	2.90 (1.04)
73kg	2.38 (0.65)	4.49 (1.09)*	2.75 (0.86)*
81kg	2.43 (0.52)*	5.75 (0.60)	1.74 (0.37)
90kg	3.30 (0.81)	5.53 (0.35)*	1.53 (0.60)*
100kg	3.88 (0.87)*	6.94 (0.77)*	0.83 (0.47)
plus 100kg	4.55 (2.05)	8.13 (2.67)	0.72 (1.08)
Females			
Under 48kg	2.58 (0.92)	2.73 (0.80)*	3.79 (0.83)*
52kg	3.39 (0.92)	3.72 (0.96)	3.23 (0.94)
57kg	3.12 (0.69)*	3.58 (0.41)*	3.11 (0.68)*
63kg	4.03 (0.34)	5.01 (1.18)	2.16 (0.46)*
70kg	4.60 (1.11)	4.54 (1.02)	1.64 (1.05)
78kg plus	4.48 (1.31)	5.16 (1.37)	1.83 (0.57)

*: p<0.05 between the category and the next heavier category.

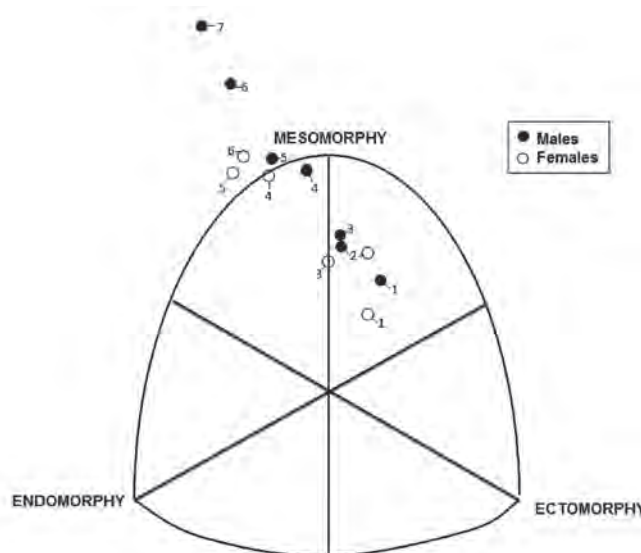

Figure 1: Somatochart of elite Serbian judokas according to the 7 weight categories in males (from 1 as the lightest category, to 7 as the heaviest one), and 6 weight cateogries in females (from 1 as the lightest category, to 6 as the heaviest one in which 78kg and plus 78kg were combined).

Discussion and conclusions

Our results showed significant differences in the somatotype and anthropometric profiles of elite Serbian judokas according to weight categories in both groups of men and women. Judokas belonging to heavier categories have higher body height, BMI, and body fat percentage.

Similarly, Stachon et al. (2014) reported that heavyweight female judokas have higher body fat and more massive body build than light and middleweight judokas. Moreover, similar results have been found in male athletes from other weight-categorized sports as Freestyle and Greco-Roman wrestlers, in which heavy weight athletes showed higher body fat, height and BMI (López-Gullón, Muriel, Torres-Bonete, Izquierdo & García-Pallarés, 2011; Jagiello and Kruszewski, 2009).

Comparing our results in male judokas with Jagiello’s (2013) study, Serbian elite judokas seem to have lower body fat percentage and BMI than Polish judokas, but it can be due to the small sample that this researcher used (14 males). However, the tendencies found are in accordance with our results, and, as other studies also reported, the weight categories determine a morphological diversification in judo (Jagiello, Kalina & Korobielnikow, 2007).

Somatotypes in heavier categories were mesomorphic-endomorphic, like other ten groups of elite judokas which were reported by Sterkowicz-Przybycien and Almansba (2010); however, the categories of lower weight were mesomorphic-endomorphic and the differences with previous studies are probably due to the analysis of the judokas in only one group. Thereby, this tendency from mesomorphic-ectomorphic to mesomorphic-endomorphic with the increase in the weight category, for both males and females, highlights the differences by weight categories and seems useful to improve the selection of talented judokas.

Thus, it can be concluded that there are specific body compositions in function of the weight category in male and female elite judokas. This study highlights the importance of distinguishing between categories during the training and selection processes. It is also important to note that our results show significant differences between weight categories usually grouped into one group of analysis, since other studies categorized the weight in three groups or less. Future research should attend to these differences by category to generate appropriated conclusions about the role of anthropometric characteristics in judo performance.

References

1. Carter, J. L., & Heath, B. H. (1990). *Somatotyping: development and applications*. Cambridge University Press.
2. Drid, P., Maksimovic, N., Matic, R., Obradovic, B., Milosevic, Z., & Ostojic, S. M. (2009). Fitness profiles of elite female judokas of the Serbian national team. *Medicina dello Sport*, 62(3), 251-263.
3. Franchini, E., Huertas, J. R., Sterkowicz, S., Carratala, V., Gutierrez-Garcia, C., & Escobar-Molina, R. (2011). Anthropometrical profile of elite Spanish Judoka: Comparative analysis among ages. *Archives of Budo*, 7(4), 239-245.
4. Franchini, E., Nunes, A. V., Moraes, J. M., & Del Vecchio, F. B. (2007). Physical fitness and anthropometrical profile of the Brazilian male judo team. *Journal of physiological anthropology*, 26(2), 59.
5. Franchini, E., Sterkowicz, S., Szmatlan-Gabrys, U., Gabrys, T., & Garnys, M. (2011). Energy system contributions to the special judo fitness test. *International Journal of Sports Physiology & Performance*, 6(3).
6. Franchini, E., Takito, M. Y., Kiss, M. A. P. D. M., & Sterkowicz, S. (2005). Physical fitness and anthropometrical differences between elite and non-elite judo players. *Biology of Sport*, 22(4), 315.
7. Heyward, V. H. (1998). *Advanced fitness assessment & exercise prescription*. Champaign IL: Human Kinetics.
8. Jagiello, W. (2013). Differentiation of the body build in judo competitors of the men's Polish national team. *Archives of Budo* 9(2), 117-125.
9. Jagiello, W., Kalina, R. M., & Jagiello, M. (2011). Differentiation of the Body Composition in the Polish National Team Pentathletes. *Baltic Journal of Health and Physical Activity*, 3(2), 105-111.
10. Jagiello, W., Kalina, R.M., Korobielnikow, G. (2007). Morphological diversification of female judo athletes. *Archives of Budo* 3, 27-34.
11. Jagiello, W., & Kruszewski, A. (2009). Morphological diversification of competitors training Greco-Roman style of wrestling. *Archives of Budo* 5, 147-153.
12. Kim, J., Cho, H. C., Jung, H. S., & Yoon, J. D. (2011). Influence of performance level on anaerobic power and body composition in elite male judoists. *The Journal of Strength & Conditioning Research*, 25(5), 1346-1354.
13. Kubo, J., Chishaki, T., Nakamura, N., Muramatsu, T., Yamamoto, Y., Ito, M., & Kukidome, T. (2006). Differences in fat-free mass and muscle thicknesses at various sites according to performance level among judo athletes. *The Journal of Strength & Conditioning Research*, 20(3), 654-657.
14. Krstulović, S., Žuvela, F., & Katić, R. (2006). Biomotor systems in elite junior judoists. *Collegium Antropologicum*, 30(4), 845-851.
15. Lewandowska, J., Buško, K., Pastuszek, A., & Boguszevska, K. (2011). Somatotype variables related to muscle torque and power in judoists. *Journal of Human Kinetics*, 30(1), 21-28.
16. López-Gullón, J. M., Muriel, X., Torres-Bonete, M. D., Izquierdo, M., & García-Pallarés, J. (2011). Physical fitness differences between Freestyle and Greco-Roman elite wrestlers. *Archives of Budo* 7(4), 217-225.
17. Marfell-Jones, M., Olds, T., Stewart, A., & Carter, J. (2006). ISAK: Potchefstroom: International Standards for Anthropometric Assessment.
18. Stachon, A., Pietraszewska, J., Burdikiewicz, A., & Andrzejewska, J. (2014). The diversity of body composition, body proportions and strength abilities of female judokas in different weight categories. *Archives of Budo*, 10, 37-46.
19. Sterkowicz-Przybycien, K., & Almansba, R. (2011). Sexual dimorphism of anthropometrical measurements in judoists vs untrained subject. *Science & Sports*, 26(6), 316-323.

BIOPHYSICAL ANALYSIS OF DROP JUMPS IN FEMALE ELITE TRIPLE JUMP ATHLETES

Milan Čoh¹, Milan Žvan¹, Stanislav Peharec² and Petar Bačić²

¹Faculty of Sport, University of Ljubljana, Slovenia

²Polyclinic for Physical medicine and Rehabilitation "PEHAREC" in Pula, Croatia

The purpose of the study was a biophysical analysis of the kinematic and dynamic parameters of two types of drop jumps (heights of 25 cm and 45 cm). The sample of measured subjects included four female elite triple jump athletes, with their best results varying from 13.33 to 15.06 metres. The kinematic and dynamic parameters were calculated with the use of a bipedal tensiometric force plate, which was synchronised with nine CCD cameras. In the drop jump from a 25 cm height, the measured subjects achieved the following results: height of jump 43.37 ± 5.39 cm and ground reaction force 2770 ± 411 N. In comparison, results for the drop jump from a 45 cm height were: height of jump 45.22 ± 4.65 cm and ground reaction force 2947 ± 366 N. Vertical velocity of the take-off in the 25 cm drop jump was 2.77 ± 0.19 ms⁻¹ and in the 45 cm drop jump it was 2.86 ± 0.15 ms⁻¹.

Key words: triple jump, biomechanics, plyometric jump, biodynamical parameters

Introduction

Triple jump is a complex technical track and field discipline, structured from the run-up phase and three consecutive jumps. The result is defined mostly with the speed of the run-up and the optimal proportion of individual jump lengths (Grahman-Smith, Lees, 1994). In keeping with the biomechanical and neuromuscular principles of triple jump, one of the key areas is diagnostics in the area of strength in female and male triple jump athletes. The results of some studies (1995; Zatsiorsky, 1995; Komi, 2000) show that drop jumps from various heights are the best indicator of special take-off strength. The experimental procedure in the present study employed drop jumps of 25 and 45 cm height which generate an eccentric-concentric muscular modulation. This stretch-shortening cycle (SSC) is a result of stretching due to the external forces and shortening of muscles in the second phase (Komi and Gollhofer, 1997; Nicol et al., 2006). In the eccentric phase a certain amount of elastic energy is stored in a muscular-tendon complex, which can be spent in the second phase. Some of the elastic energy accumulated in a muscle is only available for a definite time, depending on the life span of cross bridges in a muscle, which is between 15 and 120 milliseconds (Komi and Gollhofer, 1997; De Luca, 1997; Bobbert & van Ingen Schenau, 1988). The efficiency of the stretch-shortening cycle (SSC) also depends on the time of switching from an eccentric to a concentric contraction: the longer the switch, the lower the efficiency of the contraction. Besides the magnitude and velocity of changes in muscle length and the time of switching from the eccentric to the concentric phase, the preactivation of muscles is also very important for the efficiency of the stretch-shortening cycle (Nicol et al., 2006). Preactivation is defined by the first contact of the foot with the ground and is mainly manifested in sprints, horizontal and vertical jumps. Preactivation prepares muscles for stretching and is manifested by a number of joined cross bridges and changes in the excitation of α -motor neurons. Both factors influence the short-range stiffness: greater stiffness leads to less stretching of the tendons and ligaments and consequently to the better integration of chemical and elastic energy in the muscle (Komi & Gollhofer, 1994; Bobbert & van Soest, 2000; Komi & Nicol 2000; Nicol et al., 2006). This results in the higher production of muscular force.

The purpose of the present study was to find the most important kinematic and dynamic parameters of four female elite athletes in drop jumps from 25 and 45 cm heights. The tests varied in their starting height. It may be assumed that in a drop jump from a 45 cm height the force of muscle stretching will be larger in the eccentric phase, which will consequently lead to the integration of elastic and chemical energy in the concentric phase of the take-off. As a larger amount of accumulated elastic energy will then be carried over to the concentric phase of the take-off, and assuming that a short contact time will be accomplished, hypothetically higher vertical jumps can be expected. Both tests are important diagnostic indicators of the degree of take-off strength in triple jump athletes of both genders. The aim of the study is to examine the kinematic and dynamic parameters and find an optimal height of drop jumps that will have the largest effect on the required special strength in female triple jump athletes.

Methods

The sample of measured subjects included the four best female triple jump athletes in Slovenia (age 26.3 ± 4.2 years, body height 171.3 ± 9.6 cm and body weight 65.2 ± 4.1 kg. The average triple jump result of these athletes was 13.74 ± 1.4 m, the best jumper had a result of 15.03 m, achieving 6th place at the 2008 Beijing Olympic Games). The measured subjects were informed of the aim, goals and organisation of the experiment, which was carried out according to the Helsinki-Tokyo declaration.

The procedure of the experiment was carried out in laboratory conditions (Biomechanical Laboratory, Polyclinic for Physical Medicine and Rehabilitation Peharec in Pula, Croatia). When performing the jumps, the hands were fixed at hip height. Each jump was repeated three times, with the best result being included in the study. A system of 9 CCD cameras type SMART-e 600 (BTS Bioengineering, Padua) with 20 Hz frequency and a resolution of 768 x 576 pixels was used to achieve a 3-D kinematic analysis of the vertical jumps. Analysis of the kinematic parameters was carried out using the BTS SMART Suite programme. A dynamic model was defined with a system of 17 infra-red sensitive marking points. Dynamic parameters of the drop jumps were collected with the use of two independent tensiometric force plates (Kistler Wintherthur Switzerland, Type 9286A, 600 x 400). The frequency of data collection was 1,000 Hz. The ground reaction force was measured unilaterally and bilaterally. The analysis included the following dynamic parameters: maximal ground reaction force with the left and right leg, total impulse of the ground reaction force, the impulse of force with the left and right leg.

Results

The results in Tables 1 and 2 reveal that the athletes on average achieved better results for the drop jump from a 45 cm height (45.22 ± 4.65 cm). The difference between the 25 and 45 cm drop jumps was 1.47 cm. The best result (51 cm) was achieved by subject A, who also possessed the best triple jump result. The average value of the measured subjects' contact time was lower in the drop jump from a 45 cm height. The duration of the eccentric phase did not vary between the jumps; however, a difference in the concentric phase is apparent.

Table 1: Kinematic and dynamic parameters of the 25 cm drop jump (DROP JUMP 25 cm)

Parameter	Unit	A	B	C	D	Mean	SD
DJ25H	cm	49.6	40.4	46.4	38.6	43.75	5.13
DJ25TIMECON	ms	88	83	108	80	89.75	12.60
DJ25TIMEECC	ms	67	52	75	94	72.00	17.49
DJ25CONTACT	ms	155	135	183	174	161.75	13.44
DJ25FL	N	1382	1539	753	1937	1402.75	492.13
DJ25FR	N	1354	1474	893	1752	1368.25	358.00
DJ25IMPR	Ns	141	118	88	139	121.50	24.63
DJ25IMPL	Ns	146	127	103	103	132.25	22.38
DJ25VEL	ms ⁻¹	2.88	2.56	2.99	2.99	2.77	0.19
DJ25DOWN	ms ⁻¹	-2.68	-2.26	-2.86	-2.86	-2.55	0.27
DJ25ANKLEL	deg	20	10	23	23	19.50	6.65
DJ25ANKLER	deg	20	11	24	24	20.00	6.37
DJ25KNEEL	deg	54	42	62	62	54.75	9.21
DJ25KNEER	deg	50	26	70	70	51.50	18.85

Key: DJ25H-height of jump, DJ25TIMECON – duration of concentric phase of take-off, DJ25TIMEECC – duration of eccentric phase of take-off, DJ25CONTACT – total contact time, DJ25FR – maximal force (right leg), DJ25JFL – maximal force (left leg), DJ25IMPR – force impulse (right leg), DJ25IMPL – force impulse (left leg), DJ25VEL – velocity of take-off, DJ25DOWN – eccentric velocity, DJ25ANKLER – angle of knee joint (right leg), DJ25ANKLEL – angle of knee joint (left leg), DJ25KNEER – angle of ankle joint (right leg), DJ25KNEEL – angle of ankle joint (left leg)

Table 2: Kinematic and dynamic parameters of the 45 cm drop jump (DROP JUMP 45 cm)

Parameter	Unit	A	B	C	D	Mean	SD
DJ45H	cm	51.0	42.2	46.9	40.8	45.22	4.65
DJ45TIMECON	ms	83	84	100	79	86.50	9.25
DJ45TIMEECC	ms	68	59	72	91	72.50	13.47
DJ45CONTACT	ms	151	143	172	170	159.00	11.03
DJ45FL	N	1482	1601	830	2025	1484.50	494.66
DJ45FR	N	1439	1504	893	2017	1463.25	459.73
DJ45IMPR	Ns	147	134	93	147	130.25	25.57
DJ45IMPL	Ns	152	134	105	165	139.00	25.98
DJ45VEL	ms ⁻¹	2.92	2.71	3.05	2.76	2.86	0.15
DJ45DOWN	ms ⁻¹	-3.09	-2.83	-3.21	-2.73	-2.96	0.22
DJ45ANKLEL	deg	18	10	24	24	19.00	6.63
DJ45ANKLER	deg	21	12	24	26	20.75	6.18
DJ45KNEEL	deg	54	44	58	60	54.00	7.11
DJ45KNEER	deg	50	32	64	60	51.50	14.27

Key: DJ45H – height of jump, DJ45TIMECON – duration of concentric phase of take-off, DJ45TIMEECC – duration of eccentric phase of take-off, DJ45CONTACT – total contact time, DJ45FR – maximal force (right leg), DJ45JFL – maximal force (left leg), DJ45IMPR – force impulse (right leg), DJ45IMPL – force impulse (left leg), DJ45VEL – velocity of take-off, DJ45DOWN – eccentric velocity, DJ45ANKLER – angle of knee joint (right leg), DJ45ANKLEL – angle of knee joint (left leg), DJ45KNEER – angle of ankle joint (right leg), DJ45KNEEL – angle of ankle joint (left leg)

Namely, in the drop jump from a 45 cm height, the duration of the concentric phase was more than 3 milliseconds shorter. The surface reaction force in the drop jump from a 45 cm height was recorded at $2,947 \pm 366$ N, compared to $2,770 \pm 411$ N in the drop jump from a 25 cm height. Separate results of the ground reaction force measured with the bipedal force platform revealed that the measured subjects developed greater force with the left (dominant) leg in drop jumps from both heights. The difference in the ground reaction force between the left and right leg amounted to 34 N in the drop jump from 25 cm and 21 N from the 45 cm height. The vertical velocity of the take-off in the drop jump from 25 cm was recorded at 2.77 ± 0.19 ms⁻¹ and 2.86 ± 0.15 ms⁻¹ in the 45 cm drop jump. The velocity of the measured subjects in the eccentric phase of the take-off in the 45 cm drop jump was 0.41 ms⁻¹ larger than in the 25 cm drop jump. The amplitude of the knee flexion was identical in both drop jumps.

Discussion

Drop jumps are one of the most important methods in the training process of female and male triple jump athletes. In addition, they are an important diagnostic instrument for controlling specific take-off power. The purpose of drop jumps is to reduce the duration of amortisation, which generates the optimal switch from an eccentric to a concentric contraction. If an eccentric contraction is not followed quickly enough by a concentric one, there is a loss of the elastic energy which has been stored in the cross bridges of muscles. In a phase of muscle and tendon elongation (prestretch), the main part of elastic energy is stored in serial elastic muscle elements – aponeurosis, tendons and cross bridges (Bobert, van Ingen Schenau, 1988). Some of the elastic energy is only available for 15–100 milliseconds (Komi and Gollhofer, 1997). The amount of elastic energy that is stored also depends on the force of the muscle stretch and the muscle-tendon complex stretch. Rigidity of both systems is therefore important. Triple jump athletes in particular develop more rigidity in muscles (m. gastrocnemius) than in the Achilles tendon (Zatsiorsky, 1995). It is a known fact that the muscle-tendon complex in conditions of a higher velocity stretch-shortening cycle can store a larger amount of kinetic energy in the form of elastic energy (Bobert, van Soest, 2000; Komi, 2000). Generating elastic energy also means shorter contact times, which is a decisive factor for maintaining horizontal velocity in a triple jump. Where contact times with the ground are longer (more than 200 milliseconds), some of the absorbed elastic energy transforms into heat energy (Komi, 2000; Komi, Nicol 2000). Studies have revealed (Perttunen et al., 2000; Panoutsakopoulos, Kollias, 2008) that among female elite triple jump athletes the contact times vary in the different jumps (hop, step, jump) from 120 to 185 milliseconds. Similar results were revealed in drop jumps on the sample of female athletes in the present study.

According to the results of the present study, it may be concluded that in the 45 cm drop jump the sample of female triple jump athletes achieved a larger vertical height (45.22 ± 4.65 cm), shorter contact times (159 ± 11.03 ms), higher vertical velocity of the take-off (2.86 ± 0.15 ms⁻¹) and a greater bilateral ground reaction force ($2,947 \pm 27.88$ N) at identical amplitudes in the knee and ankle joints. In the 45 cm drop jump, the athletes developed a 7.01% larger ground reaction force than in the 25 cm drop jump. Individual results showed the unilateral ground reaction force of the left (dominant)

leg at $1,402 \pm 492$ N and of the right leg at $1,368 \pm 358$ N. The difference in the maximal ground reaction force between the dominant and non-dominant leg was 34 N, whereas in the 45 cm drop jump it was only 21 N. All but one of the measured subjects (subject C) developed a larger ground reaction force with the dominant leg for both types of drop jump. Drop jumps from a 45 cm height require larger eccentric velocity in the amortisation phase, which amounted to -2.96 ± 0.22 ms⁻¹ in comparison to -2.55 ± 0.27 ms⁻¹. Apparently, female elite jumpers use a strategy of jumping with a fast stretch-shortening cycle. Namely, only a fast switch of an eccentric contraction to a concentric contraction whilst using the stretch reflex allows the efficient transfer of elastic energy from the first to the second phase of the take-off action. This was clearly manifested with the vertical velocity of the take-off in the concentric phase of a jump. In the 45 cm drop jumps the female jumpers achieved a vertical take-off velocity of 2.86 ± 0.15 ms⁻¹, compared to 2.77 ± 0.19 ms⁻¹ in the 25 cm drop jumps. The best athlete, subject A, also showed the largest absolute take-off velocity of 3.09 ms⁻¹. Vertical take-off velocity is strongly correlated with the height of a jump. In the 45 cm drop jump the female athletes achieved on average 3.3% better results than in the 25 cm drop jump. The average value of the height of a jump in the 25 cm drop jump was 43.75 ± 5.13 cm and in the 45 cm drop jump it was 45.22 ± 4.65 cm. Subject A also achieved the best absolute height of a jump of 51 cm.

A basic precondition for the efficient execution of drop jumps is suitable preactivation of agonist and antagonist muscles, which provide increased rigidity of the ankle joint. Rigidity is a responsibility of the central motor programme (joint stiffness regulation), which controls and synchronises the functioning of the flexors and extensors of the feet prior to making contact with the ground (Bobbert, 1990; Gollhofer, Kyrolainen, 1991; Voigt, 1995; Nicol et al., 2006, Joshua et al., 2011). This preactivation is revealed in the low amplitude of the plantar flexion of a foot on landing, which was measured at $52.7^\circ \pm 11.4^\circ$. Simultaneously, a low amplitude was also revealed in the knee joint ($19.9^\circ \pm 1.8^\circ$).

Conclusion

Drop jumps are extremely important training tools for male and female triple jump athletes. They are used to improve the function of eccentric-concentric muscular modulation in lower extremities. In addition, these jumps are a very reliable and objective measuring instrument for diagnostics and planning of the training process. The present study revealed that drop jumps from a 45 cm height provide the best effects in terms of developing take-off strength in conditions of eccentric-concentric contractions. Nevertheless, since the sample of elite female triple jump athletes was relatively small the results must be observed with a certain amount of tolerance. Undoubtedly, the results of the current study importantly contribute to understanding the rules of plyometric strength training.

References

1. Bobbert, M., & van Ingen Schenau, G. (1988). Coordination in vertical jumping. *Journal of Biomechanics*, 21:249-262.
2. Bobbert, M. (1990). Drop jumping as a training method for jumping ability. *Sports Medicine*, 9 (1), 7-22.
3. Bobbert, M., & van Soest, A. (2000). Two joint muscles offer the solution, but what was the problem. *Motor control*, 4 (1), 48-52.
4. De Luca, C. (1997). The use of surface electromyography in biomechanics. *Journal of Applied Biomechanics*, 13, 135-163.
5. Graham-Smith, P., & Lees, A. (1994). British triple jumpers 1993: approach speeds, phase distances and phase ratios. *Athletic Coach*, 28, 5-12.
6. Gollhofer, A., & Kyrolainen, H. (1991). Neuromuscular control of the human leg extensor muscles in jump exercises under various stretch-load conditions. *International Journal of Sports Medicine*, 12, 34-40.
7. Joshua, T., Weinhandl, J., Smith, D., & Dugan, L. (2011). The effects of repetitive drop jumps on impact phase joint kinematics and kinetics. *Journal of Applied Biomechanics*, 27, 108-115.
8. Komi, P., & Gollhofer A. (1997). Stretch reflex can have an important role in force enhancement during SSC exercises. *Journal of Applied Biomechanics*, 13 (14), 451-459.
9. Komi, P. (2000). Stretch-shortening cycle: a powerful model to study normal and fatigued muscle. *Journal of Biomechanics*, 33 (10), 1197-2006.
10. Komi, P., & Nicol, C. (2000). Stretch-shortening cycle fatigue. In: McIntosh, B. and Nigg, B. (eds), *Biomechanics and Biology of Movement*. Champaign (IL): Human Kinetics.
11. Nicol, C., Avela, J., & Komi, P. (2006). The stretch-shortening cycle. *Sports Medicine*, 36 (11), 977-999.
12. Panoutsakopoulos, V. & Kollias, I. (2008). Essential parameters in female triple jump technique. *New Studies in Athletics*, 4, 53-61.
13. Perttunen, J., Kyrolainen, H., & Komi, P. (2000) Biomechanical loading in the triple jump. *Journal of Sports Science*, 18, 363-370.
14. Voigt, M., Simonsen, E., & Klausen, K. (1995). Mechanical and muscular factors influencing the performance in maximal vertical jumping after different prestretch loads. *Journal of Biomechanics*, 28 (3), 293-307.
15. Zatsiorsky, V. (1995). *Science and practise of strength training*. Champaign (IL): Human Kinetics.

STUDY OF ELITE FEMALE ROWERS' AEROBIC FITNESS DURING THE ANNUAL PREPARATORY CYCLE

Ruta Dadeliene, Einius Petkus, Rutenis Paulauskas, Kazys Milasius and Algirdas Raslanas

Lithuanian University of Educational Science, Lithuania

Abstract

The aim of the research was to establish aerobic fitness of elite female rowers and its changes in the annual cycle. Two elite female rowers, European and world champions, were investigated in the preparatory cycle. Aerobic capacity was tested using gas analyser system. The study investigated the cardiovascular functional capacity. While preparing for the 2013 World Championship, aerobic fitness of rowers of the Lithuanian pair double scull significantly progressed at the point of anaerobic threshold and critical intensity and reached a very high level of working capacity without a significant change in pulmonary ventilation and the increase of rowing economy. Meanwhile, the cardiovascular functional capacity during the preparatory period changed rather slightly.

Key words: preparatory cycle, female rowers, aerobic capacity

Introduction

Lithuanian rowers have been making the country known in the world for many years. Both men and women have achieved significant wins in the European and world championships and the Olympic Games. Sports scientists widely explore the training of rowers under Lithuanian climatic and economic conditions (Petkus, 2010). Researchers Fikerstrand, Seiler, (2004) **point** out that in a rowing (2 km event) contest, 80-82 percent of the mechanical energy is produced by using oxygen. According Steinacker (1993) this consists of 75-80 percent. It has been found that rowers' $\text{VO}_{2\text{max}}$ is between 5.8 and 7.7 l/min (Petibois et al., 2003), working capacity at the point of critical intensity is 450-550 W. During distance passing, work intensity changes and at the end of event glycolytic reactions become considerably active. This activity is also very important (De Compos Mello et al., 2009; Smith, Hopkins, 2011). An important indicator is the reached oxygen uptake and the capacity level at the point of the anaerobic threshold (Petibois et al., 2003). It would be relevant to establish Lithuanian elite female rowers' aerobic fitness level and its changes in the annual cycle. So the research problem arises to investigate aerobic fitness of elite female rowers, world champions, at the point of critical intensity and anaerobic threshold, as well as its changes in the annual cycle. Research object was the changes of female rowers' aerobic fitness.

Research aim was to establish aerobic fitness of elite female rowers and its changes in the annual cycle.

Methods

Two elite female rowers (height – 170,0 cm and 175,5 cm, body mass – 65,5 kg and 66,0 kg, muscle mass 34.9 kg and 35,0; fat mass 5,5 kg and 7,1 kg) were investigated. Their aerobic fitness was studied in the annual training cycle of 2012-2013. The first testing session (T1) was carried out at the beginning of the preparatory period. The second testing session (T2) was carried out in the competition period. Testing was performed between 11 a.m. and 2 p.m. and at the same time of day, as T1 for each participant in the same location. It can be noted, that the procedures involved for T1 and T2 were identical.

For evaluation of aerobic capacity, was used test with constantly increased physical workload (Nowacki, 1978). For recording data we used gas analyser system Oxycon Mobile 781023-052 version 5.2 (Cardinal Health Germany 234 GmbH, Germany). Pulmonary ventilation (PV) (l/min), heart rate (HR) (beats/min), oxygen uptake (VO_2) (l/min, ml/min/kg), oxygen pulse (OP) (ml/beat), working capacity (W), rowing economy (l W/ml) at the point of the anaerobic threshold and the point of the critical intensity were recorded. The study investigated the cardiovascular functional capacity in determining blood pressure while seated with RI-SAN (Rudolf Riester, Germany) and recording heart rate. Resting heart rate (beats/min) was assessed in supine position with Polar FS1 (Polar Electro Oy, Kempele, Finland) after 5 min of lying in the supine position, during active orthostasy, in response to standard physical load (30 squats within 45 s) and during 60 s recovery period in lying position. Lactate concentration (La) (mmol/l) was measured by analyzer Lactate Pro LT-1710 (ver. 1,0), ARKRAY, taking capillary blood from finger.

Results

The results (Table 1) shows that at the point of critical intensity pulmonary ventilation of rower D. V. during the testing period increased by 12 l/min, for rower M. V. it decreased by 3 l/min. HR changes also varied, for athlete D. V. it increased by 9 beats/min, for M.V. it decreased by 10 beats/min. Oxygen uptake increased for both athletes and reached a very similar level. Initial level of oxygen uptake for athlete M.V. was much lower than that of athlete D.V., so it increased much more (1.12 l/min and 16.9 ml/min/kg). Athletes' oxygen pulse was of similar level, but for athlete M.V. it increased significantly more. Working capacity for athlete D.V. increased by 60 W, and for athlete M.V. – by 10 W. Rowing economy during the research period did not improve.

The analysis of the data at the point of anaerobic threshold shows that pulmonary ventilation of athlete D.V. did not change, and her heart rate decreased by 11 beats/min; her O₂ uptake increased by 2.2 ml/min/kg, working capacity increased by 20 W and rowing economy remained almost unchanged. Blood lactate concentration after the test was 1 mmol/l lower than that in the first study. Pulmonary ventilation for athlete M.V. at the point of anaerobic threshold increased by 15 l/min. The heart rate changed from 175 beats/min to 173 beats/min. VO₂ increased significantly – from 47.7 to 61.9 ml/min/kg; working capacity increased by 30 W, and blood lactate concentration during the second study was slightly lower than that during the first study.

The analysis showed that throughout the observed period cardiovascular function capacity indices changed insignificantly (Table 2). The resting heart rate of athletes decreased by 8 beats/min for athlete D.V. and for athletes M.V. it increased by 4 beats/min. Response to orthostatic testing for both athletes was normal and changed only slightly. Response to the standard physical load for athlete D.V. increased by 10 beats/min, but for athlete M.V. it decreased by 4 beats/min. Recovery per minute in the second test for both athletes accelerated. Athletes' blood pressure remained almost unchanged.

Table 1: Research data on rowers' aerobic fitness

Testing session	Name	Point of critical intensity							Point of anaerobic threshold							La mmol/l	
		PV l/min	HR beats/min	VO ₂ l/min	VO ₂ ml/min/kg	OP ml/beat	W	O ₂ 1W/ml	PV l/min	HR beats/min	VO ₂ l/min	VO ₂ ml/min/kg	OP ml/beat	O ₂ % from VO ₂ max	W		O ₂ 1W/ml
T1	D.V.	145	190	4.06	62.6	21.60	330	12.30	110	183	3.76	57.90	20.60	92.60	270	13.90	12.7
	M. V.	129	196	3.47	52.6	17.50	340	10.20	85	175	3.15	47.70	18.00	90.78	240	9.06	9.3
T2	D.V.	157	199	4.84	70.6	24.32	390	12.41	110	172	3.84	60.10	22.35	79.30	290	13.24	11.7
	M. V.	126	186	4.59	69.5	24.62	380	12.07	100	173	4.08	61.90	23.60	88.90	270	15.12	8.8

Note: PV – pulmonary ventilation, HR – heart rate, VO₂ – O₂uptake, OP – oxygen pulse, W – watts, La - lactate

Table 2: Research data on the dynamics of rowers' heart rate (beats/min) at rest, during orthostatic test, during standard physical loads, in the restitution period and 1 min recovery

Testing session	Name	A	B	HR after 30 squats within 45s, beats /min					Blood pressure at rest
				Immediately	15s	30s	45s	60s	
T1	D. V.	56	76	119	92	72	64	64	100/60
	M. V.	52	85	124	100	88	80	80	120/70
T2	D. V.	48	82	129	108	92	64	60	110/70
	M. V.	56	91	120	108	92	80	72	110/70

Note: A – heart rate per min in a supine position, B – heart rate per min while standing

Discussion

The study revealed that aerobic fitness of the Lithuanian elite rowers (world champions) at point of critical intensity and point of anaerobic threshold during the annual preparation cycle progressed and reached very high levels, exceeding the limits specified by other researchers. Riechman et al. (2002) show that high-capacity rowers' males VO₂max is between 60-68 ml/min/kg, while this index for our subjects - females in the competition period was 69.5 and 70.6 ml/min/kg. These indices were significantly higher than those of the Lithuanian female rowers who won the bronze medals in Sydney Olympic Games (56.1 and 41.2 ml/min/kg) (Petkus, 2010). The oxygen pulse rates of our tested athletes were also very high – 24.32 and 24.62 ml/beat. The study showed that the rowing economy of our subjects still has substantial reserves to improve; it has not improved yet ahead of the World Championship. Anaerobic threshold indicators are also important for high results (Ingham et al., 2002; Petibois et al., 2003). Our tested rowers' anaerobic threshold in the competition

period was at HR of 172 beats/min and 173 beats/min; VO_2 of both athletes were rather similar (60.1 and 61.9 ml/min/kg) and significantly higher than those of rowers mentioned above. Working capacity increased by 20 and 30 W. Absolute working capacity indices are close to those of Olympic medal winners, but with a significantly lower body weight the relative indices are much higher. Summarising the changes in the investigated functional indices of the circulatory system we suggest that these indicators altered only slightly and significant progress during the period of the study was not established. We argue that athletes' aerobic capacity increased with the ability of muscles to use more oxygen with little changes in systems supplying blood to muscles.

Conclusions

While preparing for the 2013 World Championship, aerobic fitness of rowers of the Lithuanian pair double scull significantly progressed at the point of critical intensity and reached a very high level of oxygen uptake and high working capacity without a significant change in pulmonary ventilation and the increase of rowing economy. Aerobic fitness of rowers at the anaerobic threshold also progressed; the HR was 172 and 173 beats/min.

Cardiovascular functions of rowers during the preparatory period changed rather slightly.

It can be assumed that for the tested athletes muscle's ability to use O_2 and produce mechanical energy through aerobic reactions improved much, while the system supplying O_2 and energy substances almost did not improve and this can be a reserve to improve movement technique and increase aerobic fitness.

References

1. De Campos Mello F., De Moraes Bertuzzi R., Grangeiro P., et al. (2009). Energy systems contributions in 2,000 m race simulation: a comparison among rowing ergometers and water. *European Journal of Applied Physiology*, 107, 615-619.
2. Fikerstrand A., Seiler, K. (2004). Training and performance characteristics among Norwegian international rowers from 1970-2001. *Scandinavian Journal of Medicine and Science in Sports*, 14, 303-310.
3. Ingham S.A., Whyte G.P., Jones K., et al. (2002). Determinants of 2,000 m rowing ergo performance in elite rowers. *European Journal of Applied Physiology*, 88, 243-246.
4. Nowacki P. (1978) Die Bedeutung der Modernen Kardio-respiratorischen Funktion Diagnostik für jugendliche Leistungssportler und Ihre Trainer. Sportärztliche und Sportpädagogische Betreuung zur Sportmedizin, 8, 153-178.
5. Petibois C, Cazorla G., Deleris G. (2003). The biological and metabolic adaptations to 12 months training in elite rowers. *International Journal of Sports Medicine*, 24, 36-42.
6. Petkus E., (2010). The training of Lithuanian high performance rowers. Summary of the Doctoral Dissertation: Social Sciences, Educational Science. Vilnius Pedagogical University. Vilnius.
7. Smith T., Hopkins W. (2011). Variability and predictability of finals times of elite rowers, *Medicine and Science in Sports and Exercise*, 43 (11), 2155-2160.
8. Riechman S., Zoeller R., Balasekaran G. Goss R., Robertson R. (2002). Prediction of 2,000 m indoor rowing performance using a 30 s sprint and maximal oxygen uptake. *Journal of Sport Science*, 20, 681-687.
9. Steinacker J.M., Both M., Whipp B.J. (1993). Pulmonary mechanics and entrainment of respiration and stroke rate during rowing. *International Journal of Sports Medicine*, 1 (14), 15-19.

Acknowledgments

The authors would like to thank participants for their involvement in the study. This study was supported by funding from Lithuanian Olympic Comity.

PAIN STATUS MONITORING AMONG INTERNATIONAL COMPETITIVE SPORT DANCERS

Vedrana Grčić, Alen Miletić and Saša Krstulović

Faculty of Kinesiology, University of Split, Croatia

Abstract

The aim of this study was to determine the gender-specific pain status among sport dance competitors by defining the proportions of pain status of fourteen body regions. The subject sample was 373 sport dancers from 50 different countries and with international competitive experience. On-line questionnaires translated into eight world languages were applied for data collection of Self-Estimated Functional Inability because of Pain questionnaire designed for dancers. According to obtained results female dancers often report pain on the upper back, ankles/feet, knees, neck, toes and lower back region. Male dancers most frequently report pain on the lower back, knees and toes region. Significant gender differences were found by the Chi-square test in the shoulders, upper and lower back, thighs (front), ankles/feet and toes region. Female dancers report pain status more frequently than male dancers in all musculoskeletal regions.

Key words: health care, SEFIP - questionnaire, pain topology

Introduction

Competitive Sport Dance is a physically and mentally demanding activity, and as a recreational activity it can be carried out through a lifetime. Therefore, it is very important to pay special attention to dancers' health and injuries prevention. Competitive couples train together, and their training duration is mostly equal. However, their dancing techniques are gender-specific, and the frequency of medical problems is not caused only by training duration and intensity. In order to compete at a world level, elite competitive dancers undergo rigorous training to help and enhance their competition performance. Extensive, long lasting, training is needed to sustain a high quality dance performance consistent over a few rounds of a competition and there is a fine line separating pain from just overwork or fatigue and pain from overuse. One of the prerequisites of a successful dancing carrier is surely the dancer's state of health. Therefore, it is necessary to do research in the area of most common topological dancer's pain prevalence. This would prevent dancers from injuries caused by training loads and demanding dance techniques. Due to previous studies on the sample of dancers, it is known that the most frequent pain prevalence and injuries are located in the region of back, knees, ankles and fingers (McMeeken et al., 2001 Luke et al., 2009. Miletić et al., 2011). These studies are important for preventing injuries in dancers because most of the locomotor injuries will from acute turn to chronic unless they are taken care of properly. The more frequent pain prevalence becomes, the more it affects the dancer's devotion in training, as well as the choreography performance itself. Commonly, rarer trainings and trainings of lesser intensity that don't require demanding technical elements, will lead to a lower quality performance. As a chain reaction, a consequence of a bad performance cannot be a good competition score. Differences in pain status are expected because the male and female dance technique is different. Even they have approximately the same training extensity, because they practicing the same choreographies, they techniques and then expected overload injuries are different. For example, male's techniques are characterized with lifting partners, and female is characterized with greater spinning and movement with larger amplitudes.

The purpose of this study was to identify the gender-specific pain status by defining the proportions of pain status of fourteen body regions. Accordingly, we analyzed and compared the results of female and male competitive international sport dancers. It is presumed that obtained informations could help making the measures for preventing injuries among dancers. Determining the critical pain sensitive gender-specific musculoskeletal points according to dancers most frequent complains, could help dancers, their coaches, choreographers and physicians.

Methods

The sample of entities in the present study included international female (N= 173) and male (N=200) Dance Sport competitors in Latin (samba, rumba, cha-cha-cha, paso doble and jive) and Standard (English waltz, tango, Viennese waltz, slowfox and quickstep) dances.

Mean age for female dancers was 24 years (range 15 to 38), mean body height 165.7 ± 6.49 cm, mean body weight 53.7 ± 6.84 kg and mean BMI 19.5 ± 1.9 . Mean age for male dancers was 25 years (range 15 to 40), mean body height 177.8 ± 7.73 cm, mean body weight 69.1 ± 10.1 kg and mean BMI 21.8 ± 2.5 .

To enable the participation of a larger number of dancers, an “on-line” questionnaire was posted on a specialized server (*surveymonkey*) for collecting and analysing data electronically on a global level. The server and the application enabled a password level of access security and automatic identification of subjects when filling out the questionnaire from a computer defined by the IP address and personal information. In this manner in this investigation were included dancers from five continents and 50 different countries. The survey consisted of questions concerning SEFIP - Self-Estimated Functional Inability because of Pain questionnaire designed for dancers. This questionnaire is a simple and valuable tool in defining the pain status in certain regions in dancers approved to be of high applicability in professional ballet dancers, S&L dancers and dance students (Miletić et al., 2011). SEFIP is an instrument that asks the subjects to assess their current pain on a 5 – point scale; with 0 being no pain and 4 being pain so severe they are unable to dance. The questionnaire covers 14 body regions (neck, shoulders, elbows, wrists/hands, upper back, lower back, hips, thighs (front), thighs (back), knees, shins, calves, ankles/feet; toes). A sum score (range 0-56) can be achieved where 0 represents no pain and 4 maximal pain. Everything above zero is regarded as a positive finding.

Pearson's χ^2 test was applied for the comparison of the proportions of pain experience in the 14 body regions between the female and male dancers. The statistical level of significance of 95% ($p < 0.05$) was applied.

Results and discussion

According to the results of the χ^2 test (Table 1) significant differences have been found between male and female dancers in the topology of pain prevalence. These include the region of neck, upper and lower back, thighs (front), ankles and toes. In all of the specified topological regions a greater value of percentage is recorded in women. The most common pain prevalence that female dancers noted is in the region of upper back and ankles/feet (53.7%), knees (50.3%), neck (50%), toes (48%) and upper back (42.2%). In male dancers, the most frequent pain prevalence is noted in the region of lower back (53.5%), knees (43%) and toes (40.5%).

Table 1: Differences between female and male dancers: number of dancers that reported any pain (1, 2, 3 or 4) and their percentages in each age group, Chi square test results (χ^2) for each body region regarding all three dance groups and degrees of freedom (df)

	male dancers (N= 200)	female dancers (N= 173)	χ^2	df
Neck	55 27.5%	88 50.0%	23.35**	3
Shoulders	72 36.0%	65 37.6%	1.26	4
Elbow	13 6.5%	8 4.6%	.69	2
Wrists/hands	20 10.0%	20 11.5%	1.77	3
Upper back	67 33.5%	73 42.2%	6.67*	4
Lower back	107 53.5%	93 53.7%	9.31*	4
Hips	40 20.0%	36 20.8%	1.38	3
Thights (front)	24 12.0%	33 19.1%	7.76*	3
Thights (back)	29 14.5%	30 17.3%	4.96	3
Knees	86 43.0%	87 50.3%	7.17	4
Shins	27 13.5%	26 15.0%	4.21	4
Calves	43 21.5%	43 24.8%	3.16	3
Ankles/feet	74 37.0%	93 53.7%	13.67**	4
Toes	81 40.5%	83 48.0%	6.77*	4

*Denotes significant coefficients on the level $p < 0.05$;

**Denotes significant coefficients on the level $p < 0.01$;

Pain prevalence in the lower back region, after a long and intense training, is well known in dancers. This is caused by technical requirements for performing dance figures in sport dance, forcing stiff and not-physiological positions, especially in standard dances. This is not only characteristic for adult and professional dancers. Miletić, Miletić & Maleš (2008) have recorded pain prevalence in the lower back region in sport dance beginners. Also, McMeeken et al. (2001) have stated that the risk of back injury in adult dancers is largely increased if they train more than 30 hours per week, while in adolescents that number is significantly decreased in 8 hours per week of intense training.

Nilsson et al (2001) have explained high percentage of pain prevalence in the region of knees in both sexes, by often acute painful syndromes in the region of feet and ankles that are transferred onto the next weak link of the locomotor system – knee, which was sampled on ballet dancers. These indicative facts are confirmed by medical informations about acute injuries of the lower extremities. It is known that dancing techniques encumber knees and calves. By strengthening calf muscles in training, it is possible to alleviate the burden that is transmitted to the knees, and by that also prevent knee injuries. Dysfunction of the kinesthetic chain as a result of overloading, leads to pain prevalence in the region of ankles and toes. Pain prevalence in toes can be a consequence of insufficient muscle development, tightened footwear and demanding spinning techniques as well as balancing on the surface of the frontal part of feet. It is important for pain prevalence, especially of higher intensity, to react by lessening training load of painful regions, so serious injuries could be avoided. Although training load of male and female dancers in pairs is closely similar, it is clear that specificity of pain prevalence is different for both sexes. Dancers often endure pain for their partners, because absence from trainings means badly rehearsed choreographies and figures that are performed in pair, so this would also mean decreased competition score.

In conclusion different pain occurrences could be indicator for proper training load as follows: (1) higher incidence of neck pain among female dancers is probably connected with gender specific poses required in Standard dances (English and Wien waltz), and could be decreased with proper relaxation during training pauses; (2) increased pain prevalence in lower and upper back and front thighs among female dancers is mostly caused by frequent and sudden movement with extreme amplitudes that could be decreased with proper warm up and better organized flexibility training; and (3) higher ankle and feet pain sensation are probably consequence of improper female training shoes with high heels. That is why pain endurance in dancers is commonly disguised; therefore their detection and rehabilitation should be treated very seriously.

References

1. Luke, A. C., Kinney, S.A., D'Hemecourt, P. A., Baum, J., Owen, M., & Micheli, L. J. (2002). Determinants of injuries in young dancers. *Med Probl Perform Art*, 17(3), 105-112.
2. McMeeken, J., Tully, E., Stillman, B., Nattrass, C., Bygott, I.L., & Story, I. (2001). The experience of back pain in young Australians. *Man Ther*, 6(4), 213-220.
3. Miletić, A., Kostić, R., & Miletić, Đ. (2011). Pain prevalence among competitive international dancers. *Athletic Therapy Today*, 16(1), 13-16.
4. Miletić, A., Miletić, Đ., & Maleš, B. (2008). Morphologic differences and pain status monitoring in dance training. *Facta Universitatis. Series: physical education and sport*, 6(2), 159-168.
5. Nilsson, C., Leanderson, J., Wykman, A., & Strendel, L.E. (2001). The injury panorama in a Swedish professional ballet company. *Knee Surh Sports Traumatol Artrosc*, 9(4), 242-246.

THE DIFFERENCES BETWEEN THE GROUPS OF PLAYERS AT DIFFERENT LEVELS OF COMPETITION IN THE TESTS FOR ASSESSING FITNESS PREPAREDNESS

Marko Hrgetic¹, Marko Milanović² and Ivan Krakanić³

¹*TowerFitness, Croatia*

²*Tehničko Veleučilište u Zagrebu, Croatia*

³*Faculty of Kinesiology, University of Zagreb, Croatia*

Abstract

The aim of this study was to analyze the differences between the two groups of players at different levels of competition in the fitness indicators of preparedness. For the purpose of this study a selection of measuring instruments will be carried out and the soccer teams at different levels of competition, that will be included in the set-up testing, will be determined. Seventeen players from two different clubs will be tested by the following tests: Abs ABC, 300Y, LJ, 93639RS, 93639RWT, S & R.

The differences between the two groups of players will be determined by applying discriminative analysis (discrete). In order to show the differences between the two teams of players the global difference well as the value of each of the variables will be determined.

Key words: *difference, fitness, soccer, tests*

Introduction

Soccer is a team sport played between two teams consisted of eleven players. It is played with a soccer ball on a rectangular grass or artificial surface field.

The playing field is a rectangular. For the international matches, the length should not exceed 90 to 100 feet, and the width should be between 65 and 75 meters. These lines are called long - throw lines, while the shorter ones are called goal lines. The touchline must be longer than the goal line. The goals are set. The goal consists of a beam and two tripods. A standard adults match consists of two parts of 45 minutes known as a half. So, the game lasts 90 minutes. There is usually a break of 15 minutes between the two halves.

Soccer belongs to polystructural complex movements characterized by a very large number of different movements and techniques that take place in varying situations. The analysis of the structure of soccer tells us that the success of players in soccer depends on a number of skills and qualities. Soccer is predominantly aerobic - anaerobic sport. In soccer there is a great aerobic load for the player. In recent years, soccer is played faster and faster. Modern technology for monitoring the game shows us clearly some arguable points about the players that cannot be seen with unaided eyes, where and when they make mistakes, the movements lines, the number of kilometres they have run all around and across the field, their playing technique etc.

The importance of the game of soccer is in the physical conditioning of players. The number of matches increases every season. Accordingly the number of trainings is increased, too. To bring the players withstand the body and physical effort the coaches must improve training methods each season. It is important to note that due to the large number of different learning activities and movements of high and low intensity, the coaches should be aware of overtraining and injuries that occur during the training. Without previously training the players will find it difficult to reach the set goal and results. Most clubs have fitness programs that are not adequate. It is not enough to power the components. It primarily refers to the explosive force, despite the fact that different players, to the available data, only 1-11 % of the time in the game spend sprinting, which is 3 or 5% of the effective time of one match. Most of the time players are walking or running slowly.

The soccer players sprint every 90 seconds, and each player's sprint takes 2-4 seconds, and 1000 to 1400 changes in direction are made during the matches (Mohr, Krustup and Bangsbo 2003; Bangsbo, Noregaard and Thorso, 1991, et al., 2000, Reilly and Thomas, 1976).

A larger number of authors have studied the types and amount of movement of players during the game and they get different results. Okashi et al. (1991st According to Castagna et al., 2003) provided results that show that Japanese players cover 11, 529 meters in one match while most players cross the distance from 8.680 to 11.527 meters in the game. Soccer matches consist of 1000-1200 motion changes, this means that the change in activity takes place every 5-6 seconds with

short breaks. Movements consist of walking (25%), jogging (37%), submaximal running (20%), sprint (11%), running back (7%) with the proviso that all of these developments include multi-directional movement (Ekblom, 1994 by Jeffreys, 2004).

During a soccer game, players cross 1200-1400 changes of various activities, changing them every 4-6 seconds. Nowadays, players pass between 10 and 13 km during the game, of which 2% are movements with the ball, the rest are movements without the ball. During the match, a top player on average does between 30-35 sprints, with the fact that each sprint lasts for about 2 seconds. The most common distance travelled by a top soccer player is 10-15 meters. In addition to the sprint the top player performs 15-20 duels with the opponent, about 10 jumps and kicks with his head, about 40-50 contacts with the ball and about 20 dribbles and 30 times passing the ball. On average a player performs between 600 and 800 different turns. During a soccer game, the relative heart rate of players is on average 85% of the maximum heart rate, and varies between 75% and 100% of the maximum heart rate. Anaerobic threshold is achieved in 80-90% of maximum heart rate, this means that the average intensity of players fits ventilatory threshold (Markovic Bradic, 2008).

Goal of the work

The main objective is to analyze the differences between the two groups of players at different levels of competition in the fitness indicators of preparedness. For the purpose of this study the two groups of soccer clubs according to the rank contests were chosen.

H₀: there is statistically a significant difference between the players in different levels of competition variables for assessing fitness preparedness.

Methods of work

The working methods will analyze a sample of players, who will form a group of senior players of higher and lower quality levels.

When applying the methods we must be aware of the aim and objectives of the training process, what the athletes do, the age of group athletes, where and when the training process is carried out, and which aids are used.

The sample

The first group will consist of 17 players seniors low class soccer teams, and the other group will be composed of 17 senior first division football teams. It is evident that 17 examiners are footballers who didn't pass selections for the top team. The other group is consisted of 17 players who have passed quality soccer school and gained higher condition preparedness and technical and tactical knowledge. 17 soccer examiners in each group will be sufficient for the analysis of significant differences for basic and specific motor skills.

Variables

To assess the fitness of preparedness six tests for assessing fitness preparedness will be used.

Variables for assessment of fitness preparedness players

- Seat&reach:** This test involves sitting on the floor with your legs extended straight forward. Shoes should be removed. Feet are placed in a straight line. With palms down and hands on top of each other or side by side, the subject reaches forward along the measuring line as possible as he can.
- 93639 runnings with turn:** The test is performed on the 18 meters long track. The starting line is one meter in length, and parallel to it, at the distances of 6, 9 and 12 meters cones and the 18 meter target line length of 1 meter. The player starts from a standing position.
- 93639 running straight:** The test is performed on the track 18 meters long. The starting line is marked one meter in length, and parallel to it, at the distances of 6, 9 and 12 meters the cones and the 18 meter target line length of 1 meter. The player starts from a standing position. During the performance the subject is facing the chest all the time towards the finish line and without the head spin or rotating the torso.
- Abs Abc:** The task is within 60 seconds to perform as much as possible lift troops from lying on his back holding hands joined behind his head.
- Long jump:** The player standing in line, with the measuring tape in front. Measured 3 times.
- 300 Yards:** The test is carried out in the gym or outdoors in a way to draw two parallel lines, the length of one meter at a distance of 22.84 meters. The maximum speed running length of 12, and timekeepers record passing of each share, as and the final result.

Test	Test mark	Measure of the test	Intencional measure of the test
1. Seat&Reach	S&R	Centimetres	Flexibility
2. 93639 running with turn	93639OK	Seconds	Agility
3. 93639 running straight	93639NN	Seconds	Agility
4. Abs abc	TRBUH ABC	Repetitions	Repetitive strenght
5. Long jump	SDM	Centimetres	Explosive power of jump type
6. 300 yards	300YARDI	Seconds	Speed endurance

Variables are consisted of 6 classic motor skill tests, some belonging to repetitive strenght (4), speed endurance (6), agility (2, 3), flexibility (1) and explosive power of jump type (5). All these motor skills represent important factors for successfull and efficient soccer playing at all ranks including top rank and amater rank.

Methods of data processing

Data processing methods for determining the difference between the two groups of players have been applied to the following methods:

- Processing of basic statistical parameters
- T-test for independent samples difference

Basic statistical parameters describing the variable, ie the sample is measured on the variables. Basic statistical parameters are divided into measures of central tendency and measures

Results and Discussion

Table 1: T-test differ the two different groups of players quality levels in variables for assessing fitness preparedness

T-test; Grouping: Grupa 1=NNR; 2= NVR					
	Mean G 1:1	Mean G 2:2	t-value	df	p
1. S&R (cm)	11,3971	11,9235	-0,32459	32	0,747601
2. 93639OK	7,5659	7,5000	0,65349	32	0,518111
3. 93639NN	7,4888	7,7853	-3,01386	32	0,005014
4. Abs ABC(pon)	52,9412	62,2941	-4,00897	32	0,000342
5. SDM(cm)	231,1190	239,5850	-1,60312	32	0,118735
6. 300	65,9824	66,0647	-0,15308	32	0,879298

Legend: MEAN - the arithmetic mean of the group, the T-value - the value of the t-test, df - degrees of freedom, p - significance level, NVR-soccer team of senior-level competition, NNR-soccer team of lower level of competition

It seems that the players of top rank are achieving 10 more repetitions then the lower rank soccer players in the test for strenght repetition of abs. That means that top rank soccer players have higher level of stability and strength of core which is important factor for motor skills for defense and offense in soccer.

According to the chart below we can see that the two tests are statistically significant. In the third test, running back and forth 93639 (93639NN) there are statistically significant differences according to values of t-test -3.01. In this test, better results are achieved for low class players. Test lift the upper body (TRBUHABC) also shows a statistically significant difference where the better team is of senior rank.

However, the other tests show that the team of higher rank generally is better than lower-level teams. Lower rank team has better results in the test 93639NN, while higher-ranked team has similar results, but in more complicated structure movements it has better results.

According to the results we see that the players premier league teams are better prepared than low class of players . Two variables that significantly differ two teams at different levels are running back and forth 93639 (93639NN) and lift the upper body (TRBUHABC).

Conclusion

According to the results we see that the players premier league teams are better prepared than low class of players . Two variables that significantly differ two teams at different levels are running back and forth 93639 (93639NN) and lift the upper body (TRBUHABC).

In this section, an analysis of the differences between the two groups of players different quality using the t - test for independent samples is made. The values obtained show that only in the two test of fitness preparedness there are significant differences between the two groups of players. It should be noted that of the six variables of conditional readiness, four variables are performed better by the players of the first division, and in one test by the lower-level players, while the tests running 300 yards (300) for estimating speed endurance are almost equal. Interestingly, in a test run back and forth 93639 (93639NN) better results are achieved by lower-level players, while the test of raising upper body (TRBUHABC) is performed better by the players of a higher rank, which means they have more power AB muscle than the lower-level players. According to the results, we can say that the major league team is generally superior team, better prepared and of better fitness than lower rank team. The bad news is the fact that the test running 93639 back and forth (93639NN) is better performed by the players of lower rank. This means that the major league teams in their development process ignore the ability of agility, which is one of the most important factors in the success of the football and you have to specifically work on that front.

This work is only one segment of the analysis of the state of preparedness of two different qualities teams and certainly not intended to be comprehensive in defining the state of preparedness of players as it takes to improve the system tests, increase the number of respondents, low class track and major league teams and over a longer period of time.

References

1. Ermanno Rampinini, Aldo Sassi, Andrea Azzalin, Carlo Castagna, Paolo Menaspa, Domenico Carlomagno, Franco M. Impellizzeri. (2009). Physiological determinants of Yo-Yo intermittenr recovery test in male soccer players, *European Journal of applied Physiology*, Volume 108, Number 2, 401-409, DOI: 10.1007/s00421-009-1221-4
2. Jose Carlos Barbero Alvarez, Stefano D'Ottavio, Juan Granda Vera and Carlo Catagna. (2009). Aerobic Fitness in Futsal Players of Different Competitive Level, *J Strength Cond Res* 23(7): 2163-2166
3. K.A.P.M. Lemmink, R. Verheijen, C. Visscher. (2004). The discrimitive power of the Interval Shuttle Run Test and the Maximal Multistage Shuttle Run Test for playing level of soccer. *Journal of Sports Medicine and Physical Fitness*, September 2004; 44, 3, 233-239
4. Sera N. Dogramaci, Mark L. Watsford, and Aron J. Murphy. (2010). Time-Motion Analysis of International and National Level Futsal, *J Strength Cond Res* 25(3): 646-651
5. Sportski trening. (2010). *Što treba znati o fizičkoj pripremi*. S mreže skinuto 20.1.2011. s adrese :<http://www.sportskitrening.hr/sto-treba-znati-o-fizickoj-pripremi>

FREE THROWS NUMBER AND ACCURACY IMPACT ON THE RESULT OF BASKETBALL GAME

Rasa Kreivytė

Lithuanian Sports University, Kaunas, Lithuania

Abstract

Free throws indicators (number and accuracy) are one of the 18 parameters of the competitive activity that are officially recorded in every game and that can have a substantial impact on the victory among the winners and losers teams in important competitions. The aim of this research was to identify and assess the top-level women's basketball teams free throws influence on the final result of the official game. Technical protocols (n=54) of the 2013 year European championship match women's basketball teams (n=16), which were provided on the official championship website (www.fibaeurope.com). Free throws indicators (number and accuracy) between the winners and losers teams were recorded: all games, the game that ended in a one-digit points lead and playoff, finals. Women's basketball teams in an average during one game scored 64.3 ± 12.2 points. The winning teams scored 71.0 ± 8.9 , while the losing teams - 57.6 ± 11.4 points. During championship among winners and losers the game ended 13.4 ± 8.5 points. In average during one game teams gave 15.8 ± 7.3 free throws, the accuracy of the throws was $73.0 \pm 14.4\%$. Teams, which have won the game, in the championship during one game had 18.4 ± 7.1 free throws and the accuracy of throws accounted for $72.0 \pm 12.5\%$. Teams, that lost the game, stood at the free throw line after 13.1 ± 6.6 times, throwing $75.8 \pm 15.0\%$ in accuracy. During championship collected points from the free throw line accounted for $17.5 \pm 7.6\%$ from all points earned: winning the game teams $18.1 \pm 7.6\%$, unsuccessful teams $16.8 \pm 7.6\%$ of all earned points during the game.

Key words: women's basketball teams, competitive activity parameters, quantitative and qualitative indicators

Introduction

The analysis of Europe's best basketball teams match performance indicators provides a lot of objective information about the basketball game, its development and results. A number of authors (Mendes & Janeira, 2001; O'Donoghue, 2010) as one of the main sport science research field consider the research of match performance (game) indicators, the change of their characteristics in most important matches. Team game, it's change can be evaluated by analyzing quantitative (throws into the bag from a variety of distance, free throws, rebounds, etc.) and qualitative (throws into the bag effectiveness, variety and etc.) indicators. Match performance indicators are often analyzed aiming to determine the differences of winners and losers teams (Csataljay et al., 2009, Dezman, et al., 2002).

The International basketball federation (FIBA) has determined 18 indicators of match performance, which are officially registered in all matches. One of these indicators are free throws, which number during the match shows the activity of the team in organizing and ending attacks, the accuracy of throws – stability of technical action, having physical and mental loads, players mental stability, reliability of players. When elite men basketball teams play, free throws create a percentage from 20% to 25% from all gained points during the match (Mersky, 1987). These throws become more important at a later game stage – free throws create 35% from all the points during last 5 minutes of match (Kozar et al., 1994), and during the match, which ended with the difference of nine or less points, free throws of winners team create 48% of all points during the last five minutes of match and 69% points during the last minute of the game.

Playing point-to-point, at the end of the match there are opportunities to throw free throws, so it is necessary to make these shots efficient (Trninić et al., 2002). The analysis results of such important match provides useful information on the most important game elements, which determine differences between winners and losers teams. The knowledge of decisive match performance allows coaches to prepare more accurate match schemes and to create the best strategy for winning the game.

The primary aim of this research was to determine and evaluate free throws (number and accuracy) influence on the final match result of elite woman's basketball teams.

Methods

Technical protocols (n=54) of the 2013 year European championship match women's basketball teams (n = 16), which were provided on the official championship website (www.fibaeurope.com). The indicators of free throws (number and accuracy), the number of points earned between the winners and losers teams were registered:

- of all championship match (n=54);
- of play-off and final match (n=12);
- of tense match, which ended in a one-digit points difference (n=20).

Statistical analysis

The SPSS for Windows 21 was used for the statistical analysis. Descriptive statistics was calculated for all experimental data. In order to compare the game indicators of winners and losers, criterion of Wilcoxon test was applied. The difference is statistically significant at $p < 0.05$.

Results

In order to identify and assess the impact of free throws on the match result, primarily we have determined in the European Championship participated winners and losers team's average points during one match. Total women's basketball teams averages during one match scored 64.3 ± 12.2 points (Table 1). The winning team scored 71.0 ± 8.9 points, while the losing team - 57.6 ± 11.4 points. During all championship between the winners and losers match ended 13.4 ± 8.5 points. Playoffs and the final match scored on average 68.2 ± 13.9 points: winning the match 74.3 ± 12.1 and losers - 62.1 ± 13.2 points. Such matches between the teams set 12.1 ± 7.1 points. In a match that took place in the point -to-point and ended in a single-digit points difference (on average 5.7 ± 2.2 points), team average per game scored 68.4 ± 9.9 points: winning the match 71.3 ± 9.3 and losers match 65.6 ± 9.8 .

Comparing the number of points earned during one match, it was found that the team winning the game significantly gained more points during all championship, in play-off and final match ($p < 0.05$), but the match, which ended in a one-digit points difference, the change was not significant ($p > 0.05$) (Table 1).

Table 1: The indicators of points and free throws during the European women basketball championship, average per one match ($\bar{x} \pm SD$)

Match	Indicators	Of all teams	Winners	Losers	Difference (p)
All matches (n=54)	The number of free throws	15.8 ± 7.3	18.4 ± 7.1	13.1 ± 6.6	$p < 0.05$
	Accuracy of free throws (%)	73.0 ± 14.4	70.4 ± 13.4	75.8 ± 15.0	$p < 0.05$
	Points	64.3 ± 12.2	71.0 ± 8.9	57.6 ± 11.4	$p < 0.05$
	% from all points	17.5 ± 7.6	18.1 ± 7.6	16.8 ± 7.6	$p > 0.05$
Play-offs and final matches (n=12)	The number of free throws	16.7 ± 6.6	19.3 ± 7.3	14.1 ± 4.7	$p < 0.05$
	Accuracy of free throws (%)	74.9 ± 12.0	77.0 ± 8.7	72.7 ± 14.7	$p > 0.05$
	Points	68.2 ± 13.9	74.3 ± 12.1	62.1 ± 13.2	$p < 0.05$
	% from all points	18.0 ± 5.8	19.9 ± 7.1	16.1 ± 3.6	$p > 0.05$
Matches, which have ended in one digit difference (n=20)	The number of free throws	18.5 ± 5.5	20.1 ± 7.5	16.9 ± 7.4	$p > 0.05$
	Accuracy of free throws (%)	72.9 ± 14.2	67.3 ± 14.2	78.6 ± 12.1	$p < 0.05$
	Points	68.4 ± 9.9	71.3 ± 9.3	65.6 ± 9.8	$p > 0.05$
	% from all points	19.2 ± 8.2	18.6 ± 8.1	19.9 ± 8.5	$p > 0.05$

Women's basketball team in an average had throws 15.8 ± 7.3 of free throw during one match, the accuracy was $73.0 \pm 14.4\%$. Teams that have won the match, during all the championship in an average had 18.4 ± 7.1 free throws and the accuracy accounted for $70.4 \pm 13.4\%$. Teams that lost in the match, stood at the free throw line after 13.1 ± 6.6 times, throwing $75.8 \pm 15.0\%$ in accuracy. During all championship winning teams free throws number indicators were significantly higher than the losers teams ($p < 0.05$) in free throws, but the accuracy was better of the losers match teams ($p < 0.05$).

During the play-off and finals, the teams, which have won the match, in an average during one match has thrown 19.3 ± 7.3 free throws, the accuracy of throws accounted for $77.0 \pm 8.7\%$. Teams that have lost match stood at the free throw line in an average of 14.1 ± 4.7 times, throwing $72.7 \pm 14.7\%$ in accuracy. During the play-off and final matches the indicators of the winning match team free throws were significantly higher than the losing teams ($p < 0.05$) indicators in free throws, but the accuracy rates between the teams did not differ significantly ($p > 0.05$). In a match, which were in the point -to-point and ended in one-digit points difference, teams in average during match have thrown $18.5 \pm 7.5 \pm 72.9$ free throw in an accuracy of 14.2% (Table 1).

The winning teams of match have thrown in an average of $20.1 \pm 7.5\%$ free throws, and the accuracy throws accounted for $67.3 \pm 14.2\%$. Teams that have won the match stood to the free throw line in an average of 16.9 ± 7.4 times, throwing $78.6 \pm 12.1\%$ in accuracy. Free throws number indicators, which have ended in a one-digit points difference between winners and losers teams did not differ significantly ($p > 0.05$) in free throws, but the accuracy was better of teams that

lost the match. During all the championship collected points from the free throw line accounted for $17.5 \pm 7.6\%$ from all points earned: winning the match teams $18.1 \pm 7.6\%$, and the losers teams - $16.8 \pm 7.6\%$ of the total points earned per match (Table 1).

During the play-off and final matches collected points from the free throw line was $18.0 \pm 5.8\%$ of the total points earned: winning the match teams $19.9 \pm 7.1\%$, while the losing teams free throws points accounted for $16.1 \pm 3.6\%$ of the total points earned during a match. During the tense match (which ended in a one-digit point's difference) collected points from the free throw line accounted for $19.2 \pm 8.2\%$ of the total points earned. Game winning teams points of free accounted for $18.6 \pm 8.1\%$ and $19.9 \pm 8.5\%$ of losing teams from the total points per match. Significant change of points collected by free throws between winners and losing teams during all championship was not determined, in play-off and final matches, which have ended in a one-digit points difference ($p > 0.05$).

Discussion

The main objective of this study was to determine the difference between winners and losers teams of the European championship women's basketball teams free throws indicators (number and accuracy), aiming the final result - a victory. To assess the impact of free throws on the final result of the game we have determined one of indicators that describe the nature of offensive basketball teams, the effectiveness during the game - the number of points. Free throws per game show team activity in organizing and ending the attacks (Csataljay et al., 2009). In the European Women's Basketball Championship match winning team has been more active than losing teams in organizing the attacks and ending them by free throws, but the teams were not as active as in the past championships, they rarely stood up to the free throw line. The European Champion of the year 1997 - Lithuanian women's team at the free-throw line stood even 28 times in matches and 22 free throws reached the aim (79 percent accuracy) (Kreivytė et al., 2013).

In the playoffs and the final match, which is a decisive match, there is a tendency to play this game more slowly, which may increase the number of free throws, while at the same time and the number of points collected. However, investigated teams in the most important championship matches stood less at free throws line in comparison with the total championship match. Especially important free throws indicators when a match is tense and only minor points of difference shall be appointed by the competing with each other for two teams (Csataljay et al., 2009).

Very high value have free throws indicators at the end of tense match, when remains few minutes, as teams often stop at the free throw line (Csataljay et al., 2012). Despite the fact that losing teams throw less free throws in the match, but the teams free throws, the accuracy of these teams was better than of the winning the championship team and intense match, during the play-offs and the final match the accuracy of indicators didn't differ. In match between the elite men's basketball teams, free throws create from 20 to 25 percent of all points total during a match (Mersky, 1987). The European Champion of the year 1997 - Lithuanian women's team free throws were 29 percent from all the points (Kreivytė et al., 2013). Investigated women's basketball teams free throw points collected in the European championship created only from 16.8 to 18.1% of the total points in the match.

Conclusions

The winning teams significantly had more free throws than the losing teams during the 2013 European Basketball Championship, but the accuracy of these throws were better of losing teams. In the European Championship teams haven't been active in the free throw line and the free throw points accounted for 18% of the total points.

References

1. Csataljay, G., O'Donoghue, P., Hughes, M., & Dancs, D. (2009). Performance indicators that distinguish winning and losing teams in basketball. *International Journal of Performance Analysis of Sport*, 9, 60–66.
2. Csataljay, G., James, N., Hughes, M., & Dancs, H. (2012). Performance differences between winning and losing basketball teams during close, balanced and unbalanced quarters. *Journal of Human Sport & Exercise*, 7(2), 356–364.
3. Dezman, B., Erculj, F., & Vucković, G. (2002). Differences between winning and losing teams in playing efficiency. *Acta Kinesiologiae*, 7, 71–74.
4. Kozar, B., Vaughn, R.E., Whitfield, K.E., Lord, R.H. and Dye, B. (1994). Importance of free-throws at various stages of basketballgames. *Perceptual and Motor Skills*, 78(1), 243-248.
5. Kreivytė, R., Emeljanovas, E., Sporiš, G., Knjaz, D., Vučković, G., Milanović, Z. (2013). Shooting performance did not change in elite women's national basketball teams from 1995 to 2011. *Annales Kinesiologiae*, 4, 1, 45-56.
6. Mersky, M. J. (1987). Coaching and teaching the free-throw shooter. *The Basketball Clinic*, 19(5), 8-11.
7. Mendes, L., & Janeira, M. (2001). Basketball performance - multivariate study in Portuguese professional male basketball teams. In M. D. Hughes, & F. Tavares (Eds.) *Notational Analysis of sport – IV* (pp. 103–11). Cardiff: UWIC.
8. O'Donoghue, P. (2010). *Research methods for sport performance analysis*. New York: Routledge.
9. Trninić, S., Dizdar, D., & Luksić, E. (2002). Differences between winning and defeated top quality basketball teams in final of European club championship. *Collegium Antropologicum*, 26(2), 521–531.

EFFECTS OF ANAEROBIC TRAINING IN FEMALE SWIMMERS

Goran Leko and Klara Šiljeg

Faculty of Kinesiology, University of Zagreb, Croatia

Abstract

The aim of the paper is to determine whether the increased anaerobic zones in swimming training brings about positive results in female swimmers' anaerobic capacity in the age group 12-13. The paper analyzed the progress of female swimmers in the period of six months in specific swimming tests: speed tests, endurance tests and repetitive muscular strength test measured on swimming ergometer. The measurement was aimed at determining if the female swimmers in this age group adequately responded to the anaerobic stimuli. Multivariate variant analysis showed a statistically significant improvement in the observed group of tests that define anaerobic abilities of female swimmers. A series of univariate analyses showed that in all observed tests there was a statistically significant improvement.

Key words: *swimming, anaerobic training, growth and development*

Introduction

Most of the female swimmers' training process is done in aerobic conditions although almost all sections in the competitive program have anaerobic character (Leko, 2009). Therefore, female swimmers' training development process is more focused on the development of aerobic, aerobic-anaerobic and anaerobic endurance (Vorontsov, 2002). The mechanisms of aerobic workout mature relatively early, in the pre-puberty phase, with the highest speed of growth in puberty, while the accelerated development of anaerobic abilities takes place towards the end of puberty (Vorontsov, 2002, 2011). The puberty phase in girls starts between ages 10 and 12 when they experience sudden transitory increase in height, whereas the increase in weight happens between ages 12 and 13. The girls' first menses marks the attainment of 97-98% of their final height and muscle mass (Kolesov, 1977, Wutscherk, 1983). Unlike the boys, whose growth and development lasts several years, the regulation of the girls' menstrual cycle resulting in final height and muscle mass (Vorontsov, 2002) can be completed in several months. Furthermore, estrogen in women increases the fatty component in the total body mass (Costill et al 1992; Šimek et al, 2002; Ogonowska et al 2009) thus changing the composition of the body. The composition and the proportions of the body depend on the biological maturity. They influence the lift and resistance, and determine the success in swimming disciplines (Carter, 1994; Sokolovas, 2000; Ostrowska, 2006; Rama, 2006). We often see girls hitting the plateau or stagnating with their results once their menstrual cycle is regulated. According to the development plan of the Croatian Swimming Association, female swimmers aged 12 to 13 fall into the cadet or pre-junior category whose task is to train for competitions. The above implies increased training in anaerobic zones of the water training as well as increased dry-land training with the aim of maintaining muscle mass (Long term athlete development strategy, 2008). Latt (2009) and Marinho (2011) suggest that intensive anaerobic training should be introduced even before puberty, and Mišigoj - Duraković (2008) recommend controlled application of anaerobic load with younger age groups due to the activity of the enzyme phosphofructokinase that limits anaerobic glycolysis. However, the measurements at submaximal load showed that children for the most part use entirely aerobic energy sources (fatty acids and carbohydrates) and such will be the response to anaerobic water training if the biological maturation has not taken place (Rowland, 2005).

The aim of this paper was to determine whether it is possible to obtain positive results in tests assessing anaerobic capacity in female swimmers aged 12 to 13 by increasing the anaerobic zones of the swimmers' water training (lactate tolerance zone, maximum lactate production zone, sprint zone) as well as increasing the training on specific training machines. The work followed the swimmers' progress in the period of six months in specific swimming tests: speed test, speed endurance, repetitive muscular strength measured on the swimming ergometer, since specific swimming tests predict high percentage of success in swimming disciplines (Arrelano, 2004; Latt et al, 2010; Šiljeg 2012).

Methods

The sample of subjects consisted of 29 female swimmers aged 12-13. They were tested in specific motor skills. All of them are participating in training programs in Zagreb swimming clubs. All participants were in good health, and they had been involved in swimming training process for the last 6 years. They train six times per week, with the length of training of 2 hours.

Table 1. and Table 2. show an increase in the anaerobic zones of the swimmers' water training as well as an increase in the frequency of dry-land training on specific swimming training devices.

We used 7 energy zones:

- Zone – aerobic low intensity
- Zone – aerobic maintenance/development,
- Zone – anaerobic treshold,
- Zone – aerobic overload,
- Zone – lactate tolerance,
- Zone – lactate production
- Zone – sprint ATP/CP

Table 1: Intensity zones

	1. Zone	2. Zone	3. Zone	4. Zone	5. Zone	6. Zone	7. Zone
2007/08 (%)	26,8	62,6	4,7	3,2	1,1	0,8	0,8
2008/09 (%)	19,3	44,9	15,8	10,6	4,1	2,8	2,8

Table 2: Training elements

	2007/08.	2008/09.
Num. of workout/week	6	6
Km/week	24	26,4
Dryland/week	3	5

The testing was undertaken at the Diagnostics Centre of the Faculty of Kinesiology in Zagreb, and at swimming pools in Zagreb. Measurements were done in accordance with ethical principles. Each participant was explained the intended measurement procedure, and her parents signed their written informed consent for the testing protocol. Measurements were carried out during October 2008 and March 2009, during swimmers short course period. The testing procedure is standardized for all swimmers. A variable sample includes 4 tests for the assessment of specific motor skills that measured: speed of swimming (25m crawl with start in water), speed endurance (50m crawl with start in water and 6x50m crawl with start in water and a 10-second break), and the overall work on swimming ergometer in 60 seconds with imitation of crawl stroke (Šiljeg 2012). In the 6x50m crawl test the average result of all 6 repetitions was recorded.

Statistic for Windows version 10.0 was used for the statistical analysis of specific motor skills. The following was computed: basic statistical parameters (mean, minimum and maximum results, standard deviation, coefficient of variability, degree of asymmetry). The data was analyzed using MANOVA and ANOVA for repeated measurements to determine differences between measurements. Statistical significance was set at $p < 0.05$.

Results

Table 3. shows descriptive indicators: number of entities (N), arithmetic mean (Mean), standard deviation (SD), results of ANOVA and MANOVA. Focusing on the arithmetic mean in two measurements, it is evident that the absolute values of arithmetic means differ in the two measurements in favor of the better results of the second measurement in all four tests. Statistically significant differences in the two measurements obtained through multivariate variance analysis are shown in Table 3. A series of univariate analyses indicates statistically significant differences in all tests on the level of statistical significance $p < 0.05$.

Table 3: Descriptive statistics of motor characteristics, results of ANOVA and MANOVA

	N	M 1	SD.1	M 2	SD 2	p	ANOVA p
Biokinetik 60 s crawl W tot	29	3461.24	1064.91	4163.79	998.12	0.012	0,012
25m crawl	29	15.84	0.86	15.01	0.81	0.001	0,001
50m crawl	29	34.56	1.92	32.21	2.16	0.000	0,000
6X50 crawl AVG	29	39.38	2.79	37.24	2.06	0.001	0,001

MANOVA WILKS $F=5381,67$ $p=0,00$

Legend: Biokinetik 60-W - crawl stroke in 60 s on the swimming ergometer in W, 50m crawl - 50m freestyle swimming result, 25m crawl - 25m freestyle swimming result, 6X50 crawl AVG - average result in 6x50 freestyle swimming

Discussion

Although Vorontsov (2002) states the age 11 to 13 as the period with greatest variations in maturing and motor skills in women, result variability of measured variables in this research shows regular distribution. Until puberty, children are “aerobic” athletes for several reasons. They have less muscle mass and therefore they have less glycogen stored per gram of muscle along with less glycolytic enzyme phosphofructokinase (PFK). Children are thus unable to generate high blood lactate values that are associated with anaerobic work (Malina, 1991).

Considering the statistically significant improvement in test results and their absolute value, we can conclude that female swimmers aged 12 to 13 react extremely positively to intensive anaerobic stimuli in both swimming training and dry-land training, which can be of crucial importance in their further development. Phillips (2012) says that these years are foundational years and have a profound impact on the rest of a career. It would be presumptuous to call these years “make or break” without definitive evidence, but when you consider the physiology of what occurs during adolescence, certain things happen to the body that will never happen again during the athlete’s life. Vorontsov (2002) states that the biological maturing of women, i.e. the final regulation of their menses can result in a drop in motor skills such as strength, VO₂ max etc. Hence, these results show timeliness and coordination in the application of anaerobic stimuli while maintaining aerobic capacity. In crawl and backstroke, arm techniques make the biggest propulsion, and Šimek et al (2002) in their paper stress that arms and shoulders in women are the weakest link if viewed from the point of view of strength. They advise special attention to be devoted to the development of this topological region in female athletes whose sport demands strength and efficacy of arms and shoulders. In order to prevent unwanted consequences of maturation listed by Vorontsov (2002), swimming ergometer test is ideal for the control of dry-land workout, which improves the strength of arms and shoulders up to 35% (Tanaka et al 1993; Guglielmo, 2000). The authors stress that the effect the improvement of strength on ergometer has on swimming results is questionable, and they suggest a specific training of speed in water. Consequently, the better results in the second ergometer measurement and the speed test in 25m crawl can indicate effectiveness of the long-term curriculum of the Croatian Swimming Association conducted on female swimmers, which takes into consideration their specific development of strength and speed. Although speed is primarily genetically determined and depends on the muscle fiber type (Maglischo 1982), it can be improved through training to a certain extent (Pyne, 2001). Dolan (2001) mentions age 9 to be the ideal time to start sprint training. Sprint training is unavoidable, especially in training phases where the majority of workout is focused on the stimulation of endurance development (Maglischo, 2003). The improvement in results of speed endurance in the second measurement can indicate the swimmers’ readiness for the competition. Test results indirectly show the strength and endurance of the anaerobic glycolytic system, which is the main factor in the ATP production during 1-3-minute maximal exertion (Vorontsov, 2002, 2011; Pyne et al 2000; Szafranec et al 2012). Therefore, better results in speed and speed endurance tests show that female swimmers in this age group reacted positively to the increase in anaerobic stimuli. Such results confirm the theory by Canadian scientists (Long term athlete development strategy, 2008) that this age group in female swimmers is optimal for the increase in anaerobic stimuli while maintaining the workout volume in aerobic zones.

Conclusion

Statistically significant result improvements in the second measurements in speed and speed endurance tests in water and on swimming ergometer indicate that female swimmers aged 12 to 13 reacted positively to the more intense anaerobic training that included anaerobic energy sources and dry-land workout. Specialization in certain swimming disciplines is the logical sequence since a timely specialization is a prerequisite for a superior result. The swimmer’s speed during the whole competition is called speed endurance or anaerobic competitive endurance. Thus, the conducted tests should be repeated with the aim of obtaining swimmer’s full potential. Moreover, we can conclude that the increase in the overall workout in anaerobic conditions on the swimming ergometer is largely connected to the better results in the tests that show increased anaerobic abilities in water.

The limiting factor in this study is the inability to measure the control group. The relatively long period of research can lead to significant stagnation in the swimmers’ results.

References

1. Arellano, R (2004). Applying biomechanical testing to swimming training. Seminario Europeo de Entrenadores de Natacion - Madrid /on line/. Downloaded from: <http://homepage.mac.com/natacion/SwimmingScience/page4/page57/files/2004ArellanoEuroSem.pdf>
2. Carter, J.E.L., and Ackland, T.R. (1994). Kinanthropometry in aquatic sports: A study of world class athletes. Champaign, IL: Human Kinetics.
3. Costill, D.L., Maglischo, E.W., Richardson A.B. (1992). Handbook of sports medicine and science-swimming. Blackwell Scientific Publication.
4. Dolan, T. (2001). Something Special. NY: American Swim Coaches Association.
5. Ford P, De Ste Croix M, Lloyd R, Meyers R, Moosavi M, Oliver J, Till K, Williams C. (2011). The long-term athlete development model: physiological evidence and application. *J Sports Sci*;29(4):389-402.

6. Guglielmo, L.G.A., Dendai, B.S. (2000). Assessment of anaerobic power of swimmers: the correlation of laboratory test on as ergometer with field test sin a swimming pool. *Journal of Strength Conditional Reserch*; 14, (43):395-8.
7. Kolesov, D.V., Selverova, N.B. (1977). Physiological and pedagogical aspects of sexual maturation. "Pedagogica", 217pp. Moscow.
8. Lätt, E., Jürimäe, J., Haljaste, K., Cicchella, A., Purge P., Jürimäe, T. (2009). Physical Development and Swimming Performance During Biological Maturation in Young Female Swimmers. *Coll. Antropol.* 33, 1: 117–122
9. Malina, R. M. (1991) Fitness and performance: The interface of biology and culture. In PARK, R. J. & ECKERT, H. M. (Eds) *New Possibilities/New Paradigms?* Champaign, IL: Human Kinetics, pp.30-38
10. Marinho, D. A., Amorim, R. A., Costa, A. M., Neiva, H. P. (2011). The relationship between "anaerobic" critical velocity and swimming performance in young swimmers. *Medicine and Science in Sports and Exercise*, 43(5). Supplement abstract 2451.
11. Maglischo, E. W. (2003). Energy Metabolism and Swimming Performance. UD. Maglischo, E. W. (ur.), *Swimming Fastest*, str.349-369. Champaign IL: Human Kinetics.
12. Mišigoj-Duraković, M. (2008). Kinantropologija. Biološki aspekti tjelesnog vježbanja. Kineziološki fakultet, Sveučilišta u Zagrebu, 130-224.
13. Ogonowska, A., Hübner-Woźniak, E., Kosmol, A., Gromisz, W. (2009). Anaerobic capacity of upper extremity muscles of male and female swimmers. *Biomed Hum Kinetics*. 1:79–82.
14. Ostrowska, B., Domaradzki, J., and Ignasiak, Z. (2006). Factor analysis of anthropometric characteristics in young swimmers aged 11 and 12. *Acta Universitatis Palackianae Olomucensis. Gymnica*, Vol. 36, No 1; 59-68.
15. Phillips, A. (2012). *Swimming Science*. Downloaded on 13.2.2014 from: http://www.swimmingscience.net/2012/05/should-female-swimmers-train_22.html
16. Pyne, D.B., Goldsmith, W.M., Maw, G. (2000). Physiological Test for Elite Athletes Training and testing of competitive swimmers. In Dr Chris Gore (eds.). *Human Kinetics*, PO Box 5076, Champaign Illinois. *Swimming Chapter is Chapter 27* pp 372-382.
17. Pyne D. (2001). Speed development in swimmers. UD. Dolan, T. (ur.), *Something Special*, pp.145-148. NY: American Swim Coaches Association.
18. Szafraniec, R., Seidel, W., Kruszyna, D., Żurowska, A. (2012). Aerobic and Anaerobic Endurance of Disabled Swimmers in Special Preparation Sub-Period. *Baltic J. of health and physical activity*. Gdansk University of Physical Educ. and Sport, Vol. 4 No. 4, 231-237
19. Rama, L., Santos, J., Gomes, P., and Alves, F. (2006). Determinant factors related to performance in young swimmers. In J.P. Vilas-Boas, F. Alves, A. Marques (eds.) *Xth Int. Symposium on Biomech. and Medicine in Swimming*. University of Porto, pp.246-249.
20. Rowland TW. (2005). *Children's exercise physiology*. (2nd edition). Champaign, IL, USA: Human Kinetics.
21. Šimek, S., Čustonja, Z., Nakić, J. (2002). Programiranje treninga opterećenja kod žena. *Zbornik radova 11. ljetne škole kineziologa Republike Hrvatske. Programiranje rada u području edukacije, sporta i sportske rekreacije*. Rovinj, 10-14.
22. Tanaka, H., Costill, D.L., Thomas, R., Fink, W.J., Widrick, J.J. (1993). Dry-land resistance training for competitive swimming. *Medical Sciences Sports Exercise*, 25(8):952- 9
23. Vorontsov, A.R. (2002). Multi-year training of young athlete as potential modifier of growth and development (Analysis of some biological concepts). *Sport Medicine in Aquatic Sports – the XXI Century*, FINA World Sport Medicine Congress. Moskva.
24. Vorontsov A. (2011). Strength and power training in swimming In: *World book of swimming: From science to performance*. Eds: Seifert L., Chollet D., Mujika I, editors. 313-344.
25. Sokolovas, G. (2000). Anthropometrics (Chapter 2). In *The Olympic Trials project*, Colorado Springs, CO: United States Swimming.
26. Šiljeg, K. (2012). Connection between anthropological characteristics and swimming abilities with obtained results. (Doctoral thesis). Faculty of Kinesiology, University of Zagreb.
27. Wutscherk, H. (1983). *Die Antropometrie in der Praxis des Kreissportarztes*. Leipzig, 180 p.
28. Long term athlete development strategy (2008). *Swimming natation Canada*. https://www.swimming.ca/docs/ltad/ltad_en.pdf

CHARACTERISTICS AND DIFFERENCES OF BASIC TYPES OF OFFENSES IN EUROPEAN AND AMERICAN TOP-LEVEL BASKETBALL

Dragan Milanović¹, Aleksandar Selmanović² and Dario Škegro¹

¹Faculty of Kinesiology, University of Zagreb, Croatia

²University of Dubrovnik, Croatia

Abstract

The goal of this study was to determine the basic characteristic of offensive phase in European and American top-level basketball with an emphasis on the type and duration of offense and number of passes. On a total sample of 5,718 entities, the results indicate that European basketball facilitates a greater number of set offenses and a larger number of passes. On the contrary, a larger frequency of transition offenses and generally higher utilization of individual offenses (offense benefit value) is recorded in American basketball. Duration of offense variable has not been determined as significant regarding the differentiation of two styles, which indicates that the tempo of transformation between offense and defense is basically equal. Authors suggest the possibilities of using variables for further research of offense characteristics as well as for the comparison of European and American styles of basketball.

Key words: basketball, offense, game analysis

Introduction

The structure of basketball game is a subject of interest in numerous scientific researches. According to the topic and specificities of offense structure research, many authors (*Cruz and Tavares, 1998; Tavares and Gomez, 2003; Bozanov, Vohandu and Haljand, 2006; Trninić, Perica and Pavičić, 1994*) originally categorize offenses and define the limitations of their modalities therefore it can be stated that classification of types of offenses in basketball is not unified. This paper operationally defines three basic types of offenses which are recognized in basketball: set, transition and other offenses. During the evaluation, offensive plays were categorized according to the following definitions:

- Set offenses represent offenses which involves the set phase only or contain transition and set phase where set phase is considerably longer in comparison to transition phase ($tps > tts$)
- Transition offenses are defined as offenses consisting of transition phase only or consisting of both transition and set phase. In cases when transition offense comprises both transition and set phase, then the duration of set phase is generally shorter in comparison to transition phase ($tps < tts$).
- Other offenses, according to their structure, represent offenses that cannot be classified as either of the above mentioned types of offenses.

The goal of this study was to determine the basic characteristics of offenses in absolute and relative values and to assess whether there is any significant difference between European and American basketball according to the above-mentioned criteria. Partial goals were focused on offensive benefit value potential for each of the given offenses and comparison of offense duration and the number of passes between those two styles of basketball.

Methods

Offense phase represents the entity in this whereas its beginning and the end are strictly limited by the rules of basketball game. The sample of entities was collected by detailed evaluation of 30 randomly chosen games in basketball playoffs in 2010/11 season, 15 of which were from the Euroleague and 15 from the American NBA league. Entire sample generated a total of 5,724 entities ($N=5,724$).

Variable sample consisted:

- Type of offense – represents the frequency of set, transition and other offenses
- Number of passes – represents the number of all successful and unsuccessful passes during an individual offense
- Offense duration – represents the time, measured in seconds, which a team spent in offense phase

Variable analysis was performed using Match Analysis System (MAS) computer program which supports video analysis and an adequate tool for noting targeted characteristics. It has been proven that MAS meets strict reliability criteria (*Škegro, 2013*).

Methodological processing includes the overview of descriptive parameters of quantitative variables (number of passes, offense duration) and qualitative variables (type of offense) in absolute and relative values and efficiency coefficient. For the purpose of comparing European and American basketball, χ^2 test in nominal variable was used, while t-test was used on independent samples for the purpose of determining the differences in variables – number of passes and offense duration. The data was processed using *Statistica 8.0* statistical package.

Results and discussion

During the course of this study had been analyzed a total of 5718 entities which represent offense phases in basketball. By examination of basic characteristics of offense phase, it is visible that 2604 entities out of total sample refer to European, and 3114 refer to American basketball (Table 1). European basketball on average generates 173.6 offenses per game, while in American basketball that average amounts to 207.6. Efficiency in studied games of European basketball amounts to an average of 145.3 points per game (*min 117, max. 199, SD 16.6*), unlike American basketball which on average amounts to 182.4 points per game (*min. 160, max. 210, SD 14.1*).

Table 1: Basic characteristics of offenses in European and American basketball

	Euroleague	NBA
Number of analyzed games	15	15
Total number of offenses	2604	3114
Offenses/game	173.6	208.9
Offenses/minute	4.34	4.33
Number of points	2179	2736
Points per game	145.3	182.4
Points per minute	3.63	3.80
Offense benefit value	0.84	0.88

Since NBA game lasts for 48 minutes, i.e. 8 minutes longer than European game, the comparison of absolute values is for informative purposes only. General overview of relative parameters shows that values do not display significant deviations. European basketball features 4.34 offenses per minute, American basketball features 4.33 which dismisses speculations (*Sampaio, Lago and Drinkwater, 2010; Bertan 1992, according to Lukšić, 2011*) that American style is characterized by faster pace, or in other words, that occurs a larger frequency of changes of team ball possession.

During the comparison of overall offense efficiency, American type of basketball demonstrates slightly higher efficiency – on average, 3.80 points per minute are scored, while in European basketball is observed a frequency of 3.63 points per minute. These values are proportionally reflected in offence benefit value coefficient which amounts to 0.88 in the NBA league and 0.84 in the Euroleague.

Comparison of types of offenses between European and American basketball

According to established offense classification model, from results shown (Table 2) it is seen that there is a significant difference between European and American professional basketball ($\chi^2=28.128$; $p=0.000$) regarding the frequency of set, transition and other offenses.

Table 2: Representation of types of offenses and characteristics of their efficiency in European and American top-level basketball

Type	Euro. (freq.)	NBA (freq.)	Euro. %	NBA %	Euro. no. of points	NBA no. of points	Euro. % of points	NBA % of points	Euro. OBV	NBA OBV
SO	1780	2041	68.36%	65.54%	1439	1730	66.00%	63.2%	0.81	0.85
TO	392	630	15.05%	20.23%	411	673	18.9%	24.6%	1.05	1.07
OO	432	443	16.59%	14.23%	329	333	15.1%	12.2%	0.76	0.75
Total	2604	3114			2179	2736				
Chi square 28.128; df=2; p=0.000										

Legend: Euro. – Euroleague, SO – set offense, TO – transition offense, OO – other offense, OBV – offense benefit value

Approximately 2/3 of offenses in basketball are set offenses. Similar results had been confirmed in other studies (Remmert, 2003; Tavares and Gomez, 2003; Cardenas et al., 2000). Domination of set offenses in basketball suggests the relevancy of that segment in situational team preparation. *Set offenses* in its structure are more prone to preparation than *transitions* and *other offenses* which largely rely on hardly predictable spontaneous situations. On the other hand, due to their structure, set offenses require comprehensive tactical (both individual and team) preparation since the realization of that type of offense mainly contributes to the final outcome of the game.

Regarding the positive outcome of the offense, the highest benefit value is observed in transition offense which is slightly higher in the American top-level basketball (1.05 in the Euroleague, 1.07 in the NBA). That suggests that teams should be oriented towards creating as many transition offenses as possible. Since transition offenses are dominantly the consequence of opponents offensive mistakes (Škegro, 2013), there is a tendency to create opponents turnovers with aggressive defense (steals or forcing opponents into taking low percentage shots) which can lead to fast transition. Total share of transition offenses in the NBA amounts to 20.2% and generate almost a quarter of total points (24.6%), unlike the Euroleague where transition offenses amount to only 15.05% of total offenses and contribute with 18.9% to overall efficiency of the game. Under certain limitations (situational circumstances, players conditioning level which can keep up with pressure on the defensive end and the ability of the team to realize transition offense), this data can be formulated as a phenomenon of more efficient ball control in European basketball, i.e. higher defensive pressure and more successful realization of transition offenses in American basketball.

Differences in the number of passing and offense duration between European and American basketball

The total number of passes represents a segment which characterizes one of the tactical determinants of a team on offense. Generally speaking, both American and European styles of professional basketball feature slightly under 3 passes per offense and, according to the standard deviation value, most offenses feature between one and five passes.

Table 3: Descriptive parameters and difference analysis in the number of passes between European and American professional basketball

Number of passes (freq.)	AM	SD	Min.	Max.	t-value	df	p=0.01
Euroleague	2.95	1.87	0	14	4.8695	5716	0.000001
NBA	2.71	1.84	0	12			

Legend: AR – arithmetic mean, SD – standard deviation, Min. – minimum result, Max. – maximum result, t-value – t-test value, df – degree of freedom, p – level of significance

The results of this study prove there is a higher frequency of passes in European basketball (*Euroleague 2.95, NBA 2.71*) and the difference is statistically significant ($t=4.870; p=0.000$). Referring to results given earlier and higher representation of set offenses in European basketball, which in general generate larger number of passes, it is logical that the total number of passes in European basketball is higher. This data surely suggests that there is a higher emphasis on tactical combinations on offense in European basketball. Clearer conclusions regarding characteristics of both types of basketball could be made by the analysis of passing frequency in a given type of offense, followed by pass type and evaluation of their efficiency level.

Table 4: Descriptive parameters and the analysis of differences in offense duration between European and American basketball

Offense duration (s)	AM	SD	Min.	Max.	t-value	df	p=0.01
Euroleague	11.98	6.35	0	24	1.5145	5716	0.1299
NBA	11.73	6.17	0	24			

Legend: AR – arithmetic mean, SD – standard deviation, Min. – minimum result, Max. – maximum result, t-value – t-test value, df – degree of freedom, p – level of significance

Orientating on offense duration, Table 4 shows that the difference in average offense duration (*Euroleague 11.98 s, NBA 11.73 s*) does not cause statistically significant difference at the significance level $p=0.01$. Offenses in European basketball are slightly longer, which proves that the difference does not cause a major practical applicability. This data is confirmed by relative indicator in Table 1 which additionally refutes the speculations that offenses in American basketball are shorter, i.e. that there is a higher frequency regarding the changes of ball possession.

It is recommended that further studies consider more detailed examination of the average duration of each offense type, as well as the contribution of a given type to the referred difference. From the aspect of detecting factors that determine the success in a given sport, in this concrete case it would be useful to research the relation between the duration of certain offense types and basketball efficiency.

Conclusion

Research of sport activity's characteristics represents the vital part of sport kinesiology. The results of structural analyses allow the determination of model characteristics of top-level performance for a given sport activity. Furthermore, they allow us to determine the connections between parameters of sport activity with competitive result (Milanović, 1999). This study aimed at the analysis of top-level performance in European and American basketball, specifically on structural analysis of basketball offense. After the evaluation of offense type, results prove the highest chance of positive outcome for transition offense and 2/3 dominance of set offenses.

American basketball is characterized by much higher frequency of transition offenses as well as significantly higher level of efficiency. On the other hand, higher representation of set offenses and generally higher number of passes are characteristics for European basketball. Finally, observed professional basketball types exhibit insignificant difference regarding the tempo of play.

General conclusions of this research though constitute certain controversies. For example, since European professional basketball is characterized by a lower efficiency of set and transition offenses, it initiates a discussion whether this is caused by the defensive efficiency in the Euroleague or by better scoring abilities in the NBA. Furthermore, higher efficiency of transition offenses is a result of more aggressive defense in the NBA or more efficient ball control in the Euroleague. These are surely subjects for further examination. In any case, from observed variables there are further possibilities of analysis which could contribute to differentiation between European and American basketball styles, primarily the possibility of more detailed distribution of variables to its' own modalities, also their contribution to the overall share of certain characteristics and, finally, their relation to the final outcome of offense and the final outcome of the game.

References

1. Marvidis, G., Tsamourtzis, E., Karipidis, A., Laios, A. (2009) The inside game in World Basketball: Comparison between European and NBA teams. *International Journal of Performance Analysis in Sport*, Volume 9, No.2, August 2009, pp 157-164(8)
2. Milanović D. (1999) Struktura i značajke znanstvenih istraživanja u postučju sporta, *Kineziologija za 21. stoljeće*, Zbornik radova, Ur: Milanović, D., Dubrovnik, 87-90.
3. Remmert, H. (2003) Analysis of Group-Tactical Offensive Behavior in Elite Basketball on the Basis of a Process Oriented Model. *European Journal of Sports Science*, vol.3, iss.3
4. Škegro D. (2013) Vrednovanje različitih vrsta napada u košarkaškoj igri temeljem njihova početka, ishoda, trajanja i broja dodavanja (Disertacija), Zagreb: Kineziološki fakultet Sveučilišta u Zagrebu
5. Tavares F. and Gomes N. (2003). The offensive process in basketball – a study in high performance junior teams, *International Journal of Performance Analysis in Sport*, 3(1): 34-39.
6. Theoharopoulos, A., Laparidis, K., Galazoulas, C., & Tsitskaris, G. (2010) A comparative study relating pass between male and female basketball players. *Journal of Physical Education and Sports*, 26(1), 44-50.

DIFFERENCE IN IMPORTANCE OF HAND AND LEG TECHNIQUES IN THE COMPETITIVE KICKBOXING DISCIPLINES

Hrvoje Sertić, Marko Žaja and Ivan Segedi

Faculty of Kinesiology, University of Zagreb, Croatia

Abstract

The main purpose of this paper was to determine the importance of kickboxing techniques in individual kickboxing disciplines and to establish whether there are any differences between the kickboxing disciplines as far as the importance of their techniques is concerned. For this reason two main hypothesis were established; H1- Kickboxing techniques are of different importance for different disciplines; H2 – Hand techniques, unlike leg techniques, are more important within “hard” than within “soft” disciplines. The assessment of importance of individual techniques (44) in different variables of competitive kickboxing disciplines (8) was performed by six experts who were familiar with the research methodology. Results indicate the existence of a statistically significant difference in technique importance between the “soft” and “hard” disciplines. Hand techniques are identified as statistically more important in “hard” disciplines. Also, there is no statistically significant difference in importance of leg techniques between “hard” and “soft” disciplines. The obtained results identified, also, the difference of importance between hand and leg techniques in three out of eight competitive kickboxing disciplines. Both established hypothesis were accepted. These data can be important for kickboxing coaches who can use the result distribution to select competitors according to the predominantly used technique and the quality of their performance by each competitor. It can be concluded that coaches should teach their competitors all groups of techniques equally, considering the fact that competitors may compete in all disciplines and that a technical deficit may be an obstacle in achieving high-quality results.

Key words: Semi contact, Light contact, Full contact, Low kick, K1 discipline

Introduction

Kickboxing is a sport which, according to its structure, belongs to the group of polystructural acyclic sports. Numerous techniques manifest themselves during combat in five competitive disciplines. Each discipline differs from others in rules, and consequently, in the way the techniques are used.

The five kickboxing disciplines can be divided into two groups - the “soft” kickboxing disciplines and the “hard” kickboxing disciplines.

The “soft” kickboxing disciplines include semi contact and light contact, whereas “hard” kickboxing disciplines include full contact, low kick and the K1 discipline. All three “hard” kickboxing disciplines can be practiced according to amateur rules and professional rules. Technical training, tactical training and conditioning are three main types of training and ignoring even one of them can result in irrecoverable shortcomings in performance, especially when the technical domination is proven to be one of most important factors to win the kickboxing fight (Ouergui et al., 2013). The negligence of technical and tactical training is partially caused by lack of quality data about technical and tactical structures of kickboxing. It is important to conduct such analysis so the coaches, in training process, can rely on scientifically proven data.

The main goal of this paper was to determine the importance of kickboxing techniques in individual kickboxing disciplines and to establish whether there are any differences between the kickboxing disciplines as far as the importance of their techniques is concerned. The importance is defined as applicability, representation and effectiveness of a technique in a certain discipline, as well as the contribution of individual techniques to the final outcome of the combat according to expert opinion.

For this reason two main hypothesis were established;

H1 – Kickboxing techniques are of different importance for different disciplines;

H2 – Hand techniques, unlike leg techniques, are more important within “hard” than within “soft” disciplines.

Methods

The sample of entities was represented by 44 kickboxing techniques (19 hand techniques and 25 leg techniques) which are used in kickboxing competitions in accordance with official rules.

The sample of variables represents the following kickboxing competitive disciplines: Semi contact (SC), Light contact (LC), Full contact (FC), Low kick (LK), K1 discipline (K1), Full contact according to professional rules (FCPRO), Low kick according to professional rules (LKPRO), K1 discipline according to professional rules (K1PRO).

The assessment of importance of individual techniques in different variables of competitive kickboxing disciplines was performed by six experts who were familiar with the research methodology. All experts were top international competitors or coaches of top international competitors. The experts have performed an assessment of the importance of techniques (entities) in said kickboxing disciplines (variables) in a way that grade 1 stands for very small significance of a certain technique in a certain variable, while grade 5 stands for very large significance of a certain technique in a certain variable.

Descriptive parameters (arithmetic mean, standard deviation, minimum and maximum) of technique importance grades have been calculated in each individual variable.

The T-test for independent samples was used to examine the significance of difference in the importance of hand and leg techniques between individual “hard” and “soft” kickboxing disciplines.

Results

Table 1: Reliability coefficients (Crombach alpha) of the results of the group of experts during the assessment of technique (object) importance in the variables of competitive kickboxing disciplines

VARIABLES	Crombach alpha
SC	.902
LC	.894
FC	.911
LK	.922
K1	.821
FCPRO	.916
LKPRO	.908
K1PRO	.879

The fact that experts with a high level of experience in kickboxing, who have won European and World medals competing in all kickboxing disciplines listed as variables in this research, were included in this paper resulted with a high degree of internal consistency of experts, and, therefore, with a high reliability of obtained results. It was thus possible to definitively interpret all obtained results.

Table 2: Descriptive parameters and results of the Kolmogorov – Smirnov test of the normality of importance grade distribution for 19 hand techniques in the variables of competitive kickboxing disciplines

VARIABLES	Valid N	Mean	Minimum	Maximum	Std. Dev.	Max D	K-S test
SC	19	,359649	1,333333	3,666667	0,750027	0.198	p > .20*
LC	19	,403509	1,666667	3,666667	0,539535	0.195	p > .20*
FC	19	3,140351	1,666667	4,166667	0,752082	0.131	p > .20*
LK	19	3,350877	1,833333	4,666667	0,738899	0.111	p > .20*
K1	19	3,536842	2,600000	4,800000	0,666842	0.127	p > .20*
FCPRO	19	3,464912	2,166667	4,500000	0,780904	0.174	p > .20*
LKPRO	19	3,508772	2,166667	4,500000	0,599572	0.162	p > .20*
K1PRO	19	3,694737	2,200000	4,800000	0,712954	0.181	p > .20*

Legend: Valid N – number of analyzed hand techniques; Mean – arithmetic mean; Minimum – minimal score of importance; Maximum – maximal score of importance; Std.Dev. – standard deviation; Max.D. – maximal deviation from normal distribution; K-S test – result of KS test (* variables with normal distribution)

The results of an expert analysis give a pretty clear picture of the importance of hand techniques in individual kickboxing disciplines (table 2). A greater importance of hand techniques is evident in “soft” kickboxing disciplines in relation to the importance of hand techniques in “hard” kickboxing disciplines.

Table 3: Descriptive parameters and results of the Kolmogorov – Smirnov test of the normality of importance grade distribution for 25 leg techniques in various competitive kickboxing disciplines

VARIABLES	Valid N	Mean	Minimum	Maximum	Std. Dev.	Max D	K-S test
SC	25	2,926667	1,000000	4,833333	1,449042	0.213	p > .20*
LC	25	2,833333	1,000000	4,500000	1,371840	0.282	p > .20*
FC	25	2,740000	1,000000	4,500000	1,317686	0.186	p > .20*
LK	25	2,686667	1,000000	4,833333	1,227878	0.155	p > .20*
K1	25	3,272000	1,800000	4,800000	0,932523	0.185	p > .20*
FCPRO	25	2,700000	1,000000	4,500000	1,333333	0.178	p > .20*
LKPRO	25	2,700000	1,000000	4,833333	1,220959	0.158	p > .20*
K1PRO	25	3,312000	1,600000	4,800000	1,008431	0.152	p > .20*

Legend: Valid N – number of analyzed hand techniques; Mean – arithmetic mean; Minimum – minimal score of importance; Maximum – maximal score of importance; Std.Dev. – standard deviation; Max.D. – maximal deviation from normal distribution; K-S test – result of KS test (* variables with normal distribution)

The obtained results provide an insight into the importance of leg techniques in certain disciplines (table 3). The lowest means of leg technique importance grades have been observed in the full contact and low kick disciplines, according to both amateur and professional rules (they vary from 2,69 to 2,74), whereas the highest expert grades for the importance of leg kickboxing techniques were for the K1 discipline for both amateur and professional rules (3,27 and 3,31).

Table 4: Differences in importance of hand and leg techniques in certain competitive kickboxing disciplines

VARIABLES	Mean (hand techniques)	Mean (leg techniques)	t-value	Df	P
SC	2,359649	2,926667	-1,55201	42	0,128163
LC	2,403509	2,833333	-1,28912	42	0,204411
FC	3,140351	2,740000	1,18386	42	0,243124
LK	3,350877	2,686667	2,08505	42	0,043182
K1	3,536842	3,272000	1,04948	42	0,299959
FCPRO	3,464912	2,700000	2,22382	42	0,031594
LKPRO	3,508772	2,700000	2,64951	42	0,011312
K1PRO	3,694737	3,312000	1,40689	42	0,166816

Legend: Mean – arithmetic mean; t value – results of t test for independent sample; Df – degrees of freedom; p – p value

A statistically significant difference ($p < 0,05$) in the grading of importance of hand techniques as opposed to the leg techniques in kickboxing, as seen per individual kickboxing disciplines, occurs in the low kick according to amateur and professional rules and in full contact according to professional rules (table 4).

Table 5: The difference in the importance of hand techniques in “soft” and “hard” disciplines

VARIABLES	Mean (hand techniques) in “soft” disciplines	Mean (hand techniques) in “hard” disciplines	t-value	Df	P
SC vs. FC	2,359649	3,140351	-3,20387	36	0,002838
SC vs. LK	2,359649	3,350877	-4,10374	36	0,000222
SC vs. K1	2,359649	3,536842	-5,11284	36	0,000011
SC vs. FCPRO	2,359649	3,464912	-4,44952	36	0,000080
SC vs. LKPRO	2,359649	3,508772	-5,21641	36	0,000008
SC vs. K1PRO	2,359649	3,694737	-5,62372	36	0,000002
LC vs. FC	2,403509	3,140351	-3,47001	36	0,001369
LC vs. LK	2,403509	3,350877	-4,51352	36	0,000066
LC vs. K1	2,403509	3,536842	-5,75919	36	0,000001
LC vs. FCPRO	2,403509	3,464912	-4,87435	36	0,000022
LC vs. LKPRO	2,403509	3,508772	-5,97297	36	0,000001
LC vs. K1PRO	2,403509	3,694737	-6,29502	36	0,000000

Legend: Mean – arithmetic mean; t value – results of t test for independent sample; Df – degrees of freedom; p – p value

The results of t – test indicate the existence of a statistically significant difference between the “soft” and “hard” disciplines in connection with the importance of using hand techniques (table 5).

Completely different results in leg techniques analysis are obtained. The results of t-test indicate the lack of a statistically significant difference between the “soft” and the “hard” kickboxing disciplines in connection with the importance of using leg techniques (table 6).

Table 6: The difference in the importance of leg techniques in “soft” and “hard” disciplines

VARIABLES	Mean (leg techniques) in “soft” disciplines	Mean (leg techniques) in “hard” disciplines	t-value	Df	P
SC vs. FC	2,926667	2,740000	0,47654	48	0,635854
SC vs. LK	2,926667	2,686667	0,63181	48	0,530512
SC vs. K1	2,926667	3,272000	-1,00203	48	0,321355
SC vs. FCPRO	2,926667	2,700000	0,57555	48	0,567609
SC vs. LKPRO	2,926667	2,700000	0,59811	48	0,552577
SC vs. K1PRO	2,926667	3,312000	-1,09135	48	0,280569
LC vs. FC	2,833333	2,740000	0,24533	48	0,807244
LC vs. LK	2,833333	2,686667	0,39831	48	0,692165
LC vs. K1	2,833333	3,272000	-1,32226	48	0,192348
LC vs FCPRO	2,833333	2,700000	0,34849	48	0,729000
LC vs. LKPRO	2,833333	2,700000	0,36301	48	0,718190
LC vs. K1PRO	2,833333	3,312000	-1,40569	48	0,166258

Legend: Mean – arithmetic mean; t value – results of t test for independent sample; Df – degrees of freedom; p – p value

Discussion and conclusions

The obtained results identified the importance of certain techniques in certain disciplines and have enabled the establishment of a better – specifically focused training programme. The interpretation of results in professional terms is important in two aspects. The first aspect is the global analysis of the sport in relation to the usage of techniques in combat. From this aspect, it can be concluded that the importance of hand techniques in “hard” kickboxing disciplines is statistically much greater, while, at the same time, statistically significant difference was not noted between the leg techniques of these two groups. This difference is understandable and expected, primarily because we know that full-force striking and knockout are not allowed in the “soft” kickboxing disciplines, whereas the rules for “hard” kickboxing disciplines allow full-force striking and knockout, while hand strikes are usually used for achieving knockouts. Also, numerically higher values are observed for the importance of leg techniques in the K1 discipline for both amateur and professional rules (table 3). These results were expected because the techniques of knee strikes are allowed and very important in the K1 discipline, and they have contributed to the increase in the mean value of importance of leg techniques for these two disciplines.

It can be observed that both hand and leg techniques have lower mean importance grades in the “soft” disciplines (between 2.35 and 2.92). The reason for this is that semi contact and light contact combat take place on a tatami, and not in the ring as with the full contact, low kick and K1 disciplines, so the fighters are able to move more freely and thus avoid contact, and like in some other similar tatami striking combat sports, much more attention must be focused on the speed of movement and evasion (Chaabene et al., 2012.; Katić et al., 2009). It is therefore recommended to pay more attention to the training of these technical elements in the preparation for competition in “soft” disciplines. In the disciplines in which combat takes place in a ring, due to the inability to exit the arena and reduced distance, fighters are more often in the position to apply a direct strike, which is not necessarily previously connected with a feint, movement or any other similar preceding action. Precisely for the reasons described above, it can be confirmed that the semi and light contact are semi-contact disciplines which are recommended for children up to the age of 14 in order for them to gradually start adopting the basics of movement and defense and delivering strikes in martial disciplines without the danger of a knockout or a serious injury (Žaja et al., 2011). After the children adopt the basics of martial techniques through those “soft” disciplines, they can certainly engage in the quality practice of “hard” kickboxing disciplines.

From the aspect of somatotypes, in the “soft” disciplines (that are similar to karate or taekwondo) mesomorph characteristic don’t need to be limiting factor for selection of young kickboxers, unlike in “hard” disciplines, that involve more contact and power (similar to judo, wrestling and boxing) this attribute is much more important (Chan et al., 2003; Krawczyk et al., 1997).

Another aspect is to analyze the importance of techniques individually for each kickboxing discipline (table 4). This analysis will provide an insight into the complexity of each discipline and the possibility to create a tactical combat pattern. As expected, a statistically significant difference ($p < 0,05$) in the assessment of importance of hand techniques in relation to the importance of leg kickboxing techniques, as seen per individual kickboxing disciplines, occurs in the low kick according to amateur and professional rules, while the statistically significant difference in full contact manifests itself only according to professional rules. At first, this result was surprising, given that a statistically significant difference was expected according to amateur rules as well, however, the result is still logical. Knowing the rules of combat and the differences between amateur and professional combat methods, this conclusion becomes self-evident. Since, according to amateur rules, a fight consists of only three two-minute rounds, it is less likely for a knockout to happen and, therefore, the competitors, aware of the fact that it is much more probable that the fight will end with the decision of a judge, rely more on leg techniques and less on hand techniques in combat according to amateur rules when compared to fighting according to professional rules. In other disciplines, there were no statistically significant differences in the importance of using hand and leg techniques, and one can conclude that, in the preparation of said disciplines, competitors should pay equal attention to both technique groups (both in offense and defense). These data are also important for kickboxing coaches who can use the result distribution to select competitors according to the predominantly used technique and the quality of their performance by each competitor.

It can be concluded that the existence of statistically significant difference in importance of using hand techniques between “hard” and “soft” kickboxing disciplines has been determined, so H2 hypothesis – stating that hand techniques, unlike leg techniques, are more important within “hard” than within “soft” disciplines was accepted. Also, the results identified difference of importance between hand and leg techniques in three disciplines (low kick, full contact according to professional rules and low kick according to professional rules) in favor of hand techniques. These results confirmed H1 hypothesis – stating that kickboxing techniques are of different importance for different disciplines. The obtained results can be used for the quality correlation of both technical and fitness requirements for each competition discipline, which is extremely important in professional sports (Đug et al. 2012). When all these results are observed through one prism, it can be concluded that coaches should introduce their competitors with a high-quality performance of all technique groups, considering the fact that competitors may compete in all disciplines and that a technical deficit may be an obstacle in achieving high-quality results. This is certainly not an easy task for kickboxing coaches, but we can conclude that this multi technical dimension and complexity lend special air to kickboxing and distinguish it from all other strike-based martial sports today.

References

1. Đug, M., Zildžić, S., mačković, S., Mikićred, B., & Zahirović, J. (2012). Principi i specifičnosti kondicijske pripreme vrhunskih kik-boksača. In Jukić, I., Gregov, C., Šalaj, S., Milanović, L., Wertheimer, V. (Eds.), *Zbornik radova 10. godišnje međunarodne konferencija Kondicijska priprema sportaša, Zagreb, 2012* (pp. 189-193). Zagreb: Kineziološki fakultet Sveučilišta u Zagrebu.
2. Chaabene, H., Hachana, Y., Franchini, E., Mkaouer, B., Chamari, K. (2012). Physical and Physiological Profile of Elite Karate Athletes. *Sports Medicine*, Vol.42(10), 829-843.
3. Chan, K., Pieter, W., Moloney, K. (2003). Kinanthropometric profile of recreational taekwondo athletes. *Biology of Sport*, Vol.20 (3), 175-179.
4. Katic, R., Jukic, J., Glavan, I., Ivanisevic, S., Gudelj, I. (2009). The Impact of Specific Motoricity on Karate Performance in Young Karateka. *Collegium Antropologicum*. Vol.33(1), 123-130.
5. Krawczyk, B., Skład, M., Jackiewicz, A. (1997). Heath-Carter somatotypes of athletes representing various sports. *Biology of Sport*. Vol.14(4). 305-310.
6. Ouergui, I., Hssin, N., Franchini, E., Gmada, N., Bouhlel, E. (2013). Technical and tactical analysis of high level kickboxing matches. *International Journal of Performance Analysis in Sport*, Vol. 13 (2), 294-309.
7. Žaja, M., Belošević, D., & Sertić, H. (2011). Specifični kondicijski trening u kickboxingu. In I. Jukić, C. Gregov, S. Šalaj, L. Milanović i T. Trošt-Bobić (Eds.), *Zbornik radova 9. godišnje međunarodne konferencije Kondicijska priprema sportaša, Zagreb, 2011*, (pp. 144-149). Zagreb: Kineziološki fakultet Sveučilišta u Zagrebu.

THE RELATIONSHIP BETWEEN THE NUMBER OF PASSES IN A POSSESSION AND THE PROBABILITY OF SCORING IN MEN'S DIVISION I COLLEGE BASKETBALL IN THE UNITED STATES

Kenneth Swalgin

Department of Kinesiology, Penn State University, USA

Abstract

The paper investigates the relationship between the number of passes in a possession and the probability of scoring. Games were randomly selected from the 2012 national championship tournament, 33 games were analyzed of the 68 games in the tournament through video analysis. The number of possessions analyzed equaled 4,481. Pass-Possession categories in the sample ranged from 0 to 23. Because 90% of the pass-possession (p-pos) occurred from 0 p-pos to 7 p-pos, the analysis was restricted to these categories. For the analysis, the variable *points scored* that ranging from 0-5 points in a given possession, was converted to a categorical variable *score* with 0 = *not scored* and 1 = *scored*. Exploratory Data Analysis show that for the category 0 p-pos, the probability of scoring was nearly 57%, where the probability of scoring for categories 1 p-pos through 6 p-pos on average was only 46%. For 7 p-pos the probability of scoring was 50/50. The results of the chi-square test and Logistic Regression analysis indicated that there is a relationship between the number of passes in a possession and the probability of scoring, and that as the number of passes in a possession increased, the probability of scoring decreased.

Introduction

Over the past decade in the United States, men's Division I college basketball has not appeared to have changed in terms of team statistical trends recorded by the National Collegiate Athletic Association (NCAA). (See NCAA Division I statistical trends 2013) However, the nature of the game in terms of one of the fundamental structural elements, passing, appears to have changed significantly. This change appears not to be a measure of quality of passing, but the number of passes in a typical offensive possession. The reason for this apparent trend toward fewer passes in a possession may be the quality of pressure man-to-man defenses. Pressure man-to-man defense especially on the ball handler and the closing of passing lanes by over play deny type defenses has made it difficult to move the ball through passing to good scoring positions on the floor. To counter this type defense, dribble penetration has become a primary tactic to create scoring opportunities where in the past passing was the primary tactic to break down the defense to create scoring opportunities. Although not the primary purpose of the study, the data collected will establish a baseline to measure this aspect of the game for the future. Here again, the primary focus of the study was the analysis of the relationship between passes in a possession and the probability of scoring.

Method

Data on games from the 2012 NCAA National Championship Tournament were analyzed. From the 68 team single elimination tournament, 33 games were randomly selected. To qualify for the tournament, teams had to win their respective conference or conference tournament, or be selected as at-large team by the tournament committee. Therefore, teams and games selected for the study represented all NCAA Division I levels of play from all regions of the country.

For the study, a basketball possession was standardized and defined as when a team gains possession of the ball until the opponent gains possession of the ball. In the U.S., college basketball is played under a 35 second shot clock. The time of a standardized possession was not restricted to 35 seconds, the time of the possession could be extended, i.e. by an offensive rebound, defensive foul, a kicked ball by the defense or by a held ball/jump ball situation that gives the ball back to the offensive team under the alternate possession rule.

For the study the number of passes for each pass-possession (p-pos) category that ranging from 0 to 23 were recorded along with the number of points scored, i.e. 0, 1, 2, 3, 4, and 5 respectively. For the 33 games analyzed through video, scores on 4,481 possessions were recorded. Of all the possessions in the sample, 90% of the possessions range from 0 p-pos to 7 p-pos.

Another consideration related to the research question was scoring outcomes. In the original data set the number of points scored for each possession was recorded. To help answer the research question, points scored for each possession were converted to a binary scores having two possible values, 0 = *not scoring* and 1 = *scoring*.

Results

In this section, the original data will be described to include, number in each pass-possession category, number of missing data, maximum and minimum point values in each pass-possession category, and the cumulative percentage of possessions in each category excluding missing data. Table 1, describes the above and illustrates that 90.1% of all possession were in the range from 0 p-pos to 7 p-pos.

Table 1: Descriptive Statistics for Pass-Possession Categories

Variable	N	N*	Minimum	Maximum	cummulative%
0-Passes	239	424	0	3	5.33
1-Pass	678	0	0	5	20.45
2-Passes	890	0	0	4	40.29
3-Passes	673	0	0	3	55.30
4-Passes	605	0	0	4	68.78
5-Passes	453	0	0	4	78.89
6-Passes	295	149	0	4	85.46
7-Passes	208	62	0	5	90.10
8-Passes	134	48	0	4	93.09
9-Passes	106	0	0	3	95.45
10-Passes	84	1	0	4	97.32
11-Passes	37	0	0	3	98.15
12-Passes	29	0	0	3	98.80
13-Passes	21	1	0	3	99.26
14-Passes	17	0	0	3	99.64
15-Passes	5	0	0	3	99.75
16-Passes	2	2	0	2	99.80
17-Passes	3	1	0	2	99.87
18-Passes	2	2	0	2	99.91
19-Passes	1	3	0	0	99.93
20-Passes	2	2	0	2	99.98
23-Passes	1	3	2	2	100.00

Data Conversion

Because the research question revolves around the probability of scoring for each pass-possession category, now scoring chance becomes the relevant question. Here, could a greater number of passes in a possession create a greater or lesser probability of scoring. Also, within a standard possession of *points scored*, the ability of the players, style of play, and/or the quality of the opposition can be factors leading to the number of points scored in a possession. Therefore, it is more logical to investigate not how many points have been scored in a possession, but the probability of scoring for a possession.

To answer the research question on the probability of scoring, data needed to be converted from the *point-scored* variable having numerical data to a *score* variable having categorical data. Here *no score* was recorded as a 0 and a *score* regardless of its value was recorded as a 1.

Data Analysis

In this section, exploratory data analysis is performed first, such as descriptive statistics and graphic representation of the data. Exploratory Data Analysis (EDA) will show the big picture of the data and examine the data structure. Then to further explore the quantitative relationship between scoring and passing, chi-square testing and logistic regression analysis will be applied to answer the research question. In Table 3, the original data from the eight p-pos categories are described by; the number of possession in each category, mean and standard deviation for points scored in each category and the percentage of the sample that each category represents.

Table 2: Descriptive Statistics: P-Pos, Points Scored, and Percentage of Sample

Pass-Possession	N	Mean/SD	% of Sample
0 Pass-Pos.	239	1.0753 (1.0097)	5.11
1 Pass-Pos.	678	1.0074 (1.0972)	14.49
2 Pass-Pos.	890	1.0112 (1.1204)	19.03
3 Pass-Pos.	673	0.9970 (1.1313)	14.39
4 Pass-Pos.	605	1.0033 (1.1009)	12.94
5 Pass-Pos.	453	0.9536 (1.1308)	9.69
6 Pass-Pos.	295	0.9797 (1.1836)	6.31
7 Pass-Pos.	208	1.1250 (1.2213)	4.45

To further illustrate a wider relationship between the pass-possession categories, Figure 3 illustrates that there is a peak at 2-passes, and after 2-passes the number of records in each group decreases sharply. It is also interesting to observe that if the 3 p-pos category is included, 53% of the entire sample (N = 4,481) falls within zero to three passes.

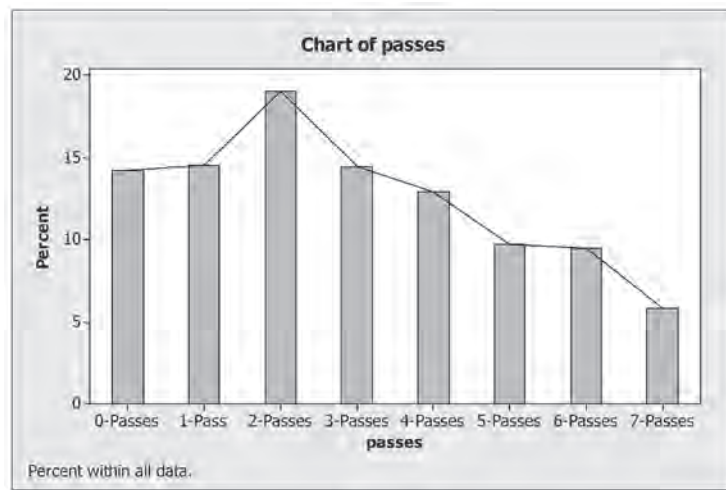

Figure 1

The next descriptive statistic related to the analysis is the new variable *score*. After converting *points scored* to *score*, this binary variable now only has two possible values, 0 for *no score* and 1 for the *score*. Figure 2 is a Pie Chart for the variable “score”. The chart contains data on each p-pos category. For example, in the category 0 p-pos, the 1’s represent a *score* equal to 136, or a scoring percentage of 56.9%. The number of 0’s is 103 and the percentage of *no scoring* is 43.1%. For the p-pos category having the highest percentage of possessions in the sample, 2-passes, the 1’s = 421 or 47.3%, while the 0’s equal 469 representing *no scoring* of 52.7%. It is interesting to note that with the exception of 0 p-pos and 7 p-pos (50/50), all categories have less 1’s than 0’s.

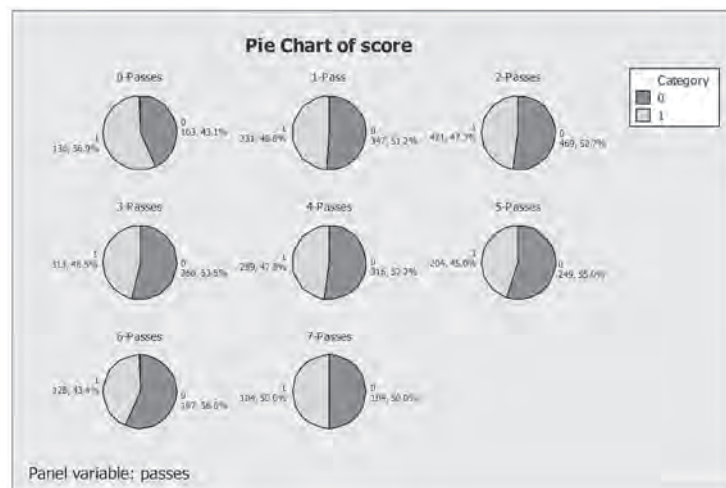

Figure 2

Logistic Regression

To be able to check the quantitative effect of one variable has on the other, logistic regression would be necessary. Logistic regression normally has been applied to the situation when outcomes are binary, i.e, 1 or 0, yes or no. The explanatory variable could be categorical or quantitative, or both. The general model of the logistic regression could be:

$$\log\left(\frac{\pi}{1-\pi}\right) = \beta_0 + \beta_1 X_1$$

Let's take a look at the left side of the model first. π is the probability of scoring, $1-\pi$ is the probability of no score. The ratio $\frac{\pi}{1-\pi} = \frac{P(y=1)}{P(y=0)}$ is known as the odds of the event $y=1$ occurring, in this case, that would be odds of scoring. For example, if $\pi = 0.6$ then the odds of scoring are $\frac{0.6}{1-0.6} = 1.5$, or 1.5 to 1. Then we take the log of odds in order to make the right side as linear combination of explanatory variables. Therefore, this is often referred to as the log-odds model.

On the right side of the model, X_1 is number of passes. First, it is treated as a categorical variable which means *passes* has 8 groups, next it is fitted as a quantitative variable which means *number of passes* have numeric values from 0-7. See Table 4.

Table 4

Binary Logistic Regression: score versus passes								
Link Function: Logit								
Response Information								
Variable	Value	Count						
score	1	1926	(Event)					
	0	2115						
	Total	4041						
* NOTE * 4041 cases were used								
* NOTE * 635 cases contained missing values								
Logistic Regression Table								
Predictor	Coef	SE Coef	Z	P	Odds Ratio	95% CI		
Constant	0.277926	0.130620	2.13	0.033				
passes								
1-Pass	-0.325132	0.151541	-2.15	0.032	0.72	0.54	0.97	
2-Passes	-0.385896	0.146864	-2.63	0.009	0.68	0.51	0.91	
3-Passes	-0.417827	0.151771	-2.75	0.006	0.66	0.49	0.89	
4-Passes	-0.367241	0.153904	-2.39	0.017	0.69	0.51	0.94	
5-Passes	-0.477259	0.161182	-2.96	0.003	0.62	0.45	0.85	
6-Passes	-0.543889	0.175676	-3.10	0.002	0.58	0.41	0.82	
7-Passes	-0.277926	0.190506	-1.46	0.145	0.76	0.52	1.10	
Log-Likelihood = -2790.169								
[Test that all slopes are zero: G = 12.835, DF = 7, P-Value = 0.076								

Logistic Regression Table 5

Fit the model with *passes* as categorical variable.

First, we use variable “passes” to fit the model. Since “passes” is a categorical variable, it’s also called a factor.

Table 5

Binary Logistic Regression: score versus passes							
Link Function: Logit							
Response Information							
Variable	Value	Count	(Event)				
score	1	1926					
	0	2115					
	Total	4041					
* NOTE * 4041 cases were used							
* NOTE * 635 cases contained missing values							
Logistic Regression Table							
Predictor	Coef	SE Coef	Z	P	Odds Ratio	95% CI	
Constant	0.277926	0.130620	2.13	0.033			
passes							
1-Pass	-0.325132	0.151541	-2.15	0.032	0.72	0.54	0.97
2-Passes	-0.385896	0.146864	-2.63	0.009	0.68	0.51	0.91
3-Passes	-0.417827	0.151771	-2.75	0.006	0.66	0.49	0.89
4-Passes	-0.367241	0.153904	-2.39	0.017	0.69	0.51	0.94
5-Passes	-0.477259	0.161182	-2.96	0.003	0.62	0.45	0.85
6-Passes	-0.543889	0.175676	-3.10	0.002	0.58	0.41	0.82
7-Passes	-0.277926	0.190506	-1.46	0.145	0.76	0.52	1.10
Log-Likelihood = -2790.169							
Test that all slopes are zero: G = 12.835, DF = 7, P-Value = 0.076							

Above in Table 5 is part of the output from logistic regression. The model fit used 4041 records because other 635 are missing values, which is correct. Note that the last line is the overall test that all slopes are zero and p-value of this test is 0.076, which is the same result from chi-square test, meaning that at least one slope in the model is not zero at the significance level of 0.10.

Above the overall test is Logistic Regression Table, showing the estimated coefficients, standard error of the coefficients, z-values and p-values. The odds ratio and their 95% confidence intervals also have been computed. Based on the coefficient estimates, we can write down the regression equation. The reference factor level of this model is 0-passes because the statistical software (MINITAB) always uses the first group listed as the reference by default, and the reference event is *no score*. So π in the below equation is the probability of scoring.

All p-values in the Logistic Regression Table are less than 0.10 except 7-passes, which indicates that there is sufficient evidence that the coefficients are not zero at $\alpha=0.10$ and these pass-groups have effect on log-odds of scoring.

First constant line is the estimated intercept of the equation, 0.2779, which can be converted into the odds of scoring for 0-passes group, $\exp(0.277926)=1.3204$.

But the interpretation of the slopes is different. Under passes, the first line is regarding 1-passes group. The estimated slope coefficient of -0.3251 for X_1 and odds ratio of 0.72 ($=\exp(-0.3251)$) represent the change in the odds of scoring between 1-passes group and 0-passes group. For 1-passes group, the odds of scoring is 28% (=1-72%) less than for 0-passes group. The estimated coefficient for X_2 is -0.3859 and odds ratio between 2-passes group and 0-passes group is $\exp(-0.3859)=0.68$, which means the odds of scoring after two passes is 32% lower than 0-passes group. You can get the similar

results for other groups compared with 0-passes group since all slope estimates are negative. In sum, the probability of scoring decreases as number of passes increases.

$$\log\left(\frac{\pi}{1-\pi}\right) = 0.2779 - 0.3251X_1 - 0.3859X_2 - 0.4178X_3 - 0.3672X_4 - 0.4773X_5 - 0.5439X_6 - 0.2779X_7$$

Among wich,

$$X_1 = \begin{cases} 1 & \text{passes} = 1 - \text{passes} \\ 0 & \text{otherwise} \end{cases} \quad X_2 = \begin{cases} 1 & \text{passes} = 2 - \text{passes} \\ 0 & \text{otherwise} \end{cases} \quad X_3 = \begin{cases} 1 & \text{passes} = 3 - \text{passes} \\ 0 & \text{otherwise} \end{cases}$$

$$X_4 = \begin{cases} 1 & \text{passes} = 4 - \text{passes} \\ 0 & \text{otherwise} \end{cases} \quad X_5 = \begin{cases} 1 & \text{passes} = 5 - \text{passes} \\ 0 & \text{otherwise} \end{cases} \quad X_6 = \begin{cases} 1 & \text{passes} = 6 - \text{passes} \\ 0 & \text{otherwise} \end{cases}$$

$$X_7 = \begin{cases} 1 & \text{passes} = 7 - \text{passes} \\ 0 & \text{otherwise} \end{cases}$$

Fit the model with number of passes as quantitative variable (Table 6).

Here, the variable *number of passes* is used to fit the model. Since we already recoded this variable into a numeric one, it would be treated as quantities in the model.

Binary Logistic Regression: score versus number of passes

Link Function: Logit

Response Information

Variable	Value	Count	
score	1	1926	(Event)
	0	2115	
	Total	4041	

* NOTE * 4041 cases were used
 * NOTE * 635 cases contained missing values

Logistic Regression Table							
Predictor	Coef	SE Coef	Z	P	Odds Ratio	95% CI	
						Lower	Upper
Constant	0.0110158	0.0604684	0.18	0.855			
number of passes	-0.0341628	0.0168694	-2.03	0.043	0.97	0.93	1.00

Log-Likelihood = -2794,533

Test that all slopes are zero: G = 4.108, DF = 1, P-Value = 0.043

In Table 6, when checking the last line of this part of the output, the p-value of the test of all slopes=0 is 0.043 < 0.10, which means *number of passes* has effect on log-odds of scoring and it should be included in the model.

Then go back to Logistic Regression Table above, as before, it has coefficient estimates, standard errors, z-values and p-values, the odds ratio and their 95% confidence intervals. The reference event is *no score*. So π in the model is still the probability of scoring.

$$\log\left(\frac{\pi}{1-\pi}\right) = 0.0110 - 0.0342X$$

Among which, X is the number of passes, which could be 0, 1, 2, 3, 4, 5, 6, 7.

The interpretation is little different from the previous one since the predictor (number of passes) now becomes quantitative. With slope of (-0.0342) we would state that for one more pass the log odds of scoring decreases by 0.0342. With odds ratio 0.97 ($=\exp(-0.0342)$), we would say that one more pass decreases odds of scoring by 3% (1-0.97). Although there is evidence that the estimated coefficient in number of passes is not zero (p-value=0.043), the odds ratio is very close to one (0.97), indicating that one more pass slightly affects the odds of scoring. A more meaningful difference would be found if the odds ratio were higher. For example, if number of passes increased by 5, the odds ratio becomes 0.8428, indicating that the odds of scoring decreases by 15.72%.

Although the quantities are different from the previous model with passes as a categorical variable, the conclusions are the same that more passes decrease the probability of scoring.

Conclusion and Discussion

From the Exploratory Data Analysis section of the study it can be seen that the 0 pass-possession category is the only category with a probability of scoring over 50% (57%). To explain why this category is substantially above the other categories whose probabilities range from 50% down to 43%, we need to look first at the nature of the game itself. Typically, possession having no passes, occur when a steal/interception is made or when a long rebound leads to a fast break situation with a high probability of scoring off a dribble situation. It might be expected that the mean number of points scored from these possessions would be the highest amongst all categories, it is not. The primary reason for this is that scoring in these type possessions generally end up with opportunities near the the basket and not with three point shot opportunities. Once the ball has been passed at least once, scoring probability is no greater than 50%, and on average only 46% for pass-possession one through six.

The analysis of the entire range of pass-possession categories, indicate that the different groups have different scoring possibilities. Therefore, data on the number of passes is useful when predicting probability of scoring.

In the study, only one predictor (*passes* or *number of passes*) has been included in the analysis to predict probability or chance of scoring. However, there are many factors that may affect scoring or not scoring, some include style of play, the offensive ability of players, strength of opponent, and the quality of shot selection. In terms of shot selection, (Swalgin, 1998) has demonstrated that shots taken by players closer to the basket increases shooting percentage.

In regards to the significance level used in the study, both 0.05 and 0.10 are very commonly used cut-off p-values. The p-value used for this research was at the 0.10 level. If a 0.05 p-value would have been used, only one conclusion would have been affected, which is the results from the chi-square test. All other would have remained the same. Therefore, we can conclude that, the number of passes in a possession are directly related, at least at the 0.10 level, and that the probability of scoring decreases as the number of passes increase.

References

1. <http://www.ncaa.org/championships/statistics/division-i-mens-basketball-statistical-trends>
2. Swalgin, K.L., The basketball evaluation system: a computerized factor-weighted model with measures of validity. *The International Scientific Journal of Kinesiology and Sport*. 30:1, 31- 37.

BILATERAL DIFFERENCES IN PUNCH VELOCITY AND ACCURACY IN TAEKWONDO ATHLETES

Saša Vuk

Faculty of Kinesiology, University of Zagreb, Croatia

Abstract

The ability to punch with both hands is regarded as a desirable skill in high level taekwondo athletes; however, most athletes display a dominance of one side of the body relative to another. Therefore, the two main objectives of this study are presented: 1) to determine whether there is a difference in maximum punch velocity between dominant and non-dominant hand, and 2) to determine whether there is a difference in the punch accuracy between dominant and non-dominant hand. Forty-two taekwondo athletes were measured by *Punch system* which is specially designed to measure the velocity and accuracy of a punch. Differences between the punch accuracy of a left and right hand, and difference between punch velocity of a left and right hand were determined by univariate analysis of variance. The average punch velocities were 8.08 m/s (± 2.39) and 6.73 m/s (± 1.67) for the right and left hand, respectively. Average punch lengths, as a measure of an accuracy, were 50.81 cm (± 3.74) and 51.24 cm (± 5.11) for the right and left hand, respectively. By univariate analysis of variance it was determined that there was a difference in punch velocities ($F_{1,82} = 8.85, p < .01$) between right and left hand. There was no difference between the punch accuracy of a left and right hand ($F_{1,82} = 0.19, p = .662$). The findings of this study suggest that each limb is specialized in controlling various features of the movement: the dominant side to control the punch velocity, while the non-dominant side is responsible for controlling the position of the limb, i.e. the focus of the punch.

Key words: *handedness, left hand, right hand, dominance*

Introduction

The ability to punch with both hands is regarded as a desirable skill in high level taekwondo athletes; however, most athletes display a dominance of one side of the body relative to another. Previous studies also show clear differences between dominant and non-dominant side in performance and the related activity in different parts of the brain, especially in relation to upper limb motor tasks (Kapreli et al., 2006). This suggests that it is important to take limb dominance into account when studying the performance of different motor tasks.

In general, limb dominance is related to the notion that two hemispheres of the human brain are functionally dissimilar (Nachshon, Denno, & Aurand, 1983; Gabbard, & Hart, 1996). Specifically, left hemisphere is specialized for precise control of fine motor actions on both sides, while the right hemisphere is related to bilateral somatosensory spatial abilities, emotion expression, and motor functions (Cavagna, Tesio, Fuchimoto, & Heglund, 1983; Colborne, Naumann, Longmuir, & Berbrayer, 1992; Colborne, Wright, & Naumann, 1994).

A variety of studies suggest that 70-90% of the world population is right-handed (people who are more dexterous with their right hand when performing tasks), and only 10-13% is left-handed (Hardyck, & Petrinovich, 1977; Raymond, Pontier, Dufour, & Moller, 1996). Hence, the lack of familiarity with the playing techniques and tactical strategies of left-handed competitors may disadvantage a player to act the same as when faced with a right-hander (Loffing, Hageman, & Strauss, 2010). As a result, the inexperience of those players ultimately creates an advantage for their left-handed opponent (Wood, & Aggleton, 1989). Therefore, the left-handed people are more successful in certain interactive sports such as tennis, fencing, or martial arts (Faurie, & Raymond, 2005). Loffing, et al. (2011) emphasize that in interactive sports such as tennis and volleyball, performance depends on sport-specific perceptual or anticipatory skill. The ability to exploit the movement information available early in an action sequence in order to anticipate an opponent's intention is crucial to successful performance (Farrow, & Abernethy, 2003; Williams, & Ward, 2003). However, if the opponent is left-handed, this anticipation is aggravated. Success in taekwondo also depends to some extent on dominance. As already mentioned, in order to combat, left-handers may have a tactical advantage over right-handers. However, does the dominance of certain body side in the taekwondo forms represent, where the symmetrical performance with both hands and feet is needed, an advantage or disadvantage? Fast and accurate punches are responsible for the successful realization of taekwondo forms. Forms (*Poomses*) are a series of movement sequences consisting of punching, blocking and kicking techniques as well as twisting, leaping, turning and jumping movements performed at high intensity (Melhim, 2001). For this reason, maximal punch velocity and punch length with both hands were tested in this study. Because the punch is most frequent technique in all forms, it is optimal technique for the measurement of maximum velocity and length.

For those reasons, the two main objectives of this study are presented: 1) to determine whether there is a difference in maximum punch velocities between the dominant and non-dominant hand; and 2) to determine whether there is a difference in the accuracy of the punches between the dominant and non-dominant hand.

Regarding the primary goals, two related hypotheses were set: H1) athletes who systematically train taekwondo do not have different maximal punch velocities between the dominant and non-dominant hand; and H2) athletes who systematically train taekwondo do not have different lengths between the dominant and non-dominant hand.

Methods

Subjects

Under the testing hypotheses the sample of 42 (18.7 ± 2.1 years) athletes who actively train Taekwondo for at least 2 years (4 ± 1.2 years) and who were well familiar with the punch technique were measured. All subjects included in the study were right-handers.

All subjects were familiar with the objectives and potential risks of research and, subsequently, signed a written consent to participate in the experiment. The study was fully in accordance with the Helsinki Declaration. Subjects had no history of muscular-skeletal injuries of the hands and shoulder area over the last three years.

Measuring instrument

In this study a specially designed system is used (*Punch system*). It is a mechanical sensor which enables the measurement of punch velocity and punch accuracy. System consists of three parts. The first part makes a wooden frame (dimensions: $90 \times 60 \times 2$ cm). On wooden platform is placed a mechanical sensor, which consists of wireless base and telescopic rod that rotates freely within $\pm 40^\circ$ around the base. The upper part of the telescopic rod, whose length depends on the height of subjects (more accurately, the height of the subjects plexus), by textile ribbon is fixed to the subject's hand and wrist. The third part of the system represents computer application (*LabVIEW 8.5, National Instruments, Austin, TX*) that receives real-time data from the base and displays them on the computer screen.

Testing procedure

Subject stands on a platform of the *Punch system* in taekwondo walking stance (*Ap-seogi*). The base of a system is located in front of the body, next to the opposite foot of the punching hand, which is placed on the hip. The opposite hand is extended in front of the body. The punch is performed each time as quickly as possible straight forward, into the plexus (reverse punch or *Momtong-jireugi*), while the other hand is simultaneously coming to the hip. During the punch, the subject's torso should remain upright without forward bend, which could increase the maximum punch velocity.

The punch velocity is recorded in meters per second and the punch length is recorded in centimeters. This information is stored in a database for further processing and analysis.

In this experiment, each subject performed three consecutive punches by each hand, where the pause between repetitions was less than 30 seconds, and between the hands changes of 1 minute. Results with highest velocities for each hand, and corresponding punch length were used in the analysis.

Data analysis

Punch system during each punch captures a series of data about the angle and time required for achieving this angle. Angular velocity w (s^{-1}), based on data of the angle a (rad) and time t (s), is calculated as: $\Delta w = \Delta a / \Delta t$.

Based on the length of the rod r (m) which is manually entered into the application and the calculated angular velocity Dw , a circumferential velocity Dv (ms^{-1}), or the subject's punch velocity, is calculated as: $\Delta v = \Delta w \cdot r$. Maximum punch velocity is defined as a maximum value of circumferential velocity during the punch and is displayed on the screen. The punch length is calculated as $l = r \cdot p \cdot a / 180$ (where p represents the mathematical constant value of 3.14).

Statistical analyses

Descriptive statistics were calculated for all experimental data as mean and SD. Differences in punch velocities and punch lengths between left and right hands were tested by one-way analysis of variance (ANOVA). The level of statistical significance was set to $p = .05$.

Results

Values of the punch velocities range within the intervals from 3.86 m/s to 13.73 m/s, and from 4.18 m/s to 10.69 m/s for the right and left hand, respectively. Average values are 8.08 m/s (± 2.39) and 6.73 m/s (± 1.67) for the right and left hand, respectively. The average lengths are 50.81 cm (± 3.74) and 51.24 cm (± 5.11) for the right and left hand, respectively. ANOVA of the punch velocities revealed significant difference ($F_{1,82} = 8.85$, $p < .01$) between the right and left hand. No significant differences between hands in punch length ($F_{1,82} = 0.19$, $p = .662$) were observed.

Discussion and conclusions

In this experiment differences in punch velocities and punch accuracy between the dominant and non-dominant hands during the performance of a maximally fast punch were tested.

Generally, the results do not support the first hypothesis (i.e., that athletes who systematically train taekwondo do not have different punch velocities between the dominant and non-dominant hand), but the results support the second hypothesis (i.e., that athletes who systematically train taekwondo do not have different punch lengths between the dominant and non-dominant hand). However, prior to discussing the main findings, several important methodological aspects need to be stressed.

First, it should be noted that the *Punch system* is a mechanical sensor to its structure and to some extent it restricts the freedom of a hand movement. The telescopic rod is attached to its base, so the height of the hand is determined by exactly its height. Therefore, hand can move freely only in two dimensions (i.e., left-right and forward-backward). However, as the predefined punch has to be properly performed only in one dimension (i.e., the direction forward-backward), oscillations from side to side or up and down are not allowed, this system provides sufficient room for the proper and undisturbed performance of a punch.

Second, it should be noted that telescopic rod has a certain mass and therefore the inertia, so each subject during the performance of a punch must accelerate, beside their own hand, the weight of the rod. Nevertheless, that resistance that rod provides is negligibly small and equal for all subjects, so the effect of inertia of the rod on the results can be ignored.

And third, it is important to note that constructed system is not limited by laboratory conditions, it is easily portable and allows for the direct measurement at any training hall or even at the competitions.

The reverse punch has been the subject of biomechanical research in taekwondo and karate, but different study designs disabled fully comparison of the results. Nevertheless, Smith and Hamill (1986), similar to Pieter F. and Pieter, W. (1995) recorded a punch velocity of 11 m/s. Walker reported a velocity of 7 m/s, which compares favorably with the punch performed in this study. Differences in execution of the punch may account for differences in velocity in addition to the methods of assessing punching velocity. For instance, different skill level of the subjects, performing of a standing versus stepping punch, or measuring the karate opposed to taekwondo athletes may account for differences in punch velocities. However, those studies have not compared the bilateral differences between punch velocities.

The first main finding of this study indicates a difference between the punch velocities of dominant and non-dominant hand. According to the authors' knowledge so far no one has conducted similar study of the upper limbs. However, McLean and Tumilty (1993) found a difference between the kick velocity and its accuracy between the preferred and non-preferred leg. Other studies confirm that the dominant limb is generally responsible for the control of limb dynamics (Sainburg, 2005). However, it should be noted that statistically significant difference in velocities obtained between the dominant and non-dominant hand (8.08 m/s versus 6.73 m/s) without some sort of measuring device can not be seen, although, as the results show, it really exists. In practical terms, during the performance of taekwondo form at the competition, judges may not notice such difference in punch velocities between the two hands. However, it is possible to notice the difference between punch focuses, i.e. judges can notice if there is an asymmetry in performance between the dominant and non-dominant hand.

Second main finding confirms second hypothesis, i.e. that differences in punch accuracy between the dominant and non-dominant hand exist. Previous research supports this finding. Specifically, it was found that the tasks which require precise movements are better and more accurately performed with the left (or non-dominant) in relation to the right (or dominant) hand (Barthelemy, & Boulinguez, 2001; Miesche, Elliot, Helsen, Carson, & Coull, 2001; Velay, & Benoit-Dubrocard, 1999; Velay, Daffaure, Raphael, & Benoit-Dubrocard, 2001; Guiard, Diaz, & Beaubaton, 1983; Boulinguez, Velay, & Nougier, 2001; Sainburg, 2005; Asai, Sugimori, & Tanno, 2010). Sainburg (2005) emphasizes that each hemisphere/limb system is specialized in controlling different, but complementary features of movement: the dominant system for controlling limb dynamics and non-dominant system appears specialized for controlling limb position. Another possible explanation is that right-hemisphere advantage for the spatial planning of movements in right-handers produces pronounced accuracy advantages for the left hand (Lenhard, & Hoffmann, 2007). Also, it should be noted that the punch velocity in not-dominant hand was smaller than the in dominant hand, which could provide greater precision and thus the same focus in both hands. In further studies this statement should be verified by using electromyographic (EMG) recordings, which should reveal corresponding differences in normalized EMG activities between the hands.

In this context, one might hypothesize that punching with dominant hand is specifically associated with performance velocity, and punching with the non-dominant hand is specifically associated with greater accuracy when tasks involve both accuracy and velocity simultaneously (Asai, Sugimori, & Tanno, 2010). This division of labor is consistent while performing the typical bimanual motor tasks such as hammering nails, or holding the baseball bat, where the non-dominant hand tends to stabilize an object while the dominant hand performs the task. For this reason it is inappropriate to conclude that the dominant system is generally “better” than non-dominant. Instead, it is appropriate to conclude that each system is specialized for unique processes. This hypothesis is supported by findings in unilaterally lesioned stroke patients, which have revealed consistent deficits in ipsilesional arm. Dominant hemisphere lesions produce deficits in performance speed, whereas non-dominant lesions produce deficits in final positional accuracy (Haaland, Prestopnik, Knight, & Lee, 2004).

Punch focus symmetry is probably result of the great number of a high quality punch repetitions performed with both hands, which leads to the conclusion that the programmed training sessions can influence the development of those abilities that predominantly do not “belong” to a certain limb (dominant or non-dominant). In this context, as *Punch system* can accurately detect the slightest differences in the punch velocities, the systematic training sessions can reduce the differences between the maximum velocity of the dominant and non-dominant hands for better performance of the technical elements in Taekwondo.

Further research should be directed to the other populations, including left-handers and mixed-handers, and also to determine whether the same principles can be applied for the lower limbs.

References

- Asai, T., Sugimori, E., & Tanno, Y. (2010). Two agents in the brain: motor control of unimanual and bimanual reaching movements. *PLoS ONE*, 5(4), e10086.
- Barthelemy, S., & Boulinguez, P. (2001). Manual reaction time asymmetries in human subjects: the role of movement planning and attention. *Neuroscience Letter*, 315, 41-44.
- Boulinguez, P., Velay, J.L., & Nougier, V. (2001). Manual asymmetries in reaching movement control. II: Study of left-handers. *Cortex*, 37, 123-138.
- Cavagna, G.A., Tesio, L., Fuchimoto, T., & Heglund, N.C. (1983). Ergometric evaluation of pathological gait. *Journal of applied physiology: respiratory, environmental and exercise physiology*, 55(2), 607-613.
- Colborne, G.R., Naumann, S., Longmuir, P.E., & Berbrayer, D. (1992). Analysis of mechanical and metabolic factors in the gait of congenital below knee amputees. A comparison of the SACH and Seattle feet. *American Journal of Physical Medicine & Rehabilitation*, 71(5), 272-278.
- Colborne, G.R., Wright, F.V., & Naumann, S. (1994). Feedback of triceps surae EMG in gait of children with cerebral palsy: a controlled study. *Archives of Physical Medicine and Rehabilitation*, 75(1), 40-45.
- Farrow, D., & Abernethy, B. (2003). Do expertise and the degree of perception-action coupling affect natural anticipatory performance? *Perception*, 32, 1127-1139.
- Faurie, C., & Raymond, M. (2005). Handedness, homicide and negative frequency-dependent selection. *Proceeding of the Royal Society of London B*, 272, 25-28.
- Gabbard, C., & Hart, S. (1996). A question of foot dominance. *Journal of General Psychology*, 123(4), 289-296.
- Guiard, Y., Diaz, G., & Beaubaton, D. (1983). Left hand advantage in right-handers for spatial constant error: preliminary evidence in a unimanual ballistic aimed movement. *Neuropsychologia*, 21, 111-115.
- Haaland, K.Y., Prestopnik, J.L., Knight, R.T., & Lee, R.R. (2004). Hemispheric asymmetries for kinematic and positional aspects of reaching. *Brain*, 127, 1145-1158.
- Hardyck C., & Petrinovich L.F. (1977). Left-handedness. *Psychological Bulletin*, 84(3), 385-404.
- Kapreli, E., Athanasopoulos, S., Papatasiou, M., Van Hecke, P., Strimpakos, N., Gouliamos, A., Peeters, R., & Sunaert, S. (2006). Lateralization of brain activity during lower limb joints movement. An fMRI study. *Neuroimage*, 32, 1709-1721.
- Lenhard, A., & Hoffmann, J. (2007). Constant error in aiming movements without visual feedback is higher in the preferred hand. *Laterality*, 12, 227-238.
- Loffing, F., Hagemann, N., & Strauss, B. (2010). Automated processes in tennis: Do left-handed players benefit from the tactical preferences of their opponents? *Journal of Sports Sciences*, 28, 435-443.
- Loffing, F., Schorer, J., Hagemann, N., & Joseph, B. (2011). On the advantage of being left-handed in volleyball: further evidence of the specificity of skilled visual perception. *Attention, Perception and Psychophysics*, in press.
- Melhim, A.F. (2001). Aerobic and anaerobic power responses to the practice of taekwon-do. *British Journal of Sports Medicine*, 35, 231-235.
- Mieschke, P.E., Elliott, D., Helsen, W.F. Carson, R.G., & Coull, J.A. (2001). Manual asymmetries in the preparation and control of goal-directed movements. *Brain and Cognition*, 45, 129-140.
- Nachshon, I., Denno, D., & Aurand, S. (1983). Lateral preferences of hand, eye and foot: relation to cerebral dominance. *International Journal of Neuroscience*, 18(1-2), 1-9.
- Pieter, F., & Pieter, W. (1995). Speed and force in selected Taekwondo techniques. *Biology of Sport*, 12(4), 257-266.

21. Raymond, M., Pontier, D., Dufour, A.B., & Moller, A.P. (1996). Frequency-dependent maintenance of left-handedness in humans. *Proceeding of the Royal Society of London B*, 263, 1627-1633.
22. Sainburg, R.L. (2005). Handedness: differential specializations for control of trajectory and position. *Exercise and Sport Sciences Reviews*, 4, 206-213.
23. Smith, P.K., & Hamill, J. (1986). The effect of punching glove type and skill level on momentum transfer. *Journal of Human Moving Studies*, 12, 153–161.
24. Velay, J.L., & Benoit-Dubrocard, S. (1999). Hemispheric asymmetry and interhemispheric transfer in reaching programming. *Neuropsychologia*, 37, 895-903.
25. Velay, J.L., Daffaure, V., Raphael, N., & Benoit-Dubrocard, S. (2001). Hemispheric asymmetry and interhemispheric transfer in pointing depend on the spatial components of the movement. *Cortex*, 37, 75-90.
26. Williams, A.M., & Ward, P. (2003). Perceptual Expertise: Development in sport. In: *Expert performance in sports: Advances in research on sport expertise*. Eds. Starkes, J.L. & Ericsson, K.A. Champaign, IL: Human Kinetics. 219-249.
27. Wood, C.J., & Aggleton, J.P. (1989). Handedness in “fast ball” sports: Do left-handers have an innate advantage? *British Journal of Psychology*, 80, 227-240.

EVALUATION OF ATTACK-CONTRIBUTION IN COLLEGIATE WOMEN'S HANDBALL

Eiko Yamada

University of Tsukuba, Japan

Abstract

In the present study, we evaluated female collegiate players to reveal the relationship between their positions and attack-contribution utilizing final dependency and final efficiency. The sample population comprised 28 matches played by 8 collegiate women's teams in the Japan-Kanto-League. The total number of subjects was 56 players, including 7 players from each team with the highest final dependency. Processing data, calculated average, standard deviation, and coefficient of variation were calculated for each item and compared among players. Back court players had the highest final dependency ($14.9 \pm 10.2\%$), followed by wings ($9.4 \pm 5.3\%$), and finally, pivots ($7.3 \pm 4.1\%$). On the other hand, pivots had the highest final efficiency ($53.9 \pm 27.4\%$), followed by wings ($46.9 \pm 23.8\%$), and then backs ($28.9 \pm 17.6\%$). Final dependency and final efficiency were related to player position, and the tendency of backs differed from that of wings and pivots.

Key words: *game analysis, attack-contribution, final dependency, final efficiency*

Introduction

In the game of handball, the goal of the team while on defense is to prevent the attackers from scoring a goal and to regain possession of the ball by letting an attacker shoot. For example a goal keeper can make a save or provoke an attacker to execute a technical fault (TF) (Stiehler et al., 1999). For an effective defense, the coach and players analyze the opposing players' characteristics and their roles on the team before the match; for example, who has the highest shot frequency, who has the highest shot success rate, and who is best at assisting. The analysis is usually made based on experience and initial impression, however, rather than quantitatively. Nagano et al. (2010) evaluated attack-contribution in men's collegiate handball players by combining two values: final dependency and final efficiency. Final dependency was defined as how often each player shoots or executes a TF before losing possession of the ball in the attack phase relative to that of the their team members. Final efficiency was defined as the number of goals relative to the number of shots and TF. By combining final dependency and final efficiency, players were comprehensively evaluated and the attack-contributions showed different tendencies based on player position.

Foretic et al. (2011) reported that men and women have different game performances based on differences in their physical constitution, technique, preference, and biomechanical characteristics. Thus, an appropriate criterion for evaluating the attack-contribution of women must be developed. Here we evaluated the attack-contribution based on final dependency and final efficiency in women's collegiate handball.

Methods

The population sample comprised 28 matches played by 8 women's collegiate teams in the Japan-Kanto-League. In the Japan-Kanto-League, each team played all of the teams in Round 1, and then they were divided into 2 groups according to the Round 1 results with the top 4 placed in one group and the bottom 4 placed in another group for Round 2. The sampled matches included the 28 matches of Round 1 of the Japan-Kanto-league, so each team played the same number of matches against the same opponents. The subjects comprised 56 players, each of whom was among the 7 players with the highest final dependency score on their team. Basic data regarding the play results were collected using the running score in real time. A video of each match was observed to clarify unclear play result scenes after the match was over. Basic data for each player were then calculated.

Variables. The evaluated variables included the number of Attacks (number of shots + number of TF), Shot efficiency (number of goals/number of shots $\times 100$), Final efficiency (number of goals/(number of shots + number of TF) $\times 100$), and Final dependency ((number of shots + number of TF)/ number of team attacks $\times 100$).

Data processing. Calculated average, standard deviation, and coefficient of variation for each item were compared among players. Attack-contribution is categorized in the figure, with final dependency on the x-axis and final efficiency on the y-axis. In the figure, the characteristics were divided into 4 types as follows, the cutoff criterion for the final dependency was 15% and that of the final efficiency was 45% (Nagano et al., 2010).

- Type 1: final dependency >15%, final efficiency >45%
- Type 2: final dependency >15%, final efficiency <45%
- Type 3: final dependency <15%, final efficiency > 45%
- Type 4: final dependency <15%, final efficiency <45%

Results

Table 1 shows a prime example of game performance and types from the league’s winning team. There were no Type 1 players, that is, players who scored more than 15% in final dependency and more than 45% in final efficiency. On the other hand, only back court players were categorized as Type 2, scoring more than 15% in final dependency and less than 45% in final efficiency. There were very few Type 3 players, but these players had high efficiency when shooting and when there were only wing and pivot players. Furthermore, Type 4 players, with low final dependency and low final efficiency, showed no tendency toward a particular position.

Table 1: Game performances and types of the winning team

player	position	number of shots	number of goals	TF	shot efficiency	final dependency	final efficiency	type
1	Back	12.0±3.0 (25.0)	3.7±2.1 (55.4)	3.1±1.8 (56.4)	30.1±15.1 (50.2)	24.1±5.6 (23.3)	24.5±14.4 (58.9)	2
2	Back	7.7±3.0 (39.4)	4.7±3.7 (78.1)	4.0±2.1 (52.0)	55.0±24.9 (45.2)	18.6±6.3 (33.6)	35.7±36.8 (19.6)	2
3	Back	7.6±3.9 (51.1)	2.9±2.5 (86.7)	3.9±2.5 (66.0)	40.4±32.8 (81.2)	18.2±7.9 (43.6)	29.0±25.1 (86.4)	2
4	Wing	6.3±3.8 (60.7)	3.0±2.0 (66.7)	1.1±0.4 (33.1)	43.5±22.7 (52.1)	11.8±6.1 (51.2)	37.0±18.7 (50.4)	4
5	Wing	3.7±2.1 (57.6)	2.1±1.3 (62.8)	0.7±0.8 (122.5)	56.2±30.0 (53.3)	6.8±3.9 (56.9)	49.8±25.1 (50.4)	3
6	Pivot	3.0±1.9 (62.4)	2.4±1.5 (63.2)	1.2±1.3 (108.7)	52.1±83.3 (16.7)	4.8±4.8 (100.2)	63.8±22.8 (35.7)	3
7	Wing	4.3±2.9 (67.6)	3.3±2.6 (80.9)	0.3±0.6 (173.2)	78.1±21.3 (27.0)	4.1±4.8 (117.1)	75.7±20.5 (27.0)	3

Data are presented as Mean±Standard deviation (Coefficient of Variation)
 TF = technical fault

The means and standard deviations of the final dependency and final efficiency in each position (Figure1) indicated that back court players had the highest final dependency (14.9±10.2%), followed by wings (9.4±5.3%), and finally pivots (7.3±4.1%). On the other hand, pivots had the highest final efficiency (53.9±27.4%), followed by wings (46.9±23.8%), and then backs (28.9±17.6%).

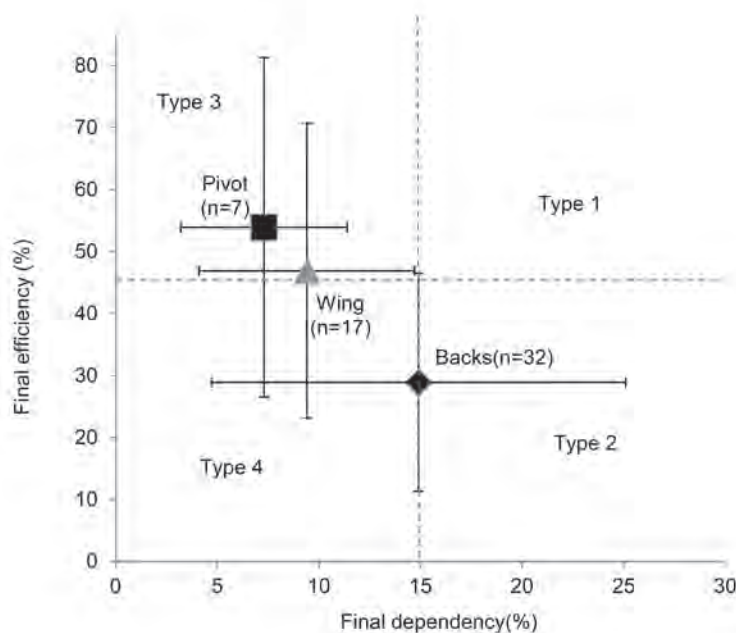

Figure1: Mean and standard deviations of the final dependency and final efficiency in each position

Discussion and conclusions

None of the players was categorized as Type 1, and the final dependency criterion of 15% (Nagano et al.2010) was too high for the wings and pivots among Japanese collegiate women. Moreover, the final efficiency criteria were also high for Japanese collegiate women back court players. These findings indicate that appropriate criteria are needed for proper evaluation of women players. Based on the categorizing and attack-contribution results for each position, final dependency and final efficiency are related to position, and trends of the back position are different from those of the wings and pivots. In other words, the criteria for final dependency and final efficiency must be adjusted according to position when evaluating the player's attack-contribution.

This study aimed to evaluate collegiate women handball players and reveal the relationship between position and attack-contribution based on final dependency and final efficiency. Sex-appropriate standard rates for final dependency and final efficiency must be established for evaluating women collegiate women players. In addition, final dependency and final efficiency relate to player position, with backs showing a different tendency than wings and pivots. Additional studies using data from top-level world teams will be added to further develop the standards for evaluating women's handball at different levels.

References

1. Nagano D., Mizukami H., Kawamura R., Aida H. (2010) Players' evaluation by the final dependency and the final efficiency. *Japanese Journal of Handball* 12:126-130.
2. Foretic N., Rogulj N., Srhoj V., Burger A., Rakovic K. (2011). Differences in situation efficiency parameters between top men and women handball teams. *EHF Scientific Conference 2011 Science and Analytical Expertise in Handball*: 243-247.
3. Stiehler G., Konzag I., Döbler H (1999). *Sportspiele*. (Karaki K., Trans.) Tokyo: Taishukan, p. 359. (Original work published 1988).

BEGINNING WITH WRESTLING, WRESTLING EXPERIENCE AND WRESTLING MATURITY – TRENDS IN 2002-2012

Mario Baić¹, Hrvoje Karninčić² and Dražen Šprem¹

¹Faculty of Kinesiology, University of Zagreb, Croatia

²Faculty of Kinesiology, University of Split, Croatia

Abstract

The aim of this study was to describe the trend of beginning with wrestling, experience and maturity of wrestlers who won their first European Championship medal in the period from 2002 to 2012, and to determine the differences in those parameters between the weight categories. The study was conducted on a sample of 180 wrestlers. Variable sample: beginning with wrestling, wrestling experience, age of wrestler when he won his first European medal – maturity. Winners of European medals began with wrestling at the age of 10.27 ± 2.79 years, they had had 14.61 ± 4.02 years of wrestling experience before they won a medal and they won the medal at the age of 24.86 ± 3.29 years. In the period of 2002-2012, the wrestling experience trend and the maturity trend showed a decrease. One should begin with wrestling approximately at the age of 10 years. Experience and maturity are significantly correlated variables, but not the same variables. In the lightest and the heaviest weight categories wrestlers begin with wrestling at a later time and the period of wrestling before winning the first medal is shorter. In heavier categories it is even necessary to reach mature wrestling age.

Key words: *European championships, Greco-Roman wrestling, weight categories, seniors, ages*

DIFFERENCES BETWEEN 2010 AND 2011 SITUATION-RELATED INDICATORS OF TENNIS PLAY EFFICIENCY AT THE GRAND SLAM TOURNAMENTS – ROLAND-GARROS, WIMBLEDON AND US OPEN

Petar Barbaros Tudor¹, Miroslav Zečić² and Bojan Matković¹

¹Faculty of Kinesiology, University of Zagreb, Croatia

²Croatian tennis association, Croatia

Abstract

The aim was to ascertain whether any differences in the standard situation-related efficiency indicators can be discerned when the indicators of the matches played in the year 2010 are compared with the matches played in 2011 for each of the three greatest Grand Slam tournaments – Roland-Garros, Wimbledon and US Open. The sample of entities consisted of 1524 game statistics records of 127 men single matches played within the main draw of each of the three tournaments in each of the two observed years. The basic central and dispersive parameters were calculated, and independent samples t-test was used to establish differences between the explored years (significance level $p < 0.05$). The smallest number of differences were determined for the R-G tournament. Generally, at all the three tournaments speed deceleration of the 1st and 2nd serve was obvious in 2011, probably indicating the shift of players' focus on serve features other than power used for active entrance into points. The number of unforced errors increased at R-G in 2011, whereas on fast grass courts of Wimbledon and hard courts of US Open it was decreased, as well as the number of winners. The findings suggest that tennis play styles on fast courts tend to safer play with lower risks in the starting and middle phases of points, whereas on slow courts styles are characterized with a more aggressive play in the middle phase of points.

Key words: tennis game analysis, tennis situational efficiency, tennis statistics

DOES A RED FIGHTER WIN MORE OFTEN IN TAEKWONDO FIGHTS?

Renata Barić and Marko Mijić

Faculty of Kinesiology, University of Zagreb, Croatia

Purpose

Red color is usually associated with high power, aggressiveness, love, passion, and attention to details. The color of sportswear has been shown to influence the outcome of matches in several different combat sports, i.e. that there is a significant difference in the number of victories favoring the athlete wearing red (Hill, Barton, 2005; Hagemann, 2008; Attrill et al., 2008). The aim of this study is to investigate the existence of statistically significant difference in the number of victories between the taekwondo fighters wearing red outfits and the fighters wearing blue outfit in taekwondo honoring WTF sparring rules, with regard to taekwondo categories age and gender.

Methods

The sample consists of 9631 taekwondo matches in 50 competitions held over the years 2011 and 2012 in Croatia, Bosnia and Herzegovina, Serbia and Slovenia. Variables of this study include the outfit color (red and blue), age and gender (younger cadets and female cadets, cadets and female cadets, juniors and female juniors, seniors and female seniors).

Results

On the specified sample the athletes wearing red outfits had 63 more victories than the athletes wearing blue outfits, i.e. the athlete wearing red wins in 50.327% matches while the athlete wearing blue wins in 49.672% matches. The obtained difference is not statistically significant ($\chi^2 = 0.412$, $df = 1$, $p = 0.520$). Similar findings were obtained in all categories (age and gender).

Conclusions

Despite some previous evidences that wearing red outfit in different combat sports was associated with higher probability of winning, this study didn't confirm that bias. It may be concluded that factors such as skill and ability have the greatest influence in determining sporting outcomes, the subtle effects of red coloration may maybe contribute to the outcome when competitors are evenly matched, bringing psychological advantage to the red one because he/she feels more aggressive and looks more dangerous to the opponent, but this hypothesis should be tested on further sample of fighters from different combat sports.

References

1. Attrill, M. J., Gresty, K. A., Hill R. A., Barton, R. A. (2008). Red shirt color is associated with long-term team success in English football, *JSS*, 26(6)577-582.
2. Hagemann, N., Straus, B., Leißing, J. (2008). When the referee sees red. *Association for Philological Science*, 19(8)769.
3. Hill, R. A., Barton R. A. (2005). Sporting contests: Seeing red? Putting sportswear in context, *Nature*, 435:293.

Key words: *impact of color, red and blue fighters, win, aggressiveness*

HOW TO REDUCE THE DURATION OF JUMP SHOT IN BASKETBALL?

Boris Bazanov

Tallinn University, Institute of Health Sciences and Sports, Estonia

One-handed jump shot is the main form of shooting in the modern basketball. Along with shooting accuracy, it is important to perform a jump shot in less time. **The purpose** of the present paper was to study the structure of the elements of jump shot technique and find out the way of reducing the duration of jump shot activity.

The task was carried out by using *the methodology* of kinematic analysis developed in the Centre for Kinesiology Studies of Tallinn University. Jump shots analyzed were recorded from television broadcasts of Estonian Championship, World Championship and NBA games. All together, *185 resultive jump shots* were analyzed. Based on kinematic characteristics the whole action of shooting was divided into 5 phases. The data were processed statistically. Correlation analysis was carried out between the duration of the phases and the whole activity. Coefficient of variation was calculated for every phase and whole activity using formula $C = SD/mean * 100\%$.

The analysis carried out enabled to determine the phase structure and variability of the movements and to create rhythm models. It appeared that highly qualified basketball players have a considerable variety of rhythm in their jump shot phases. It appeared that the *main phase* of the whole activity was “*catching*”. The duration of the whole activity depends mostly on the duration of this phase ($r=0,79$). Large deviances from the optimum duration of phases have a negative impact on the rhythm of the whole activity and should be considered flaws of technique.

Based on the result we can **conclude** that setting a goal to reduce the length of jump shot basketball player should reduce the duration of the “*catching*” phase. The requirements developed in this study can be used for control, management and the correction of mistakes in the technical preparation of basketball players.

DIFFERENCES IN AEROBIC CAPACITY INDICATORS BETWEEN CROATIAN NATIONAL TEAM AND CLUB LEVEL VOLLEYBALL PLAYERS

Tomislav Đurković, Nenad Marelić and Tomica Rešetar

Faculty of Kinesiology, University of Zagreb, Croatia

Abstract

The aim of this study was to determine the possible significance of differences in the area of aerobic capacity among two groups of volleyball players. Laboratory measurements were performed on sixty-eight male subjects, all members of the A1 Croatian volleyball league who were divided into 2 groups. The first group consisted of higher level volleyball players ($n = 34$) with recent national team status who performed in qualification matches for the European or World Championship. The second group consisted of club level players who were members of clubs playing in the A1 Croatian league and who have not performed in national teams ($n = 34$). The aerobic capacity was estimated by the progressive maximal exercise test performed on a motor-driven treadmill. The following variables were studied: relative maximal oxygen uptake (VO_{2max} - $ml\ kg^{-1}\ min^{-1}$), relative maximal oxygen uptake at anaerobic threshold (VO_{2AT} - $ml\ kg^{-1}\ min^{-1}$), percentage of VO_{2max} at anaerobic threshold ($\%VO_{2max}$ - %), maximum speed before exhaustion (V_{max} - $km\ h^{-1}$) and speed of the treadmill at anaerobic threshold (V_{AT} - $km\ h^{-1}$). The group of national level volleyball players had numerically better results in all the measured variables and the T -test for independent groups showed a statistically significant difference ($p < 0.05$) in two of the five measured variables (V_{max} and V_{AT}), with large and moderate magnitudes which were observed in those two variables (Cohen's d 0.75 and 0.57). A player's participation in top clubs and national selections implies his exposure to an additional training volume, trainings of higher quality and intensity, which can ultimately have a positive effect on aerobic capacity indicators and certain neuromuscular adaptations of the lower extremities. Volleyball players with a higher level of aerobic capacity recover quickly between points and sets and they have the ability to delay fatigue, which can result in a better situational efficiency in long points, sets and matches. Players with better neuromuscular control and movement biomechanics can perform more efficiently during a volleyball match. Among other factors, this can be a possible reason for their selection in the national team.

Key words: volleyball, oxygen consumption, anaerobic threshold, biomechanics

THE SCORE DIFFERENCES BETWEEN ELITE EUROPEAN JUNIOR AND SENIOR WOMEN GYMNASTS

Tina Erceg, Sunčica Delaš Kalinski and Mirjana Milić

Faculty of Kinesiology, University of Split, Croatia

Artistic gymnastics is generally determined by the rules of the gymnastics Code of Points and long-term processes of learning gymnastics skills. Though intensive, the career of women gymnasts is relatively short, so with the goal of prolonging it the International Gymnastics Federation (FIG-a) prescribes easier dismounts for junior women gymnasts in relation to senior gymnasts. The aim of this study was to, by analysing the difficulty score (DS), execution score (ES), total score of each apparatus (TOTAL) and all-around final score (EP TOTAL), achieved at the 2012 European Championship (Brussels), determine the characteristics of junior exercises (N=88) and their differences in relation to senior exercises (N=85). The study results established significant differences between the samples in almost all the analysed scores.

NEW APPROACH IN COACHING AND METHODOLOGICAL PRACTICE

Zdeněk Janík

Faculty of Sport Studies, Masaryk University, Brno, Czech Republic

Objectives

The main goal is to present new possibilities and methods of diagnosing athletes' technique and performance used by the students of training during their coaching and methodological practice.

Methodology

In connection with the innovation of the course (Coaching and Methodological Practice) three up-to-date devices were implemented for diagnosing athletes' technique and performance. Dartfish software optically records the movement and thus provides the main characteristics (speed, acceleration, course, and trajectory). Polar Team 2 and Garmin concurrently give information about the current load of the monitored athletes based on their heart frequency. Coaching and Methodological Practice absolved 48 coaches. We evaluate most frequently mistakes and effectiveness of all devices above regarding optimization process.

Results

The implementation of the above-mentioned devices made possible to obtain relevant data on the current load and technical performance of movement in a training process of chosen sport fields. We analysed the most common technical mistakes in frame of selected exercise - developing up chest muscles (peck deck). We divided the exercise into four phases, the first phase - the launch, the second phase - the pull, the third phase - the detention, the fourth phase - return to starting position. Based on heart rate monitoring we found out that the most significant problem lies in the first phase of the exercise in which the proper angle of the shoulder joint is not kept. With the correct technique increased heart rate in the first phase of the exercise of 17%, which indirectly points to the increased effectiveness of exercise. The wrong technique was also shown in reaching lower load intensity.

Conclusion

The use of Dartfish software, Polar Team 2, and Garmin Forerunner 910XT in the course of Training and Methodology Practice met with positive reactions of the students, which supports our confidence that the devices will contribute to the optimization of the student's profile in the field of training at the Faculty of Sport Studies of Masaryk University and that they will be likewise more broadly used in training practice.

Key words: *Dartfish, Polar Team 2, Garmin, sport training, load*

ISOKINETIC MUSCLE STRENGTH, ASYMMETRY AND H:Q RATIO OF SOCCER PLAYERS ACCORDING TO PLAYING POSITION

Mikola Misjuk, Indrek Rannama and Ervin Kõll

Tallinn University, Estonia

Purpose: to compare isokinetic knee extensor (EXT) and flexor (FLX) muscles strength and strength balance patterns of soccer players in different playing positions.

Methods: 54 male soccer players of Estonian Premium League teams (age 22.6±4.7yrs, height 181.4±5.7cm, mass 76.0±8.6kg) participated in the study: 19 defenders (DEF), 20 midfielders (MF) and 15 forward players (FOR). Muscle strength was measured with an isokinetics dynamometer Humac Norm in the concentric (CON) actions at angular velocities 60, 180, 300°/s and in eccentric (ECC) actions at 60°/s. Isokinetic absolute (Nm) and relative (Nm/kg) peak torque (PT) of dominant (DOM) and non-dominant (N-DOM) leg, muscle groups contralateral deficit values and H:Q ratios were compared between DEF, MF and FOR.

Results: DEF had significantly ($p < 0.05$) higher EXT absolute PT in all CON testing speeds and FLX PT at CON-60°/s compared to MF. FOR had higher EXT PT compared to MF in N-DOM side at CON-60°/s and ECC-60°/s, in the DOM side at CON-180°/s, CON-300°/s and ECC-60°/s. No differences in absolute PT between DEF and FOR and in relative PT between all groups were found. MF show significantly lower FLX deficit values (7.1±5.2) in CON-300°/s than DEF (12.7±10.2) and FOR (12.1±7.8), no other differences were found. DEF players had significantly stronger DOM leg FLX at ECC-60°/s and FOR players stronger DOM leg EXT at CON-300°/s and FLX at CON-180°/s. No other significant one side directional asymmetry was found. The H:Q ratio of DEF was significantly higher than in FOR in N-DOM side at CON-60°/s and significantly lower than in MF in DOM leg at CON-180°/s. No differences between body sides in, H:Q ratios were found at CON-300°/s in any group, DEF had significantly higher ratios in the DOM side at ECC-60°/s, but no differences in CON speeds. MF and FOR had higher H:Q ratios of DOM side at CON-180°/s and CON-300°/s, also FOR had higher DOM side ratios at ECC-60°/s.

Conclusions: There were found some playing position specific differences in isokinetic knee extensors and flexors muscular strength and strength balance patterns of soccer players.

Key words: isokinetic strength, soccer, playing position

CLIFF DIVING: EVALUATION OF THE IMPACT WITH THE WATER AND PERFORMANCE ANALYSIS

Salvatore Napolitano, Daniela Tursi and Domenico Tafuri

University of Naples “Parthenope” – Department Physical Education and wellness

This work focuses on two specific aspects of the High diving: 1) the impact with water: in high diving competitions the platforms are located at a height between 25 and 28 meters. The impact with the water exposes muscles, articulations and the whole athlete body to abnormal solicitations; 2) the lack of opportunities for athletes to train in an environment similar to that in which the performance occurs: divers can practice only on the day before the competition; they can't practice on a daily basis.

The aim of this study is to develop a training methodology that takes into account these two peculiar difficulties and, on a scientific basis, looks for methodological and technological supports.

The approach of research is integrated and composed by two distinct methods: 1) With regard to the influence of impact with the water, the coefficient of impact was calculated using pre-existing data in scientific literature, by reference to studies, conducted in the aeronautical field, concerning the impact of the water on the objects. The human body has been simulated by a cylinder with a mass of 80 Kg and 1,71 m height. Velocity in based on a free fall and has been calculated as $v=\sqrt{2*g*h}$, without considering drag effects; 2) With regard to the technical side, three international competitions have been studied using video analysis methodology: 2 events related

Aim of video analysis was to analyze the various segments of technical execution of each single dive executed by the athlete during the competition in order to better prepare and individualize the strengths and weaknesses of the athlete in each single execution. As is easily understood, the diver's body, even for a short time, is subject to a notable stimuli. With a 28m diving height, the results show a maximum force of about 24236 [N] during $dt = 0,001s$ from and with a 1,5m penetration body under water line. Based on the results, it is possible to develop a model that, given height, weight and anthropometric values. A so constructed model may help athletes to develop a type of training that protects privileged way in the body segments most vulnerable to and including and prevent the consequences of any errors.

Key words: *training methodology, videoanalysis, biomechanics, diver*

RELATIONSHIP BETWEEN ISOKINETIC MUSCLE STRENGTH AND KINEMATICS OF SPRINT CYCLING

Indrek Rannama, Kristjan Port and Boris Bazanov

Institute of Health Sciences and Sport, Tallinn University, Estonia

Purpose

To examine the relationship between maximal isokinetic local muscle strength and cycling sprinting kinematic patterns of three lower limb joints.

Methods

The 3D kinematics of 16 competitive road cyclists (20.0±3.9 yrs., 181.5±4.9 cm, 74.8±6.9 kg) were recorded during 10 sec isokinetic maximum power test with cadence 120 RPM in sitting position on a Cyclus2 Ergometer. The kinematic patterns of the ankle, knee and hip joint extension (EX) and flexion (FL) was described by the angular position (AP), velocity (AV) and acceleration (AA) values. Also isokinetic peak torque (PT) and average power (PW) of ankle plantar (PF) and dorsal flexion (DF), knee and hip EX and FL were measured with a Humac NORM isokinetic dynamometer at angular speeds 60, 180 and 240°/sec. The correlations analyze between cycling kinematics and isokinetic relative PT (Nm/kg) and PW (W/kg) parameters of ankle, knee and hip joints were performed. Left and right leg values were included into the analysis (n=32).

Results

No strong ($r > |0.7|$) correlations between kinematics and joint torque parameters were found, but there were many significant ($p < 0.05$) low ($r = |0.35| - |0.49|$) and moderate ($r = |0.5| - |0.69|$) correlations. The PT and PW of hip FL was positively related with AA of ankle PF and DF. The higher PT and PW of hip FL associated with more flexed knee AP and lowered knee and hip AP amplitudes. Inversely hip and knee EX PT and PW were related to more extended AP and larger AP amplitude in knee and hip joint and higher knee EX AA. Ankle DF PT correlated positively with ankle AP amplitude and average AP, PF AP and peak DF AA. Ankle PF PT at 240°/sec correlated weakly with ankle PF AA. Knee FL PT at 60°/sec had weak positive correlations with an AA of knee EX and FL and hip FL.

Conclusion

The sprint cycling kinematics had most relations with hip muscles isokinetic performance. Individuals with enhanced hip FL muscular strength had more impulsive ankle movement and less movement amplitude in hip and knee joint. Inversely hip and knee EX strength associated with larger extension and movement amplitude of knee and hip joints.

CLASSIFICATION OF JUDO THROWING TECHNIQUES ACCORDING TO THEIR IMPORTANCE IN JUDO BOUT

Ivan Segedi and Hrvoje Sertić

Faculty of Kinesiology, University of Zagreb, Croatia

Analysis of judo throwing techniques, as the most important attacking elements in the judo bout, can help experts in training process. The aim of this paper is to analyse and classify throwing techniques from the aspect of their importance in the bout. For the purpose of this research expert assessment, of the importance of forty throwing techniques (entities) in fifteen variables (characteristics) of judo bout, was made. Cluster analysis identified two main groups of throws (group A and group B). Group A is divided into four sub-groups which contain the most important and the most applicable throws in modern judo bout. Group B is divided into two sub-groups that represent less important throwing techniques. The results of this research can be useful to judo experts in selecting the most rational methods of the technical and tactical preparation and in establishment of new and modern approaches in judo training.

Key words: *weight category, movement of opponent, age groups, cluster analysis, applicability*

A COMPARISON OF ANAEROBIC ENDURANCE CAPACITY IN ELITE SOCCER, HANDBALL AND BASKETBALL PLAYERS

Goran Sporiš¹, Vlatko Vučetić¹, Luka Milanović¹, Zoran Milanović² and Marino Krespi³

¹Faculty of Kinesiology, University of Zagreb

²Faculty of Sport and Physical Education, University of Niš

³Faculty of Kinesiology, University of Split

Abstract

The aim of the study was to determine whether there was a difference in anaerobic endurance between soccer, handball and basketball players. One hundred fifty players (mean age: 22.35±4.31 years), 50 from each sport (mean age: soccer, handball, basketball players 23.54±4.19, 20.42±4.48, 23.10±3.63 years, respectively), were members of the highest level of their sport in Croatia; some were representatives of their national team. Participants undertook a 300 yard shuttle run test (300Y) and a maximal blood lactate test (BL). Results showed that there were significant differences in both 300Y and BL tests between the soccer, handball and basketball players. Basketball players (57.04±3.41sec) achieved the best results in the 300Y test followed by soccer (57.06±2.27 sec) and then handball players (59.53±2.65 sec). Post hoc tests indicated that soccer players (14.70±2.07) had significantly ($p<0.05$) higher maximal lactate (BL) than handball players (13.70±1.83). It is not possible to say that these three sports require equal levels of anaerobic endurance but it is certainly an important component of performance in all of them. Comparing team sports such as handball, basketball and soccer we were concluded that their anaerobic abilities are different, which means that the sport-specific demands could influence on athletes anaerobic capacity.

Key words: soccer, handball, basketball, lactate, 300 yard shuttle

RELATIVE AGE EFFECT IN ELITE SOUTH AFRICAN CRICKETERS

Richard Stretch

Nelson Mandela Metropolitan University, South Africa

The relative age effect (RAE) has been widely observed in a number of sports as a result of annual age-grouping policies in youth sport. This study aimed to identify the existence of RAE among elite senior South African cricket players.

The birth-date distribution (January to March (Q1), April to June (Q2), July to September (Q3), October to December (Q4)) of all players ($n = 1\,576$) who had played representative cricket for South Africa at Test, limited-overs and age-group (Under 19) level and at provincial first-class level (franchise, provincial or bowl) since the 1991-1992 season, were collected from the Cricket South Africa database.

The data revealed that there was no significant RAE for the cricketers. However, there was a descriptive trend showing more players were born at the start of the new academic school-year which coincided with the first quartile for each age-group category ($Q1 = 27\%$). The quartile just prior to the start of the new cricket season ($Q3 = 26\%$) showed the second largest birth-date distribution. When the players were divided into their role in the team, the batsman showed a RAE ($\text{Chi}^2(\text{d.f.} = 3, n = 518) = 10.02; p = .018$) in Q1 (30%), with the bowlers showed a non-significant increase in Q1 (28%). The left handed batsmen recorded greater birth-date distributions in Q1 (29%) than the other quartiles, while the players who had played at International level ($n = 125$) showed a non-significant greater birth-rate distribution in Q1 (33%) than the provincial players ($N = 1\,451$) ($Q = 26\%$).

No RAE for the cricketers was evident, but a descriptive trend to more players being born at the start of the school academic year (Q1) and then again the months prior to the start of the new cricket season (Q3) was found.



Management of Sport

**7th INTERNATIONAL
SCIENTIFIC
CONFERENCE ON
KINESIOLOGY**

**FUNDAMENTAL
AND APPLIED
KINESIOLOGY – STEPS
FORWARD**

Editors:

**Prof. Mato Bartoluci, PhD
Sanela Škorić, PhD**

Peer Reviewers:

**Prof. Mato Bartoluci, PhD
Prof. Jurica Pavičić, PhD
Andrea Pešutić, PhD
Prof. Helga Maškarin Ribarić, PhD
Prof. Claude Sobry, PhD**



THE IMPACT OF THE GLOBAL ECONOMIC CRISIS ON THE FINANCES IN SPORT: CASE OF SLOVENIA

Gregor Jurak¹, Stevo Popović², Damjan Jakšič³, Edvard Kolar⁴, Wladimir Andreff⁵ and Jakob Bednarik¹

¹University of Ljubljana, Faculty of Sport, Ljubljana, Slovenia

²University of Montenegro, Faculty for Sport and Physical Education, Nikšić, Montenegro

³University of Novi Sad, Faculty of Sport and Physical Education, Novi Sad, Serbia

⁴University of Primorska, Faculty of Mathematics, Natural Sciences and Information Technologies, Koper, Slovenia

⁵University Paris 1, Pantheon Sorbonne, Centre d'Economie de la Sorbonne, Paris, France

Abstract

The financial market turmoil in 2007 and 2008 has led to the severe financial crisis and threatens to have severe repercussions on the real economy. The sport industry could not remain unaffected by these circumstances. This paper examines the impact of the global economic crisis on revenues of non-governmental sport organisations (sport NGOs) in Slovenia, as a small European economy. The operating revenues (sales revenues, public revenues, membership fees, donations, other operating revenues) of all sport NGOs from 2007 to 2012 have been analysed. We found that the overall trend of sport NGOs revenues correspond with few years of delay to the trends of the Slovenian economy. Until 2010 the impact of crises in Slovenia was relatively small and diverse regarding the different financial design types of sport NGOs. The greatest financial impacts were experienced in grassroots sport, while professional sport NGOs have increased their operating revenues, mostly due to increases of public revenues. In 2012 total revenues of all sport NGOs decreased first time in last 10 years. Stagnation in this period is most visible in professional sport NGOs due to around 8% decrease of public and sales revenues. The findings suggest that the true impact of the recession on Slovenian sport NGOs remains to be seen. We conclude that the ongoing recession will affect grassroots sport the least, while semi-professional and professional sport NGOs will be under financial threat. Because of the synergistic effects of different types of NGOs, this could affect the sustainability of Slovenian sport.

Key words: *grassroots sport, professional sport, sport club, sport federation, financial distress, recession, revenue, financial statement*

Introduction

An overview of the globalisation of the sport economy (M. Andreff & Andreff, 2009; W. Andreff, 2008) confirms the main hypothesis of this study: the sport industry could not remain unaffected by global economic crisis. Sport organisations have different organisational forms, operating methods, goals, and institutional characteristics than those in other sectors of the economy, so there is good reason to expect them to react differently to economic and financial downturns (Humphreys, 2010). Therefore, the global financial crisis presents significant challenges for the growth of the sport industry, representing a serious setback, because it is taking place at a time the sport business had begun to progress in economic performance.

Slovenia is a small open economy within the EU, with two million inhabitants and €35,416 million of gross domestic product (GDP; SORS, 2011). Affected by the global crisis, Slovenian GDP fell by close to 8% in 2009, among the deepest declines in the OECD (OECD, 2011); GDP grew modestly by 1.2% in 2010 and by 0.6% in 2011, but fell again by 2.5% in 2012 (Eurostat, 2012). In August 2012, the three main ratings agencies all downgraded Slovenian sovereign debt as investors' voiced concerns that Slovenia would require a bailout. If Slovenia rebalances its economy and restores competitiveness, its macro-economic performance should improve in coming years, but the improvement will most likely be smaller than the deterioration in the past period; real growth is expected in several years. According to aforementioned, this paper aims to represent the likely impact of the global financial crisis on the finances of non-governmental sport organisations (sport NGOs) in Slovenia and to assess the extent to which that influence is reflected in certain groups of sport NGOs.

The Slovenian Sport Financial Information

The Slovenian sport services market has been monitored for more than fifteen years with the approach taken by Andreff and his colleagues (W. Andreff, Bourg, & Halba, 1994); therefore, high quality population data was used for this study. The survey examined operating revenues among 6,246 sport NGOs in Slovenia (sport clubs and associations)

that provided annual income statements for each year from 2007 to 2010. The data in this study has been obtained at the request of the authors, using annual financial reports from the Agency for Public Legal Records and Services in the Republic of Slovenia.

To obtain a more comprehensive insight, operating revenues were analysed according to different types of sport NGOs. For this purpose, sport NGOs were divided into three groups of financial design types, according to a cluster analysis using Ward’s hierarchical fusion algorithm clustering technique on 10 primary financial variables from the financial statements of sport NGOs: grassroots sport organisations, semi-professional and professional sport NGOs (Bednarik et al., 2013).

Structure of Operating Revenues of Slovenian sport NGOs

The overall operating revenues of Slovenian sport NGOs rose by 9.6% from 2007 to 2012 and reached €218.279 million. In the absolute sense, these revenues are, for instance, equal to the budget of the Italian Football club Juventus (Deloitte, 2010), which is indicative of the financial strength of Slovenian NGOs. However, many of the accomplishments of Slovenian sport (Bednarik, et al., 2013) have been achieved with these limited finances. This leads to an assumption of the relative superior efficiency of the Slovenian model of sport. The different types of sport NGOs play an influential role in this model.

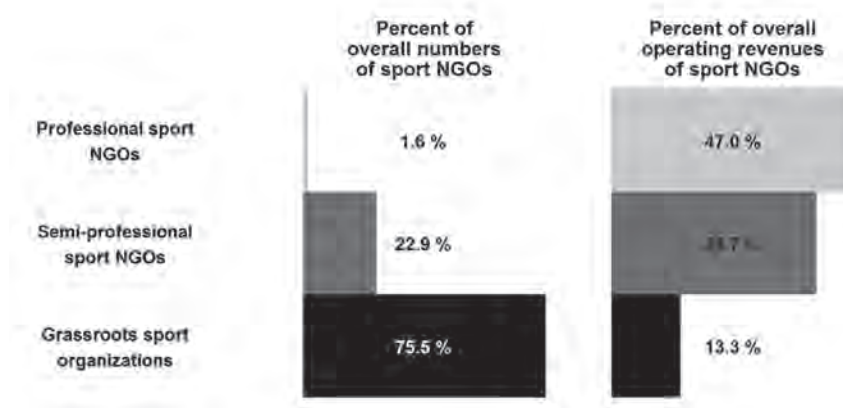

Figure 1: Share in overall operating revenues by three groups of sport NGOs (Bednarik, et al., 2013)

The impact of professional and semi-professional sport NGOs is much higher than their share in the total number of sport NGOs (Figure 1). The operating revenues differ between groups of sport NGOs in level as well as in their structure (see Figure 2).

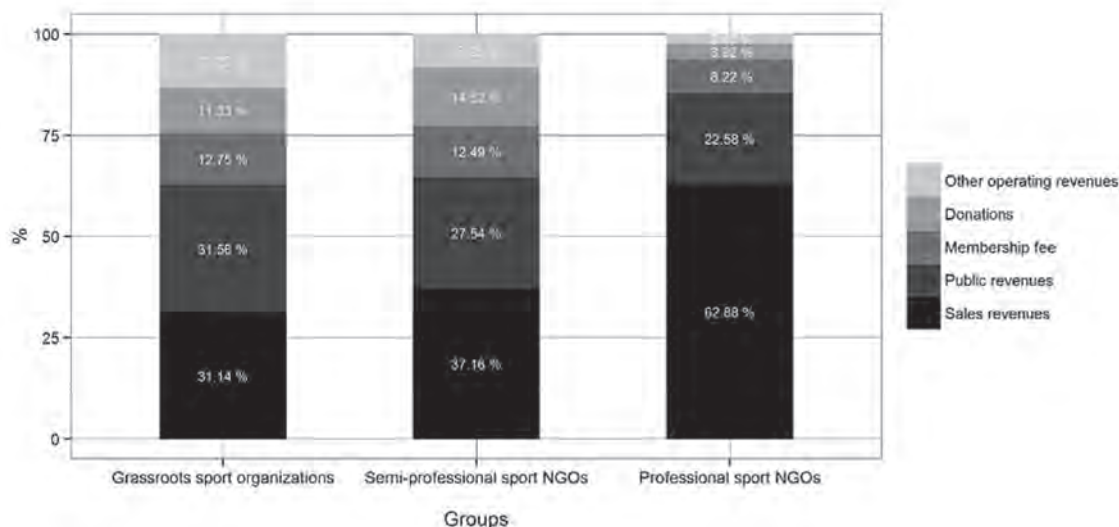

Figure 2: Structure of operating revenues in year 2010 by three groups of sport NGOs (Bednarik, et al., 2013)

Impact of the Recession on Operating Revenues of Slovenian Sport NGOs

The comparison of operating revenues in the 2007–2012 period shows that sport NGOs in Slovenia have increased their overall operating revenues in comparison with the revenues before the global economic crisis started. Therefore, in spite of the crisis, until the year 2011 the operating revenues of sport NGOs have continuously grown over the previous 10 years (Bednarik, Kolar, & Jurak, 2010; Jurak, Bednarik, Kolenc, & Kolar, 2010). Just moderate stagnation has been observed in 2012. This does not correspond exactly to the trends of Slovenian economy in the 2007–2012 period (OECD, 2011). A more detailed analysis reveals important differences in operating revenues regarding the three groups of sport NGOs and explains revenue fluctuations.

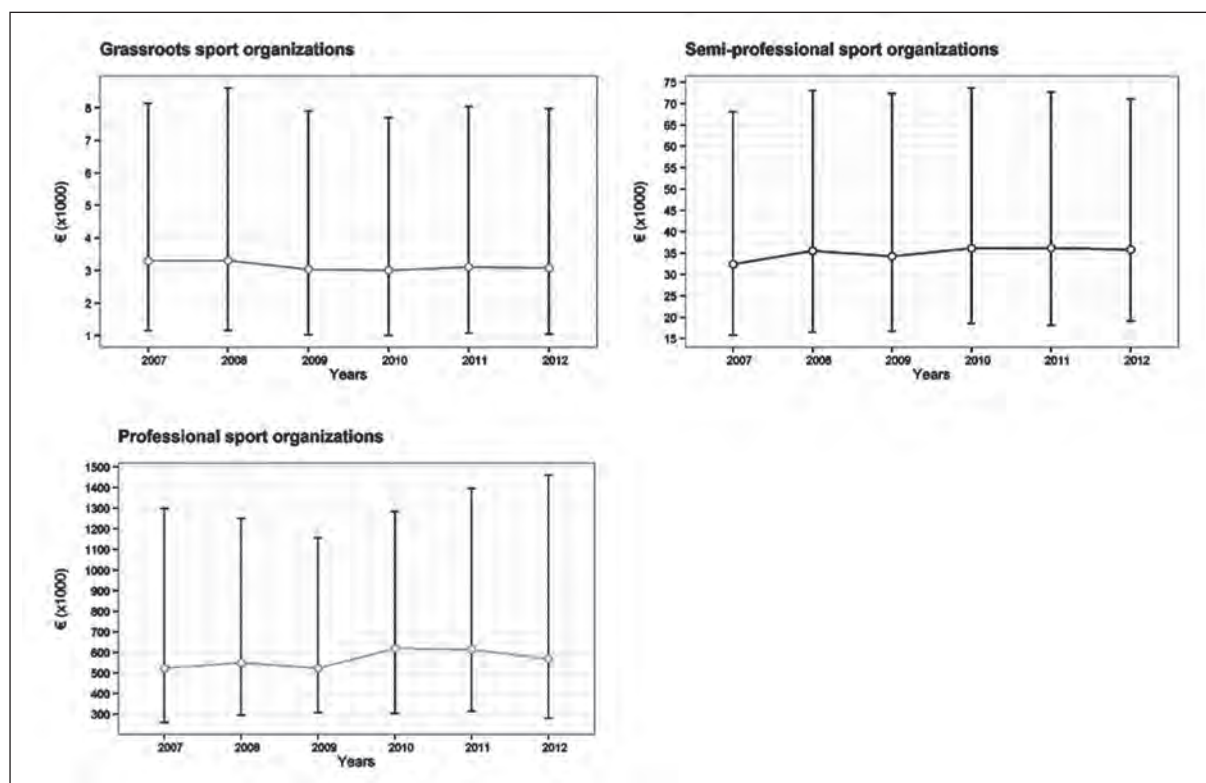

Figure 3: Trend lines of medians and interquartile range of total operating revenues of three different types of sport NGOs

Trends of the impact of the crisis on total operating revenues three different financial design types of sport NGOs are presented in Figure 3. For better insight the trend has been analysed with Wilcoxon signed rank test separately for the period 2007-2010 and 2010-2012.

In period 2007-2010 in semi-professional and professional sport NGOs the majority of operating revenues are significantly higher in 2010 than in 2007. The upward trend of operating revenues in the observed period was noted as being the greatest in group of professional sport NGOs. Their total operating revenues increased by 18%, mostly because of increases of public revenues in 2009 and 2010. A positive trend was also observed in semi-professional sport NGOs, which managed to maintain this trend with higher levels of all operating revenues. In contrast, in grassroots sport only public revenues were significantly higher in this period; consequently, their total operating revenues decreased in period 2009-2010 (Jurak, Andreff, Popović, Jakšić, & Bednarik, 2013).

In period 2010-2012 some changes in trend have been observed. In all groups of sport NGOs the total operating revenues and the majority of operating revenues are not significantly different. Stagnation in this period is most visible in professional sport NGOs (see Figure 3). To explain trends, one should understand the meaning of certain types of operating revenues in the observed sport organisations.

In grassroots sport organisations, sales revenues are represented mostly by fees for exercise programmes and sport courses, but in professional sport NGOs most sales revenues are generated by sponsorship, ticket revenues, trade of athletes and media rights, while in semi-professional sport NGOs they are mixed. Similar structures of revenues of grassroots sport (Waelbroeck-Rocha et al., 2011) and professional sport (Deloitte, 2013) have been found in other studies. Therefore, sales revenues in grassroots sport organisations are more influenced by household expenditure and their purchasing power. Purchasing power parity in Slovenia dropped in the 2008–2010 period by 8.3% (Eurostat, 2012) and then remains in this level until 2012, which is in line with the stagnation of operating revenues in grassroots sport.

However, sales revenues of professional sport NGOs are more influenced by the interests of enterprises and their capability for financing of sport and their marketing activities. In contrast to some bigger sport economies, the Slovenian sport sponsorship market has been characterised by social networks (Jurak, Bednarik, & Kovač, 2009). The management of enterprises considers sport sponsorship to be a social vehicle for introducing the company name into the media or for creating new acquaintances with other sponsors/business partners and politicians at sport events, thus widening the network of their business/social connections. The biggest sport clubs and the biggest national sport federations have been mainly sponsored by government-owned enterprises. Sponsors from abroad are very rare. Therefore, it can be assumed that professional sport NGOs expanded their sponsorship revenues more on the basis of socio-political than marketing interests. Since the size of Slovenian market is two million people and the fact that the sales of media rights in other countries are not large due to a lack of interest in Slovenian competitions, there is also limited potential for sponsors and advertisers for the broadcasting of sport events. During the economic crisis, one possible strategy for existing sponsors is changing their priorities in favour of the most media-exposed sports, athletes, clubs and events. We do not have separate data for sponsorship revenues and are thus unable to analyse this problem more thoroughly. However, since sales revenues of professional sport NGOs did not change in the 2007–2010 and 2010–2012 periods, we assume redistribution of sponsorship revenues within professional sport NGOs is occurring.

Public revenues are represented by subsidies and grants at national, regional or local levels. In Slovenia, about 75% of public revenues comes from local authorities (Jurak, et al., 2010), which is main source of public finances of grassroots sport. Government finances are concentrated on national sport federations. Therefore, the large increase of public revenues in professional sport NGOs in period 2009–2011 is mostly a consequence of much higher financing of sport federations on the government level caused by political decisions and some change of criteria that were initiated by national sport federations at the start of the global financial crises. However, public revenues of this type of sport NGOs in 2012 indicate on opposite trend of these revenues in future.

A donation in context of revenues of sport NGOs is revenue given by individuals or legal entities for sport organisation activities without an expectation of a commercial return (unlike sponsorship). Moreover, these are payments made by the sport federations to the clubs for some of their programmes. Therefore, it is logical that donations represent more important revenues in grassroots sport organisations than in professional sport NGOs (Jurak, et al., 2013). With the beginning of the global economic crisis, donations have been decreased particularly in grassroots sport, so much so that the median has fallen for 75%.

A membership fee is charged as part of being an NGO's member. In return, the member has membership rights (access to sport facilities and programs, candidature for NGO' bodies, voting etc.). In the structure of finances, membership fees represent highly significant revenue in grassroots sport organisations and semi-professional sport NGOs, but less important revenue in professional sport NGOs (Bednarik, et al., 2013). In period 2007–2010 trend of decreasing revenues from membership fees can be observed in grassroots sport and professional sport NGOs, while an increasing trend in semi-professional sport NGOs was present (Jurak, et al., 2013). In period 2010–2010 membership fees in grassroots sport have increased, while a decreasing trend prevailed in semi-professional and professional sport NGOs.

The trend of the operating revenues of sport NGOs reflects the economic situation in Slovenia in the observed period with few years delay. However, the OECD (2012) has predicted reductions of Slovenian GDP by 1.1% in 2013, so the Slovenian economy is currently faced with risks of prolonged stagnation. Rising fiscal deficits and public debt have already required stabilisation (austerity) policies in Slovenia. Despite a recent paper by IMF economists **Blanchard** and **Leigh** (2013) criticizing policies of slashing budgets too rapidly early in the euro crisis, starving many economies of much-needed growth, the Slovenian government is determined to take this route. Along with the strained economic situation and its reflection on sport finances, we believe this would greatly affect the finances of Slovenian sport, but differently according to type of sport NGO.

It seems that grassroots sport organisations will suffer the least in these new circumstances, as they have the most balanced structure of revenues, a stable trend of revenues and a structure of expenses that enables the easiest adjustments (Bednarik, et al., 2013). In this group, a severe decline of all revenues, with exception of membership fees can be expected, as these organisations are mostly fulfilling interests of small number of members, who will continue to pay the fees at the same level. A gradual slightly negative trend of revenues of these organisations has already been observed in recent years; therefore, an additional decrease will not represent major disruptions for these organisations. Supporting this statement are the facts that these organisations generally do not have problems with liquidity and solvency, and they can very quickly adjust their expenditure with the revenues, as their budgets include only a small proportion of fixed costs, such as the salaries of employees (Bednarik, et al., 2013).

Semi-professional sport NGOs will experience larger financial difficulties. They are mostly dependant on the revenues from households (membership fees, training fees and entrance tickets), as their programmes are particularly aimed at these groups. Smaller purchasing power, more difficult business conditions and austerity measures in public finances will result in decreases of all revenues of these organisations. As these sport NGOs have more fixed costs (employees) in their budgets than the grassroots sport organisations do, they will also have more difficulties in adjusting their expenditure to the decrease in revenues.

The largest problems can be expected in professional sport NGOs. These organisations depend on sales revenues the most and are thus greatly influenced by the economic situation; at the same time, they experienced a considerably unstable positive trend in revenues from the public funds at the start of recession. Due to limitations in data collection, a more thorough analysis of sales revenues regarding the different types of these revenues (sponsorship, media rights, ticket sales, players' trade etc.) is impossible. Some information about changes of the structure of these revenues from business reports of certain professional sport NGOs indicates a rapid fall of sponsorship revenues in 2011 and 2012. Excessive emphasis on sponsorship revenues can therefore represent a threat for these organisations.

Significantly increased public financing of professional sport NGOs in 2009-2012 has caused so-called financial doping. In these years, the programmes of national sport governing bodies have experienced particularly large financing from the government funds, which resulted in increased expenditure. It can be assumed that (with a few exceptions) these sport NGOs did not adjust their business models to changed circumstances in the economic market due to experiencing total positive trend of business income. As a result, in coming years these sport NGOs will be ill-prepared for changes, as the public financing of their programmes will sharply decline. This decline will also correspond with a decline in sponsorship revenues, which represents an important part of their sales revenues. If these organisations wish to balance their expenditures with revenues, they will quickly have to enact considerable cuts in salary expenses and/or dismiss their staff. Nevertheless, it is more likely that they will merely postpone the payments and prolong the agony. This will be particularly true for sport clubs in professional competitive sport, where the costs of professional teams represent more than half of all the budget expenses. Even larger problems will be experienced by the NGOs, which are highly leveraged and have intense liquidity and solvency problems. According to findings of Bednarik et al. (2013), 35% of professional sport NGOs are operating under net losses from previous years.

The opinion of the authors of this paper is that the sport NGO sector in Slovenia will be faced with de-professionalisation, which had already been predicted prior to the beginning of the crisis (Jurak, 2006). This process will strongly affect many semi-professional and professional sport NGOs. At the moment, these two groups employ significant numbers of university-educated coaching staff, supported through the system of public financing and enabling them stable running. Austerity measures will also affect such financing, and without suitable business solutions these sport NGOs will not be able to finance the employees from other sources. Consequently, unpaid bills, dismissals and staff resignations will follow, resulting in destabilisation of functioning of the sport NGOs.

In professional sport NGOs, the consequences will be even greater, because they employ more professional staff. A demise of some professional teams and their return to amateur status can be expected. Our analysis has shown that three professional sport NGOs (representing 4% of sport NGOs in these group) already closed their business in year 2011. Only professional sport NGOs with proper business strategies regarding their resources (sport facilities, media attention, people involved, etc.) can survive the recession with the same model as before crisis. Generally speaking, their business models better resemble the functioning of business companies rather than that of NGOs. Some sport NGOs have already set up such models; however, time will tell how successful they are. For example, the Slovenian skiing association has transferred the majority of the financial burden of the national teams onto the competitors and their families. Maribor Football Club has changed its income structure, with a significant increase of revenues from the transfers of players.

The next important question is when it can be expected that the status of operational revenues in semi-professional and professional sport NGOs will again reach the level prior to the economic crisis? It seems such a recovery will take some time and will happen only if these sport NGOs will change their business models. To be clear: the current models are obsolete. This will be most apparent with regard to one of the larger sources of revenue in these organisations, i.e. sponsorship, as the sponsorship market in Slovenia will never be return to the state it was before the economic crisis. The model of sponsorship in Slovenian sport has been based on social-political connections with mainly state-owned companies; recently passed legislation on the Slovenian Sovereign Holding will result in a sale of state shares in a large number of these companies. As a result, the withdrawal of the state from the economy will presumably result in more deliberate decisions of companies for sponsoring of all types of activities, including sport. Marketing interest in particular sports will become particularly important, which will enable companies to fulfil their marketing goals. If Slovenian and perhaps even foreign companies will recognise Slovenian sport as a tool for fulfilling their marketing goals, then the Slovenian sport could, as a result of global trends (IEG, 2013), increase sponsorship revenues; otherwise, the money will be directed elsewhere.

A considerable threat to the stability of the future functioning of semi-professional and professional sport NGOs will also be the dependency on public finances, particularly in national governing bodies. Specifically, the majority of them are already excessively dependent on state resources (Jurak, et al., 2010).

Measures for Sport NGOs to Address the Prolonged Recession

The similarity of economic trends and finances of sport NGOs with some delay pattern suggests that Slovenian sport is not recession-resistant. According to the economic forecast and socio-political circumstances in Slovenia, we believe the true measure of economic turmoil will be seen over next few years. It is vital for Slovenian sport NGOs to survive recession, not merely for this sector itself, but also because of its impact on public health and economic growth.

We believe that grassroots sport will survive the financial crisis almost unchanged in its way of business. However, it is very important for the sustainability of Slovenian sport as whole to keep different types of sport NGOs well-functioning, because of their synergistic effects on Slovenian sport success. Therefore, it is crucial for semi-professional and professional sport NGOs to be better equipped to deal with recession. Each sport NGO must find each own combination of measures regarding to their resources and opportunities.

One possible course is to enhance domestic expenditure for sport by raising the revenues generated from households, combined with the more efficient exploration of given resources within Slovenian sport. Raising the household expenditure for sport services implies many measures (see Waelbroeck-Rocha, et al., 2011), which require the development of sport NGOs' services for existing and new target groups of consumers. However, for high level and professional sport organisations, identification with the sport organisation seems to be the ultimate key. When it comes to the internal market of sport, strategic partnerships between sport organisations must be mentioned. Instead of focusing on yields alone, professional and high level sport organisations could be based on a special combination of competition interest and sport responsibility, which is grounded in utilising the synergies that exist between sport clubs within the same sport discipline. Only few sport clubs in Slovenia complete in high-level commercial sport competitions, have a brand that attracts major sponsors and modern sport facilities. These organisations could make a network of partnerships with domestic sport clubs to help them organise youth teams (with professional support, management, sport facilities and premises), train talents and then fairly trade for them. This could share limited finances with all partners.

Regardless, semi-professional and professional sport NGOs should also perform cost-saving measures, requiring these NGOs to prepare a specific action plan in order to best exploit the opportunities available. The highest expenditures of these sport NGOs are for costs of services (Bednarik, et al., 2013), among which are contract personnel payments, leasing sport facilities and various charges for competitions. Reductions of personnel payments should be achieved mostly through the reviewing of player salaries, and less by lay-offs of permanent professional staff, who are capable of providing sport services of high quality. New, more economically realistic and sustainable bases of payments should be set. Regarding charges for sport premises, new contract terms with local communities (which are mainly their owners) should be made. Cost reductions in the competition system should be designed together with sport federation and other sport clubs, with possible measures as fewer games/competitions performed, rules adaptations in minor leagues to avoid some costs (e.g. few referees, shortening of competition time) and reduction of work and cost of competition bureaucracy. National sport federations could reduce the costs of national teams by carrying out all of the sport training programmes in suitable sport facilities in Slovenia.

References

1. Andreff, M., & Andreff, W. (2009). Global Trade in Sports Goods: International Specialisation of Major Trading Countries. *European Sport Management Quarterly*, 9(3), 259-294.
2. Andreff, W. (2008). Globalization of the Sports Economy. *Rivista di Diritto ed Economia dello Sport*, 4(3), 13-32.
3. Andreff, W., Bourg, J.-F., & Halba, B. (1994). *The economic importance of sport in Europe: financing and economic impact*. Brussels: Committee for Development of Sport of the Council of Europe.
4. Bednarik, J., Andreff, W., Popović, S., Jakšič, D., Kolar, E., & Jurak, G. (2013). Financial taxonomy of non-governmental sports organizations. *Kinesiology*, 45(2), 241-251.
5. Bednarik, J., Kolar, E., & Jurak, G. (2010). Analysis of the sports services market in Slovenia. *Kinesiology*, 42(2), 142-152.
6. Blanchard, O., & Leigh, D. (2013, April 5 2013). Growth Forecast Errors and Fiscal Multipliers. IMF Working Paper. Retrieved April 5, 2013, from <http://www.imf.org/external/pubs/ft/wp/2013/wp1301.pdf>
7. Deloitte. (2010). Football Money League 2010. Retrieved December 14, 2012, from http://www.deloitte.com/assets/Dcom-Ecuador/Local%20Assets/Documents/Estudios/100412-ec_DeloitteFML2010.pdf
8. Deloitte. (2013). Football Money League 2013. Retrieved April 5, 2013, from http://www.deloitte.com/view/en_GB/uk/industries/sportsbusinessgroup/sports/football/deloitte-football-money-league/
9. Eurostat. (2012). National accounts Available from http://epp.eurostat.ec.europa.eu/portal/page/portal/national_accounts/introduction
10. Humphreys, B. (2010). The Impact of the Global Financial Crisis on Sport in North America. Optimal strategies in sports economics and management. In S. Butenko, J. Gil-Lafuente & P. Pardalos (Eds.), *Optimal Strategies in Sports Economics and Management* (pp. 39-57). Berlin Heidelberg: Springer.
11. IEG. (2013). 2013 sponsorship outlook: spending increase is double-edged sword Available from <http://www.sponsorship.com/IEGSR/2013/01/07/2013-Sponsorship-Outlook--Spending-Increase-Is-Dou.aspx>
12. Jurak, G. (2006). *Značilnosti vodenja prostovoljcev v športnih organizacijah v Sloveniji [The characteristics of the leadership of volunteers in Slovenian sports organizations]*. Unpublished master's thesis, University of Ljubljana, Ljubljana.
13. Jurak, G., Andreff, W., Popović, S., Jakšič, D., & Bednarik, J. (2013). Impact of the global economic crisis on the finances of non-governmental sport organizations in Slovenia remains to be seen. University of Ljubljana, Faculty of Sport.

14. Jurak, G., Bednarik, J., Kolenc, M., & Kolar, E. (2010). Analiza ekonomskih učinkov športa v Republiki Sloveniji. In E. Kolar, G. Jurak & M. Kovač (Eds.), *Analiza nacionalnega programa športa v Republiki Sloveniji 2000-2010 [Analyses of national programme of sport in Republic of Slovenia 2000-2010. In Slovenian]* (pp. 61-82). Ljubljana: Faculty of Sport.
15. Jurak, G., Bednarik, J., & Kovač, M. (2009). The sponsorship potential of Slovenian sport *Acta Universitatis Carolinae. Kinanthropologica*, 45(1), 95-113.
16. OECD. (2011). *OECD Economic Surveys Slovenia*. Paris: Economic and Development Review Committee of the OECD.
17. OECD. (2012). *Economic outlook, analysis and forecasts. Slovenia - Economic forecast summary (November 2012)*. Paris: Economic and Development Review Committee of the OECD.
18. SORS. (2011). Slovenia in Figures 2011 Available from http://www.stat.si/doc/pub/slo_figures_11.pdf
19. Waelbroeck-Rocha, E., Avice, E., Nguyen, T. A., Mirgon, C., Lourimi, S., Mialet, G., et al. (2011). *Study on the funding of grassroots sports in the EU. With a focus on the internal market aspects concerning legislative frameworks and systems of financing*. Brussels: Eurostrategies.

SPORT MANAGEMENT AS AN INTEGRAL PART OF KINANTHROPOLOGY

Jana Nová

Faculty of Sports Science, Masaryk University, Brno, Czech Republic

Abstract

This theoretical paper is touching the problem related to the nature and identity of sport management discipline and its appropriate integration into the structure of the scientific disciplines. In the paper the position of sport management within the kinanthropology is examined and clarified. In the quest to justify the position of the sport management within the kinanthropology, the body of the knowledge, subject of the study, methodology and vocabulary are discussed from the perspective of the historical development. The content analysis and philosophical as well as disciplinary approach are used as a primary research method in order to identify the links between the kinanthropology as the scientific discipline and sport management as its sub discipline.

Key words: subject of study, body of knowledge, scientific discipline, research methodology, paradigms

Introduction

There is an ongoing discussion led by scholars in quest to clarify the sport management as a discipline with its own body of knowledge, vocabulary and methodology. Following the disciplinary approach described by Renson (1989) that the discipline is characterized by a particular focus or object of study, a specialized method of inquiry and unique body of knowledge, we provide the overview of the development of the thoughts in these three areas. The overview is complemented with the insight of the paradigms development in sport management in tune with the Kuhn's (1962) concept of a science based on paradigms. In our contribution, we will defend our view that if sport management would like to be considered as a mature science, then the scholar in this field must stick to the integrative paradigm, which is offered by kinanthropology, i.e. human movement studied in its socio – cultural context.

Sport management as a research discipline

Sport management as a research discipline is relatively new and has a short history but there is a lot of discussion within the academic community about what is and should be nature of this new disciplines and where it should be placed in the science. The first author who tried to find the proper place for sport management within the sciences was Earle F. Zeigler (1987) who underlined that all management theory and research are the social sciences, and more specifically the behavioural sciences and the fact that management is practiced in a specific settings has tended to obscure the fundamental similarities of the managerial process. In addition, according to him the theories related to the behaviour of people in organizations have much to offer to an understanding of management. The confusion of where to place the sport management as a research discipline has, in our view, its origin in the different housing of the sport management study programmes within the universities. As Costa (2005) argues sport management is housed within the kinesiology, the business schools, or independent departments. Another confusion especially in the Czech environment, but also in some other countries in Europe, comes from the different interpretation and the distinctions between the scientific disciplines kinanthropology and kinesiology. In this sense the most comprehensive explanation of the kinanthropology as an integrative paradigm for the study of human movement is offered by the R. Renson (1989). He argues that the kinanthropology is the cross – disciplinary science consisting from various sciences / disciplines from natural, human movement and human sciences. He offers the matrix where the mix between these sciences and physical activity sciences is displayed. In this matrix not surprisingly the sport management is placed in the bottom line as a professional application in the socio – cultural vertical dimension. The subject of research of the kinanthropology and thus of the sport management alike, is in general focused on physical activity of man in relation to its socio- cultural context.

Body of the knowledge development in sport management

Examination of the development of the body of the knowledge in sport management could show how the science of the sport management is developing in terms of the solidity of the study area (Kuhn, 1962). This examination could also reveal the paradigms in the context of sport management. These than indicate according to Kuhn a sum of interconnected theoretical and methodological beliefs and can function as a criterion defining what is scientifically relevant by pointing out several possible directions. Moreover the results of the studies could indicate the convergence of the body of the knowledge

in sport management to the parent discipline kinanthropology. Trying to find out what can currently be considered as a body of the knowledge in sport management, we have conducted the content analysis of available studies with regard to this problem (Parkhouse, Ulrich & Soucie, 1982; Soucie & Doherty, 1996; Pitts & Pedersen, 2005; Pitts & Danylchuk, 2007; Kim, 2012; Ciomaga, 2013). The clusters of theoretical topics have been developing in the period from 1950 to 2010 from leadership and administrative arrangement of sport management to sport marketing (motivation and behaviour of sport consumers), the organizational change and organizational culture. Assessing the whole range of theoretical topics which have been identified in all studies, we could state that a body of knowledge generated so far in sport management is organized in clusters around marketing and organizational theory and the convergence towards the subjects of study from various disciplines in kinanthropology is apparent. United paradigm is human movement which is studied in the socio-cultural context of the sport. The variety of topics also supports the main idea of the kinanthropology that to understand the human movement in all its context the cross-disciplinary approach is needed. This approach in sport management is also supported by the Parkhouse, Ulrich & Soucie (1982) who argued that a body of knowledge generated in studying the management of other industries already exists and could serve as the basis for sport management research.

Sport management as a science – development of the theories and paradigms

There has been a remarkable progress in the number and diversity of scholarly opinions regarding the research topics and methodologies in the field of sport management (Zeigler, 1987; Paton, 1987; Olafson, 1990, 1995; Slack, 1991, 1996; Soucie & Doherty, 1996; Boucher, 1998; Pitts, 2001; Balduck, Parmentier & Buelens, 2004; Skinner & Edwards, 2005; Frisby, 2005; Chalip, 2006; Chadwick, 2009, 2011, 2013; Rudd, Johnson & Burke, 2010; Doherty, 2012, 2013; Naumovski, Sojkov, Naumovski & Naumovski, 2013; Chelladurai, 2013), but what is still needed is justification of the produced knowledge in the light of the research practice. Academic disciplines differ from each other in terms of the theories and scientific laws the particular discipline consists of. The discipline has to be described as a more or less logical integrated system of theories. The idea that supports the correlation between the discipline and systems of theories has historical context (Kuhn, Popper, 1991). In sport management it has the consequences that once we would like to investigate the problems /elements in sport we shall pursue the integrative approach (Renson, 1989) and we have to search for the best solution by using the variety of the theories from different disciplines so to capture the nature of the problem and to be sure the solution we found is optimal with regards to that context. In this sense we will be also able to identify better the specific features of the problem in the sport context which inevitably led to the definition of the new (most probably integrative) concepts and theories distinctive to the sport management. Theory or a statement of construct and their relationships to one another that explain how, when, why, and under what conditions phenomena take place, is a critical element in the advancement of a discipline (Cunningham, 2013). Parkhouse, Ulrich, & Soucie (1982) suggested that the methods and conceptual frameworks of related disciplines can be effectively utilized to form the core on which sport management research is based. Zeigler (1987) suggests how to improve the situation in developing the sound theoretical basis in sport management and the great example of this process is described by Chelladurai (2013) where he is articulating the process of theorizing in sport management. For him, the theory development begins with a disconnection and discomfort with existing formulations on a topic. In drawing from this premise Chelladurai provides an overview of the theory development process he undertook when focusing on explaining the observed phenomena in sport. He underlines the importance of a sound classification of the observed phenomena which would facilitate the articulation and testing of the effects of certain factors and the relationships among them in each class of the phenomena. What are then theories and testing performing by sport management scientists? Do they have any peculiar way of doing so? The answer is, most, if not all, that the theories in sport management science belong to the domain of the traditional disciplines. As a field, sport management is made up of multiple disciplines (Doherty, 2012). Some of the disciplines received more attention than others, but for the most part each continues to advance within the academy. For sport management science to be considered as the mature science it means that it has to constitute a distinctive mode of inquiry in the light of the specific features of sport, context of the sport and distinctive features of the management in sport. As far as one of the distinctive feature of management in sport is complexity, the complex issues in sport may be an ideal opportunity for sport management to reach out and link with other disciplines in a “sport – focused” (Chalip, 2006) yet interdisciplinary agenda. From Kuhn’s perspective, the existence of a paradigm is necessary condition for an area of inquiry to be considered as science. Unfortunately, the term paradigm is used quite loosely in academic research and can mean different things to different people. To help clarify the uncertainties, Morgan (1979) suggests that the term can be used at three different levels. At the philosophical level, where it is used to reflect basic beliefs about the world; at the social level, where it is used to provide guidelines about how the researcher should conduct his or her endeavours; at the technical level, where it is used to specify the methods and techniques which ideally should be adopted when conducting research. Kuhn (1962) states that the science is developing from a non-scientific to a pragmatic stage. So where are we in the sport management? Mature science is characterized by the existence of paradigm. That is a criterion for the assessment of the sport management science development stage. If sport management science satisfies the description of paradigm, it can be considered a science (Kuhn, 1962). Theories are among those typical elements of paradigm and development of a sport management theory is a necessary condition for science of sport management. To explain why we are so much in favour of the idea that the right place for the sport

management is to be a sub discipline of kinanthropology, we have to justify what are, in our view, the paradigms of the sport which could be examined the best within the kinanthropology context. If the sport management is to be considered as a science which contributes to the theories, methodology and vocabulary in the mother discipline – kinanthropology, it must follow the interdisciplinary approach and at the same time it must focus on the unique research question to which no other basic discipline can give the answers. The research inquiry must challenge the unstated assumption about the sport or ideological issues related to the sport, i.e. sport is a good thing for society, building social values, etc. These questions should be linked to the role the sport is playing in society and the research must consider the new realities of the 21st century in such areas as: How and to what extent sport is developing and forming the desirable social and national values? How the economic impact of the sport activities should be measured so to capture the social capital as a consequence? How to measure the best the social, economic and ecological impact of sport? Why there is still decline of sport engagement? These are quite complex questions and therefore in our view they can be answered only by following the interdisciplinary approach in the disciplinary framework of kinanthropology. In terms of the classification of the paradigms (Morgan, 1979), the above-mentioned question are related to those paradigms that are set at the philosophical level, and which are reflecting the basic beliefs about the world. The second type of paradigms which are set at the social level, and which are used to provide guidelines about how the researcher should conduct his or her endeavours, we refer to the paradigms discussed recently in the academia and which are presented in the book of essays (Gillentine, Baker & Cuneen, 2012). The paradigms in sport management at a third – technical level are used to specify the methods and techniques which ideally should be adopted when conducting research, are touching the issues as sport management as an academic discipline and science; development of the theories of sport management; methodological aspects of the research in sport management and taxonomy for sport management. Following the content analysis of the development of the scholars opinions regarding the research and methodology in sport in the period from 1987 to 2013 we could state, that has been an agreement reached that in sport – focused research interdisciplinary approach as well as utilization of fixed research methods in needed. This paradigm again can be realized only in the kinanthropology framework.

Discussion and conclusion

Based on our previous considerations we cannot agree with an idea that a research discipline should possess the subject matter which would be not under the jurisdiction of another discipline and we are very much in favour of those who heavily criticized the paradigm that each discipline relates to the exclusive subject matter. Popper (1991) points out that it is a mistake to think that academic disciplines are distinguishable by the subject they investigate. According to the Popper, this type of distinction is only at a very basic level. For Popper, we do not study subject matter but problems and the latter may cut across disciplines and subjects matters. Problems emerge out of expectations, theories and empirical test derived from them. Therefore theories and not subject matter may comprise a discipline. Sport Management as a relatively new discipline is seeking its own subject which is not the subject of any discipline already in existence. But what is actually the subject of the sport management? Obviously, it is sport and management. But which elements of the sport and management? What constitutes the overlap between these two? What from this overlap is not covered by other discipline and is exclusive to the sport management? At this point, we have to stress that the elements of sport and management are covered by variety of disciplines. Considering the various situation in the sport management practice it is obvious, that the overlap is composed of the mixed elements which are subject of different disciplines. Considering the Renson's (1989) description of the kinanthropology, the sport management is a discipline which is a smaller part of the particular portions of knowledge related to the kinanthropology and it follows the integrated paradigms in the study of Human Movement. In sport management, research and teaching is organized assuming that it is a discipline. This is led by the conviction that sport management as an academic discipline is also an autonomous branch of scientific knowledge. Subjects which are included in the sport management programmes vary significantly from country to country and body of the knowledge for sport management as an academic discipline is defined by the academic standards. Sport management as an academic discipline is composed of certain portions of diverse fields such as anatomy, physics, psychology, history, sociology, economics. But these portions differ and this is strongly influenced by the administrative arrangement and by the academic standards which are set and pursuit in that particular country. Creating a unique body of knowledge has been and still is tough in sport management due to the breadth of the field and the various mother disciplines provide the knowledge applicable in sport management. Based on our cogent analysis of the studies related to the body of the knowledge and research focus and methodologies in sport management, our conclusion is that the unique body of the knowledge in sport management is created within a unique context – sport environment - in which the various aspects of management are explored using the mixed research methods. Thus the uniqueness of the body of knowledge and the methodology in sport management can be justified only when interdisciplinary nature of the sport management is taken into consideration. Our thoughts are very much in tune with the framework suggested by Zeigler (2007) which he called the taxonomy of sport management. It includes both scholarly and professional dimensions with areas of scholarly study and research, related disciplinary aspects, and professional aspects. Although Zeigler's taxonomy was designed to postulate three categories of graduate education in sport management, he admitted that it has a number of meanings. For us, this taxonomy provides another justification of our claim regarding the interdisciplinarity of the sport management research and clarifies again the link between the kinanthropology as a mother discipline and sport management as its sub discipline.

References

1. Balduck A.L, Parmentier, A & Buelens, M. (2004) Research methodology in the domain of sport management : preliminary results of the current state. EASM European Sport Management Congress, 12th, Book of abstracts : 261-262.Vancouver.
2. Boucher, R.L. (1998). Toward Achieving a Focal Point for Sport Management: A Binocular Perspective. *Journal of Sport Management*, 12, 76-85.
3. Ciomaga, B. (2013) Sport management: a bibliometric study on central themes and trends. *European Sport Management Quarterly* [online]. 20131201, vol. 13, issue 5, 557-578.
4. Costa, C.A. (2005). The Status and Future of Sport Management: A Delphi Study: *Journal of Sport Management*, 19, 117-142.
5. Cunningham, G.B. (2013). Theory and theory development in sport management, *Review. Sport management Review* 16, 1-4.
6. Doherty, A. (2012). "It takes a Village": Interdisciplinary Research for Sport Management. *Journal of Sport Management*, 2012, 27, 1-10.
7. Doherty, A. (2013). Investing in sport management: The value of good theory. *Sport Management Review* 16, 5-11.
8. Frisby, W. (2005). The Good, the Bad, and The Ugly: Critical Sport Management Research: *Journal of Sport Management*, 19, 1-12.
9. Gillentine A., Baker R.E & Cuneen, J. (2012) *Critical Essays in Sport Management: Exploring and Achieving a Paradigm Shift*. Holcomb Hathaway.
10. Chadwick, S. (2009). From outside lane to inside track: sport management research in the twenty – first century: *Management Decision*, vol. 47, No. 1, 191- 203.
11. Chadwick, S. (2011). Editorial: the distinctiveness of sport: opportunities for research in the field: *Sport, Business and Management: An International Journal*, Vol. 1, No. 2, 120-123.
12. Chalip, L. (2006). Toward a Distinctive Sport Management Discipline: *Journal of Sport Management*, 20, 1-21.
13. Chelladurai, P. (1992). Sport Management: Opportunities and Obstacles. *Journal of Sport Management*, 6, 215-219.
14. Chelladurai, P. (2013). A personal journey in theorizing in sport management. *Sport Management Review* 16, 22- 28.
15. Kim, A. Ch. H. (2012) Knowledge Structure in Sport Management: Bibliometric and Social Network Analyses. The Ohio State University, 2012.
16. Kuhn, T. S. (1962). *The Structure of Scientific Revolutions*. Chicago: University Of Chicago Press.
17. Morgan (1979). 'Response to Mintzberg'. *Administrative Science Quarterly*. 24 (1), 137-139.
18. Naumovski, G., Sojkov, A., Naumovski, A. & Naumovski, V. (2013) Fostering application of more exact methodological and statistical procedures in sort management research. *Journal pf Physical Education and Sport*, 13(2), Art 41, 250- 254.
19. Olafson, G.A. (1990). Research Design in Sport Management: What's Missing, What's Needed? *Journal of Sport Management*, 4, 103-120.
20. Olafson, G.A. (1995). Sport Management Research: Ordered Change, *Journal of Sport Management*, 9, 338-345.
21. Parkhouse, B.L., Ulrich, D & Soucie, D. (1982). Research in Sport Management: A Vital Rung of This New Corporate Ladder: *Quest*, 34(2), 176-186.
22. Parkhouse, B.L. & Ulrich, D. (1979). Sport Management as a Potential Cross- Discipline: A Paradigm for Theoretical Development, Scientific Inquiry, and Professional Application: *QUEST*, 31(2), 264 -276.
23. Paton, G. (1987). Sport Management Research – What Progress Has Been Made? *Journal of Sport Management*, 1, 25-31.
24. Pitts, B. G. (2001). Sport Management at the Millennium: A Defining Moment: *Journal of Sport Management*, 15, 1-9.
25. Pitts, B. G. & Pedersen, P.M. (2005) Examining the Body of Scholarship in Sport Management: A content analysis of the *Journal of Sport Management*. The SMART Journal, Vol. 2, issue 1, Fall 2005.
26. Pitts, B. G. & Danylchuk, K. E. (2007). Examining the Body of Knowledge in Sport Management: A Preliminary Descriptive Study of Current Sport Management Textbooks, *Sport management Education Journal*, 1, 40-52.
27. Popper, K.R. (1991) *Conjectures and Refutations: The Growth of Scientific Knowledge*. London: Routledge.
28. Renson (1989). From Physical Education to Kinanthropology: A Quest for Academic and Professional Identity. *QUEST*, 41, 235-256.
29. Rudd, A. & Johnson, R. Burke (2010). A call for mixed methods in sport management. *Sport Management Review*, 13, 14-24.
30. Skinner, J. & Edwards, A. (2005). Inventive Pathways: Fresh Visions of Sport Management Research: *Journal of Sport Management*, 19, 404-421.
31. Slack, T. (1991). Sport Management: Some Thoughts of Future Directions. *Journal of Sport Management*, 5, 55-99.
32. Slack, T. (1993). Morgan and the Metaphors: Implication for Sport Management Research, *Journal of Sport Management*, 7, 189-193.
33. Slack, T. (1996). From the Locker Room to the Board Room: Changing the Domain of Sport Management. *Journal of Sport Management*, 10, 97-105.
34. Soucie, D. & Doherty, A. (1996). Past Endeavors and Future Perspectives for Sport Management Research: *QUEST*, 48, 486-500.
35. Zeigler, E. F. (1987). Sport Management: Past, Present, Future. *Journal of Sport Management*, 1, 4-24
36. Zeigler, E.F. (2007), Sport Management Must Show Social Concern as It Develops Tenable Theory: *Journal of Sport Management*, 21, 297-318.

STRATEGIC MANAGEMENT ISSUES OF CROATIAN NATIONAL SPORT FEDERATIONS

Sanda Čorak, Snježana Boranić Živoder and Zrinka Marušić

Institute for Tourism, Zagreb, Croatia

Abstract

Although a large number of sport organizations are non-profit, achieving the best sports results possible while at the same time using financial resources efficiently leads to the need for strategic planning methods and tools. Compared to a decade ago, literature and educational opportunities for professional development are nowadays much more widely available and yet many sport organizations in Croatia still do not develop and adopt strategic development plans. This paper presents the results of a survey conducted among national sport federations under an umbrella of Croatian Olympic Committee with an aim to determine their attitudes regarding main development directions of sport in Croatia. The research builds on a similar research conducted by Škorić (2011) which revealed devastating facts regarding the use of some of the main strategic planning instruments. The results obtained by this survey show clear progress. Although it is still early to speak about comprehensive strategic planning, its individual elements are used by the majority of national sport federations in Croatia.

Key words: strategic planning in sport, national sport federations, sport management, Croatia

Introduction

In the past 20 years, sport management has increasingly been attracting attention in scientific and professional circles. The need for applying strategic management principles in sport organizations had not been identified until the early 1990s, when researchers started to consider strategy in the context of sport organizations (Škorić, 2011). Sport management, as a process of organizing and managing sport or a sport organization in order to achieve sporting and other goals while at the same time rationally using limited resources (Bartoluci, 2003) is nowadays used at various levels, from sport organizations to clubs. It involves the “process of monitoring and analyzing key changes in the environment and developing strategies to increase the organization’s effectiveness in response to those changes” (Covell *et al.*, 2003: 139).

Globalization, as well as economic, political and social developments, brought numerous challenges to sport organizations when it comes to successful and professional management. Such management means that all managerial activities, from planning, organizing and leading to controlling are applied in an efficient way. The growth and professionalization of sport, particularly in the last 30 years, has led to changes in the way sport is consumed, produced and managed within sport organizations at all levels of sport (Hoye, Nicholson & Smith, 2010). Nowadays sport employs a huge number of people, enriches and promotes the tourism industry and “feeds” the media. Many sporting events are becoming increasingly commercialized and generate income in a variety of ways. However, unlike other types of organizations with management, sport organizations are not focused solely on generating profit and their priorities also include winning competitions and servicing the needs of members.

Sport is characterized by a number of unique features which make sport management different from the management of other economic activities. According to Hoye, Nicholson and Smith (2008), these unique features refer to: sport consumer behaviour, government relations, sport regulations, strategy in sport, organizational structure, human resources management, sport culture, sport governance and performance management. Many sport organizations around the world are undergoing change in terms of professionalization of management and introduction of management roles. While the dominant management culture in the past was the traditional culture of volunteer managers, management of sport organizations today requires numerous managerial skills and knowledge.

Since sport, given its multiple roles, is also part of national policies, from health, promotion and economic to other policies, at the level of countries and groups of countries strategies and various other documents are adopted aimed at boosting the quality of governance of sport, but also at preserving features that make it different. For example, the European Union (2013), in its Work Plan for Sport for 2011-2014, adopted principles for the successful management of sport which it defines as “the framework and culture within a sport body sets policy, delivers its strategic objectives, engages with stakeholders, monitors performance, evaluates and manages risk and reports to its constituents on its activities and progress including the delivery of effective, sustainable and proportionate sports policy and regulation”. Principles for successful management are also adopted by umbrella sport organizations, the International Olympic Committee and the European Commission (Preparatory Actions in Sport), indicating the widely recognized need for developing strategies, defining

strategic goals, implementing organizational elements - monitoring, controls and systems and in general management in the way that best meets the interests of all members.

In its "Strategic plan of the Ministry of Science, Education and Sports for 2012 -2014" (2012) Croatia likewise made sustainable quality of the sport system one of its goals and emphasized the need for improving the recreational, health, educational, professional and promotional importance of sport. New national strategy for sport in Croatia is expected to be developed in 2014, and all national sport federations are expected to participate in its operationalization through their umbrella organization, the Croatian Olympic Committee [COC]. The aim of this research is to determine the extent to which national sport federations use strategic planning methods and tools and, comparing it with the research conducted in 2011 (Škorić, 2011), determine if there has been progress in the use of some of the main strategic planning instruments between 2011 and 2013.

Methods and Results

In this paper we analyse the data collected by the annual survey of national sport federations conducted by the COC for the planning purposes. The COC gathers all national Olympic and non-Olympic sport federations with the status of regular, associate or temporary members. The total population for this study was comprised of all 78 national federations, either regular or associate members of the COC (2014). Responses to three open-ended questions collected by the survey regarding the: (i) main/strategic goals, (ii) organizational and business aims, and (iii) major problems/obstacles identified by each sport federation are analysed. Prior to data analysis the responses to open-ended questions were first categorised and coded. Data are analysed overall and according to sport status (Olympic vs non-Olympic sports) and type of sport (individual vs team ones) in order to observe eventual differences in the use of basic strategic planning elements.

Table 1: Response rate by status and type of sport

		Total number of federations	Number of filled-in questionnaires	Response rate in%
Total		78	58	74.4
Status of sport	Olympic	38	32	84.2
	Non-Olympic	40	26	65.0
Type of sport	Individual	64	44	68.7
	Team	14	14	100.0

The overall survey response rate was 74% with slightly higher response rate for Olympic sports (84%) than for non-Olympic ones (65%). The national federations of team sports had a 100% return rate (Table 1).

Table 2: Main goals of sport federations (members of COC) in 2012 - 2013

Main goals:	Total (N=58)		Status of sport				Type of sport			
			Olympic (N=32)		Non-Olympic (N=26)		Individual (N=44)		Team (N=14)	
	n	%	n	%	n	%	n	%	n	%
Training and education of coaches, judges and competitors; exchanging experiences	37	63.8	19	59.4	18	69.2	27	61.4	10	71.4
Popularization of sport, expanding the base, increasing the number of clubs and competitors	32	55.2	21	65.6	11	42.3	19	43.2	13	92.9
Development of a quality plan and programme of activities	20	34.5	14	43.8	6	23.1	15	34.1	5	35.7
Better cooperation with the media; promotion of sport	17	29.3	6	18.8	11	42.3	12	27.3	5	35.7
Improving the work with younger generations; cooperation with schools	15	25.9	7	21.9	8	30.8	10	22.7	5	35.7
Building adequate infrastructure/sport facilities/purchasing equipment	13	22.4	7	21.9	6	23.1	7	15.9	6	42.9
Improving the system of competition	6	10.3	3	9.4	3	11.5	5	11.4	1	7.1
Intensifying cooperation with international organizations	4	6.9	3	9.4	1	3.8	4	9.1	0	0.0
Professionalization of coaches	4	6.9	4	12.5	0	0.0	3	6.8	1	7.1
Other	5	8.6	2	6.3	3	11.5	5	11.4	0	0.0

Source: COC survey of national sport federations in 2012 - 2013

Two main goals of the majority of sport federations, according to their own responses, are the following: (i) training and education of coaches, judges and competitors (64%) and (ii) popularization of sport and expanding the base, including also the goal of increasing the number of competitors and clubs in the country (55%), which were chosen by more than half of the surveyed federations (Table 2). The third goal by the importance is development of a quality plan and programme of activities (35%), followed by promotion of sport, including better cooperation with the media (29%). The group of non-Olympic sports gives more importance to training and education, promotion activities and work with young athletes, but significantly less importance to the popularization activities, the development of quality plans and to professionalisation of coaches which they did not mention at all. This difference is largely the result of the fact that Olympic sports in Croatia are more developed than non-Olympic ones. Differences were also observed between individual and team sports, and even though the order of the top two goals is the same, popularization of sport is twice as important to team sports (93%) than to individual ones (43%). While team sports consider improving the work with younger generations (36%) and building adequate infrastructure (43%) as important goals, individual sports give more priority to intensifying cooperation with international organizations (9%), which is an expected result given that team sports are in general more developed in Croatia, particularly Olympic team sports.

Table 3: Organizational and business objectives of sport federations (members of COC) in 2012 - 2013

Organizational and business objectives	Total (N=58)		Status of sport				Type of sport			
			Olympic (N=32)		Non-Olympic (N=26)		Individual (N=44)		Team (N=14)	
	n	%	n	%	n	%	n	%	n	%
Better organization of work in the federation (computerization, databases, web page etc.)	29	50.0	19	59.4	10	38.5	20	45.5	9	64.3
Attracting sponsors	13	22.4	8	25.0	5	19.2	10	22.7	3	21.4
Organization of major international competitions	11	19.0	5	15.6	6	23.1	10	22.7	1	7.1
Improving the quality of competitions (trainings)	11	19.0	5	15.6	6	23.1	8	18.2	3	21.4
Securing more funding	9	15.5	5	15.6	4	15.4	7	15.9	2	14.3
Increasing the number of professionals to work with the national team (coaches/cooperation with Faculty of Kinesiology)	7	12.1	3	9.4	4	15.4	4	9.1	3	21.4
Cooperation with the media	6	10.3	4	12.5	2	7.7	5	11.4	1	7.1
Better marketing	5	8.6	5	15.6	0	0.0	2	4.5	3	21.4
Hiring an administrative worker	5	8.6	4	12.5	1	3.8	2	4.5	3	21.4
Publishing activities (publications; professional literature)	3	5.2	2	6.3	1	3.8	3	6.8	0	0.0
Other	8	13.8	5	15.6	3	11.5	8	18.2	0	0.0

Source: COC survey of national sport federations in 2012 - 2013

The second open-ended question related to the planning process in sport federations asked them to specify organizational and business objectives that should help them meet strategic goals mentioned previously. Responses to this question largely overlap with main goals, indicating that people who work in sport federations do not perceive the difference between strategic, long-term goals and operational, short-term objectives (Table 3). As expected, better organization of work in the federation which includes activities from computerization to development of adequate databases and informative websites, is the primary objective (50%) of national federations, followed by activities aimed to attract sponsors (22%), organizing major international competitions and increasing the quality of competitions (19% respectively). If we look at differences between federations by status and type of sport, better organization of work in the federation is more important to the Olympic (59%) and team sports (64%) while non-Olympic and individual sports place higher importance (23% each) on organization of major international competitions, probably because of a greater need for promoting these sports. It is interesting to note that Olympic sports have selected a larger number of objectives than non-Olympic ones and have put a relatively high importance on better marketing, hiring an administrative staff and publishing activities, which are more important to federations from the group of individual sports. Compared with individual sports, team sports more often stressed the need to increase the number of professionals to work with the national team (21%) which is understandable given the nature of these sports. Better marketing and hiring an administrative staff are also more important to team than individual sports.

Table 4: The main problems in the work of sport federations (members of COC) in 2012 - 2013

The main problems	Total (N=58)		Status of sport				Type of sport			
			Olympic (N=32)		Non-Olympic (N=26)		Individual (N=44)		Team (N=14)	
	n	%	n	%	n	%	n	%	n	%
Lack of financial resources	31	53.4	21	65.6	10	38.5	24	54.5	7	50.0
Lack of or inadequate sport infrastructure	21	36.2	14	43.8	7	26.9	13	29.5	8	57.1
Lack of skilled staff (coaches, judges, administrative staff)	19	32.8	11	34.4	8	30.8	13	29.5	6	42.9
Media neglect	13	22.4	5	15.6	8	30.8	10	22.7	3	21.4
Difficulties in finding sponsors	11	19.0	7	21.9	4	15.4	7	15.9	4	28.6
Shortage of equipment (expensive equipment)	4	6.9	3	9.4	1	3.8	3	6.8	1	7.1
Categorization of athletes	3	5.2	1	3.1	2	7.7	3	6.8	0	0.0
Other problems	21	36.2	11	34.4	10	38.5	14	31.8	7	50.0

Source: COC survey of national sport federations in 2012 - 2013

National sport federations reported lack of financial resources (53%), lack of or inadequate sport infrastructure (36%) and shortage of skilled staff (33%) as the main problems in their work, followed by media neglect of sport and difficulties in finding sponsors, which are an issue for a fifth of the federations, while shortage of equipment (or expensive equipment) and inappropriate categorization of athletes were cited less often (Table 4). The first two issues are more important to Olympic than non-Olympic sports, whereas the second and the third problem are much more important to federations of team sports than federations of individual ones. Difficulties in finding sponsors were, again, more important to federations of team sports (29%), lack of equipment to Olympic sports (9%) and categorization of athletes to non-Olympic sports, which is understandable given their status within the COC. All of these problems are in line with the objectives they mentioned. There is a logical connection between the identified problems and the objectives set forth for a specific area of action. The "Other" category is the most prevalent (36%) in this regard, indicating that specific problems some federations have could not have been classified under any of the established categories, leading to a conclusion that sport is a specific activity to which strategic planning is as important as it is to other types of activities, yet the specific nature of its problems calls for different objectives as well as measures and activities to meet these objectives. The biggest problem sport federations in Croatia faced is securing funding for all types of activities they want to engage in, these being, as this research has shown, not only activities concerning top level performances but also popularization of sport and increasing the number of clubs and competitors. All of these objectives are non-monetary and meeting them requires not just financial resources but a great deal of enthusiasm, volunteering etc.

Although strategic plans in sport have common components - current situation analysis, vision statement, mission statement, goals and objectives and activities and measures for a specific period - in the absence of such plans in sport organizations in Croatia, we may superficially conclude that there is a complete absence or that a very small number of organizations and national sport federations uses strategic planning, as reported by Škorić as well (2011). According to the results of the 2012 - 2013 COC survey, three-quarters of federations set their main strategic goals, organizational and business objectives and identify the biggest problems they encounter in their work based on which they make their annual plans of activity. Therefore, despite the fact that these are not comprehensive plans, federations are clearly capable of articulating strategic (long-term) goals and operational (short-term) objectives of their activities, as well as of identifying major problems based on which they adopt annual plans of activity.

Conclusion

Strategic planning is gaining importance in sport, especially due to the need to reduce investment risks. Regardless of whether funding comes from private or public sources, the latter being the most common sources of funding in Croatia, transparent performance is expected. Therefore, strategic management has established as a prerequisite for autonomy and financial support. Sport organizations are becoming increasingly aware that long-term, strategic perspective is extremely important for achieving success. Although, as the survey suggests, strategic planning and development of long-term plans are still in their infancy in sport federations in Croatia, the situation is improving. Furthermore, the conclusion that strategic planning is rarely implemented in its entirety in sport in Croatia still stands (Škorić, 2011). However, most sport federations, with Olympic sports leading the way, detect major problems and adopt strategic goals and operational objectives each year. Given this positive trend, we may conclude that a lot of sport professionals will get educated in the field of strategic planning in the next several years and will soon master the technology of developing and adopting strategic plans. The national strategy for sport is surely going to contribute to that process and become a 'guiding principle' for all sport federations and other sport organizations at the regional and local level.

References

1. Australian Sports Commission. (2012). Sport Governance Principles. Retrived Febrary 20, 2014, from http://www.ausport.gov.au/__data/assets/pdf_file/0004/563629/ASC_Governance_Principles.pdf
2. Bartoluci *at al.* (2004). *Menadžment u sportu i turizmu*. Zagreb: Kineziološki fakultet i Ekonomski fakultet.
3. COC (Croatian Olympic Committee) (2014). *Nacionalni sportski savezi*. Retrived Febrary 20, 2014, from <http://www.hoo.hr/1340-v-nacionalni-sportski-savezi.aspx>
4. Corrvell, D., Walker, S., Sociliano, J. & Hess, P.W. (2003). *Managing sport organizations: Responisbility for performrance*. Mason; OH: Thomson South-Western.
5. Expert Group “Good Governance” (2012). Discussion document. Principles of good governance in sport. Brussels: European Union. Retrived February 20, 2014, from http://ec.europa.eu/sport/news/2013/20131017-principles-good-governance_en.htm
6. Hoye, R., Nicholson, M. & Smith, A. (2008). Unique aspects of managing sport organizations. In C. Wankel (Ed.), *21st century management: A reference handbook*. (pp. II-501-II-510). Thousand Oaks, CA: SAGE Publications, Inc. Doi:<http://dx.doi.org/10.4135/9781412954006.n99>
7. Škorić, S. (2011). Application of strategic management activities in the Croatian National Sport Federations. In D. Milanović & G. Sporiš (Eds.), *Proceedings Book of the 6th International Scientific conference of Kinesiology* (pp.584-587). Zagreb: Faculty of Kinesiology.

FINANCING SPORTS ASSOCIATIONS IN CONDITIONS OF ECONOMIC CRISIS – A CASE STUDY: THE CITY OF RIJEKA

Lorena Dadić

Faculty of Tourism and Hospitality Management, Opatija, Croatia

Abstract

The excellent performance of Croatian athletes and sports clubs at the world level has made Croatia internationally distinctive. Without top-quality sports personnel, equipment and sports infrastructure, athletes cannot be expected to achieve excellent results, no matter how dedicated and committed to sports they may be. For the most part, sports associations traditionally rely on funds from the state budget and the budget of local self-government units. However, given the economic crisis and growing pressure on budgets, the sustainability of the existing model of financing sports associations has been brought into question. Using the example of the Town of Rijeka, the paper analyses the allocation to sports of funds from the town budget and examines modifications in the structure of financing sports associations as the result of adverse changes to conditions in the environment.

Key words: sports associations, financing sports associations, local self-government budget

Introduction – overview of previous research

Unlike most developed countries in Europe and around the world, the Republic of Croatia has only in recent times recognized the opportunity of developing civil society through the establishment and registration of non-profit organizations. It was only in the late 1990s that Croatia built an extensive institutional infrastructure to foster the development of civil society. At the national level, these are the Government Office for Cooperation with NGOs, the Council for the Development of Civil Society and the National Foundation for the Development of Civil Society. Of all NGO forms, associations are the most numerous civil society organizations in Croatia. (Bežovan, Ivanović, 2007, p. 17)

An association does not operate for the purpose of generating profit for either its members or third persons. If an association should generate profit in the course of its operations, such profit can be used exclusively in carrying out and promoting the association's activities in accomplishing its goals as stipulated in its statute. According to the *Central Bureau of Statistics*, there were 41,100 registered associations in Croatia in 2013. The majority of these associations were registered for conducting sports activities (Bežovan, 2000, p. 86). In Croatia, the *Sports Act* (Official Gazette 71/06) does not define the term *sport*. Instead, it stipulates the activities it involves. These are "participating in sporting competitions, sporting preparation, sporting recreation, sports teaching, organizing and managing sporting competitions, managing and maintaining sports facilities, and organizing extracurricular sports activities for school children and sports activities for students."

According to Bartoluci & Skoric, (2008, p. 465), competitive sporting in Croatia is organized in the form of a pyramid, at the tip of which is the Croatian Olympic Committee, followed by national sports federations, sports federations and sports communities of counties and the City of Zagreb, sports communities of towns and municipalities, and finally, sports clubs and associations. Other areas in sports also have a similar organizational chart; sports associations and societies in individual fields may come together to form federations at the level of towns, municipalities and counties and, ultimately, national federations (Croatian School Sports Federation, Croatian University Sports Federation, Croatian Sporting Recreation Federation, Croatian Paralympics Committee and Croatian Deaf Sports Federation).

In the period 1997 – 2009, the number of associations entered in the Register of Associations increased continuously. The number of registered sports associations grew from 2,770 in 1997 to as many as 4,165 in 2009. The City of Zagreb boasts the largest number of sports associations (668), while Zadar County, with only 67 sports associations, has the least. By number of associations, Primorje-Gorski Kotar County ranks third in Croatia with no less than 3,279 associations, of which 1,279 or 39% are sports associations (*2013 – 2020 Development Strategy of the Healthcare Industry in Primorje-Gorski Kotar County*, p. 24)

Based on the clear set of regulations in respect of funding of the sport activities and the adopted key strategies for progress to be achieved in sports, the city of Rijeka sets an expiring example. Therefore this paper shall analyse the funding of sport associations, based in the city of Rijeka, in the time of economic crisis.

Table 1: Types of sports associations entered in the Register of Sports Activities at the State Administration Office in Primorje-Gorski Kotar County in 2012

Sports Associations	Number of associations	Structure (%)
TOTAL	216	100
Bocce ball	33	13.1
Sports fishing	33	13.1
Other sports	31	12.3
Hunting associations	25	9.92
Soccer	19	7.54
Basketball	15	5.95
Sailing	11	4.37
Tennis, squash	11	4.37
Bowling	10	3.97
Volleyball	10	3.97
Mountain climbing	10	3.97
Chess associations	9	3.57
Karate	7	2.78
Diving	5	1.98
Handball	5	1.98
Skiing	5	1.98
Shooting sports	5	1.98
Table tennis	4	1.59
Taekwondo	4	1.59

Source: Register of Sports Activities of Primorje-Gorski Kotar County <http://www.sport-pgz.hr/content/view/1155/248/> (10.12.2013)

Judging by the number of associations entered in the Register of Sports Activities, the most popular sports are bocce ball and sports fishing, each with 33 registered associations or 13.1%. Next in popularity are hunting associations, numbering 25 and accounting for 9.92%, followed by 19 soccer associations, accounting for 7.54% of all registered sports associations. Table tennis and taekwondo are sports with the lowest number of sports associations (only four each) and the lowest share (1.59%).

Financing sports associations

The sports financing system in Croatia is regulated by the Sports Act (Official Gazette 71/06, Article 74) which stipulates:

- “The basis of sports financing is the revenue which legal and natural persons who perform sporting activities gain by performing sporting activities; the membership fees collected by sports associations; a part of the revenue from organizing games of luck; and the funds given by local and regional self-governing units, the City of Zagreb and the State to assist the performance of sporting activities.
- The Republic of Croatia, local and regional self-government units and the City of Zagreb shall determine the public needs for sports and ensure the funds for meeting these needs from their own budgets in accordance with this Act.”

For the most part, the sports sector in EU member states is financed from public sources (state budget, the budgets of counties, cities and municipalities) and, to a smaller extent, by funding from businesses. Each member state has set up its own, specific system for allocating funds according to sources and the amount of money allocated, leading to considerable differences among countries. (Petry et al., 2004, p. 17)

The sports financing system in Croatia is similar to the European one which is based on a combined sports-financing model. The most common model in practice, it combines two models – state financing and funding from businesses (Bartoluci, Škorić, 2009, p. 32). Due to the economic crisis, public sources of financing from the budgets of towns, municipalities, counties and the state designated for associations are steadily shrinking, thus directly affecting the sports sector as a whole that is confronted with a large loss of funding. Clearly, the economic crisis has dealt a severe blow to the sports system and caused revenue to drop. In analysing the budget expenditure of the Town of Rijeka over the last ten years, the following section focuses on the total allocation of funds for sports by year and offers a projection for 2014 and 2015.

Table 2: Sports financing in the Town of Rijeka budget in the period 2004-2013 and projections for 2014 and 2015 (in EUR millions)

Year	Town of Rijeka Budget (total expenditure)	Part of budget for the Town Department of Sports and Technical Culture		Allocated to sports from total budget, in%
		Total (EUR)	Out of total, allocated to sports (EUR)	
2004	93,42	9,71	7,36	7.88
2005	109,41	9,72	8,46	7.73
2006	111,62	12,64	11,36	10.18
2007	124,63	18,03	17,33	13.91
2008	138,17	10,01	8,67	6.28
2009	125,52	11,27	10,33	8.23
2010	115,73	13,06	12,08	10.44
2011	130,60	15,31	13,09	10.03
2012	111,33	13,24	9,76	8.77
2013	111,28	11,32	9,91	8.91
2014	99,27	10,76	9,42	9.49
2015	97,57	10,47	9,15	9.38

Source: by the author based on data gathered from the official Web pages of the Town of Rijeka (<http://www.rijeka.hr/ProracunGrada>) 17.12.2013

Table 2 shows how much money went to the Town Department for Sports and Technical Culture out of the total expenditure of the Town of Rijeka budget and how much of that money was allocated to sports. Expenditure in the Town of Rijeka budget was the lowest in 2004, and contrary to expectations that sports allocations would also be the lowest, this was not the case. The lowest amount allocated to sports in the total expenditure of the Town of Rijeka budget was in 2008. The largest amount was allocated to sports in 2007 (13.91%) and the lowest in 2008 (6.28%). After 2008 and with the beginning of the economic crisis in 2009, there has been an evident drop in total expenditure in the Town of Rijeka budget (with the exception of 2011) and this trend is expected to continue in 2014 and 2015. Contrary to expectations, a drop in expenditure in the budget does not necessarily mean a drop in expenditure for the sports sector. This is evident when the years 2010 and 2009 are compared. Although total expenditure in the Town of Rijeka budget dropped in 2010, allocations to the sports sector grew in that same year. Projections for 2014 and 2015 also follow this trend; although total expenditure will be lower relative to the two previous years, allocations to sports will show a slight increase.

Beneficiaries of budget funds are mostly sports associations and athletes as well as institutions that manage sports infrastructure. Public funds are most often granted to entities in sports activities in the form of funds for financing programmes for public needs in sports or through applications for grants to finance special sports projects and programmes. In the Town of Rijeka budget, funds allocated to sports are shown in Division 007, Town Department for Sports and Technical Cultural, which is divided according to programmes and activities. This department includes the programme of public needs in sports, the programme of public needs in technical culture, the programme of managing sports and technical culture facilities in the competence of the department, the "Rijeka Sports" programme, the loan repayment programme and the EU projects programme.

The following section focuses on the programme of public needs in sports and identifies the allocation of funds from the Town of Rijeka budget for each individual activity within the programme. This programme also finances the Rijeka Sports Federation– the Sports Community of the Town of Rijeka.

The Rijeka Sports Federation is a non-profit organization, the members of which are sports associations with registered offices in the territory of Rijeka. It was established with the aim of developing and promoting sports in Rijeka, encouraging top-level sports achievements and creating conditions to enable such achievements, and developing sports activities of children and young people, as well as recreational activities of citizens and disabled persons. (*Rijeka Sports Federation, www.rss.hr 16.12.2013*) At the end of 2012, the members of the Rijeka Sports Federation were 207 sports associations. The Rijeka Sports Federation obtains funds for financing its operations from the Town budget, from donations, from selling goods and providing services, and from other revenue. (*State Audit Office www.revizija.hr ; Audit Report, Sport Community of the Town of Rijeka "Rijeka Sports Federation"; June 201, accessed 17.12.2013*)

Table 3: Structure (in%) of allocations to public needs in sports in the Town of Rijeka budget in %

	YEAR							
	2008	2009	2010	2011	2012	2013	2014*	2015*
Training and sporting competitions of athletes	71.04	67.11	68.42	70.37	71.59	71.14	71.64	71.64
Awards and participation in sporting competitions	14.46	12.73	10.58	10.65	6.51	8.59	6.48	6.48
Implementing sports activities of children, young people, students and recreationalists	1.10	3.77	2.40	1.56	1.48	1.98	1.47	1.47
Training and sporting competitions of disabled persons or persons with impaired hearing	1.32	2.12	1.62	1.07	1.98	1.89	1.96	1.96
Operating of the sports system	12.08	14.27	16.97	16.35	18.44	16.40	18.45	18.45
TOTAL SPORTS NEEDS	100.00	100.00	100.00	100.00	100.00	100.00	100.00	100.00

Source: by the author based on data gathered from the official Web pages of the Town of Rijeka (www.rijeka.hr) 12.12.2013

*Projections for 2014 and 2015

It is evident from Table 3 that in the structure of allocations to the programme of public needs in sports, the largest share goes to the activity involving training and sporting competitions of athletes, this being the most important activity in any sport. Although funding for this activity dropped in 2009 and 2010, it began to grow again in the following years, and this gentle upward trend is projected for 2014 and 2015. The second activity, awards and participation in sporting competitions, has seen a continuous downward trend in financing since 2008. The reason for this can be attributed to the global economic crisis which has brought about a series of savings measures which are reflected in budget cuts in all areas, including the various parts of the sports sector. To enable the functioning of the sports system, a 12.5 percentage point increase in funding is planned relative to 2013.

Table 4: Revenue structure of the Rijeka Sports Federation

	2009		2010		2011		2012	
	HRK	%	HRK	%	HRK	%	HRK	%
Total revenue	10,538,009	100.00	5,836,462	100.00	5,829,539	100.00	4,621,163	100.00
Revenue from selling goods and providing services	481,184	4.57	59,952	1.03	90,165	1.55	101,551	2.20
Revenue from the budget as per special regulations	8,564,828	81.28	5,440,642	93.22	5,174,487	88.76	4,056,704	87.79
Revenue from assets	10,428	0.10	7,119	0.12	8,455	0.15	9,326	0.20
Revenue from donations	791,305	7.51	187,508	3.21	553,870	9.50	444,920	9.63
Other revenue	690,264	6.55	141,241	2.42	2,562	0.04	8,662	0.19

Source: by the author according to data submitted by the Rijeka Sports Federation

It is clear from Table 4 that total revenue has been dropping drastically since 2009; in 2012 it dropped by as much as 56% relative to 2009. Considering the revenue structure, it seems that from the onset of the economic crisis the sports system has failed to adjust to new conditions and that substantial revenue from citizens and sponsors, the dominant consumers of goods and sports services, has been lost. This part needs to be specially looked at and analysed since revenue from goods sold and services provided represents the Federation's primary activity. A severe drop in revenue from goods sold and services provided was recorded in 2010 and 2011; 2010 saw as little as 12% of the revenue generated in 2009, and 2011, only 19%. Given the economic crisis, a reduction in revenue from donations is understandable considering that donations from companies and other legal persons prevail in the structure of revenue from donations. A downward trend in revenue from donations is evident: in comparison with 2009, revenue from donations decreased by as much as 76% in 2010 and by 44% in 2012.

Conclusion

Under the impact of the economic crisis, public sources of financing from the budgets of towns, municipalities, counties and the state, intended for the operation of associations, are increasingly shrinking. The sports sector at large is directly affected through the loss of substantial funding. Clearly, the economic crisis has dealt a severe blow to the sports systems and caused revenue to drop. Data analysed in this paper indicate that the structure of financing sports associations in Primorje-Gorski Kotar County has changed in recent years. Data regarding the Town of Rijeka budget show that the amount of funds allocated to sports has been decreasing yearly. However, according to forecasts for 2014 and 2015, this situation is expected to improve because the amount of funding allocated to sports associations from the Town of Rijeka budget is planned to increase. Although the entire structure of funding sports associations has changed, it is a very important fact that efforts are being made within the programme of public needs in sports to maintain a balance for financing training for athletes as well as sporting competitions. In the example of the Rijeka Sports Federation, which brings together sports associations in the Rijeka, it has been noted that total revenue has dropped considerably. Especially disturbing in the revenue structure is the fact that revenue from goods sold and services rendered is steadily falling. Revenue from donations has also decreased, which is fairly understandable given the economic crisis. In recent years the sports system has fallen into a financial crisis and is struggling with limited funds. Sporting activities require continuous investment in equipment and grounds, and in the training and specialization of athletes, which is not possible without money. These activities, in which people – professional athletes and coaches – are the key, cannot just stop and wait for better times because every delay and every sports training in poor conditions represents a potential danger to athletes in the form of injuries, loss of physical fitness, etc. To enable the sports financing system to maintain long-term financial stability, research is required that will indicate on which type of revenue the sports sector should focus.

References

1. Bartoluci, M., Škorić, S. (2008). Uloga menadžmenta u sportskoj rekreaciji. Proceedings book of 17th Summer school for kinesiologist of the Republic of Croatia, Poreč.
2. Bartoluci, M., Škorić, S. (2009). Menadžment u sportu. Zagreb: Odjel za izobrazbu trenera, Kineziološki fakultet Sveučilišta u Zagrebu.
3. Bežovan, G., Ivanović, M. (2007). Razvoj civilnog društva u Hrvatskoj. Zagreb: United Nations Development Programme.
4. Bežovan, G., (2000), "Struktura civilnog društva u Hrvatskoj" *Politička misao*, 39(1), pp. 63-87.
5. Državni zavod za statistiku; *Statistički ljetopis 2011. godine* (http://www.dzs.hr/Hrv_Eng/ljetopis/2012/sljh2012.pdf) (accessed 7.12.2013.)
6. Državni zavod za statistiku; *Kultura i umjetnost u 2010. godini* (http://www.dzs.hr/Hrv_Eng/publication/2011/SI-1447.pdf) (accessed 13.12.2013.)
7. Grad Rijeka, www.rijeka.hr (accessed 10.12.2013.)
8. Petry, K., Steinbach, D., Tokarski, W. (2004), Sport system in the countries of the European Union: similarities and differences, *European Journal for Sport and Society* 1(1), pp.15-21.
9. Primorsko-goranska županija, (2013) "*Strategija razvoja zdravstvene industrije Primorsko-goranske županije 2013. – 2010.*", Rijeka.
10. Riječki sportski savez, www.rss.hr (accessed 10.12.2013)
11. Zakon u udugama (2002), Narodne novine, br. 88/01, Zagreb, (<http://narodne-novine.nn.hr/clanci/sluzbeni/233067.html>) (accessed 5.12.2013)
12. Zakon o športu (2006), Narodne novine, br. 71/06, Zagreb, (<http://narodne-novine.nn.hr/clanci/sluzbeni/127447.html>) (accessed 4.12.2013)

ECONOMIC IMPACTS OF FIFA WORLD CUPS

Alen Jerkunica, Ivana Jadrić and Josip Zec

University College of Sports Management Aspira, Split, Croatia

Abstract

Football is “the most important secondary thing in the world” and as such it has become a significant economic sector and a crucial source in many funding instruments. The euphoria that is generated when a national football team takes part in a world championship brings along certain financial investments. The impact is not only of a financial nature, but its implications are also relevant in the psychological context; both regarding the host country as well as all other teams that compete in the championship. The feeling of unity and solidarity, and the fighting spirit, that appear in the football team and during the games create a certain force. In this study, the authors do not focus on the psychological connotations that a football championship creates but rather on the effects that are realized in the field of economy. In the introduction, the emphasis is on the significance of football among different sports. The authors then give an overview of the largest sporting event – The World Cup. After that authors give an overview of various research studies concerning economic impacts of sport events with main conclusions.

Key words: *world football championship, economic impact, tourism*

The importance of football in the sports business

The importance of sport for individuals as well as whole nations can be seen throughout history, from the Ancient Greece and Olympic Games to numerous sports competitions and associations.

The power of sport is reflected in the number of positive implications for the economy, such as strengthening the nation's health, social background, international reputation and affirmation, as well as national pride (Selhanović, 2007).

The highest level of the development of sport is when a young generation accepts sport as its way of life and its profession. After school sport is spread to broader nation, associations and clubs are established, which then form federations. The aims of modern sports are outplaying, awareness of the power and ability, collectivism, the role and position of a leader, and education for leadership. It is a means of communication, affirmation of individuals, as well as the whole society, nation, country, and politics. It is also a tool for developing desirable personality traits, teaching forcefulness and competitiveness, as well as a means for propaganda (Banović, 2011).

Tomić (2007) claims that sport is a type of a game which is a characteristic activity in itself, because participating in it is voluntary; it is an institutionalised game because it represents a form of social structure and culture; as well as a social institution in itself, and a form of sociability in which human communication takes place.

Football occupies the throne amongst sports, since it is estimated that over several hundred million people plays it as amateurs or professionally. Although the origins of football are related to China, it is officially considered that modern football originated in England (the University of Cambridge) in the year 1848, when the first football rules were written. The oldest football club in the world, Sheffield FC, was established in 1855. The first official international game was played in 1872 between Scotland and England on a cricket court West of Scotland, and in 1885 professional engagement in football was legalized (Baddiel, 1997). Football was rapidly expanding outside of England, and at the beginning of the 20th century, there was the need to establish an executive body that would be at the forefront of the world of football. FIFA (Fédération Internationale de Football Association), the main executive body in football, was established in Paris on 21 May 1904, and it included seven member states: Belgium, Denmark, France, Netherlands, Spain, Sweden, Switzerland. The first known football transfer was recorded in 1905, namely, it was the transfer of Alf Common from Sunderland to Middlesbrough for 1,000 pounds (Radnedge, 2005). The Croatian Football Federation has been a member of FIFA since 3 July 1992, while it was admitted to full membership in UEFA (Union of European Football Associations) on 17 June 1993.

World Cup and its significance

The World Cup is one of the most important sporting events in the world. The first world football championship was organized in Uruguay in 1930. Uruguay and Argentina played in the finals, and Uruguay won the match at the stadium in Montevideo before 93 000 spectators. 76 years later, it is estimated that over 715 million people watched the World Cup finals in Germany. Considering that sports management represents a force which organizes and constitutes basic

and integral component of every sports organization (Tomić; 2007), it is clear that football and football championships need to be managed, and they are therefore held under the supervision of FIFA (Fédération Internationale de Football Association), and imply participation of 32 qualified male football national teams competing for their nation's colours. World Cup is being organized since 1930 every four years. FIFA's mission is to "Develop the game, touch the world, build a better future".

Due to the large number of football fans, FIFA commits to preserve the rules of the game, develop it, and make it closer to those in less privileged places in the world. The main goal is developing a better future for football and increasing its popularity.

Considering the number of spectators of the World Cup is increasing drastically, promotion and willingness of advertisers to pay higher advertising price increase accordingly (Novak, 2008).

The evidence that this is the most important sporting event in the world is the official data published by FIFA saying that the World Cup in Germany was watched by 3,353,655 spectators, i.e. the average of 52,401 per game, while more than 40 billion people watched the matches on TV (www.fifa.com). Television broadcasting of FIFA World Cup™ 2006 was the most extensive in the history of broadcasting World Cup matches. The matches were broadcasted on 376 channels in over 214 countries, with the overall coverage of 73,072 hours. It needs to be pointed out that there was a 76% increase in television coverage in comparison to the same event in 2002. In the final match of the FIFA World Cup South Africa 2010, on the other hand, there was a 5% increase compared to the year 2006.

Moreover, a number of studies have been made regarding the benefits the host country has from organizing a large sporting event such as the World Cup. Based on such studies, the chief executive of the South African World Cup 2010 Organizing Committee, Danny Jordan, states, "The World Cup is about nation building, it's about infrastructure improvement, it's about country branding, it's about repositioning, it's about improving the image of our country, and it's about tourism promotion. It's also about return on investment, job creation and legacy. These are the things that drive not only our nation but the nations of the world" (Allmers and Maening, 2009). According to Maening (2007), the most important benefit Germany had from the World Cup 2006 was the feel-good effect and the improvement of the image of the country. Furthermore, people will support the organization of major sporting events if it is perceived as an opportunity to improve the infrastructure, and especially as an opportunity to improve their recreational activities.

The Croatian national team is playing the opening match of the World Cup 2014 in Brazil against the host team. This match will be watched by over a billion spectators all over the world; hence, the publicity for Croatia is enormous, and most importantly completely free. It goes without saying that many people who have never heard about Croatia will probably google it for the first time. In this regard, we should not neglect the positive effect this will have on the Croatian tourism in the future, primarily through the increase in the number of guests from Brazil.

Influence of the World Cup on the economy of the host (positive and negative implications)

Ever more nations and cities apply to stage mega sporting events. The most challenging bid procedures are those for Olympic Games and the FIFA and UEFA football tournaments. One reason to enter the costly bidding process is the prospect to attract autonomous money and to speed up the infra-structural development of the host city and region (Preuss and Schütte, 2008).

Organizing the World Cup is a very extensive work for the host country, but it represents an important investment of which the greatest benefit is creating the image of the country and its branding. What the organization of such championship entails is opening new workplaces, as well as organizing the necessary infrastructure for the competition such as construction and renovations of stadiums. Furthermore, great emphasis is placed on the investment in the traffic infrastructure. The economic benefits of organizing such a large competition arise from two sources of additional consumption: expenditures of tourists, and consumption related to the organization and preparation of the event (Saayman and Rossouw, 2008). Due to the large inflow of visitors, the host country achieves significant increase in the number of booked accommodations, which has a positive effect on its tourism, since tourism is the industry that has long-term benefits from organizing large sports competitions. Research shows that tourists who come to the World Cup spend 1.8 times more than those who travel on vacation (Lee and Taylor, 2005).

A certain increase in profit has an impact on the beer industry, textile industry, souvenir shops, restaurants, tourist agencies, TV stations, caterers, betting as well as many others who are directly involved in the World Cup. Furthermore, great emphasis is put on the investment in traffic infrastructure. Due to a large inflow of visitors, there is a significantly larger number of nights per stay, which positively affects tourism of the host country, since tourism is the branch of economy that has long-term benefit from organizing a large sporting event, although increase in the number of visitors does not necessarily mean increase in the number of nights. According to the available data of the Institute of Sports Economics in Vienna, the championship in Austria in 2008 generated the additional effect on economy worth 641 million Euros (Helmenstein and Kleissner, 2008). A former football player and the ambassador of South African Committee for getting the 2010 World Cup, Mr Gary Baily, concluded there are five industries that have the greatest potential for quick financial income, namely: restaurants, hotels, airline companies, insurance companies, and construction companies

(Saayman and Rossouw, 2008). Baily reported that in the 2002 World Cup in Korea and Japan only the insurance industry made profit, while other four industries did not benefit from it even though the event generated the economic impact in the amount of 1.35 billion US-\$ from sales, 307 million US-\$ of direct income from competition, and 713 million US-\$ in added value for South Korea.

However, not all the implications of football championship to economy are positive. Research show that large sports competitions can have unequal benefits for different countries. For instance, the World Cup held in the USA in 1994 was rated as a great success; there were approximately 3.5 million spectators, who left the organizers with great profit (Loots, 2006). However, Loots states that nine host cities suffered losses from participating in the organization, and only four cities achieved profit. Even during the World Cup 2006 in Germany, when the restaurant owners, traders, and transport companies earned a lot of money, gross national income additionally increased for only 0.13%. What was more important was the effect on tourism, i.e. the number of visitors and their positive impressions, which influence the positive branding of the host country, which is than in the centre of the world's attention.

Although tourism is a great benefier, certain negative effects on tourism have to be considered, for example the crowding-out effect. The crowding-out effect occurs when those who are not related to or interested in the event, give up going to the destination due to objective and/or subjective restrictions caused by the World Cup (Preuss, 2010). Crowding-out can occur due to real or perceived limited accommodation, transportation (in particular air fare to South Africa) or other factors such as crime rate, overcrowded city centres or tourism attractions. In other words crowding-out is not limited to increased prices. A deterrent (effect) for non-football tourists can be based on perceptions relating to limited hotel rooms and high hotel prices, drinking behaviour, fan violence and hooliganism, and peak use of public goods such as highways (Baade and Matheson, 2004).

Influence of the World Cup on the participating countries (comparison with the Champions League)

Due to its popularity, football is nowadays considered far more important ambassador of a country than politics. National team's participation in the World Cup is positively reflected on every nation that participates in it, both financially and psychologically, because, as mentioned in the introduction, it strengthens the unity of citizen, who therefore gain more self-esteem, which results in them buying more products and services, thus strengthening the domestic economy. Furthermore, the fact that a country participates in the World Cup brings multiple benefits: from the promotion of tourism, concluding new business contacts, strengthening international cooperation, attracting potential investors, etc.

MasterCard research conducted by distinguished professors from Coventry College, Simon Chadwick and Paul Meulendijk, Chairman of the Department of Sponsorship at MasterCard Europe, show that the annual value of UEFA Champions League can be compared to the profit of the participants in the World Cup in Germany. UEFA rewards every football team that qualifies in Champions League with 3.8 million Euros, which amount is increased for additional 550,000 Euros per match as a team progresses in the championship. UEFA furthermore increases this amount for a reward of 3.3 million Euros for participating in the quarterfinals, 4 million Euros for the semi-finals, 5.2 million Euros for the finals, and 9 million Euros for the winner of the finals. In the end, when all the profits are taken into consideration (UEFA participation rewards, commercial profit from the tournaments, ticket sale, sponsorship, and other profit from marketing, food and drinks), it is estimated that participating in this kind of championship earns a club around 50 million Euros. On the other hand, it is estimated that in the European Championship 2008 held in Austria and Switzerland, each match played by the Croatian national team earned the Croatian economy 42 million Euros on average (Sportbusiness.com, 2008). It has to be noted that further participation in the competition means increasing the amount of profit. Apart from the participation rewards, the teams make profit from sponsorship, marketing contracts, etc.

Conclusion

It is a fact that football as “the most important secondary activity in the world” and the most important sport nowadays has a significant influence on the economy, especially when it comes to the most watched sporting event in the world. It is undisputed that there are multiple implications reflecting certain branches of economy. The economic benefits of organizing such a large competition arise from two sources of additional consumption: expenditures of tourists and consumption related to the organization and preparation of the event. Considering the information presented in the article, we can conclude that it is in the interest of every country to participate in the World Cup, and to achieve the best possible placement in it.

References

1. Allmers, S. and Maening, W. (2009). Economic impacts of the FIFA Soccer World Cups in France 1998, Germany 2006, and outlook for South Africa 2010. *Eastern Economic Journal*, 2009, 35, pp. 500-519.
2. Baddiel, I. (1997): *Nogomet najbolja igra na svijetu; Naša djeca*; Zagreb
3. Baade, R. and Matheson, V. (2004). The quest for the cup: Assessing the economic impact of the world cup. *Regional Studies*, 38(4):343-354.
4. Banović, I.(2012): *Povijest sporta; Visoka škola za sportski menadžment Aspira; Redak; Split.*
5. Helmenstein, C.; Kleissner, A.(2008): *Economic Effects of the UEFA EURO 2008 in Austria*, SportsEconAustria, Institute for Sports Economics, Vienna
6. Lee, C. and Taylor, T. (2004). Critical reflections on the economic impact assessment of a mega-event: the case of 2002 FIFA World Cup. *Tourism Management*, 26:595-603.
7. Loots, E. (2006). The 2010 Soccer World Cup: An economic and socio-economic perspective. *DiscourseDiskoers*, 34(2).
8. Maennig, W. (2007). One year later: A re-appraisal of the economics of the 2006 soccer World Cup. *North American Association of Sports Economists. IASE/NAASE Working Paper Series, Paper No. 07-25. July 2007.*
9. MasterCard press release: <http://newsroom.mastercard.com/press-releases/europe%E2%80%99s-leading-clubs-scoop-average-of-e50-million-for-reaching-uefa-champions-league-knock-out-stage-according-to-mastercard-study/> (01.03.2014.)
10. Novak, I. (2008.): *Role and place of sport as a medium in sport management; 5th International Scientific Conference on Kinesiology, 2008, Zagreb, Croatia; str.341-344*
11. Preuss, H. (2010). The measurement of crowding-out at the FIFA Football World Cup in South Africa 2010, *Mainzer Papers on Sports Economics & Management*, 2010.
12. Preuss, H. and Schütte, N. (2008). *Football-Tourists and Their Contribution to the Economic Impact - Evidence from EURO 2008 in Austria/Switzerland*, European Association for Sport Management Conference, 2008, Heidelberg, Germany
13. Radnedge, K. (2005.): *Enciklopedija nogometa; Znanjed.d.; Zagreb (str. 14-16)*
14. Saayman and Rossouw, (2008). *The economic value of the 2010 soccer world cup, Acta Commercii 2008*
15. Selhanović, D. (2007.) ; *Zavod za međunarodnu naučnu, prosvjetno-kulturnu i tehničku suradnju Vlade Crne Gore, Odbor za pravne i političke nauke Crnogorske akademije nauka i umjetnosti; MEDIANALI ; Vol.1 No.1.*
16. Sportbusiness.com, *European Economy to Receive €1.4 Billion Boost from UEFA EURO 2008™*, <http://www.sportbusiness.com/news/163041/european-economy-to-receive-1-4-billion-boost-from-uefa-euro-2008, 2007>.
17. *The Official FIFA World Cup 2006 Report*: http://www.fifa.com/mm/document/fifafacts/ffprojects/ip-401_06e_tv_2658.pdf; 01.01.2014.
18. Tomić, M.(2007): *Sportski menadžment; SP Print; Beograd; str. 5-6*

THE STRATEGIC ORIENTATION AND PERFORMANCE OF FOOTBALL CLUBS

Eli Marušić¹, Katija Kovačić² and Duje Petričević²

¹University of Split, Faculty of Maritime Studies, Croatia

²University of Split, Faculty of Kinesiology, Croatia

Abstract

Dynamic changes and environmental uncertainty, as well as the global economic crisis, significantly influence the sport clubs management to continuously make strategic decisions and adapt their organizations to the environment. Miles and Snow's (1978) typology of strategic orientation has been successfully used in many research on strategy and performance of various organisations, across many industries worldwide. The choice of specific solutions to a set of strategic problems forms a type of strategic orientation, and significantly influences organizational performance. This paper explores the strategic behaviour of football clubs and the influence of strategic orientation on their organizational performance.

Key words: *strategic behaviour, strategic types, sport clubs*

Introduction

The football clubs, as extremely profitable sport organizations that compete in various sport markets (professional and amateur players, sponsors, supporters, football fans, children interested in playing the sport and their parents, media, etc.) are significantly influenced by their continuously changing environment. Environmental changes influence operations and overall performance of sport organizations. Therefore, sport organizations are forced to continuously adapt to the changes in their environment. Strategic orientation refers to a specific organizational behavior adopted with regard to environmental changes. The differences in strategic behavior of organizations in the process of adaptation to their environment have been theoretically recognized and empirically tested. Miles and Snow's typology (1978) and Porter's typology (1980) represents two dominant theoretical frameworks for strategic orientations (Slater, Olson & Hult, 2006; Hambrick, 2003). The typology of Miles and Snow (1978) is used in numerous research on strategic behavior of various organisations worldwide (e.g. Conant et al, 1990; Shortell & Zajac, 1990; Zahra & Pearce, 1990; Veliyath & Shortell, 1993; Slater & Olson, 2001; Slater et al, 2006; Hambrick, 2003). In their theoretical framework, Miles & Snow identified four different types of strategic orientation - *prospector*, *defender*, *analyzer* and *reactor*, each represented by a distinguished pattern of organizational adjustment to continuously changing environment. According to Miles & Snow (1978), the three stable strategic types - *defender*, *prospector* and *analyser* all exhibit equal capabilities for achieving high performances, which are always superior to the performance of unstable reactors. Over the years, Miles & Snow's typology has been validated in numerous researches on the relationship between strategic orientation and organizational performance (Conant et al, 1990; Zahra & Pearce, 1990; Hambrick, 2003; Slater et al, 2006), and therefore presents useful framework for the research of the strategic orientation and performances of football clubs. Considering the fact that the influence of strategic orientation on the performances of football clubs has not been explored yet, the main question of this research is as follows: *What is the impact of a strategic orientation on the performance of football clubs?* The research conducted sampled two successful football clubs in the Republic of Croatia, identified their strategic orientation type, as well as determined the relationship between their strategic orientation and performance.

Theoretical background and research goals

The organisations operating in the sport industry are continuously faced with dynamic changes, uncertainty and growing competition, which ultimately creates a challenge to their market survival and success. The strategic orientation indicates the existence of a certain organisation's tendency toward determining, developing and maintaining a specific set of consistent responses to various environmental changes (Miles & Snow, 1978). The theoretical framework laid out by Miles & Snow (1978) represents the most important system of strategy classification (Hambrick, 2003).

In their theoretical framework, Miles & Snow explained specific strategic behavior of organizations during the dynamic and continuous process of organizational adaptation to the changing environment. The process of organisational adaptation (*adaptive cycle*) the authors divided into the three major problems which organizations must continuously solve - entrepreneurial, engineering and administrative problems. The entrepreneurial problem involves a concrete definition of organizational product-market domain, the engineering problem involves a selection of the technology and processes for producing and distributing the chosen products and services, and the administrative problem involves a

selection, rationalization and development of the chosen process and structure. Miles & Snow (1978) proposed a strategy classification of four distinct types (*defenders, prospectors, analysers* and *reactors*). These represent four specific strategic behaviour patterns and are dependent on how a particular organisation defines its product-market domain and also in what way it creates its structure and processes. *Prospectors* are in continuous search for new market opportunities, quickly respond to the environmental changes and adopt new ideas and innovations. They invest into new products, services and markets, and tend to continuously modify their product-market domain. *Prospectors* are primarily focused on a high level of effectiveness. In contrast to *prospectors*, *defenders* tend to obtain the maximum operational efficiency. In order to achieve this particular strategic goal, *defenders* offer a limited range of products and services to their narrow target markets, thus trying to keep their product-market domain relatively stable. They tend to be highly proficient within their limited business area, tending not to expand beyond their initial domain and thus not seek out new market opportunities. The *analysers* act simultaneously as both extreme strategic types (*defenders* and *prospectors*), they trying to balance between the operational efficiency and market effectiveness. Therefore, they tend to maintain a dual product-market domain, one stable, and the other innovative. In their stable product-market domain they act more like internally oriented *defenders*, trying to reach the maximum level of operational efficiency in their core business, while, at the same time, quickly adopting the most promising innovations of the leading *prospectors*. In contrast to *prospectors*, *defenders* and *analysers*, *reactors* are organisations without an apparent and consistent strategic behaviour. They are unable to both, efficiently and effectively respond to any environmental changes, reacting only when forced by the overwhelming environmental pressure.

The theoretical framework of Miles & Snow (1978) is a useful tool for anticipating the organisational success and performances. The organisations that consistently follow one of the three stable strategic options – *prospector*, *defender* or *analyser*, always have a better performance rate than unstable *reactors* (Miles & Snow, 1978), which is mostly confirmed by various empirical researches (Shortell & Zajac, 1990; Zahra & Pearce, 1990; Slater & Olson, 2001; Hambrick, 2003). Regardless of the typology's general acceptance among scholars, as well as its successful validation by numerous empirical researches, the Miles & Snow's typology needs to be tested further, in order to obtain more information on the relationship between strategic orientation and performance.

Methodology and results

The research of the influence a strategic orientation has on the football club's performance is realised by using the case study method. The data concerning the strategic orientation and performance of football clubs are obtained by in-depth interviews with sport managers and by collecting available secondary data. The strategic orientation of football clubs has been identified according to a set of relevant strategic variables (strategic intent, dominant strategic goals and strategic response to the environmental changes). The performance of football clubs has been assessed on the basis of four revenue indicators and two cost indicators (Table 1).

The research is based on a sample of clubs that participate in the highest level of national football competition, are of the same legal status (namely, joint-stock sport companies), varying budgets and a dissimilar ownership structure (privately owned vs. publicly owned). The sport clubs sampled develop relatively identical types of products and services (football matches, professional players and teams, branded products, youth sport education, etc.), competing in almost identical sport markets (professional players and coaches, young players, media, sponsors, youth sport schools, etc.). Therefore, the sampled football clubs have quite comparable product-market domains. The current environmental conditions, characterised by continuous increase in competition, changeable customer needs and the decreased cash flow from the existing financing sources (government budget, media rights, etc.), force the clubs to focus more toward the market. Therefore, the process of managing the players (buying, developing and selling them) and valorisation of the first team on the football market, are the two dominant means of securing sufficient funds for the club's operating activities.

Along the incomes obtained from selling players, which is the most important and dominant form of income, the clubs also generate income by sponsorship contracts, co-branding arrangements, entrance tickets, subscriptions, membership fees, by selling branded merchandise in fan-shops, etc. Although the trading of the football players is the most important source of income, during the recession period it alone is insufficiently profitable to meet all the club's financial needs and ensure both efficient and effective operation. The sport clubs are thus forced to seek out new financing means and resources. In the cost structure of the clubs which consists of several items, the costs of the first team salary present the most dominant item significantly overshadowing the costs of training process, competition costs, support staff costs, licensing costs, maintenance costs, administrative costs and the cost of furnishing sport facilities.

The research results indicate that both sampled clubs have a clearly stated strategic intent, a defined primary strategic goal, as well as the planned strategy. The decisions concerning the strategic intent, the strategic goals and the chosen strategic orientation are made on the highest level of management. Furthermore, the strategic intent, goals and orientation are clear and uniformly consistent for all the organisational levels and every shareholder group. The club designated as Alpha is simultaneously focused on achieving the cost reduction, resources rationalisation, and implementation of new and innovative business solutions, i.e. on two competing strategic goals, effectiveness and operational efficiency. When

adapting to the environmental changes, Alpha strives to use advantages of the existing market situation, improving on the existing products and services, technologies and processes, all the while timely responding to market trends and changes by implementing innovative business solutions. Namely, Alpha has reduced the employee count, capped the contracts with professional players, improved the overall team quality and enhanced the technology of internal and external communication and information systems, such as the information exchange system between the sport scouts and the club.

This period was also marked by the implementation of a few innovative marketing solutions (co-branding arrangements) and sales (introducing new sales channels for branded products, devising subscriptions for different target groups). The research results indicate that Alpha conducts its strategic behaviour in a pattern attributive to the analytical strategic orientation. On the other hand, Bravo is focused on seeking out new market opportunities, new technologies and processes, as well as the development of innovative business solutions for every business level. During the scrutinised timeframe, Bravo has, for instance, implemented innovative solutions for the training process and marketing (i.e. the purchase of an Internet portal), launched subsidiaries operating in new locations (thus entering the previously unoccupied market niches), as well as intensively investing in modern equipment, building of new sport and recreational facilities and the preparation of the project of building a new sport and business complex located next to the stadium. When considering the behaviour patterns of organizational adaptation to the environmental changes, Bravo is quite consistent with the characteristics of the prospector strategic orientation.

The research results also indicate that, regardless of the primary strategic orientation, both Alpha and Bravo share characteristics of the two opposite strategic types, defender and prospector. When considering the strategic activities affiliated to products and markets (the decisions concerning the product-market domain, as well as the innovations of the existing business processes), both of the clubs act as defenders, thus striving to standardise the sale assortment, improve quality (for instance, the quality of players, teams and football matches as their fundamental products), as well as strengthen their market position in the existing target markets. On the other hand, when considering the strategic activities concerned with technology and application of new processes, the clubs act as prospectors, developing innovative business solutions that serve to improve information systems, sales and marketing performances.

Table 1: The research results

CLUB ALPHA	I. General data	CLUB BRAVO
Joint-stock sport company	Legal status	Joint-stock sport company
Public	Ownership	Private
10 million EUR	Budget	3 million EUR
CLUB ALPHA	II. Strategic intent, goals and orientation*	CLUB BRAVO
Clearly expressed	1. Strategic intent	Clearly expressed
Efficiency and effectiveness	2. Primary strategic goal	Effectiveness
Continuous search for new market opportunities, while taking advantage of the existing market situation	3. The strategic behavioural response to the environmental changes	Continuous search for new market opportunities
Analysed	4. Strategic orientation	Prospector
CLUB ALPHA	III. Performances**	CLUB BRAVO
	1. Revenues	
a) 1 2 3 4 5	a) Subscription and ticket income	a) 1 2 3 4 5
b) 1 2 3 4 5	b) Player sale income	b) 1 2 3 4 5
c) 1 2 3 4 5	c) Sponsorship income	c) 1 2 3 4 5
d) 1 2 3 4 5	d) Youth football schools income	d) 1 2 3 4 5
	1. Costs	
a) 1 2 3 4 5	a) Team cost	a) 1 2 3 4 5
b) 1 2 3 4 5	b) Total cost	b) 1 2 3 4 5

* during the last 3 years (2011-2014)

** during the last year; (Five-point scale, where 1=decline, 3=stagnation, and 5= growth)

Alpha and Bravo clubs have achieved quite various performance levels (Table 1: The research results). The results in the income category indicate that the performance achieved by Bravo (prospector) grew quicker than those of Alpha (analyser). However, Alpha which has invested considerable resources in improving existing relationships and fan and supporter communication, during the scrutinised time period, managed to achieve greater income in individual income categories (the ticket and subscription fees), thus ensuring a greater relative growth with regard to Bravo. Additionally, Alpha had better costs performance than Bravo. Alpha costs have diminished or stagnated, while the costs of Bravo have significantly increased. With the aim of improving the, initially, unfavourable market position, Bravo invested significant assets into all the business segments (the management of the first team, marketing, stadium conditions, entering new markets, etc.), thus generating above average costs when compared to the rest of the sector.

Conclusion

The research results confirm that, by using Miles & Snow's (1978) typology, determining a strategic orientation of a particular sport organisation is a feasible attempt. Based on a few strategic variables (the strategic intent, primary organisational goal, response to environmental changes, product-market domain), the conducted research indicates that the sampled football clubs primarily act as analysers (club Alpha) and prospectors (club Bravo). Furthermore, the results indicate that, regardless of the prevalent pattern of their strategic behaviour (strategic orientation); the sampled clubs exhibit certain characteristics of both opposite strategic types – defenders and prospectors. Alpha optimally combines the characteristics of defender and prospector, and is equally focused on the efficiency and effectiveness. Therefore, Alpha is able to successfully control all the costs, but it has a lower income growth than the other club. On the other hand, the club significantly behaving as a prospector (Bravo) is dominantly focused on the effectiveness and is thus forced to increase investment into innovations, growth and development. Prospector on average has better income performance; however, it is exposed to a significant cost growth. The research results are in accordance to the results of previous research and the theoretical postulates describing the relationship between strategic orientation and performance, thus representing the implementation of an existing theory to a specific sport club market.

Finally, it is necessary to point out a few significant limitations to this research: (1) a small sample hindering the formation of general conclusions, (2) the subjectivity of the interviewed sport managers and experts when assessing the questioned variables and (3) the specific research methodology which ensured the basis for future research. The guideline characteristics of advised future research is as follows: (1) obtaining a larger sample of sport clubs both from the Republic of Croatia, as well as other SE Europe countries, (2) applying the quantitative research methods, and (3) linking the concept of strategic orientation to the objective indicators of the sport club's performance.

References

1. Conant, J. S. and M. P. Mokwa, and P. R. Varadarajan (1990). Strategic Types, Distinctive Marketing Competencies, and Organizational Performance: A Multiple Measures-Based Study. *Strategic Management Journal*, 11(5), pp. 365–83.
2. Hambrick, D. (2003). On the Staying Power of Miles and Snow's Defenders, Analyzers, and Prospectors. *Academy of Management Executive*, 17(4), pp. 115–18.
3. Miles, R. E. and C. C. Snow (1978). *Organizational Strategy, Structure, and Process*. New York, McGraw-Hill.
4. Shortell, S. and Zajac, E. (1990). Perceptual and Archival Measures of Miles and Snow's Strategy Types: A Comprehensive Assessment of Reliability and Validity. *Academy of Management Journal* 33(4), pp. 817–832.
5. Slater, S. and Olson, E. (2001). Marketing's contribution to the implementation of business strategy: an empirical analysis. *Strategic Management Journal* 22(11), pp.1055–1068.
6. Slater, S. and Olson, Eric M. and Hult, Tomas M. (2006). The moderating influence of strategic orientation on the strategy formation capability–performance relationship. *Strategic Management Journal* 27, pp. 1221–1231.
7. Snow, C. and Hrebiniak, L.G. (1980). Strategy, Distinctive Competence, and Organizational Performance. *Administrative Science Quarterly* 25(June), pp. 317-336.
8. Veliyath, R. and S. Shortell (1993). Strategic orientation, strategic planning system characteristics and performance. *Journal of Management Studies* 30(3), pp. 359–381.
9. Zahra, S. A. and Pearce, J. A. (1990). Research Evidence on the Miles-Snow typology. *Journal of Management* 16(4), pp. 751-768.

SPORTS FACILITY MANAGEMENT – CASE STUDY: MULTI-PURPOSE HALL / ICE RINK IN DELNICE

Marko Perić¹ and Nensi Puškarin Radun²

¹*Faculty for tourism and hospitality management, Opatija, Croatia*

²*Goranski sportski centar Ltd., Croatia*

Abstract

Sport in modern tourism has become an important content of stay and, in many cases, the needs for provision of sports facilities and services within tourism have increased. Therefore, providers of facilities for sports services should seek to improve their efficiency and effectiveness. The aim of this paper is to analyse the importance of managing sports facilities for sports and tourism markets and provide new insight on organising the sports offer in the destination. A case study method is used for holistic and in-depth analysis on a real sports facility – the Multi-purpose hall / Ice rink in Delnice. In addition to describing the current situation, the analysis will include major difficulties in daily functioning, potential cooperation and investment required to meet the standard set by the specific market niche.

Key words: sports experiences, tourism, strategies

Introduction

The relationship between tourism and sport is not new and was analysed by many authors over more than half a century (Hunziker, & Krapf, 1942; Anthony, 1966; Glyptis, 1982; Standeven, & De Knop, 1999; Hinch, & Higham, 2001; Keller, 2002; Turco, Riley, & Swart, 2002; De Knop, & Van Hoecke, 2003; Bartoluci, 1995; 2003; Weed, 2001; Weed, & Bull, 2009; Sobry, 2011; Radicchi, 2013). Their analyses indicate that tourism and sport are two cognate and closely interrelated social phenomena. Indeed, Keller (2002) concluded that tourism, as an experience-oriented activity, and sport, as a performance-oriented activity, are very much like Siamese twins. Active or passive participation in sports or athletic activities can provide tourists (both day and overnight visitors) with extraordinary adventures and experiences. In addition, types of sporting activities and the unique experiences that are expected from these activities directly affect the tourists when choosing the destination (Weed, & Bull, 2009; Perić, 2010).

Nevertheless, one cannot forget the fact that sports experiences arise from a unique interaction of people, activities and places (Weed, & Bull, 2009), where places could take the form of a natural or artificial, outdoor or indoor sports facility. The importance of sports facilities in the creation of overall sports tourism experiences was also highlighted by other authors. For instance, Greenweel, Fink and Pastore (2002) found physical facility, Harrison-Hill and Chalip (2005) found quality of infrastructure, and Högström, Rosner and Gustafsson (2010) found physical service environment as key factors that have a major influence on customers' experiences and satisfaction.

Therefore, these findings indicate the need for management of sports facilities which become an integral part of sports management (Bartoluci, 2003; Arthur, 2010; Fried, 2010; Schwarz, Hall, & Shibli, 2010; to list only a few). Sports facility managers will need to acquire a wide variety of managerial skills and knowledge in order to be adequately prepared to plan, construct, promote and manage these facilities.

The aim of this paper is to analyse the importance of managing sports facilities for sports and tourism markets, and to provide new insight into the organisation of the sports offer in the destination. Theories and concepts are brought to life by using a case study method.

The paper is divided into three sections. The first presents a brief description of the current status of the Multi-purpose hall / Ice rink in Delnice, including the major difficulties in its daily operation. In the second section, strategies in order to create the facility and make the facility manager more successful are proposed. The paper finishes with concluding remarks.

Current status of the Multi-purpose hall / Ice rink in Delnice

The Multi-purpose hall / Ice rink in Delnice was built in 2008 and funded by the European Union, with the Primorsko-goranska County and the City of Delnice as partners. Other partners were Goranski sportski centar Ltd and the Tourist Board of Delnice. The Multi-purpose hall is currently managed by the Goranski sportski centar Ltd and is opened all year round (as ice rink during the winter months or as a concrete playground during the summer months). The facility occupies a total area of 1,800 square meters. It includes the catering facility, locker rooms, a storage, as well as a parking

lot. It is well connected with major regional centers such as the City of Rijeka (30 minutes by car) and the City of Zagreb (60 minutes by car), and easily accessible by train or road.

Table 1: SWOT analysis of the Multi-purpose hall / Ice rink in Delnice

Strengths: Multifunctionality; roofed facility; the only one within a radius of 150 km (Zagreb); a small number of employees at the facility; possibility of year round use; proximity to major regional centres (Zagreb, Rijeka, Pula, Karlovac, Kočevje)	Weaknesses: High amounts of operating and maintenance costs (creation and maintenance of ice); low capacity utilization, under-skilled and non-continuous marketing
Opportunities: possibility for year-round operations; sports teams rent (lease); organisation of sports, tourism and other events; sale of advertising space	Threats: Creation of negative economic indicators because of the facility's expensive operation (electricity) and low sales prices of basic products

The business cooperation between Goranski sportski centar Ltd and its clients is based under the terms of a lease agreement (prior notification for groups or individual arrivals and single tickets). Travel agencies, primary and secondary schools as well as sports clubs and various associations are direct beneficiaries of its capacities. During the three winter months, the ice hockey club "Mamut" in Delnice uses the ice rink three days a week for two hours a day (six hours a week in total). Individual skaters are potential customers of the ice rink too and the capacity of the ice rink is 100 visitors per hour.

The price is 650.00 HRK per hour for the whole ice rink, 25.00 HRK per hour (includes skates) or 15.00 HRK per hour (with your own skates) for individual skaters. Comparing the prices for the whole ice rink between the Ice rink in Delnice (650.00 HRK per hour; possible discount) and the Ice hall in Zagreb (it is the closest to that of Delnice; 1,850.00 HRK per hour; no discount) a big difference in the price of rent between the two can be noticed. It could be explained by the type of building and full range of services offered (changing rooms, showers on site, etc.). Furthermore, the location itself (million people that gravitate to the area) enables the formation of a more economic price. Also, a higher concentration of sports clubs and the existence of various associations as potential clients provide a large membership, continuous visits and a higher capacity utilization. Therefore, the Ice hall in Zagreb cannot be considered as a direct competitor but it can be cited as an example of best practice.

Table 2 shows revenue structure of the Multi-purpose hall / Ice rink Delnice for the last four years. Approximately from 50 to 60 per cent of the total receipts in cash are collected during winter season by individual visitors (skaters). Daily average is between 45 and 55 skaters. Accordingly, operating costs are particularly high during the winter months (more than 35,000.00 HRK a month) and are manifested through large amounts of consumed electricity and water and costs for clearing snow around the building.

Table 2: Structure of the revenue collected at the cash desk of The Multi-purpose hall / Ice rink Delnice

Year	Winter period (01/12-31/03) – in HRK				Summer period (01/04-30/11) – in HRK				Total (wint. + summ.)*
	Individuals (tickets)	Groups (rent/hour)	Coffee bar	Total*	Individuals (tickets)	Groups (rent/hour)	Coffee bar	Total*	
2010	147.060	7.069	60.877	215.006	-	6.885	24.189	31.074	246.079
2011	146.999	11.864	63.552	222.415	-	12.544	24.309	36.853	259.268
2012	153.706	21.552	71.458	246.716	-	18.458	29.879	48.337	295.054
2013	114.835	11.583	62.569	188.987	-	16.589	32.998	49.587	238.574

* does not include transactions through bank accounts (mainly groups; contribute with an additional 20-25 per cent)

Its current utilization rate of only 35 per cent (on a yearly basis) is insufficient for planning any additional investments or for creating new values. However, the ability to modify its offer throughout the year provides a variety of options on the sports and tourism markets (renting to sports teams for training and competition purposes or for various events and manifestations during the summer and winter season). In the light of these possibilities we can deduce that it is necessary to change the existing business model, primarily in the form of adequate managerial and marketing activities. Moreover, taking into account the maintenance cost of the facility, especially in the winter period, several strategies could be considered in order to improve the performance.

Possible success strategies

Although contracts provide the basis for the preparation of the budget and the calendar of events in the facility, an offer must contain the basic prices and possible variations and discounts. The flexibility and the possibility of meeting the needs and desires of business partners should be involved in contracting, at least to the extent of covered operating

costs. Table 3 shows the possible clients and the associated discount. The offer applies only to the winter term (ice rink), while the summer term includes only the rental rate per hour, which amounts to 450.00 HRK per hour.

Table 3: Suggestions for possible cooperation

Contracting Party	Price per hour	Discount - percentage	Discounted price
Tourist agencies	650.00 HRK per hour 25.00 HRK per visitor	10% (up to 50 visitors) 15% (over 50 visitors)	585.00 HRK per hour 21.25 HRK per visitor
Sports clubs and associations	650.00 HRK per hour	5% (up to 10 hours per week) 10% (up to 15 hours per week) 15% (for seasonal rental)	617.50 HRK per hour 585.00 HRK per hour 552.50 HRK per hour
Individual visitors	25.00 HRK per hour	Monthly ticket: 10% (for 20 visits) 15% (for 30 visits)	22.50 HRK per visit 21.25 HRK per visit
School institutions	25.00 HRK per visit 650.00 HRK per hour	10% (per visit) 15% (per hour)	22.50 HRK per visit 552.50 HRK per hour
Civic associations / organised groups	25.00 HRK per visit 650.00 HRK per hour	10% (per visit) 10% (per hour)	22.50 HRK per visit 552.50 HRK per hour
State and local government	25.00 HRK per visit 650.00 HRK per hour	10% (per visit) 10% (per hour)	22.50 HRK per visit 585.00 HRK per hour

Based on experiences and results of the previous business period, six scenarios of future business strategies and the possible consequences, are proposed (Table 4).

Table 4: Possible business scenarios

Scenarios	Activities	Results
Scenario 1	Raising ticket prices per individual visitor (from 25.00 to 30.00 HRK) and sports team (from 650.00 to 850.00 HRK).	The possible increase in revenues in the amount of 15,000.00 HRK a week (60,000.00 HRK a month). However, it could have a negative impact on attendance and satisfaction of visitors because it did not introduce new content (it is just a price increase).
Scenario 2	Raising ticket prices per sports team only (from 650.00 to 850.00 HRK).	The possible increase in revenues in the amount of 1,200.00 HRK a week (4,800.00 HRK a month). Since there is only one team that has leased dates in the winter period, a positive effect on the company and on further cooperation and interest of other potential clients is very questionable.
Scenario 3	Raising ticket prices per individual visitor only (from 25.00 to 30.00 HRK or from 15.00 to 20.00 HRK).	The risk that a person rents skates or buys tickets, and after a few minutes lends it to friends could result with lost profits. Increased prices of basic services could reduce consumption in the coffee bar located within the rink.
Scenario 4	Introducing a parking fee (the parking is now free) – 3 HRK per hour.	The possible increase in revenues (on average 270.00 HRK a day). However, since the City of Delnice does not charge parking, the introduction of the parking fee would trigger negative reactions and would have a negative effect on the overall visitors' perception of the facility. In addition, it requires certain funds (parking equipment/staff etc.).
Scenario 5	Available morning capacities could be offered to organized arrivals of school children (for purposes of skating schools, figure skating or ice hockey) and all other sports clubs that can train on ice or a concrete surface.	The contract with KHL "Mamut" (two hours a day, three days a week; at a price of 650.00 HRK per hour) provides revenue in the amount of 3,900.00 HRK a week, or 15,600.00 HRK a month. The revenue for the three winter months is 46,800.00 HRK. Arranging new contracts with other clients multiplies the amount.
Scenario 6	Additional contracts with other sports teams and individuals (at a price of 650.00 HRK per hour).	Provision of relatively stable revenues during the contract period. However, there are some issues like revenue collection (whether the payment is in advance or after the use), the question of reserved but unused terms etc.

There is another fact that contributes to the possible successful business future of the Ice rink in Delnice. Its potential for training purposes has been recognized by the leadership of ice hockey club "Medvečak" from Zagreb. In cooperation with ice hockey club "Mamut" from Delnice, the meeting with Goranski sportski centar Ltd was initiated in 2012, in order to come to an agreement on possible cooperation. Prerequisites for the cooperation are primarily conditions that must be met in terms of equipment, quality of ice surface, etc. The Ice rink meets most of the technical requirements for trainings, but for professional matches and competitions additional investment in protective plastic for the auditorium, dressing rooms and access to the parking lot for buses, should be done. The ice rink staff is sufficient for basic operation, because sport teams usually have their own staff in charge for the organisation of trainings and matches. Accordingly, investments are necessary if the facility manager wants to fully commercialize the facility and put it into function as

sport at a higher level. This could further boost sports tourism, especially sports participation tourism, sports training tourism and event sports tourism.

Concluding remarks

The Multi-purpose hall / Ice rink in Delnice is an expensive facility to maintain, with a relatively disproportionate monthly traffic. The specificity of such a group of facilities (like museums, theatres, etc.) is that they are often not profitable centers, but they serve the community in terms of satisfying leisure needs. Therefore, it is hard to expect from it to achieve a satisfactory payback period and return on investment. However, the facility manager must try to at least cover the operating costs. After analysing the current situation and possible scenarios, it can be concluded that the main problem is the inappropriate and inefficient business model that results in an insufficient number of tickets sold. The only quality strategy is to increase the number of tickets sold in a way to expand the range of services to existing and new customers, local residents and tourists as well. In addition, a special contribution could be reflected in the expansion of the sports tourism offer within the destination, either through active (competitors) or passive (viewers) participation in both amateur and professional sports. On the other hand, raising the unit prices of primary products – tickets or rental by the hour – is risky and can just slightly contribute to the overall increase in sales and earnings. In this regard, special attention should be paid to improving the quality of marketing activities and to creating cooperation between sports managers, destination managers, athletes and the public sector, in order to attract new clients and visitors. Thenceforth, the facility manager could think about raising the prices, of course with a reasonable calculation.

It could be concluded that the findings and recommendations suggested by this paper have important theoretical and managerial implications. They can be used by managers of existing and potential sports facilities in order to better serve sports and tourism needs in the destination.

References

1. Anthony, D. (1966). *Sport and Tourism*, London: CCPR.
2. Arthur, D. (2010). Sport Event and Facility Management. In: J. Beech & S. Chadwick (Eds.), *The Business of Sport Management* (pp. 321-349). Harlow: Pearson Education.
3. Bartoluci, M. (1995). Razvitak sportsko-rekreacijskog turizma u Hrvatskoj. [Development of sports-recreational tourism in Croatia. In Croatian.] *Acta-Turistica*, 7(2) 137-157.
4. Bartoluci, M. (2003). *Ekonomika i menadžment sporta*. [Economics and management of sport. In Croatian.] 2nd revised ed. Zagreb: Informator, Kineziološki fakultet Sveučilišta u Zagrebu.
5. De Knop, P., & Van Hoecke, J. (2003). The Place of Sport in the Battle for the Tourist: A Figurational Perspective of the Development of Sport Tourism. *Kinesiology*, 35(1), 59-69.
6. Fried, G. (2010). *Managing Sport Facilities. 2nd Edition*. Champaign: Human Kinetics.
7. Glyptis, S.A. (1982). *Sport and Tourism in Western Europe*. London: British Travel Education Trust.
8. Greenweel, T.C., Fink, J.S., & Pastore, D. L. (2002). Assessing the Influence of the Physical Sports Facility on Customer Satisfaction within the Context of the Service Experience. *Sport Management Review*, 5(2), 129-148.
9. Harrison-Hill, T., & Chalip, L. (2005). Marketing Sport Tourism: Creating Synergy between Sport and Destination. *Sport in Society: Cultures, Commerce, Media, Politics*, 8(2), 302-320.
10. Hinch T.D., & Higham, J.E.S. (2001). Sport Tourism: a Framework for Research. *International Journal of Tourism Research*, 3, 45-58.
11. Högrström, C., Rosner, M., & Gustafsson, A. (2010). How to create attractive and unique customer experiences: An application of Kano's theory of attractive quality to recreational tourism. *Marketing Intelligence & Planning*, 28(4), 385-402.
12. Hunziker, W., & Krapf, K. (1942). *Grundriss der Allgemeinen Fremdenverkehrslehre*. Zurich: Polygraphischer Verlag.
13. Keller, P. (2002). *Sport & tourism: Introductory Report*. World Conference on Sport and Tourism, Barcelona, 22 and 23 February 2001, Madrid: WTO.
14. Perić, M. (2010). Sports Tourism and System of Experiences, *Tourism and Hospitality Management*, 16(2), 197-206.
15. Radicchi, E. (2013). Tourism and Sport: Strategic Synergies to Enhance the Sustainable Development of a Local Context. *Physical Culture and Sport. Studies and Research*, 57, 44-57.
16. Schwarz, E., Hall, S.A.A., & Shibli, S. (2010). *Sport Facility Operations Management*. Oxford: Elsevier Butterworth Heinemann.
17. Sobry, C. (2011). For a Responsible Sport Tourism and a Local Sustainable Development. In: D. Milanović & G. Sporiš (Eds.), *6th International Scientific Conference on Kinesiology: Integrative Power of Kinesiology* (pp. 50-54). Zagreb: Faculty of Kinesiology, University of Zagreb.
18. Standeven, J., & De Knop, P. (1999). *Sport Tourism*. Champaign IL: Human Kinetics.
19. Turco, D.M., Riley, R., & Swart, K. (2002). *Sport Tourism*. Morgantown: Fitness Information Technology.
20. Weed, M.E. (2001). Developing a sports tourism product. *Paper to the First International Conference of the Pan Hellenic Association of Sports Economists and Managers, The Economic Impact of Sport*, February.
21. Weed, M.E., & Bull, C.J. (2009). *Sport Tourism: Participants, policy and providers*. Second edition. Oxford: Elsevier Butterworth Heinemann.

SOCIAL COMPETENCES OF SLOVENIAN SPORT MANAGERS

Iztok Retar, Saša Pišot and Edvard Kolar

University of Primorska; Science and Research Centre, Institute for Kinesiology Research, Koper, Slovenia

Abstract

The study aimed at analysing how Slovenian sports managers assesses the importance of social competences and self-assess their own social competences, taken from the model Key competences of Slovenian sport managers. They have ranged only two social competences at a very high level. We found that the assessment of importance on one hand and the self-assessment of one's own competences on the other hand regarding the same competence correlate negatively. The results have shown, that managers assesses certain social competences to a very high level of importance, and that, nevertheless, leadership and technical competences seem to stay remain more important. According to managers' self-assessment their social competences are less developed than they are important. This opens up the opportunity to further develop and strengthen the successfulness of sports management.

Key words: *sport management, key competences model*

Purpose

In the contemporary management practice the leadership approach model which includes competences for action as well as social competences is increasingly becoming implemented in practice (Verle & Markič, 2012). Social competences, in terms of soft leadership forms, may be expectedly omitted, particularly due to the actual financial, moral and economic crisis, and thus reduce the competitiveness of sports organisations in the global market.

The following definition of management serves for the purposes of our research "Management in sports is a process of key resources management and cooperation with important stakeholders, and which enables efficient realisation of business and sports goals of an organisation and/or athlete in all management functions." (Retar, et. al., 2013). An important emphasis is put on the social dimension of management processes by Parks & Quarterman, (2002), claiming that sports management covers four key areas: sports marketing, financing of sports organisations, managing people and influence of sport as a social institution. Through the definition they attribute direct as well as indirect power of sport not only to economic terms, but also to social and other non-economic areas. Thus, sports managers can have positive or negative influence on the above mentioned impact of sport on society. We decided to study the presence, development and importance of social competences of Slovenian sports managers on the basis of the fact that they may have comparative advantage since "in the long run only those organisations can survive where besides economic added value the social stability of their social environment plays an important role." (Nonaka & Takeuchi, 2011 by Verle & Markič, 2012).

Since the gap between theory and practice, when studying Slovenian sports managers' competences, was still quite significant, and because the presence of social competence has not been studied yet, lead us to make a study into the following questions: which competences among social competences considered as the most important are for Slovenian managers for efficient management of Slovenian sports organisations, and which social competences of their own they subjectively considered as the most developed. In addition, we wanted to know whether there is any statistically significant connection between the development level and the importance of social competences.

In our research competences are understood as "the ability to apply knowledge, skills, personal characteristics, experience and motivation in order to uniquely and efficiently perform an expected type of work or task." (Retar, et al., 2013). According to the TUNING methodology (Tuning, 2003), they are divided into general competences, being transferrable, and in specific competences related to concrete expected tasks or functions. General competences are instrumental (e.g., mother tongue), individual abilities (e.g., perseverance), social skills (e.g., participation in the group) and system competences (e.g., adjustment to changes). Specific competences are knowledge, understanding and skills in professional areas of sports management. Among various definitions of "social competences" we selected the definition of Education and Culture Directorate General of the European Commission (EC) which introduced the definition of social competences within the European framework of key competences for lifelong learning, as follows: "These include personal, interpersonal and intercultural competence and cover all forms of behaviour that equip individuals to participate in an effective and constructive way in social and working life, and particularly in increasingly diverse societies, and to resolve conflict where necessary." (EC, 2010). Based on the model of competence structures of Slovenian sports managers

(Retar, et.al., 2013) and on the basis of the above cited EU criteria, for the purposes of this study we selected the following six competences and classified them in the group of social competences:

1. Ability to cooperate with people,
2. Developing positive working environment,
3. Taking responsibility for co-workers, for sports environment, for the society with regard to the results of their work,
4. Understanding ethical and expert obligations,
5. Designing the appropriate strategy for conflict management and stress situation management and
6. Establishing partner relationships.

Methods

Measurements by applying quantitative research method were carried out on the entire population of Slovenian sports managers employed in sports organisations having more than EUR 100.000 of annual revenue, more than one employee and where sports managers perform at least one year of voluntary tasks or professional work. Data were collected with a survey questionnaire in electronic form, which was sent to official electronic addresses of 150 selected sport managers complying with the above stated criteria. After numerous requests we were able to acquire 85 managers who agreed to participate (53% response rate). The questionnaire was divided in 3 parts; in the first part we obtained general socio-demographic characteristics of the respondents; in the second, sports managers evaluated the competences according to importance and, in the third part they were asked to self-assess their own level of developed competences. The importance of social competences was evaluated by the respondents using a 6-grade assessment scale with values ranging from 1 (not important) to 6 (very important). They were asked to choose arrange of 15 competences out of 34 competences. The IBM SPSS Statistics 19.0 software (SPSS, Inc., Chicago, Ill, USA) was used for descriptive statistics and Spearman's bivariate correlation coefficient analysis. Statistical significance was set at the level of $p < .05$.

Results

The sample included mainly men 91.8%, only 8.2% were females. The average age of an interviewed Slovenian sport manager was 45 years and 4 months (± 9 years and 6 months). The survey included respondents from 27 Slovenian cities, and the majority, 36, were from the Ljubljana. Most respondents had university education and 50.6% of the respondents were employed on a full time basis. More than a half, 52.9% of the respondents, answered the question about the total income of their organisation in 2012 by claiming that the total annual income of the organisation amounted between EUR 100,000 and EUR 300,000. Only 7.1% of the respondents replied that their organisation's income ranged between EUR 300,000 and EUR 500,000; 16.5% of the respondents replied that the income of their organisation was between EUR 500,000 to EUR 1,000,000. And 23.5% of respondents replied that their sports organisation had more than EUR 1,000,000 of annual income in 2012.

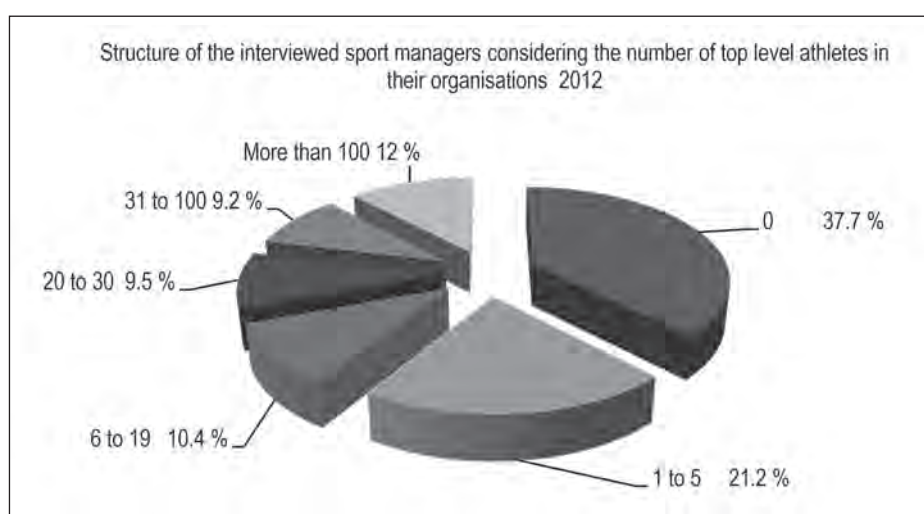

Source: Retar, et. al., 2013

Graph 1: The structure of the interviewed sport managers considering the number of top level athletes in their organisations in 2012 (categorised on the basis of Slovenian Olympic Committee's Categorisation)

Only 37.7% of the respondents replied that no top level athletes categorised on the basis of the Slovenian Olympic Committee's Categorisation in 2012, were in their sport organisations (Graph: 1).

The respondents ranked the competence “developing a positive working environment” as the top competence among all competences (Table: 1), “taking responsibility for co-workers, the sports environment and the society with regards to the results of their work” was ranked ninth and finally the competence “designing the appropriate strategy for conflict management and stress situation management” ranked last, on the 15th place. On the other hand, the social competences “ability to work with other people”, “understanding ethical and expert obligations” and “establishing partner relationships” did not rank among the first fifteen at all, which indicates that Slovenian sports managers do not consider social competences as relevant in sports management.

Table 1: 15 most important competences of sport managers according to respondents' opinion

Competences, Social competences*	Rank
Developing a positive working environment*	1
Organising work and delegating tasks	2
Financial resources and knowledge management	3
Representing professional and moral authority	4
Understanding and realising business goals	5
Readiness for changes needed for improvement	6
Stimulation for work, supervision, awarding	7
Analysing work processes	8
Taking responsibility for co-workers, the sport environment and the society with regards to the results of their work*	9
Striving to operate on the basis of best practices	10
Establishing partnerships	11
Employing and selecting candidates for employment	12
Sustainable planning and implementing business processes	13
Mastering project management	14
Designing the appropriate strategy for conflict management and stress situation management*	15

Source: Retar, et al., 2013

Furthermore, we compared how respondents were self-assessing the development of their own competences with reference to their importance. Our comparison has shown (Table: 2) a weak coherence between them, as the majority of competences which the respondents considered as very important, were less developed according to their self-assessment. There were only two exceptions, i.e., the competence “ability to work with people” and “developing a positive working environment”. From our findings we can assume that, except for the above mentioned two competences, which are evaluated on one hand as very important and on the other hand as very much developed in the interviewed managers, the rest of social competences have not been developed yet as one might assume on the basis of the assessment of competence importance with reference to successful sports management.

Regarding the-correlation between the assessment of the importance and the self-assessment of social competences development, some significant positive and also negative correlations have been noticed: a) There is a positive correlation ($r = .519$, $p < .001$, $N = 85$) in the question of “understanding ethical and professional obligations of sport manager”; b) There is a negative correlation ($r = -.289$, $p = .007$, $N = 85$) in the question of “feeling the responsibility of co-workers, environment and society for the results of sport manager”. Other connections between similar competences are not statistically relevant.

Table 2: Comparison between the self-assessment of development and the assessment of social competences' importance of the interviewed managers

Social competence	Assessment of competence importance	Self-assessment of competence development
Ability to cooperate with people	5.84	5.26
Developing a positive working environment	5.51	5.05
Taking responsibility for co-workers, the sport environment, the society with regards to the results of their work	5.22	4.99
Designing the appropriate strategy for conflict management and stress situation management	5.21	4.42
Understanding ethical and expert obligations	5.13	4.99
Establishing partner relationships	4.93	4.74
Average value	5.3	4.9

Conclusions

As expected, the research found that sports managers assessed quite high the development of their social competences, the average grade from 1 to 6 is to 4.9. We have been surprised at the result that some of the competences were not even ranked among the first fifteen competences as for example "ability to cooperate with people", "understanding ethical and expert obligations" and "establishing partner relationships". In the next stages it would be interesting to study the reasons for this. In addition, the study results point at unused opportunities for improving sports management by developing social competences. We have been equally surprised by the negative correlation between the self-assessment of the development and the assessment of importance given by the interviewed managers to the competence "feeling the responsibility for co-workers, environment and society for the results of sport manager".

The results of the research may be understood as good encouragement for taking effective measures for the development of social competences as well as for studying any other connections with the objective to fulfil the public interest in the field of sports culture, to act responsibly, transparently, being profit and social oriented, especially from the perspective of workers, volunteers and other shareholders involved in sport.

References

1. Evropska komisija, Generalni direktorat za izobraževanje in kulturo (2010). Ključne kompetence za vseživljenjsko učenje, Evropski referenčni okvir. Bruselj: Key competences for lifelong learning. European references. Retrieved from: http://ec.europa.eu/dgs/education_culture/publ/pdf/lil-learning/keycomp_sl.pdf (
2. Parks, J., Qurterman J. (2002). Contemporary sport management. Champaign: Human Kinetics.
3. Retar, I., Plevnik, M. & Kolar, E. (2013). Key competences of Slovenian sport managers. Koper: Univerza na Primorskem, Znanstveno-raziskovalno središče Inštitut za kineziološke raziskave, Založba Annales. Annales kinesiologyae, 4, 2, 81-94.
4. Tuning Educational Structure in Europe. (2003). Final report. Phase one. (ur. Gonzales, J., Wagenaar, R.). Bilbao: University of Deusto, University of Groningen.
5. Verle, K. & Markič, M. (2012). Kompetence vršnih menedžerjev in organiziranost kot osnova uspešnosti organizacije. Koper: Univerza na Primorskem, Fakulteta za management.

HOW DOES ADVERTISING THROUGH SPORT WORK? EVIDENCE FROM TURKEY

Duško Bjelica¹, Stevo Popović¹, Damjan Jakšić², Rašid Hadžić¹ and Selçuk Akpınar³

¹University of Montenegro, Faculty for Sport and Physical Education, Nikšić, Montenegro

²Faculty of Sport and Physical Education, University of Novi Sad, Novi Sad, Serbia

³Physical Education and Sport Department, Nevşehir Üniversitesi, Nevşehir, Turkey

Purpose

The first purpose of this study was to compare consumers' attitudes towards advertising through sport with their attitudes towards advertising in general. The second purpose of this study was to analyze the relationships between beliefs about and attitude towards advertising through sport, mostly due to the reason that it was expected that companies should profit from the use of sport as an advertising medium and the identification of specified beliefs influencing to positive attitudes would enhance advertising strategies.

Methods

The subjects that were asked to participate in the survey during the spring semester of 2010 were randomly selected students who attended METU in Ankara. Out of 174 questionnaires distributed, 173 usable questionnaires were returned (male: 75; female: 98). The system of variables consist 45 items, modeled by seven-point Likert scale, of attitudes and beliefs about and 6 demographic items that were modified from Pyun (2006) original items to fit each area. The factor analysis were employed to take the best item of each question, while Wilcoxon Signed Ranks Test was used to test consumers' attitudes towards advertising through sport with their attitudes towards advertising in general. Then, Optimal Scaling Method was employed to reveal the relationships between beliefs about and attitude towards advertising through sport.

Results

The customers' attitudes towards advertising through sport were significantly more positive than their attitudes towards advertising in general. On the other hand, three of maximum seven belief constructs: social role and image, hedonism/pleasure and annoyance/irritation have significantly influenced attitude towards advertising through sport.

Conclusions

The current findings support the authors' hypothesis that the consumers' attitudes toward advertising through sport in Turkey are significantly more positive. These findings were consistent with the previous evidences (Mittal, 1994; Schlosser et al., 1999; Pyun et al., 2012). In addition, this study found similar advertising beliefs with the previous studies of the university students (Pyun & James, 2009, 2011; Pyun et al., 2012) that significantly influenced consumers' attitude towards advertising through sport. Consequently, these findings will certainly provide a cornerstone for understanding the growth of consumers' attitude towards advertising through sport in Turkey, especially in this demographic group.

Key words: Sport, Advertising, Beliefs, Attitudes, Turkey

References

1. Mittal B (1994). *J Advertising Res*, 34(1), 35-53.
2. Pyun DY (2006). *The proposed model of attitude toward advertising through sport* (Unpublished doctoral dissertation), Florida State University, Tallahassee.
3. Pyun DY, James JD (2009). *Int J Sport Comm*, 2, 1-20.
4. Pyun DY, James JD (2011). *Sport Manage Rev*, 14(1), 33-41.
5. Pyun DY, Kwon HH, Chon TJ, Wook J (2012). *Eur Sport Manage Quart*, 12(1), 43-63.
6. Schlosser AE, Shavitt S, Kanfer A (1999). *J Interact Mark*, 13(3), 34-54.

SPORTING EVENTS WITH A CAUSE: THE CASE OF CROATIAN RUGBY UNION AND WOMEN'S SHELTER

Miroslav Mandić and Morana Fudurić

Faculty of Economics and Business Zagreb, Croatia

Purpose

The main purpose of this paper is to examine sporting events that promote a specific cause, and are planned and implemented as a result of close cooperation between a sports and a non-profit organization. Furthermore, the aim is to show synergic effects which can be the result of the given collaboration, and which can be seen in joint organisation of sporting events.

Methods

Given the exploratory nature of the study case study method was used. Moreover, a qualitative analysis was conducted through in depth interviews with key persons who were included in the organisation of the sports event.

Results

Over the years, there have been a considerable number of contributions that examine the impact of sporting events from many diverse perspectives, among others, its impact on tourism and economy. However, the impact of sporting events on society did not receive adequate attention. Therefore, this work fills a certain gap in the literature. The analysed data shows that the collaboration between the Croatian rugby Union and Women's shelter led to a successful organisation of a sports event, where synergic effects were realised.

Conclusion

The paper demonstrates an example of successful collaboration between a sports association (the Croatian Rugby Union) and a non-profit organisation (Women's Shelter). Their joint organisation of a sporting event resulted in raising funds for women who are victims of violence, and the event was also successfully used for informing the public about the problem of violence against women in this society. Furthermore, the paper identified the main drivers of the mentioned collaboration, underlying reasoning and impact and outcomes for both organizations.

Key words: *sports marketing, sporting events, non-profit, cause*

PLANNING IN CROATIAN NATIONAL SPORT FEDERATIONS

Sanela Škorić¹ and Mato Bartoluci²

¹Faculty of Kinesiology, University of Zagreb, Croatia

²Faculty of Economics and Business, University of Zagreb, Croatia

Purpose

The purpose of this study is twofold. First, the purpose is to stress the importance of the planning in non-profit organisations, and the second is to test the level of satisfaction with the process of planning in Croatian national sport federations.

Methods

A questionnaire developed by *Association Management, Consulting & Evaluation Services* for checking how well an organization engages in strategic management (AMCES, 2011) was adopted, and sent to national sport federations as organizations in charge of the development of various sports. The population consisted of 80 sport federations which are members of the Croatian Olympic Committee (see HOO, 2011). In total, 76 questionnaires were sent (4 organizations could not be reached either because of the wrong contact information, or because of the legal issues concerning the representation of sport in question), and 33 answers were received (43.4% response rate). Among other variables, the questionnaire tested the level of satisfaction with various management functions, including planning.

Results

The majority of respondents hold the position of a general secretary (54.5%) or member of executive board (18.2%), i.e. having in mind their responsibilities their opinion on this matter is of great importance and value. The interviewees are most satisfied with the communication function, and least satisfied with various aspects of human resources management. Planning was graded with an average grade 3.4.

Conclusion

Although the starting hypothesis is rejected and the average grade concerning satisfaction with the process of planning will be at least 3.04, and not 3.00, one cannot ignore the fact that the difference seems rather low. The purpose of this paper was to stress the importance of the planning for all types of organizations, and especially non-profit ones like sport federations. It is clear that the recommendation to national sport federations in Croatia goes towards the improvement of the planning function.

Key words: *non-profit organisations, sport, planning, management*

References

1. AMCES (Association Management, Consulting & Evaluation Services) (2011). *Tools* /online/. <http://www.amces.com/resources.htm>, retrieved in January 2011.
2. HOO (Hrvatski olimpijski odbor) (2011). *Nacionalni sportski savezi* /online/. <http://www.hoo.hr/1340-v-nacionalni-sportski-savezi.aspx>, retrieved in February 2011.

CLUSTER AS A POSSIBILITY FOR SPORT SECTOR

Irena Valantine¹, Ingrida Krikstaponyte¹ and Gytis Junevicius²

¹Lithuanian sports university, Lithuania

²Lithuanian Innovation centre, Lithuania

Purpose

In recent years an important type of business cooperation, the so-called “clusters”, came to the focus of interest at both national and international level. According to M.E. Porter (2001), clusters are “geographically proximate group of interconnected companies, associated institutions linked by commonalities and complementarities”. These actors refer to entrepreneurs, governments and education/knowledge institutions (the triple helix). Sport as an industry plays very important role in the society and supports innovative organizations to carry out research and develop new products and services, and in order to expand into new markets. Clusters in sports industry will be the best method to supply and deliver in the holistic sense a whole range of sports, wellness and physical activity services.

Methods

Content analyses of the scientific literature.

Results

The European Commission (EC) identifies that collaboration in sport is highly effective and provides three forms that are most common: partnership, networks and clusters. These forms increase sectors effectiveness in terms of collective learning, sharing of knowledge. In terms of sport and wellness cluster Europe has many examples. Some of them, like Switzerland and Austria, are really famous, effective and prosper from increasing number of arrivals each year. Nevertheless, clusterization processes in Lithuania does not practically take part and are really fragmented. Most of clusters are in the stage of feasibility studies, but it is clear that interest in this type of business development is increasing. In sport industry Lithuania doesn't have proper clusters yet, but there are some embryos of wellness services concentration and cluster formation in particular regions.

Conclusions

Shilbury (2000) examines sport cluster as potential future sport delivery systems. There are more studies on sport clusters such as the horseracing industry in Southern England, the skateboarding cluster in Australia, the surfing cluster in Torquay, Australia, the football league in Victoria, Australia and etc. (Gerke and etc., 2011). Cluster formation tendencies are intensifying in all around the world, but in Lithuania clusterization processes are really fragmented at the moment.

Key words: *sport sector, cluster*

References

1. Porter, M.E. (2011). Location, Competition, and Economic Development: Local Clusters in a Global Economy, *Economic Development Quarterly*, 14, 15-34.
2. Shilbury, D. (2000). Considering Future Sport Delivery Systems, *Sport Management Review*, 3(2), 199-221.
3. Gerke, A., Desbordes, M., Dickson, G. (2011). The relationship between inter-organisational citizenship behaviour and innovation within sport clusters – a cross-cultural approach.



Kinesiology in Social Sciences and Humanities

**7th INTERNATIONAL
SCIENTIFIC
CONFERENCE ON
KINESIOLOGY**

**FUNDAMENTAL
AND APPLIED
KINESIOLOGY – STEPS
FORWARD**

Editors:

**Prof. Ksenija Bosnar, PhD
Zrinko Čustonja, PhD**

Peer Reviewers:

**Prof. Renata Barić, PhD
Prof. Sunčica Bartoluci, PhD
Prof. Ksenija Bosnar, PhD
Zrinko Čustonja, PhD
Prof. Tanja Kajtna, PhD
Darija Omrčen, PhD
Prof. Benjamin Perasović, PhD
Prof. Franjo Prot, PhD
Prof. Vladimir Takšić, PhD**



FACING CHALLENGES: AN INTERNATIONAL PERSPECTIVE OF SPORT HISTORY IN ACADEMIA

Annette R. Hofmann

Ludwigsburg University of Education, Germany

Each country and each culture has its own set of sports, games and exercises which are part of a local, national and nowadays also a global identity. Sport historians look at the historical developments of sports and physical cultures, its agents and the societies involved with it from various angles. Within the last decades sport history, which is very much connected to the cultural studies of sports, has become a field that many academics of different backgrounds are interested in. Not only researchers with a background in physical education, but also mainstream historians, scholars of cultural, media or linguistic studies engage in this field. Despite this interest, often the work of sport historians with a background in physical education not esteemed by others. This can be seen, for instance, in the fact that the scholars of various backgrounds publish in different journals or do not acknowledge each other's works.

Sport history is also an academic discipline that fights for methods and theory; some countries show increasing interest in this field, while in others, involvement is declining. But sport history is also of importance outside of academia for sports clubs and federations, for sports fans and journalists. Politicians as well show a certain interest in instrumentalizing sports for their political programs.

This paper will show the importance of sport history as an academic field and will give an overview of developments and challenges in this field by looking at the situation in various countries.

CROATIAN SOKOL OR HOW DID POLITICS INFLUENCE ON EARLY DEVELOPMENT OF SPORTS AND PHYSICAL EXERCISE IN CROATIA

Zrinko Čustonja

Faculty of Kinesiology, University of Zagreb, Croatia

Abstract

First Croatian Sokol society was founded in Zagreb in 1874. By the beginning of World War I in Croatia existed about 180 Croatian Sokol societies which together counts between 15,000 and 20,000 members. During that period of time the Croatian Sokol was the most widespread and most massive physical exercise and social movement in Croatia. The Sokol movement (from the Slavic word for falcon) was a gymnastic movement (system of physical exercise) founded in Prague in the Czech in 1862 by Miroslav Tyrš and Jindřich Fügner. In that time both Czech and Croatia were parts of Habsburg Empire (later Austro-Hungarian Empire). Exercise was a fundamental activity, but the reasons for the establishment and goals of the Sokol movement were political and ideological: the fight against Germanization and Hungarization, development and preservation of national awareness and the fight for a better state-legal status of the Czech, Croatia and other Slavic countries within the Austro-Hungarian Empire. In order to achieve these political objectives Sokol based their activities on the inclusion of people with different social, economical and educational background, organizing big and massive public physical exercise events, so-called 'slet', wide range of activities in the field of education and culture and branched publishing activities. The leaders of the Croatian Sokol societies were generally prominent social and political figures who were mainly related to the People's Party, and later the Croatian Party of Rights.

Key words: Croatian Sokol, exercise, politics, sports

Introduction

Sokol movement occurred in the second half of the 19th century in the Czech (Bohemia), and then spreads to other Slavic nations within the Habsburg or Austro - Hungarian Empire and beyond. Definitions, scopes, roles and understanding of the impacts of the Sokol movement may vary from country to country, but the prevailing opinion is that Sokol movement had a prominent role in social and political life as well as in the development of sports and physical exercises movement in all Slavic nations where it appeared and developed. (Stepišnik, 1977, Radan, 1981, Jajčević, 2010)

In Croatia Sokol movement occurred in the 1870s although Sokol's ideas and initiatives for the establishment of Sokol organization occurred during the 1860s. The first Sokol organization was founded in Zagreb in 1874. (Jajčević, 2010)

Croatian sports historiography is relatively rich in numerous studies of Sokol movement that relate to specific region of Croatia (see Virč, 1998, Horvat, 1991, Mijandrušić, 1971) or, more often, to the cities and local Sokol societies (see Hrستیć 2013). Archives of Croatian Sokol Association as well as most of the archives of particularly Sokol societies are not preserved. The main sources for researching the history and development of the Sokol movement in Croatia are Sokol periodicals (newspapers, journals, magazines) which brings news and reports on the activities of different Sokol societies. A small part of the material is in the State and local public archives, but only to the extent that it relates to communication of Sokol societies with official bodies or persons. At this point, unfortunately, no one has made a complete and comprehensive historiographical research of phenomena and development of the Sokol movement in Croatia.

In this paper the focus will be on establishment of first Sokol organization in Croatia in 1874 and specific political and social moments connected to that event.

Political and social situation in the mid-19 century Habsburg Monarchy and Croatia

Reasons for the emergence of Sokol movement as well as motives and aims are predominantly connected with wider social and political situation in the Habsburg Monarchy (later Austro-Hungarian Empire). Affected by the wave of political, social and economic problems that occurred in the Habsburg Monarchy as a result of foreign policy failure and military defeats in the late 1850s and early 1860s first Sokol organization in Czech was organized in 1862. (Jajčević, 2010) Foundation of the Sokol movement must be also seen in context of development and strengthening of national and political consciousness of the Czech people, especially young and progressive Czech intellectuals, since the first Sokol society in Prague was organized under the umbrella of the political party *Mladočeši* (Národní strana svobodomyšlná, National Liberal Party, Jungtschechen, Young Czechs Party). It was the second major Czech political party with national and liberal political ideology. Sokol movement was created as a tool of political struggle and the social pressure, modeled

according to the German gymnastic system (Turnverein), prompted a mass gathering with the aim of demonstrating unity, the strength and the teamwork of Czech citizens, and was later extended to all citizens in the Austro-Hungarian Empire of Slavic origin. (Radan, 1981, Jajčević, 2010)

Political situation in Habsburg Empire in the second half of the 19th century, especially after the end of Neoabsolutist era (in 1859) is also important for understanding the emergence and development of the Sokol movement in Croatia .

The Compromise Ausgleich (Settlement between Austria and Hungary) of 1867 divided the Habsburg Empire into two separate states with equal rights under a common ruler, hence the term “Dual Monarchy”. The officially accepted name of the Dual Monarchy was Austria-Hungary, also seen as the Austro-Hungarian Empire. Due to the special constitutional position that the Croatia had, Hungary was forced to enter into a separate contract – Croatian-Hungarian Settlement. Settlement was signed in 1868 and it’s recognized Croatia as a separate unit within the Hungarian part of the Monarchy, while Dalmatia and Istria remained under the Austria. With this Settlement, Croatia received autonomy in administrative, educational, and judicial affairs. As a consequence of the new statehood position of Croatia provincial government was formed in 1869 which represent first political precondition for the establishment of Sokol organizations in Croatia. Another political precondition is met in 1873 when National Party under the leadership of Ivan Mažuranića won the elections. Ivan Mažuranić became Croatian Ban (head of the autonomous government). Ban Ivan Mažuranića conducted a number of reforms in civil, administration, judiciary, economy, culture and educational sector making a foundation of modern Croatian society. (Šišić, 1975; Gross, 1985; Gross, Szabo, 1992; Dumbović, 1999)

Ban Mažuranić and the National Party were aware that after Croatian-Hungarian Settlement Croatia can not expect further steps forward in terms of social, political and statehood position of Croatia. As a consequence they encouraged and supported social and cultural movement under the slogan “freedom through education” which aim was the development of Croatian society with an emphasis on education and enlightenment of the people. Some of the results of that policy were first Croatian Law on Education by which obligatory four-years education was introduced for the first time as well as foundation of the modern University of Zagreb. (Jajčević, 2010; Čustonja, Škegro, 2011)

Mid-19th century Croatia is also a period when nationalism emerged to counteract the apparent Germanization and Magyarization of Croatia. National movement was rather broad in scope, both nationalist and pan-Slavist and it eventually develop into two major causes: 1) a Croatian national cause aimed primarily at the unification and independence of the people of Croatia, headed by Party of Rights established in 1861 and 2) a pan-Slavic and South-Slavic (Yugoslav) cause also oriented towards the integration of the neighboring Slavic nations, organized through the People’s Party.

Establishment of the first Croatian Sokol society in Zagreb

The first ideas and initiatives for the establishment of gymnastic (physical exercise) organization in Croatia are associated with the year 1866 when the *Južni Sokol* (South Sokol) from Ljubljana (Slovenia) visited Croatian singing society *Kolo* in Zagreb on the occasion of the 300th anniversary of the death of Nikola Šubić Zrinski, famous person from the Croatian history. Guests from Slovenia participated in celebration with about 60 members who where dressed in typical Sokol uniforms with flags and a brass band caused great attention of the citizens of Zagreb. (Szabo, 1988; Bučar, 1925) After that visit within the Croatian singing society *Kolo* occurred several initiatives for establishment of gymnastic (physical exercise) organization and in particular stands out a proposal presented by Mile Maravić, later editor of *Obzor* (Horizon, leading political, cultural and educational newspaper in Croatia in second half of 19th century published by People’s Party), at the annual general assembly in 1869. (Szabo, 1988; Bučar, 1925)

It was not until 1874, however, that first concrete steps in order to establish Croatian Sokol were taken. In June 1874 at the initiative of physician Dr. Josip Fon first meetings were held and first agreements for the establishment of Croatian Sokol in Zagreb were reached. On that occasion Dr. Fon composed the Initiative committee headed by the catholic priest and director of the high school Josip Torbar with the tasks of recruiting members, preparing the rules of society and the organization of the first general assembly. Nevertheless, it took two more incentives for initiative to become fruitful.

Next arrival of the representatives of the *Južni Sokol* (South Sokol) from Ljubljana (Slovenia) was one of them. During the grand opening celebration of the modern University of Zagreb on October 19th 1874 guests from Slovenia had a very prominent role. They participated in most of the ceremonies, with special attention drawn by horn quartet that played in the parade. They also prepared fireworks in order to pay special tributes to the Ban Ivan Mažuranić, the first rector of the University of Zagreb Matija Mesić and the Bishop Josip Juraj Strossmayer. Special farewell ceremony was organized for Slovenians and even Ban Mažuranić spoke to them. (Bučar, 1925) Probably key impetus for final establishment of the Croatian Sokol society was an initiative and announcement from the German community in Zagreb for the establishment of the German Gymnastic Society (Turnverein) in Zagreb. In order to forestall that initiative Dr. Josip Fon and Josip Torbar created the first rules (statute) of Croatian Sokol society which were approved on November 3rd, 1874. Officially Croatian Sokol in Zagreb was established on December 27th, 1874 when was held first constitutive general assembly of the society. For the President of Croatian Sokol was elected Josip Vončina, the then mayor of Zagreb and a prominent member of the People’s Party, his deputy was Dr. Josip Fon, and the first Board members were: Milan Lenuci, Dr. Levin Rojčević, Đuro Kontak, Ivan Stožir, Antun Stiasny and Franjo Pečak. (Bučar, 1925)

Croatian Sokol then counted 185 members. There were 19 founding members, 66 active members (gymnasts) and 100 supporting members. Among founding and supporting members we can recognize some of the most prominent public, political, cultural and academic figures of that time: writer August Šenoa, a university professor, catholic priest and Rector of the University of Zagreb Matija Mesić, member of the Croatian parliament Fran Folnegović, the future Mayor of Zagreb Milan Amruš, a prominent Croatian historian Tadija Smičiklas, former Illyrian, high school teacher and linguist Vjekoslav Babukić, Mayor of the Zagreb Ivan Vončina etc. The only physical education teacher in the then Zagreb was Friedrich (Miroslav) Singer (1821?-1876). He was appointed as a physical exercise instructor. The gym in High School in which F. Singer held his PE instructions, was the first gym used by the Croatian Sokol. Stronger step forward in the functioning of Croatian Sokol happened from the 1876 and the arrival of Czech František (Franjo) Hochman for teacher and physical exercise instructor in the Croatian Sokol in Zagreb.

Historian Agneza Szabo (1988) points out that about 30% of the Croatian Sokol members were governmental employees (civil service, county or city employees) of various categories, about 30% entrepreneurs and craftsman (tailors, bakers, jewelers, etc.), about 20% accounted for retailers and wholesalers, about 10% were lawyers, about 10% high school and university professors, doctors, engineers and landowners.

Few years after first Sokol society organized in Zagreb many new societies were organized all over country: Varaždin in 1877, Bjelovar and Krapina in 1884, Zadar, Karlovac and Vukovar in 1885, Koprivnica in 1887, Ogulin in 1889, Split in 1893 etc. (Jajčević, 2010, Radan, 1981)

Political dimensions and political agenda of Croatian Sokol

Croatian Sokol had strong political agenda similar to Czech Sokol. Members of the Croatian Sokol societies could be all Croats and Slavs, regardless of class affiliation and status. The only language used in Sokol societies was Croatian language (contrary to the official and administrative usage). All Sokol societies had to make sure that Croatian national identity must be preserved and emphasized. (Croatian Sokol, 1908) The leaders of the Croatian Sokol were active members of the People's party and Croatian Party of Rights (especially at the end of 19th and the beginning of 20th century in Dalmatia). They had campaigned for the better political and statehood position of Croatia within the Monarchy and later unification of the all Slavs especially South Slavs within the Monarchy and the consequently creation of the independent state of South Slavs. These ultimate political goals were not public expressed because then it would not be possible to win the support of the Hungarians and Austrians. Officially Croatian Sokol did not have any political agenda it was politically neutral and it was often stressed that the Croatian Sokol members were prohibited to wear Sokol uniforms at the political events but in reality members didn't respect that. (Croatian Sokol 1907, 1908, 1909) Official statements about the political neutrality were also required by the Monarchy regulations. Sokol movement was established to preserve "national identity" and to "educate individuals to serve to the people and homeland". (Hanuš, 1925) The motto of Croatian Sokol was: *Strength is in Hands, Courage is in Heart, Motherland is in Mind*. The basic idea of the Sokol movement was fight against Hungarization and Germanization.

References

1. Bučar, F. (1925). Povijest Hrvatskoga sokola – Matice u Zagrebu 1874.-1885. Zagreb: Naklada Hrvatskog sokola Wilsonovog.
2. Dumbović, I. (1999). Razvoj pedagoške misli u Hrvatskoj. U: A. Mijatović (ur.), Osnove suvremene pedagogije. Zagreb: Hrvatski pedagoško-književni zbor.
3. Gross, M. (1985). Počeci moderne Hrvatske. Zagreb:Globus.
4. Gross, M. i Szabo, A. (1992). Prema hrvatskome građanskom društvu, Zagreb: Globus.
5. Hanuš, J. (1925). Sokolska čitanka. Zagreb: Hrvatski sokolski savez.
6. Horvat, M. (1991). Društva Hrvatskog sokola u Podravini. Podravski zbornik, 17/1991., 183.-188.
7. Hrstić, I. (2013). Hrvatski sokol u Makarskoj (1894.-1914.). Historijski zbornik, 64(1):79-98.
8. Hrvatski sokol (1907). Društvene vijesti. br. 2, 15. II. 1907., 22.
9. Hrvatski sokol (1908). Društvene vijesti. br. 5, 15. V. 1908., 59.
10. Hrvatski sokol (1908). Više svjetla. br. 5, 15. V. 1908., 51.
11. Hrvatski sokol (1909). Izvještaj središnjeg odbora o radu Hrvatskog sokolskog Saveza u poslovnoj godini 1908./1909. br. 12, 15. XII., 1909, 111.
12. Jajčević, Z. (2010). Povijest športa i tjelovježbe. Zagreb: Odjel za izobrazbu trenera Društvenog veleučilišta u Zagrebu i Kineziološki fakultet Sveučilišta u Zagrebu.
13. Mijandrušić, J. (1971). Sokolska društva u Istri i Primorju do 1914. godine. Povijest sporta, 7:618-628.
14. Radan, Ž. (1981). Pregled historije tjelesnog vježbanja i sporta. Zagreb: Školska knjiga.
15. Stepišnik, D. (1977). Sokolstvo. U: M. Flander (ur.) Enciklopedija fizičke kulture, Zagreb: Jugoslavenski leksikografski zavod.
16. Szabo, A. (1988). Kulturne dimenzije sportskih udruženja u zagrebu u drugoj polovici 19. stoljeća: djelovanje Hrvatskog sokola. Povijest sporta, 19(75): 35-45.
17. Šišić, F. (1975). Pregled povijesti hrvatskog naroda. Zagreb: Nakladni zavod Matice Hrvatske.
18. Virč, Z. (1998). Hrvatski sokol u sjeveroistočnoj Hrvatskoj. Vinkovci: SN "Privlačica" d.o.o.

ACHIEVEMENT MOTIVATION AND ITS RELATIONSHIP WITH CONCERN THE FUTURE AMONG THE STUDENTS OF THE UNIVERSITY OF TRIPOLI

Mabrouk Mohamed Aboamaed¹ and Sarmad Ahmed Mousa²

¹University of Tripoli, Libya

²University of Tikrit, Libya

Abstract

The motivation of the most psychology topics importance and significance of both the theoretical or practical level, it is difficult to address many of the psychological problems without concern motivated organism which play the main role in determining the quality and quantity of behavior "(5: 417)

It is through the study of motives can predict human behavior in the future and create some special situations that give rise to certain motives spur of doing business that we want performance and prevent to do some other work which is undesirable increases the importance of studying motives in various fields.

And knows Driver 1971) (motivation as a factor payers polemical works to guide the behavior of the organism to achieve a particular goal ”.

The motive for the completion of the individual is willing to take responsibility and the pursuit of excellence to achieve certain goals and perseverance to overcome the obstacles and problems that face and a sense of the importance of time and planning for the future.

And motivation to accomplish be motives concern when working rights pursuant to worry about not perfected or failure which seeks to accomplish the required format, and concern the future as defined Zale ski 1996 “as a state of apprehension, fear and uncertainty and fear of change is desired in the future in the case concern the future maximum it may be a severe threat of panic that there was something catastrophic happen to anyone.

Research Problem

In lost social and economic conditions existing and administrative instability, security and unemployment increased from a loss of Youth and concern for the future may affect the achievement motivation they have.

Importance of research

Lies the importance of research in dealing with a large and important in the community arrived at the stage of university education in the process of Sunni-filled problems and psychological stress of everyday life and the ambiguity surrounding their future which affects their physical and mental, and so are the importance of this research to know the level of motivation for achievement and the extent of their concern for their future and the relationship and which can be utilized in the design of extension programs to improve the motivation to accomplish and relieve anxiety level so as to create a better life balance.

Search targets

The research aims to verify the level of motivation to achieve and the level of concern the future and determine the relationship between them and the verification of the differences by the standard academic and economic level.

Find questions

1. What level of achievement motivation among the students of the University of Tripoli boycotted?
2. What the future level of concern among the students of the University of Tripoli boycotted?
3. Is there a relationship between motivation to accomplish and future concern for the students of the University of Tripoli.
4. Are there significant differences in motivation for achievement and future concern to members of the sample belonging to the worker level academic and economic level.

Search Terms

Achievement motivation knew Moses 1981 (5) that desire in a good performance and achieve success is the goal of self-activates and directs behavior and alter the important ingredients for success.

Concern the future you know Chouker 2005 as defect or mental disorder origin resulting from experiences past unpleasant with distortion and misrepresentation of cognitive knowledge of reality and the self by invoking memories and past experiences unpleasant with inflation for the cons and disprove the positives of self and reality makes its owner in a state of tension and insecurity, which could paid to change the self and the deficit.

Search procedures

Research Methodology / Use descriptive approach Relational comparative analytical relevance to the nature of the search

1. Research community / Tripoli University students boycotted first-year students and fourth
2. Sample students of College of Physical Education and the Faculty of Arts and numbered (200)
3. Research tools

Scale motive for the completion of the preparation of Moses (1981)

Concern the future scale of preparation Shukair (2005)

Show us straw Results

In light of the results obtained and the answer to the first question to the effect that the level of motivation to accomplish among the students of the University of Tripoli?

The Table (1) shows the means and standard deviations, grades and their significance on a scale motivation to accomplish.

Table 1

Sample	Measure motivation for achievement		Ranks	Significance
	Average	Deviation		
First Year	100,21	10,20	64	Medium
Fourth Year	100,66	10,30	67	Medium
Arts	102,17	9,70	65	Medium
Education	102,60	11,40	67	Medium
The total sample	101,41	10,04	65,70	Medium

From the above table it is clear that the level of motivation to accomplish the sample was an average coverage on students from the first year and fourth year as well as students of Faculty of Arts as an area of Humanities and students College of Physical Education and Sports Science as an area of Applied Sciences, where due because first year students have Hamas and motivation to accomplish bigger as knocking ocean new and different from the earlier stages of education in many variables, and performance on the scale generally reflects the rule of manifestations and behavioral of work performance without focus and life without work can be human where luck and personal responsibility in front of the difficulty of performance are often medium and yield less than hoped and that there is difficulty in doing business that requires responsibility and not to seek to reach a prominent status and lack of appreciation for outstanding students and feeling bored and all that consistent with a study Mohammed Qurashi (2011) e come to similar conclusions. The second question, which expressed what the future level of concern among the students of the University of Tripoli? It results in Table (2) show averages and standard deviations and the degree and significance of the (T) on the scale.

Table 2

Sample	Scale concern the future		Class T	Significance
	Average	Deviation		
First Year	95,00	13,5 0	84,70	Very high
Fourth Year	96,18	12,90	85,30	Very high
Arts	96,50	12,93	85,20	Very high
Education	96,00	12,80	85,32	Very high
total sample	95,92	13,0375	85,13	Very high

Table past that level of anxiety about the future is characterized by rising and that all members of the sample at various levels was concern they have a very high level the total score and the level dimensions measure which may be due to the circumstances surrounding Libya currently insecurity, high unemployment and the economic crisis and the lack administrative stability and lack of clarity of image for the country's future.

The third question / is there a relationship between the degree of motivation to accomplish the utmost concern the future when the sample? To investigate this question, use the Pearson correlation coefficient to determine the relationship and Table (3) shows that Correlation coefficient of the relationship between the payer and the achievement concern future.

Table 3

No	Relationship motivation and concern future	Correlation coefficient
1	Dimension concern future life problems	0,199
2	Dimension the vision of life	0,223
3	Dimension worried thinking about the future	0,239
4	Dimension anxiety of failure in the future	0,291
5	Dimension despair of the future	0,244
6	The total score on the scale	0,339

Table former existence correlation at 0.05 between degrees total sample on a scale motivation for achievement and grades overall on a scale of concern in its various dimensions which is consistent with the study of serenity southpaw and others 1983, which reached a positive relationship between achievement motivation and concern future after perseverance and success The collection, which means that the motivation to accomplish all its dimensions linked to positive future concern. The fourth question is no statistically significant difference between the mean scores of the motivation for completion by specialty. To answer this question test was applied (v) to see the differences between the mean scores of the motivation for achievement according to the type of specialization Physical Education and Arts, and the following table shows the results.

Table 4

Sample measure	Physical Education		Arts		Value T.	Significance level
	Average	Deviation	Average	Deviation		
Measure motivation for achievement	104,1477	9,68	104,5931	10,620	0,368	

The previous table shows no statistically significant differences in the motivation to accomplish according to a variable which means specialization. That there is no role in shaping the environment motivation to accomplish its basic components where equal between students of the Faculty of Education. Physical and students of the Faculty of Arts, which was confirmed by a study Abdoalrhman 1988 which reached no significant differences Statistically between the various disciplines on a scale motivation to accomplish.

Display the previous tables, research findings for the following:

1. level of motivation to accomplish in the sample was average.
2. the level of concern the future of the sample was high.
3. There is a positive correlation between the degree of motivation to accomplish future and degrees of concern.
4. No statistically significant differences between the mean scores of the motivation for achievement and anxiety back to the future specialty.
5. No statistically significant differences between the mean scores of the motivation for achievement and concern the future belonged to the school level.

Recommendations

Through the results obtained from research can recommend the following.

1. Interest guidance programs that help in the development of the motivation for achievement in young people.
2. Attention to programs that help alleviates the anxiety level among young people.
3. New studies dealing with achievement motivation of the rest of society.
4. Conduct studies on the causes of high concern to the members of the community.

References

1. Zeinab Chouker ----- scale concern the future, Egyptian Renaissance Library, Cairo, 2005.
2. Safaa Gimp and others ----- prospective study of the relationship between achievement motivation and some mental variables and personal and social development in the Qatari society, Educational Research Center, Qatar, 1983.
3. Abdul Rahman ----- relationship between motivation to accomplish and some academic and demographic variables, Yearbook No. 16, University of Qatar 1988.
4. Abdul Latif Mohamed Khalifa ----- achievement motivation, strange house for printing, publishing and distribution, Cairo, 2000.
5. Abdullah Moataz Sayed ----- General Psychology (i) 3 Exotic Publishing House, Cairo, 1990.
6. Farouk Abdel Fattah Moses ----- test motivation to accomplish for children and adults, Egyptian Renaissance Library, Cairo, 1981.
7. Zale ski, z, 1996 future anxiety, concept measurement and preliminary research .parson individual difference .rol.21 (2) pp174.

AN ATTEMPT TO IMPROVE OPERATIONAL DEFINITION OF MINDSET IN SPORT CONCEPT

Boris Balent and Ksenija Bosnar

Faculty of Kinesiology, University of Zagreb, Croatia

Abstract

Considering the fact that core beliefs, i.e. basic beliefs about oneself, have high impact on behavior, Carol Dweck developed the concept of fixed and growth mindset (Dweck, 1999; 2006; 2012). To measure mindset, Dweck proposed scale containing 6 questions, and one simple estimation of percentage of effort and percentage of ability in some achievement (Dweck, 1999). The aim of this paper is to present new 30 questions version of the mindset in sport scale. Added items were extracted mainly from behavioral examples Carol Dweck described in her popular psychology texts (Dweck, 2006), to secure that meaning of the concept is not changed. The scale was applied to 362 students of kinesiology, with mean age 21.8 years. Initial six items version of scale show Crombach alpha reliability coefficient of $\alpha=0.689$; coefficient of thirty items version is incremented to $\alpha=0.799$. Both versions have very low correlations with estimation of proportion of effort and ability in sport success. Component analyses with promax rotation of 30 item scale show that it can be useful not only as one-dimensional instrument, but can be viewed as three-factor measure. First promax factor is identified as growth mindset, second factor is recognized as mindset defined by objective measurement and results of learning, and third factor represents fixed mindset. Factor validity and internal consistency of expanded version of sport mindset scale are acceptable and it can be used in further research.

Key words: fixed and growth mindset, sport mindset scale

Introduction

Important part of the explanation why different people think, feel and behave differently in the same situation can be found in implicit theories, or basic beliefs about oneself (Burnette et al., 2013). Researching beliefs about intelligence and academic achievement, Carol Dweck (Dweck and Legget, 1988; Dweck, 1999; 2006; 2012) found that beliefs have high impact on behavior, and consequently, on academic success. She developed the concept of fixed and growth mindset (Dweck, 1999). It is defined as continuum, with belief that success in some activity entirely depends on ability at one pole, and belief that it entirely depends on effort at other pole. The concept was first confirmed in the domain of academic achievement (Henderson & Dweck, 1990), but it can be applied in any other field of human activity (Dweck, 2006).

The aim of this paper is to present new 30 questions version of the mindset in sport scale. Added items were extracted mainly from behavioral examples Carol Dweck described in her popular psychology texts (Dweck, 2006), to secure that meaning of the concept is not changed.

Methods

To measure mindset, Dweck proposed scale containing 6 questions, and one simple estimation of percentage of effort and percentage of ability in some achievement (Dweck, 1999, 2006). It was first used to measure mindset regarding intelligence, but can easily be converted to inspect mindset regarding any ability and beliefs about achievement in any activity. To research mindset in sport, Li (2012) adopted Dweck's six questions and call it Scale of implicit theories of sport competence. To obtain measure of mindset in sport with improved metric properties, initial Dweck's scale was expanded to 30 questions version. Added items were extracted mainly from behavioral examples Carol Dweck described in her popular psychology texts (Dweck, 2006). Items are describing three ways the mindset can be revealed, beliefs that ability or effort is key factor in sport achievement, and beliefs that results of learning and testing always predict sport success. Proposed responses on items are on five-point scale, from "completely disagree" to "completely agree" coded 1 to 5. Before further analyses, all results were coded in the way that high value means fixed mindset. The scale was applied to 362 undergraduate and graduate students of kinesiology, with mean age 21.8 years. Sample consists of 64% male and 36% female students. The analysis of reliability of whole scale was done under internal consistency model. Factor validity was inspected by component analysis with promax rotation.

Results and discussion

Internal consistency coefficient Cronbach alpha for total scale result is $\alpha=0,797$, standardized alpha is $\alpha=0,799$. Average inter-item correlation is $r=0,119$. On the same sample, initial six items version of scale show Cronbach alpha reliability coefficient of $\alpha=0,689$, and increment of reliability by adding 24 more questions is not very high. Mean of total scale result, defined as unweighted sum, is $M=76,5$ and standard deviation is $SD=10,39$; minimal result is 44 and maximal is 115 points. Kolmogorov-Smirnoff test show that distribution of total scale result do not differ significantly from theoretic normal distribution ($\chi^2=6,489$, $df=7$, $p=0,484$). The results are coded in the way that high value means fixed mindset, and low value growth mindset. Mean scale value is visibly lower than neutral point, meaning that growth mindset prevails in the sample of kinesiology students. Metric properties of items are in Table 1. Original Dweck's six questions (bolded) show adequate values on first principle component and satisfactory item-total correlations. In the set of other 24 questions, lower values are seen for questions which are indirect measures of fixed mindset, regarding results of learning and ability testing. The values of internal consistency coefficient if particular item is deleted show that there is no item which should be unquestionably removed from the scale.

Table 1: Means and standard deviatins (SD), first principle component (K1), item- total correlation (r_{it}), and internal consistency if item is deleted (a_{min}) of 30 items of sport mindset scale

Item	Mean	SD	K1	r_{it}	a_{min}
Why hide deficiencies instead of overcoming them?	1,86	0,759	-0,309	0,209	0,795
Although athletes may differ in their initial talent, trough hard work and experience they can make significant improvement.	1,59	0,794	-0,311	0,200	0,796
You have a certain amount of sport ability, and you really can't do much to change it	2,24	0,956	-0,488	0,375	0,788
To be good at sports you need to be naturally gifted.	2,98	1,070	-0,401	0,331	0,791
How good you are in sports will always improve if you work harder at it.	1,33	0,573	-0,325	0,225	0,795
Test results give us a good sense of our abilities in sport.	3,73	0,907	-0,164	0,181	0,797
Already with jung children we can foresee how sport successful they will be when they grow up.	2,80	1,009	-0,337	0,303	0,792
If at first you don't succeed, you probably don't have the ability.	1,61	0,758	-0,485	0,373	0,789
Sport achievement isn't something that can be changed much during one season.	2,73	0,888	-0,234	0,177	0,797
Effort means that we are not smart and talented.	1,63	0,823	-0,471	0,350	0,790
If we don't have abilities for something, it is smarter not to spend our time on that activities.	1,96	0,946	-0,547	0,435	0,786
The person who learn some activities faster, is the one who will be better in that activities later on.	3,08	1,066	-0,420	0,387	0,788
Test results can tell us what our abilities are, and how successful in future will we be.	3,12	0,905	-0,403	0,400	0,788
To be honest, i believe that the coach can hardly influence the level of athletes abilities.	1,87	0,873	-0,413	0,306	0,792
Some people are initially better in sports because of their origins, race, etc.	3,38	1,072	-0,278	0,232	0,796
No matter how much sport competence you have, you can always change it quite a bit.	2,01	0,751	-0,452	0,323	0,791
Your sport competence is something about you that you can't change very much.	2,26	0,857	-0,504	0,370	0,789
Uncoordinated and graceless as child can become a top level athlete in future.	2,41	1,000	-0,494	0,382	0,788
To be honest, you can't really change how sport competent someone is.	2,94	0,912	-0,484	0,385	0,788
Test results give us a good sense who the athlete is, and what is she/he capable of.	3,83	0,721	-0,082	0,120	0,798
People can learn new things, but they can't really change their basic sport competence.	2,73	0,902	-0,487	0,387	0,788
The person who learns some activities making fewer mistakes at start, is the one who will be better in that activities later on.	3,41	0,968	-0,406	0,376	0,788
You can always greatly change how sport competent you are.	1,92	0,713	-0,409	0,256	0,794
Women are better in activities that require fine motor skills.	3,24	1,055	-0,207	0,182	0,798
Women are better in activities that require fine motor skills.	2,26	1,090	-0,382	0,328	0,791
Tests or experts can tell us what our potential is, what we're capable of, what our future in sport will be.	3,46	0,895	-0,195	0,213	0,795
No matter who we are, we can change our sport competence a lot.	2,05	0,724	-0,512	0,361	0,790
The person who learns some activities with less effort, is the one who will be better in that activities later on.	3,30	0,977	-0,391	0,383	0,788
I really believe that many athletes ware not initially talented, but still have achieved great accomplishment in their sport lives.	1,99	0,912	-0,424	0,321	0,791
If I fail, I worry that others might say that I'm not as talented as they thought I was.	2,80	1,098	-0,295	0,254	0,795

Table 2: Eigenvalues of correlation matrix of sport mindset scale items exceeding value 1 with percent of explained variance

	Eigenvalue	% of variance	Cumulative %
1	4.657	15.522	15.522
2	2.961	9.871	25.394
3	1.735	5.784	31.178
4	1.434	4.781	35.959
5	1.368	4.561	40.519
6	1.304	4.348	44.867
7	1.249	4.164	49.031
8	1.151	3.838	52.869
9	1.080	3.600	56.468
10	1.011	3.370	59.838

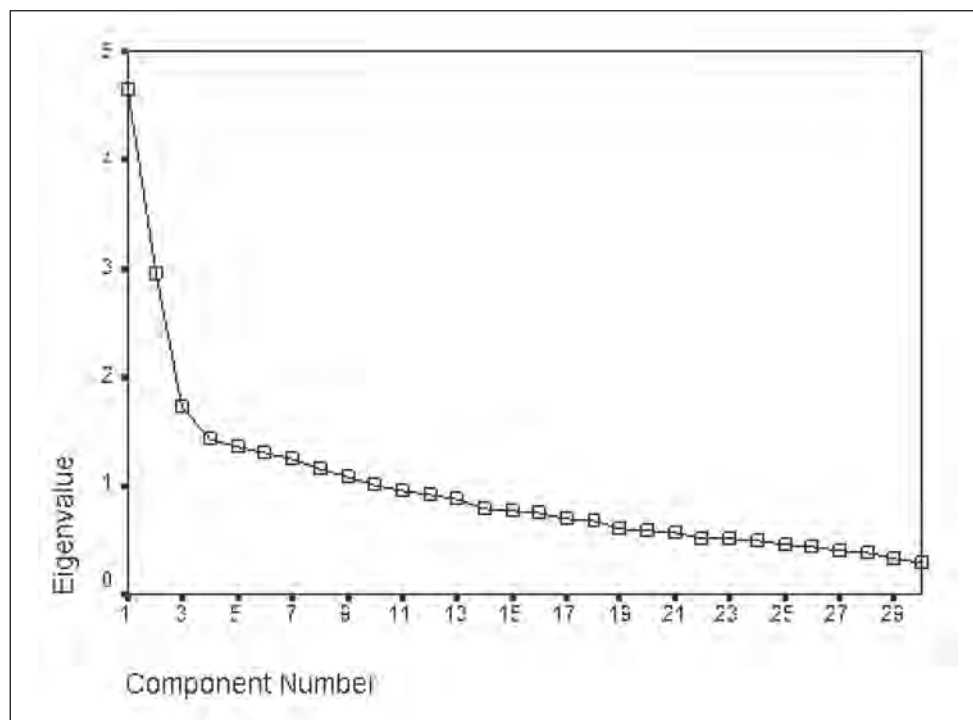

Figure 1: Scree plot of eigenvalues of inter-item correlation matrix

Table 3: The results of 3-factor solution of component analysis with promax rotation of sport mindset scale; F denotes structure and P denotes pattern

Item	F1	P1	F2	P2	F3	P3
Why hide deficiencies instead of overcoming them?	.367	.332	.023	.068	-.215	-.106
Although athletes may differ in their initial talent, through hard work and experience they can make significant improvement.	.437	.434	.074	.110	-.169	-.030
You have a certain amount of sport ability, and you really can't do much to change it	-.403	-.273	.113	.020	.450	.343
To be good at sports you need to be naturally gifted.	-.325	-.297	.331	.306	.194	.017
How good you are in sports will always improve if you work harder at it.	.472	.507	-.003	.013	-.096	.091
Test results give us a good sense of our abilities in sport.	-.016	-.056	.521	.562	-.070	-.212
Already with young children we can foresee how sport successful they will be when they grow up.	-.129	-.050	.415	.382	.241	.141
If at first you don't succeed, you probably don't have the ability.	-.459	-.358	.073	-.011	.404	.272
Sport achievement isn't something that can be changed much during one season.	-.059	.081	.111	.038	.344	.366

Item	F1	P1	F2	P2	F3	P3
Effort means that we are not smart and talented.	-.364	-.178	-.015	-.140	.562	.525
If we don't have abilities for something, it is smarter not to spend our time on that activities.	-.438	-.294	.161	.060	.496	.373
The person who learn some activities faster, is the one who will be better in that activities later on.	-.061	.070	.633	.586	.340	.240
Test results can tell us what our abilities are, and how successful in future will we be.	-.138	-.103	.700	.701	.151	-.037
To be honest, i believe that the coach can hardly influence the level of athletes abilities.	-.275	-.077	-.019	-.143	.553	.555
Some people are initially better in sports because of their origins, race, etc.	-.183	-.130	.222	.191	.195	.105
No matter how much sport competence you have, you can always change it quite a bit.	.624	.681	-.096	-.085	-.105	.168
Your sport competence is something about you that you can't change very much.	-.462	-.314	-.013	-.124	.508	.418
Uncoordinated and graceless as child can become a top level athlete in future.	.458	.411	-.252	-.204	-.285	-.088
To be honest, you can't really change how sport competent someone is.	-.404	-.314	.213	.145	.363	.214
Test results give us a good sense who the athlete is, and what is she/he capable of.	.107	.069	.551	.602	-.111	-.214
People can learn new things, but they can't really change their basic sport competence.	-.354	-.199	.143	.043	.488	.405
The person who learns some activities making fewer mistakes at start, is the one who will be better in that activities later on.	-.039	.094	.634	.589	.335	.244
You can always greatly change how sport competent you are.	.654	.710	.084	.106	-.113	.131
Women are better in activities that require fine motor skills.	-.002	.152	.115	.039	.355	.404
Women are better in activities that require fine motor skills.	-.131	.075	.171	.060	.525	.540
Tests or experts can tell us what our potential is, what we're capable of, what our future in sport will be.	-.028	-.056	.546	.582	-.038	-.184
No matter who we are, we can change our sport competence a lot.	.699	.708	.034	.082	-.239	.009
The person who learns some activities with less effort, is the one who will be better in that activities later on.	.011	.134	.726	.693	.296	.198
I really believe that many athletes were not initially talented, but still have achieved great accomplishment in their sport lives.	.527	.583	-.216	-.216	-.075	.189
If I fail, I worry that others might say that I'm not as talented as they thought I was.	.018	.263	.134	.013	.556	.652

Validity of scale was established as factor validity by component analysis with promax rotation (Tables 2-4). Ten eigenvalues of correlation matrix of sport mindset scale items exceed value 1 (Table 2), but the scree plot (Figure 1) suggest that Kaiser's criterion should lead to over-factoring. In literature, if mindset is not treated as single-factor concept, two factor solutions were reported (Li, 2012; Karwowski, 2014). In this research, for further analysis three components were retained. Structure and pattern of promax factors are in Table 3. Obtained solution is simple and follows the way items were composed. First promax factor is identified as growth mindset, second factor is recognized as mindset defined by objective measurement and results of learning, and third factor represents fixed mindset. Correlations of promax factors are in Table 4. First and third factor have moderate negative correlation, as expected. Low and negative correlation of first and second factor was also expected. Theoretically, correlation of second and third factor should be higher. Third factor clearly represents fixed mindset, and second factor represents items which should also measure fixed mindset, but indirectly. That puts into question definition of second factor and should be analyzed in further research.

Table 4: Correlations of promax factors

Promax factor	1	2	3
1	1.000	-.070	-.374
2	-.070	1.000	.214
3	-.374	.214	1.000

To conclude, factor validity and internal consistency of expanded version of Dweck's sport mindset scale are acceptable and it can be used in further research. It can be useful not only as one-dimensional instrument, but can be viewed as three-factor measure.

References

1. Burnette, J. L., O'Boyle, E., VanEpps, E. M., Pollack, J. M., & Finkel, E. J. (2013). Mindsets matter: A meta-analytic review of implicit theories and self-regulation. *Psychological Bulletin*, 139(3): 655-701.
2. Dweck, C. S. (1999). *Self-theories: Their role in motivation, personality and development*. Philadelphia: Psychology Press.
3. Dweck, C. S. (2006). *Mindset: The new psychology of success*. New York: Random House.
4. Dweck, C. S. (2012). *Mindset: How You Can Fulfil Your Potential*. Constable & Robinson Limited.
5. Dweck, C. S. & Leggett, E. L. (1988). A social-cognitive approach to motivation and personality. *Psychological Review* 95 (2): 256-273
6. Henderson, V. L., & Dweck, C. S. (1990). Achievement and motivation in adolescence: A new model and data. In S. Feldman & G. Elliott (Eds.) *At the threshold: The developing adolescent*. Cambridge, MA: Harvard University Press.
7. Karwowski, M. (2014). Creative mindsets: Measurement, correlates, consequences. *Psychology of Aesthetics, Creativity, and the Arts* 8 (1): 62:70.
8. Li, C. H. (2012) Construct Validity of Implicit Theories of Sport Competence Scale. *World Academy of Science, Engineering & Technology*, 66, 351-354.

NATIONAL IDENTITY AND HANDBALL - IMAGE OF THE CROATIAN SOCIETY?

Sunčica Bartoluci

Faculty of Kinesiology, University of Zagreb, Croatia

Abstract

National identity and nationalism are endless issues of social sciences and humanities reemerging in late 1980s due to big social and political changes in Eastern and Central Europe. New nations-states, like Croatia, have tried to find their place on European as well as world social and political scene where successes in sport and achievements have played an important role. Handball experienced general popularization in the first half of the 90s. Events like the Olympic Games or European and World Handball Championships acquire greater social importance because they have become efficient means of national identification and in such a way powerful tool of the political elites in achieving their own objectives both in the state and abroad. This paper analysed the relationship between national identity and sport at multiple levels, taking World Handball Championship in Croatia in 2009 as a case study.

Key words: *national identity, nationalism, sports, handball, Croatia*

Introduction

National identity and sport in Croatian society are interlinked on many levels. Trends on the sports' fields from the 80s until today have supported the saying, which states, that the sport is a reflexion image of the society *per se*. In the sports' fields the unsustainability of then country (Yugoslavia) and its policy was clearly revealed.

The stadiums have always been more than just places where football supporters get together. It is well known that the supporters in Split and Zagreb were bringing national flags to the stadiums, singing songs forbidden due to nationalism, even though from today's perspective they seemed innocent, they also expressed hatred towards other nationalities. Sport and sport's gatherings were used for expressing frustration and dissatisfaction with the political system and became the stage for expressing national feelings – mostly of supporters. The stadiums were probably the only places, during a specific period, where nationalistic iconography was seen, especially in Croatia, where during the Serbian mass nationalistic movement led by Milošević the so-called 'Croatian silence' from the officials was presented. Therefore, the members of the football tribe who emphasized Croatian signs had almost suffering and heroic roles in the struggle for national identity (Perasović, 1995), and many more supporters had a chance to express attitudes and views they could have never expressed anywhere else. It is not without foothold the statement which says that the atmosphere on the stadiums reflects and offers conclusions on social, economic and political conditions in one society.

From patriotism to the ethnic nationalism

The turning point in the newer Croatian history is the unplayed football match between Dinamo and Crvena zvezda from 13th May, 1990 where the great conflict emerged between the supporters from both teams, *Bad Blue Boys* and *Delije*. It is known that the leader of *Delije*, a war criminal Željko Ražnjatović Arkan, boasted that the war in former Yugoslavia had been initiated by the supporters of Crvena zvezda and not Yugoslav National Army (Vrcan, 2003).

Transforming Yugoslavia into separate national countries leads not only to restructuring of past political system but also to deep changes on all levels of society. Therefore, the knowledge of political background is necessary for understanding past and present systems, as well as understanding the social role of sport in this region.

What identity and to which extent it surfaces and dominates the life of an individual depends on social and political circumstances. If the nation is threatened from the outside the national identity starts overpowering the 'dominating field' and other forms of identification are placed aside (Sekulić et al, 2004 pp. 203).

By creating Croatian national state the sport becomes the means of integration and political homogenization of society. In the first years of Croatia sport played an irreplaceable role in constituting Croatian national identity (Bartoluci and Perasović, 2008; Bartoluci, 2014). National teams are formed and sport becomes the stage where collective promotional and affirmational actions of Croatian sportspersons are held within European and international frames. The first medals on the Olympics were expected euphorically. At the Olympic Games in Barcelona in 1992 the silver medal was won by the basketball national team and two bronze medals were won by a tennis player Goran Ivanišević, one individually and the other in pair with Goran Prpić. At the Olympics in Atlanta in 1996 the gold medals were won by the handball national team and silver by the water polo national team.

Perhaps the greatest achievement is the third place at the World Football Championship in France in 1998 when the memory of war was still fresh and present in public life and the victory taken as the absolute triumph of Croatian nation – small, economically weak but more than ever proud and at the time, it seemed, homogeneous. Sport was used as the means of recognition on the international political scene and to show that Croatia deserves to become its equal protagonist.

The role the sport had in the first years of establishing independent Croatia was documented in the request by Croatia and other newly formed countries to have become FIFA's members before joining the UN (Bodin et al., 2007).

Sport victories acquired by the national team contribute to creating a nation's image in the world, giving it, so often, (un)deserved attention and legitimacy. For instance, if you ask a foreigner where Croatia is, you would hardly get a correct answer, but the possibility that the same person has heard of a Croatian athlete, like footballer Davor Šuker or skier Janica Kostelić increases dramatically.

In one part of the public the prevailing opinion is that sport today has become the continuation of war only using different means. This statement is not entirely without the foothold in reality – at sports' fields there is a constant confrontation among supporters from different nations in their search for international recognition and prestige. The viewers identify themselves with their teams expecting winnings or, at least, a better position. In some way sport has become a political weapon of contemporary society. It leaves the impression that competitions between Croatia and Serbia will always be considered as a political and not a sporting duel.

Sport has played an important role in developing the national identity in Croatia. At the same time sports events have become places for expressing nationalism where patriotism is mixed with much uglier faces: ethnocentrism, xenophobia and chauvinism.

The fall of communism and geopolitical change of the world led to redefinition of nationalism. Theoreticians who represent primordialistic view of nations are of the opinion that nations are given to man by nature and at the same time are infinite and unchangeable, and in a way doomed to constant conflicts until independence is reached by each one (Smith, 1996). During four-year wars period the national identity transformed its shape under the influence of elite driven nationalistic ideology into a negative term. Even if it had a chance in a newly formed democratic society to create grounds for the development of liberal, democratic society they were erased completely in the war. It seems that national aspect has become the main driving force of many political elites. Louder and more violent national identities, which gain the sound of nationalistic ideology very fast, emerge on the scene. In such a way the sport becomes the field for different disputes between 'us' and 'them', our nation and those 'others', and each victory or defeat takes the form of the warfare. In the shortest period possible, the liberal nationalism was transformed into its worst form – ethnic nationalism. The sport has become "the mode for expressing national struggle, and sportspersons, representing their nations or countries, has become the primary expression of their imaginary community" (Hobsbawm, 1993). Partially this statement could be applied for Croatia, either.

Handball Championship as a part of political folklore

Handball experienced general popularization in the first half of the 90s. It was preceded by the Croatian handball national teams' success at major championships as the European Handball Championship in 1994 when the team won a bronze medal, the World Handball Championship in Island with silver medal and at the turning point in 1996 when gold medal was won in the Olympics in Atlanta. From that moment on we have witnessed the increase in popularity of handball as a sport which will place it into the position of political instrumentalization. After Atlanta there are more successful years to come: gold medal at the World Championship in Portugal 2003 and the Olympics in Athens in 2004; silver medal at the World Championship in Tunisia in 2005; the European Championship in Norway in 2008, in Austria in 2010; and the World Championship in Croatia in 2009, bronze medal at the European Championship in Serbia in 2012, Olympics in London and the World Championship in Spain.

Due to its general presence and popularity handball absorbs attention of more people independent of age, gender or social status. So, events like the Olympic Games or European and World Handball Championships acquire greater social importance because they have become efficient means of national identification and in such a way powerful tool of the political elites in achieving their own objectives both in the state and abroad. Playing for the national team has become the issue of social prestige as well as national price and honor, and this applies not only for handball.

When four basketball players did not answer the invitation to play for the Croatian basketball national team at the European Championship in Spain in summer 2007, they were publicly labeled and moral panic was created – they were called national traitors. Under the influence of the event, Petar Metličić says that playing for the national team is a matter of national pride and not a job. Even though it seems that the rhetoric calling for lynch was left in the past, once again, it was shown how often sport becomes the means for achieving political goals. Therefore, the moment it was announced that Croatia would be the host for the future World Handball Championship in January 2009 it became the issue marked with national importance.

With the success in handball and other sports, Croatia wanted to increase its reputation and present itself as a nation-state prepared to play its role in the European Union and the world. Following this atmosphere it was decided that for the forthcoming World Handball Championship which had to be held in Croatia at seven different locations, 6 new sports centers would be built. This example requires deeper sociological analysis.

Under the circumstances of global economic crisis, to start with such investments that are known to be unprofitable, leads us to the conclusion that the entire story around the Handball Championship has grown over the sport itself and become a part of political folklore. The impression was given for the public that fulfilling the terms and conditions for hosting the Championship (including the infrastructure) was of national importance. At the same time Croatia desperately needs new facilities like hospitals, kindergartens and schools. For decades a new hospital has not been built in the capital, and Arena was built for the Championship and millions of Euros spent. Pursuant to the Contract signed with the contractor Ingra the city of Zagreb and the Government will be paying EUR 7.5 million a year for the lease in the next 28 years.

Zadar, one of the towns hosting the Championship has suffered great destruction during the war in Croatia. However, for the past years it has experienced economic and social revival. Moreover, it is a town with great sport, above all basketball, tradition. In a newly built sports center *Krešimir Ćosić* handball qualifications for the Olympics in Beijing were played in May 2007. In those days it seemed that in spite of all atrocities of war that the town survived the normalization of political life and gradual formation of liberal nationalism began. In other words the town of Zadar has been governed by the right wing politicians since Croatian independence. The same way so-called ‘Dalmatian spite’ comes to the fore, as well as the wish to show that Zadar is a town with strong sport’s tradition which, symbolically, won all of its battles. The impression was made that at least in those days the politics was pushed in the background. A player from the Croatian national team, Petar Metličić said: “The public is unbelievable, they were cheering the entire time without offending the other team. I am very grateful for that on my and behalf of the entire team. Zadar has to be proud for having such supporters!”

Six months later, Zadar hosted Group 2 of the World Handball Championship – along with the national teams from Denmark, Poland, Germany, Norway and Macedonia, in the Group there was also the national team from Serbia. Zadar was, concerning this fact, experiencing so-called test of its political openness toward ‘others’ and the test would have been passed if it had not happened, what everyone talked about for days. From the main town square 24 flags from participating countries were removed. Their removal was ordered by the mayor Živko Kolega. Disputable was above all the removal of Serbian flag. After harsh demonstrations from the public, the mayor said, “analyzing all facts, and taking into consideration these special dates during which citizens are sensitive with memories of war devastations and are paying a tribute to the victims from Maslenica defensive action” he decided to remove the flags. As the consequence of this event, media established moral panic, due to labeling sport and Serbian national team and despite reprehensions coming from all sides, a so-called prophecy was fulfilled – the bus of Serbian basketball team *Hemofarm* played in Zadar in same days, was stoned, a supporter of Macedonian national team beaten up and Serbian flag torched in Zagreb. Stories on the war from not long ago and conflicting sides ‘leaked’ in the public which again made a step back in the attempt to create a democratic society.

Regarding the support of Croatian national team it leads to creating stereotypes and other discourses on ‘hot-blooded south’ and ‘cold-blooded north’ within Croatian border. The first matches were played in Split and the atmosphere was, as we could say, in accordance with the existing stereotypes ‘very hot-blooded’. The other part was played in Zagreb, and as a part of public opinion that the atmosphere was not loud and hot enough, Internet petitions and requests from citizens of Split appeared in a statement ‘Gives us the finals, we are louder!’. The discussion was observed by typical football fans (Ultras, hooligans) commenting that all these represented a theater performance without real organized cheering. Naturally, a part of supporters in Zagreb found it offensive, from the perspective of South-North relationship, where the North does not accept the stereotypes, and a part of public independent of North-South division could not accept the Ultras’ opinion on calm atmosphere, considering it the proof that to Ultras only violence and disorder are the good atmosphere. Consequently, the discussion on cheering and the atmosphere only deepened the existing prejudices.

Conclusion

The purpose of talks on sport/handball in Croatia today is the least about its self-purposeness, and mostly due to its political instrumentalization. In fact, sport and sport’s successes are very efficient promotional medium for prestige and power of certain groups, communities or nations but also for creating the identity sense and unity of the nation. It has been shown in many examples that sport in Croatia has been used as the means to manipulate the masses. Following the formula ‘bread and circuses’ the feeling of pride was offered to exhausted nation both politically and economically and it gave the legitimacy to the prevailing ideology.

The way it enflamed nationalistic passion, after the end of the war and with the normalization of social relationships it was expected that the sport could become an example of good practice and as such a universally accepted means of communication could encourage understanding among different cultures, show that international friendships are possible and eliminate the usage of national stereotypes. As the outside enemy vanishes, the need for national identification weakens and other identities come to the scene. We are in the wake of those approaches and thoughts which support the

thesis that national identities and sport are social constructions which depend on different social life circumstances and interactions of social protagonists.

Perhaps, regarding the possibility of change or hope in the evolution of thought, sport will become an example of good practice in overcoming intergovernmental conflicts among sides involved in the war in the very recent past.

References

1. Anderson, B. (1990). *Nacija: zamišljena zajednica* [Nation: Imagined Community]. Zagreb: Školska knjiga.
2. Bartoluci S. & Perasović, B. (2008). National Identity and Sport: The Case of Croatia. In: Doupona Topič, M. & Ličen, S. (Ed). *Sport, Culture & Society: an Account of Views and Perspectives on Social Issues in a Continent (and Beyond)*. Ljubljana, Slovenia: University of Ljubljana, Faculty of Sport, pp.187-191.
3. Bartoluci, S. (2014). Uloga vrhunskog sporta u oblikovanju nacionalnog identiteta u Republici Hrvatskoj: usporedba devedesetih i dvijetisućitih. [The Role of High-Performance Sport in Shaping of National Identity in the Republic of Croatia: The Comparison of the 1990s and the 2000s]. Doctoral dissertation. Zagreb: Filozofski fakultet Sveučilišta u Zagrebu.
4. Bodin, D., Robène, L. & Héas, S. (2007). *Sport i nasilje u Europi* [Sport and violence in Europe]. Zagreb: Knjiga trgovina.
5. Coakley, J. (2009). *Sports in Society: Issues and Controversies*. 10th edition. McGraw Hill.
6. Hobsbawm, E. J. (1993). *Nacije i nacionalizam* [Nations and Nationalism]. Zagreb: Novi liber.
7. Perasović, B. (1995). Navijačko pleme – do nacije i natrag. [Football supporters tribe: Towards the nation and back]. *Erasmus*. Zagreb, 61-67.
8. Sekulić, D., Šporer, Ž., Hodson, R., Massey, G. & Županov, J. (2004). *Sukobi i tolerancija : Ogledi o društvenoj uvjetovanosti nacionalizma i demokracija* [Conflict and Tolerance. Studies on social determination of nationalism and democracy]. Zagreb: Naklada Jesenski i Turk, Hrvatsko sociološko društvo.
9. Smith, A. D. (1996). *Nacionalni identitet* [National Identity]. Beograd: Biblioteka XX vek.
10. Vrcan, S. (2003). *Nogomet – politika – nasilje. Ogledi iz sociologije nogometa* [Soccer –politics – violence. Essays on sociology of soccer]. Zagreb: Jesenski i Turk, Hrvatsko sociološko društvo.

ROLE AND SIGNIFICANCE OF THE INTERNATIONAL OLYMPIC ACADEMY FOR THE OLYMPIC MOVEMENT

Saša Ceraj

Croatian Olympic Academy, Zagreb, Croatia

Abstract

The International Olympic Academy, which marked the 50th anniversary of its operations in the dissemination of the Olympic values and development of Olympic education, presents the main focus of this article. Based on scientific research and historical context, it is trying to determine the significance of the International Olympic Academy for the Olympic Movement. The significance of the International Olympic Academy is reflected in its definition as a multicultural and interdisciplinary scientific and educational centre aiming at studying and teaching Olympism in its widest forms of existence. The foundations of the International Olympic Academy are recognized in the Ancient Greek ideal inspired by the ancient *gymnasium*, which formed the Olympic ideal, through balanced cultivation of the body, will and mind.

Key words: *Olympism, National Olympic Academies, Croatian Olympic Academy, International Olympic Committee, sport, history*

Introduction

The date taken as the official beginning of operations and the foundation of the International Olympic Academy (IOA) is 16 June 1961 (Georgiadis, 2011, p. 21), when the first Session for Young Participants was held, but the roots of the Olympic idea and the program determination of the IOA go back to the distant past, to the ancient times. The ancient idea spurred the revival of the Olympic Games and found its direction within the Olympic Movement through Olympism, which presented the pedagogical, moral and educational component of the Modern Olympic Games, introduced by Pierre de Coubertin. The International Olympic Academy is closely associated with the original ancient Greek idea, and this association is still fostered today and particularly evident in the program part of the IOA's work. Besides the program association, the ancient and Greek orientation of the International Olympic Academy is clearly recognized in its external signs, especially symbols, and the location of the IOA headquarters in Ancient Olympia, Greece, not far from the archaeological site, over which the spirit of the Ancient Olympic Games still hovers. The International Olympic Academy is a part of the Olympic Movement, and while the Olympic Games, featuring the world's best athletes, who present their achievements, are held throughout the world every four years, one must point out that the IOA is an institution founded with the goal to implement and promote the educational and intellectual context of the Olympic Games, that is, Olympism.

It was Coubertin, who, when reviving the Modern Olympic Games, defined sport as a means of forming physical, moral and intellectual abilities in young people, closely associating it with Olympism as a philosophical and educational determinant, as well as with the then *gentleman* value system and moral qualities defined by the term *religio athlete* as a new platform, which would find its determination in the term Olympic education. On that note, Coubertin wrote: „Olympism can become a school for moral nobility and purity as well as physical endurance and energy, but this can happen only if you continually raise your concept of athletic honour and impartiality to the level of your muscular ability“ (Müller, 2000, p. 560). This is how one can refer to Olympism as a link between Coubertin and the International Olympic Academy, because Coubertin set the pedagogical and educational guidelines of the International Olympic Committee's (IOC) work, introducing sport as a means of development, during his time as IOC President, and especially through the Congresses in Le Havre in 1897, Brussels in 1905, Paris in 1906, Lausanne in 1913 and Prague in 1925 (Koulouri, Georgiadis, 2011, p. 21). The mentioned orientation introduced by Coubertin and his ideas can be regarded as the corner stone of the future International Olympic Academy, the foundation of which he didn't live to see, but he certainly made a major contribution, which hasn't been forgotten. It was also officially recognized on 1 January 2013, when the whole world marked the 150th anniversary of Pierre de Coubertin's birth. Besides Coubertin, Ioannis Ketseas and Carl Diem also played a very important role in the foundation of the International Olympic Academy. They strongly advocated its foundation, which legally took place in 1955 (Koulouri, Georgiadis, 2011, p. 25).

Although founded in 1955, the year of 1961 is considered to be the beginning of its operations, when the first Session for Young Participants took place and the first informal guidelines for its activities were set (Koulouri, Georgiadis, 2011, p. 25); they defined the International Olympic Academy as an „international cultural centre in the sacred place where the idea of athletic contests was born and developed, so its aim shall be to maintain and spread the Olympic idea and its

ideals, thus contributing to the education and exercise of youth through the study and application of the pedagogic and social principles in sport“ (Koulouri, Georgiadis, 2011, p. 51).

Work Program of the International Olympic Academy

The International Olympic Academy implements its educational program through sessions, which take place at the IOA headquarters in Ancient Olympia, Greece, every year. Lecturers vary from eminent university professors coming from throughout the world to Olympic Movement officials and famous athletes. The work program of the International Olympic Academy is adopted annually and sent to the International Olympic Committee, National Olympic Committees, National Olympic Academies and other stakeholders of the Olympic Movement. Although the work program and the number of educational programs implemented by the International Olympic Academy have changed throughout history, one needs to distinguish between the IOA's international and national programs. Over the years, however, five of them have established themselves as the most important international educational programs: The Session for Young Participants, The Session for Educationists, The Session for Officials of National Olympic Committees and National Olympic Academies, The Seminar for Sports Journalists and The Olympic Studies Seminar for Postgraduate Students, among which The Master's Degree Program on Olympic Studies holds a special position (Koulouri, Georgiadis, 2011, p. 192).

The International Olympic Academy program that has been going on for the longest time and has included the most participants is the Session for Young Participants. It presents the International Olympic Academy's multicultural character and its role in today's world in the best way; based on its ancient roots, it connects nations and people through sport, but it also uses sport as a means of connecting it with education, culture and art, spreading the message of peace and tolerance in modern society. National Olympic Academies from throughout the world send young people to the Session for Young Participants to learn about the Olympic Movement and Olympism through educational programs. The program lasting two weeks includes classes and lectures, but also „discussion groups, educational trips, guided tours, art workshops, sports activities and social events are held, with the presentation of their individual cultural features by the participants“ (Koulouri, Georgiadis, 2011, p. 192).

The Session for Educationists is an International Olympic Academy program, which started as a local program in 1970, only to develop into an international program in 1973, including a large number of international participants and presenting a new orientation of the IOA and a greater step towards the area of education.

The Session for Officials of National Olympic Committees and National Olympic Academies is an International Olympic Academy program, which includes representatives of National Olympic Committees and National Olympic Academies. Besides lectures by eminent experts and professors on Olympism and various other topics, it includes annual work reports of each National Olympic Academy. The mentioned program is „an international forum for the exchange of views between representatives of the Academies, the encouragement of their collaboration, and the promotion of the setting up of more throughout the world“ (Koulouri, Georgiadis, 2011, p. 194), and it has become one of the primary goals of the International Olympic Academy, especially because of the significantly increased number of National Olympic Academies over the years, which can be seen as a result of the IOA's efforts and the fact that the International Olympic Committee and National Olympic Committees have recognized the importance of Olympic education.

The Seminar for Sports Journalists is a step towards spreading the interest area of the International Olympic Academy to more social areas after detecting the need to spread the knowledge on Olympism and Olympic ideals among various professions. The Session for Educators and Officials of Higher Institutions of Physical Education presents a stronger involvement of education and the promotion of Olympism among a larger number of sports officials, especially lecturers involved in the issues of Olympism, and it touches upon the area of higher education and an exchange of opinions and experiences among participants from the whole world.

The Olympic Studies Seminar for Postgraduate Students is an International Olympic Academy program intended for experts with a degree in various areas. It lasts one month and includes university professors coming from throughout the world, who hold lectures on sports in Ancient Greece in the first module, on the history of the Modern Olympic Games and modern Olympic Movement in the second, on the sociological context and phenomenology of the Olympic Games in the third, and on the philosophical approach to the Olympic Games in the fourth. At the end of the seminar, all participants must write a paper to the topic they have selected with their mentor and make a public presentation of the conclusions of their work.

It is also necessary to recognize the new international educational program titled The Master's Degree Program on Olympic Studies, started by the International Olympic Academy in cooperation with the University of the Peloponnese in 2009; with it, the IOA achieved the objective of founding an „Olympic University“ (Koulouri, Georgiadis, 2011, p. 189). The program is based on three main determinants of the Olympic Movement and Olympism: education, sport and culture, and it provides students with specialization in the field of the research of Olympism and Olympic education. The program is open to international and Greek graduate students, especially officials of National Olympic Committees, National Olympic Academies, the International Olympic Committee, European Olympic Committees and experts with a degree in kinesiology, economics, media and similar areas.

As an indicator of the IOA's work – besides the advances in quality – one must also take into account the quantitative data demonstrating the scope of its work. It is evident that 1,124 lecturers (of whom 976 men and 150 women) participated in it between 1960 and 2005. They held lectures on various topics, from the history of the Olympic Games, the Olympic idea, the history of the Modern Olympic Games and sport, the philosophy of sport, the influence of sport on fine and liberal arts, moral principles of sport, to those in the fields of kinesiology, medicine, biology, and similar. (Koulouri, Georgiadis, 2011, p. 235).

The Role of National Olympic Academies

National Olympic Academies (NOAs) present an integral part of the International Olympic Academy and the Olympic Movement, and their foundation and activities are stipulated by the Olympic Charter as one of the tasks of the International Olympic Committee and National Olympic Committees (The Olympic Charter, 2013, p.17, 57). The foundation of National Olympic Academies resulted from the need that emerged as the IOA's work spread and intensified. The goal was to provide assistance in the implementation of educational programs dedicated to disseminating the fundamental and educational principles of Olympism. Their original names were Olympic Studies Centres, but they were renamed to National Olympic Academies after 1976 (Koulouri, Georgiadis, 2011, p. 268).

Today, 46 years after the foundation of the first National Olympic Academy – the Spanish Olympic Academy in 1968 (Koulouri, Georgiadis, 2011, p. 274, Naul, 2008, p. 67) – the task of National Olympic Academies is „the cultivation and dissemination of the Olympic Ideal, together with the study and application of the universal pedagogic and social principles of the Olympic Movement, as defined in the Olympic Charter, through Olympic Education programmes, within the boundaries of the national and cultural zone in which each is active, in collaboration with the International Olympic Academy and the International Olympic Committee“ (Koulouri, Georgiadis, 2011, pp. 268-269, Karaiskou, 2012, pp. 4-5). As the task of each National Olympic Committee is to ensure the introduction of the Olympic principles to the public and their implementation in schools and educational institutions, each National Olympic Committee in each country – according to the provisions of the International Olympic Committee and the Olympic Charter – must found the National Olympic Academy and enable its work (Koulouri, Georgiadis, 2011, p. 271).

The importance and scope of the tasks of each National Olympic Academy are stipulated in detail by the International Olympic Academy, with a special focus on six major areas encompassing 33 most important programs (Karaiskou, 2012, p. 5). The significance of National Olympic Academies is also seen in the fact that 144 National Olympic Academies from all five continents are members of the International Olympic Academy today (Karaiskou, 2012, p.13). The Croatian Olympic Academy is also a part of the Olympic family; it was founded „at the 58th COC Council meeting in Zagreb on 27 June 1996“ (Jurkin Lugović, Jajčević, Drpić, 2006, p. 71) with the goal to promote cultural values, sports staff training, fair play and moral principles of the Olympic idea. It is necessary to point out that National Olympic Academies are the extended arms of the International Olympic Academy; they promote the values stipulated by the Olympic Charter, especially by implementing Olympic education, but their task is also to promote participation in sports „among all social and age groups and promote the idea of sport as a fundamental human right“ (Karaiskou, 2012, p. 5).

Conclusion

The significance, importance and role of the International Olympic Academy for the Olympic Movement is maybe best described by the words of one of the world's leading researchers in the field of Olympism and the IOA's activities, Professor Norbert Müller: „There are no other institutions which can be more compared with the IOA and its teaching methods. The mixture of recognized academics from basic specialized areas, well known sports scientists, practising athletes and top Olympic officials have extended the IOA clearly beyond the framework of other types of scientific congresses. No sports university or institute and no academic seminar has a similar, permanent framework and none is as meaningful: nowhere else can modern sport be discussed against such a stimulating backdrop as that of the Stadium in Olympia“ (Koulouri, Georgiadis 2011, p. 252). On that note, one can say that the International Olympic Academy was founded as an academic and educational centre for studying and teaching Olympism with a strong international and multicultural orientation focusing on the promotion of the Olympic ideal based on research and scientific and academic context.

One of the main goals of the International Olympic Academy is to increase the number of National Olympic Academies and their educational activities, especially Olympic education. As the International Olympic Committee provides strong support to the International Olympic Academy operations – and consequently to National Olympic Academies – further development of the Olympic Movement based on humanism and educational context presents the IOA's core area of activities and the „intellectual network of the International Olympic Academy in cooperation with National Olympic Academies is of utmost importance for the propagation of these ideas world wide“ (Karaiskou, 2012, p. 8). In line with that, it is necessary to point out that connecting culture, arts, education and sport will continue to be an important area of activities of the International Olympic Academy and National Olympic Academies, with a special emphasis on the fact that the International Olympic Academy and National Olympic Academies, through their activities, will continue to play a leading role for the Olympic Movement, especially in the field of the „fundamental moral principles of respect for others, fair play, equality, democracy and peace in the world“ (Karaiskou, 2012, p. 8).

References

1. Georgiadis, K. (2011). *50 years International Olympic Academy*. Athens: International Olympic Academy.
2. International Olympic Committee. (2013). *Olympic Charter*. Lausanne: IOC.
3. Jurkin Lugović, R., Jajčević, Z. Drpić, A. (2006). *On the Olympic Path*. Zagreb: Croatian Olympic Committee.
4. Karaiskou, A. (2012). *Directory of National Olympic Academies*. Athens: International Olympic Academy.
5. Koulouri, C., Georgiadis, K. (2011). *The International Olympic Academy. A History of an Olympic Institution*. Athens: International Olympic Academy.
6. Müller, N. (2000). *Pierre de Coubertin Olympism*. Lausanne: International Olympic Committee.
7. Naul, R. (2008). *Olympic Education*. Oxford: Meyer & Meyer Sport.

KARATEKAS OF VARIOUS STYLES PLACING ASSOCIATIONAL WORDS CONNECTED WITH TRAINING OF MARTIAL ART

Jitka Čihounková and Michal Vít

Masaryk University, Faculty of Sport Studies, Brno, Czech Republic

Abstract

The aim of the work is to identify factors that are important for trainees of different styles of karatedo. The focus group method were use to identify 56 terms, which were selected by q-sort. Subjects in all styles of karatedo agreed that most of their karatedo is associated with friendship, which in all styles of karatedo achieved an average score of 3 or higher. However, on the other side of the scale karate practitioners consistently placed the terms drug, aggression and negative emotions, which means that they definitely do not associate their karatedo with these terms. Important factors (excluded by factor analysis) of karate for our group are factors of non-competitive game, sport concept of karatedo, training obstacles, movement drill and decrease in motivation to performance.

Key words: Q sort, factor analysis, karatedo

Introduction

Karatedo, as well as other martial arts and combat sports, is fragmented into a number of styles and schools. The main motto of this martial art is plurality of options to achieve the same goal (G. Funakoshi: “There are many schools, karatedo is the only one”, M. Oyama, “just as one can climb the mountain by different routes, there are also more paths in karatedo to achieve the same peak”). The work should find common or differing perceptions of karatedo by trainees of various styles of this martial art and discuss this issue.

Karatedo today includes many styles, whose origin leads into two major Okinawan systems: Shorin ryu and Shorei ryu.

Shorin ryu is a generic term for Okinawa martial arts of external schools. The name has been developing as an umbrella term for styles included in them in the early 19th century. It indicates especially those styles whose typical features are fast movements and smooth combinations. Its formation is influenced by Chinese external styles (Shaolin). Shorin ryu forms the styles of the Shuri city (Shuri te) together with the styles of Tomari (Tomari te). Although the individual styles were different there was a good exchange of experience between the two cities and masters were learning from each other. Thus most of the later formed styles have been affected by the martial arts from both cities. Shorin ryu means a “pine forest school” and is the Okinawan pronunciation of Shaolin (Lind, 1996). It includes styles of shotokan ryu, wado ryu and shito ryu.

Beginning of karate development in Japan is connected with the name of Gichin Funakoshi, who is justly considered the father of modern karate by all adherents of this art. Funakoshi was a bridge between Okinawa and Japan.

Shotokan style is characterized by straightforward punches, blocks and kicks from low positions. It emphasizes right posture, right position of joints and formality of basic techniques. Basic techniques are defined in detail and the highest priority is assigned to their correct execution.

The founder of kyokushinkai is Masutacu Oyama who was born as Jong-I-Choi in South Korea. He studied kempo martial arts, boxing and judo, at the age of fifteen he became a student of Gichin Funakoshi and under his guidance he obtained the fourth dan. For two years he studied goju ryu as well. He compiled his style during his self-imposed isolation in the Japanese mountains, where he was training intensively more than a year. Kyokushinkai is considered the hardest style of karatedo, where the wrestling full contact unprotected competition (Oyama, 1997; von Rotz, 2000).

Shorei ryu is a summarizing term for all Okinawan martial systems that are derived from the Chinese internal school (Nei chya). The first school of this system was in Naha city (Naha te). It is characterized mainly by postures anchored on the ground and special breathing techniques (Ibuki and Nogare). Movements are less rapid than in Shorin ryu, but they are in perfect harmony with breathing. The largest systems classified in Shorei ryu are Goju ryu and Uechi ryu (Lind, 1996).

Goju ryu is today known as one of the four major Japanese karate systems, though having the Okinawan origin in Naha te. Chogun Miyagi is considered its founder. Although the foundations were laid earlier, it was officially registered as a style in 1933. The name Goju ryu was first used in 1929 and it means hard - soft. The emphasis is on precise coordination of movement with breath (Strand, 2008).

Methods

The work builds on the results of a specific research project called *Fight, dance, ritual*, no. **MUNI/A/0989/2010** implemented at the Faculty of Sports Studies in the period from 1/2011 to 12/ 2011. It involved six doctoral students and observed a long-term plan of the Faculty of Sports Studies of Masaryk University. Within the project via help of a „Focus group“ method a group of terms was gained, which were further analysed and 56 of them were selected for the Q-sort method (W. Stephenson) which allows to evaluate quantitatively the qualitative data. The subjects placed the individual terms in the template boxes of the Q-sort according to their relationship to karatedo (-5 standing for the weakest relationship - +5 standing for the strongest relationship, all terms in one column having the same weight), so that all words were used and all boxes were full. Partial results of the project have already been published mostly in English (Nejedlá, Reguli, Vít, Čihounková, & Mlejnková, 2011; Reguli, Jalovega, Vít, & Čihounková, 2011; Tumová & Reguli, 2011; Chvátalová & Reguli, 2011; Chvátalová, Nejedlá, & Reguli, 2012; Reguli, Vít, & Chvátalová, 2012; Vít, Reguli, & Chvátalová, 2012; Nejedlá & Reguli, 2011). Simultaneously with the project *Fight, dance, ritual* the work *Spirituality of physical activity* was being produced (Hurych et al., 2013), which is one of the most important literary sources of the work.

The data from the Q-sort were processed via a factor analysis in a Statistica Cz program for the whole research sample.

The aim of the work is to identify factors that are important for trainees of different styles of karatedo.

The research group consists of karatedo practitioners over 18 years of age who have been actively involved in karatedo training at least within the last 5 years, during which most karatedo practitioners have achieved higher technical degrees. Throughout the Czech Republic a total of 34 karatedo clubs dedicated to the styles of shotokan and goju ryu (19 of them cooperating) were addressed. From the style of kyokushinkai the whole Czech representation of the 16 clubs registered in the Czech Republic completed the Q-sort. In some clubs there were no subjects who would meet our criteria. Totally, the Q-sort was completed by 62 subjects from the listed styles of karatedo.

Results and discussion

The average score gained by the individual variables was calculated for each style of karatedo. Terms that reached the score of 2.5 and higher for positive placement in the template of the Q-sort and -2.5 and lower for negative placement in the template of the Q-sort have been marked in bold.

The average score for each variable was calculated also indiscriminately of the style. Values that are found in all different styles of karatedo have been marked in bold.

Shotokan:

positive values: **friendship** (3.0), **self-improvement** (2.8), training (2.4), condition (2.0)

negative values: **drug** (-2.8), **negative emotions** (-2.7), aggression (-2.3), dance (-2.3), shower (-2.2)

Goju ryu:

positive values: **friendship** (3.3), **joy** (3.3), positive emotions (2.8), freedom (2.2), love (2.1), energy (2.1)

negative values: **aggression** (-3.7), **injury** (-3.2), **drug** (-2.7), **alcohol** (-2.5), **addiction** (-2.5), dance (-2.4), pain (-2.4), negative emotions (-2.4)

Kyokushinkai:

positive values: **life** (4.0), **love** (3.7), **friendship** (3.7), **joy** (2.9), **freedom** (2.8), trust (2.4), training (2.3), fun (2.2), courage (2.0), lifelong journey (2.0), self-improvement (2.0)

negative values: **drug** (-4.5), **addiction** (-3.2), **aggression** (-3.0), **injury** (-2.9), **negative emotions** (-2.6), exhibitionism (-2.4), bruise (-2.3), dance (-2.2), escape from reality (-2.1), foreign words (-2.0), audience (-2.0), pain (-2.0)

all styles:

positive values: **friendship** (3.2), self-improvement (2.3), joy (2.2), training (2.1), life (2)

negative values: **drug** (-3.3), **aggression** (-2.9), **negative emotions** (-2.6), addiction (-2.4), injury (-2.3), alcohol (-2.3), dance (-2.3)

Subjects in all styles of karatedo agreed that most of their karatedo is associated with friendship, which in all styles of karatedo achieved an average score of 3 or higher. One of the conditions of participation in the research except for the age of majority was also minimally 5 last years spent by training karatedo, which inevitably brings social ties in the training group. Hardly anyone would keep a leisure activity for five years, if they did not find any friends in the group.

However, on the other side of the scale karatedo practitioners consistently placed the terms drug, aggression and negative emotions, which means that they definitely do not associate their karatedo with these terms. Designation of sport

or leisure activities as drugs rather comes from the environment of street dance, whose leaders were in the specific research on which the dissertation builds also included. It is therefore not surprising that karatedo practitioners do not identify with this term. Moreover, karatedo practitioners do not associate this aggression with karatedo as well, which corresponds to the basic philosophy. The full contact karatedo style is also not aggressive. Although training and competition stress in karatedo often hurts and is associated with failure, the subjects in our research do not link it with negative emotions.

Determining factors

Using a method of principal components the number of searched factors was determined as 5 that explain variability of 42.3%, which is a satisfactory number for our needs.

Using factor analysis, we extracted and named 5 new latent variables.

The first factor significantly negatively correlates with variables of aggression (-0.740212), pain (-0.758587), and negative emotions (-0.658579). We can mark it as *a factor in the non-competitive match*. In karatedo and other martial arts such friendly fights are called randori. Combats are used by both partners for mutual development and learning. They are approached in accordance with the karatedo ethics with respect to competitors and teaching of the inexperienced by the experienced is often implemented in this combat when the experienced highlights the mistakes and the signals sent to the opponent.

The second factor significantly negatively correlates with variables of philosophy (-0.726356), technique (-0.775098), and tradition (-0.607638). This factor can be identified as *a factor of sports concept of karatedo*. Philosophy, tradition and precise technique characterize mainly the traditional concept of karatedo which is gradually disappearing from sports forms of martial arts under the pressure of rapid success of talented athletes and impatience characteristic of today's hectic lifestyle.

The third factor positively correlates with variables of sweat (0.659576), foreign words (0.685056) and time consumption (0.607222), negatively with a variable of lifelong journey (-0.653738). It can be identified as *a factor of training obstacles*. Sweat is an obstacle for teenagers who want to “look good” even while training, foreign words limit the understanding of the guidelines and are limiting for the older population starting with karatedo and the time-consuming factor is a source of frustration for working middle layer struggling to balance work responsibilities, hobbies and family life in an effective way. The fact that karatedo is a lifelong journey on the other side, calms down trainees regardless of age.

The fourth factor negatively correlates with variables of relaxation (-0.700860) and expression (-0.622437). This factor can be identified as *a factor of the locomotive drill* which leaves no room for either of the variables.

The fifth factor positively correlates with the variable of fatigue (0.627918), negatively with the variable of the audience (-0.650875). The fifth factor can be identified as *a factor of the decline of motivation to performance*. With increasing fatigue motivation to performance decreases, conversely the presence of the audience often excites the trainee to perform better.

Conclusion

The basic statistical analysis based on the average scores of the individual variables implies conformity of the subjects of all styles showing that their karatedo is mostly associated with friendship which in all styles of karatedo achieved an average score of 3 or higher. On the other side of the scale karatedo practitioners consistently placed the concepts of drug, aggression and negative emotions.

Important factors of karatedo for our group are factors of non-competitive game, sport concept of karatedo, training obstacles, movement drill and decrease in motivation to performance.

References

1. Hurych, E., Jirásek, I., Nesti, M., Parry, J., Robinson, S., Sekot, A., a další. (2013). *Spiritualita pohybových aktivit*. Brno: Masarykova univerzita.
2. Chvátalová, J., & Reguli, Z. (5 2011). What does karate mean for them? *Studia sportiva*, stránky 217-220.
3. Chvátalová, J., Nejedlá, L., & Reguli, Z. (2012). Analysis of Irish dancers' and karate practitioners' attitude to Irish dance and karate. *Game, Drama, Ritual in Martial Arts and Combat Sports*. Genova.
4. Jakhel, R. (1992). *Moderní sportovní karate*. Svitavy: LUPA.
5. Lind, W. (1996). *Tradice karate*. Brno: Comenius.
6. Nejedlá, L., & Reguli, Z. (5 2011). What is in Their Mind: Analysis of Dancers Mindset to Irish Dance. *Studia Sportiva*, stránky 241-242.
7. Nejedlá, L., Reguli, Z., Vít, M., Čihounková, J., & Mlejnková, L. (2011). What is in their mind: Analysis of various martial artist group. *Scientific Congress on Martial Arts and Combat Sports*, (stránky 82-83). Visou.

8. Oyama, M. (1997). *Cesta kyokushin*. Brno: Comenius.
9. Reguli, Z., Jalovega, M., Vit, M., & Čihounková, J. (2011). Ritualism in the Microcosm of Aikido Dojo. *Scientific Congress on Martial Arts and Combat Sports*, (pp. 97-98). Viseu.
10. Reguli, Z., Vit, M., & Chvátalová, J. (2012). Sacralization of Fight. *Game, Drama, Ritual in Martial Arts and Combat Sports*. Genova.
11. Strnad, K. (2008). *Karate: cesta k prvnímu danu*. Praha: Grada.
12. Tumová, V., & Reguli, Z. (2011). Not only dancing: lifestyle and culture in the phenomenon of streetdance battle. *Scientific Congress on Martial Arts and Combat Sports*, (stránky 128-129). Viseu.
13. Vit, M., Reguli, Z., & Chvátalová, J. (2012). Ethics of scenario training in self-defence class. *Game, Drama, Ritual in Martial Arts and Combat Sports*. Genova.
14. von Rotz, P. (2000). *Kyokushin karate*. Beckenried: Dynamik Trading.

PHYSICAL SELF-CONCEPT IN ADOLESCENT ATHLETES: RELATION TO GENDER, AGE, TYPE OF SPORT AND TRAINING FREQUENCY

Petra Dolenc

University of Primorska, Slovenia

Abstract

The purpose of the study was to examine physical self-perceptions in adolescent athletes according to gender, age, type of sport and frequency of exercise. The sample consisted of 140 Slovenian student-athletes aged 15–19 years. The Slovenian version of the Physical Self-Description Questionnaire (PSDQ-SL) was used to measure multidimensional physical self-concept. The results indicated that males had higher scores in perceived appearance, strength, endurance, global physical self and reported greater body weight satisfaction compared to female athletes. Older athletes exhibited higher scores in perceived health and strength than younger athletes. Results also showed differences in physical self-perceptions with regard to type of sport: athletes of individual sports had higher scores in perceived coordination, flexibility, strength, and endurance compared to team sport athletes. Furthermore, significant positive correlations were found between the number of training hours per week and some dimensions of the PSDQ-SL. Results suggest that in the case of physical self young athletes are not a homogeneous group. In particular, gender differences should be considered when examining physical self among athletes.

Key words: *physical self-concept, sport, adolescents, gender, team sports, individual sports*

Introduction

Self-concept is one of the most extensively studied psychological constructs, defined as a set of descriptive and evaluative statements about oneself (Harter & Whitesell, 2003). Physical self-concept represents an important component of the overall self-concept, and includes different characteristics, such as physical activity, physical condition, health and appearance (Marsh et al., 1994). In the field of physical activity and sport, physical self-concept can be viewed either as a mediating factor, that allows the acquisition of motor competences and promotes sport participation or as a result of exercise (Marsh, Chanal & Sarrazin, 2006). Physical self-concept plays a crucial role in adolescence, when many changes occur to the body. Thus, maintaining and developing a positive physical self during this period contributes to better mental health and well-being of youth (Mañano, Ninot & Bilard, 2004).

In the last decade, a great amount of studies examined the relationship between physical self-concept of children and adolescents and their level of physical activity (Moreno, Cervelló & Moreno, 2008). Research findings quite consistently indicated that adolescents involved in regular and organized exercise have more favourable physical self-perceptions, especially in terms of perceived motor abilities and body attractiveness compared to their less active or sedentary peers (Dolenc, 2011; Lazarević, Radisavljević & Milanović, 2008; Moreno et al., 2008). Also, significant correlations were observed between objective measures of physical fitness and physical self-concept (Carraro, Scarpa & Ventura, 2010). However, very little research has been done on physical self-perceptions in young athlete population, particularly in relation to gender and type of sport.

Contemporary concepts of the physical self emphasize its multidimensional and hierarchical structure (Eснаоla, Infante & Zulaika, 2011). A number of instruments have been developed to assess physical self-concept in children and adolescents. Among these instruments, the most widely used are the Physical Self-Perception Profile (PSPP; Fox & Corbin, 1989) and the Physical Self-Description Questionnaire (PSDQ; Marsh et al., 1994). The latter was validated in various adolescent samples and used in different sociocultural contexts.

The present study was primarily focused on determining the differences in multidimensional physical self-concept between male and female athletes, and athletes of individual and team sports, using the PSDQ-SL questionnaire.

Methods

Participants

The sample included 140 young athletes (70 girls and 70 boys) of different sport disciplines aged between 15 and 19 years ($M = 16.6$; $SD = 1.1$) who attended sports classes of three gymnasiums in Slovenia. All participants were engaged in regular and organized sport practice in sports clubs at least three times a week for the past twelve months. Among them,

there were 76 team-sport athletes (basketball, volleyball, soccer, handball) and 64 individual-sport athletes (athletics, swimming, rowing, gymnastics, sailing, archery, cycling). The average training frequency was 11.4 hours per week ($SD = 4.4$).

The school staffs were informed about the purpose of the study. A written consent to participate was also obtained from the participants and their parents. The study was approved by the Ethics committee for sport at the Faculty of sport, University of Ljubljana.

Instrument

The Slovenian version of the Physical Self-Description Questionnaire (PSDQ-SL; Dolenc, 2011) was used to assess multidimensional physical self-concept. Previously, we obtained the permission to translate the questionnaire from H. Marsh, the author of the original version. The PSDQ (Marsh et al., 1994) is a 70-item instrument designed for adolescents between 12 and 18 years, and measures nine specific components: Appearance (being attractive), Body Fat (not being overweight, satisfied with body weight), Physical Activity (doing a lot of physical activity regularly), Strength (being strong, having a powerful body with lots of muscles), Coordination (being good at coordinated movements), Flexibility (being able to bend and turn one's body in different directions), Endurance (being able to run for a long time without stopping), Sport Competence (being good at sports, having good sports skills), Health (not getting sick very often), and two more general dimensions: Global Physical Self (feeling positive about one's physical self), and Self-Esteem (the overall emotional evaluation of his/her own worth). Participants respond to the items using a 6-point rating scale, where higher values indicate a higher perceived competence and a more positive self-concept. Psychometric properties of the PSDQ-SL were determined on a larger sample of older primary school pupils. Confirmatory factor analysis confirmed the 11-factor structure of the original PSDQ questionnaire. Internal consistency coefficients for the PSDQ-SL subscales ranged from 0.81 to 0.90, indicating a high reliability of the instrument (Dolenc, 2011).

Statistical analysis

The data was analysed with the software package SPSS. The independent-samples *t*-test was used to determine the differences in PSDQ-SL dimensions between specific groups of athletes. Pearson's correlation coefficient was calculated to establish the relationship between PSDQ-SL dimensions and training frequency.

Results

Gender differences in physical self-concept among young athletes are presented in the Table 1. Male athletes had higher scores in the Global Physical Self and four specific component: Appearance, Strength, Endurance and Body Fat compared to female athletes.

Table 1: Differences in physical self-concept between male and female athletes

PSDQ-SL	Female athletes		Male athletes		<i>t</i>	<i>p</i>
	<i>M</i>	<i>SD</i>	<i>M</i>	<i>SD</i>		
Health	4.70	0.81	4.65	0.80	-0.33	0.744
Coordination	4.85	0.68	4.93	0.76	0.67	0.506
Physical Activity	5.64	0.48	5.70	0.45	0.79	0.434
Body Fat	4.38	1.13	4.99	1.00	3.43	0.001
Sport Competence	4.69	0.78	4.90	0.78	1.54	0.127
Global Physical Self	4.33	1.13	4.97	0.76	3.99	0.000
Appearance	4.27	0.98	4.86	0.75	4.02	0.000
Strength	4.29	0.87	4.90	0.86	4.18	0.000
Flexibility	4.95	0.94	4.96	0.83	0.03	0.974
Endurance	4.44	1.15	4.98	1.07	2.91	0.004
Self-Esteem	4.86	0.67	5.04	0.63	1.59	0.115

Age and type of sport related differences among adolescent athletes were also investigated (table 2). Older adolescents achieved significantly higher scores in Health and Strength components compared to younger adolescents. Athletes in individual sports scored significantly higher in Coordination, Flexibility, Strength and Endurance compared to athletes in team sports.

The number of training hours per week was positively correlated with the following dimensions of the PSDQ-SL: Sport Competence ($r = 0.24$; $p = 0.005$), Global Physical Self ($r = 0.31$; $p = 0.000$), Appearance ($r = 0.29$; $p = 0.000$), Endurance ($r = 0.26$; $p = 0.002$), Strength ($r = 0.28$; $p = 0.001$) and Self-Esteem ($r = 0.22$; $p = 0.011$).

Table 2: Summary of significant differences in physical self-concept between the athlete groups

Variable	PSDQ-SL	Athlete groups	Statistical test
AGE	Health	15, 16 years: $M = 4.48$; $SD = 0.87$ 17, 18, 19 years: $M = 4.87$; $SD = 0.69$	$t = -2.94$ $p = 0.000$
	Strength	15, 16 years: $M = 4.41$; $SD = 0.96$ 17, 18, 19 years: $M = 4.78$; $SD = 0.82$	$t = -2.41$ $p = 0.000$
	Coordination	Individual sports: $M = 5.03$; $SD = 0.64$ Team sports: $M = 4.77$; $SD = 0.76$	$t = 2.12$ $p = 0.036$
TYPE OF SPORT	Strength	Individual sports: $M = 4.77$; $SD = 0.82$ Team sports: $M = 4.44$; $SD = 0.96$	$t = 2.22$ $p = 0.028$
	Flexibility	Individual sports: $M = 5.13$; $SD = 0.79$ Team sports: $M = 4.81$; $SD = 0.93$	$t = 2.13$ $p = 0.035$
	Endurance	Individual sports: $M = 4.96$; $SD = 1.04$ Team sports: $M = 4.50$; $SD = 1.18$	$t = 2.431$ $p = 0.016$

Discussion and conclusions

The aim of the present study was to investigate the physical self-concept in Slovenian adolescent athletes. Boys perceived themselves as more attractive and satisfied with their body compared to girls. Boys also reported significantly higher perceived endurance and strength and showed a more positive global physical self than girls. There were no differences between boys and girls in other specific components, as well as in their self-esteem. These results are mostly in line with a large number of studies that have analysed physical self-perceptions in adolescent non-athletes using the PSDQ questionnaire (Klomsten, Skaalvik & Espnes 2004; Lazarević, et al., 2008; Mañano et al., 2004), although these studies have revealed significantly higher physical self-concept in boys than in girls in almost all components of the PSDQ. This might suggest that there are less gender differences among adolescent athletes compared to non-athlete groups, possibly indicating that physical activity/sports can be an important factor in reducing gender differences in physical self. It is very difficult to find a clear explanation for these differences; some discrepancies can be largely explained by biological factors (e.g. strength), but are not sufficient to clarify all gender differences observed in sport performance and participation. Thus, psychosocial determinants should also be considered. In particular, the role of gender stereotypes in gender differences in sport and exercise has been extensively investigated, showing that stereotypes are internalized into the self during the socialization process (Chalabaev et al., 2013).

Some significant differences in physical self-concept were also observed in relation to type of sport. Athletes of individual sports perceived their body as stronger, more flexible, robust and coordinated compared to athletes in team sports. It should be noted that the two groups differed only in the subscales related to motor abilities, but not in the other aspects, such as perceived appearance, health and body weight satisfaction, as well as overall self-esteem. Perhaps, the obtained differences can be explained by characteristics of individual and team sports and related training procedures. It can be, however, that these results were at least partially related to the amount of sports training. The exercise frequency (in terms of numbers of training hours per week) was generally higher among athletes who participate in individual sports. More frequent activity could mean more opportunities for the development of different motor abilities, which in turn leads to a more favourable perception of motor competences.

It can be assumed that besides gender, specific characteristics of sports exercise (e.g. intensity and duration of training, type of sport) should be taken into account when investigating self-concept in the physical domain among young athletes.

References

- Carraro, A., Scarpa, S., & Ventura, L. (2010). Relationships between self-concept and physical fitness in Italian adolescents. *Perceptual and Motor Skills*, 110 (2), 522–530.
- Chalabaev, A., Sarrazin, P., Fontayne, P., Boiché, J., & Clément-Guilhotin, C. (2013). The influence of sex stereotypes and gender roles on participation and performance in sport and exercise: Review and future directions. *Psychology of Sport and Exercise*, 14 (2), 136–144.
- Dolenc, P. (2011). Physical self-concept and coping with stress among sport-active adolescents and their inactive peers [Telesna samopodoba in spoprijemanje s stresom pri športno aktivnih mladostnikih in njihovih neaktivnih vrstnikih]. Unpublished doctoral dissertation. Ljubljana: University of Ljubljana. Faculty of Arts.

4. Esnaola, I., Infante, G., & Zulaika, L. (2011). The multidimensional structure of physical self-concept. *The Spanish Journal of Psychology*, 14 (1), 304–312.
5. Fox, K. R., & Corbin, C. B. (1989). The Physical Self- Perception Profile: Development and preliminary validation. *Journal of Exercise and Sport Psychology*, 11, 408–430.
6. Harter, S., & Whitesell, N. R. (2003). Beyond the debate: Why some adolescents report stable self-worth over time and situation, whereas others report changes in self-worth. *Journal of personality* 71 (6), 1027– 1058.
7. Klomsten, A. T., Skaalvik, E. M., & Espnes, G. A. (2004). Physical self-concept and sports: do gender differences still exist? *Sex Roles*, 50, 119–127.
8. Lazarević, D., Radisavljević, S., & Milanović, I. (2008). Relations between physical self-concept and physical exercise of primary school pupils. *Zbornik Instituta za Pedagoška Istraživanja*, 40 (1), 306–326.
9. Mañano, C., Ninot, G., & Bilard, J. (2004). Age and gender effects on global self-esteem and physical self-perception in adolescents. *European Physical Education Review*, 10, 53–69.
10. Marsh, H. W., Chanal, J. P., & Sarrazin, P. G. (2006). Self-belief does make a difference: A reciprocal effects model of the causal ordering of physical self-concept and gymnastics performance. *Journal of Sports Sciences*, 24 (1), 101–111.
11. Marsh, H. W., Richards, G., Johnson, S., Roche, L., & Tremayne, P. (1994). Physical Self-Description Questionnaire: Psychometric properties and a multitrait-multimethod analysis of relations to existing instruments. *Journal of Sport and Exercise Psychology*, 16, 270–305.
12. Moreno, J. A., Cervelló, E., & Moreno, R. (2008). The importance of physical-sport practice and gender in physical self-concept from 9 up to 23 years. *International Journal of Clinical and Health Psychology*, 8 (1), 171–183.

MOTIVES AND ATTITUDES OF NURSING HOME RESIDENTS TOWARDS EXERCISING IN THE SENIOR EXERCISE PARK: A PRELIMINARY REPORT

Tjaša Gerževič¹ and Mitja Gerževič²

¹Elementary School Koper, Advisory Centre for Children, Adolescents and Parents, Koper, Slovenia

²University of Primorska, Science and Research Centre, Institute for Kinesiology Research, Koper, Slovenia

Abstract

The aim of this study was to evaluate the motives and attitudes of residents of the Ljubljana Šiška Nursing Home towards exercising in the Senior Exercise Park (SEP). Fifty volunteers (79.3 ± 8.4 years; 80.0% women) filled out a questionnaire where 25 of them were exercising in the SEP. Basic statistics with frequency distribution of responses are presented in this preliminary report. The results have shown that the most frequent motivational factors for exercising in the SEP were medical (health) factors (36%), challenge/benefit (32%) and curiosity (24%). Among the reasons why some residents had not engaged in the SEP exercise, the most frequently mentioned were health problems and physical/motor difficulties (52%) and the lack of interest (44%). The analysis of attitudes towards SEP exercise showed that among all kind of home's activities, the SEP exercise was, besides walking (32%), the most frequently chosen activity (32%). Based on the respondents' opinion the main benefit of the SEP practice was the ability to perform everyday tasks much easier (24%), feeling better and being in a better mood (20%). It can be concluded that SEPs in the nursing homes can represent an important achievement, because it could significantly contribute to the increase in PA of its residents. In addition, it could have an indirect positive effect on their health and overall home's atmosphere.

Key words: elderly, Nursing Home, physical activity, Exercise Park, motivation, attitude

Introduction

Physical activity is decreasing with aging. Besides the obvious degenerative decline of physical functions in old age, the growing presence of health problems and an increasing intake of medicines (Strojnik, 2010), older people are less interested in sport which is slowly replaced by less demanding activities, such as watching TV, gardening, domestic chores, etc. The opportunities to engage in sport activities are narrowing (Tokarski, 2004). Fortunately this is changing because of the increasing awareness of the importance and positive effects of PA on the medical and psycho-social status of the elderly (Jiménez-Beatty Navarro et al., 2007). This is happening both in terms of equipment, facilities and infrastructure as well as in terms of finding new approaches which could be used to encourage the elderly to become physically active. Therefore, it is necessary to know what motivates elderly people the most.

Organisers and promoters of PA are becoming more aware of the important impact that outdoor exercise, attractive and safe equipment and infrastructure have on motivation, even in the case of the elderly. For this reason the popularity of the so called Senior Exercise Parks or Outdoor Fitness Parks for the elderly is increasing. Senior Exercise Park (SEP) is a general name for outdoor exercise stations that are adapted to special and individual needs, abilities and performance of the elderly and/or frail people (Strojnik, 2007). They allow maintaining or improving strength, flexibility and balance as well as co-ordination, precision (fine motor skills) and mobility. Beside this it is also a place where older adults can socialise and actively spend their free time in fresh air (Strojnik, 2007).

Even if the understanding of the motivational factors affecting PA of the elderly is a prerequisite for any effective exercise programme design/prescription, until recently there were just a few studies in this field (Baranowski, Anderson & Carmack, 1998, in Kolt et al., 2004; Paxton, Browning & Connell, 1997, in Kolt et al., 2004). According to Kolt et al. (2004), who implemented the one of the first detailed study on the subject, there are six motivational factors: social, fitness, recognition, challenge/benefit, medical and involvement. The predominant reasons reported by 815 community dwelling older adults (63.6 ± 7.8 years, 49.0% men) who were regular exercisers related to health, fitness, enjoyment in the activity, and relaxation, all of which were rated as very important by more than half of the sample. This study (Kolt et al., 2004) identified also several differences in participation motives based on gender, age, occupation, and education level among older adults.

However, the open question is, if the motivational factors are the same for those older adults who live in nursing homes. Considering that these people are less independent and probably have more accompanying health problems in comparison to those living at their own homes, the involvement in PA could have greater limitations. On the other hand the activities in nursing homes could perhaps be better organised and managed and also more accessible. If we compare studies of Cohen-Mansfield et al. (2003), Jiménez-Beatty Navarro et al. (2007), Moschny et al. (2011) and Myiake and Rodgers (2009), it could be noticed that there are similarities between the two groups of the elderly only in the reasons for the non-inclusion in PA.

In the present study we were interested in the attitudes of the residents of the Ljubljana Šiška Nursing Home towards exercising in the SEP. Our goal was to find out, which are the motives that encourage or stimulate some of the residents to exercise in the SEP and why some others do not engage in exercising in the SEP. It was also verified if sporting or PA habits from the past (when they were young) have any influence on exercising in the SEP. Finally, we wanted to establish how popular and useful is exercising in the SEP in comparison with other (physical) activities in the home.

This paper presents only a part of the results of the whole study, based on the analysis done until the submission deadline. It includes: a) the most common motivational factors for exercising in the SEP, b) the reasons for non-inclusion in SEP exercise and c) attitudes towards SEP exercise. These findings can be used in developing relevant exercise and physical activity programmes for the growing population of the elderly.

Methods

Fifty residents of the Ljubljana Šiška Nursing Home (40 women and 10 men, age 79.3 ± 8.4 years) were voluntarily included in the study. The subjects were split in two groups; 25 who exercised and 25 who did not exercise in the SEP. There were 22 women and 3 men (age 79.3 ± 8.9 years) in the first group and 18 women and 7 men (age 79.4 ± 8.0) in the second group.

To achieve the objectives of the study, a questionnaire that was designed specifically for this purpose was used. It was divided in four sections with open and closed type questions: i) General information about the respondent, ii) Motives and motivation for engaging in SEP exercise, iii) Frequency, regularity and graduation of exercise in the SEP and iv) Attitudes towards SEP exercise. The survey was conducted with each resident individually at the Home. The interviewer asked questions and also wrote the answers in the survey form.

The data were analysed with the SPSS 19.0 statistical package for Windows (IBM Corporation, New York, U.S.A.). Because of the preliminary nature of the results, only descriptive statistics with frequency distributions are presented.

Results

The answers to the question: “*Why did you decide to exercise in the Senior Exercise Park?*” (open type, multiple-choice question) were post-hoc classified in six categories of motivational factors (reasons) according to Kolt et al. (2004). By frequency they followed as: i) medical factor (36.0%; N = 9), which referred to the desire for stretching and maintaining health, ii) challenge/benefit (32.0%; N = 8) that was linked to the fact that exercise brings benefit, that people feel better and gain strength when exercising and to the individual desire for walking. Further factors (reasons) were iii) involvement (20.0%; N = 5), which referred to outdoor exercise or exercising in fresh air and spending time, iv) social factor (12.0%; N = 3) referred to the desire for socialising with peers, while the v) fitness factor (12.0%; N = 3) was linked to the people’s own examination of physical fitness and abilities through exercise as well as to their feeling of being able to exercise. The factor of recognition was not detected in the present study. However, curiosity (24.0%; N = 6), which was not observed by Kolt et al. (2004), showed to be quite a frequently stated reason (motive) for the involvement in SEP exercise (Figure 1a).

The answers to the question: “*Why do you not exercise in the Senior Exercise Park?*” (open type, multiple-choice question) were also post-hoc grouped in five categories. The most frequent were i) health problems and physical/motor difficulties (52.0%, N = 13), which referred to the inability of walking, weakness for being able to exercise (practice), vision problems, lower back pain, feeling of insufficient fitness for exercising, constant vertigos, wire in the knee, Alzheimer’s disease, injury and heart disease. The second category was ii) lack of interest for practice in the SEP (44.0%, N = 11), where participants stated that they are not interested in exercising or exercise stations and that they do not need to exercise neither they feel any joy or desire for exercising. The following category was iii) exercising elsewhere (8.0%, N=2) and the participants answered that they stretch enough already when going for a walk or when exercising elsewhere, not in the SEP. The fourth category was iv) short length of stay in the home (8.0%, N = 2) and the last one was v) the belief in the ineffectiveness of exercise (4.0%, N = 1) (Figure 1b).

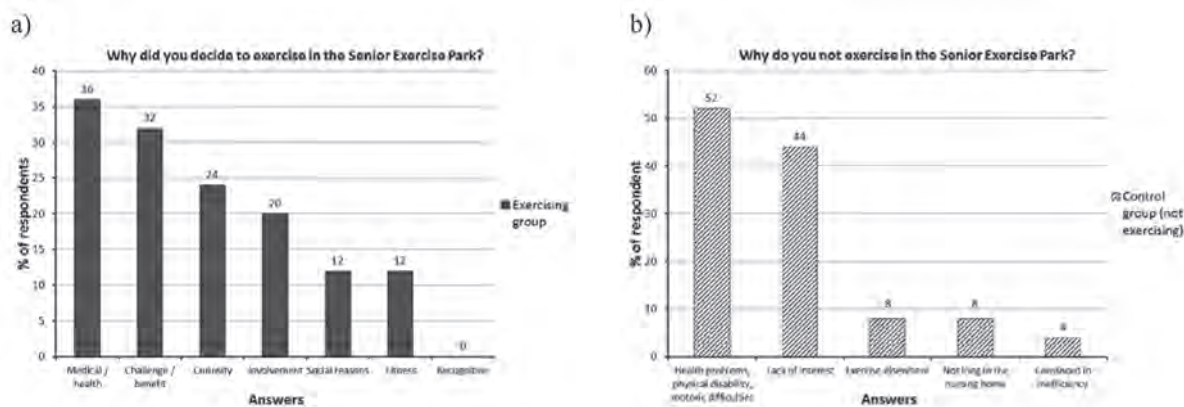

Figure 1: Frequency distribution (% of respondents) of a) motivational factors for engaging and practicing in the Senior Exercise Park and b) reasons why participants did not practice in the Senior Exercise Park.

Among all kind of home’s activities it was shown that the highest percentage of participants most likely practice in the SEP (32.0%, N = 8) and go for a walk (32.0%, N = 8). This is followed by physiotherapy (20.0%, N = 20), morning exercise/gymnastics (8.0%, N = 2) and with the same percentage (4%, N = 1) working therapy and indoor cycling (Figure 2).

The answers to the question: “How does exercising in the SEP help you?” (closed type, multiple-choice question) are presented in Table 1. The most frequent answer was that the participants easily perform everyday tasks (24.0%, N = 6), followed by feeling better and being in a better mood (20.0%, N = 5). However, 16.0% (N = 4) of the answers were that SEP exercise does not help them at all.

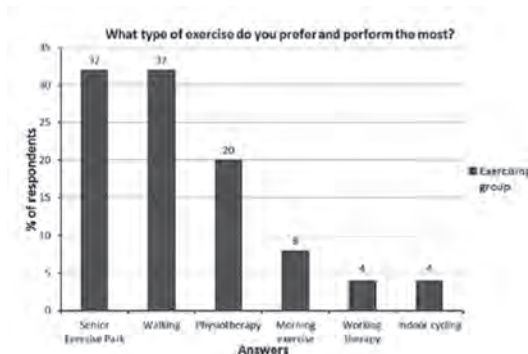

Figure 2: Frequency distribution (% of respondents) of the type of exercise that participants (the group that practiced in the Senior Exercise Park) preferred and performed the most.

Table 1: Frequencies (in percentages (%) and total number (N)) for each of the given answers (a–i) to the question, whether exercising in the Senior Exercise Park helps and how it helps (multiple-choice closed type question).

Answer	%	N
a) It does not help me.	16	4
b) It enables me to perform everyday tasks much easier.	24	6
c) I no longer have problems with sleeping.	4	1
d) The presence of pain is smaller.	16	4
e) My digestion has improved.	0	0
f) Before exercising in the SEP, I needed support when walking; now I no longer need it.	12	3
g) My balance has improved.	16	4
h) I feel better and I am in a better mood.	20	5
i) Other: entertainment, being in fresh air, I improved the deteriorating part of my body, I started walking with stilts/walkers.	20	5

Note: Each respondent gave at least one answer.

Discussion and conclusions

In this study we examined the motives and attitudes of fifty elderly people living in Ljubljana Šiška Nursing Home towards exercising in the SEP. The aim was to determine the main reasons that encouraged residents to join the exercise in the SEP or not and how often and how regularly they have implemented this form of exercise. We also checked out if PA of home residents in the past was related to their involvement in PA in the SEP now when they are older. And last but not least, we wanted to establish how popular and useful exercising in the SEP was according to other forms of exercise carried out at the nursing home. However, in this preliminary report only a part of the results of the whole study are presented, namely a) the most common motivational factors for exercising in the SEP, b) the reasons for non-inclusion in SEP exercise and c) attitudes towards SEP exercise.

Kolt et al. (2007) studied 815 elderly participants (51% women, age: 55–93 years) who regularly practiced at least once a week. Subjects evaluated 30 claims from one to three with relation to motives for dealing with PA. The claims were taken from a previously verified questionnaire “*Participation Motivation Questionnaire for Older Adults*” (PMQOA; Kirkby, 1998, 1999, in Kolt et al., 2004). The motivational factors were distributed by importance in six groups: social (24.5% variance explained (VE)), fitness (10.8% variance explained), recognition (7.3% variance explained (VE)), challenge/benefits (5.6% variance explained (VE)), medical (14.1% variance explained (VE)), involvement (3.7% variance explained (VE)). Our study has shown that the main motivational reasons for engaging in exercise in SEP were medical factors (36.0%), challenge/benefits (32.0%), curiosity (24.0%), involvement (20.0%), social (12.0%) and fitness (12.0%). Health factor was the highest rated also by Jiménez-Beatty Navarro et al. (2007).

In comparison with the study of Kolt et al. (2004), the motivational structure of the participants in our study varies considerably. This is undoubtedly due to the fact that we have discussed only with participants who live in a nursing home. They have very different priorities, opportunities and capabilities of other older people living in their own household. For those who live in a nursing home, health is of primary importance. If they would not have health problems and they would not depend on others, they would probably live in their own households. Therefore, they choose exercise mainly because they want to have some benefits from it, especially by improving their own health. It is also understandable that participants in the study by Kolt et al. (2004) mostly chose social factors, fitness and recognition. These people are relatively healthy, and above all, independent and living in their own households. As they do not need to worry too much about their health, they are motivated to be physically active because of many other reasons. Their priority becomes to actively spend their free time, related to socialising with friends, meeting new people, maintaining or improving their skills, physical fitness, health and vitality. They want to be noticed, recognised and important.

Unlike Kolt et al. (2004) and Jiménez-Beatty Navarro et al. (2007) the recognition factor in this study was not observed, showing that participants living in the nursing home do not give much emphasis on physical appearance, popularity and the desire for being noticed and important. Additionally, in this study curiosity was a common factor, most probably due to the fact that the SEP was new to participants and consequently provoked a great interest among them. Usually, in studies about the motivational factors for involving older people in PA, such as the studies of Jiménez-Beatty Navarro et al. (2007) and Kolt et al. (2004), the curiosity factor does not appear, probably because it deals with physical activities that participants already know. Therefore, it would be interesting to examine how much time the influence of curiosity on exercising in the SEP would be present among participants living in nursing homes. It would be appropriate to obtain this information one or more years after starting with exercise in the SEP and determine if curiosity still remains one of the major factor that motivates respondents to exercise in the SEP; probably not.

On the other hand, the main reasons for non-inclusion in exercise in the SEP were health problems and physical/motor difficulties and lack of interest. This could be explained by the specifics of the population of the nursing homes, which is mostly non-autonomous or partly autonomous, with accompanying health problems. This has an important influence on PA and different types of exercise - in our case, SEP exercise involvement. Lack of interest in SEP exercise, however, is probably a direct consequence of a lack of intrinsic motivation. Studies that examine the reasons and motives for inclusion and non-inclusion in PA (Alexandris et al., 2003, Lees et al., 2005, v Jiménez-Beatty Navarro et al., 2007; Cohen-Mansfield et al., 2003; Jiménez-Beatty Navarro et al., 2007; Moschny et al., 2011) usually consider the elderly that are mostly independent and live in their own household, which is quite a different circumstance compared to those living in nursing homes. Nevertheless, these studies, as well as ours, identified that health problems (Cohen-Mansfield et al., 2003; Moschny et al., 2011) and lack of motivation or interest in PA (Alexandris et al., 2003; Lees et al., 2005, v Myiake in Rodgers, 2009; Moschny et al., 2011) are the most important and frequent barriers to involvement in PA among the elderly, including fear of falling (Lees et al., 2005, v Myiake in Rodgers, 2009), lack of company (Moschny et al., 2011), lack of time and fatigue (Cohen-Mansfield et al., 2003). Similarly, for the elderly living in residential care homes, Myiake in Rodgers (2009) have realized that lack of interest and motivation, fear of injury and availability of infrastructure for exercise represent the main barriers to PA, which show that the reasons for non-inclusion in exercise and PA are the same for both groups of the elderly, those living in their own household and in nursing homes.

Based on the high percentage that the curiosity factor scored among all the motives for inclusion in SEP exercise in this study, it should not be ignored that the introduction of novelties actually plays an important role in encouraging the elderly to do exercise. This fact should be considered and implemented by promoters and leaders of exercise and PA in

residential care homes and other organizations, where different types of PAs for the elderly are organized. As proposed by Smith et al. (2012), exercise and PA should be focused on satisfying the health needs of the elderly.

The analysis of the attitudes towards exercising in the SEP in this study showed that out of all the activities available at the Nursing Home, apart from walking, SEP exercise is the activity that the participants choose most often. According to their opinions and responses, the positive effects of SEP exercise are reflected in a much easier performance of everyday tasks, feeling better and being in a better mood, followed by (fewer responses) better balance, less pain, abandonment of walking aids and fewer sleep problems. These facts point out that the introduction of exercise stations of this kind in nursing homes would be more than advisable.

In conclusion, the results of the present study showed that the most common motivational factors for inclusion in SEP exercise for the residents of the Ljubljana Šiška Nursing Home were medical factors, challenge and benefit, and curiosity. The latter is also important because other studies did not point it out and because it suggests how important it is to integrate novelties in residential activities. The most important barriers to SEP exercise were health problems and physical/motor difficulties and lack of interest. An analysis of the attitudes toward SEP exercise showed that, besides walking, SEP exercise is the most popular activity. This data supports the advisability of introducing SEPs in nursing homes. This was further confirmed by the benefits of SEP exercise that were reported by the participants (easier performance of everyday tasks, feeling better and being in a better mood). Based on these results, a relatively small sample of participants and the fact that only one nursing home was included in the study, the authors are aware of the fact that the results cannot be generalized and that it would be advisable to repeat the study on a larger sample and that the study should also include other Homes where similar SEPs are placed. Future studies should also take into consideration other types of exercises or PAs that might be performed by those who do not exercise in the SEP, and which were not taken into consideration in this study.

References

1. American College of Sports Medicine (1998). Exercise and physical activity for older adults. Position Stand. *Medicine & Science in Sports & Exercise*, 30(6), 992–1008.
2. American College of Sports Medicine (2009). Exercise and physical activity for older adults. Position Stand. *Medicine & Science in Sports & Exercise*, 41, 1510–1530.
3. Cohen-Mansfield, J., Marx, M. S., & Guralnik, J. M. (2003). Motivators and barriers to exercise in an older community-dwelling population. *Journal of Aging and Physical Activity*, 11(2), 242–253.
4. Giannakouris, K. (2008). *Population and social conditions: Ageing characterises the demographic perspectives of the European societies*. EUROSTAT: Statistics in Focus, 72/2008. Retrieved January 28, 2011, from http://epp.eurostat.ec.europa.eu/cache/ITY_OFFPUB/KS-SF-08-072/EN/KS-SF-08-072-EN.PDF
5. *Global strategy on diet, physical activity and health. Physical activity and older adults. Recommended levels of physical activity for adults aged 65 and above.* (2012). Geneva: World Health Organization. Retrieved August 11, 2012, from http://www.who.int/dietphysicalactivity/factsheet_olderadults/en/index.html
6. Jiménez-Beatty Navarro, J. E., Graupera Sanz, J. L., del Castillo, J. M., Izquierdo, A. C., & Rodríguez, M. M., (2007). Motivational factors and physician advice for physical activity in older urban adults. *Journal of aging and physical activity*, 15, 241–256.
7. Kolt, G. S., Driver, R. P., & Giles, L. C. (2004). Why older Australians participate in exercise and sport. Human kinetics publishers, inc.: *Journal of aging and physical activity*, 11, 185–198.
8. Moschny, A., Platen, P., Klaaßen-Mielke, R., Trampish, U., & Hinrich, T. (2011). Barriers to physical activity in older adults in Germany: a cross-sectional study. *International Journal of Behavioral Nutrition and Physical Activity*, 2(8), 121.
9. Myiake, M. & Rodgers, E. (2009). Interrelationship of motivation for and perceived constraints to physical activity participation and the well-being of senior center participants. In D. B. Klenosky & C. LeBlanc Fisher (Eds.), *Proceedings of the 2008 Northeastern Recreation Research Symposium* (p. 21–28), Gen. Tech. Rep. NRS-P-42. Newtown Square, PA: U.S. Department of Agriculture, Forest Service, Northern Research Station.
10. Smith, K. L., Carr, K., Wiseman, A., Calhoun, K., McNevin, N. H., & Weir, P. L. (2012). Barriers are not the limiting factor to participation in physical activity in Canadian seniors. *Journal of Aging Research*, doi: 10.1155/2012/890679.
11. Strojnik, V. (2007). *Senior vadbeni park Visport: zbirka vadbenih postaj na prostem namenjena vadbi moči, koordinacije, ravnotežja in gibljivosti – navodila za uporabo [Senior Exercise Park Visport: A collection of outdoor exercise stations designed for improving strength, coordination, balance and flexibility – instructions]*. Tinjan: Visport d.o.o.
12. Strojnik, V. (2010). *Vadba za moč pri starejših ljudeh [Strength training for the elderly]*. Retrieved January 19, 2012, from <http://maximum-portal.com/clanek.php?ContentID=526>
13. Tokarski, W. (2004). Sport of the elderly. *International journal of fundamental and applied kinesiology*, 36(1), 98–103.
14. *World dataBank: World Development Indicators (WDI) & Global Development Finance (GDF)*. (2012). Washington, DC: The World Bank Group. Retrieved June 25, 2012, from <http://databank.worldbank.org/ddp/home.do?Step=2&id=4>

Acknowledgement

Great thanks go to prof. Vojko Strojnik and prof. Rajko Vute for their mentoring and supervision in this research project, to the director and the physiotherapist of the Ljubljana Šiška Nursing Home.

DEPENDANCE OF NEGATIVE EXPRESSIONS OF BASKETBALL PLAYERS' BEHAVIOUR ON THE FREQUENCY OF REFEREES

Petr Hrusa

Department of Leisure and Tourism, Faculty of Informatics and Management, University of Hradec Kralove, Czech Republic

Abstract

In 2005 the number of referees in the top Czech basketball league games was changed from two to three. The aim of the study was to show that the change has led to decreasing negative expressions of players' behaviour on the court. The problem was solved by an empirical, descriptive and causal research with quantitative (χ^2 , $p < 0.05$) and qualitative analysis. Observation of DVD-recorded games ($n = 60$) was employed for data collection, with focus on two indicators – negative reactions and aggressive behaviour. In comparison of the games officiated by 2 referees and by 3 referees, the higher frequency of referees was reflected in lower frequency of negative expressions of player's behaviour. The results suggest dependence of negative expressions of players' behaviour on the frequency of referees in game.

Key words: basketball game; FIBA; negative reactions; aggressive behaviour

Introduction

In the Czech Mattoni National Basketball Men League (CMNBL), which is the top Czech basketball league, the number of referees in the game was changed, preceding the season 2005 – 2006. The Czech Basketball Federation (CBF) increased the number of referees on the court from two to three. This measure followed the proposal of the International Basketball Federation (FIBA). Hence the change was not initiated by the fact that two referees would not have been able to follow the game sufficiently, as suggested by Seidl (2005). The study deals with the problem, how the change of frequency of referees reflected in negative reactions and aggressive behaviour of the players during games. Rainey (1994) divides offensive behaviour in sport into minor offenses (e.g. pushing, catching, spitting) and major offenses (e.g. striking, choking, throwing objects at the referee – primarily the ball) and suggests that violence can sometimes be tolerated in different sports.

Sport is "emotiogenic"; it is the source of emotions, as suggested by Slepíčka et al. (2009). The emotions are triggered from the outside (Atkinson et al., 2003). It is important to observe and evaluate both verbal and nonverbal negative emotional expressions (Paulík, 2006). Position of a basketball referee is difficult and demanding in terms of prompt and correct deciding. However, in some cases the referee's decision may be perceived as incorrect and such situation can elicit negative behaviour of the players (Weinberg and Gould, 1995). The players often believe their emotional behaviour can be justified in such situations. Relation of players and referees has always been complicated and has always been perceived as a source of continual conflict. These conflicts arise as a result of a cognitive development of players (Rainey et al., 1992), and are probably unavoidable.

Based on the literature review, there was not much research evidence concerning negative behaviour and its relation to the frequency of referees, when the project was designed. The main focus in this study was on the selected aspects referring to the change of the number of referees in game. Two consecutive seasons (2004 - 2005 and 2005 – 2006) were evaluated, preceding and following the change, with regard to officiating and negative behaviour of players after a referee's foul call.

Methods

The aim of the study was to evaluate the negative expressions of players' behaviour as a consequence of different levels of objectivity of game officiating based on the frequency of referees. Negative reactions and aggressive behaviour were followed. It was assumed that the frequency of referees in a basketball game will be reflected in the frequency of negative expressions of players' behaviour. The main focus was on two indicators – negative reactions and aggressive behaviour during matches. In the first hypothesis (H1) a higher frequency of negative reactions of the players was assumed in games officiated by two referees, compared to three referees. In the second hypothesis (H2) a higher frequency of aggressive behaviour of the players was assumed in games officiated by two referees, compared to three referees. The problem was solved by an empirical, descriptive and causal research with quantitative (χ^2 , $p < 0.05$) and qualitative data analysis. To verify the hypotheses, two selected indicators were followed with regard to the dependent variable: and aggressive behaviour. The frequency of negative reactions of basketball players ($\sum \text{NRp}$) comprised total frequency of verbal and non-

verbal negative expressions of players in games towards the referees after a personal foul having been called or not (rude communication with the referee, tossing the ball down to the ground, throwing one's arms). The frequency of aggressive behaviour of basketball players (Σ ARP) comprised total frequency of aggressive behaviour of players in games towards the referees or the opponents (hitting by hand, kicking, spitting at the opponent, deliberate throwing of the ball into the referee, thrust into the referee or the opponent).

The main method for data collection was observation of DVD-recorded basketball games ($n = 60$) with focus on the selected indicators. Method of questioning, a technique of questionnaire was employed as a control technique to verify the collected data. The substantive difference that can affect course of the game, concerning both negative reactions and aggressive behaviour of the players, with regard to the frequency of referees in game, was determined according to expert opinions ($n = 26$). The data collection and processing was carried out repeatedly in a pilot study, to verify the methods, and in the main research, according to the hypotheses and based on the given constructs and variables and their indicators.

Participants

The basic sample for the research consisted of all the referees and all the games of the teams in the top basketball league in the Czech Republic - Czech Mattoni National Basketball Men League (CMBML) – in the two consecutive seasons of 2004 – 2005 and 2005 – 2006. The research comprised 26 referees and 60 games of CMBML.

Analysis

Data were processed and analysed by quantitative and qualitative analysis. The significance of difference was calculated on the level of significance $p < 0.05$. In qualitative analysis the results were evaluated according to the criteria referring to substantive differences that can affect course of the game in both indicators, based on a consensus of expert opinions of all the league basketball referees ($n = 26$). The criterion of substantive difference was set by a percentage (20% for negative reactions; 10% for aggressive behaviour) of minimal difference between the average value in the games officiated by two referees and games officiated by three referees.

Results

Evaluation of the data provided following results: descriptive statistics and the results of statistical and qualitative analysis of the variables and its indicators (negative reactions and aggressive behaviour). The descriptive statistics are showed in the table overview (see tables 1 and 2) of all the observed games ($n = 60$). The results are compared between the games officiated by two referees and the games officiated by three referees, in the seasons 2004 – 2005 and 2005 – 2006). Both table 1 and table 2 comprises values for 30 games of CMNBL.

Table 1: Descriptive statistics for the games officiated by two referees in the season 2004 – 2005.

2 referees	Frequency	Average	Median	Min.	Max.	Stand. Dev.	Quartile
Negative reactions	213	7,1	7	5	10	1,56	2
Aggressive behaviour	15	0,5	0	0	2	0,63	1

Table 2: Descriptive statistics for the games officiated by three referees in the season 2005 – 2006.

3 referees	Frequency	Average	Median	Min.	Max.	Stand. Dev.	Quartile
Negative reactions	137	4,57	5	3	7	0,97	1
Aggressive behaviour	9	0,3	0	0	2	0,53	1

In the research hypothesis it was assumed that the frequency of referees in a basketball game will be reflected in the frequency of negative expressions of players' behaviour. The significance of the difference was calculated in statistical analysis (χ^2 , $p < 0.05$) and qualitative analysis. One hypothesis (H1) was verified by the indicator of negative reactions (H1) and the other hypothesis (H2) focused on aggressive behaviour.

The results concerning negative reactions indicated significant difference between the games officiated by 2 referees and between the games officiated by 3 referees, based on both statistical and qualitative analysis (see table 3). The significance of difference was calculated on the level of significance of $p < 0.05$. Concerning qualitative analysis, a higher real value of the percentage difference was shown and the criterion according to the expert opinions ($> 20\%$) was exceeded - the difference of 76 cases of negative reactions of the players was regarded as substantive and therefore can affect the game.

The results concerning aggressive behaviour did not indicate a statistically significant difference ($p < 0.05$) between the games officiated by 2 referees and between the games officiated by 3 referees (see table 4). However, this result can be affected by a low frequency of the observed features. Concerning qualitative analysis, a higher real value of the percentage difference was shown and the criterion according to the expert opinions ($> 10\%$) was exceeded - the difference of 6 cases of aggressive behaviour of the players was regarded as substantive and therefore can affect course of the game.

With regard to confirmation of the partial hypotheses, based on the set conditions of verification, the overall results suggest that the frequency of negative expressions of players' behaviour depends on the frequency of referees in the basketball game; and that the higher frequency of referees is reflected in lower frequency of negative expressions of players' behaviour.

Table 3: Statistical and qualitative analysis of the difference in frequency of negative reactions of the players

	$\Sigma_{2/3}$	χ^2	H_0/H_A	Qualitative criterion	Real value of difference	Substantive significance of difference
Negative reactions	213/137	3,43	H_A	$> 20\%$	-35,70%	YES

Table 4: Statistical and qualitative analysis of the difference in frequency of aggressive behaviour of the players

	$\Sigma_{2/3}$	χ^2	H_0/H_A	Qualitative criterion	Real value of difference	Substantive significance of difference
Aggressive behaviour	15/9	0,09	H_0	$> 10\%$	-40%	YES

Discussion

The results provide base for discussion concerning efficiency of the change in the number of referees in basketball game proposed by FIBA, in the Czech top men league, before the season 2005 – 2006. The research constructs and variables focused on negative expressions of players' behaviour. The frequency of negative reactions of players dropped on average by 2,53 for a game, which is a decrease of 35.7%. According to a general opinion this may be due to the fact that the referees make fewer mistakes and thus the players have fewer reasons for negative emotions. It was also observed, that in the games officiated by three referees some players were not sure to whom of the referees they should turn their attention to, and therefore seemed confused. As the author suggested above, the relation of a referee and a player can induce a lot of emotions, in compliance with the findings that sport is "emotiogenic" (Slepička et al., 2009).

The frequency of aggressive behaviour dropped on average by 0.2 for a game, which is a decrease of 40%. Based on the expert opinions, the difference in aggressive behavior of basketball players can be considered substantive. Concerning aggression, Rainey and Duggan (1998) found out in their study at American referees that every referee ($n = 98$) has been assaulted during the game or straight after the game at least once in their career. Weinberg and Gould (1995) discussed that the referee has a less important role, the game being meant in the first place for players, coaches and fans. However, the findings of this study points to the fact that referee is an important person. Also Glegg and Thompson (1993) rank the referee to be the third important aspect of the game, after players and coaches.

Conclusions

The aim of the study was to evaluate the negative expressions of players' behaviour as a consequence of different levels of objectivity of game officiating based on the frequency of referees. The research hypothesis was verified by means of the selected indicators - negative reactions and aggressive behaviour of the players in basketball game. The results suggest dependence of negative expressions of players' behaviour on the frequency of referees in game. In comparison of the games officiated by 2 referees and by 3 referees, the higher frequency of referees was reflected in lower frequency of negative expressions of player's behaviour. In practice the findings may support the change of the number of referees in basketball game to be reasonable and well-founded. However, the subject should be a course to a further study.

References

1. Glegg, A., Thompson, F. *Modern Sport Officiating: A practical Guide*. Dubuque: Brown&Benchmark, 1993.
2. Paulík, K. *Psychologie sportu*. Ostrava: Ostravská univerzita, 2006. ISBN 80-7368-259-1.
3. Rainey, D. Assaults on Umpires: A Statewide Survey. *Journal of Sport Behaviour*, 1994; 17(1): 144-155.

4. Rainey, D., Santili, N. R., Fallon, K. Development of Athletes' Conceptions of Sport Officials' Authority. *Journal of Sport and Exercise Psychology*, 1992; 14: 392–404.
5. Rainey, W., Duggan, P. Assaults on Basketball Referees: A Statewide Survey. *Journal of Sport Behaviour*, 1998; 21(1): 113-119.
6. Atkinson, R. L. et al. *Psychologie*. Praha: Portál, 2003. ISBN 80-7178-640-3.
7. Seidl, J. *Basketbal zavedl tři rozhodčí* [online]. c2005, last revision 08. 12. 2005 [cit. 2007-11-05]. Retrieved from www: <http://basket.idnes.cz/basketbal-zavedl-tri-rozhodci-dkz-/nbl.asp?c=A051207_172652_nbl_rav>.
8. Slepíčka, P. et al. *Psychologie sportu*. Praha: Karolinum, 2009. ISBN 978-80-246-1602-5.
9. Weinberg, R. S., Gould, D. Foundations of Sport and Exercise Psychology. *Journal of Sport Behaviour*, 1995; 21(1): 113-120.

SPECIFIC ASPECTS OF FOOTBALL GOALKEEPERS MENTAL POTENTIAL IN RELATION TO OTHER PLAYERS IN THE TEAM

Živko Kalentić, Snežana Vujanović, Nenad Sudarov, B. Strajnić, Branko Đukić and Nebojša Vujkov

Provincial Institute of sport and sport medicine, Novi Sad, Serbia

Abstract

Numerous studies exist which are dealing with the differences between football players in various interest fields depending on their position in the team, but very few of those which concerning the capabilities and potentials of performance conscious mental activities such as perception, memory, thinking and so on. Cognitive is often equated with mental and intelligent. Chronometry in psychology presents study of psychic phenomena characteristic presentation approach, which is based on the assumption that on the time of some phenomena lasts we can fathom the complexity of its structure, and decipher dynamic of mechanism functioning through which they are realized (Drenovac, 2009).

The research aim is to identify differences between displaying mental potentials of football goalkeepers and other players in the team.

The sample consisted of 32 football players, of which there were 16 players and 16 goalkeepers aged from 16 to 18 years, from territory of autonomous region of Vojvodina, were tested using CRD battery of tests (test 4-33 measuring simple psychomotor reaction speed), in diagnostics cabinet of Provincial Institute of Sports and Sports Medicine in Novi Sad. Variables for mental potential estimation were used in this Work: shortest time solving test (TMIN), total mistakes number (UP), total lost time/ballast (UB) and start dissociation (DI).

Results of multivariate analysis of variance (MANOVA) showed lack of statistically significant differences in simple psychomotor reaction speed between goalkeepers and other players in the team ($p = .20$). Univariate analysis of variance (ANOVA) showed that the differences were on the verge of statistical significance between the players and a goalkeepers in a test 4-33 that measures the speed of simple psychomotor reaction, presented through variable (UP)-the total number of errors. Statistically significant differences in test 4-11 presented through variable (UPM) $p = .03$ and (DIUBM) $p = .00$. Results of discriminative analysis showed statistically significant differences in test 4-11, that measures movement coordination test between goalkeepers and other players in the team ($p = .01$).

Key words: *Mental potential, football players, goalkeepers*

Introduction

Football experts need to note how behavior of goalkeepers is different from other players, and they have different capabilities and resources to perform conscious mental activities such as perception, memory, thinking and so on. A number of authors have investigated the differences in anthropometric measures and motor skills manifestation between players and goalkeepers (Radosav, 1990, Smajic, 2005, Verdenik, 1981, Savelsberg, 2001), but very few that are related to the cognitive abilities of these athletes (Radulovic, 2011, Williams, 2000, Falk, 2004), while the differences between the cognitive abilities between players and goalkeepers in football almost not even investigated.

Cognitive is often equated with mental and intelligent, while chronometry in psychology represents approach to the study of psychic phenomena characteristic presentation, which assumes that on the basis of time that event happens, can enter the bottom of the complexity of its structure and decipher the dynamic of functioning of the mechanism by which they are achieved. It is undeniable that the brain (CNS) is a place to consolidate and control the work of all organs in the body, and this specificity determinates the general characteristics and the effectiveness of individual behavior. Because of this level of efficiency and dynamic characteristics of functioning are the elements on which are based the description and sizing of some performances of individual identity. Method by which a CRD battery of tests is designed is based on the position that the mental processes are treated from the standpoint of information processing. Mental potential and functional characteristics of performing mental activities are defined by performance indicators and performance characteristics of different form and mechanisms of processing and storage (Vujanovic 2011). Sport efficiency in the processing of stimulus content was determined by relation to such a content and situational characteristics of the excitatory situation. Neurophysiological studies suggest that with cognitive the emotional processing component of current content is present. While the cognitive processes are manifested quickly, emotional reactions occur with a greater latent period, much later (Behterjeva, 1971, Drenovac, 1994).

For the purpose of this paper is to take into account the following potential indicator of mental capacity:

Perception, signal detection, because the perception of the initial phase of each receptive process in which meaning is not found, but only registered signal phenomena. Unlike the orientation reflex, unintended reactions due to the presence of a strong stimulus, perception is a component of the conscious signals registration in simple psychomotor reaction cycle. The simplest form of mental activity of perception of the expected signal Doners appointed as A reaction, and Wundt called it simple reaction (Drenovac, 1994).

Operating thinking is a complex mental activity of managing the coordinated action of the arms and legs to the patterns of light stimuli (Drenovac, 1994).

The aim of the study was to determine whether there were differences in the manifestation of mental potential of goalkeepers in relation to the other players in the team.

Method

The sample consisted of 32 football players, of which there were 16 players and 16 goalkeepers aged from 16 to 18 years, from territory of autonomous region of Vojvodina, were tested using CRD battery of tests (test 4-33 measuring simple psychomotor reaction speed), in diagnostics cabinet of Provincial Institute of Sports and Sports Medicine in Novi Sad.

CRD series of psychodiagnostical tests contains 38 standardized tests intended to determine (diagnosis and follow-up): perceptual abilities, thinking, memory, and various forms of psychomotor reactions. (Drenovac, 1994).

For the Research needs we used test CRD 4-33, which contains the signal circuit of 1 lamp and 1 button for the application response. The task is that on the appearance of the light signal press the button to answer as quickly as possible, while pressing the button before the appearance of the signal is registered as an error. The test contains 35 tasks and measures the speed of simple psychomotor reactions.

Test CRD 4-11 comprises a set of four lights that outline the corners of the trapezoid. In lower corner there are lights that are signals to reply by feet. The tasks are switched from one to three lights to be answered by pressing to answer by one or a combination of synchronized limbs.

As variables to assess the mental potential and athletes efficiency in this work are:

Time: the fastest time of the test solution (TMIN), which represents a potential mental speed, which is the closest to “natural border” facilities functioning mechanism by which mental function is achieved.

Accuracy: Total number of errors (UP), which is an indicator of reliability of neuropsychological functions and operating performance of mental activity, as an indicator of dissociation and concentration.

Ballast as follows: total waste of time, ie. Ballast (UB), which is an indicator of stability course of mental functions, ie. indicator of inefficient time spent in solving the test: starting dissociation (D1), which is an indication of lost time in the first five tasks in the test, which according to many factor analyzes emotionally causing disturbances, anxiety of participants on the first meeting with the new content.

First of all are calculated central and dispersion parameters of the whole observed sample. Then we started calculating the differences on the level of whole system observed variables by multivariate analysis of variance (MANOVA), while the differences between the groups were calculated by univariate analysis of variance (ANOVA).

Results and discussion

Table 1: Descriptive analysis of results of reaction speed variable (Test 4/33) and coordination (Test 4/11)

VARIABLE	N	MIN	MAX	AS	SD
REACTION 4-33	16	6.83	12.54	9.30	.39
	16	6.97	11.85	8.51	.43
TMIN	16	.16	1.53	.46	.03
	16	.15	1.95	.40	.02
UP	16	.00	2.00	.69	.70
	16	.00	3.00	.19	.75
UB	16	1.16	5.55	2.92	1.45
	16	1.22	6.95	2.23	1.37
D1/UB	16	.14	.24	.18	1.74
	16	.14	.23	.18	1.37

COORDINATION 4-11	16	.51	1.71	.36	1.07
	16	.69	4.88	.44	.46
TMIN	16	.32	.56	9.81	5.69
	16	.36	.66	16.13	16.83
UP	16	3.00	27.00	1.18	2.12
	16	2.00	14.00	6.42	7.92
UB	16	10.31	32.74	.076	.07
	16	8.84	32.80	6.72	2.91
D1/UB	16	22.88	47.28	5.49	6.08
	16	21.52	51.50	32.11	33.42

In Table 1 are calculated central and dispersion parameters of the entire sample, it was shown that the results are normally distributed and that further analysis of the same possible.

Table 2: Test results differences analysis of goalkeepers in relation to the other players in the team (MANOVA and ANOVA)

VARIABLE		N	AS	F	p
REACTION 4-33	Goalkeepers	16	9.30	2.05	.16
	players	16	8.51		
TMIN	Goalkeepers	16	.46	.01	.94
	Players	16	.40		
UP	Goalkeepers	16	.69	3.78	.06
	Players	16	.19		
UB	Goalkeepers	16	2.92	1.92	.18
	Players	16	2.23		
D1/UB	Goalkeepers	16	.18	.20	.66
	Players	16	.18		
COORDINATION 4-11	Goalkeepers	16	.36	.27	.61
	Players	16	.44		
TMINM	Goalkeepers	16	9.81	.56	.46
	Players	16	16.13		
UPM	Goalkeepers	16	1.18	5.08	.03
	Players	16	6.42		
UBM	Goalkeepers	16	.076	.12	.73
	Players	16	6.72		
D1/UBM	Goalkeepers	16	5.49	11.08	.00
	Players	16	32.11		

Multivariate analysis of variance (MANOVA) showed that there are differences of simple psychomotor reaction between players and goalkeepers in the whole system of observed variables $p = .20$. Individually speaking, universal analysis of variance (ANOVA) showed that the differences were on the verge of statistical significance between the players and goalkeepers on a test 4/33 that measures the speed of simple psychomotor reaction, shown through variable (UP) as total number of errors.

Univariate analysis of variance (ANOVA) showed that differences in Test 4-11 are existing in variable (UPM) $p = .03$ total number of errors which indicates the reliability of neuropsychological functions and operational performance of mental activities, it is also an indicator of the concentration and dissociation constant and (D1/UBM) $p = .00$ which provides information on lost time at the beginning of the test, which is an indicator of emotional disturbance of patient in touch with the new situation.

Table 3: Discriminant analysis of test results of goalkeepers in relation to the other players in the team

	Wilks' Lambda	Chi-square	p
DISCRIMINANT	.615	14.090	.01

Discriminant analysis of test results of goalkeepers in relation to other players in the team has shown that there is a significant difference and clearly defined limit on the expression of the tested characteristics of the studied groups of patients.

Table 4: Shows that the biggest discriminative difference between groups exists in variables DUBM and UPM

VARIABLE	λ	F	p
DUBM	.730	11.076	.02
UPM	.615	9.071	.01

Table 5: Structure coefficient of discrimination of test results of goalkeepers in relation to other players in the team

VARIABLE	Coefficient of discrimination
DUBM	.768
UPM	-.520
TMINM ^a	.370
TEST 4-33 ^a	.205
TEST 4-11 ^a	.144
UPR ^a	-.139
TMINR ^a	.114
UBM ^a	.086
DUBR ^a	.071
UBR ^a	.021
DUBM	.768

The coefficient of discrimination shows that the largest discriminant function between players and goalkeepers is in manifestation of mental resources in the variables (UPM) $p=.01$ total number of errors that shows reliability of neuropsychological functions and operational performance of mental activities, it is also indicator of the concentration and the dissociation constant and (DI/UBM) $p=.02$ which provides information on lost time at the beginning of the test, that indicates emotional disturbance of the patient in touch with the new situation.

A review of studies of perceptual skills of football players, Williams (2000), concluded that successful players are significantly different from less successful in their abilities. They more successful recall and recognize patterns of the game and their ability to decipher, extract and recognize the sport-specific information and based on early signals successfully anticipate the further course of events on the field.

Research by Reilli and associates (2000) in a multidisciplinary approach to talent identification in football found that ego orientation and the orientation on the task, as well as the ability to anticipate in situations 1 on 1, best represent the characteristics of the players. Everything mentioned so far tells us an important fact, which is that all the researchers analyzed the players as all equal and no one has paid special attention to separate the players from the goalkeepers, which confirms the findings from the introduction that the differences between the cognitive abilities between players and goalkeepers in football are almost never investigated.

Based on the literature review and the results obtained, the differences that were on the verge of statistical significance between the players and goalkeepers in football on a test 4/33 that measures the speed of simple psychomotor reaction, shown as a variable (UP)-total number of errors, which is an indicator of reliability of neuropsychological functions and operational performance of mental activity, indicating that the goalkeepers in relation to other players, make significantly more errors. Because of the specific positions they occupy in the team during the match results can be explained by the influence of emotional dissociation as a manifestation of emotional excitement. Emotional dissociation is indicated by different types of transient faults in the reaction performance or response to stimuli content. Resulting with a prolonged reaction time, followed by uncontrolled reactions and bigger number of errors.

Statistically significant differences obtained in the test 4-11, shown in variable (UPM) total number of errors, which is an indicator of reliability of neuropsychological functions and operational performance of mental activities, indicates that the goalkeepers in relation to other players are making a statistically smaller number of errors. Due to a specific position in the team during the match, obtained results can be explained by the fact that the goalkeepers have a different training process from other players in the team, during which the emphasis is on the synchronized operation of the upper and lower extremities.

Existence of significant difference in variable (D1/UBM), in favor of the goalkeepers, can be explained with fact that goalkeepers are taught during a long training process to overcome the dissociation starting at the beginning of the match. As a support to this observation is the fact that the warm-up process of the goalkeeper before the match is longer and different than the rest of the team, as the position is very responsible, so, in order to minimize the probability of error, it is necessary for them to be mentally well prepared and that the level of activation is optimal.

The results show that the problem defining the structure elements and functioning mechanisms of mental processing in the range of complexity of mental activity, including the need to define the function and structure of human functioning and efficiency indicators of psychological components in different segments of cognitive abilities. These are the elements that should be addressed to future researches, what CRD battery of psychological tests provides us.

Conclusion

Presented research could draw the attention of football specialists that there is a correlation between the functioning mechanisms of mental processing and efficiency on the field. The results show that the goalkeepers are subjected to constant emotional excitement, which resulted in prolonged reaction time followed by less controlled reactions and longer number of errors. For this reason, the practice for goalkeepers to be more mentally and physically prepared for the game proved to be a good precondition for the level of activation of which the game starts to be optimal, and thus lower dissociation at start.

On the other hand, it has been shown that the players have higher start-up dissociation, but the total number of errors is less than goalkeepers, which indicates that better mental preparation of players would affect their efficiency at the start and during the whole match.

References

1. Drenovac, M. (2009). "Kronometrija dinamike mentalnog procesiranja". Osijek: Sveučilište Josipa Jurija Strossmayera, Filozofski fakultet.
2. Drenovac, M. (1994). "CRD serije psihodijagnostičkih testova". Zagreb: AKD.
3. Malacko, J., Doder, D. i Vujanović, S. (2010). "The differences in the movement structures of Kata, fights and mental potentials between boys and girls who train karate" Acta Kinesiológica, International Scientific Journal of Kinesiology, Vol. 4, Issue 2, str. 28-32.
4. Radosav, R. (1990). "Odabiranje dečaka za fudbal na osnovu longitudinalnog praćenja i usmeravanja razvoja bazičnih i specifičnih karakteristika i sposobnosti" (doktorska disertacija). Novi Sad: Fakultet fizičke kulture.
5. Radulović, I. (2011). Identifikacija talenata u fudbalu - predlog baterije motoričkih psiholoških testova. Sport - nauka i praksa. Bol.2, No3, str. 35-53.
6. Reilly, T., Bangsbo, J., Franks, A. (2000). Anthropometric and physiological predispositions for elite soccer. *Journal of Sports Sciences*, 18, 669-683. <http://www.acesmylibrary.com>
7. Reilly, T., Williams, A. M., Newill, A., Franks, A. (2000): A multidisciplinary approach to talent identification in soccer. *Journal of Sports Sciences*, 18, 695-702.
8. Savelsberg, J. P., Williams, A. M., Van der Kamp, J., and Ward, P. (2001). "Visual search, anticipation and expertise in soccer goalkeepers". *Journal of Sports Sciences*, 20(3), 279-287.
9. Smajić, M. (2005). "Relacije morfoloških karakteristika i bazičnih motoričkih sposobnosti sa specifičnom preciznošću fudbalera uzrasta 10 – 12 godina" (doktorska disertacija). Novi Sad: Fakultet fizičke kulture.
10. Verdenik, Z. (1981). "Povezanost nekaterih manifestnih in latentnih psihomotornih spremeljivk z uspehom v nogometni igri (nogometni igrači, starost od 9-11 let)" (magistrska naloga). Zagreb: Kineziološki fakultet.
11. Vujanović, S. i Tišma M. (2011). Povezanost kompetitivne anksioznosti i efikasnosti sportista. *Aktuelno u praksi*, Vol. 23 (10), str 31-39.
12. Vujanović, S., Kalentić, Ž., Jovančević, V., Sudarov, N., Strajnić, B., Golik-Perić, D. i Đukić, B. (2012). Cognitive skills specificities of football goalkeepers in comparison to other players in the team. Belgrade: *International scientific conference effects of physical activity application to anthropological status with children, youth and adults*, 146-147.
13. Williams, A. M. (2000): Perceptual skill in soccer: Implications for talent identification and development. *Journal of Sports Sciences*, 737-750. <http://www.acesmylibrary.com>.

ANALYSIS OF THE DYNAMICS OF SUBJECTIVE MENTAL STATES DURING COMPETITIVE ACTIVITY OF CZECH ELITE TRACK CYCLISTS

Jan Mach, Viktor Pacholík, Sylva Hřebíčková and Damjan Siriški

Faculty of Sport Science, Masaryk University Brno, Czech Republic

Abstract

Purpose: Influence of psychological load connected with competition on mental state of track cycling athletes was assessed. The purpose of this study was to evaluate changes of subjective psychological experiences and states of track cycling athletes during competition and to find out about any regularity of these changes.

Methods: Two standardized questionnaires were used: SUPSO and Belov temperament test. Results It has been proved that psychological state of track cycling athletes before the competition has statistically significant impact on their psychological state evaluated immediately after the competition.

Conclusions: Pre-competition mental states of track cycling athletes are very stressful for their personalities. Psychological preparation of track cycling athletes therefore contributes to improving their performance.

Key words: track cycling, psychological experiences, psychological states, temperament, SUPSO

Introduction

Mental state can be understood as a dynamic quantity characterized by the variability of activation of mentality and mental experience (changes in basal qualities of emotional setting) reflected in the dynamics of the inner (mental) and outer (physical) activity of an individual.

The dynamic change of mental state in the area of activation of mentality and mental experience is a typical sign of every situational change. The set of non-specific mental changes, i.e. the actualization of a certain psychic state is caused by every change of a higher significance to the inner and outer environment. Such dynamics can be observed in both positive and negative changes for the individual, but it is still vital to take into account the dialectics between the two basic parts of mental state – mental activation and mental experience.

Track cycling demands great physical and mental endurance of the sportsman, especially in the sprint disciplines where more than one round can take place during the competition (e.g. the qualifying race followed by several final or repechage races). As there are more races in one day, there is a great pressure on the athlete's psychics and performance concentration. A possible failure brings other negative experience which negatively influences the cyclists's performance in next rounds where the best results need to be achieved. (Blahutková, Pacholík, 2008).

Methods

This research was financed within the specific research project called „*Koncentrace pozornosti jako jeden z předpokladů úspěšnosti výkonu v cyklistice*“ (*Attention concentration as one of the success predispositions in cycling*), programme „c. MUNIA/A/0829/2012 ID 23564“.

The research sample consisted of 9 track cyclists (extensive Czech national team - TO1 – TO9), specialized in sprint disciplines.

1) Temperament test

Belov's temperament test (in Blahutková, 1999) distinguishes four basic temperament types: choleric, sanguine, phlegmatic and melancholic type. It also works with combinations of these basic types, e.g. sanguine-choleric type. In case of these combinations the first is always the dominant temperament type (i.e. the type which was more often represented in the results).

$$Vt = \frac{Cha \cdot 100}{a} + \frac{Sa \cdot 100}{a} + \frac{Fa \cdot 100}{a} + \frac{Ma \cdot 100}{a}$$

where:

- Ch = number of positive responses in column A
- Sa = number of positive responses in column B
- Fa = number of positive responses in column C
- Ma = number of positive responses in column D
- a = number of positive responses in the whole test

Generally, the item exceeding 30% is considered dominant. In case of two items exceeding 30%, it is the combination of two temperament types.

2) SUPSO questionnaire

The standardised questionnaire SUPSO made by prof. Oldřich Mikšík was used to describe the dynamics of subjective experience and personality states (Mikšík, 2004). It is the result of the factor and multivariation analysis of operationally defined and internally pragmatically devised scales including 28 adjectives that characterize concrete symptoms of feelings, mental experience and personality states.

The measured components of mental state are:

P = psychological well-being (feeling of satisfaction, a pleasant mood and pleasant mental warm-up, which is often accompanied by feelings of euphoria and confidence). This component shows a degree of freshness, satisfaction, peace and mental balance, optimism and good mood.

A = activity, vigorousness (feelings of power and energy which are associated with a hankering after the action). It is a readiness for active interaction among various situational variables. It can be described with the qualities of psychological phenomena, such as vigorousness and assertiveness.

O = impulsiveness, letting off steam (uncontrolled, spontaneous release of energy stress and mental tension). Described by feelings like moodiness, difficulty in self-control, explosiveness, irritability and uncorrected aggressiveness.

N = mental restlessness, discomfort (experiencing psychological stress, when it is not possible to find ways to release it). Characteristic symptoms are mental and motoric restlessness, annoyance, discontent, impatience and restlessness.

D = mental depression, tiredness (complex of feelings and states, of which the main characteristics represent a tendency towards passivity and apathy).

U = anxious expectations and fears (complex of feelings of insecurity, experience of psychological, tension, feelings of anxiety, fear of the possible future consequences, etc.). Experiencing possible future development is being updated within inner experiences, but there is lack of readiness to deal with situational components.

S = sadness (these experiences can be expressed by adjectives sad, lonely, hypersensitive, unhappy). It can be defined as a passive experiencing of situational variables. Experiences are not turned out to interact with the outer environment, but "inside".

SOFTWARE DIAROSWIN VERSION 1.1

The computer software DiarosWin version 1.1 was used for recording results of personality tests and their case and statistical interpretation. The software operates in 32bit Microsoft Windows operational systems. The processing of results takes place in the Case Interpretation model and it is possible to display the results in tables or graphically as a target diagram. The standard edition includes the Z-scores interpretation, i.e. the comparison of proband with a defined group from the database. The selection of groups is possible by individual choice, filtering or by both of these options.

Results

According to literature, the choleric type should be prevalent in the sprint disciplines. Our research revealed that the majority of tested individuals were sanguine-choleric types (picture 1). The highest number of these temperament types corresponds to the preference of short and intensive physical activity such as sprint performances.

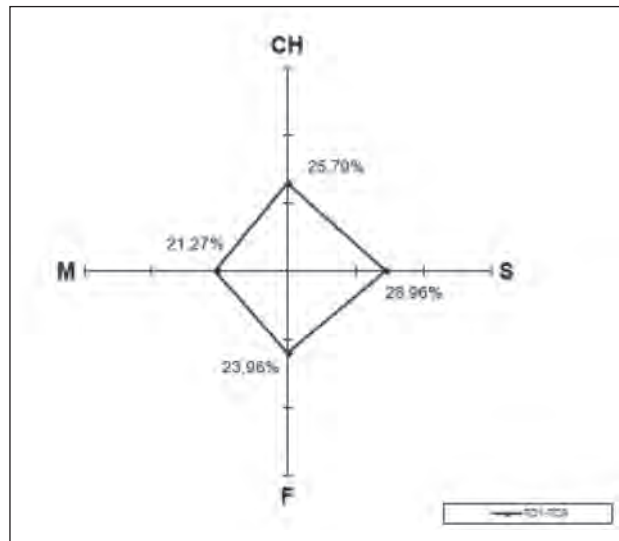

Picture 1: Temperament types diagram of selected track cyclists

Table 1 illustrates the statistically significant dependence of pre-start state on a common mental state in top-level athletes. The T-test results reveal statistically significant differences in „A“, „O“, „N“ and „U“ components. Table 2 shows statistically significant differences in the dynamics of mental states and experience during the competition, which are based on the results of the T-test. The statistically significant components are „D“ and „U“.

Table 1: Mental state before competition

Scale	M	SD	t(spc)
P	21,28	7,56	-4,65**
A	21,68	5,66	-1,18
O	14,26	5,51	<u>3,64**</u>
N	13,79	5,37	<u>2,23*</u>
D	8,14	6,79	-1,26
U	15,6	4,52	<u>6,42**</u>
S	5,26	6,03	-1,76

Table 2: Mental state after competition

Scale	M	SD	t(spc)
P	16,8	9,8	-2,0
A	19,8	6,5	-1,2
O	15,3	6,9	0,6
N	16	5,3	1,5
D	12,6	5,3	<u>2,8*</u>
U	11,1	5,2	<u>-3,5**</u>
S	8,6	6,2	2

The target diagram in Picture 2 graphically illustrates the situation. This target diagram is a sample of our research and represents one of the probands.

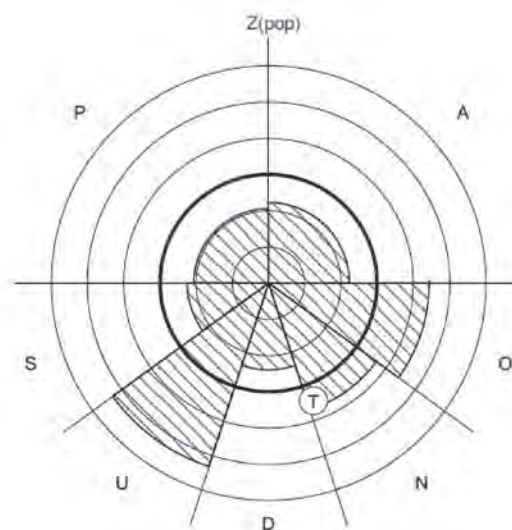

Picture 2: The target diagram of partial mental state components revealed by the standardized SUPSO questionnaire before competition versus top-level athletes

Discussion

Table 2 shows the actual mental state before the competition (pre-start state) in comparison to a common mental state of top-level athletes. Firstly, the statistically significant differences are in the component „P“, when the probands are in negative numbers which signifies mental disturbance (the feeling of dissatisfaction, lessened self-esteem, and also often mental disbalance). Secondly, the statistically significant component is „O“, when the proband has difficulty with outer influences, proband is moody, struggles with self-regulation, irritativeness and often unregulated aggressivity. Thirdly, the component „N“ is also statistically significant. The proband is experiencing restlessness, discomfort and psychological stress, when it is not possible to find ways to release it. The characteristic symptom is the motoric restlessness which makes him unable to concentrate on the race. Lastly, the statistically significant component is „U“, characterized by uncertainty, anxiety and mental tension. The target diagram in Picture 2 graphically illustrates the situation. This target diagram is a sample of our research and represents one of the probands. Furthermore, table 2 shows the change of mental state and experience after the competition. The table reveals the two statistically significant differences in the components „D“ and „U“. The component „D“ concerns mainly the feeling of exhaustion which is understandable after the maximum level performance. Another marked change of mental state is the shift of the component „U“ towards the center, which results in the loss of doubts, anxiety and balancing the moodiness. These changes in these components are a common phenomenon in the dynamics of subjective experience and mental state. They are average and such changes in probands were expected. It confirms our hypothesis that the probands will display a greater level of physical exhaustion but a lower level of stress after the competition.

Conclusions

The research confirmed our hypothesis that the pre-start state is stressful for the proband. The results of the research are illustrated in Picture 2 or Table 1, where the probands reveal a significant discomfort evident from the subjective states and experience before the race. In particular, it is mainly the shift of mental states to negative numbers like anxious expectations, deepening of stressful states and greater restlessness. In overall, the athletes are strongly discomforted, as is obvious from Picture 2 where the centre is shifted to the lower part of the diagram.

On the contrary, there are changes after the competition when the component „D“ – characterized by the feelings of mental and physical exhaustion - gets into the negative numbers. Consequently, the mental state of the athlete is becoming balanced to the level of comfort, as is evident from Table 2. The feelings of nervousness and restlessness weaken.

The research proved that for track cyclists it is very hard and stressful to cope with the pre-start states. Hence we would recommend the cyclists to consult these perceptions with an expert (psychologist), which would help them find the ideal coping strategy and master the difficult conditions in order to achieve the maximum physical performance.

References

1. Blahutková, M. (1999). Rozdíly aspirační úrovně jako faktoru výkonové motivace u sportující a nesportující mládeže. 121. Brno: Masarykova univerzita, Pedagogická fakulta.
2. Blahutková, M., Pacholík, V. (2008). Vrcholový sportovní výkon a reakce okolí. In D. Heller.
3. Mikšík, O. (2004). *Dotazník SUPSO: Příručka*. Brno: Psychodiagnostika s.r.o.

BODY, MOVEMENT AND SPORT IN AMERICAN PAINTING

Michał Mazurkiewicz

The Jan Kochanowski University in Kielce, Poland

Abstract

Human body, movement and sports provide constant inspiration, which manifests itself also in art. This is clearly visible in the history of painting. Numerous artists – American painters as well – have perceived sport as representing something about man's desire to achieve perfection. The aim of this paper is analysis of certain aspects of American art, concentrating on painters such as: Winslow Homer, Thomas Eakins and George Bellows. This is an attempt to find out how certain social processes in the nineteenth century and in the beginnings of the twentieth century are reflected in American painting. Sport in art definitely constitutes an important subject of scientific research. The author concentrates here on the United States, examining the history and sociology of American sport and paying attention to sports depicted by American artists, like for example boxing, very important in American culture. The research required detailed in-depth analysis of some periods in the history of American sport, close observation of a great number of American paintings, as well as reading numerous books and articles on American art. The results corroborate the importance of sport in America and the conclusions included in the final part of the paper prove that sport in art is a very interesting subject worth further research.

“The great applicability of sport as an inspiration for artists lies in its potential for symbolic reference to human existence.”

Maria Anna Potocka, Polish art critic

American Painting – Introduction

Numerous artists have drawn inspiration from sport for centuries. Sport – a very important sphere of life and a fascinating social phenomenon – definitely has the power to stimulate and is frequently present in art, which is clearly visible in the history of painting.

As for the United States, at first, American art imitated European styles; then, however, was gradually becoming more and more independent. Most of early American art – late eighteenth century through the early nineteenth century – consists of history painting and especially portraits (one can mention here John Singleton Copley¹). Next, the artistic output of American realism representatives gained popularity. In the 1820s, the Hudson River School of landscape painting was formed. During the late nineteenth and early twentieth centuries, impressionists with their style of painting characterized by loose brushwork and vivid colours became fashionable. After World War II New York – replacing Paris – became the centre of modern art. It was there that new trends were born and works which influenced the whole world's painting were created. The most important were works of the group The Eight, realism of Edward Hopper, abstract expressionism of Jackson Pollock, pop-art and the urban graffiti.

Winslow Homer – Croquet and Sailing

Winslow Homer (1836-1910) was a lithographer, illustrator and painter. At first, he was an artist mostly interested in classical oil painting who, however, later achieved wonderful results in watercolours. His contribution to American art is undisputed.

Homer is well-known as landscape painter whose paintings focused on leisure diversions. What is interesting, some of them – for instance *A Game of Croquet* or *Croquet Scene* – were devoted to the subject of croquet, which was a popular sport among the upper classes in America.² *A Game of Croquet* is the most impressionist work of Homer, both as for the subject (entertainment of young people from rich families), and as for obtained light effects. However, contrary to Monet,

¹ His most famous works include, among others: *Paul Revere*, *Boy with a Squirrel*, *Watson and the Shark* or *The Siege and Relief of Gibraltar*.

² Croquet – a game played on grass in which the players hit balls through a series of hoops, using a mallet (a wooden hammer). Regarded as an upper-class game in Great Britain. For more on croquet see: Lipoński.

Homer's paintings are created with the help of dynamic moulding, not the colour. According to the tradition of American realism, a game of croquet was recreated with the accuracy of sports broadcast (Marchetti 2005: 86). By the way, croquet also appeared in painting of other countries, for example in Poland. Leon Wyczółkowski, one of the best painters of the Young Poland movement who specialized in landscapes and pastoral scenes, also painted *A Game of Croquet*.

Coming back to Homer, one should mention his paintings devoted to sailing. *Breezing Up (A Fair Wind)*, where father and his three sons are shown out for a spirited sail and a brisk breeze fills the mainsail and heels the boat over, is one of his well-known works. It is painted with unusual verve. Homer often painted seaside landscapes and scenes presenting people struggling with the forces of nature. Looking at *Breezing Up*, we immediately notice that the sea was a favourite subject of Homer; we feel almost tangibly the waves whirling under the keel of the boat. The silhouettes of three boys and the fisherman seem to be made of delicate sea matter. It is one of these days when sea wind gives a feeling of acute freshness (Beckett 2000: 304).

A very interesting Homer's painting is also *Canoe in the Rapids*, in which the painter effectively captured the drama and excitement of a fragile canoe being tossed by a raging current. There is a sense of pleasure mixed with thrill and danger.

Thomas Cowperthwait Eakins – Admirer of Athletes

Thomas Eakins (1844-1916) is regarded as the most eminent artist of oil painting in American realism. (Beckett 2000: 305). He is one of the most famous American realist painters of the nineteenth century.

In 1884, Eakins started to co-operate with photographer Eadweard Muybridge under the patronage of Pennsylvania University and began to gather photographic documentation concerning movements made by man and animals. This material was published in 1887 in the form of an album containing over 700 pictures, put in sequences (Marchetti 2005: 90).

Eakins dedicated his career to depicting the human figure. What is important, in his critically acclaimed works, he introduced the elements of motion to American painting. Eakins painted several hundred portraits, but being an ardent sports fan, he often expressed his admiration of athletes and outdoor activities like swimming (*The Swimming Hole*), wrestling (*Wrestlers*) or rowing (*Max Schmitt in a Single Scull*³).

Eakins liked to observe sporting contests, especially rowing regattas on the Schuylkill River in Philadelphia. In the decade following the Civil War, rowing became one of America's most popular spectator sports, being very fashionable in the east of the USA (Marchetti 2005: 93). Thanks to the realistic shot of the water, which brings to mind associations with Canaletto, the pictures of Eakins depicting rowers went down in the history of painting.

The Biglin Brothers Racing is another picture of rowers, a very impressionistic one (Beckett 2000: 305). It seems as if the scene lasted a long while. There is motion, which is visible in different phases of the location of the oars, one of them biting the water. Both ends of the boat project beyond the picture's edges, which generates a sense of urgency, as does the other prow jutting suddenly into view.

George Bellows – Boxing Passion

George Bellows (1882-1925) was an American realist painter whose subject matter often included the city as he was fascinated with New York's gritty landscape. The main themes of his works are not only social scenes but also boxing matches. This studious and methodological painter was also a determinedly self-taught athlete. In his works, he liked showing unstoppable vivacity of sportsmen (Gołębiowski 2004: 281). It should be noted that boxing was one of the most popular sports at the beginning of the twentieth century. The fights were forbidden, but in some clubs – like at Tom Sharkey's in New York – they were illegally organized. (Marchetti 2005: 167).

Bellow's painting *Stag at Sharkey's*, manages to capture the tawdry underworld flavour of the clubs in which boxing was practised in the United States. As for the fight, it is gruelling; we can see the tense muscles and intertwined bodies; there is passion, drama, excruciating force. The boxers seem to bring the house down – the ring is surrounded by fans in an absolute frenzy. The painting is painted with energetic movements of the brush.

It is worth mentioning that the 1920s boxing acquired a new level of respectability. Before the First World War the fights were often organized in secret in isolated rural areas or hidden places in cities and had a bad reputation. During the war the army used boxing as a part of the training and after the war legal barriers to prize fighting were officially dropped. Boxing entered huge stadiums and enjoyed unprecedented popularity. It was fashionable for American celebrities, high society, "proper women" to watch the fights (Rader 1983: 187).

³ Eakins showed his friend, Max Schmitt, resting after winning (or before starting?) a race and himself rowing another scull away from the viewer.

Another Bellow's painting, *Dempsey and Firpo* is considered the finest American sports painting by many experts. The picture, inspired by the ferocious fight between American legend of boxing Jack Dempsey⁴ and Luis Angel Firpo, took place in 1923 and is often described as the most savage two rounds in the history of boxing. At one moment, Dempsey was sent through the ropes and this dramatic part of the match inspired Bellows.

Summary

To sum up, as it has been demonstrated in this brief analysis, sport and art make an exciting combination. The United States is no exception here. In the course of history, there were many painters fascinated with sport and depicting it in miscellaneous forms. I have presented three of them, definitely illustrious artists. Anyone interested in this subject should explore it further.

References

1. Beckett W., *Siostra Wendy, Historia malarstwa. Wędrowki po historii sztuki zachodu/The Story of Painting. The Essential Guide to the History of Western Art*, Arkady, Warszawa 2000.
2. Dunning E., *Sport Matters*, Routledge, London and New York 1999.
3. Gołębiowski M., *Dzieje kultury Stanów Zjednoczonych/The History of American Culture*, PWN, Warszawa 2004.
4. Johnson P., *A History of the American People*, Harper Perennial, New York 1999.
5. Lipiński W., *World Sports Encyclopedia*, Oficyna Wydawnicza Atena, Poznań 2003.
6. Marchetti F. C., *Malarstwo amerykańskie/American painting*, Arkady, Warszawa 2005.
7. Rader B. G., *American Sports: From the Age of Folk Games to the Age of Spectators*, Prentice Hall, Englewood Cliffs 1983.
8. Zirin D., *A People's History of Sports in the United States*, The New Press, New York and London 2008.

⁴ Dempsey was the World Heavyweight Champion from 1919 to 1926. His popular name was The Manassa Mauler because he was from Manassa, Colorado and mauled his opponents.

EXPRESSING KEY CONCEPTS IN HUMAN MOVEMENT SCIENCE: ANALYSIS OF FOOTBALL-RELATED ARTICLES' TITLES

Darija Omrčen¹ and Hrvoje Knežević²

¹*Faculty of Kinesiology, University of Zagreb, Croatia*

²*Zagreb, Croatia*

Abstract

Every scientific discipline forms its own system of concepts and assigns names to these concepts. Ultimately, terminology, one of the crucial epistemological characteristics of scientific disciplines, is created. The aim of this investigation was to find out which words, i.e. terms, have been used in the sample of 424 randomly selected titles of articles whose topics were connected with football to refer to three concepts crucial to human movement science – cause, effect and motion. The analysis has shown that a rather limited set of words was found to appear in the selected titles to denote each of the listed concepts.

Key words: concept, cause, effect, causality, terminology

Introduction

Concept formation is “one of the classical problems in the philosophy of science” (Blahuš, 1996, p. 13). Concepts are usually understood as mental representations that are formed by summarizing attributes of either abstract or physical objects. They represent components of scientific theories. Within the scientific community in general various epistemic communities exist that focus on a domain of their expertise and interest. According to Roth and Bourguin (2005), an epistemic community refers to a group of experts who conduct research within the same epistemic framework; to be able to do so these experts must work on concepts that are specific for this epistemic community. These concepts are denoted by terms – ultimately, terminology of a scientific discipline in question is created. Terminology, together with the problem of research, subject matter, methodology and research methods, belongs to the set of basic epistemological characteristics or prerequisites of every scientific discipline (Milat, 2005, pp. 23, 24). Unfortunately, as pointed out by Graybeal, Isenor and Rueda (2012, p. 122), “many communities do not recognize the importance of terms and vocabularies, especially their importance to interoperability”.

Scientific texts are a way of conveying perceptions, theories, research results, etc. to members of the scientific community. Nowadays databases containing a multitude of scientific texts offer an insight into the realm of contemporary scientific inquiry. Journals have increasingly gained importance in terms of presenting research results to a wide scientific public, so that consequently significant attention is paid to the structuring of articles published in them. Titles, and also abstracts, thus represent that part of an article's text that a prospective reader first encounters when searching the databases. According to Soler (2007), titles are of vital importance and frequently serve as means of searching for scholarly data of their interest. Titles of scientific publications have been in the focus of interest of many researchers, who analysed them from various points of view. As for the content conveyed by a title, in some earlier studies (Tocatlian, 1970; Buxton & Meadows, 1977; Diener, 1984) analyses were found to address, for example, the number of substantive words in the titles, whereas some recent studies (Gesuato, 2008; Harmon, 2009; C.E. Paiva, Lima, & B.S.R. Paiva, 2012) dealt with the information, regarded from various points of view, contained in titles. A significant number of researches were aimed at constructing semantic networks on the basis of titles of scientific papers (cf. Pereira, Fadigas, Senna, & Moret, 2011). The titles of articles dealing with the topics connected with football (soccer) have been analysed previously by Knežević (2012) in terms of, among other things, title length and lexical density, the incidence of certain terms or sets of terms, number of authors, etc.

Accordingly, the aim of the research in this article was to analyse how three concepts crucial to human movement science—cause, effect and motion—are expressed in the titles of scientific articles whose topics were connected with football.

Methods

The sample was comprised of 424 randomly selected titles (publication period: 2000 – March 2014), written in English, of scientific articles dealing with the topics connected with football. The titles were collected from the databases *Web of Science* and *Science Direct*. The key words used to search for the titles were *soccer* and *football*. Attention was

paid to the fact that the word *football* may be used to denote several types of team games whose names contain this word (e.g. American football, Gaelic football, etc.). The check was made to certify that the game referred to in the title, and, consequently in the text that a title stands for, was *soccer*, that is football whose international governing body is *Fédération Internationale de Football Association* (FIFA).

One of the aims of scientific theories is scientific explanation. “Scientific explanation may be causal, unificatory, nomological, statistical, deductive, inductive or any combination of them” (Rosenberg, 2006, p. 56). Since in terms of epistemology causality belongs to the set of critical foci of science in general, i.e. to a wide epistemic community, and since it implies the cause-and-effect relationship between phenomena, two key concepts in this respect—*cause* and *effect*—were selected accordingly for the analysis. Further, the usage of words conveying the concept of *movement*, being among the principal concepts of human movement science, was also analysed. *Roget’s Thesaurus of English Words and Phrases: Body with Parts of Speech* (released: 2004, assembled by L. John Old, <http://www.gutenberg.org>) was used as a reference source for the identification of words that can be used to express the selected concepts.

Results

As presented in Table 1, from a rather extensive cluster of words and phrases listed in *Roget’s Thesaurus of English Words and Phrases: Body with Parts of Speech* (released: 2004, assembled by L. John Old, <http://www.gutenberg.org>) as those expressing the notion of *cause*, nouns, verbs and adjectives, were used in the titles to make reference to the concept in question.

Table 1: Words and phrases used in the titles to denote the concepts of cause and effect

CAUSE	EFFECT
cause (n)	effect (n)
influence (n)	result (n)
key (n)	development (n)
agent (n)	production (n)
induce (v)	work (n)
create (v)	performance (n)
causal (adj)	due to (adj)
	caused by (adj)
	as a consequence (adv)

Legend: n – noun; v – verb; adj – adjective; adv – adverb

The word *production* was found both on the list of words in the cluster referring to *cause* and on the list of words in the cluster referring to *effect*. However, in the analysed titles it was found to refer to effect, and was hence listed in Table 1 among the words denoting only the concept of effect.

Table 1 also shows that of the words listed in the reference source to express the concept of *effect* nouns, adjectives and adverbs were used in the titles under consideration. Like the words used to denote the concept of *cause*, in the reference source used for this investigation these words were also categorized as those expressing abstract relations, and within this class to the set of words typifying the concept of causation as well. This means that semantically both *cause* and *effect* belong to the more complex concept of causation. Interestingly, of the words and phrases listed in the reference source to express motion, only nouns appeared in the analysed titles (Table 2). In other words, the concept that implies the change of place, which subsequently implies action, was denoted exclusively by nouns, not by verbs. The dominant usage of nouns points to one of the characteristics of the scientific style of writing, i.e. to the process of nominalization.

Table 2: Words and phrases used in the titles to denote the concept of motion

MOTION
motion (n)
movement (n)
move (n)
evolution (n)
kinematics (n)
rate (n)
velocity (n)
locomotion (n)
in motion (adj)

Legend: n – noun

Discussion and conclusions

The selection of analysed terms was aimed at showing how some concepts and their accompanying terms are inevitable in a scientific discipline, the science of human movement in this case, i.e. within it, the epistemic community that analyses various aspects of football. The overall concept of research in science implies striving to arrive at new perceptions, i.e. to gain objective knowledge. Scientific research is aimed at scientific explanation through the analysis of different aspects connected with the subject matter under consideration. What scientific explanation requires is knowledge that is viewed as causal. Epistemologically, causality and causal inference are critical tasks of science. Epistemic causality, according to Williamson (2007, pp. 111-112), is a twofold concept – on the one hand it “advocates an inductive approach to causal discovery”, and on the other, in terms of methodology, it is hypothetico-deductive. Ultimately, “epistemic causality leads to an objective concept of cause” (Williamson, 2007, p. 109). Causality implies the cause-and-effect relationship between phenomena. Their interrelatedness makes it possible to predict the outcome of the interaction between them. The cause-and-effect relationship regards relatedness on a general level, and different types of this relatedness, e.g. correlation, comparison, etc., on a more specific level. The initial notion in this abstract relation is the one of *cause*. The possible words denoting cause were categorized in *Roget's Thesaurus of English Words and Phrases: Body with Parts of Speech* (released: 2004, assembled by L. John Old, <http://www.gutenberg.org>) under the class which consists of words and phrases expressing abstract relations, more precisely the notion of causation, and within it the constancy of sequence in events. The number of words found in the titles to denote this concept, and taking into account the fact that the words sought in the titles were in compliance only with the selected reference source, almost equalled the number of words and phrases used to denote the other concept in this bipartite association, i.e. the concept of effect.

The justification for allocating the words denoting cause to the same cluster is to be found in their etymology and consequently, naturally, in their usage. Thus, for example, the Latin word *causa* refers to a *cause*, i.e. to a thing, event, phenomenon, etc., that makes something happen as an effect. Both the word *influence* and the word *induce* imply the notion of *bringing into* – as for their etymology, the former is derived from the Latin verb *influerre* meaning *to flow in(to)* and the latter also from a Latin verb, *inducere*, meaning, among other things, *to lead in(to)*. The word *key* is of unknown origin, so that in its case, no such reference can be made. Naturally, since the chosen reference source cannot provide all the possible words and phrases denoting the concept of cause, some that are not listed in this source were found to occur in the titles. For example, the verb *determine* appearing in the set of words in the selected reference source and conveying the concept of cause was not found in the titles; however, the words *determinant(s)* and *determination* that are not included in the previously mentioned cluster were found to be used in the sample of titles in this investigation. Consulting another reference source would probably produce somewhat different results. For example, *Collins Internet-Linked Dictionary of Synonyms and Antonyms* (2005, p. 105) lists the word *motivation* as one of the possible words expressing cause and this word is to be found in the analysed sample of titles.

Human movement science is interested in effects that movement has on human organism. According to Mraković (1971), kinesiology is the science that deals with specially conditioned movement and its aim is to identify the regularities of transformational processes occurring under the influence of movement. In other words, kinesiology analyses causes, changes, regularities and effects of movement. Therefore, and taking into account that football is a game which implies movement, the effects—in other words, changes—incurred by different stimuli on, for example, motor abilities or morphological characteristics of football players, in other words, the responses of a human organism to such stimuli represent the critical points of interest in this scientific discipline. As for the origin of the word *effect*, it is derived from the Latin verb *efficere* meaning *to make or to carry out* (*Webster's Encyclopedic Unabridged Dictionary of the English Language*, 1996, p. 622), thus implying the notion of a result. If another reference source be consulted, for example, the already mentioned *Collins Internet-Linked Dictionary of Synonyms and Antonyms* (2005, p. 219), this would result in adding some words to the already existing ones referring to the concept of effect. Subsequently, words such as *outcome*, *impact* and *influence* could be included in the list of words expressing the notion of effect in the sample of titles.

Interestingly, in *Roget's Thesaurus of English Words and Phrases: Body with Parts of Speech* (released: 2004, assembled by L. John Old, <http://www.gutenberg.org>) the word *influence* is listed either within the class containing words that express abstract relations to refer to the concept of *change*, but also to refer to the concept of *cause* within the broader concept of *causation*. In other words, within the section of causation, the word *influence* is used to convey the meaning of *cause* which is categorized as a concept within the constancy of sequence in events and to convey the concept of *power* thus belonging to the broader concept referring to the connection between cause and effect (*influence* is also regarded as a separate cluster within the set of words and phrases categorized as referring to indirect power, however, the concept of *influence* was not in the focus of investigation in this research). In *Collins Internet-Linked Dictionary of Synonyms and Antonyms* (2005, p. 105), for example, the word *influence* is found to be listed as a synonym of the word *effect*, but not as a synonym of *cause*. The survey of the titles selected for this analysis shows that the meaning in which the word *influence* was dominantly used in them referred to the concept of cause and to the connection between cause and effect.

When subject matters expressed in the titles be taken into account, it becomes obvious that the concept of cause has been addressed in articles whose topics frequently focus on physiological changes occurring due to the agency of certain factors, but also to injuries incurred in football context, to the training process, and to a lesser degree to biomechanical

issues. The concept of effect was found to be addressed in a wider scope of topics, e.g. in health-related ones, in articles focusing on the training process, physiology (metabolism), team performance, play analysis, motor abilities, biomechanics, genetics, anthropology in relation to performance, psychology, medicine, etc.

The notion of *movement* has not been identified as a separate cluster in *Roget's Thesaurus of English Words and Phrases: Body with Parts of Speech* (released: 2004, assembled by L. John Old, <http://www.gutenberg.org>). However, the notion of *motion* is to be found as a semantic cluster, i.e. concept. The list of words expressing it contains, among other words, the word *movement* as well. Thus, movement is regarded both as a subordinate concept and as a subordinate term to a more complex concept, that of *motion*, which obviously has a broader scope that it refers to. Regarded in terms of physics, *motion* is the concept that is under consideration, thus making *human movement* partly belonging to the domain of physics. This is manifested in the fact that biomechanics, for example, a scientific discipline that scrutinizes movement, is a branch of mechanics, i.e. a branch of physics. Physics analyses motion in general, whereas biomechanics focuses on, e.g., human movement, and while doing so applies the laws of physics. Interestingly, *Roget's Thesaurus of English Words and Phrases: Body with Parts of Speech* (released: 2004, assembled by L. John Old, <http://www.gutenberg.org>) does not list the word *motor* among the words expressing the notion of motion. However, in human movement science this word is used in various collocations to refer to some key concepts in this scientific discipline, e.g. *motor ability*, *motor skill*, etc. Moreover, the three words—*motion*, *movement* and *motor*—share the same Latin origin, i.e. the Latin verb *movēre* meaning *to move*. Other additional words used in the titles and not listed in the previously already mentioned source could also be said to refer to motion – for example, the words like *running*, *speed*, *kinetic*, *sprint(ing)* and *acceleration*. Out of this group of words, *running* and, for example, *sprint(ing)* might be said to refer to the narrower concept, i.e. *movement*, whereas other words comprising this set are applicable to the concept of motion understood on a broader basis. The fact that nouns were used to refer to the concept of motion, i.e. the concept that implies a process, points to the process of nominalization in scientific texts. Word classes have the so called unmarked functions (Banks, 2005), i.e. nouns express entities, verbs express process and adjectives express quality. However, as pointed out by Banks (2005), nouns derived from verbs, i.e. deverbal nouns, (Latin *movēre* (*v*) → English *to move* (*v*) → *motion* (*n*), *movement* (*n*); *to run* (*v*) → *running* (*n*), etc.) can also refer to a process, or any of its phases or agents. The justification of nominalization, according to Banks (2005, p. 350), lies in the fact that “the nominalization permits the concentration of information”.

Exercise, another key concept in human movement science, and the concept connoting movement, has in *Roget's Thesaurus of English Words and Phrases: Body with Parts of Speech* (released: 2004, assembled by L. John Old, <http://www.gutenberg.org>) been allocated to the concept of agency, i.e. power in operation, which means that it ultimately belongs to the general concept of causation. On the other hand, *exercise* can also be found, together with *practice*, as a word indicating the concept of learning. *Play*, another concept that implies movement, belongs to one of the central concepts of all sporting games. According to the categorization of words in the selected reference source, *play* belongs to the notion of *agency*, a concept belonging, among other ones, to the set of words expressing power in operation, thus ultimately belonging to the notion of *causation*.

The analysis has shown that a rather limited set of words was found to appear in the analysed titles to denote each of the selected concepts. The list of words referring to each concept would have probably been longer if full texts of articles had been taken into account. Since variety of expression depends on many factors, among them also, to a certain extent, on individual writing style of authors, this is a variable that allows for much diversity and is therefore very difficult to consider strictly. The yielded results also show that the selected key concepts, central to scrutiny in human movement science, are also expressed in the context of a narrower epistemic community, i.e. the one that focuses on football-related topics.

References

1. Banks, D. (2005). On the historical origins of nominalized process in scientific text. *English for Specific Purposes*, 24, 347-357.
2. Blahuš, P. (1996). Concept formation via latent variables modeling of motor abilities. *Kinesiology*, 28(2), 12-21.
3. Buxton, A.B., & Meadows, A.J. (1977). The variation in the information content of titles of research papers with time and discipline. *Journal of Documentation*, 33(1), 46-52.
4. *Collins internet-linked dictionary of synonyms and antonyms* (2005). Glasgow: HarperCollins Publishers.
5. Diener, R.A.V. (1984). Informational dynamics of journal article titles. *Journal of the American Society for Information Science*, 35(4), 222-227.
6. Gesuato, S. (2008). Encoding of information in titles: academic practices across four genres in linguistics. In Christopher Taylor (Ed.), *Ecolingua. The role of e-corpora in translation and language learning*, pp. 127-157.
7. Graybeal, J., Isenor, A.W., & Rueda, C. (2012). Semantic mediation of vocabularies for ocean observing systems. *Computers & Geosciences*, 40, 120-131.
8. Harmon, J. E. (2009). The structure of scientific titles. *Journal of Technical Writing and Communication*, 39, 455-465.
9. Knežević, H. (2012). *Analiza diskursa engleskih naslova znanstvenih članaka o nogometu [Analysis of discourse of English titles of scientific articles on football]*. In Croatian]. [Unpublished graduation thesis] Zagreb: Kineziološki fakultet.
10. Milat, J. (2005). *Osnove metodologije istraživanja [The fundamentals of research methodology]*. In Croatian]. Zagreb: Školska knjiga.

11. Mraković, M. (1971). Kineziologija [Kinesiology. In Croatian]. *Kineziologija*, 1(1): 1-5.
12. Paiva, C.E., Lima, J.P.S.N., & Paiva, B.S.R. (2012). Articles with short titles describing the results are cited more often. *Clinics*, 67, 509-513.
13. Pereira, H.B.B., Fadigas, I.S., Senna, V., & Moret, M.A. (2011). Semantic networks based on titles of scientific papers. *Physica A*, 390, 1192-1197.
14. *Roget's thesaurus of English words and phrases: Body with parts of speech*. (released 2004). Assembled by L. John Old, Project Gutenberg's #22. [eBook #10681]. Accessed at www.gutenberg.org on January 10, 2013.
15. Rosenberg, A. (2006). *Philosophy of science: A contemporary introduction*. 2nd reprinted edition. New York: Routledge.
16. Roth, C., & Bourguine, P. (2005). Epistemic communities: Description and hierarchic categorization. *Mathematical Population Studies*, 12, 107-130.
17. Soler, V. (2007). Writing titles in science: An exploratory study. *English for Specific Purposes*, 26, 90-102.
18. Tocatlian, J.J. (1970). Are titles of chemical papers becoming more informative? *Journal of the American Society for Information Science*, 21(5), 345-350.
19. *Webster's encyclopedic unabridged dictionary of the English language* (1996). New York: Gramercy Books, Random House Value Publishing, Inc.
20. Williamson, J. (2007). Causality. In D.M. Gabbay & F. Guenther (Eds.) *Handbook of philosophical logic*. 2nd Edition, Volume 14, (pp. 95-126). Dordrecht: Springer.

GENDER DIFFERENCES IN SPORT MINDSET

Franjo Prot, Boris Balent and Ksenija Bosnar

Faculty of Kinesiology, University of Zagreb, Croatia

Abstract

Researching self-theories, Carol Dweck developed concept of mindset explaining success or failure in some activity by abilities or effort (Dweck, 1999), and call it growth and fixed mindset, respectively. The aim of this study is to research gender differences in mindset regarding sport, to inspect possible explanation of some behavioral differences by believing in abilities or effort to be factors of sport achievement. For that purpose, the sample of 229 male and 128 female students were given the questionnaire including 38-items sport mindset scale, 52-items sport interests scale, estimation of percentage of effort and abilities in sport success and level of achievement in sport. The result on mindset scale was established as first principle component of correlation matrix of 38 items. General interest toward sport was defined as first principle component of correlation matrix of 52 sport preferences. Gender differences were established as statistically significant by multivariate analysis of variance at level $p < 0.0015$. Males put higher value on effort as factor of sport success when estimated by percentage, mean value is 74% compared to 69% found in females. Univariate analysis show no difference when mindset was measured by scale. In the sample of students of kinesiology no difference in the level of sport achievement was found, but females have slightly higher general interest in sports. The results suggest that estimation of percentage of effort and abilities in sport success is perhaps to simple way to measure mindset, and more complex scale is recommended.

Key words: *growth and fixed mindset, gender differences*

Introduction

Comparative studies show remarkable number of gender differences in behavior and achievement developed mainly under cultural influence (Eccles et al., 2000). Revealing underlying processes of gender differentiation is inevitable step for understanding and intervention. Notable example comes from the field of gender differences in mathematics. As was presented by Carol Dweck (2006a, 2006b), lower achievement of female pupils in mathematics in USA could be explained by (false) beliefs that success in mathematic is strictly related to male abilities and could not be changed by any female effort. Researching self-theories, Carol Dweck developed concept of mindset explaining success or failure in some activity by abilities or effort (Dweck, 1999), and call it growth and fixed mindset, respectively.

In the field of sport, a number of gender differences in interest and participation were found (Pfister and Lippe, 1994; Klomsten et al., 2005; Prot, et al. 2006). To explain this phenomenon, researches were done regarding attitude development and gender typing of sports (Bosnar and Žugaj, 2009; Koivula, 1995), development of gender role stereotypes including values, expectancies and beliefs (Eccles et al., 1990; Klomsten et al., 2005), role of parenting in gender differences in sport development (Brustard, 1996; Eccles et al., 2000). One possible perspective for understanding gender differences in sport behavior could be Dweck's model (2006a). Sport is still understood to be male activity and almost all abilities related to sport achievement are underestimated in self-concept of girls (Klomsten et al., 2004). Combined with mindset that effort is of less importance in sport, it can be the reason of lower proportion of girls in sport activities (Xiang et al., 2001).

The aim of this work is to research gender differences in sport mindset on the young adults who are physically active much more than average population. The results should show does difference in beliefs relating to sport exist even in the part of population where difference in behavior is as small as possible.

Methods

The research was done on the sample of 229 male and 128 female students of kinesiology from Zagreb, where 167 males and 98 females have complete set of data. Students were given the questionnaire including 38-items sport mindset scale and 52-items sport interests scale; they were asked to estimate percentage of effort and percentage of abilities in sport success, with total of 100%. They were also asked to mark their level of achievement in sport on 7-point scale, rating from “1- I have no sport experience” to “7- I have been the member of national team”. In this sample, nobody stated that did not have experience in sport, and only 10% participated in school sport programs or in recreational activities. The result on mindset scale was established as first principle component of correlation matrix of 38 items. General interest toward sport was defined as first principle component of correlation matrix of 52 sport preferences. Gender differences were established by multivariate analysis of variance on the subset of respondents having whole set of data.

Results

Correlations in Table 1. are very low suggesting almost orthogonal constellation. Highest value is -0,21, meaning that percent of common variance of mindset scale and effort estimation is less than 5%.

Table 1: Correlations of the result on first principle component (K1) of mindset scale (1.), first principle component (K1) of sport interest scale (2.), Sport achievement scale (3.) and Effort estimation (4.)

	1.	2.	3.
1. Mindset scale K1	1,00		
2. Sport interests scale K1	0,125	1,00	
3. Sport achievement scale	-0,040	0,005	1,00
4. Effort estimation	-0,210	0,022	-0,089

Gender differences were established as statistically significant by multivariate analysis of variance at level $p < 0.0016$ (Table 2). Univariate tests show that main variable forming that difference is estimation of percentage of effort ($p < 0,01$); general interest toward sport show difference significant on the level of $p < 0,03$. other two variable show no difference (Table 4). Having highly selected sample of students of kinesiology, it was expected that no significant gender difference in the level of sport achievement is going to be find.

Table 2: Results of multivariate analysis of variance in two measures of mindset, level of sport achievement and general interest in sports regarding gender.

Factor	Wilks' lambda	Rao's R	df 1	df 2	p-level
Gender	.934953	4.522210	4	260	.001508

Table 3: Means and standard deviations of first principle component of 38-items sport mindset scale, 52-items sport interests scale, estimation of percentage of effort and in sport success and level of achievement in sport in two groups defined by gender.

Gender	Mindset scale K1		Sport interests K1		Effort		Sport achievement		Valid N
	Mean	SD	Mean	SD	Mean	SD	Mean	SD	
Males	-.0162	1.109	-.1127	1.008	73.976	13.854	4.719	1.232	167
Females	.0375	.876	.1940	.924	68.714	15.433	4.949	1.388	98
Total	.0037	1.027	.0007	.987	72.030	14.652	4.804	1.294	265

Means of the results (Table 3) show that males put higher value on effort as factor of sport succes when estimated by percentage, mean value is 74% compared to 69%. At the same time, there is no difference when mindset was measured by scale. Higher general interest in sports was registrated in female students.

Table 4: Results of univariate analyses of variance of first principle component of 38-items sport mindset scale, 52-items sport interests scale, estimation of percentage of effort and in sport success and level of achievement in sport regarding gender.

	df 1, df2	MS Effect	MS Error	F-value	p-level
Mindset scale K1	1, 350	.095259	1.002585	.095013	.758081
Effort	1, 352	1451.366	214.0221	6.781382	.009602
Sport interests K1	1, 278	5.031709	.991725	5.073692	.025072
Sport achievement	1, 276	3.451698	1.650159	2.091736	.149232

Discussion and conclusions

The sample in this research consists of subjects who are physically very active and have experience in sport, and do not represent general population. Due to selection, correlations among variables will tend to be lower indicating relative independency, which might not be true for entire population. This is clearly illustrated by correlation between general sport interests and sport achievement scale. Correlation of mind set scale and effort estimation is low, probably because of the same reason. In such circumstances, even relatively small differences in absolute values of variables may be relevant. The results of multivariate analysis of variance followed by univariate analyses of variance are showing that multivariate difference is based on the direct contribution of measure of effort and measure of overall sport interest. When mindset is measured by scale, there is no gender related difference. It means that composition and formulation of items bring some indiscriminative content to the first principal component.

Observed gender difference in effort estimation can be explained in manner that male and female sport are seen as two parallel systems of contemporary sport. In male competition, results are consistently higher than in female sport, and could be seen as needing more effort. Higher estimation of proportion of effort in sport success in males perhaps means that in males talent is considered just as a starting point for overall improvement in excellence through systematic training. If that is true, when levels of demand in female sport become as high as in male sport, what can be expected in the near future, estimations of importance of effort should become more similar in males and females.

References

1. Bosnar K. and Žugaj, S. (2009). Gender typing of sports in Croatian university students. In. Doupona Topič, M. And Ličen, S. (Eds.): Sport, culture & society: an account of views and perspectives on social issues in a continent (and beyond), Ljubljana: University of Ljubljana, Faculty of Sport, 161-164.
2. Brustad, R. J. (1996). Attraction to physical activity in urban schoolchildren: Parental socialization and gender influences. *Research Quarterly for Exercise and Sport*, 67, 316-323.
3. Dweck, C. S. (1999). *Self-theories: Their role in motivation, personality and development*. Philadelphia: Psychology Press.
4. Dweck, C.S. (2006a) *Mindset: the new psychology of success*. New York: Ballantine Books.
5. Dweck, C.S. (2006b) *Is Math a Gift? Beliefs that Put Females at Risk*, in S.J. Ceci & W. Williams (Eds) *Why Aren't More Women in Science? Top Researchers Debate the Evidence*. Washington DC: American Psychological Association.
6. Eccles, J. S., Freedman-Doan, C., Frome, P., Jacobs, J., & Yoon, K. S. (2000). Gender-role socialization in the family: A longitudinal approach. In T. Eckes & H. M. Trautner (Eds.), *The developmental social psychology of gender* (pp. 333-360). Mahwah, NJ: Lawrence Earlbaum Associates.
7. Eccles, J. S., Jacobs, J. E., & Harold, R. D. (1990). Gender role stereotypes, expectancy effects, and parent's socialization of gender differences. *Journal of Social Issues*, 46(2), 183-201.
8. Eccles, J. S., & Harold, R. D. (1991). Gender differences in sport involvement: Applying the Eccles' Expectancy-Value model. *Journal of Applied Sport Psychology*, 3, 7-35.
9. Klomsten, A. T., Marsh, H. W. and Skaalvik E. M. (2005.) Adolescents' Perceptions of Masculine and Feminine Values in Sport and Physical Education: A Study of Gender Differences. *Sex Roles: A Journal of Research*, 52 (9-10), 625-636.
10. Klomsten, A. T., Skaalvik, E. M., & Espnes, G. A. (2004). Physical self-concept and sports: Do gender differences still exist? *Sex Roles*, 50, 119-127.
11. Koivula, N. (1995). Ratings of gender appropriateness of sports participation: Effects of gender-based schematic processing. *Sex Roles*, 33, 543-557.
12. Pfister, G., and von der Lippe, G. (1994). Women's participation in sports and the olympic games in Germany and Norway: A sociohistorical analysis. *Journal of Comparative Physical Education and Sport*, 16, 30-41.
13. Prot, F., Bosnar, K. i Sporiš, G. (2006). Discriminant analysis of sport interests in young male and female urban adolescents. 3th European Association for Sociology of Sport Conference. *The changing Role of Public, Civic and Private Sectors in Sport Culture*. Jyväskylä, Finland: EASS, pp.83.
14. Xiang, P., Lee, A.M., & Williamson, L. (2001). Conceptions of ability in physical education: Children and adolescents. *Journal of Teaching in Physical Education*, 30, 282-294.

RITUAL FORMALISM OF THE JAPANESE KORYU BUDO: A SOCIO-ANTHROPOLOGICAL APPROACH

Leo Rafolt

Faculty of Humanities and Social Sciences, University of Zagreb, Croatia

Abstract

The paper presents a socio-anthropological analysis of the interrelation between traditional Japanese martial arts culture (*koryu budo*) and its modern correspondents (*gendai budo*). The author interprets the ritual and pattern formalism of the Japanese budo, especially in the context of Japanese nationalist history. Emphasis is put on the structures of movements that pre-exist in ritual practices of classical budo culture and are still present in modern martial arts systems as judo, aikido, kendo etc.

Key words: *koryu budo, gendai budo, ritual, kata, Japanese martial arts*

Introduction

Japanese martial arts are nowadays widely known in western societies, although they have stopped gaining popularity in the last couple of decades. Some of them have transformed its legacy in westernized sports and leisure activities. More than half a century ago some became members of the Olympic family of sports and different national or international organizations. They have been included in educational systems and curriculums inside and outside Japan, either because of pedagogical values they promote, competitive nature they contextualize, either because of the rich cultural background and the important role they have in preserving national heritage (Sugie, 2009; Kanno, 2009). According to central Japanese martial arts and martial culture research institution, Nippon Budokan, these martial arts are the following: judo, karate(do), kendo, kyudo, sumo, aikido, shorinji kempo, naginata and jukendo. Judo and karate(do) are definitely most known among the above mentioned martial arts, especially on the west, although popularity of the arts like kendo, kyudo, aikido and sumo is definitely increasing among western practitioners. Although Jigoro Kano, the founding figure of judo, made a lot of efforts during the 1930s to include judo in the international circles of physical education and sports, unfortunately it remained a central component of Japan's nationalistic and militaristic education. Furthermore, after the war, in November 1945, all martial arts in Japan were banned by the occupying Allied Forces General Headquarters and the martial education system in schools was, at that point, suddenly interrupted. Just a couple of decades later All Japanese Judo Federation was established and, automatically being a part of the Japanese Sports Association since 1951, it became also affiliated to the Japanese Olympic Committee. Similar histories can be traced for kendo, kyudo and sumo. After these were forbidden by the occupying forces, they soon became recognized by some of the international bodies, including General Association of International Sports Federations (GAISF) and the International Olympic Committee (IOC). Even before the World War I some of these martial arts were able to promote themselves among many western competitive disciplines. For example, kyudo was presented on London Olympics in 1908 by a couple of Japanese practitioners that were, surprisingly, competing in western style archery. On the other hand, many of the above mentioned martial arts disciplines produced newer and even more modern martial arts (Russian sambo, Japaneseshintaido, yoseikan budo and nanbudo, Korean kumdo and hapkido, Brazilian jiu-jitsu, to name just the few of them) and combat sports (UFC, MMA) that are nowadays gaining popularity (Murata, 2009). But all the mentioned styles of the Japanese martial arts, actually, are not so old in tradition. In other words, they are also reformed martial arts and combat strategies with (clear or unclear) historical roots and movement genology.

Ancient ways and modern *budo*

In the history of Japanese martial arts there is a strong division between modern martial arts or the above mentioned ones, usually called *gendai budo*, and, on the other hand, traditional martial arts, heritage, usually denominated by the terms *koryu budo*, *koryu bujutsu* or *kobudo*. Modern budo arts, such as shorinji kempo, karate, judo, aikido or kyudo, have their roots in the classical martial schools developed from the end of Heian period (794-1185) through the Tokugawa period (1600-1868) of Japanese military history, in the martial arts technical heritage that is often divided in different styles, schools or traditions (*ryuha*). One of the first category of combat traditions developed in the early Heian period was mounted archery (*kyuba jutsu*) and one of the oldest sword routines was the one belonging to Kashima tradition (Yokose, 2009). It is very important to mention that all the traditions of *koryu budo* were so called technically composite

and integrative traditions. Due to realities of war the practitioners were obliged to educate themselves in close-combat techniques, armed and unarmed techniques, swimming strategies, military tactics etc. For example, one of the oldest traditional martial arts schools, Shinto-ryu, employed techniques and strategies of armed and unarmed combat, knife throwing, spearmanship, swordsmanship and even engineering. Broadly taken, koryu budo can be categorized in the following heterogeneous groups: *bujutsu* or horsemanship, *kyujutsu* or archery, *kenjutsu* or swordsmanship, *sojutsu* or spearmanship, *naginatajutsu* or glaive using techniques, *bojutsu* or staff combat techniques, *kamajutsu* or sickle techniques, *jujutsu* or unarmed or small-armed close combat techniques, *suijutsu* or tactical swimming and *hojutsu* or musketry techniques. It would be easy to conclude that modern martial arts were derived from specific groups of the here mentioned categories. But it is not that simple. Technical repertoire of judo and aikido, to offer just two examples, is more influenced by armed koryu school and traditions than the unarmed ones. From the anthropological standpoint, as I will show later on, this is very interesting, because it attracts different light to the relatively unknown history of the Japanese budo. During the Tokugawa period (1600-1868) the number of schools suddenly progressed, reaching the number of almost one hundred ryuha. At that point mystical aura surrounding martial arts was created, mainly because of neo-Confucian philosophy, esoteric Buddhism and Shinto religious rituals, etc. This aura is still related to martial arts, even today, although in a purely socio-anthropological sense, it is useless to analyze martial arts in this manner, as ‘Zen-arts’ (Cox, 2003). More likely this can be interpreted by statistical reasons: Japanese military history demanded different sorts of physical education in the area of combat systems. This is why at the end of 17th century Japanese historians mention around fifty two *ryu* of archery, around seven hundred schools of swordsmanship, more than one hundred styles of spearmanship, and around two hundred schools for close unarmed and armed combat. During the Meiji period, before the World War I (1868-1912), samurai class system was dismantled. After the Meiji Restoration in 1868, some of the traditional martial arts schools almost disappeared. There were some efforts to preserve koryu budo as an intangible cultural heritage of Japan's utmost history. For example, commercial martial arts shows and demonstrations (*gekken kogyo*) were often performed to promote the historical values of *bushido* code and koryu budo styles. Furthermore, in 1895 Great Japan Association of Martial Virtue (Dai Nippon Butokukai) was established in order to preserve ancient martial ways. The founder of judo, Jigoro Kano, also played a great role in preserving koryu budo schools, mainly because he admitted that most of judo techniques were actually inherited from different traditions, such as Kitoryu, Daitoryu and Tenjin Shin'yoryu. Some of the experts in different styles of koryu budo even collaborated to create a unique curriculum, for example, for kendo examinations. In 1912 a unique set of forms (*kata*) for kendo was created in order to represent some of the fundamental principles of different traditional swordsmanship schools. Since 2009 All Japanese Budo Association acknowledges seventy eight koryu budo schools with clear lineages and history that have been affiliated to Japanese Classical Budo Association (Nippon Kobudo Kyokai). Surprisingly enough, central institution for Japanese martial arts, both modern and traditional (Nippon Budokan), was actually founded and opened in 1964, in the occasion of the Tokyo Olympics. Modern educational theories influenced a lot the main mission and all of the activities of the Budokan. And the research in the field of interconnections between modern and traditional martial arts systems plays an important role in most of the Universities and Faculties dealing with physical activity research, in all its integrative contexts.

Ritualized movements of *koryu budo* movement heritage

Technical repertoire of the modern martial arts like judo and aikido is extremely wide-ranging and interesting enough to be analyzed in a socio-anthropological way. Contemporary scholars of modern martial arts often forget that there is a vast field of motoric knowledge, technical, tactical and strategic skills, hidden somewhere beneath the surface of their techniques (*waza*). This knowledge asks for a deep sociocultural or socio-anthropological research. In a broader sense of the word we can say that this analysis is actually some kind of ethno-kinesiological research, trying to encompass the pre-structured, pre-ritualized and formalized movements in the background of many complex Japanese martial arts systems. Many disciplines today can offer different approaches to these problems. In this paper, the most suitable approach demonstrated was a socio-anthropological one. If we are supposed to interpret koryu budo as ‘old traditions’ or ‘old schools’ of martial arts, it is important to separate it from modern martial arts, for example, using the pragmatic socio-anthropological distinction employed by Donn F. Draeger: for the more modern arts of budo the ranking of priorities would be from morals to discipline and the aesthetic form; for the older ones, the hierarchy would be from combat efficiency towards discipline and morals (Draeger, 1973, 36). Nevertheless, it appears that this distinction is not sufficient. Traditional or koryu budo schools have the same, or almost the same, *waza list* or technical repertoire like their modern, contemporary successors. But it all depends how we perceive modern martial arts. Judo, karate, even kendo and sumo, although in a transitional phase, are often perceived as *sui generis* combat-competitive regimes. Usually they are denominated by their polistructural and acyclic composition, while their conventional and aesthetical surplus is often disregarded: one of the main technical aspect of karate, judo and kendo is actually technical competence in *kata* (form) performance. This part is, unfortunately, often neglected while defining the field of technical competence or movement structures of the above mentioned modern martial arts. This is why, in my opinion, comparing traditional martial arts or koryu budo systems with the modern ones (*gendai budo*) can result in discovering some neglected and yet undiscovered movement structures lying beneath the modern budo technical surface. This problem can be approached from many sides.

Here I decided for a socio-anthropological one, tracing these movement (or technical) structures in the ritualization process visible in koryu budo. These ritualized and formalized, pre-existent structures of movement can be defined in the following ways: (1) as movement structures that can be found in military and physical education practices of the koryu budo systems and were employed mainly on the battlefield as unconventional physical practices; (2) as movement structures that are deeply socially and culturally routed in the Japanese society, as norms, conventions and customs, in other words as rituals, and can be found in some other physical activities, such as traditional dance rituals, tea ceremony, kabuki performance and Noh-theatre practices; as movement structures that are conventional, standardized, deeply aesthetic and formative, including sets of prearranged sets of techniques or special skills to be acquired and transmitted by hereditary line (*iemoto*). There are dozens of ritualistic movements traceable in budo culture, but in this paper I will try to mention just a few of them and will name them in the following manner, using the koryu budo terminology: specific way of walking, called *namba aruki*; global ritual or pattern structure, usually called *kata*; corporal differences between inside and outside of the body or *uchi/ura* and *soto/omote* sides of one's body; the position of awareness usually called *kamaeru*; the seated positioning of the body for combat purposes, usually called *suwari*; incorporation of armed techniques in prearranged sequences of unarmed combat; the military correspondence between execution (*waza*), distancing (*ma, maai*) and tactics (*heiho*), etc. Here I would like to concentrate more on the namba aruki walking scheme and kata pattern of transmission, mainly because of their importance for comparison of koryu budo and modern martial arts. It goes without saying, of course, that these ritualistic concepts are visible in all modern martial arts, although they somehow lost their importance, relevance, even their ethnological and socio-anthropological meaning in nowadays competition-oriented system of combat. The information gathered to explain above mentioned structures are available in many ways, using many historiographical and ethnographical methods: in ancient texts about war strategy or combat tactics; in kinetographical materials available in many hereditary scrolls (*densho*) explaining the specificities of a certain school or a lineage; in kata or form patterns which tend to keep the system of techniques almost preserved. Koryu budo schools have kept the specific way of walking as their movement specificity. This is usually called namba aruki. Primarily it was a walking style used by the messengers during the Edo period of Japanese history (1603-1868), whose job was to quickly distribute messages between Edo and the other provinces. They would usually walk long distances, such as from Edo to Kyoto, approximately five hundred kilometers, in around six days. This style of walking employs hips in a different way from today's translatory hip employment, or western style walking, because namba aruki uses the principle of moving the same hand and the same foot forward in the same time. There are several, of course, ethnological reasons for this pattern of movement: it was supposed to decrease the swinging of the samurai sword, economizing the tiring as well. The leftovers from this biomechanics of walking can be seen today in many modern martial arts and it was obligatory to learn it in koryu budo systems. For example, in modern aikido most of the entering based principles in throwing techniques (*irimi nage*) are based on the procedures of namba aruki; sliding techniques (*tsuri ashi*) in kendo and karate have the same background; sliding and approaching movements of the attacker and disbalancing procedures of the defender in most of the judo kata employ the same principle. Today namba aruki is used in a different manner, as an alternative training method in other sports activities. There are a number of professional athletes in Japan who trained this method and, for example, set some records in different athletic disciplines. Shingo Suetsugu is the most famous example, because he set the Asian record on two hundred meters. One of the most famous Japanese martial arts scholars, Yoshinori Kono, still performs kinesiological researches on this method (Kono 1986, 1987). The formative fundament of all Japanese martial arts systems is called kata. Few facets of Japanese martial arts have been as consistently misunderstood as kata. It was variously described as a kind of ritual- like or ritualized combat, as an exercise in the aesthetic manner, as a moving meditation, etc. Some scholars suggest that the most suitable translation for the Japanese term kata, instead of ever-present *form*, should be *pattern practice*. Because kata is always perceived as a training method wherein students rehearse and simulate combinations of techniques and counter-techniques, or sequences of such combinations, in exactly the same manner and style as they were taught to (Friday, 1999). In a broader sense of the word, kata is a pattern structure of Japanese society and culture in general, used in calligraphy training, learning languages, theatre practices etc. There are at least several functions of kata preserved in modern budo: metacognitive function, because kata is always training of the bodily cognition; pedagogical functions, because this is the way how to transmit knowledge of a certain pattern in a certain martial arts school; and archival function, because only learning and relearning formative and ritualized patterns of kata preserves all of the structures of movements in the existing style, employing the kinesthetic experience as a dominant one. Contemporary or modern martial arts have preserved kata patterns in two ways. First one is the original Japanese way, and its source is in koryu budo, where kata actually means prearranged sparring between two partners, where one of them takes the initiative of the attacker and the other of the defender. This kind of pattern practices exist in kendo and judo, to name just a few of them. The other meaning of kata is of Chinese origin, as it is imposed in modern karate, where the emphasis is put on solo-performance. However we interpret it, kata is a compendium of techniques (*waza*), and it probably has its roots in neo-Confucian philosophy. Learning through pattern practice derives from the Confucian infatuation with ritual and ritualized movements, where ritual is stylized action and formalist duplication of the pre-learned bodily knowledge (Friday, 1999, 157). In modern budo, kata practice is usually opposed to some sort of free or semi-free sparring, usually called, in Japanese martial arts terminology, *kumite*, *randori* or *jigeiko*. In a way, free combat movements naturally stem from the kata practice because kata, consequently, allows freedom of movements in real combat. Even in Japanese, kata

in budo systems is written using the different ideogram then, for example, when it is used to designate pattern practice of tea ceremony, flower arrangement, theatre etc., because the budo ideogram represents the changeable and modifiable nature of budo kata.

Conclusion

Japanese martial arts were often analyzed in-between two extremes, purely biomechanical analysis of the combat system on one side, which is only one small part of the encompassing technical repertoire of the modern budo, and their utmost esoteric and mystical aspects on the other side (Mol 2001). First pattern of analyzing martial arts is somehow reasonable because they have slowly been transformed to competition-oriented physical activities. The second, mystical or esoteric pattern of analyzing the Japanese budo heritage is the most dangerous one because it subdues the complexity of the relationships between traditional budo and modern budo to Zen-philosophy, Buddhist mysticism and other religious and contemplative practices that became a part of budo curriculum very recently. The objective of this paper was very simple, to show that modern Japanese martial arts inherited a lot of elements from the ancient ways, as well as that most of the movement structures used in modern budo actually come from the koryu budo systems, either by direct lineage or indirect influences, as in the example of aikido or judo. Different modern martial arts decided to preserve this koryu heritage in a different way, either by making an implicit technical difference between kata and randori, as in judo, where kata systems function as a memory machine for keeping the koryu budo traditions alive. Or, like in aikido, where different aspect of koryu budo movements are kept in the technical domain, especially in entering techniques (irimi) or disbalancing techniques (kokyu) and seated techniques (suwari waza). In sumo, kyudo and kendo reference to old-school martial arts is preserved in the ceremonial context of the actual combat, explicit in opening sumo rituals, in the appearance of techniques, arenas where the practice and the competition takes place, etc. The role of the classical martial arts is formative, because it generates not only technical data, depository of movements, but also an external ritualized context.

References

1. Armstrong, H. B. (1997). *The Koryu Bujutsu Experience. Koryu Bujutsu: Classical Warrior Traditions of Japan*. New Jersey: Koryu Books.
2. Cox, R. A. (2003). *The Zen Arts: An Anthropological Study of the Culture of Aesthetic Form in Japan*. London-New York: Routledge Curzon.
3. Draeger, D. F. (1973). *Classical Budo: The Martial Arts and Ways of Japan. Vol. 2*. New York-Tokyo: Weatherhill.
4. Friday, K. F. (1999). *Kabala in Motion: Kata and Pattern Practice in the Traditional Bugei. Sword and Spirit: Classical Warrior Traditions of Japan. Vol. 2*. New Jersey: Koryu Books.
5. Kanno, K. (2009). *From Bushido to Budo. Budo: The Martial Ways of Japan*. Tokyo: Nippon Budokan.
6. Kono, Y. (1986). *Omote no taiiku, ura no taiiku*. [In and Out of Physical Education] Tokyo: Sojinsha.
7. Kono, Y. (1987). *Bujutsu wo kataru*. [On Martial Arts] Tokyo: Sojinsha.
8. Mol, S. (2001). *Classical Fighting Arts of Japan: A Complete Guide to Koryu Jujutsu*. Tokyo-New York-London: Kodansha International.
9. Murata, N. (2009). *The Modernization of Budo: The Teachings of Kano Jigoro. Budo: The Martial Ways of Japan*. Tokyo: Nippon Budokan.
10. Skoss, D. (1997). *Field Guide to the Classical Japanese Martial Arts. Koryu Bujutsu: Classical Warrior Traditions of Japan*. New Jersey: Koryu Books.
11. Skoss, M., Skoss, D. (1999). *Field Guide to the Classical Japanese Martial Arts. Sword and Spirit: Classical Warrior Traditions of Japan. Vol. 2*. New Jersey: Koryu Books.
12. Sugie, M. (2009). *Japanese Budo. Budo: The Martial Ways of Japan*. Tokyo: Nippon Budokan.

FLOW STATE OF DIFFERENT LEVELS IN AIKIDO PRACTITIONERS

Zdenko Reguli, Jitka Čihounková and Martin Sebera

Masaryk University, Faculty of Sport Studies, Brno, Czech Republic

Abstract

The purpose of this study was to assess the flow state of aikido practitioners. Seventy-six Czech male and female aikido practitioners (age 32.5 ± 9.2 years (mean \pm SD), range 18-56 years) participated in this study. The subjects were divided according to a ranking system into three groups: Beginners (up to third kyu), Intermediate (second and first kyu) and Advanced (dan holders). The Flow State Scale-2 was used to assess the experience of flow in aikido. Practical significance was found in flow state in different levels of aikido practitioners. Partial eta-squared coefficient was 0.04 in beginners, intermediate as well as intermediate and advanced aikido students. Significant differences were found in Unambiguous feedback and Sense of control dimensions of flow state. No differences were found between female and male aikido practitioners too.

Key words: emotions, challenge, experience, martial arts

Introduction

Aikido is a Japanese non-competitive martial art. It was developed in the middle of the 20th century by its founder Morihei Ueshiba as so called shinbudo, modern martial art. This shinbudo is known as a lifelong learning way of warriors. As there are no opponents, there is also no winner or loser. Aikido is practised in a co-operative manner. One (called uke) attacks with a pre-defined strike or a grasp, then the defender (called tori) uses momentum of an attack and leads the attacker to the ground. Thus the attacker receives defending technique without opposition. Such session is safe and allows aikido students to be fully open for experience to be involved to the movement. After the technique is executed they switch roles of uke and tori. The key is to learn and enjoy the practise. Aikido students search for harmony between an attacker and defender. The ultimate goal of aikido is to develop personality in the balance of bio-psycho-socio-spiritual dimensions.

Aikido group described in this study is from Czech aikikai group, taught mainly by shihan Franck Noel from France and Seishiro Endo from Japan. The style is dynamic, smooth and fluid, and rather sportive than traditional, enabling wide population to practise Aikido.

As there are no competitions there is only one way to measure performance in Aikido objectively, by examination. In ranking system, there are 6th to 1st kyu grades and 1st to 10th dan degrees. All aikido students wear white belt until they obtain black one for shodan, or 1st dan degree. Except that, more skilful aikidokas are allowed to wear traditional wide pants hakama. Second and first kyu grade holders are recognized as intermediate practitioners, all dan holders are recognised as advanced practitioners. It takes about three years of minimum practice to obtain second kyu and about five years to obtain black belt of first dan. Grading system allows to divide aikido students into groups according to their experience, knowledge and skills.

Except regular training sessions, there are occasional weekend seminars. Usually an internationally respected teacher is leading the practise. Aikido students can learn new movements and movement principles. Next to this reason there is another one for attending seminars. It is possible experience to practise with many different students from various clubs enabling to solve new challenges. It is expected that only students with true interest in aikido attend seminars as it cost additional time and money.

Japanese martial arts works with an idea of ichi-go ichi-e (“one meeting, one time”) which comes from tea ceremony. It means to perform here and now, to be involved in the movement from beginning to the very end. In this way we were interested in manifestation of flow state in aikido students. Despite some critics (Løvoll & Vittersø, 2014), flow state is often described as the state, when high skills meet high challenge and experience (Moneta, 2012).

Methods

As a basic approach, we chose the componential view of flow to measure flow as a state. Jackson and Eklund (2002) developed, refined, and validated standardized questionnaire Flow State Scale-2 (FSS-2), which measures intensity of flow as a state. The state questionnaire asks participants to answer the questions thinking of the specific activity, here aikido practising, they just completed. FSS-2 questionnaire has good psychometric properties (Jackson and Eklund 2002).

FSS-2 was adapted for Czech language by Řezáč (2007) and then revised and modified for using in martial arts by authors of this study. FSS-2 measures intensity of flow as either a general trait or as a domain-specific trait. Nine domains (36 items) in FSS-2 can be analysed separately, but they all testify flow as a specific activity oriented state. Reliability coefficient for an overall mean alpha for original FSS-2 was 0.87. Although Cronbach's alfa of Czech version is lower (0.86), the reliability is satisfactory.

The data were taken as follows: the subjects were asked to answer each question using a 5 point Likert Scale ranging from strongly disagree (1) to strongly agree (5) just after a practice on a weekend seminar taught by a master teacher. Then, all data were rewritten to Microsoft Excel sheet and statistically analysed in Statistica 12 software.

Seventy-six Czech male (n=62) and female (n=14) aikido practitioners, aged 32.5±9.2 years (mean±SD), range 18-56 years, volunteered to participate in this study. As it is seen in the Table 1, practitioners were intentionally classified into three subgroups according to the divisions to which they belonged: Beginners (up to third kyu), Intermediate (second and first kyu), and Advanced (dan holders).

Table 1: Description of subgroups

Parameters	Descriptive statistic			
	Sample group	N	Mean (SD)	Range
Age (years)	Advanced	24	36.3 (7.9)	24-51
	Intermediate	28	30.7 (8.2)	21-52
	Beginners	24	30.9 (10.5)	18-56
Age (years)	Male	62	33.6 (9.4)	18-56
	Female	14	27.6 (7.1)	18-45

Results

ANOVA was used for evaluating differences between male and female practitioners and between the three levels of aikido practitioners (Table 2). There were no significant differences between male and female practitioners in the overall flow score at $p < 0.05$. The mean overall flow state was 3.50 in male and 3.49 in female aikido students, while the standard deviation was 1.04 and 1.03. On the other hand, we can see less consistency in the level of flow state in female aikido students, which can be given by low number of females.

Table 2: Analysis of Variance in beginners (B), intermediate (I) and advanced (A)

	SS Effect	df Effect	MS Effect	F	p	Partial eta-squared
Male/female flow	0.00	1	0.00	0.01	0.91	0.00
B//A flow	0.35	2	0.18	1.57	0.21	0.04

There even was not a significant difference in flow state in Beginners, Intermediate and Advanced practitioners at the level of $p < 0.05$ (Table 2). The mean overall flow state was 3.41 (SD=1.05) in beginners, 3.50 (SD=1.05) in intermediate and 3.58 (SD=1.04) in advanced groups. Scheffe's post hoc test (Table 3) was used to analyse possible differences between groups. Differences were not found among three levels of aikido students. Because of that, effect size was determined for calculating of practical significance. Partial eta-squared coefficient was 0.04 in beginners, intermediate and advanced students. Effect size was found rather small then medium according the Cohen's conventions. So, as aikido students are more experienced and skilled, also experience of flow is deeper but only at small level of significance.

Table 3: Scheffe's post hoc test

Level	{1} M=3.41	{2} M=3.50	{3} M=3.58
Beginners {1}		0.63	0.21
Intermediate {2}	0.63		0.69
Advanced {3}	0.21	0.69	

Except of two from nine dimensions, there were not differences in aikido groups divided by level. In detail, this difference was caused between beginners and advanced practitioners by Sense of control and Unambiguous feedback dimensions. Partial eta-squared coefficient for Sense of Control (0.15) and Unambiguous feedback (0.12) was calculated between small and medium effect size (Table 4).

Analysis of variance and Scheffe's post hoc test showed a significant difference (at $p < 0.05$) only in these two dimensions as it is shown in tables 4 -6. Significant difference was found in Sense of control between Beginners and Advanced as well between Intermediate and Advanced. In Unambiguous feedback, only significant difference between Beginners and Advanced was found.

Table 4: Analysis of Variance in Sense of control and Unambiguous feedback

	SS Effect	df Effect	MS Effect	F	p	Partial eta-squared
Sense of control	60.65	2	30.32	6.43	0.00	0.15
Unambiguous feedback	59.10	2	29.55	4.80	0.01	0.12

Table 5: Scheffe's post hoc test – Sense of control

Level	{1} M=3,21	{2} M=3,37	{3} M=3,76
Beginners {1}		0.62	0.00
Intermediate {2}	0.62		0.04
Advanced {3}	0.00	0.04	

Table 6: Scheffe's post hoc test – Unambiguous feedback

Level	{1} M=3.13	{2} M=3.45	{3} M=3.68
Beginners {1}		0.18	0.01
Intermediate {2}	0.18		0.41
Advanced {3}	0.01	0.41	

Discussion and conclusions

The present study demonstrated that there is no significant difference in flow state between male and female aikido practitioners. The highest level (dan holders) of aikido student significantly experienced higher overall flow state, then beginners and intermediate students. This results were shown by practical but not statistical significance. Statistical significance depends on number of cases too, so we could expect different results with higher number of aikido students in groups. It also shows that in aikido, as in non-competitive martial art, one could choose challenge according his/her skills. Flow can be found when high challenge meets high skills as well as when low challenge meets low skills. This results were shown by practical but not statistical significance. Statistical significance depends on number of cases too, so we could expect different results with higher number of aikido students in groups. It also shows that in aikido, as in non-competitive martial art, one could choose challenge according his/her skills. Flow can be found when high challenge meets high skills as well as when low challenge meets low skills. Difference between the levels is mainly in Sense of control and Unambiguous feedback dimensions. A sense of control in flow frees an individual from the fear of failure (Jackson & Csikszentmihalyi, 1999) and results in the individual feeling of power, confidence and calm (Jackson 1995). These attributes are widely trained in martial arts. Clear feedback is given by a training partner, a teacher as well as a practitioner themselves. Such feedback will help the individual to stay in tune and in control of what they are doing (Jackson & Csikszentmihalyi 1999). As there are no data to compare results in different martial arts, it is expected to find out deeper knowledge about flow state in martial arts in the future.

References

1. Løvoll, H.S. & Vittersø, J. (2014). Can Balance be Boring? A Critique of the “Challenges Should Match Skills” Hypotheses in Flow Theory. *Social indicators research*, vol. 115(issue 1), pp. 117-136.
2. Moneta, G.B. (2012). On the Measurement and Conceptualization of Flow. In Engeser, S. *Advances in flow research*. (pp. 23-50). New York: Springer.
3. Jackson, S.A. & Eklund, R.C. (2002). Assessing flow in physical activity: The flow state scale-2 and dispositional flow scale-2. *Journal of sport & exercise psychology*, vol. 24(issue 2), pp. 133-150.
4. Řezáč, P. (2007). *Flow Experience Aspects in Sports*. [Master thesis]. Brno: Masaryk University
5. Jackson, S. & Csikszentmihalyi, M. (1999). *Flow In Sports: The keys to optimal experiences and performances*. Champaign, IL: Human Kinetics Books.
6. Jackson, S.A. (1995). Factors influencing the occurrence of flow in elite athletes. *Journal of Applied Sport Psychology*, 7, 138-166.

TOTAL PHYSICAL RESPONSE AND SECOND LANGUAGE ACQUISITION

Dejan S. Savičević¹, Maja S. Cvijetić¹ and Zdravko B. Ivanković²

¹Preschool Teacher Training and Business Informatics College “Sirmium“, Sremska Mitrovica, Serbia

²Technical faculty “Mihajlo Pupin“, Zrenjanin, Serbia

Abstract

The purpose of the study was to investigate positive effects of Total Physical Response method in English language teaching while working with children with reading difficulties and attention deficit hyperactivity disorder (ADHD). The survey was conducted on a sample of fifteen children during eight months. The control group (n = 7) attended English classes based on the traditional approach (Grammar-Translation Method), whereas the students of the experimental group (n = 8) followed the instructions according to the principle of TPR (Total Physical Response). KET test has been applied to assess the students' level of knowledge. T test and Z scores determined statistically significant differences between groups in grammar (t = -1.73, p = 0.03) and vocabulary test (t = 4.56, p = 0.02). The research confirms positive effects of Total Physical Response method when working with children with special needs..

Key words: total physical response, children with special needs, language teaching, motor activity

Introduction

Total Physical Response (TPR) was introduced by James Asher and has a noteworthy influence on second language teaching. James Asher based his theory on developmental psychology, or “trace theory” of memory, which is based on a notion that repetition helps memory associations to become stronger and more easily recalled (Asher, 2000). This can be gained by the combination of both verbal and motor activities, combination of coordination, speech and action. These are the basic ideas supporting teaching language via movement (Richards, and Rodgers, 1997). The authors of this paper believe that second language learning and teaching should follow the natural processes of language learning (Larsen-Freeman, 2000). Lowering the affective filter thanks to kinesthetic sensory activities helps the input to become comprehensible and acquired. The authors of this paper consider language-movement pairings to be beneficial for learners with special needs. (Crary, 1993; Caruso, 1999,) Therefore, the authors of this paper see a strong connection between language and body, for child first responses are not spoken but motional. Kinesthetic learning is therefore strongly recommended.

Methods

The survey was conducted from October 2012 to May 2013, in a private language school in Sremska Mitrovica “Britannica”. It included two groups of pupils aged 7 ± 0.49 years. The experimental group included eight children with special needs - two children with ADHD and three children with dyslexia. Control group included seven children with special needs, three children with ADHD and two children with dyslexia. The first group attended English classes for 40 minutes, three times a week, and the teaching method was based on TPR, whereas the control group attended English classes for 40 minutes, three times a week, but the teaching was based on the traditional approach (Grammar-Translation Method). Children from both groups were subjected to initial testing, where their knowledge of vocabulary, grammar and reading comprehension were tested. After completion of the eight months course children were subjected to final testing. KET test has been applied to assess the students' level of knowledge as well as to assess their achievement after completing the course.

Results

Table 1 shows the results for the analyzed variables and groups in the initial and final measurement. The number of entities (N), arithmetic mean (Mean), standard deviation for each group (Std. Deviation) and standard error of the arithmetic mean for each group (Std. Error Mean) are presented.

Table 1: Basic descriptive statistical parameters

	Group	N	Mean	Std. Deviation	St.Error Mean
Grammar I	experimental	8	6,50	1,41	,500
	control	7	7,42	1,39	,528
Vocabulary I	experimental	8	8,37	1,06	,375
	control	7	9,00	1,41	,534
Text Comprehension	experimental	8	11,87	1,24	,440
	control	7	13,57	1,27	,480
Grammar F	experimental	8	9,10	1,06	,377
	control	7	11,42	1,27	,480
Vocabulary F	experimental	8	16,87	1,88	,666
	control	7	13,28	2,13	,808
Text Comprehension F	experimental	8	18,10	1,19	,422
	control	7	18,14	,899	,340

Table 2: Achievement index in Z scores in initial measurement

Examinee	Group	Gramm. Score.	Z value.	Vocab. Score.	Z value.	R. Score.	Z value.	Σ Z Score
D.P. ADHD	EXPERIMENTAL	6	-0,035	8	-0,34	14	1,71	0,54
S.C. ADHD		5	-1,06	7	-1,29	11	-0,70	-3,05
M.N. ADHD		5	-1,06	9	0,59	12	0,10	-0,70
D.D. ADHD		5	-1,06	7	-1,29	10	-1,48	-3,83
S.T. dyslexia		8	1,06	10	1,53	12	0,10	2,69
S.E. dyslexia		8	1,06	8	-0,34	11	-0,70	0,02
M.S. dyslexia		8	1,06	9	0,59	12	0,10	1,75
E.P. dyslexia		7	0,35	9	0,59	12	0,10	1,09
A.V. ADHD	CONTROL	6	-1,04	7	-1,38	13	-0,52	-2,94
M.J. ADHD		6	-1,04	8	-0,70	12	-1,23	-2,97
R.S. ADHD		6	-1,04	8	-0,70	15	1,12	-0,62
J.J. dyslexia		9	1,13	11	1,41	15	1,12	3,66
M.K. dyslexia		8	0,44	9	0,15	14	0,35	0,94
A.I. dyslexia		9	1,13	10	0,92	14	0,35	2,46
M.P. dyslexia		8	0,44	10	0,92	15	1,22	2,58

Individual results were compared by Z-score, i.e. achievement index of each child was compared regarding the results of tests in the initial (Table 2) and final measurement (Table 3). Generally, children with ADHD in both groups had lower overall Z score compared with children with speech disorder.

Table 3: Achievement index in scores and Z scores in final measurement

Examinee	Group	Gramm. Score.	Z value.	Vocab. Score.	Z value.	R. Score.	Z value.	ΣZ Score
D.P. ADHD	EXPERIMENTAL	9	-0.09	17	0.069	20	1,69	1,66
S.C ADHD		9	-0.09	17	0.069	19	0,81	0,78
M.N. ADHD		8	-1,03	18	0,60	18	-0,08	-0,51
D.D. ADDH		8	-1.03	16	-0.46	17	-0,92	-2,41
S.T. dyslexia		10	0,94	18	0,60	17	-0,92	0,62
S.E. dyslexia		10	0,94	14	-1.52	17	-0,92	-1,50
M.S. dyslexia		9	0.09	15	-0,99	19	0,75	-0,15
E.P. dyslexia		10	0,94	20	1,66	17	-0,92	1,68
A.V. ADHD	CONTROL	11	-0,33	10	-1,53	18	-0,15	-2,01
M.J. ADHD		11	-0,33	11	-0,77	17	-1,14	-2,24
R.S. ADHD		9	-1.90	16	1,27	20	1,77	1,14
J.J. dyslexia		12	0,45	14	0,33	18	-0,15	0,63
M.K. dyslexia		12	0,45	13	-154	18	-0,15	0,95
A.L. dyslexia		13	1,24	14	0,33	18	-0,15	1,42
M.P. dyslexia		12	0,45	15	0,80	18	-0,15	1,10

According to these results, it can be concluded that children in both groups made progress after eight months of treatment. General comparison of the overall success of the two treatments using the Z-score leads to the conclusion that the experimental treatment contributed more to children with ADHD than to children with dyslexia, and in both treatments children with ADHD were individually more successful than children with dyslexia.

Table 4: Overall achievement index

Examinee	Group	ΣZ Score initial	ΣZ Score final	Σ achievement
D.P. ADHD	EXPERIMENTAL	0,54	1,66	+ 1,12
S.C ADHD		-3.05	0,78	+ 3.83
M.N. ADHD		-0,70	-0,51	+ 0.19
D.D. ADDH		-3.83	-2.41	+ 1.42
S.T. dyslexia		2.69	0.62	- 2.07
S.E. dyslexia		0.02	-1.50	- 1.48
M.S. dyslexia		1.75	-0.15	- 1,60
E.P. dyslexia		1.09	1,68	+ 0,59

A.V. ADHD	CONTROL	-2.94	- 2,01	+ 0.93
M.J. ADHD		- 2.97	-2,24	+ 0.73
R.S. ADHD		-0,62	1,14	1,76
J.J. dyslexia		3,66	0,63	- 3.03
M.K. dyslexia		0,94	0,95	+ 0,01
A.L. dyslexia		2,46	1,42	- 1.04
M.P. dyslexia		2,58	1,10	-1 .48

T-test was applied to determine the significance of difference in achievement between the two groups, i.e., in the effects of the two programs. We compared the results of children in the experimental group and control group in the initial and final measurement. There was no statistical difference between the groups in the initial measurement. However, significant difference between the results of the groups in the results of the test grammar and vocabulary tests was observed in the final measurement.

Table 5: Significance of mean differences of results of experimental and control groups in the initial and final measurement

	Mean	df	F	t	Sig. (2-tailed)
Grammar I	- 0,9	13	0.012	-1,27	0,224
Vocabulary I	-0,6	13	0,756	-0,97	0,347
Text Comprehension	-1,69	13	0,190	-2,60	0,220
Grammar F	-2,42	13	0,245	-4,02	0,01
Vocabulary F	3,56	13	0,205	3,45	0,04
Text Comprehension F	-0,14	13	2,08	-0,25	0,80

The results are calculated and presented separately for each variable. (Table 5). Interpretation of the results is based on the significance of t-test. Since statistical significance is under 0.05, statistically significant improvement can be noticed only in two tests in the final measurement (grammar F, sig. = 0.01 and Vocabulary F, sig. = 0.04). Positive value of t-test shows the difference in favor of experimental group in the vocabulary test, while the negative sign of t-test indicates that there is a difference in favor of control group in grammar test.

Discussion and Conclusions

The results proved positive effects of TPR method while working with children with special needs. Body movements proved to be helpful with memorizing vocabulary items, their meaning and pronunciation. It proved that acquisition does not represent simple memorization, which is credited to be a left brain activity. (Asher, 2000). TPR focuses on the learning processes of right-brain, as oppose to the majority of second language teaching favouring left-brain learning. According to Jean Piaget's studies children acquire language through motor movements, being the dominant activity of the right hemisphere (Saville-Troike, 2006). Language production, represented by the left hemisphere, is to follow naturally after sufficient right hemisphere learning accomplishment (Richards, and Rodgers, 1997). Motor activities drew and held the students attention, especially children with ADHD managed to stay focused for a longer period of time. (Williams, 2001). TPR suggests, that thanks to its methods, the affective filter is lowered, because the structure becomes explicit via gestures and movement (Arnold, 1999). The research generally proved movement activities to be effective attention catchers.

However, certain rules require longer period of time to be acquired, especially grammar rules. Nevertheless, the involvement of body movement in the lesson improved students' attentiveness, interest and involvement in the lesson and showed that the slower pace does not necessary result in lower performance.

References

1. Arnold, J. Ed. (1999). *Affect in Language Learning*, Cambridge University Press.
2. Asher, J. (2000). *Learning Another Language through Action*, Sky Oaks Productions.
3. Caruso, Anthony and Edythe Strand (1999). *Clinical Management of Motor Speech Disorders in Children*, New York: Thieme.
4. Crary, M.A. (1993). *Developmental Motor Speech Disorders*. San Diego, CA: Singular.
5. Larsen-Freeman, D. (2000). *Techniques and Principles in Language Teaching*, Oxford University Press.
6. Lockhard, Walter F., and Cristina Perez Arraiza. (1988): “Krashen’s Model: The Theoretical Basis of the Natural Approach.” *Practical English Teaching*. 50-52.
7. Richards, Jack C., and Theodore S. Rodgers. “Total Physical Approach.” *Approaches and Methods in Language Teaching. Approaches and Methods in Language Teaching*. Oxford: Oxford University Press, 1997. 87-98.
8. Saville-Troike, M. (2006). *Introducing Second Language Acquisition*. Cambridge: Cambridge University Press.
9. Schmidt, R.A. (1988). *Motor Control and Learning: A Behavioral Emphasis* (2nd ed.). Champaign, IL: Human Kinetics.
10. Williams, Marion and Robert L. Burden (2001). *Psychology for Language Teachers*. Cambridge: Cambridge University Press.
11. Werstler, Jessica M. (2002). “Total Physical Response Storytelling: a Study in Actively Engaging Students Across the Modalities.” MA thesis. Central Connecticut State University Digital Archive. Central Connecticut State University.

DIFFERENCES IN EMOTIONAL COMPETENCE BETWEEN INDIVIDUAL AND TEAM SPORTS ATHLETES

Tanja Stibilj Batinić¹, Vjeran Švaić² and Janko Babić³

¹Health School Zagreb, Zagreb, Croatia

²SkiBoo sportska akademija, Zagreb, Croatia

³University of Applied Health Studies, Zagreb, Croatia

Abstract

The aim of this study was to establish differences in emotional competence level between individual and team sports athletes. The data was collected from 467 active athletes, aged 18 – 64 years (M=26,5). Emotional competence was measured using UEK-45 questionnaire, which consists of three emotional competence subscales: ability to perceive and understand emotions; ability to express and name emotions; and ability to govern emotions. T-test was used to establish differences between the two groups. Results showed that there are no significant differences between individual and team sports athletes in emotional competence level either in total or in each subscale independently ($p>0,05$). It is considered that sport and physical exercise increase the ability of athletes to govern emotions regardless of the type of the activity.

Key words: emotional intelligence, physical exercise, ability to govern emotions

Introduction

Emotional intelligence can be defined as the ability to perceive accurately, appraise, and express emotion; the ability to access and/or generate feelings when they facilitate thought; the ability to understand emotions and emotional knowledge; and the ability to regulate emotions to promote emotional and intellectual growth (Salovey and Mayer, 1990). Idea to develop new concept came as a result of researches which showed that for managing in everyday situations one need different skills then those measured by traditional intelligence tests. Individuals who scored high on intelligence tests were often unsuccessful in their career and personal life, unlike those who were good in recognizing, expressing, understanding and regulating emotions (Salovey and Mayer, 1990).

Emotional competence is a similar concept that can be defined as combination of skills and abilities that individual puts to use to express, regulate and understand emotions (Takšić et al., 2006). Its importance is widely recognized so educational programs with purpose of enhancing emotional competence are being created (Takšić et al., 2006).

Emotional intelligence has significant role in sport, especially regarding emotion regulation (Goleman, 1998). Non efficient regulation of emotion impulses can lead to weaker sport performance. On the other side, detecting and understanding emotions can enhance athlete performance, but can also help coaches to better understand their players (Goleman, 1998). It has been found that there are emotional intelligence level differences between in favor of athletes compared to non-athletes (Ardahan, 2012; Bostani and Saiari, 2011; Sohrabi et al., 2011). Takšić et al. (2005) found that adolescents in Sport Gymnasium have better emotional competence than those in Regular Gymnasium, but the only significant difference is found in ability to express and name emotions. Students from Sport Gymnasium are better in expressing and labeling emotion compared with their peers in Regular Gymnasium.

Presence of emotions is inevitable during participation in sports competitions, and there are numerous examples of athletes losing control over their emotions which has negative effect on their performance. Crombie, Lombard and Noakes (2009) found that team emotional intelligence of six cricket teams, measured by MSCEIT ability test, was positively correlated with sports performance of teams in question. This could suggest that emotional intelligence may contribute to the success of teams participating in complex sports.

Therefore, importance in recognizing all factors that may contribute to higher emotional competence in sport is understandable. One of the factors that could be related to athlete's ability to control, express or recognize others emotions is whether he or she is participating in individual or team sports. Ilyasi et al. (2011) found that there is no significant difference in emotional intelligence level between team and individuals athletes. In this research we tried to examine this relationship further, mainly because prior researches were conducted only on male student athletes, by using a reliable tool for measuring emotional competence level Emotional Skills and Competence *Questionnaire* (UEK-45).

Methods

The data was collected from 467 active, both male and female, athletes ($N=467$) from different sports (Table 1). Out of the total sample number 146 athletes competed in individual and 321 athletes competed in team sports. All subjects were aged 18-64 years ($M=26,5$). The athletes filled out emotional competence questionnaire UEK-45 (Takšić et al., 2006), which consists of three emotional competence subscales: 1. ability to perceive and understand emotions, 2. ability to express and name emotions, 3. ability to govern emotions. All subscales use a five point Likert scale and have proved to be highly reliable (α_{cr} 0,87-0,92).

Table 1: List of individual and team sports athletes used in the study

INDIVIDUAL SPORTS ATHLETES	TEAM SPORTS ATHLETES
Athletics	Football
Fencing	Baseball
Judo	Basketball
Karate	Handball
Kayak-canoe	Hockey
Rowing	Ice hockey
Shooting	Rugby
Skiing	Softball
Swimming	Synchronized swimming
Table tennis	Volleyball
Tennis	
Wrestling	
n=146 (number of athletes)	n=321 (number of athletes)

Results

The results of UEK-45 questionnaire were tested using Kolmogorov-Smirnov test of normality which showed a normal distribution ($p>0,05$) and made it possible to proceed with the quantitative analysis.

Four separate t-tests for independent variables were used to determine differences in emotional competence between individual and team sports athletes, one for every subscale of the questionnaire and one for totals (Table 2). The level of significance was set to $p<0,05$. No significant differences were found between individual and team sports athletes when comparing total emotional competence levels of the used questionnaire ($t=1,12$; $p=0,26$).

Table 2: Results of t-tests for independent variables

Emotional competence subscale	Sport	n	M	SD	df	t	p
Ability to perceive and understand emotions	Team	321	56,85	5,85	465	0,85	0,39
	Individual	146	57,3	5,4			
Ability to express and name emotions	Team	321	49,7	5,88	465	0,11	0,91
	Individual	146	49,7	7,56			
Ability to govern emotions	Team	321	58,56	7,04	465	1,77	0,07
	Individual	146	59,84	7,52			
Emotional competence UEK-45 total	Team	321	165,15	14,85	465	1,12	0,26
	Individual	146	166,95	16,65			

* N – number of participants, M – mean, SD – standard deviation, df – degrees of freedom, t – test value, p - value

Although emotional competence level was similar among athletes that competed alone and athletes that competed in teams, we decided to analyze each emotional competence subscale independently with a purpose to determine whether individual and team sports athletes possess specific emotional abilities. Again no significant differences were found between two different types of competing athletes in any of the subscales. Individual sports athletes scored a little higher emotional competence values in ability to govern emotions ($t=1,77$; $p=0,07$) and ability to perceive and understand emotions ($t=0,85$; $p=0,39$), non being statistically significant. Levels of the ability to express and name emotions were equal among the subjects ($t=0,11$; $p=0,91$).

Discussion and conclusions

The results of this study indicate that there is no significance difference in emotional competence among team and individual athletes on either UEK-45 subscale, or on total UEK-45 competence level. These results are similar to those found by some other authors (Ilyasi et al., 2011) which showed no relationship between sport orientation and emotional intelligence. The connection between athletic performance and success and emotional intelligence is well known, the results of conducted studies concerning identification of medalist athletes' properties imply that from among effective factors impacting the performance of athletes, the ability to recognize, express and manage the feelings logically in stressful situations is highly important (Soflu et al., 2011). If athlete manages to develop emotional competencies to understand and govern emotions he will be able not only to value them in himself and others, but also will be able to use them to achieve the best result possible, and meet the psychological demands of certain sport (Garcia-Coll et al., 2010) However, emotional competencies used and needed to succeed in individual sports and those used and needed to succeed in team sports are not always the same, so relationship between each UEK-45 subscale and team/individual sport performance/success should be explored more to establish emotional competencies that are more important in specific sport type.

Results of Soflu et al. (2011) research showed that there are some differences in emotional intelligence between individual and team sports athletes, mainly in emotional intelligence micro scales. The significant difference was found in following micro scales: self-management, self-motivation and social skills, but no significant difference was observed in self-awareness and empathy micro scales. Calmels (2002; in Soflu et al, 2011) in a similar research stated that the nature of sport (individual or team based) and the gender of athletes are of effective factors impacting the performance of them. He stated that individual athletes compared to team ones experience higher levels of self-talk and negative thinking but team athletes possessing better communicative skills have more ability in motivating their teammates.

It is clear that emotional intelligence and competencies that derive from it are often in correlation with other psychological constructs and to explain their importance on sport performance we must be aware of those correlations. The results of Pigozzi's study (2008, in Soflu et al., 2011) indicated that professional athletes have good motivation and self confidence through controlling competitive anxiety by mental skills (such as imaging, emotion control) but amateur athletes are faced with a significant decrease in their performance due to high anxiety during competitions. Hanton (2000, in Soflu et al., 2011) believes that Olympic athletes use mental skills particularly imaging and self confidence for displaying an excellent performance, but amateur athletes, with the aim of reducing competitive anxiety in stressful conditions, apply mental skill techniques. Lane et al. (2006) in their study on investigating the relationship between emotional intelligence and behavioral features with performance of student athletes, believe that having balanced behavioral features such as controlling negative emotions and motivations in a proper level are the characteristics of superior athletes and states that emotional intelligence has a positive relationship with optimum performance and self efficacy of superior athletes that separates the performance of these athletes from others in sensitive and important events.

It is considered that sport and physical exercise increase the ability of athletes to govern emotions regardless of the type of the activity. Ability of an athlete to regulate emotions while competing is valuable asset. High emotional intelligence as ability to assess and regulate oneself emotions, understand it among others, and emotional competence used to resolve incoming issues due to training or competition, excel sportsman craftsmanship to a mastery performance. Further research of relationship between level of sport success and emotional competence regarding sport orientation (individual vs. team sports) is needed so more emphasis on developing specific emotional competencies can be put into tracing excellence in sport.

References

1. Ardahan, F. (2012). Life satisfaction and emotional intelligence of participants/nonparticipants in outdoor sports: Turkey case. *Social and Behavioral Sciences*, 62, 4-11.
2. Bostani, M., Saiiari, A. (2011). Comparison Emotional Intelligence and Mental Health between Athletic and Non-Athletic Students. *Social and Behavioral Sciences*, 30, 2259-2263.
3. Crombie, D., Lombard, C., Noakes, T. (2009). Emotional intelligence scores predict team sports performance in a national cricket competition. *International Journal of Sport Science and Coaching*, 4 (2), 209-224.
4. Garcia-Coll, V., Ruiz-Pérez, L M., Palomo-Nieto, Martin-Esteban, A. (2010). Inteligencia emocional, pericia y deportes colectivos. Congress: III International Congress of Sport Science and Physical Education, Pontevedra.
5. Goleman D. (2000). Emocionalna inteligencija u poslu [Emotional intelligens in work]. Mozaik knjiga.
6. Ilyasi, G., Sedagati, P., Salehian, M. H. (2011). Relationship Between Sport Orientation and Emotional Intelligence among Team and Individual Athletes. *Annals of Biological Research*, 2 (4), 476-481.
7. Lane, A. M., Thelwell, R., Devonport, T. J., (2009). Emotional Intelligence and Mood States associated with Optimal Performance. *Electronic Journal of Applied Psychology: General Articles*, 5(1), 67-73.
8. Salovey, P., Mayer, J.D. (1990). Emotional Intelligence. *Imagination, Cognition & Personality*, 9, 185-211.

9. Soflu, G. H., Esfahani, N., Assadi, H. (2011). The Comparison of emotional intelligence and psychological skills and their relationship with experience among individual and Team athletes in superior league. *Social and Behavioral Sciences*, 30, 2394-2400.
10. Sohrabi, R., Abasi Garajeh, P., Mohammadi, A. (2011). Comparative Study of Emotional Intelligence of Athlete and non-Athlete Female Students of Tabriz Islamic Azad University. *Social and Behavioral Sciences*, 30, 1846-1848.
11. Takšić, V., Mohorić, T., Munjas, R. (2006). Emocionalna inteligencija: teorija, operacionalizacija, primjena i povezanost s pozitivnom psihologijom [Emotional Intelligence: Theory, Operationalization, Implementation and Relationship with Positive Psychology]. *Društvena istraživanja*, 15 (4-5), 729-752.
12. Takšić, V., Rukavina, T., Linardić, M. (2005). Emotional intelligence in high school students in regular and sport grammar school . *4th International Scientific Conference on Kinesiology - Science and profession - Challenge for the future* / Milanović, D.; Prot, F. (ur.). Zagreb : Faculty of kinesiology, University of Zagreb, 2005. 679-682.

THE FEATURES OF SELF-ESTEEM AND AGGRESSION IN ADOLESCENT ATHLETES AND NON-ATHLETES

Ilona Tilindiene and Tomas Stupuris

Lithuanian Sports University, Kaunas, Lithuania

Abstract

The aim of this study is to compare the characteristic features of self-esteem and aggression in adolescent athletes and non-athletes aged 14–16. The study was conducted in the city of Kaunas, Lithuania in 2013 and included 292 respondents (116 female and 176 male). The study employed the modified Shostrom's *Personal Orientation Inventory* (26 statements) and the Buss-Perry's *Aggression Questionnaire* (29 items) (Buss, Perry, 1992).

The study showed that physical, verbal and overall aggression in adolescent athletes was relatively higher than in adolescent non-athletes. Adolescent athletes showed higher self-esteem scores compared to non-athlete respondents. Anger, physical and overall aggression were more characteristic in boys than girls. The study also revealed that boys possessed higher self-esteem than girls.

Key words: *student, sport, negative behaviour, personality characteristics*

Introduction

The age period of adolescence is characterized by challenges such as conflicts in school and in the family, the disparity in maturity, dissatisfaction with their bodies, as well as the escalation of conflicts between adolescents and adults' shared values, the growing sense of identity, the changing status in the society, and this makes the adolescent to know not only the world around them, but themselves as well (Peleg–Oren et al., 2012). An important role in the modern world is played by the influence of the media on the negative adolescents' behaviour (Santisteban, Alvarado, Recio, 2007). Therefore, aggressive conflicting behaviour at this age period seems quite commonplace. It encourages researchers around the world to analyse the problems of youth's aggressive behaviour and bullying: in the United States (Graham, 2010), Spain (Cerezo, 2009), Romania (Beldean-Galea et al., 2010), Germany (Scheithauer et al., 2006), South Africa (Penning et al., 2010), Canada (Marini et al., 2006), Israel (Laufer et al., 2006), Bosnia and Herzegovina (Dracic, 2009), Japan (Hilton et al., 2010), etc. Research data show that aggression at school is very important for the personal psychosocial health of young people (Fleming, Jacobsen, 2009). According to the data of World Health Organization (WHO, 2008), among the 40 countries surveyed Lithuania is leading in the prevalence of aggressive behaviour and bullying among schoolchildren.

Sports scientists constantly debate about the impact of sports on personal social skills, self-development, which determine the individual's behaviour in the environment. Many Lithuanian and foreign sports scientists (Caroll, Connaughton, 2009; Dunn, Dunn, Bayduza, 2008; Mahoney, 2000; Šukys, Jankauskienė, 2008; Ullrich-French et al., 2012) recognize that involvement in sports activities positively affects adolescents' self-esteem, contributes to the development of adolescent identity and positive self-respect, promotes cooperation with peers, develops value system, distracts from harmful habits, helps to integrate into the society, preconditions lower occurrence of adolescents' anti-social behaviour. However, other studies (Mahoney, Stattin, 2000; O'Neil et al., 2013) show that physically active adolescents can become victims of bullying because of the limitation of their social relationships with peers or they initiate that themselves in order to restore their social status. Still others recognize that sport is just a pastime, a game which does not have any crucial effect on adolescent's behaviour (Cruz et al., 1995 - cit. Laskienė et al., 2010).

So, in such a controversial scientific discussion, the objective results should be based on the further research. Research literature also lacks studies that would examine inter-dependence of sport, self-esteem and aggression, for example, what influence sport can have on self-esteem, aggression, bullying prevention, etc.

Research aim – to compare the characteristic features of self-esteem and aggression in adolescent athletes and non-athletes aged 14–16.

Methods

Research methods. The subjects were given the modified Shostrom's *Personal Orientation Inventory* (26 statements, evaluating the self-esteem levels - high, normal (adequate), and low) (Lester, Lloyd, 1997). Statistical analysis was performed only for 60 participants who were involved in both test and retest investigation procedures. Data treating as

normal we determined good internal consistency for test (Cronbach $\alpha=0,79$), and retest data (Cronbach $\alpha=0,83$). It was determined strong correlations between test and retest outcomes as well ($r=0,81, p<0,001$).

Buss–Perry’s *Aggression Questionnaire* (Buss, Perry, 1992) (29 items). The latter method allows evaluating the different forms of manifestation of aggression (physical aggression (scores range from 9 to 45), anger (scores range from 7 to 35), hostility (scores range from 8 to 40), and verbal aggression (scores range from 5 to 25)). In Lithuanian social scientific literature Buss–Perry’s *Aggression Questionnaire* is broadly recognizable. Resent research has showed good internal consistency for all of the subscale, all of them were higher than 0.7 (Čėsniėnė, Bandzevičienė, 2009; Normantaitė, Perminas, 2013). During our research, permission from school director and psychologist or social educator was obtained.

Research sample. The study was conducted in the city of Kaunas (Lithuania) in 2013. Respondents were selected to the research groups at random. The study included interviewing 292 adolescents (140 non-athlete and 152 athlete adolescents), 116 girls and 176 boys among them. The subjects’ age was 14-16 years.

Statistical analysis. Research data were statistically processed using SPSS 17.0 software package. The following statistical characteristics were applied: the minimal value, the maximal value, arithmetic mean, standard deviation, standard error of the mean. *Kolmogorov-Smirnov* and *Shapiro and Wilk* tests were applied to verify normal distribution of quantitative values. At a normal distribution, the mean differences for independent samples between the two groups were compared using *Student’s t test*. In case of abnormal data distribution, the mean differences were compared using the *Mann-Whitney U test*. The hypothesis equality of the frequency of qualitative characteristics was verified using chi-square (χ^2) test. The differences were statistically significant at no more than a 5 percent error ($p<0.05$).

Results

The analysis of the occurrence of the forms of aggression allowed determining statistically significant differences between athlete and non-athlete adolescents’ physical, verbal aggression, and overall aggression parameters. It was found that aggression of those the forms was higher for athlete adolescents than for non-athletes ($t(292) = 11,58; p<0.05$) (Figure 1).

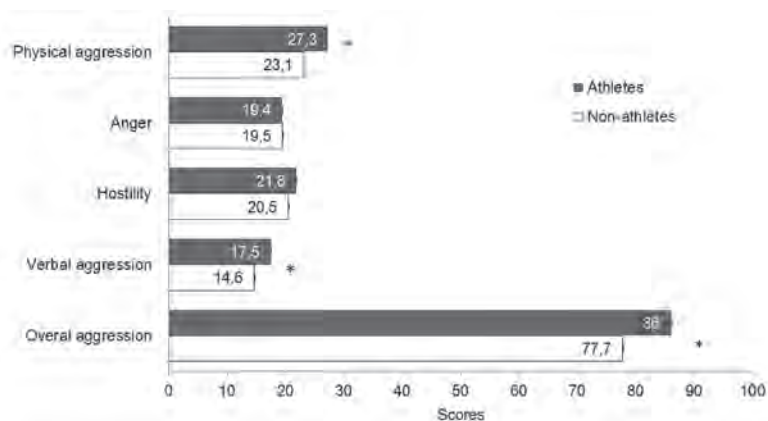

Figure 1: Expression of aggression for athlete and non-athlete adolescents ($t(292) = 11,58; p<0.05$)

Comparing the results of the expression of aggression by gender shows that boys were more aggressive than girls in the aspects of physical aggression, anger, and overall aggression ($t(292)=5,29; p<0.05$) (Figure 2).

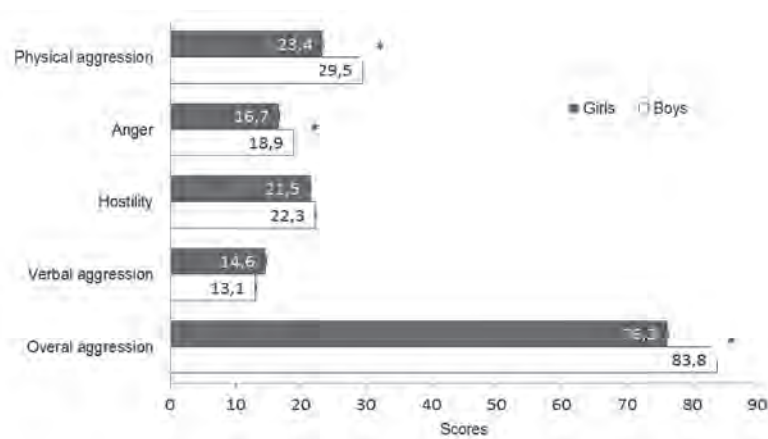

Figure 2: Expression of aggression for girls and boys ($t(292)=5,29; p<0.05$)

The analysis of self-esteem results for athlete and non-athlete adolescents show that respondents engaged in sport have higher self-esteem points than non-athletes ($\chi^2=10.17$; $df=2$; $p<0.05$) (Figure 3).

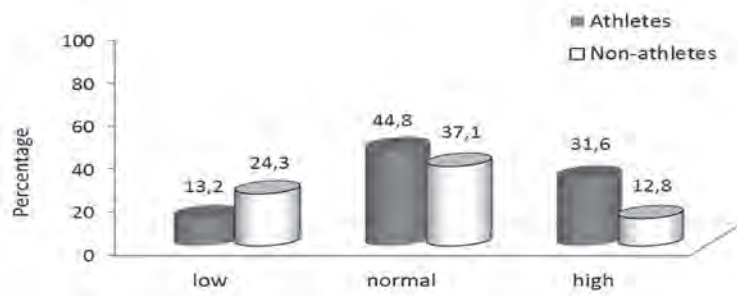

Figure 3: Self-esteem percentage distribution of athlete and non-athlete adolescents ($\chi^2=10.17$; $df=2$; $p<0.05$)

The data in Figure 4 show that boys demonstrate higher self-esteem than girls (Figure 4).

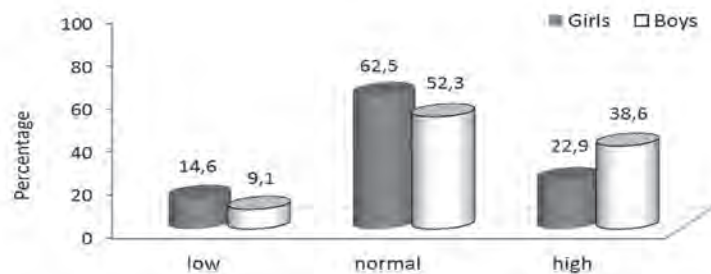

Figure 4: Self-esteem percentage distribution of girls and boys ($\chi^2=18.52$; $df=2$; $p<0.05$)

Discussion

Study of the expression of aggression for athlete and non-athlete adolescents revealed that physical, verbal and overall aggression was more characteristic of athletes. This is contrary to some researchers' claims that participation in physical activity is one of the most significant factors that positively affects adolescents' emerging system of values, communication and collaboration with peers, social skills, and positive personal qualities (Daniels, Leaper, 2006; Laskienė et al., 2010). However, our results were confirmed by other studies, which indicate that a competitive and business-oriented social environment actually encourages anti-social behaviour and has a negative impact on prosocial behaviour (Rutten et al., 2007). Scientists (Shields et al., 2007; Платонова, 2009) suggest that organized sports activities for young people can encourage antisocial behaviour because sport is the environment in which moral norms are forgotten as competition and egoistic interests are the most important in sport, so long-term sports activities can promote athletes' aggressive behaviour in other activities as well.

However, research results do not suggest that persons involved in sport are more aggressive than those not involved in sport. Some authors (Bruyn, Cillessen, 2006; Dunn, Dunn, Bayduza, 2008) indicate that athlete adolescents demonstrate some increased aggression (which can manifest in both prosocial and antisocial forms), as well as having an exceptional status (both positive and negative) in a peer group, which may lead them to be the initiators of aggression or vice versa. For example, Rutten et al. (2007) studied the effect of organized sports activities on adolescent antisocial and prosocial behaviour. Their results showed that the coaches who had a good relationship with their trainees helped them to reduce their ant-social behaviour, and this revealed that in those sports where sports activities were intense pro-social behaviour was promoted.

This study showed that boys more than girls were characterized by anger, physical and overall aggression. This is consistent with the results of many studies. For example, research by Ch. Salmivalli, A. Kaukiainen (2004), E. Kikas et al. (2009), Y. Kurtyilmaz, G. Can (2010) has shown that boys in adolescence are more physically aggressive than girls. According to M. Kavassanu, G. C. Roberts (2001), pro-social behaviour is common among girls, and this shows that adolescent girls demonstrate much greater moral qualities, unfair actions less commonly occur among them, they perform harmful actions less often compared with boys engaged in sport. However, Kurtyilmaz and Can's (2010) study has shown that boys are less aggressive than girls in the aspect of indirect aggression.

Scientists point out that both physical activity and adequate self-esteem are the attributes of the quality of human life and they influence one another (Masiliauskas, 2009). According to S. Gašič-Pavišič, S. Joksimovic, D. Janjetovič (2006), physical appearance is one of the components of the adolescent's self-esteem. Athlete adolescents, especially those who are involved in higher-level competitions, receive more praise, attention from their peers and other people important to them than non-athletes, which also conditions an adequate or increased self-esteem. According to the study results by S. Laskienė et al. (2010), athlete adolescents feel self-satisfied, and this confirms a relatively unified scientific opinion that sports activities positively affect the overall adolescent self-esteem: the stronger adolescent identifies with the role of an athlete, the more stable is self-awareness, increased self-confidence and higher levels of self-esteem. This is confirmed by our research results.

It has been found that boys have high self-esteem, and it is better than that of girls of the same age. Studies by other researchers have also shown that the self-esteem of boys is better than that of girls (Gašič-Pavišič, Joksimovic, Janjetovič, 2006). K. R. Berenson, T. N. Crawford, P. Cohen (2005) note that adolescent boys respond better to criticism, thus their self-esteem is higher than that of adolescent girls who are more emotional and more vulnerable. Research literature suggests that boys are less irritable and anxious than girls (Brettschneider, Kleine, Klimek, 2003).

Searching for research perspectives, respondents' sports activity area (branch) should be taken into account, as well as the aspects of respondents' extracurricular activities, and the sample size should be expanded.

Conclusions

The study showed that physical, verbal and overall aggression in adolescent athletes was relatively higher than in adolescent non-athletes. Adolescent athletes showed higher self-esteem scores compared to non-athlete respondents. Anger, physical and overall aggression were more characteristic in boys than girls. The study also revealed that boys possessed higher self-esteem than girls.

References

1. Beldean-Galea, I. E., Jurcău, N., Țigan, S. I. (2010). Frequency of Bullying Behaviors in secondary Schools in Cluj-Napoca. *Applied Medical Informatics*, 27 (4), 62-66.
2. Berenson, K. R., Crawford, T. N., Cohen, P. (2005). Implications of Identification with Parents and Parents' Acceptance for Adolescent and Young Adult Self – esteem. *Psychology Press*, 4, 289 – 301.
3. Brettschneider, W. D., Kleine, T., Klimek, G. (2003). *Sportpartizipation und Gewaltbereitschaft Jugendlicher – ein isrealisch – deutsche Vergleich.*: <http://sport.upb.de/gewalt/deutsch/index.html>
4. Bruyn, E. H., Cillessen, A. H. N. (2006). Popularity in Early Adolescence: Prosocial and Antisocial Subtypes. *Journal of Adolescent Research*, 21(6), 607-627.
5. Buss, A. H. & Perry, M. (1992). The Aggression Questionnaire. *Journal of Personality and Social Psychology*, 63, 452–459.
6. Cerezo, F. (2009). Bullying: análisis de la situación en las aulas españolas. *International Journal of Psychology and Psychological Therapy*, 9 (3), 367 - 378.
7. Čėsniėnė, I., Bandzevičienė, R. (2009). Jaunuolių pakartotinio nusikalstamo elgesio prognozė: galimybės ir problemos (Predicting Juvenile Re-offending: Opportunities and Problems). *Socialinis darbas*, 8(1), 92-102: https://www.mruni.eu/lt/mokslo_darbai/sd/archyvas/dwn.php?id...%E2%80%8E
8. Daniels, E., Leaper, C. (2006). A Longitudinal Investigation of Sport Participation, Peer Acceptance, and Self – esteem among Adolescent Girls and Boys. *Sex Roles*, 55, 875 – 880.
9. Dracic, S. (2009). Bullying And Peer Victimization. *Materia socio medica*, 21 (4), 216 – 21.
10. Dunn C.J., Dunn, J. G. H., Bayduza, A. (2008). Perceived Athletic Competence, Sociometric Status, and Loneliness in Elementary School Children. *Journal of Sport Behavior*, 30(3), 249-269.
11. Hilton, J.M., Anngela-Cole, L., Wakita, J. (2010). A Cross-Cultural Comparison of Factors Associated With School Bullying in Japan and the United States. *Family Journal*, 18(4), 413-422.
12. Fleming, L. C. Jacobsen K. H. (2009). Bullying and Symptoms of Depression in Chilean Middle School Students. *Journal of School Health*, 79(3), 130-137.
13. Gašič-Pavišič, S., Joksimović, S., Janjetovič, D. (2006). *General Self – Esteem and Locus of Control of Young Sportsmen*. Belgrade: Institute for Educational Research.
14. Graham S. (2010). What Educators Need to Know About Bullying Behaviors. *Kaplanmagazine*, 92 (1), 66–69.
15. Kikas, E., Peets, K., Tropp, K., at all. (2009). Associations between Verbal Reasoning, Normative Beliefs about Aggression, and Different Forms of Aggression. *Journal of Research on Adolescence*, 19 (1), 137-149.
16. Kurtyilmaz, Y., Can, G. (2010). An Investigation of Turkish Preservice Teachers' Aggression Levels. *Education and Treatment of Children*, 33 (1), 85-114.
17. Laskienė, S., Laskytė, A., Šertvytienė, D., Jamantienė, L. (2010). 16—17 metų sportuojančių ir nesportuojančių paauglių savo kompetencijos suvokimas ir bendrasis savęs vertinimas. *Ugdymas. Kūno Kultūra. Sportas*, 1 (76), 78–85.

18. Laufer, A., Harel, Y., Molcho, M. (2006). Daring, Substance Use and Involvement in Violence Among School Children: Exploring a Path Model. *Journal of School Violence*, 5(3), 71 - 88.
19. Lester, P. E., Lloyd E. B. (1997). *Handbook of Tests and Measurement in Education and the Social Sciences*. Lancaster, PA: Technomic Publishing Co.
20. Mahoney, J. L. (2000). School extracurricular activity participation as a moderator in the development of antisocial patterns. *Child Dev*, 71, 502–516.
21. Mahoney, J. L., Stattin, H. (2000). Leisure activities and adolescents' antisocial behavior: The role of structure and social context. *Journal of Adolescence*, 23, 2000, 113—127.
22. Marini, Z. A., Dane, A. V., Bosacki, S. L. (2006). Direct and Indirect Bully-Victims: Differential Psychosocial Risk Factors Associated With Adolescents Involved in Bullying and Victimization. *Aggressive behavior*, 32, 551 - 569.
23. Masiliauskas, D. (2009). Skirtingo fizinio aktyvumo paauglių savęs vertinimas. *Socialiniai mokslai. Jaunujų mokslininkų darbai*, 2 (23), 162 – 166.
24. Normantaitė, D., Perminas, A. (2013). Jaunesnių ir vyresnių 13-17 metų paauglių agresyvaus elgesio palyginimas po intervencijos, grįstos kognityvine-elgesio terapija (The Changes in Aggression of Younger and Older 13-17 year-old Adolescents after Cognitive- Behavioral Intervention). *Jaunujų mokslininkų psichologų darbai*, (2), 13-17: <http://www.jmpk.fsf.vu.lt/wp-content/uploads/2013/12/2013-JMPD-nr2.pdf>
25. O'Neill M., Calder A., Allen B. (2013). Tall poppies: bullying behaviors faced by Australian high performance school-age athletes. *Journal of School Violence*, accepted manuscript: DOI: 10.1080/15388220.2013.846223.
26. Peleg – Oren, N., Cardenas, G. A., Comerford, M., Galea, S. (2012). Does school connectedness buffer the impact of peer victimization on early adolescent' subsequent adjustment problems? *The Journal of Early Adolescence*, 33 (2), 245 – 266.
27. Penning, S. L., Bhagwanjee, A., Govender, K. (2010). Bullying boys: the traumatic effects of bullying in male adolescent learners. *Journal of Child and Adolescent Mental Health*, 22 (2), 131–143.
28. Rutten, E. A., Geert, J., Stams, J. M., Gert, J., Biesta J., Schuengel, C., Dirks, E., Hoeksma, J. B. (2007). The Contribution of Organized Youth Sport to Antisocial and Prosocial Behavior in Adolescent Athletes. *Journal Youth Adolescence*, 36, 255 – 264.
29. Salmivalli, Ch., Kaukiainen, A. (2004). „Female Aggression” revisited: variable and person - centered approaches to studying gender differences in different types of aggression. *Aggressive behavior*, 30, 158 – 163.
30. Santisteban, C., Alvarado J. M., Recio P. (2007). Evaluation of a Spanish version of the Buss and Perry aggression questionnaire: Some personal and situational factors related to the aggression scores of young subjects. *Personality and Individual Differences*. 42(8), 1453–1465.
31. Scheithauer, H., Hayer, T., Petermann, F., Jugert, G. (2006). Physical, verbal, and relational forms of bullying among German students: age trends, gender differences, and correlates. *Aggressive Behavior*, 32 (3), 261 - 275.
32. Shields, D. L., LaVoi, N.M., Bredemeier B.L., Power F.C. (2007). Predictors of poor sportpersonship in youth sport: personal attitudes and social influence. *Journal of Sport and Exercise Psychology*, 29 (6), 747-762.
33. Šukys, S. Jankauskienė, R. (2008). Mokinių sportavimo ir fizinio aktyvumo laisvalaikio sąsajos su psichosocialiniais, elgesio ir mokyklos veiksniais. *Ugdymas. Kūno kultūra. Sportas*, 1 (68), 92–99.
34. Ullrich-French S., McDonough M. H., Smith A.L. (2013). Social Connection and Psychological Outcomes in a Physical Activity-Based Youth Development Setting. *Research Quarterly for Exercise and Sport*, 83(3), 431–441.
35. WHO. (2008). Health Behavior in School-aged Children (HBSC) study. *Data and publications: Chapter 2, Section 4: risk behavior*. <http://www.euro.who.int/eprise/main/WHO/InformationSources/Publications/Catalogue/20080617_1>.
36. Платонова, З. Н. (2009). Агрессия как фактор адаптации подростков, занимающихся спортом. *Спортивный психолог*, 3 (18), 67–70.

THE ATTITUDE OF THE PRESCHOOL CHILDREN'S PARENTS IN ZADAR AND ZAGREB TOWARDS DANCE

Jadranka Vlašić¹, Zlatka Glavurčić² and Goran Oreb¹

¹Faculty of Kinesiology, University of Zagreb, Croatia

²Dance Studio "Escape", Zagreb, Croatia

Abstract

The basic aim of the research has been to establish the attitude of preschool children's parents toward dancing as a potential activity for their children. The attitude towards dancing scale (Vlašić, Bosnar 2007) has been used to estimate the attitude. The research has been conducted in some preschool institutions in Zadar and Zagreb on the sample of 273 parents. The results obtained in the research show no significant difference on the significance level $p < 0.01$ in the attitude towards dance regarding the parents' residential status when it is not in interaction with other variables. Statistically significant difference has occurred by the child's and parent's gender factors in interaction with the child's and parent's gender and residence, as well as in the interaction with all three factors defined. The lowest positive attitude toward dancing, as well as the highest positive attitude has been observed in Zadar, depending on whether the subjects father sons or daughters.

Key words: attitude toward dance, parents, children, differences, gender, age, residential status

Introduction

Dance is a rhythmical movement of the body, one of many artistic expressions; it is the sequence of rhythmical steps and body movements in a specific pace performed to the measure of music; it is a social entertainment where people dance (Anić, 2002). From the aspect of kinesiology, dance is a conventional aesthetic movement many authors consider combination of sport and art (Bijelić, 2006) while, as a kinesiological operator, it is effective from the aspect of transformational, educational and pedagogical effects (Li&Yoa, 2005). If we take into consideration that the movement is not only the form, but the expression of the moving body as well, it is possible to draw a conclusion that dancing moves and dancing skills affect positively mental health and complete human psycho-physical condition in general. The need for systematic and high quality physical activity training from the earliest age originates from the fact that motor development influences greatly the overall development of the preschool children. Doing some kinesiological activities is the main motivation to maintain good health, especially at children's and young age. Physical activity plays an important role in physical, mental and social development in childhood and the period of growth. One of the important tasks of adults is to develop an awareness of the need to do physical exercises. Technological development and modern way of life impose a different everyday routine, thus creating insecurity in mental and emotional expressions of an individual, either due to the lack of confidence or the lack of movement, which has been recognized as one of the greatest problems of modern people. Since we wanted to take into consideration, as correctly as possible, the current knowledge and ideas of the population capable to have influence on some changes, and to compare these, research has been carried out on the attitude of preschool children's parents towards dance as one of the positive factors affecting general development of any person.

Attitude is defined as an acquired, relatively permanent and stabile organisation of emotions, evaluations and reactions toward a certain object (Petz, 1992). It is considered to be necessary for explaining and predicting behaviour and it is an essential term of many motivation theories. Emotionally supported attitude is based on emotions and values towards the object of the attitude. Once the attitudes, and consequently a public opinion, have been formed, it is very difficult to provoke any changes i.e. there must be created a functional and motivational basis on which the forming of a different attitude is founded (Zvonarević, 1981). In particular situations, an individual's behaviour, which is not in accordance with his/her attitude, can have influence on the change of the attitude, accompanied by the change of conditions and motives. The experience of pleasant and positive emotions the dance gives attributes to the change of an individual's "negative" attitude towards dance, which might eventually be crucial for forming of a generally positive attitude. Current research have mostly supported the stereotype that dance belongs to the female category of sports (Oglesby and Hill, 1993, according to Bosnar, Sertić and Prot, 1999) and that it is far more popular with women in Croatia. A question arises whether this idea occurs in both a small and a big town, and whether it is evident in a generation of nowadays young parents, which might be dangerous, because of the possible negative attitude transfer onto a new generation.

The research has been done with an assumption that there are differences in attitudes of the parents-subjects considering the fact that they come from two different residential environments, two morphologically different regions and therefore potentially two different attitudes towards dance. The aim of the research has been to establish, on the sample of preschool children's parents from Zagreb and Zadar, the attitude towards dance (general), differences in attitudes according to the parent's gender, differences in attitudes according to the child's gender and differences in attitudes according to the subjects' residential status.

Methods

The research has been conducted on an appropriate sample of 273 subjects in total (aged from 24-41) preschool children's parents (children's age 2.5-7 years). The sample consisted of 132 parents from Zadar (48.35%) and 141 parent from Zagreb (51.65%). Mothers have made up 203 (74.36%) of the subjects and fathers 70 (25.64%). According to the data, the greatest number of the subjects have been aged from 30-40 years, so the correlation between the parent's age and the age of the child attending preschool institution has been noticed.

The attitude of the preschool children's parents towards dancing has been estimated by the attitude towards dance scale ATD (Vlašić, Bosnar 2007). The scale consists of 20 particles in both directions (positive and negative) with the 5 grades answers: "I agree completely", "I agree mostly", "I'm not sure", "I generally disagree" and "I totally disagree". The answers have been evaluated with 1 to 5, so that the bigger result denotes a positive attitude and the smaller a negative one. The questionnaire registered the parent's gender and age, the child's gender and age and their residence.

Basic statistic parameters have been calculated for all the results. The results of items on the principal component (K1) have been calculated with the factor analysis. Distributions and measuring characteristics of the total result have been set on the attitude towards dance scale. Differences in attitude according to the parent's gender, differences in attitude according to the child's gender and the differences in attitude according to the subjects' residence have been determined by the variance analysis.

Results

Table 1: The result of an item on the principal component (K1)

item	K1
I love dancing.	-0.676
When I am out with friends in a club with music, I spend the time talking.	0.565
I don't like weddings because the most people dance there.	0.485
I feel embarrassed when somebody is watching me when I dance.	0.411
I love watching a synchronized dancing couple.	-0.469
Dancing with a partner motivates me to dance even better.	-0.365
I'm happy when I dance.	-0.686
I love moving to some nice music.	-0.689
I avoid dancing.	0.781
Whenever there is an opportunity to dance, I take it.	-0.807
Dancing makes me feel uncomfortable.	0.797
I love dance shows.	-0.531
I feel unpleasant dancing in a circle dance.	0.514
I find it difficult to follow my partner's steps.	0.392
I'd dance all night and day.	-0.507
When I dance alone, I feel silly.	0.617
I love dancing in a couple.	-0.445
When we dance a circle dance, I feel fine.	-0.564
I can't imagine going out and not dancing.	-0.420
I take every opportunity to dance.	-0.641

Table 1 shows the result of an item on the principal component. Negative values are the values of the items which have been marked reversely on the attitude towards dance scale and they have been coded differently in the further procedure, so that the higher value denotes the more positive attitude. According to the values from the Table 1, it becomes evident that all items measure well the main object of the measurement, which is also supported by the fact that the lowest value for each item measures 0.392.

Table 2: Basic statistic indicators of the total result on the attitude towards dance scale

	N	MEAN	MIN	MAX	SD
TOTAL	273	73.62	35	100	13.46

It is possible to notice that the minimal result amounts more than theoretical minimum (35>20) and that the maximum result has reached the theoretical maximum, according to the total result on the attitude towards dance scale (Table 2). It is possible to determine a generally positive attitude of the subjects towards dance since the average value of the total result on the scale is 73.62 and any total result bigger than 60 is considered positive.

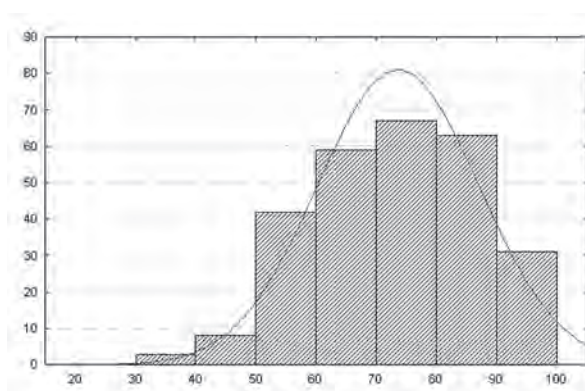

Picture 1: Distribution of the total result on the attitude towards dance scale, x-axis shows the result, ordinate shows the subjects' frequencies. Full line marks a theoretically normal distribution.

The Picture 1 shows total result distribution graph on the attitude towards dance scale. With the level of significance being p=0.01, the distribution does not differ statistically significantly from the normal distribution, which has been checked by Kolmogorov-Smirnov test (d=0.08762).

Table 3: The analysis of the group of parents variance defined by the child's and parent's gender and the residential status on the attitude towards dance scale total result

Factor	Sum of Squares	Degrees of Freedom	Average squares	F - value	p
Residence	942.8	1	942.8	6.395	0.012024
Parent's gender	1996.9	1	1996.9	13.546	0.000282
Child's gender	2707.4	1	2707.4	18.365	0.000026
Residence and parent's gender interaction	36.9	1	36.9	0.250	0.617142
Residence and child's gender interaction	1381.6	1	1381.6	9.372	0.002430
Parent's and child's gender interaction	452.0	1	452.0	3.066	0.081114
Interaction of all three factors	1150.3	1	1150.3	7.803	0.005597
Error	39065.9	265	147.4		

By analysing the groups of parents variance (Table 3), statistically significant results (on the significance level 0.01) have been gained for parent's and child's gender, residence and parent's gender and interaction of all three factors included.

Table 4: Arithmetical means and standard deviations of the total result on the attitude toward dance scale for the groups of parents defined by gender and residential status

	N	Arithmetical mean	Standard deviation
Total	273	73.62	13.46
Zadar	132	77.85	12.51
Zagreb	141	69.66	13.14
mothers	203	75.51	12.23
fathers	70	68.13	15.31
daughters	210	75.20	13.20
sons	63	68.37	13.05
Zadar mothers	107	78.58	11.31
Zadar fathers	25	74.72	16.64
Zagreb mothers	96	72.09	12.38
Zagreb fathers	45	64.47	13.35
Zadar daughters	104	79.88	11.08
Zadar sons	28	70.32	14.72
Zagreb daughters	106	70.60	13.55
Zagreb sons	35	66.80	11.53
Daughters' mothers	160	76.62	11.93
Sons' mothers	43	71.37	12.61
Daughters' fathers	50	70.62	15.92
Sons' fathers	20	61.90	11.84
Zadar daughters' mothers	85	79.74	10.90
Zadar sons' mothers	22	74.09	11.97
Zadar daughters' fathers	19	80.47	12.12
Zadar sons' fathers	6	56.50	16.61
Zagreb daughters' mothers	75	73.09	12.12
Zagreb sons' mothers	21	68.52	12.91
Zagreb daughters' fathers	31	64.58	15.06
Zagreb sons' fathers	14	64.21	8.92

Discussion and conclusions

Significant difference in attitude towards dance has been obtained in the area of residential status, i.e. more positive attitude towards dance have the parents from Zadar (77.85) than from Zagreb (69.66) which is noticeable by comparing average results values on the attitude towards dance scale. If we compare parents' gender, we see more positive attitude towards dance by mothers (75.51) than by fathers (68.13). By further result analysis, a significant difference in parents' attitude towards dance occurs depending whether they have got a daughter or a son, so more positive attitude toward dance has been expressed by parents with daughters (75.20) rather than by the ones with sons (68.37). The difference in attitude towards dance is also significant when we take into consideration the residential status and the child's gender. The parents from Zadar who have got daughters have expressed the most positive attitude (79.88), only a bit lower positive attitude has been expressed by the parents from Zagreb who have got daughters (70.60) which is by 0.27 lower than the attitude of the subjects from Zadar who have got sons. The least positive attitude towards dance regarding the child's gender and residential status has been expressed by the sons' parents from Zagreb (66.80). Considering residential status and the child's and parent's gender, significant differences are observable by fathers from Zadar who have got daughters (80.47) and mothers from Zadar who have got daughters (79.74). The lowest attitude towards dance i.e. the least positive attitude towards dance has been expressed by fathers from Zadar who have got sons (56.50). On the basis of the average value results on the attitude towards dance scale, it is possible to conclude that the attitude of the parents from Zadar towards dance is mostly influenced by their child's gender, where at the same time, the most positive and the least positive attitude is shown by fathers from Zadar precisely, depending on whether they father daughters or sons. There is a great difference in attitude between the fathers from Zadar with daughters (80.47) and fathers from Zagreb with daughters (64.58).

Doing some kinesiological activities is the main impetus to maintain good health, especially at children's age. During the childhood and growing up, physical activity plays an important role in physical, mental and social development and parents, teachers and preschool children educators and caretakers are people responsible for the development of the awareness of the need to do physical exercises. Preschool children are characterised by a more intensive process of growth and development. In this period, there should be preferred activities which improve the cardiovascular and respiratory system development and which affect positively child's psychical condition, and dance in particular is such an activity. By introducing dance to preschool children, a stronger contribution and support is being made to health improvement and physical development as well as functional and motor abilities and skills development, furthermore to acquiring some sport basics, to development of the sense of aesthetically formed moves and art, to development of hygienic and cultural habits as well as to loving sport in general. The great contribution of practicing dance at preschool age should be especially stressed because at that time the children are not the least burdened with their sexual affiliation, which makes the preschool age an ideal age to eliminate any stereotypical barriers about female and male sports, leaving thus space for choice of activities in accordance with the child's interest and liking.

The idea which prompted authors to do this research, apart from detecting the attitude towards dance as a stereotypically female sport, was that there will appear a statistically significant difference in attitude of the parents from two towns towards dance. It was assumed that the more developed capital city will show more positive attitude. The results of the research show the more positive attitude of the parents from the smaller urban environment in comparison to the bigger one. The explanation is not an easy one to find, so some additional research should be conducted to find out why the dance is favoured in the smaller and more conservative environment.

References

1. Anić, V. (ur.) (2002). Hrvatski enciklopedijski rječnik. Zagreb: Novi liber.
2. Bijelić, S. (2006). Plesovi. Banja Luka: Atlantik BB.
3. Bosnar, K., Sertić, H., Prot, F. (1999). Razlike u stavu prema borilačkim sportovima djevojčica i dječaka, učenika viših razreda osnovne škole. U: D. Milanović (ur.), *Zbornik radova „Kineziologija za 21. stoljeće“*, Zagreb, 1999 (str. 123-125). Zagreb: Fakultet za fizičku kulturu Sveučilišta u Zagrebu.
4. Li, X.-X., Yao, Y. (2005). Effect of dance-sport on physical-psychological health of university students. *Chinese journal of Clinical Rehabilitation*, 9(40), 19-192.
5. Petz, B. (1992). Psihologijski riječnik. Zagreb: Prosvjeta.
6. Vlašić, J. (2010). Razlike između studenata i studentica u plesnoj uspješnosti i stavovima prema plesu. (Doktorska disertacija). Zagreb: Kineziološki fakultet Sveučilišta u Zagrebu.
7. Zvonarević, M. (1981). Socijalna psihologija. Zagreb: školska knjiga.

THE INFLUENCE OF THE SOCIAL STATUS, MICRO SOCIAL TEAM STRUCTURE AND GROUP COHESION ON THE SCORING EFFICIENCY OF ELITE CROATIAN JUNIOR NATIONAL TEAM HANDBALL PLAYERS

Dinko Vuleta jr. and Ivana Klaričić

Zagreb, Croatia

Abstract

This study was conducted to determine the influence of the social status, micro social team structure and group cohesion on the scoring efficiency of elite Croatian junior national handball players. The participants of the study were 16 players which were the members of the junior Croatian national handball team which played at the IHF men's junior World Championship held in 2013 in Bosnia and Herzegovina. Three questionnaires were conducted which assess the social status, micro social team structure and group cohesion. The scoring efficiency was collected from the official statistics of the matches. The descriptive statistics methods, correlation analysis, and the multiple regression analysis were used to analyze the results. The correlation analysis of the items assessing the social status revealed only a significant positive correlation of the variable Player listening to popular music with the Scoring efficiency ($r = 0,60$; $p = 0,02$). The results of the questionnaire which assesses the micro social structure reveal that there is a higher degree and more refined level of emotional relations than functional relations within the team. The results from the group cohesion questionnaire revealed that there is a slightly higher level of the emotional cohesion dimension than the functional cohesion dimension. The multiple regression analysis revealed a statistical significant relation between the social status, micro social traits and group cohesion with the dependent variable scoring efficiency ($p_{mr} > 0.01$). The independent group shares 66% of the total variance with the scoring efficiency which refers to a strong influence of the overall measured social dimensions on the scoring efficiency of the junior handball players. The multiple regression results point out to the fact that the team players which scored a higher number of goals have lower levels of micro social and group cohesion values and the players which scored less goals have higher levels of micro social traits and group cohesion values. In a global sense the bad micro social structure has a negative influence on the players scoring

Key words: *social dimensions, influence, scoring, junior, handball*

Introduction

The key to success? It is the main question which drives numerous sport scientists, coaches and players during the "sport science era" to look into the fundamental occurrences in the game. What makes a sport team better than the other? Individual abilities, individual actions, small group interactions on the court or the overall team players interaction on the court and off the court. It is often referred that the overall quality of the team can be defined as the sum of the quality of its parts manifested in the right in-game situation. Optimally performed activities in the handball match lead to a higher success without a doubt. But, what stands behind those actions is much more interesting to sport scientists worldwide.

To the authors knowledge studies with the sociometric quantitative approach have been conducted in handball (Petrović & Šiftar, 1970; Težak, 1986; Sindik & Mihaljević, 2011). Handball is a complex polystructural kinesiological activity in which the success is achieved through players' optimal interactions. It is important that the handball team is emotionally and functionally balanced without any radical polarizations of players (Sindik & Mihaljević, 2011). The players' sincerity, tolerance and social responsibility represent fundamental values on which a successful team is built as well as an optimal style of play. Fundamental values in team sports have been presented throughout the history, but what is more important is the person which grants the team the benefits of good values. A higher number of players with good values in the team, the higher are the opportunities to achieve an optimal micro social structure inside the team. The group cohesion is also one significant part of the team performance which is reviewed in a prior study (Carron, 1982) in which the researcher has explained the nature of the phenomena.

There are no studies known to the authors regarding the sociologic status, micro social team structure and group cohesion conducted on the sample of elite junior handball players. And more important is the relation of such dimensions with the players scoring effectiveness. Although, the research is conducted on a small and selected sample size, valuable informations can be obtained.

Methods

Sample. The 16 players which participated in this study were the members of the junior Croatian national handball team. The investigation was conducted during the IHF men's junior World Championship held in 2013 in Bosnia and Herzegovina. The junior Croatian national team finished fourth on the Championship, which means that the team had suffered two defeats at the end of the tournament.

Questionnaires and variables. The results were collected with maximal secrecy and anonymity. No one other than the researchers were aware of the obtained results. This study encompassed the usage of three questionnaires. The social status was assessed with a questionnaire adapted for this study which consisted of 18 questions with sub-items. For the purpose of this study the most important 16 items were selected for analysis. The items assessed information regarding: the education of the players father, mother, knowledge of foreign languages of the player, father, mother, workplace qualification father, mother, success in the last grade of high school, players listening to classical music, players listening to popular music, players listening to rock, players reading local newspaper, number of books in the family, father's sport success, mother sport success, family income. The results were condensed into a variable named Social status (*SS*).

The team's micro social structure was assessed using a questionnaire consisted of 6 items (modified according to?? Šimenc, 1985; Marković, 2002) oriented after two criteria: emotional (*EC SUM3*) and functional (*FC SUM3*). The questions were answered on 5 point Likert scale (from 1 to 5): sharing the room during the training cycles and championships (*EC1*), trust to confess personal problems (*EC2*), players to go out with (*EC3*), players best for cooperation during the game (*FC1*), players to ask advice about handball anytime (*FC2*), player selected for the captain (*FC3*). The total results were summed and expressed as the Micro social team structure (*MSTS*).

The Group Environment Questionnaire (GEQ; Carron et al., 1985) was used to assess group cohesion. This questionnaire contains 18 items. The metric characteristics of this questionnaire have been assessed in prior studies (Brawley et al., 1987; Brawley, 1990; Li & Harmer, 1996). The results were standardized and condensed into two dimensions: emotional cohesion (*EMCO*), functional cohesion (*FUCO*). Furthermore, the total informations acquired by the questionnaire are summarized into the total cohesion of the group (*TCG*).

The players' efficiency was expressed through the total number of scored goals (*SGOAL*) on the IHF men's junior World Championship held in 2013 in Bosnia and Herzegovina.

Data analyses. The obtained results are presented through measures of descriptive statistics: arithmetic mean (*AM*), standard deviations (*SD*), minimal value (*Min*), maximal value (*Max*). The normality of the distributions of the variables was tested with Kolmogorov-Smirnov test. The values obtained from the K-S test were maximal deviation of the empirical distribution of the theoretical distribution (*KS_{maxD}*) and the level of error of the maximal deviation (*p_{KSmaxD}*) K-S critical value for $p=0.05$ (*KS_{crit}*). Pearson correlation coefficients (*SGOAL r*) and levels of error (*SGOAL_{plev}*) were calculated as well as Spearman rank correlation (*Spear r*). The multiple regression analysis is used to assess the influence of the social status, micro social team structure and group cohesion to the players scoring efficiency. The following parameters were calculated in the regression analysis: coefficient of multiple correlation (ρ), coefficient of determination (ρ^2), level of error (*p_{mr}*), standardized regression coefficients (β), tolerance (*TOL*) partial correlation coefficients (*PCOR*), level of error (*p_{par}*). Statistical significance is set at $p \leq 0.05$. Statistical power (*Power*) was calculated using GPOWER 3.1. (Faul et al., 2007; Faul et al., 2009). The *Statistica 10.0* for Windows statistical package (Statsoft Inc., Tulsa, Oklahoma) was used to process and report the data.

Results

The first questionnaire answered by the players of the Croatian junior national handball team about their social status revealed a large variety of results. The results reveal that the average education level of the players' mothers surpasses the qualification level of their fathers. What is interesting is that the workplace qualification of the players' fathers is slightly higher than their mothers. What is important to stress is the achievement of players in the last grade of high school regarding their grades which were at the mean level of 3 which refers to the grade very good (4) in the Croatian educational system. Such achievement is highly valued and respectable due to the fact that the young handball players sacrifice a large amount of time for training and matches over the school year, preparation cycles and season. Players prefer listening to popular music rather than classical and rock music. What is interesting is that the rock music is also highly popular with the players of this team. Another interesting finding is a high positive correlation of the Players listening to popular music and Scoring efficiency (*SGOAL r* = 0,60; *SGOAL_{plev}* = 0,02; *Spear r* = 0,68). The players have a high tendency to be informed about social and sport events through local newspapers. Families of the players in this team do indeed have a relatively high number of books which surpasses the number 100, which points out to the fact of the high literacy of families and which is expressed both through the high education level of parents, successfulness of players in school and being informed about the social happenings through newspapers. The sports career achievements of the parents were mostly without significant results. The family income of the players' families is in the range of the average income of other Croatian families.

The results of the second questionnaire which assesses the micro social team structure through six questions give an interesting insight of the situation in the team. If the results are observed on the aspect of the total emotional and functional criteria it can be concluded that the players have a higher degree and more refined level of emotional relations than functional relations within the team.

Table 1: Sum of the results of the emotional and functional relations in the micro social team structure

	AM	SD	Min	Max	KS _{maxD}	P _{KSmaxD}
EC SUM3	182,88	14,22	156	206	0,14	>0.20
FC SUM3	138,19	17,62	114	175	0,15	>0.20
					KS _{crit}	0,33

Emotional criteria (**EC SUM3**), functional criteria (**FC SUM3**).

The results of the K-S tests reveal that the variables have normal distributions. If the results presented in Table 1. are observed and explained in a more global sense, it can be concluded that there is a serious disbalance in the teams micro social structure. Low results in the functional dimension of the relations and especially in the question regarding the respect towards the knowledge of team players reveal a deal of mistrust which can seriously damage the overall individual and team effectiveness. Such disbalance and the mistrust among the team players could point out to a possible intra social team breakdown in crisis situations during the match. The researchers suggest to team coaches due to this finding to have a great deal of care with the selection process and the development of intra team social relations with various processes.

The results presented in Table 2. reveal that there is a slightly higher level of the emotional dimension than the functional dimension in the group cohesion. These findings concur with the results of the previously analyzed questionnaire which measures assesses the level of the micro social team structure (Table 1.).

Table 2: Descriptives of the results in the emotional and functional cohesion

	AM	SD	Min	Max	Skew	Kurt	KS _{maxD}	P _{KSmaxD}
EMCO	65,31	10,12	44,00	79,00	-0,62	-0,49	0,19	>0.20
FUCO	64,31	7,45	49,00	77,00	-0,69	0,40	0,18	>0.20
							KS _{crit}	0,33

Emotional cohesion (**EMCO**), functional cohesion (**FUCO**).

The results of the questionnaires which assess the social status (**SS**), micro social structure (**MSTS**) and total group cohesion (**TCG**) were condensed into three dimensions to determine the influence of such dimensions on the scoring efficiency of junior handball players. Correlations between the social status, micro social team structure, group cohesion, scoring efficiency and the normality of distributions of the variables are presented in Table 3. All of the variables are normally distributed (Table 3.). There is medium non-significant correlation between the social status and micro social team structure ($r = 0,40$), and a small non-significant negative correlation between the social status and scoring efficiency ($r = -0,33$).

Table 3: Correlations between the social status, micro social team structure, group cohesion, scoring efficiency and the normality of distributions of the variables

	SS	MSTS	TCG	SGOAL	KS _{maxD}	P _{KSmaxD}
SS	1,00	0,40	0,05	-0,33	0,21	>0.20
MSTS	0,40	1,00	-0,01	-0,58	0,16	>0.20
TCG	0,05	-0,01	1,00	-0,55	0,16	>0.20
SGOAL	-0,33	-0,58	-0,55	1,00	0,20	>0.20
					KS _{crit}	0,33

Social status (**SS**), micro social team structure (**MSTS**), total cohesion of the group (**TCG**).

A medium significant negative correlation is revealed (Table 3.) between the micro social team structure and the scoring efficiency ($r = -0,58$; $p = 0.02$), and between the total cohesion of the group and the scoring efficiency ($r = -0,55$; $p = 0.03$). Such finding can be explained with the fact that there is a undesirable level of social relations between the players which has negative effect on players scoring during the match. A negative correlation could also mean that the players with low micro social traits and group cohesion values contribute significantly to scoring on matches. In light of this finding we propose a thorough review of the played matches to determine whether there is strong level of disrespect and low cooperation between some players.

Table 4: Influence of the social status, micro social team structure and group cohesion on scoring efficiency

ρ	0,81		β	PCOR	TOL	p_{par}
ρ^2	0,66	SS	-0,08	-0,13	0,84	0,66
p_{mr}	> 0,01	MSTS	-0,55	-0,65	0,83	0,01
Power	0,98	TCG	-0,56	-0,69	0,99	0,01

Social status (SS), micro social team structure (MSTS), total cohesion of the group (TCG).

The multiple regression analysis (Table 4.) revealed a statistical significant relation between the social dimensions with the dependent variable scoring efficiency ($p_{mr} > 0.01$). The independent group shares 66% of the total variance with the scoring efficiency which refers to a strong influence of the overall social dimension on the scoring efficiency of the junior handball players. The analysis also revealed (Table 4.) a statistically significant negative influence of the micro social structure ($\beta = -0,55$, $PCOR = -0,65$, $p_{par} = 0,01$) and the total group cohesion ($\beta = -0,56$, $PCOR = -0,69$, $p_{par} = 0,01$) on the scoring efficiency. The values of the correlation (Table 3.) partial correlations and tolerance (Table 4.) point out to the fact there is no suppressor effect in the regression model. The multiple regression results point out to the fact that the team players which scored a higher number of goals have lower levels of micro social and group cohesion values, and the players which scored less goals have higher levels of micro social traits and group cohesion values. The results from the multiple regression analysis (Table 4.) and from the analysis of the micro social structure (Table 1.) point out to the possible fact that the junior team has high quality individual players and the there is an issue regarding the trust in players what to do on court. In a global sense the bad micro social structure has a negative influence on the players scoring. This unwanted structure of relations inside the team resulted with junior national team to end in the fourth place.

Conclusion

The correlation analysis of the items assessing the social status revealed only a significant positive correlation of the variable player listening to popular music with the scoring efficiency ($r = 0,60$; $p = 0,02$). The results of the questionnaire which assesses the micro social structure reveal that there is a higher degree and more refined level of emotional relations than functional relations within the team. The results from the group cohesion questionnaire revealed that there is a slightly higher level of the emotional cohesion dimension than the functional cohesion dimension. The multiple regression analysis revealed a statistical significant relation between the social status, micro social traits and group cohesion with the dependent variable scoring efficiency ($p_{mr} > 0.01$). The multiple regression results point out to the fact that the team players which scored a higher number of goals have lower levels of micro social and group cohesion values and the players which scored less goals have higher levels of micro social traits and group cohesion values. In a global sense the bad micro social structure has a negative influence on the players scoring. For further studies which should be conducted in this area, we suggest a more direct approach which includes both the quantitative and qualitative (interviews, oversight during training and matches) approach. Such studies will contribute greatly to the improvement of the team's micro social structure as well as prevention of unwanted behavior.

References

1. Brawley, L.R. Carron, A.V., Widmeyer, W.N. (1987). Assessing the cohesion of teams: validity of the the Group Environment Questionnaire. *Journal of Sport Psychology*, 9: 275-294.
2. Brawley, L.R. (1990). Group cohesion: status, problems and future directions. *International Journal of Sport Psychology*, 21: 335-379.
3. Carron, A.V. (1982). Cohesiveness in sport groups: implications and considerations. *Journal of Sport Psychology*, 4: 123-138.
4. Carron, A.V., Widmeyer, W.N., Brawley, L.R. (1985). The development of an instrument to assess cohesion in sport teams: The group environment questionnaire. *Journal of Sport Psychology*, 7: 244-266.
5. Faul, F., Erdfelder, E., Lang, A.G. & Buchner, A. (2007). G*Power 3: A flexible statistical power analysis program for the social, behavioral, and biomedical sciences. *Behavior Research Methods*, 39, 175-191.

6. Faul, F., Erdfelder, E., Buchner, A. & Lang, A.G. (2009). Statistical power analyses using G*Power 3.1: Tests for correlation and regression analyses. *Behavior Research Methods*, 41, 1149-1160.
7. Li, F. & P. Harmer (1996). Confirmatory factor analysis of the group environment questionnaire with an intercollegiate sample. *Journal of Sport Exercise Psychology*, 18: 49-63.
8. Marković, G. (2002). Analysis of the microsocial structure of the junior basketball teams. Master Thesis. Zagreb, Faculty of Kinesiology University of Zagreb, Croatia.
9. Milanović, D. (2013). Teorija Treninga. Zagreb: Faculty of physical education, University of Zagreb.
10. Petrović, K., & Šiftar, N. (1970). Sociometrijska struktura i odnosi u rukometnoj reprezentaciji SFRJ. *Trener*, 7, 22-39.
11. Sindik, J. & Mihaljević, D. (2011). Socioeconomic status and microsocial structure within female handball team. *SportLogia*, 7(2): 151–162.
12. Šimenc, Z. (1985). Analiza mikrosocijalne strukture vaterpolo ekipe metodom multidimenzionalnog skaliranja. Doktorska disertacija. Zagreb: Fakultet za fizičku kulturu.
13. Težak, I. (1986). Homogenost jedne rukometne ekipe u period najveće profesionalne efikasnosti. *Kinesiology*, 18(2): 143-148.

BIOCHEMICAL, HORMONAL AND PSYCHOLOGICAL MONITORING OF EIGHT WEEKS ENDURANCE RUNNING TRAINING PROGRAM IN FEMALE RUNNERS

Irena Auersperger¹, Branko Škof¹, Bojan Leskošek¹, Bojan Knap², Aleš Jerin³, Mitja Lainščak^{4,5} and Tanja Kajtna¹

¹Faculty of Sport, University of Ljubljana, Ljubljana, Slovenia

²Department of Nephrology, University Medical Center Ljubljana, Ljubljana, Slovenia

³Institute of Clinical Chemistry and Biochemistry, University Medical Center Ljubljana, Ljubljana, Slovenia

⁴Division of Cardiology, University Clinic Golnik, Golnik, Slovenia

Applied Cachexia Research, Department of Cardiology, Charité, Campus Virchow-Klinikum, Berlin, Germany

Abstract

Athletes improve performance when optimal balance between training stress and recovery exists. If out of proportion, overtraining syndrome (OTS) can ensue. Currently several biomarkers are used to detect OTS, but none meets all prespecified criteria for definite diagnosis. The purpose of the study was to investigate the effects of eight week endurance running training program on biochemical, hormonal, and psychological parameters in female runners. Seventeen runners were recruited for. The physical training that consisted of two, three-week progressive overload periods, each followed by a week taper period, and concluded with a 10 or 21km competitive run. Samples were taken at six time-points during the eight-week training program: Baseline (Baseline), after the first and second three-week training loads (Load1, Load2), after each taper week (Taper1 and Taper2), and post-study (Recovery). At each testing, the subjects were asked to complete the Recovery-Stress Questionnaire for Athletes (RESTQ). At the completion of the programme significant improvement of physical performance was observed (VO₂max +4.3%; $p = 0.03$). At Recovery the cortisol values significantly decreased compared to Baseline ($p = 0.002$) and to Taper2 ($p = 0.008$). In RESTQ we found that the recovery subscales sum was significantly lower at the recovery period when compared to the second taper period, and self – efficiency increased at Taper 2. We also found significantly higher self – regulation during resting periods when compared to baseline. The main finding of the current study indicates that the performed training was well-balanced between stress and recovery periods, resulting in a positive training effect. It seems that psychological parameters are more sensitive markers than biochemical and hormonal one to detect changes in stress/recovery. The RESTQ may provide a practical tool for recognizing OTS in its early stages.

Key words: training status, RESTQ, biochemistry, overreaching, stress, recovery

THE MORAL POTENTIAL OF SPORT VALUES

Dušan Macura, M. Toni and Mojca Doupona Topič

Faculty of Sport, University of Ljubljana, Slovenia

The social order consists of moral and legal norms. Owing to the excessive volume and inefficiency of legal norms, the moral rules stemming from good customs have also failed. The consequence of this is a crisis of self-image and disturbances in mutual relations. Self-reflection has failed. The attitude towards oneself and the community starts with the attitude towards one's own body. The body is the refuge of all life processes, including social ones. By nature, man is inclined towards moral conduct which a prerequisite for a harmonious co-existence. The problem is that the modern lifestyle which drives man into passivity does not give enough strength to act morally.

Sport values occupy a high functional place in the classification of values. The basic functional unit of sport is physical loading. In sport, self-approval is generated through the overcoming of strain. In sport the slogan "the harder, the better" applies, in contrast to the contemporary consumer maxim "the easier, the better". Sport is the only social activity where competitiveness is clearly and undoubtedly comparable (the same number of players, the same competition conditions etc.). In sport the role of the opponent is clear as the opponent is also important when they lose. The loser verifies the winner (it is impossible to compete without an opponent and there is no winner without a loser). This means that a monopoly is impossible in sport, but what is possible is a privilege which depends on the ranking in a competition. In this way, sport generates samples from the natural order from which moral conduct emanates (morale is a category of natural order). In this respect, sport contributes vitally to the transfer value of physical strength and personal power. It invigorates social competencies and moral fitness.

The contribution analyses the moral potential of sport values in terms of the different meanings and effects of sport as well as positions sport culture within a broader social context. At the same time, it promotes everyday moral conduct in life.

Key words: *values, sport, morale, fitness*

PREVALENCE AND SOCIODEMOGRAPHIC CORRELATES OF YOUTH ORGANIZATIONAL SPORT ENGAGEMENT

Benjamin Perasović, Renata Franc and Marko Mustapić

Institute of Social Sciences Ivo Pilar, Zagreb, Croatia

The main aims of this study are to establish the prevalence of youth organizational sport engagement and to explore the socio-demographic correlates of youth organizational sport engagement. Data was collected in 2012 by face to face interviews, on a two representative probabilistic samples of young persons (16-25 years) on two locations (city districts) in Zagreb (Croatian capital): Podsljeme (N=610) and Peščenica (N=607), total N=N=1217, as a part of international FP7 My Place project. Organizational sport engagement was operationalized by respondent's answers on three questions: are they a member of a sport club, have they participated in an activity arranged by this organisation, and have they done voluntary work for this organisation during the last 12 month before the survey. As socio-demographic correlates of youth organizational sport engagement this study investigates: age, gender, social class, household income, household structure, employment status and respondent's as well as parents' education level. Data showed that sport engagement was more frequent among youths in Podsljeme than youths in Peščenica (33% in Podsljeme and 26% in Peščenica), as well as that organizational sport engagement is most frequent type of youth engagement among 15 analysed, followed by engagement with religious or church organizations (21% in Podsljeme and 15% in Peščenica). In the next section, we present the findings of conducted analysis with regard to the main socio-demographic variables as a source of variation in reported organizational sport engagement among youths. The findings are discussed in the context of availability of sports activities for youths coming from different social backgrounds.

Key words: *youth, engagement, sport, Zagreb, Croatia*

BEGINNINGS OF EDUCATION AND TRAINING FOR CONDUCTING PHYSICAL EDUCATION CLASSES IN CROATIA – 140 YEARS OF TRADITION

Dario Škegro and Zrinko Čustonja

Faculty of Kinesiology, University of Zagreb, Croatia

Abstract

Purpose. The aim of this research is to analyze the activities and the events preceding and enabling to establish system of education and training of personnel for conducting physical education classes in Croatia after introduction of obligatory physical education classes in Croatian education system in 1874. **Methods.** The archival materials, mostly unprocessed until now, of the Croatian State Archives, the Croatian Sports Museum and the National and University Library in Zagreb were used. **Results.** The beginnings of education of physical education (PE) professionals in Croatia are related to the introduction of PE as a obligatory subject into the elementary school curricula in the Kingdom of Croatia, Slavonia and Dalmatia in 1874. Until then PE teaching was mainly optional and delivered by foreign gymnastic teachers (Germans, Austrians, Czechs), who implemented the principles of the German and later Czech gymnastic system. Most of the other teachers in the elementary schools, however, did not have even a minimal knowledge for conducting PE classes nor was there any reference or literature from which they could attain basic knowledge of the prescribed PE curriculum. We recognize two parallel systems of training introduced in 1875. First system was short training courses for elementary school teachers that already taught at the schools. Second was introduction of Gymnastic as obligatory course/subject at the Teachers training schools. Twenty years after the obligatory physical education classes had been introduced into the Croatian schools, Franjo Bučar (1866-1946), after he had returned from his two-year education at the Royal Central Gymnastic College in Stockholm (Sweden) organized and managed a two-year Course for Secondary School Gymnastic Teachers (1894-1896). In fact, it was the first high school (college) of PE in Croatia and in this region of Europe. The curriculum and syllabus, devised by Franjo Bučar, were modern and comparable to any curriculum of the most popular European schools of the time. In the three-semester course thirty attenders (one woman among them – Ivana Hirschmann) took 16 theoretical and practical course subjects. **Conclusions.** Beginnings of education and training of personnel for conducting physical education classes in Croatia was very important not only for the development of physical education but also for the development of sports and exercise movement in Croatia. However, all activities regarding education and training for physical education was also powerfully influenced by political circumstances in the 19th century Croatia.

Key words: physical education, training, education, Croatia, Franjo Bučar

PERSONALITY TRAITS AND REHABILITATION: INFLUENCE ON OUTCOME FOLLOWING ACL RECONSTRUCTION

Paola Vago¹, Francesco Casolo¹, Ferdinando Cereda¹, Monica Gatti¹ and Furio Danelon²

¹*Universita' Cattolica Milano, Italy*

²*Isokinetic Milano, Italy*

Purpose

Rehabilitation following knee ligament surgery in football players and sport active people can last several months till full functional recovery. In this long period the athlete's psychological and motivational attitude impacts on treatment outcome (2,3).

This study explored the relationships between personality traits and indices of rehabilitation to identify the variables that could represent protective and risk factors of the rehabilitation result.

Methods

70 athletes (age 33,68+-10,41, range 15-61 years, 57 males and 13 females) that underwent ACL reconstruction took part to this study. Forty six participants were recreational athletes, 20 at competitive level and 4 at professional level; 41 were football players. The rehabilitation process included sessions in gym, swimming pool and field). Assessment included the time to reach functional targets (walking with crutches, on line running and beginning of on field rehabilitation) and to return to sport. Physical fitness was evaluated with an anaerobic threshold test and with an isokinetic strength test. Functional outcome and level of sport participation were analysed with the International Knee Disease Committee scale (IKDC) and with Tegner scale. All participants completed the Big Five Observer questionnaire (1), testing the main dimensions of personality (Energy/extraversion, Agreeableness, Conscientiousness, Emotional Stability, Mental Openness) through a list of 40 pairs of bipolar adjectives. Results were analysed with parametric and non-parametric statistics.

Results

The "Big five" personological traits were not correlated with treatment outcome but rehabilitation process variables showed the following negative correlations: Energy/extraversion with gym session number ($Rho > 0,05$); Conscientiousness with isokinetic test number ($P < 0,05$); Emotional Stability with gym ($r < 0,01$) and swimming pool session number ($Rho > 0,05$); Mental Openness with gym session number ($r < 0,01$).

Conclusions

There is not a direct link between the "Big Five" and rehabilitation process outcome but energy/extraversion, emotional stability, mental openness and conscientiousness as protective factors for a good rehabilitation attitude.

References

1. Barbaranelli, C., Caprara, G.V. *Eur J Psychol Assess*, 2000; 16:1, 31-43.
2. Langford, J.L. et al. *Br J Sports Med* 2009 43: 377-378
3. Podlog, L., Eklund, R.C. *Psychol Sport Exerc* 2007;8:535-66.

ANALYSIS OF MOTIVATION OF MEXICANS TOWARDS SPORT

Jesús Viciano¹, Humberto Blanco Vega², José R. Blanco Ornelas^{2,3}, Martha Ornelas Contreras² and Daniel Mayorga-Vega¹

¹University of Granada, Granada, Spain

²Autonomous University of Chihuahua, Chihuahua, Mexico

³Autonomous University of Nueva León, Nueva León, Mexico

Abstract

Purpose: The main purpose of the present study was to analyze the influence of motivation toward sport on physical activity levels among Mexican undergraduates that frequently practice sport. **Methods:** A sample of 650 Mexican university students (477 males and 174 females) from 18 to 36 years of age (20.79 ± 2.4 years) participated in the present study. All the participants practiced sport habitually, at least for four hours a week. The participants completed the Spanish version of the questionnaires *Sport Motivation Scale* (SMS) validated by Núñez, Martín-Albo, & Navarro (2007) and *International Physical Activity Questionnaire* (IPAQ, self-administrated short version: Craig et al., 2003). **Results:** The cluster analysis identified two motivational profiles: “High motivation toward sport” ($n = 376$) and “Moderate motivation toward sport” ($n = 274$). Subsequently, the results of the one-way multivariate analysis of variance, followed by the one-way univariate analyses of variance, showed that the “Moderate motivation toward sport” profile reported lower values of vigorous physical activity than the “High motivation toward sport” profile (Table 1). **Conclusions:** Due to the verified influence of the motivation toward sport between habitual sport undergraduates on the vigorous physical activity practiced, the motivation toward sport should be taken into account by coaches and Physical Education teachers in order to promote physical activity among undergraduates.

Table 1: Multivariate analysis about weekly physical activity levels in the two clusters obtained

	High motivation toward sport ($n = 376$)	Moderate motivation toward sport ($n = 274$)	F	p
			3.018	.018
Vigorous (min)	607.0 \pm 320.8	523.5 \pm 312.8	10.961	.001
Moderate (min)	430.8 \pm 339.6	407.2 \pm 338.1	.764	.383
Light (min)	526.5 \pm 402.1	497.2 \pm 387.9	.869	.352
Seated (min)	306.7 \pm 124.3	300.6 \pm 109.3	.424	.515

Acknowledgements

We thank Aliisa Hatten for the revision of the English language. This study is part of a project funded by the *Secretaría de Educación Pública-Subsecretaría de Educación Superior-Dirección General de Educación Superior Universitaria de México* [Mexican Ministry of Education-Department of Higher Education-General Directorate of the University Education] (OF-13-6894). The fifth author is supported by a research grant from the Spanish Ministry of Education, Culture and Sport (AP2010-5905).



**7th INTERNATIONAL
SCIENTIFIC
CONFERENCE ON
KINESIOLOGY**

**FUNDAMENTAL
AND APPLIED
KINESIOLOGY – STEPS
FORWARD**

Kinesiology in Physical Conditioning

Editors:

**Prof. Igor Jukić, PhD
Cvita Gregov, PhD**

Peer Reviewers:

**Kemal Idrizović, PhD
Luka Milanović, PhD
Daniel Bok, PhD**



NONLINEAR PERIODIZATION: RESEARCH AND PRACTICE

Steven J. Fleck

*Associate Professor and Chair Health, Exercise Science and Sport Management
University of Wisconsin-Parkside, Kenosha, Wisconsin, USA*

Periodization of weight training is the manipulation of acute training variables over time in an attempt to bring about optimal training adaptations. There are several types of weight training periodization that have been examined in the scientific literature. Linear periodization follows a general pattern of increasing training intensity and decreasing training volume as training progresses. Planned changes in training volume and intensity can occur due to manipulating the weight lifted, number of repetitions performed per set and number of sets of each exercise performed. However, manipulation of training can also include changes in any of the acute training variables, including the choice of exercise performed, rest periods between sets and exercises, and the number of training sessions performed per week. Daily nonlinear periodization is a relatively new type of resistance training periodization and has gained popularity among athletes and fitness enthusiasts. Although there are several manners in which training intensity and volume can be manipulated with daily nonlinear periodization there are typically three training zones that are changed on a training session by training session basis. Although any number of repetitions could be used in a training zone typical training zones are 4-6, 8-10 and 12-15 repetitions per set. In most daily nonlinear studies to date a total body weight training program has been performed three days per week with each of the three training zones used one day per week. For example, Monday 8-10, Wednesday 12-15 and Friday 4-6 repetitions per set. Additionally, although not examined in studies to date exercise choice, rest period length, number of training sessions per week and other acute training variables can be manipulated in a daily nonlinear periodization training model. Studies to date demonstrate daily nonlinear periodization can be safely performed in various populations, including children to seniors, and that it is effective in bringing about training adaptations in all of these populations. Studies have reported significant increases in strength, power, motor performance and lean body mass as well as positive effects on the blood lipid profile. This presentation will review the peer-reviewed studies in which the effects of daily nonlinear periodization have been examined and the results explored. Additionally, how to implement a daily nonlinear periodization program will be discussed and described.

RELATIONS BETWEEN FUNCTIONAL MOVEMENT SCREEN AND STANDING LONG JUMP IN CHILDREN

Tea Bešlija, Ana Kezić and Mario Tomljanović

Faculty of Kinesiology University of Split, Croatia

Abstract

The aim of this study was to determine the possible correlation between FMS (functional movement screen) test and the test Standing long jump, in children age 8-10. The total sample of children, 40 of them (20 boys and 20 girls) underwent the test, all training in a karate school on average 2.4 years. FMS was evaluated through the Deep Squat test through videotaped material; while the jump was estimated through the Standing long jump (SLJ) test, the results used were means of all three attempts. Three independent judges estimated the FMS Deep Squat test through four variables on a scale of 0-2. Regarding the values of Cronbach's alpha coefficient (0,98) we conclude that FMS as instrument is reliable, also with the high Cronbach alpha coefficient values (0,90) we conclude that the SLJ test is reliable for children age 8-10. The correlation test analysis of these two variables has shown low correlation between variables ($r=0,36$). The authors assume that more tests should be added evaluating the explosive leg power in a jump, which would in turn give better and more relevant output, and improvement of technique should be estimate.

Key words: Functional movement screen, explosive power, standing long jump, children

Introduction

Functional movement screen (FMS) is one of more popular theme and therefore attracts attention and discussion. FMS is a tool we use as a predictive mean where an individual result shows us the state of our athletes. The result is obtained based on 7 individual tests marked on a scale of 0-3 competent assessors. FMS tests are: Deep Squat, Hurdle Step, In Line Lunge, Shoulder Mobility, Active Straight Leg Raise, Trunk Stability and Rotary Stability. First introduction to FMS was made by Gray Cook in two parts: Cook at al (2006) – introduced the Functional Movement Screen (FMS) for the first time. They suggest that any pre-participation screening protocol should address possible “functional movement deficits” in athletes, which they believe may limit performance and predispose the individual to micro-traumatic injury. Additionally, the researchers describe three of the seven movements contained within the FMS, the Deep Squat, the Hurdle Step and the In-Line Lunge. The second part of the research came later: Cook at al (2006); the researchers described the remaining four of the seven movements contained within the FMS, Shoulder Mobility, Active Straight Leg Raise, Trunk Stability Push-Up, and Rotary Stability tests. In summary, the FMS has been proposed as a method for identifying athletes who use sub-optimal movement patterns during their sporting activities that are both inefficient and injurious. However, when we want to determine the prediction of injury based on the FMS test results we get different results: Kiesel at al (2007) – prospectively tested whether FMS score and FMS score asymmetry were correlated with time-loss musculoskeletal injury during the pre-season in 238 professional American football players. Additionally, they found that those players who exhibited >1 asymmetry displayed a 1.80 times greater risk of time-loss musculoskeletal injury than those who exhibited no asymmetries; O'Connor at al (2011) –investigated whether FMS scores were able to predict injury in a two-part cohort of 874 Marine officer candidates. At the and they reported that a score of ≤ 14 on the FMS was associated with a 1.65 times greater risk of injury in the long-cycle group and a 1.91 times greater risk of injury in the short-cycle group.

In summary, in the 8 trials that have assessed correlations between athletic performance and FMS sum scores, only 2 have found any correlation between athletic performance and FMS score. Both of those trials found some degree of correlation between countermovement jump performance and FMS sum score. This suggests that either the FMS does not detect detrimental compensation patterns or that the compensation patterns that it does detect are not detrimental to performance. Benz at al (2010) investigated the relationship between FMS score and performance in 4 athletic performance tests in 50 male high school football players (age 15.4 ± 1.1 years). The 4 athletic performance tests were the countermovement jump, 40-yard sprint, T-test, and overhead medicine ball throw. The researcher reported a significant correlation between the total FMS score and the countermovement jump; Parchman at al (2011) investigated the correlation between FMS scores, normalized 1RM squat and athletic performance in 25 National Collegiate Athletic Association Division I golfers (15 males and 10 females), normalized 1RM squat was significantly correlated to 10 m sprint time, 20m sprint time, vertical jump height, agility T-test time and club head velocity. The researchers concluded that the FMS does not differentiate between athletes on the basis of any aspect of athletic performance.

The aim of this study was to determine a correlation between the FMS Deep Squat test and Standing long jump in children age 8-10. Authors suggest high correlation between these two variables due to very similar movement structures, i.e. Standing long jump as the manifestation of a squat also estimated in the “Deep Squat” test, although the technical performance of the jump is not considered, only the final result.

Methods

Participants

The study included 40 children age 8-10, of which 20 boys and 20 girls. All children are members of the Karate club “Obi” from Split and are under the karate treatment on average 2.4 years (training three times a week). The parents gave their consent for all the children to participate in this study.

Measurements

For the FMS test we used only one of the 7 tests – “Deep Squat”. According to Bešlija and al (2012) this test is valid for children age 7-10. Three different judges have evaluated the performance of the squat in four different variables grade 0-2 through videotape material. Grade 0 - if the criteria are not met, grade 1 – if there is a marginal form of satisfying the criteria and score 2 – if the criteria are fully met. Variable Standing long jump was evaluated in the Karate gym with adjusted karate pad, the test subjects performed the test barefoot through three attempts. Only the results of the mean of all three attempts were processed.

Data analysis

After we calculated the Cronbach alpha coefficient for the judge objectivity assessment in all four variables of the “Deep Squat” test, Kolmogorov Smirnov test was calculated for normality of distribution. Also descriptive statistics were used to show mean, standard deviations, minimum and maximum result for the entire sample, and separately for boys and girls. According to the given aim we used Paerson correlation analysis to determine the connection between the results of the judges grades and the Standing long jump result (mean result) with a set statistical significance of $p < 0.05$.

Results

The high Cronbach alpha coefficient (0.98) score among the judges implies good judge objectivity in the “Deep Squat” test, while according to the Kolmogorov-Smirnov test there is no difference between the observed and expected distribution ($p < 0.05$). Also the calculated Cronbach alpha coefficient for reliability with the Standing long jump indicates high level of reliability (0.90).

Table 1 shows results of means, minimum and maximum scores, standard deviations, Cronbach alpha coefficient and K-S test for the entire sample in two variables: SLJ- standing long jump, and JDS- judge evaluation in test Deep squat (J1DS- first judge, J2DS- second judge, J3DS- third judge)

Table 1

	MEAN	MIN	MAX	SE	CRONBACH ALPHA	K-S
SLJ/1	144,97	92,00	207,00	28,34	0,90	0,97
SLJ/2	149,15	90,00	208,00	27,53		
SLJ/3	149,29	99,00	211,00	28,35		
J1DS	4,50	0,00	8,00	2,23	0,98	0,08
J2DS	4,35	1,00	7,00	1,73		
J3DS	3,77	0,00	8,00	2,51		

With the aim of this work in mind which was to determine whether there is a correlation between the FMS test Deep Squat and Standing long jump in children age 8-10 we can say the correlation is statistically significant ($p < 0.05$), while the correlation coefficient is low ($r = 0.35$) which at the same time tells us of the small correlation between these variables.

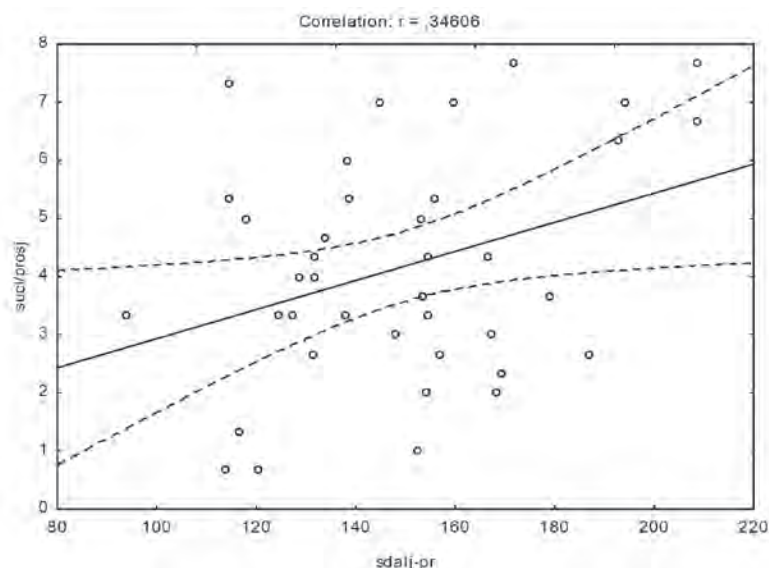

Figure 1: Graphic analysis of the correlation between the judges' results, and the mean results of Standing long jump.

Discussion and conclusions

Based on the obtained results we can conclude that the judges showed good objectivity in their grading of the FMS test “Deep Squat”, and also based on the results of the K-S test of the normality of distribution in both variables (FMS test and Standing long jump test). Hence based on the Cronbach alpha coefficient (0.98) of the average result of the Standing long jump we can say the test was reliable. According to the results of the correlation analysis between the above mentioned two variables we can safely say that the results are statistically significant ($p < 0.05$), however, according to the result of the correlation coefficient ($r = 0.346$) we are not talking about a high correlation, on the contrary we're talking about a low correlation between variables. Most of the research is related to athletes, while there is no research with children which could confirm or refute this work's hypothesis. Although, some other researchers (Conlon et al 2013) found that there was a positive correlation between FMS score and countermovement jump height; The researchers (Lockie, 2013) concluded that scoring on some of the FMS movements was associated with performance in team sport athletes and this was most obvious in respect of the deep squat, which correlated with multi-directional speed and power. However there is correlation between FMS and tests of all kind of jumps, in all kind of ages, and sports. We can say that the mobility of joints is only one part of the result which evaluates the explosive leg power. Further study should take into consideration more tests for the estimation of the explosive power in order for the results to be more objective and to be able to consider, with certainty, the correlation of the FMS test “Deep Squat” and the explosive leg power (all kind of jumps).

The assumptions of the authors are that during the preparation of the Standing long jump the movement of the Squat manifests itself. For that reason alone they have decided on this particular type of research. However the obtained results show that it was not sufficient to take into consideration only the results of the jump. With the improvement of technique it is assumed that the results would also improve, but this would have no influence on the improvement of the FMS test “Deep Squat” results. The connection exists, and that was also proved from the kinesiology point of view, in order to achieve the best result in the Standing long jump the results of the FMS test “Deep Squat” have to be satisfactory (mobility of joints, hip mobility...) of course the other factors are considered here which clearly prevail in obtaining results of the jump, through which the explosive leg power manifests itself.

References

1. Cook, G., Burton, L., & Hoogenboom, B. (2006). Pre-participation screening: The use of fundamental movements as an assessment of function—part 1. *North American journal of sports physical therapy: NAJSPT*, 1(2), 62.
2. Cook, G., Burton, L., & Hoogenboom, B. (2006). Pre-participation screening: The use of fundamental movements as an assessment of function—Part 2. *North American journal of sports physical therapy: NAJSPT*, 1(3), 132.
3. Kiesel, K., Plisky, P., & Butler, R. (2011). Functional movement test scores improve following a standardized off-season intervention program in professional football players. *Scandinavian journal of medicine & science in sports*, 21(2), 287-292.
4. O'Connor, F. G., Deuster, P. A., Davis, J., Pappas, C. G., & Knapik, J. J. (2011). Functional movement screening: predicting injuries in officer candidates. *Med Sci Sports Exerc*, 43(12), 2224-30.
5. Parchmann, C. J., & McBride, J. M. (2011). Relationship between functional movement screen and athletic performance. *The Journal of Strength & Conditioning Research*, 25(12), 3378-3384.
6. Bešlija, T.; Krespi, M.; Kezić, A.; Jukić, T. Analiza funkcionalnosti kretanja kod djece primjenom “functional movement screening”-a. *Proceedings book of 4th international scientific conference “Contemporary Kinesiology” 2012*. Split, 2012. 92-96

THE EFFECTS OF A TRAINING PROGRAM FOR THE DEVELOPMENT OF STRENGTH AND POWER IN JUNIOR BASKETBALL PLAYERS

Mate Brekal¹, Dragan Milanović¹ and Petra Zaletel³

¹University of Mostar, Faculty of Science and Education – Physical education, Bosnia & Herzegovina

²University of Zagreb, Faculty of Kinesiology, Zagreb, Croatia

³University of Ljubljana, Faculty of Sport, Ljubljana, Slovenia

Introduction

At the present stage of sport's development, strength training is becoming one of the most important parts in the process of creating athletes. Knowing that our every movement requires, to some extent, the production of strength and force in skeletal muscle, we can say that, with high quality technology, strength will be a prerequisite for top performance. All team sports, including basketball, where instantaneous power dominates, rely on a solid development of strength and power. First we need to clear what we mean by the term of strength and then the notion of power. Strength is the largest voluntary muscular force which athlete can produce in dynamic or static mode of muscular work, while, e.g. lifting heavier weights (1RM; dynamic power) or attempting to lift weights that the athlete is unable to move (static strength) (Milanovic, 2009). Power can be defined the same as the strength, but under the condition that the athlete generates maximum muscle force in the shortest possible time (Milanovic, 2009).

The methods of strength training with clearly defined loads, number of repetitions, number of series, rest intervals, rhythm of performance, depend on needs and specificities of certain sports.

We often ask the question: Do we dedicate enough time and attention to the development of the strength and power, and whether many of us still have prejudices about how much, how and when to begin to train these skills.

According to Bompa 2006, with usage of some strength development methods progress is eight to twelve times faster than when you only exercise movements used in a particular sport.

Many studies in the domain of power administrate the positive effects of such training in many sports. In addition to the positive effects that we achieve with strength and power training that are related to quality of individual technical and tactical element performance itself, power training has a positive effect on the prevention of injuries (Faigenbaum i Schram, 2004; Bilchek, 1989), as well as on the general health promotion (Faigenbaum, 1993; American Academy of Pediatrics, 2001), the psychosocial features, such as self-confidence and self-esteem and mental health (Faigenbaum, 1995; Faigenbaum et al., 1997).

According to all the positive effects of strength and power training, remains the fact that in our country these programs in team sports are still not sufficiently represented. When we talk about fitness training, including strength and power training of younger age categories, studies which indicate that fitness training, i.e. strength and power training do not negatively affect the growth, hormonal status and maturation process, are of special interest. (Welterman et al., 1986, Ramsey et al., 1990, Sailors and Berg, 1987, Siegel et al., 1989, Thaintz et al., 1994, all according to Haff, 2003). We should mention that the programs for strength and power development in junior and senior age should be exclusively developmental. With appropriate training program, adequate contents and training loads, we will help young athletes to engage with high quality and earlier in regular senior program, which is the main task of training the younger age categories in elite sports. In this paper we want to emphasize the importance of basic or general strength, which should be a prerequisite for better neuromuscular coordination, specific strength, and reduction of number and severity of locomotor apparatus injuries and also have a positive impact on mental status of young athlete.

The objective of this study is to determine the impact of specifically programmed training during one year cycle on changes in some strength and power assessment tests in basketball players of junior and younger senior age.

Methods

Sample of subjects

The sample of subjects included 17 basketball players of junior age HKK "Široki" from Široki Brijeg, Bosnia and Hercegovina, 16 to 18 years old. All respondents are physically healthy, with no visible functional, motor and psychological deviations. Prior to program implementation, 13 respondents were not systematically involved in serious fitness program, while 4 respondents conducted fitness program for a period of 4 months, 2 times a week. All together were involved in regular basketball training one to three years.

Sample of variables

The battery of tests which monitored the progress in strength and power dimensions consisted of 8 items. Four items estimated maximum strength (barbell bench press, barbell shoulder press, squat, deadlift), three items for relative repetitive strength assessment (dips-chest version, pullups and 3/4 Sit-Ups) and one item for absolute explosive strength assessment (power clean). As a special variable we also recorded gain of body mass throughout annual training cycle.

Experimental procedure

The entire procedure was conducted in the period from 2nd of June 2008 to 11th of June 2009 in Široki Brijeg. Planned and implemented macrocycle consisted of 376 days, 169 days of training, 169 training units, i.e. 211 hours of training total. Three cycles were planned in terms of training load: first – an introductory cycle lasted for four months and within the emphasis was on the adoption of the techniques with the use of minimum and medium external loads and improvement of relative repetitive strength, the second – an adaptation also lasted for four months and moderate loads were used and the third – the main cycle, which lasted for five months with a combination of moderate and high loads.

In mesocycle from 9th of July 2008 to 11th of August 2008, due to the closure of the hall and collective vacation of all employees in the club, the players were free i.e. they did carry out training under supervision. During this period, their task was to implement fifteen training units (three per week) which they received in writing. Each unit consisted of training activities for core strengthening and push-ups.

Trainings were conducted four times within weekly microcycle for one hour and fifteen minutes; one group of players in the morning before individual basketball training and the other in the evening before the team basketball training. Groups were changing shifts every week due to school obligations.

Each individual training consisted of two segments: the first – introductory part, where the activities for core strengthening, dynamic and static (stabilization exercises) character were represented and the second – main part where predominantly bodybuilding and hard athletic technology activities were represented. Individual training was carried out through the cellular methodical form of training with programmed pauses between sets of 40 to 60 sec. (in the third cycle 60 to 90 sec), changes between exercises 90 to 120 sec. Due to the limited time interval (one hour and fifteen minutes), due to better focus on training as well as increasing the intensity of individual training, minimum three (3) training tasks, 6 or 7 of them were performed with additional exercise.

Macrocycle; season 2008/2009; HKK Široki II

ANNUAL TRAINING CYCLE (refers only to the training in the gym)															
MONTHS	13	VI	VII	VIII	IX	X	XI	XII	I	II	III	IV	V	VI	
CYCLES	3	Introductory				Adaptation				Main					
PERIODS	4	Transitional period		Preparatory period			Competitive period							Transit period	
1. Number of days	376	29	31	31	30	31	30	31	31	28	31	30	31	12	
2. Number of training days	169	13	5	12	13	14	12	10	16	16	18	17	17	6	
3. Number of resting days	208	17	26	19	17	17	18	21	15	12	13	13	14	6	
4. Number of trainings	169	13	5	12	13	14	12	10	16	16	18	17	17	6	
5. Training duration – hrs & min.	211:15	16,15	6,15	15	16,15	17,30	15	12,30	20	20	22,30	21,15	21,15	7,30	
6. Duration of individual training		1,15	1,15	1,15	1,15	1,15	1,15	1,15	1,15	1,15	1,15	1,15	1,15	1,15	
7. Intensity of load - %	72	40	40	60	60	80	80	60	80	90	90	95	95	80	

WEEKLY TRAINING MICROCYCLE							
	Monday	Tuesday	Wednesday	Thursday	Friday	Saturday	Sunday
MORNING	group 1 ST-7:45-9:00 IBT-9:00-10:00	group 1 ST-7:45-9:00 IBT-9:00-10:00	Pause	group 1 ST-7:45-9:00 IBT-9:00-10:00	group 1 ST-7:45-9:00 IBT-9:00-10:00	Pause	Pause
AFTERNOON	group 2 TS-18:45-20:00 KBT-20:00-22:00	group 2 ST-18:45-20:00 KBT-20:00-22:00	Pause	group 2 ST-18:45-20:00 KBT-20:00-22:00	group 2 ST-18:45-20:00 KBT-20:00-22:00	Pause	Pause

ST-strength training, IBT-individual basketball training, KBT-collective basketball training

Along with a programmed training program it is important to say that all players were eating in the club's restaurant, according to pre-planned menu and taking oral supplements like vitamins, minerals, carbohydrate and proteins. The content of the introductory part of the training conducted sixteen units of training, after which it was changed and so on until the end of mentioned macrocycle. Within there were represented activities for strengthening bottom, side an upper abdominal muscles, lumbar part of the back, strengthening and flexibility of inguinal region and torso stabilization. In the main part of the training in the first period – introductory, exercises for development of relative repetitive strength, absolute strength but with small external loads with adoption of proper technique and performance elements of heavy athletic training technology and bodybuilding (power clean, snatch) were performed. In the second part – adaptation, we continued with relative repetitive strength exercises, however the loads were increasing in the training operators in both bodybuilding and heavy athletic technology. In the third – main period mostly were performed activities of bodybuilding and heavy athletic training technology.

Presentation of evidential list of weekly training in the main period

MONDAY

No.	CONTENT		DOSAGE			
	Main exercise	Supplemental exercise	bp/kg	bp/kg	bp/kg	bp/kg
1.	Barbell squats		6	6	6	6
2.	Step ups with a jump	Bench press (3-4p)	7+7	7+7	7+7	
3.	Barbell lunge		12	12	12	
4.	Box jumps	Balance board (40")	10	10	10	
5.	Incline bench press	Barbell curl (10p)	6	6	6	6
6.	Wide push ups	Dumbb. alternate bic. curl (10p)	20	20	20	

TUESDAY

No.	CONTENT		DOSAGE			
	Main exercise	Supplemental exercise	bp/kg	bp/kg	bp/kg	bp/kg
1.	Preexerc. for power clean*	Dips (20-3s)				
2.	Pull ups	Power clean from knee(4)	14	14	12	12
3.	Seated barbell shoulder press		6	6	6	6
4.	Standing barbell upright row	Standing dumb. calf raise(16)	8	8	8	
5.	Standing dumbbell lateral raise		8	8	8	8
6.	Lying triceps french press with bar		10	10	10	10

THURSDAY

No.	CONTENT		DOSAGE			
	Main exercise	Supplemental exercise	bp/kg	bp/kg	bp/kg	bp/kg
1.	Bench press	Barbell squats(6)	3-4	3-4	3-4	3-4
2.	Incline bench press –narrow grip	Barbell curl, wide grip(10)	6	6	6	6
3.	Dumbbell split-squat		12	12	12	
4.	Leg extension	Leg flexion on fit ball (8)	10	10	10	
5.	Dips, fast	Stan.dumb.curl hammer grip(10)	16	16	16	
6.	Lying triceps french press with bar		10	10	10	10

FRIDAY

No.	CONTENT		DOSAGE			
	Main exercise	Supplemental exercise	bp/kg	bp/kg	bp/kg	bp/kg
1.	Preexerc.for power clean*	Pull ups (12)				
	Power clean from knee		3	3	2	2
2.	Seated barbell shoulder press	Seated pulley row(8p)	6	6	6	6
3.	Dead lift		6	6	6	6
4.	Standing dumbbell lateral raise		10	10	10	10
5.	Squat-jump with weights	Vencal jumps (8p)	6	5	4	
6.	Barbell step ups	Explosive push up (8-3s)	5+5	5+5	5+5	

Data processing methods

Statistical analysis was conducted by applying the statistical software Statistica for Windows (version 8.0). Methods of data processing included calculation of basic statistical parameters for all four measuring and determine the normality of distribution with K-S test. Analysis of differences and the effect of training program between 4 time points were established with analysis of variance (ANOVA) for repeated measures and the differences between transitive conditions were verified with Bonferroni post - hoc test.

Results and discussion

Analysis of distribution parameters indicates that none of the variables have significant deviations from normal distribution. Thus planned training program, because of relating to basketball training, has aroused suspicion to what extent it will be effective from the point of development of observed dimensions as well as from the point of situational effect. However, the results obtained indicate significant effects of treatments in strength and power domain. In all variables observed significant difference between measures was noted ($p < 0.01$), i.e. there was a statistically significant increase in results in all variables (Table 2.). The effect size or the size of the effect of a particular treatment, (according to Cohen. J., 1992) indicates a large effect of the treatment in all variables, especially in those where maximum strength and power was tested through 1RM. We conclude that the treatment had positive effects on strength and power development in young athletes.

Table 2: Results of analysis of variance (ANOVA) for repeated measures

	<i>F</i>	<i>p</i>	<i>Partial eta squared</i>	<i>Power</i>	<i>Sphericity</i>	<i>G-G (p-level)</i>	<i>Hotteling's</i>
barbell benchpress	106,96	0,00	0,88	1	0,00	0,53 (0,00)	9,74 (0,00)
dips-chest version	74,72	0,00	0,83	1	0,00	0,41 (0,00)	5,66 (0,00)
Pull ups	48,04	0,00	0,76	1	0,00	0,51 (0,00)	4,22 (0,00)
Barbell shoulderpress	131,09	0,00	0,90	1	0,36		
3/4Sit-Ups	63,11	0,00	0,81	1	0,04	0,67 (0,00)	6,76 (0,00)
Deadlift	96,16	0,00	0,86	1	0,00	0,49 (0,00)	8,26 (0,00)
Squat	110,2	0,00	0,88	1	0,27	0,61 (0,00)	12,47 (0,00)
Power clean	95,2	0,00	0,86	1	0,02	0,64 (0,00)	17,91 (0,00)
Body mass	29,46	0,00	0,66	1	0	0,44 (0,00)	3,24 (0,00)

Legend: *F* – *f* value, *p* – level of statistical significance, *Partial eta-sqr.* – effect size, above 0.15 is large (by Cohen, 1988), *sphericity* ($e < 0.7$), *Hotteling* ($p < 0,05$).

The benefits which arise from improving strength and power are numerous. They refer to the quality of performing technical and tactical elements, the prevention of injuries (Faigenbaum and Schram, 2004), the general health promotion (Faigenbaum 1993, the American Academy of Pediatrics, 2001) the psychosocial features, such as self-confidence and self-esteem and mental health as well (Faigenbaum 1995; Faigenbaum et al., 1997). Strength and power as prerequisites for raising to a higher level and other abilities, can be developed through multiple approaches not just in conventional way. Thus McDonald C.J., H.S. Lamont Garner and J.C. (2010) were researching the influence of traditional resistance training, plyometric training and complex training (combination of heavy athletic and light athletic training technologies within one training session) within strength and power domain and anthropometry. Six-week program was performed by 30 students twice a week. Progress was noted in the tested dimensions of strength (squat, Romanian deadlift, standing calf raise) but not the difference between the groups. Also, Mangine G. T. et al. (2012) in the study that lasted for eight weeks (three training per week, 17 entities) proved that the development of maximum strength and power are equally influenced by the classical method of training and training in which conventional and ballistic training are combined.

Detailed view of differences, i.e. trend changes throughout four time points, separately for each variable: pullups, barbell bench press, 3/4 Sit-Ups, dips-chest version, power clean, barbell shoulder press, squat, deadlift, , body mass.

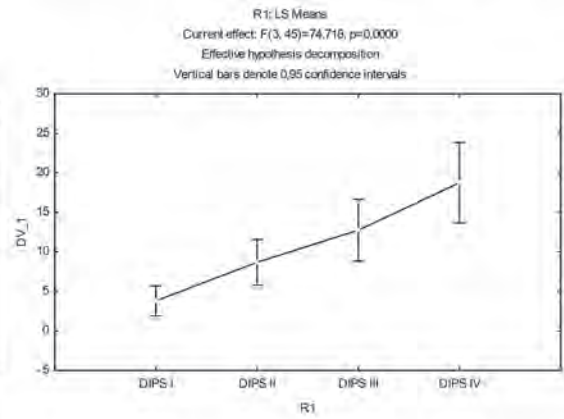
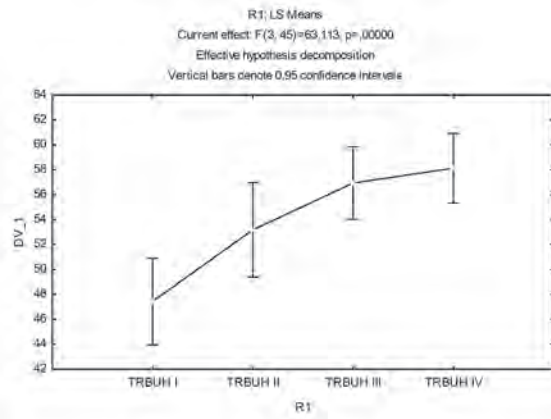
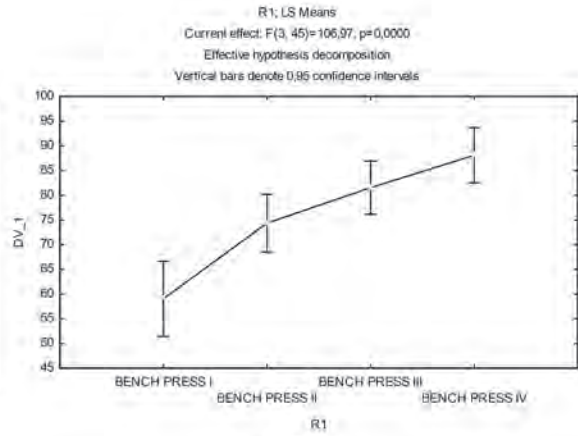
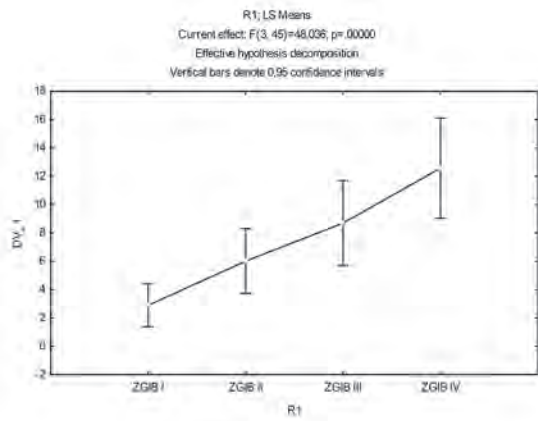
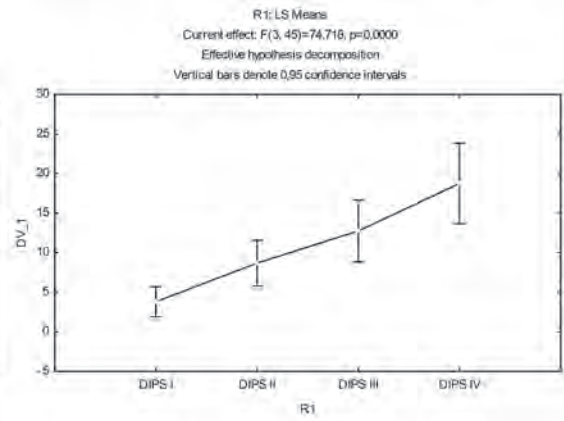
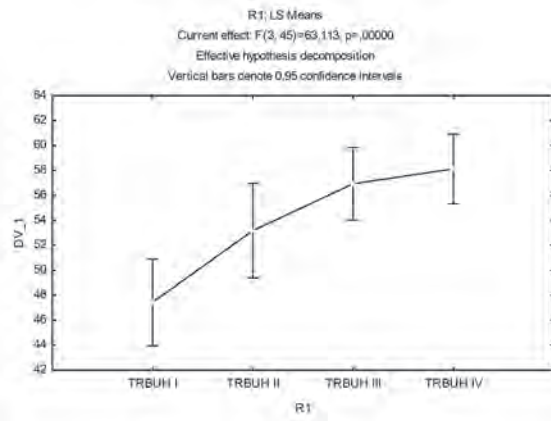
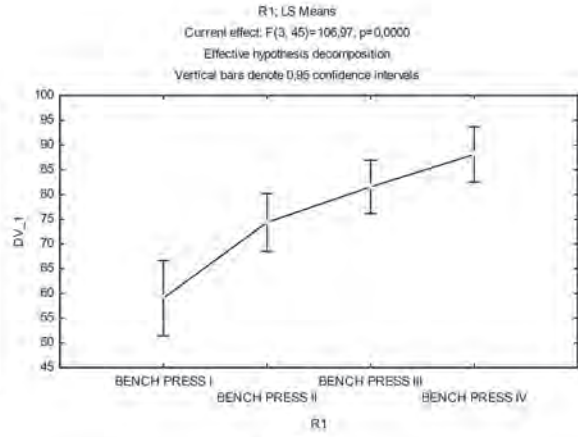
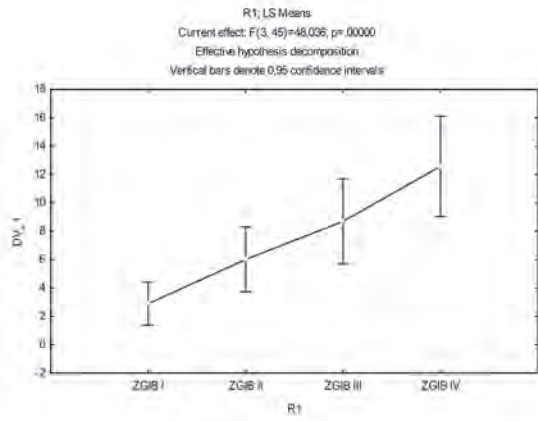

There are differences between all the states individually ($p < 0.05$) in all variables except for 3/4 sit-ups and body mass. In these two variables, the difference between the third and fourth measuring is insignificant. In the first variable, 3/4 sit-ups, the cause may be: the results achieved on the third testing were high and further increase of the result value was hard to expect. The stagnation in increasing body weight between the third and fourth measuring occurred intentionally because planned weight gain in the annual cycle (6-10 kg) in certain number of players have already been achieved.

Conclusion

Knowing that the goal of fitness training is enhancing working abilities and developing strong psychological profile (Bompa, 2006) then strength and power training should be singled out as one of essential parts of this training. There are numerous positive effects that such training produces starting with general health promotion (Faigenbaum 1993, the American Academy of Pediatrics, 2001), the quality of certain technical and tactical element performance, injury prevention (Faigenbaum and Schram, 2004; Bilchek, 1989), psychosocial features such as self-confidence and self-esteem, and mental health as well (Faigenbaum, 1995; Faigenbaum et al., 1997).

In our environment, there is still a lot of prejudices and misconceptions when it comes to strength and power training which is often, as such, in team sports, neglected or underused. The idea of this type of training is usually stereotyped i.e. implies conventional training method. This type of training, according to author, should be an unavoidable part of the training practice for junior age, however, it should be emphasized that other programs can influence this domain (strength and power).

Transformations achieved in one year training cycle have largely contributed to the success of these selections (winning the junior titles BiH), and were key detail in the further selection of professional, senior drive. Players, who have passed the selection and signed professional contract, achieved the best results in the majority of tests for strength and power assessment. Applying such type of training, players adapted faster and easier to the physical demands set by regional basketball league – the ABA, and has helped in achieving objectives and results of the club.

References

1. Bompa, T. (2006). *Periodizacija – teorija i metodika treninga*[Periodization – theory and methodology of training]. Zagreb: Hrvatski košarkaški savez.
2. Cohen, J. (1992). Statistics a power primer. *Psychological Bulletin*, 112, 155-159.
3. Cormie, P., McGuigan, M.R., Newton, R.U. (2011). Developing maximal neuromuscular power: part 2 – Training considerations for improving maximal power production. *Sports Med*, 41(2), 125-146.
4. Haff, G.G. (2003). Roundtable discussion: Youth resistance training. *Strength and Conditioning Journal*, 25(1), 49-64.
5. Faigenbaum, A.D. (1995). Psychosocial Benefits of Prepubertal Strength Training. *Strength and Conditioning Journal*, 17(2), 28-32.
6. Faigenbaum, A.D., Zaichkowsky, .D., Westcott, W.L., Long, C.J., LaRosa-Loud, R., Michelli, L.J., Outerbridge, A.R. (1997). Psychological effects of strength training on children. *Journal of Sports Behavior*, 20(2), 164-175.
7. Faigenbaum, A.D. (1993). Strength training: A guide for teachers and coaches. *Strength and Conditioning Journal*, 15(5), 20-29.
8. Faigenbaum, A.D., Schram, J. (2004). Can resistance training reduce injuries in youth sports? *Strength and Conditioning Journal*, 26(3), 16-21.
9. Faigenbaum, A.D., Kramer W.J., Blimkie C.J.R., Jeffreys, I., Micheli, L., Nitka, M., Rowland T.R. (2009). Youth resistance training: Updated position statement paper from the National Strength and Conditioning Association. *Journal of Strength and Conditioning Research*, 23(5), 60-79.
10. MacDonald, C.J., Lamont, H.S., Garner, J.C. (2012). A comparison of the effects of six weeks of traditional resistance training, plyometric training and complex training on measures of strength and anthropometrics. *Journal of Strength and Conditioning Research*, 26(2), 422-431.
11. Maffulli, N., Pintore, E., (1990). Intensive training in young athletes. *Sports Med*, 24(4), 237-239.
12. Mangine, G.T., Ratamess, N.A., Hoffman, J.R., Faigenbaum, A.D., Kang, J., Chilakos, A. (2008). The effects of combined ballistic and heavy resistance training on maximal lower and upper body strength in recreationally trained men. *Journal of Strength and Conditioning Research*, 22(1), 132-139.
13. Milanović, D. (2010). *Teorija i metodika treninga*. [Theory and methodic of training] Zagreb: Kineziološki fakultet Sveučilišta u Zagrebu.
14. Santos, E., Janeria, M. (2009). Effect of reduced training and detraining on upper and lower body explosive strength in adolescent male basketball players. *Journal of Strength and Conditioning Research*, 23(6), 1,737-1,744.
15. Zatsiorsky, V.M., Kraemer, W.J., (2006). *Science and practice of strength training* (2. izd.). Champaign, IL: Human Kinetics.

EFFECTS OF PLYOMETRIC TRAINING ON EXPLOSIVENESS AMONG JUNIOR FOOTBALL PLAYERS

Marin Dadić, Luka Svilar and Luka Milanović

Faculty of Kinesiology, University of Zagreb, Croatia

Introduction

When we compare sports games several decades ago and today we can conclude that many things related to motor abilities and skills have changed. Football field covers a large space but in order to make an advantage for a planned action sometimes it is enough to be half step “faster” than your opponent. Football game is very complex game where physical capacity, motor skills and abilities together can differentiate success between the players and teams. Even though tactical part of the game has tremendously developed, we can also state that field of physical conditioning of athletes plays a very important role in a modern training periodization. Time reaction, acceleration, power and agility are probably one of the most important abilities that lead to success. Thus it is important that coaches know how to reach peak performance with all of their athletes on the team. For previous reasons all of the methods that lead to explosiveness development should be a part of a daily training regime.

Plyometric training method (also known as a “shock method”) has been confirmed by many different studies as a very efficient tool for development of motor abilities such as power and explosiveness.

The aim of this paper is to present effects of seven weeks plyometrics training program on explosive abilities junior football players.

Methods

Subjects

The subjects were 30 young football players, age 16 to 18 years who volunteered to participate in a research training programme. Two groups of 15 men were randomized into control group (CG) and experimental group (EG). The study was conducted at the end of season 2011./2012.

Training protocol

Initial and final testing was conducted several days before and after the 7- weeks training period. Data was collected through a battery of six tests for evaluation of basic and specific motor abilities.

Table 1: Battery of tests

MOTOR ABILITIES	TEST	TEST ID
Jumping explosiveness	Long jump Sargent test	SDM SAR
Sprinting explosiveness	30 meter dash	30 mvs
Agility	20 yards 93639 Lateral shuffle	2OYD 93639 KUS

Experimental group was involved in a specific 15- minute training protocol during the warm-up and movement preparation before the football practice. In the case of control group this 15 minutes was covered by specific football drills. Training period was divided into 4 cycles (2+2+2+1 week) where players performed 12 different exercises. It is important to state that the main goal of this protocol was improvement of lower limbs explosiveness. The rest period between the sets was 1 minute.

Table 2: Training protocol

Number of weeks	Mesocycles			
	1-2	3-4	5-6	7
Exercises	Sets and repetitions			
Jumping rope	3x30 seconds			
POGO jumps	3x8			
Long jump	3x8			
High jump	3x8			
Single leg jumping rope		3x30 seconds		
Split squat high jump		3x8		
Hurdle jumps (15 cm)		3x8		
Lateral bounce		3x10		
Lateral hurdle jumps			3x8	
Single leg long jump			3x6	
Single leg high jump			3x6	
Forward bounce			3x6	
Box jumps (42 cm)				3x8
Drop jumps (42 cm)				3x8
Drop jump to high jump (50 cm)				3x8
Depth jumps (50 cm)				3x8

Statistical analysis and results

SPSS, version 12.0 was used to compute the data and the results are expressed as means and standard deviations for all variables. Statistical analysis was performed by analysis of kovariance (ANCOVA).

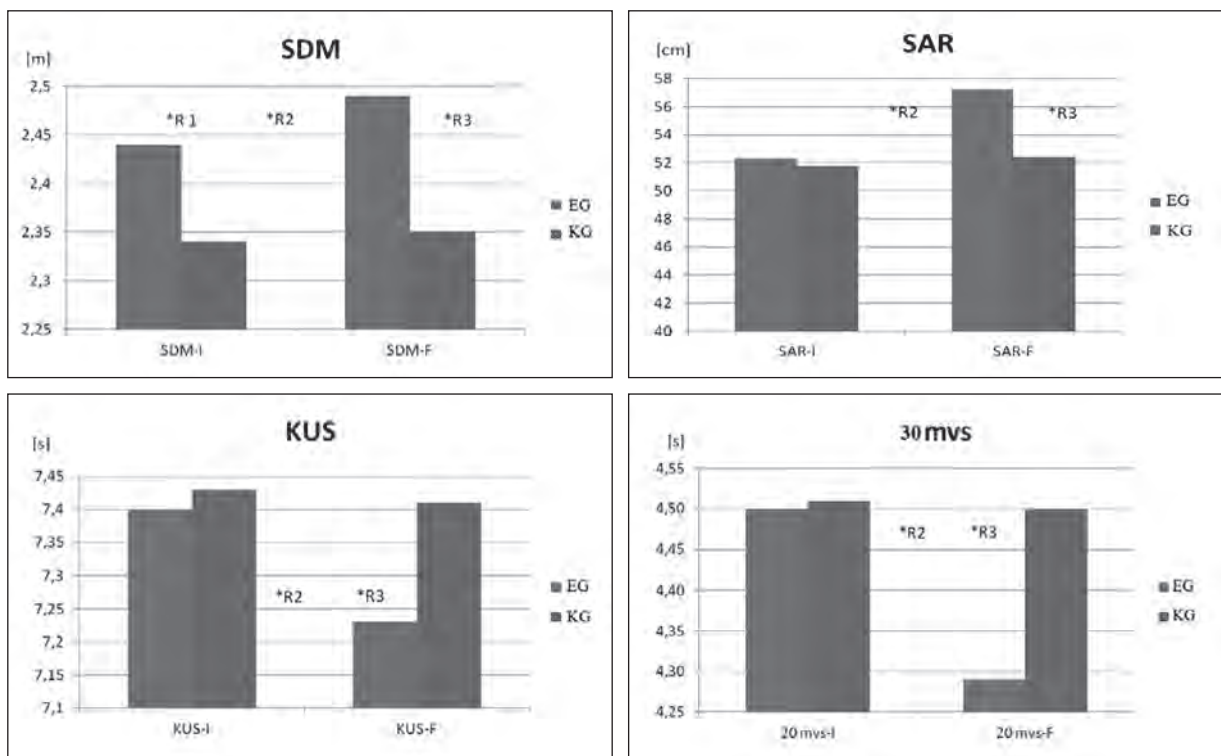

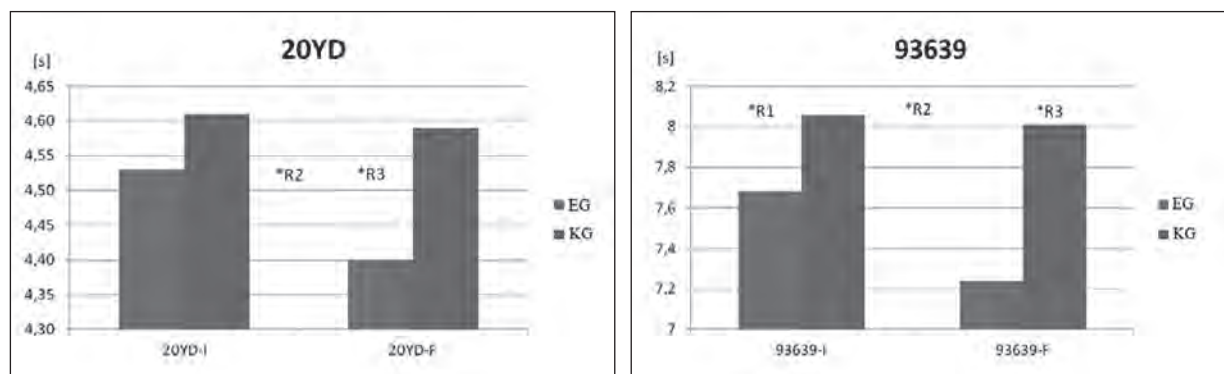

Legend: *R1 significant change between KG and EG in initial testing *R2 significant change of EG in initial and final testing, *R3 significant change in final testing between EG and KG

Figure 1: Mean values in variables between experimental and control group in initial and final testing

Discussion

Top level football puts a great demands on a player's physical capacity and abilities. In a study of Krustup et al. (2005.) top level players spent between 1,9 to 2,4 kilometers in high intensity zone, what was significantly more when compared to lower division players results. Demands for high intensity actions in a football game can be observed through both offensive and defensive plays. In a football game, according to Bangsboo (1994.) 90% of all explosive actions are related to short sprints and changes of direction. Furthermore, sprints over 30 meters make only 1% of all sprinting actions. Therefore we can conclude that all training protocols which are related to acceleration, speed and explosiveness development play a major role in a modern physical conditioning programs.

It is important to state that even minor changes in performance can be of a great benefit considering the fact that not so long period of 7 weeks can deliver positive effects. Based on tests results we can conclude that there was a significant change in experimental group after the training protocol. The change was presented in all tests that were used during the testing (SDM, SAR, KUS, 30mvs, 20YD, 93639).

In the tests for jumping explosiveness significant difference was found between experimental and control group. 7 weeks training protocol made significant influence on vertical and horizontal jump development. Results of this study are also with a positive relation with the studies of Schmidtbleicher et al. (1987.) and Miller et al. (2006.). Furthermore, when we compare initial and final results in two tests (SDM and SAR) we can see that less change was presented in a test for horizontal jumping explosiveness (SDM). Authors suggest that this phenomenon can be explained due to specificity of a training protocol which was more concentrated on a vertical than horizontal component in used exercises and drills.

In the tests for agility (KUS, 93639, 20YD) significant difference was also presented between experimental and control group. In the case of agility development it is important to know that mechanism of muscle activation (eccentric-concentric) is similar or even the same as it is during the plyometric training protocol. Thus we can conclude that significant change was expected as it was confirmed in some of the previous studies (Meylan C. 2009., Miller et al. 2006., Vaczi M. 2013., Thomas et al. 2009., Marković G. 2007., Roopchand-Martin, S. 2010.)

Results in the test for short sprint (30mvs) show a significant difference between the groups. This study results were also confirmed by previous studies of Delecluse et al. and Rimmer and Slaivert. Delecluse et al. 2000. have found that training protocol with explosive exercises brings positive effects on shorter time during the acceleration and transition between acceleration to maximal running speed. Rimmer and Slaivert 2000. have concluded that plyometric training has positive influence on 40 meters sprinting time. In the same study group that did sprints only could not improve the 40 meters sprinting time. Furthermore, results showed that plyometric group significantly decreased ground reaction time. Thus authors suggest that plyometric training should be used as one of the methods for development of sprinting abilities.

Conclusion

In all sports games nowadays, so as in football, needs for physical and tactical capacities are higher than ever. Quick and sudden changes of direction, jump for a header or sprint for a counter attack are elements that are present in each minute of a game. All the elements previously mentioned have one thing in common - explosiveness.

Different studies have showed that with different training programs one can expect positive changes in sport performance. Plyometric method is one of the methods that can bring those changes. By conducting this study we confirmed positive effects of plyometric method among young football players for a training period of 7 weeks. Thus authors suggest the practical application of presented training protocol.

References

1. Bangsbo, J. (1994). Fitness training in football- a scientific approach. August Krogh Institute, University of Copenhagen, Denmark; 112-113.
2. Delecluse, C., Van Coppenolle, H., Willems, E., Van Leemputte, M., Diels, R., Goris, M. (1995). Influence of high-resistance and high-velocity training on sprint performance. *Medicine and Science in Sports Exercise*, 27(8): 1203-1209.
3. Jeffreys, I. (2008.) Movement training for Field sport: Soccer Strenght & Conditioning Journal. str. 19-27, August 2008.
4. Krustup, P. and Bangsbo, J. (2001). Physiological demands of top-class soccer refereeing in relation to physical capacity: effect of intense intermittent exercise training. *J. Sports Sci.* 19:881–891
5. Marković, G., A. Bradić (2008.) Nogomet- integralni kondicijski trening. Zagreb.
6. Markovic, G., Jukic, I., Milanovic, D. and Metikos, D. (2007). Effects of sprint and plyometric training on muscle function and athletic performance. *J. Strength Cond. Res.* 21(2):543–549.
7. Meylan, C., Malatesta, D. (2009.) Effect of in-season plyometric training within soccer practice on explosive actions of young players. *J Strength an Cond. Res. Dec; 23 (9): 2605 – 13.*
8. Miller, M., Herniman, J., Ricard, M., Cheatham, C. and Michael T. (2006). The effects of a 6-week plyometric training program on agility. *Journal of Sports Science and Medicine.* 5:459-465.
9. Radcliffe, J.C. and C.R. Farentinos (2003.) Pliometrija, Gopal Zagreb.
10. Rimmer, E., G. Sleivert (2000). Effects of a plyometric intervention porgram on sprint performance. *Journal of Strength and Conditioning Research*,14(3): 295-301.
11. Roopchand-Martin, S., Lue-Chin, P. (2010.) Plyometric training improves power and agility in Jamaica’s national netball team. *West Indian Med J. Mar; 59 (2): 182 - 7*
12. Schmidtbleicher, D., Gollhofer, A., Frick, U. (1987). Auswirkungen eines tiefsprungtrainings auf die leistungsfahigkeit und das innervationverhalten der beinstreckmuskulatur. *Deutsche Zeitschrift fur Sportmedizin*, 38(9): 389-394.
13. Thomas, K., French, D. and Hayes, P.R. (2009). The effect of two plyometric training techniques on muscular power and agility in youth soccer players. *J Strength Cond Res* 23(1): 332–335.
14. Vaczi, M., Tollar, J., Meszler, B., Juhasz, I., Karsai, I. (2013.). Short-term high intensity plyometric training program improves strength, power and agility in male soccer players. *J Hum Kinet Mar: 28;36 17-26.*

DOES THE USE OF FOAM ROLLER HAVE AN INFLUENCE ON RECTUS FEMORIS ELONGATION?

Petra Drušković¹, Jelena Paušić¹ and Jeremy Todd²

¹Faculty of Kinesiology University of Split, Croatia

²Vita in Motus, Split, Croatia

Abstract

With tight m. rectus femoris it is impossible to have an anatomically correct posture but that also disables the full ROM in the hip and knee as the rectus femoris (quadriceps) tendon is the one that crosses both joints. One of the ways to treat the tightness is foam roller self-massage. The main aim of this research is to find out if the use of foam roller is useful for increase elongation of m. rectus femoris. The biggest effect is achieved on the right leg even though there is a statistically significant difference between the control and experimental groups in all four variables. An only six weeks long treatment of experimental group showed progress up to 12° in Ely's test and up to 6° in the Thomas test. Use of foam roller on the m. rectus femoris is providing significant increase ROM and should be used for the purpose of mobilization because it brings positive results.

Key words: hip flexor, self-massage, myofascial release

Introduction

In the human musculoskeletal system, hip is the largest and most movable joint except shoulder. For the human body to be able to move freely without fear of injury or loss of stability, it is necessary that all links of the musculoskeletal system are working. Hip structure is made of bones, many muscles, cartilages, ligaments and tendons. When one of the links in hip structure is affected and stops to perform its function, from any reason (injury, adhesions, scar tissue, knots), that can cause mechanical dysfunction that can lead to lower back pain, hip or knee pain but also to a poor sports performance.

In this research, topic is the problem of the rectus femoris muscle tightness. Rectus femoris starts with two tendons, one at the anterior inferior iliac spine and the other from the acetabulum. Together with the vastus lateralis, vastus medialis and vastus intermedius, it is merged into a common tendon that passes in front of the knee and is linked to the roughness of the front of the tibia. As a quadriceps they all do knee extension and they are innervating by femoral nerve but rectus femoris also have a role in the hip flexion.

When the rectus femoris is tight it is impossible to have an anatomically correct posture but that also disables the full ROM in the hip and knee as the rectus femoris (quadriceps) tendon is the one that crosses both joints. Such a situation can lead to many different problems. Current attention is focused on two of them in particular. As one of the two tendons is tied to the front of the pelvis, the tightness of the muscle disrupts the mechanics and pulls the pelvis in anterior tilt. Tight hip flexors cause increased lumbar extension as the thigh extends (Kisner and Colby, 2007). To keep the balance the human body increases lumbar lordosis, and a prolonged stay in this position leads to lower back pain syndrome. Another visible problem is poor sports performance. For example, when performing an ordinary air squat, the athlete will not be able to reach a technically perfect squat position, because of an increased flexion of the hip joint. A tight rectus femoris will not allow keeping torso vertically during the knee flexion. Going in to the squat athlete will lean forward, the weight will be on his toes and the mechanics of air squat will be disturbed. People learning how to squat will often mistakenly roll up on the balls of their feet and one of the biggest reasons is missing range of motion in their quads (Starrett, 2013). All this leads to the possibility of various injuries but also to a reduced effectiveness in the sport. The problem is far bigger in case of weighted squats, either front, back or overhead squatting position. In cases like these it is necessary to find the way to bring muscles back to the condition and performance they should naturally have. One of the ways to achieve that is a foam roller self-massages. Using foam roller as a mobility tool improves hip function and intra muscular stiffness (Starrett, 2013). Foam roller works on way that sustained pressures put through a muscle receptor feedback system sending signals to the brain and forces an inhibition of nerves that results in the relaxation of muscle fibers to protect it from injury. That means that pressure to muscle adhesions, scar tissue and the stubborn connective tissue called 'fascia' causes a released tension and this allows an increased blood flow, increased pliability and restoration to normal tissue function. (Marshall, 2009, unpublished thesis). MacDonald, P et al (2011) hypothesized that foam rolling would increase joint ROM, but that it would also decrease muscle force and activation but they were surprisingly wrong about

their second hypothesis. They find out that two minutes following the foam rolling, flexibility was increased by 12.7% (11 degrees), and ten minutes following the foam rolling, flexibility was increased by 10.3% (9 degrees). Following foam rolling the negative correlation between ROM and force production no longer existed.

The main aim of this research is to find out does foam roller techniques are useful for increased elongation of m. rectus femoris and can the use of foam roller increase range of motion in the hip joint.

Methods

All the subjects volunteered to participate in this study, and they had to be men between 20 and 29 years old and actively involved in sports. After the participants were randomly divided into groups (control and experimental), both groups got the explanation of procedure and goals of this study. The testing was conducted on a sample of 43 subjects. The control group had 21 and the experimental group had 22 subjects. All 43 subjects were tested initially to discover whether there is some form of stiffness of their rectus femoris muscle. Testing was performed with 2 tests, Thomas (Kisner and Colby, 2007) and Ely 's test (Kendall et al, 2005.), but with the additional modification. Test could have been positive or negative. For every positive subject on Ely's test there was goniometric measured angle between the lower leg and upper leg for three times. And for negative Ely's test subject get value 135°. For analysis it is used arithmetic mean of three items. The center of the goniometer was passing through the middle of the knee joint and tentacles were lying along the lower leg and upper leg. For every positive subject on Thomas test, there was goniometer measured angle between the upper leg (the one that is not raised up toward chest) and table (lying area). The center of the goniometer was passing through the hip, one tentacle leaning against the upper leg and other one on the table. If the test resulted negative that ment there was no tightness or stiffness in rectus femoris and subject get value 0°. Initial testing was done before training and any kind of mobilization that day. After the initial testing, the control group was free for the next six weeks. The experimental group received the following task: in the next six weeks, every second day before a workout, they had to foam roll 2 minutes each leg. Specifically the part from the hip to the knee. They were instructed to roll slowly all over that area until they locate an area of discomfort and then keep pressure for at least 30 seconds because that duration is required for the body's feedback system to effectively relax the tissue. Latter move on to another spot and repeat the process. After those six weeks, both groups were retested in same conditions. Before training or any kind of mobilization that day.

A one way ANOVA was performed on two samples. Intra-item reliability was calculated on all variables. The level of significance was set at $p \leq 0.05$. Data were analyzed using the Statistical Package Statistica 11.0 (StatSoft, USA).

Results and discussion

Although some authors find moderate intra item reliability of this two modified tests (Peeler and Anderson 2008^{1,2}) the inter item correlation in this research for Thomas modified test was 0,85 – 0,88 and for Ely's modified test is 0,89 – 0,91. Peeler and Anderson (2008) use test-retest method but in this research is used measurement whit multiple items.

Differences between control and experimental groups in the initial measurement of Thomas and Ely's test proved that the two groups did not differ significantly. This means that the selection of subjects within the control and experimental groups was successful. Subjects from each subsample started from the same initial measures. Final measurement was made after completing the treatment, which lasted six weeks. Table 1 shows that there is a significant difference between subjects of the control and experimental groups in the final results of the Ely's test right leg.

Table 1: Differences between control (C) and experimental group (E) in initial and final results of Thomas modified test and Ely's modified test (one way ANOVA)

Variables	Mean _c	SD _c	Mean _e	SD _e	F -value	p
Thomas test left leg - inital	22,57	16,61	19,82	16,90	0,29	0,593
Thomas test right leg - inital	23,55	16,45	18,18	16,38	0,70	0,406
Thomas test left leg - final	21,57	16,98	13,55	15,40	2,64	0,111
Thomas test right leg - final	21,43	17,02	12,09	14,14	3,85	0,056
Ely's test left leg - inital	117,90	14,71	112,64	17,69	1,12	0,296
Ely's test right leg - inital	118,33	15,03	115,14	17,27	0,42	0,522
Ely's test left leg - final	118,05	14,66	124,50	12,34	2,44	0,125
Ely's test right leg - final	118,33	15,57	127,27	10,73	4,85	0,033*

Table 2: Differences between control (C) and experimental group (E) in variables of changes between initial and final measurement (one way ANOVA)

Variables	Mean _C	SD _C	Mean _E	SD _E	F-value	P
Thomas test left leg	-1,00	3,38	-6,09	7,31	9,98	0,003*
Thomas test right leg	-1,00	3,35	-6,27	6,91	8,46	0,006*
Ely's test left leg	0,14	1,06	11,86	8,05	43,75	0,000*
Ely's test right leg	-0,00	2,00	12,14	9,55	32,53	0,000*

Variable of changes, between the initial and final measurements in tests, left and right legs (Table 2.), are identified differences between control and experimental groups using analysis of variance (one way ANOVA). In these variables it is identified that there is a statistically significant difference between the control and experimental groups in all four variables.

The results indicate that self-massage with roller has a positive impact on the elongation of m. rectus femoris in a way that in the control group ROM increased. Such an occurrence can be explained by the fact that the pressure to muscle adhesions, scar tissue and fascia really causes a released tension and forces an inhibition of nerves that results in the relaxation of the muscle fibers. That way increase muscle elongation causing increase ROM i achieved. Sullivan et al (2013) confirmed this in their study where they used a roller-massager on the hamstrings. After short sets of 5-10 seconds, with 13 kg of pressure, they got a positive result in an increase ROM 4.3% ($p = 0.0001$). MacDonald et al (2013) were hypothesized that foam rolling would decrease muscle activation and force but instead they only confirmed their first hypothesis how foam rolling would indeed increase joint ROM. In research announced those two minutes after foam rolling, flexibility was increased by 12.7% (11 degrees), and ten minutes following the foam rolling 10.3% (9 degrees). They explained it as the small undulations place direct and sweeping pressure on the soft-tissue, stretching the tissue and generating friction between the soft-tissue of the body and the foam roller. That way friction generated from the undulations causes warming of the fascia, promoting the fascia to take on a more fluid-like form, breaking up fibrous adhesions between the layers of fascia and restoring soft-tissue extensibility.

Conclusion

Use of foam roller on the m. rectus femoris is providing significant increase ROM. An only six weeks long treatment of experimental group showed progress up to 12° in Ely's test and up to 6° in the Thomas test. Bigger ROM allows more correct functioning of the muscular skeletal system in everyday life and so a better athletic performance. At the moment the authors doesn't know if any other technique of foam roller is even more affective but future studies should be conducted to discover more. The aim of this study is achieved so based on that, we can affirm that the foam roller should be used for the purpose of mobilization because it brings positive results.

References

1. Peeler, J. D., & Anderson, J. E. (2008). Reliability limits of the modified Thomas test for assessing rectus femoris muscle flexibility about the knee joint. *Journal of athletic training*, 43(5), 470.
2. Peeler, J., & Anderson, J. E. (2008). Reliability of the Ely's test for assessing rectus femoris muscle flexibility and joint range of motion. *Journal of Orthopaedic Research*, 26(6), 793-799.
3. Colby, L. A., Kisner, C., & Exercise, T. (2007). "Foundations and Techniques" (pp. 349-383). FA Davis Company Philadelphia.
4. Kendall, F. P., McCreary, E. K., Provance, P. G., Rodgers, M. M., & Romani, W. A. (2005). *Muscles, testing and function: with posture and pain, 5th edition*. Baltimore, MD: Williams & Wilkins.
5. Starrett, K. (2013). *Becoming A Supple Leopard*.
6. MacDonald, G. Z., Penney, M. D., Mullaley, M. E., Cuconato, A. L., Drake, C. D., Behm, D. G., & Button, D. C. (2013). An acute bout of self-myofascial release increases range of motion without a subsequent decrease in muscle activation or force. *The Journal of Strength & Conditioning Research*, 27(3), 812-821.
7. Australia, F. R. (2013). Self Myofascial Release With A Foam Roller Improves Range of Motion. *Self*.
8. Sullivan, K. M., Silvey, D. B., Button, D. C., & Behm, D. G. (2013). Roller-massager application to the hamstrings increases sit-and-reach range of motion within five to ten seconds without performance impairments. *International journal of sports physical therapy*, 8(3), 228.

THE IMPACT OF DIFFERENT TRAINING METHODS ON 12–14-YEAR-OLD BOYS ORIENTEERING SKILLS AND HEART RATE RESPONSES

Lauras Grajauskas

Šiauliai University, Šiauliai, Lithuania

Abstract

The purpose of the present study was to establish the impact of different training methods on young orienteers speed while running a course and their heart rate responses. Fourteen 12–14-year-old boys participated in the experiment. The experiment lasted for six weeks. Orienteering training was performed in both groups three times per week (1–1.5 hours⁻¹ each). Orienteers of the experimental group (n=7) used modified maps twice per week during the main part of their training, and they used standard terrain maps once per week. Orienteers of the control group (n=7) used standard terrain maps three times per week during their main training part. Application of training with modified terrain maps had no significant impact on 12–14-year-old experimental group orienteers average speed of completing the route and heart rate responses. However, during six weeks, dedicating three times per week, 20–30 min⁻¹ each, to orienteering on the terrain, independently from the training methods, significantly improved the parameters of both experimental and control groups' orienteering performance.

Key words: orienteering, novice orienteers, training methods, heart rate

Introduction

Effectiveness of orienteers competition movement is determined by orienteering skills and physical fitness. The problem of development of orienteering skills is relevant when training young orienteers. Orienteering on a terrain is a complex cognitive process; therefore, the varying of training measures and methods is highly important and related to two components: terrain and terrain map. For the sake of safety and time consumption, training of novice orienteers is usually held on one small-area terrain encompassing a dense network of linear landmarks. Therefore, variation of training parameters is facilitated by a terrain map only.

Exercises and tasks employed to control technical preparation of orienteers reveal only separate elements of orienteering skills. Integrally, orienteering skills are assessed according to the result of completing the course. Due to different physical capacities of novice orienteers, solely the result of completing the course may not exactly assess the level of orienteering skills. Research works (Peck, 1990; Chalopin, 1994; Karppinen & Laukkanen, 1994; Bird et al. 2003; Čepulėnas & Grajauskas, 2005) state that the change of heart rate, oxygen consumption when running an orienteering route reveal the intensity and evenness of orienteers physical performance, and according to these indices one can partially assess orienteering skills too.

The aim of the research is to examine the impact of different training methods on young orienteers speed while running a course and their heart rate responses.

Methods

Participants

Fourteen 12–14-year-old boys (age 13.11±0.68 years; height 1.54±0.07 m; body mass 42.89±4.14 kg; BMI 18.01±0.83 kg/m²) participated in the experiment. The participants were divided into two groups: experimental (n=7) and control (n=7). Participants of the research can be characterised as novice orienteers. Indices of body composition of the participants of the experimental and control groups did not significantly differ (p>.05).

Experimental design

The experiment lasted for six weeks. Orienteering training was performed in both groups three times per week (1–1.5 hours⁻¹ each). Orienteers of the experimental group used modified maps twice per week during the main part of their training (approx. 30 min⁻¹), and they used standard terrain maps once per week. Modifications of maps were of four types: (a) *line* (orienteers had to run along the line drawn on the map and to mark the noticed control points in their maps); (b) *black control points* (orienteers had to run holding a map where a black circle marked the location of a control point); (c)

corridor (orienteers had to run holding a special map where a narrow strip of a map indicating the path between control points was drawn only); (d) *white spots on a map* (orienteers had to run holding a map where some areas had been erased). Orienteers of the control group used standard terrain maps three times per week during their main training part (approx. 20–30 min⁻¹). Intensity of orienteers physical performance varied depending on complexity of an orienteering task: the more complex a task was the lower the intensity.

Procedures

Effectiveness of training was assessed according to the average speed of orienteers moving along the route and responses of their heart rate.

The participants were running an orienteering course encompassing a different location of control points before the experiment and after it. The length of the route was 1.41 km. *Orienteering speed* (m · s⁻¹) was calculated by dividing the race distance by the time taken. The route distance was measured as the shortest route from a check point (control) to a check point (control) and was, therefore, shorter than the true distance run by the participants.

The participants were running along the routes, having heart rate monitors Polar S610i (Polar Electro Oy, Kempele, Finland) installed. The heart rate was being recorded every 5 s. The following individual indices of the participants were calculated: *mean heart rate* (the mean heart rate during the race excluding the first 3 min⁻¹), *peak heart rate* (the highest heart rate recorded during the race), *standard deviation of heart rate* (the standard deviation in heart rate during the race excluding the first 3 min⁻¹).

Statistical analyses

The statistical analysis of the data was performed employing SPSS v. 18.0 for Windows (SPSS, Inc., USA). The descriptive analysis of variables in terms of means and standard deviations was done. Due to small samples of the participants, non-parametric criteria were used: to compare dependent samples – Wilcoxon test; for independent ones – Mann-Whitney U test. Statistical significance was set at $p \leq 0.05$.

Results

The average speed of the course for orienteers of the experimental group increased by 0.36 m · s⁻¹ ($p < 0.05$) (Table). The average speed of the control group orienteers running along the route increased slightly less than that of the experimental group orienteers, namely by 0.23 m · s⁻¹ ($p < 0.05$).

Table: Results of the speed of the orienteering course by the participants and the heart rate responses (mean ± standard deviation)

Variables	Experimental group		Control group	
	Before experiment	After experiment	Before experiment	After experiment
Speed (m · s ⁻¹)	1.39±0.21	1.75±0.30*	1.45±0.23	1.68±0.18*
HR _{mean} (beats · min ⁻¹)	175.14±5.30	180.57±6.95*	175.71±8.12	180.29±6.37
HR _{peak} (beats · min ⁻¹)	205.0±4.62	204.14±3.76	208.43±4.12	203.43±4.04*
HR _{sd} (beats · min ⁻¹)	18.44±4.59	10.93±2.89*	16.99±5.19	12.49±3.05*

Note: * = $p < 0.05$. Abbreviations: HR_{mean} = mean heart rate; HR_{peak} = peak heart rate; HR_{sd} = standart deviation in heart rate.

The HR_{mean} significantly ($p < 0.05$) increased (5.43 beats · min⁻¹) in the experimental group only, and in the control group the 4.58 beats · min⁻¹ change was insignificant ($p > 0.05$). The HR_{peak} significantly changed in the control group (5.0 beats · min⁻¹, $p < 0.05$), and in the experimental one the change of the HR_{peak} was low (0.86 beats · min⁻¹, $p > 0.05$). The HR_{sd} of both groups of orienteers changed: in the experimental group it decreased by 7.51 beats · min⁻¹ ($p < 0.05$); in the control group – by 4.5 beats · min⁻¹ ($p < 0.05$). It should be noted that there were no significant differences between the groups after the experiment.

Discussion and conclusions

The research results revealed significant changes in orienteering skills of both groups of the participants. Thus, the 6-week cycle (when 3 times per week, 20–30 min⁻¹ each, were dedicated to the training of orienteering skills), even if carrying out training on the same terrain covering a relatively small area, can significantly improve orienteering skills of 12–14-year-old boys. Absence of inter-group differences during the second survey can, perhaps, be explained by the orienteering tasks being quite difficult to both experimental and control groups. Employment of modified maps makes

training more diverse, allows more purposeful teaching of separate orienteering technique elements, to individualise tasks for the pupils. It should be noted that orienteers of the experimental group faced more difficulties when orienting using such map modifications which precisely (*line*) or conditionally (*corridor*) indicate the path for running between control points.

The research revealed the characteristics of intensity and evenness of young orienteers physical performance when running the orienteering route. The heart rate changed in both groups on the average from 175.4 ± 6.6 to 180.4 ± 6.4 beats \cdot min⁻¹ ($p < .05$). A standard deviation of the heart rate in both groups reached 17.7 ± 4.8 beats \cdot min⁻¹ during the first and 11.7 ± 3.0 beats \cdot min⁻¹ per during the second survey. Results of the earlier research (Čepulėnas & Grajauskas, 2005) showed that intensity and evenness of physical performance of more experienced young orienteers were significantly higher than those of less experienced same-age orienteers. Bird et al. (2003), who examined adult male orienteers of different level of excellence, found out that only a standard deviation of the heart rate of orienteers of these groups differed significantly. For example, the heart rate of a international competitive standard orienteer when running a technically difficult course reached 161 beats \cdot min⁻¹ on the average, and that of a club competitive standard orienteer reached 155 beats \cdot min⁻¹ ($p > .05$); a standard deviation of the heart rate was 6.0 and 10.8 beats \cdot min⁻¹ ($p < .05$) respectively (Bird et al., 2003). Results of the research ground the link between the ability to evenly intensively act along the orienteering route and sportive excellence. Thus, in the process of training of young orienteers, special orienteering tasks should occupy an important place; these tasks should be solved at a relatively high intensity of physical performance. Moreover, the ability to control intensity of physical performance when solving orienteering tasks can significantly contribute to effective solution of these tasks.

To sum up the research, two major conclusions can be drawn. First, application of training with modified terrain maps had no significant impact on 12–14-year-old experimental group orienteers average speed of the route and heart rate responses. However, during six weeks, dedicating three times per week, 20–30 min⁻¹ each, to orienteering on the terrain, independently from the training methods, significantly improved the parameters of both experimental and control groups' orienteering performance. Second, aiming to vary the training of 12–14-year-old orienteers, it is possible, having regarded their individual capacities, to use modified terrain maps. Moreover, such training can help in development of different orienteering aspects.

References

1. Bird, S., George, M., Theakston, S., Balmer, J., & Davison, R. C. (2003). Heart rate responses of male orienteers aged 21–67 years during competition. *Journal of Sports Sciences*, 21(3), 221–228.
2. Čepulėnas, A., & Grajauskas, L. (2005). The dependence of young orienteering athletes heart rates on the training duration while running. In W. Starosta, & S. Squatrito (Ed.), *Scientific fundamentals of human movement and sport practice*. 21, pp. 205–252. Rimini, Italy: Centro Universitario Sportivo Bolognese in Bologna.
3. Chalopin, C. (1994). Physical and physiological characteristics of French orienteers. *Scientific Journal of Orienteering*, 10(1-2), 58–62.
4. Karppinen, T., & Laukkanen, R. (1994). Heart rate in orienteering training and competitions before and during WOC 1993. *Scientific Journal of Orienteering*, 10(1-2), 63–77.
5. Peck, G. (1990). Measuring heartrate as an indicator of physiological stress in relation to orienteering performance. *Scientific Journal of Orienteering*, 6(1), 26–42.

THE CHRONOLOGICAL AGE AS THE IMPACT FACTOR OF PHYSIOLOGICAL CHARACTERISTICS ON TRACK AND FIELD EVENT LONG JUMP

Kemal Idrizović¹ and Marko Aleksandrović²

¹Faculty for sport and physical education, Montenegro

²Faculty of sport and physical education, Serbia

Abstract

The basic goal of this study was to estimate the impact of psychological characteristics on an track and field event long jump, depending on a chronologic age. The examinee sample consisted of 450 school boys, divided into three subsamples with 150 school boys, defined by the age (12±6, 15±6 and 18±6 years). The physiological characteristics representing the predictor system of variables, were estimated by the following tests: medicine ball throwing from sitting position, medicine ball throwing from lying position, medicine ball throwing backward over head, standing long jump, standing triple jump, vertical jump test, hand tapping, sprint 20 m flying start, sprint 30 m standing position, shoulder **dislocation with a stick**, deep forward bend on the bench and spagat, while the result in a long jump represented a criterion variable. This study proved that such a predictor system has a statistically significant result in at the criterion test during all the time interval, while, of all the independent indicators, only tests for the explosive strength estimation of lower limbs had a constant influence.

Key words: physiological characteristics, impact, long jump

Introduction

The jumps are natural forms of motion, namely biotic motor knowledge having a twofold purpose. A man use them to overcome spaces and obstacles. The two basic segments of motions such as jumps are the bounce and landing. In the literature it can also be found that the jumps are classified into the clear represents of the manifestations of explosive strength of lower limbs and of a vertical and horizontal type. There are four jumping track and field disciplines: long jump, triple jump, high jump and pole vault. The track and field jumps are very complex movements made of approach segments representing a cyclic movement and of flying segments which an acyclic movement. Of all four jump disciplines existing today in the athletic programme, a long jump is the oldest and also it belongs to the oldest track and field disciplines at all (Idrizovic, 2010).

Regardless of a jumping technique, a long jump is divided into four phases; the approach run, take-off, flight (there are important differences in the flying phase, which critically determine the very technique of a long jump, and to some extent, these influence the remaining segments of a complete technique) and landing.

The approach run is a part of complete long jump technique which lasts from the running start of a male or female jumper to the moment of a descent of take-off leg on the take-off board. As the first step of a complete technique, first of all, the athletes by the approach attain an optimal running speed which in a take-off moment should have a maximal level, by which they can perform a quality jump. In this combination of a maximally utilised speed and its transition in the best possible take-off, lies a biggest part of a secret for top male and female jumpers. Just because of it, the basic characteristics of a approach are basically the same for all jumpers, but, its details are directly caused by the morphologic-functional-motor characteristic of each athlete who performs a long jump.

The running speed by which the jumpers come to the take-off board, depending on their characteristics, ranges from 90 and 95 % of their maximal sprint running speed. The maximal running speed during the approach for a long jump, for top athletes, ranges from 10,50 m/s to 11,23 m/s (Nixdorf and Brüggemann, 1990).

The take-off lasts from the moment of take-off leg descent to its detachment from the ground.

The flight is a part of a complete jump technique which lasts from the moment of a detachment of a front part of a foot from the take-off board to the moment of the first contact of foot or some other part of body with the ground.

The landing is the last part of a long jump which actually represents a landing after the flying phase. The task of this segment of technique is to extend the jump length as maximally as possible.

The big numbers of scientific researches within the long jump discipline indicate that it represents the discipline where, globally seen, the physiological characteristics, namely the functional-motor abilities of a jumper, speed and strength, mostly influence the results. These two motor abilities, namely their synergy, critically influence the jump

quality. The development of these abilities, beside a high level of their genetic predisposition, is a matter related to a long term training process.

Actually, the basic aim of this research was to determine which sub-segments of speed-strength abilities mostly influence the results quality in this track and field event and in which way this influence the changes from the period of the differentiation to the period of amalgamation.

Methods

The examinee sample for this research was made of 450 boys, which, on the basis of their age (12 ± 6 years, body height: $150,18 \pm 6,87$ cm and body mass: $41,75 \pm 7,62$ kg; 15 ± 6 years, body height: $171,00 \pm 7,83$ cm and a body mass: $57,80 \pm 9,38$ kg; 18 ± 6 years, body height: $184,44 \pm 6,26$ cm and body mass: $77,94 \pm 13,02$ kg) were divided into three subsamples of 150 boys. The basic factor, on the basis of which the subsamples were defined, is also the goal of this research in order to see the differences in the influence of functional-motor abilities on the results in the long jump, at the beginning, during and at the end of adolescence time.

The examinees were tested for three days. In the first day, the examinees were introduced with the ways and rules of the carrying out of the research, their basic anthropometric indicators, and the criterion test of a long jump was carried out (SDZ). In the second day, during the morning, the tests for the estimation of the explosive strength of upper limbs were carried out: medicine ball throwing from sitting position (BMS), medicine ball throwing from lying position (BML), medicine ball throwing backward over a head (BMG). In the second day, in the afternoon, the tests for the estimation of the explosive strength of lower limbs were carried out: standing long jump (SDM), standing triple jump (TRM), vertical jump test (SVM). In the third day, in the afternoon, the test for the estimation of suppleness were carried out; shoulder dislocation with a stick (ISP), deep forward bend on the bench (DPK) and spagat (SPG), while, in the afternoon, the tests of speed-related abilities were carried out: hand tapping (TPR), sprint 20 m flying start (20M), sprint 30 m standing position (30M).

The examinees performed each test twice with a pause between the iterations lasting at least 3 min. The better result of two measurements was taken for the analyze. All the tests were carried out in a period of more than 48 hours after any physical effort in order to minimize the influence of a fatigue on the test of functional-motor abilities.

The examinees were completely informed about all test procedures, before they signed the written agreement for their participation in tests.

All the statistical analyses were carried out using SPSS packet version 21.0. The impact of the predictor system of variables onto the criterion of this research, and its statistical significance were proved by the use of regression analyse. The statistical significance was determined on the level of $p < 0.05$.

Results

Tabela 1: Multiple regression analysis for twelve year old boys

Varijable	r	PART-r	BETA	P	Q-BETA
T20	-.44	-.18	-.20	9.34	.03
T30	-.40	-.06	-.07	2.92	.44
BMS	.25	.11	.11	3.03	.19
BML	.21	-.00	-.00	0.17	.92
BMG	.26	.05	.05	1.36	.51
SDM	.43	.00	.00	0.25	.94
TRM	.47	.13	.14	6.84	.10
SVM	.51	.28	.29	15.16	.00
TPR	.24	.10	.09	2.18	.20
ISP	-.08	-.07	-.05	0.49	.40
DPK	.11	.04	.03	0.44	.60
SPG	.11	-.01	-.01	0.20	.81

DELTA= .41 RO= .64 Q=.00

The statistically significant impact of the predictor system of variables onto a criterion was determined for all three subsamples, namely age (Tables 1, 2 and 3) namely for the youngest subsample on the level of 41% of common variability, for the oldest boys 52%, and for 15-year-old at the level of common variability. Individually, by the independent variability, the statistically significant prediction of criteria were accomplished for 12-year-old boys in the tests SVM and T20 (Table

1). For 15-year-old boys, the statistically significant impact were attained at the tests SVM, TRM and DPK (Table 2), and for 18-year-old boys, the statistically significant values of the regression coefficients were attained at the tests SVM, T20, BMG, BMS, T30, TPR and BML (Table 3).

Tabela 2: Multiple regression analysis for 15-year-old boys

Varijable	r	PART-r	BETA	P	Q-BETA
T20	-.52	-.11	-.11	6.18	.19
T30	-.45	-.09	-.09	4.14	.29
BMS	.44	.00	.01	0.48	.91
BML	.36	-.11	-.13	4.80	.19
BMG	.52	.12	.16	8.46	.13
SDM	.61	-.08	-.12	7.78	.31
TRM	.63	.20	.22	13.97	.01
SVM	.65	.30	.42	28.07	.00
TPR	.34	-.04	-.03	1.26	.60
ISP	-.08	-.04	-.02	0.24	.63
DPK	.30	.22	.16	4.99	.00
SPG	.37	.12	.10	3.97	.13

DELTA .56 RO.75 Q .00

Tabela 3: Multiple regression analysis for 18-year-old boys

Varijable	r	PART-r	BETA	P	Q-BETA
T20	-.33	-.23	-.22	7.26	.00
T30	-.42	-.17	-.16	6.72	.03
BMS	.27	-.18	-.24	6.48	.02
BML	.34	.17	.23	7.82	.04
BMG	.43	.21	.20	8.60	.01
SDM	.48	-.05	-.06	2.88	.52
TRM	.50	.12	.14	7.00	.12
SVM	.56	.31	.39	21.84	.00
TPR	.12	-.18	-.15	1.80	.03
ISP	-.20	-.00	-.00	0.00	.06
DPK	.27	.11	.10	2.70	.17
SPG	.15	.06	.00	0.00	.43

DELTA= .52 RO=.72 Q= .00

Discussion and conclusions

By an analyse of biomechanical characteristics, a long jump belongs to the group of complex space movements, and by the type of motor activity it belongs to natural movements without use of technical apparatus. The structure of complete movement in a long jump is divided into a cyclic part (approach) and acyclic part (jump) which is divided into three segments: take-off, flight and landing. Of all mechanic factors, the running speed, intensity of take-off impulse and take-off angle most importantly influence the quality of results (Milanovic et al., 1986).

The basic task which the approach phase set to a jumper is the accomplishment of a maximal horizontal speed. This maximal speed the jumper accomplished at a runway is not identical to a maximal sprint speed. The phenomenon of usability of sprint speed is very important for a jumper. The top level jumpers fairly more benefit from its sprint speed, while for middle and lower level jumpers show much less level of sprint speed at the runway.

This research ascertained that a high level of a maximal speed exactly was one of the main factors which influenced the quality of results of a long jump. The significant impact of a sprint speed was proved for 12-year-old boys, for 15-year-old it is not present, while for 18-year-old it attained its maximal value. Such finding can be explained by the fact that the quality of a maximal running speed depends on a very high number of factors, which, during the biological development, differently behave towards it. In the period of the end of adolescence, when a complete formation of the majority of man's abilities and characteristics is being formed, an individual impact of functional-motor potentials on some defined movement activity, a long jump in this case, is completely determined.

Milanovic (1986) argues that Aleksandrov (1979) had just ascertained a different use of a sprint speed in the approach of jumpers, of a different qualitative level. For top jumpers this percent is 89,57 and for middle level jumpers 84,90%.

In this research it cannot be discussed about the utilisation of a maximal run speed, but a higher attained maximal speed is the first precondition of a higher speed for a take-off, and is also an indicator of higher explosive-strength potentials of these examinees.

The Locatelli's (1993) finding actually proves that the higher level of a maximal running speed enables also a higher level of a running speed one meter before the take-off. The same author mentions an extraordinary level of utilisation level for two jumpers in the long jump. Carl Lewis in Tokyo 1991 during the jump of 8.91 m, 10 meters, from 11th to 1st before the take-off, run for 0.89s, representing the speed of 11,23 m/s, what is 95,3% of his maximal running speed. Giovanni Evangelisti, in his 8.08 m jump, the same ten meters run for 0.93 s, representing the speed of 0.93 and 97.5% of his maximal running speed.

How much a running speed is important for the jump length is best described by the data of higher number of researches given by Homenkow (1977), where he argues that the increment of bounce speed from 9.1 to 10.7 m/s led to the improvement of the result from 690 to 890 cm.

Strizhak et al. (1989) also argue that the jump length directly depend on the running speed before the take-off phase and it represents a predictive model of a running speed in comparison to the standing jump length.

Milanovic et al. (1986), as the previous authors, mention the bounce speed as a most important factor of the results in a long jump.

Generally seen, the results obtained by this research indicate the fact that, for a result in a long jump, the most part of prediction was attained by the result in tests for the estimation of the explosive strength of lower limbs. Only the results of these tests in all three ages accomplish a statistically significant impact on a criterion test of a long jump. On the basis of such results, it can be concluded that, in a functional-motor base of an athletic discipline long jump, primarily there is an explosive strength of lower limbs of a horizontal and vertical type. Such a result completely overlaps with the conclusion drawn by Milanovic et al. (1986) that the biggest importance of anthropologic characteristics, in comparison to the success in long jump, has an explosive strength and that no other ability or characteristic is at this level.

The increment of the number of tests which accomplish a statistically important impact on a standing jump result had significantly risen for the sample of 18-year-old boys in comparison to 12-year-old boys. The basic reason for such a finding can be found that in the amalgamation period, which enfolds at the end of adolescence period, the independence of functional-motor abilities rises what also means that all of them emerges as an independent factor which has also its independent impact on the movement structures of a different complexity. This also means that in the period which is at the very end of a biological man's development, the number of abilities which directly impact on the quality in the carrying out of defined movement structures is significantly higher than the number of factors that define the same result in the periods of a start and during the adolescence.

References

1. Homenkov, L.S. (1977). *Atletika*. Beograd: NIP "Partizan".
2. Idrizović, K. (2010). *Atletika I i II*. Podgorica: Univerzitet Crne Gore.
3. Locatelli, E. (1993). Sprinting speed as a basis for the men's long jump. *New Studies in Athletics*, 8(3), pp. 93-94
4. Milanović, D., Hofman, E., Puhanić, V., Šnajder, V. (1986). *Atletika-znanstvene osnove*. Zagreb: Fakultet za fizičku kulturu Sveučilišta u Zagrebu.
5. Nixdorf, E. and Brüggemann, G-P. (1990). Biomechanical analysis of the long jump. In G.-P. Brüggemann and B. Glad (Eds.), *Scientific Research Project at the Games of the XXIVth Olympiad – Seoul 1988 Final Report* (pp. 263–301). Monaco: International Athletic Foundation.
6. Strizhak, A.P., Aleksandrov, O.I., Sidorenko, S.P. and Petrov, V.A. (1989). *Legkoatleticheskie pryzhki*, 168 p, Kiev: Health.

METRIC CHARACTERISTICS OF THE NEWLY CONSTRUCTED QUESTIONNAIRE FOR ASSESSING THE KNOWLEDGE OF WRESTLING COACHES ON NUTRITION AND DOPING

Hrvoje Karninčić¹, Mario Baić² and Kristijan Slačanac²

¹Faculty of Kinesiology University of Split, Croatia

²Faculty of Kinesiology University of Zagreb, Croatia

Abstract

The aim of this study was to determine the metric characteristics of a questionnaire assessing knowledge and attitudes about nutrition and doping on a sample of wrestling coaches. A questionnaire consisting of 40 items (16 questions for assessing knowledge and 24 attitudes on nutrition and doping) was constructed and conducted on a sample of wrestling coaches (n=21) aged 31±11 years. Reliability was determined by the test retest method, after the items of unsuitable characteristics had been excluded. There were 11 questions left with satisfactory overlap rate (80%) as well as 16 attitudes of satisfactory correlation. In the area of knowledge, two latent dimensions were extracted: coaches' practical and physiological knowledge. Among attitudes, three latent dimensions were extracted: critical attitudes, followed by affirmative attitudes on doping and attitudes on nutrition. In this study, a questionnaire with good metric characteristics for assessing wrestling coaches' knowledge on nutrition and doping was obtained. A large number of excluded questions and attitudes indicate that coaches are unfamiliar with the subject, which points out the necessity of further education of coaching staff.

Key words: survey, reliability, validity, combat sport

Introduction

From the energy aspect, modern wrestling is a very complex sport; almost all energy sources are significantly involved in a wrestling fight (Karnincic, 2013; Karnincic et al., 2013). Wrestling training sessions are extremely strenuous and carefully planned because wrestling tournaments and competition season require exceptional conditional preparedness (Kraemer et al., 2001; Kraemer et al., 2004; Ratamess et al., 2013). Various parameters of strength must be at an enviable level (McGuigan et al., 2006). All of the abovementioned statements on wrestling suggest that, besides hard work, wrestlers must take care of their nutrition and adequate supplements. Proper nutrition, supplementation and hydration ensure adequate energy sources, necessary substances for building body mass and fast recovery after strenuous exercise (Hoffman & Maresh, 2011). Besides wrestling knowledge, wrestling coaches should possess knowledge on proper nutrition and supplementation. Most coaches (82%) are convinced that their knowledge on wrestling is superior to their knowledge on wrestlers' nutrition (Sossin et al., 1997). Inadequate knowledge on nutrition results in poor physical and conditional preparedness of athletes; in such conditions, athletes might reach for illegal substances, i.e. doping (Rodek et al., 2013), which sometimes happens in wrestling as well (Lindqvist et al., 2013). Even though a lot of papers have been written on the subject of supplementation in wrestling (Hoffman & Maresh, 2011; Horswill et al., 2006; Kara et al., 2010), only 35% of coaches read professional literature (Sossin et al., 1997) and they are very often not adequately informed. The problems of supplementation and doping are necessarily overlapped, in crude terms they are divided by the WADA list of legal and illegal substances, but actually, they are divided by the fact that doping can seriously, permanently and sometimes fatally damage one's organism (Montisci et al., 2012). It is of crucial importance to educate wrestling coaches on how to achieve results through proper nutrition and adequate supplementation, which ultimately draws wrestlers away from using doping. The aim of this study was to determine the metric characteristics of the questionnaire assessing knowledge and attitudes about supplements and doping on a sample of wrestling coaches.

Methods

The subject sample included wrestling coaches (n=21), aged 31±11 years, who attended a mandatory seminar for coaches organized by the Croatian Wrestling Federation. The subjects filled out the questionnaire during seminar and once again seven days later. They used an identification password so as to keep the questionnaire anonymous. The surveyor gave the subjects detailed instructions on privacy, information on how to fill out the questionnaire and explained its purpose. The same instructions were repeated in the same way during retest.

The variable sample included a battery of 40 questions and attitudes. The first part of the questionnaire consists of 16 closed-ended questions for assessing coaches' knowledge on supplements and doping. The first 10 questions offered the following answers: true, false and I don't know; the following 6 questions offered concepts under a, b and c. The correct answer was to be circled. The second part of the questionnaire is related to attitudes towards doping. The respondents had to circle their attitude on a five-point Likert scale for the 24 attitudes offered (1 completely true, 1 usually true, 3 I don't know, 4 usually not true and 5 completely not true). During the construction of the questionnaire, the authors consulted experts and professional literature (Benardot, 2011; Tepšić et al., 2002).

Methods of data analysis for the first part of the questionnaire: the percentage of true answers per question was calculated, reliability was determined through test-retest overlap rate and validity was determined by factor analysis. For the questionnaire section related to attitudes on nutrition and doping, descriptive statistical parameters of mean and standard deviation were calculated, reliability was determined by Spearman's rank correlation coefficient and validity was determined by factor analysis. Statistical significance was set at $p < 0.05$.

Results

The test-retest overlap rate and distribution of correct answers about knowledge on nutrition and doping are presented in Table 1.

No.	Question	test % correct	retest % correct	test-retest overlap %
1	Glycemic index refers to the blood glucose level	62	62	90
2	Carbohydrates are the primary energy source	86	100	86
3	Antioxidants boost fat burn	33	33	76
4	CLA (conjugated linoleic acid) boosts muscle growth	24	24	67
5	Proteins, among other things, protect athletes from injury	19	38	71
6	Vitamin E is the strongest antioxidant important for athletes' muscle work	19	19	62
7	Glutamine supplementation can prevent muscle mass loss	71	62	62
8	When working on athlete's weight gain, I will include mostly carbohydrates into his diet	86	81	90
9	Athletes do not need to be stimulated to drink fluids during training because they regulate it themselves	67	76	76
10	Proteins are used for the activity of the brain, kidneys and red blood cells	62	57	67
11	When working on athletes' weight loss, I will mostly eliminate from his diet	95	90	86
12	Caffeine is useful during exercise because it burns more	81	81	81
13	In the process of loosing weight, wrestlers should eliminate from their menu	95	95	100
14	Fats are used for	43	38	81
15	The level of natural testosterone production is increased by	62	57	86
16	The use of blood doping increases the risk of	62	57	57

It can be seen in Table 1 that the percentages of correct answers in test and retest were nearly the same. The test-retest overlap rate was 77%. All subjects gave a correct answer to question 2 in retest.

Table 2: Factor structure matrix of coaches' knowledge on nutrition and doping based on 11 questions that meet the criteria of reliability and sensitivity. F1 – correlation coefficients of the first extracted factor and F2 – correlation coefficients of the second extracted factor. Expl. Var – The extent of variability that is explained by the extracted latent dimension. Prop. Totl – Proportion of variability that is explained by the extracted latent dimesion

question	1	3	4	5	8	9	11	13	14	15	16	Expl.Var	Prp.Totl
F 1	-0.28	0.06	-0.6	-0.71	-0.35	0.77	0.67	0.73	-0.06	0.27	-0.47	2.95	0.27
F 2	0.70	0.65	0.01	0.14	0.55	-0.14	0.38	0.51	-0.71	-0.54	-0.07	2.46	0.25

Table 2 presents the factor structure of the questionnaire on coaches' knowledge. The analysis extracted two latent dimensions that explain 50% of variability of the manifest space. Questions 5, 9 and 13 were isolated with statistical significance on the first factor and questions 1 and 14 on the second factor.

Descriptive statistical parameters of mean and standard deviation ($M \pm SD$) for test and retest for 28 attitudes on nutrition and doping are presented in Table 3, as well as Spearman's rank correlation coefficient (r_s) between test and retest.

No	Attitude	M \pm SD		r_s
		test	retest	
1	Supplements are undoubtedly useful for wrestlers	4.48 \pm 0.93	4.05 \pm 1.16	0.40
2	Wrestlers could withstand high intensity training without taking supplements	2.71 \pm 1.10	2.81 \pm 1.15	0.33
3	Supplements can cause side effects after long term consumption	2.71 \pm 1.08	3.33 \pm 0.80	0.44
4	I recommend supplements to athletes only when recommended by certified nutritionist or doctor	3.19 \pm 1.21	3.24 \pm 1.30	0.25
5	I adequately inform my wrestlers about the supplements they use	3.67 \pm 1.15	3.71 \pm 0.78	0.73
6	Wrestlers use some other supplements without my knowledge	2.57 \pm 1.03	2.33 \pm 1.02	0.44
7	Top results cannot be achieved in wrestling any more without the supplements	4.00 \pm 0.95	3.76 \pm 1.00	0.25
8	I am certain that the supplements my athletes use are not dangerous to their health	4.33 \pm 0.73	3.95 \pm 1.02	0.59
9	Doping control rarely controls wrestlers	3.52 \pm 1.12	3.38 \pm 1.16	0.53
10	I know of some cases of doping use in wrestling	3.67 \pm 1.32	3.24 \pm 1.30	0.56
11	Doping increases the level of sport results in wrestling	4.05 \pm 0.92	3.95 \pm 1.07	0.36
12	Doping is not present in wrestling much	3.00 \pm 1.00	2.86 \pm 0.91	0.43
13	Coaches and wrestlers are equally guilty for doping use in sport	3.87 \pm 0.79	3.43 \pm 1.08	0.26
14	Little attention is paid to educating wrestlers and coaches regarding doping and nutrition supplements	3.67 \pm 1.06	3.81 \pm 0.98	0.30
15	I check the list of illegal substances every year	2.33 \pm 1.24	2.67 \pm 1.35	0.57
16	I consider the use of illegal substances in sport and wrestling to be immoral.	4.62 \pm 0.80	4.38 \pm 1.07	0.36
17	The use of illegal substances is the shortest way for an athlete to ruin his life and health.	4.48 \pm 0.81	4.19 \pm 1.17	0.40
18	In my opinion, taking testosterone, steroids or hormones to build muscle mass and achieve better results is inadmissible.	4.38 \pm 0.97	4.19 \pm 1.33	0.37
19	Some illegal substances should be legal today	2.76 \pm 1.14	2.76 \pm 1.00	0.59
20	If there is not even a slightest chance for an athlete to achieve top result without doping, he should not use doping	3.29 \pm 1.45	3.29 \pm 1.19	0.09
21	Illegal substances have a negative effect on athlete's organism if used in large quantities	2.81 \pm 1.60	1.95 \pm 1.16	0.50
22	If most wrestlers used illegal substances without being caught, I would also recommend those substances to my wrestler	1.71 \pm 1.10	1.43 \pm 0.87	0.47
23	If I personally was given a chance to cheat in doping control, I would	1.76 \pm 1.09	1.48 \pm 0.93	0.54
24	I would recommend any kind of illegal substance to my wrestler if I knew he would not be tested by doping control	1.71 \pm 1.10	1.48 \pm 0.93	0.23

It can be seen in Table 3 that there were no greater deviations in the presented descriptive statistical parameters in the majority of attitudes in test and retest. Spearman's rank correlation coefficient indicates a statistically significant correlation between test and retest for attitudes 3, 5, 6, 8, 9, 10, 15, 19, 21, 22 i 23.

Table 4: Factor structure matrix of coaches' attitudes on nutrition and doping based on 18 attitudes that meet the reliability criterion. F1 – correlation coefficients of the first extracted factor and F2 – correlation coefficients of the second extracted factor and F3 – correlation coefficients of the third extracted factor. Expl. Var – The extent of variability that is explained by the extracted latent dimension. Prop. Totl – Proportion of variability that is explained by the extracted latent dimension

attitude	1	3	5	6	8	9	10	12	14	15
F 1	0.47	-0.37	-0.10	0.43	0.51	0.48	0.44	0.63	0.76	-0.19
F 2	0.57	-0.19	-0.35	0.34	0.49	0.28	0.18	-0.14	0.37	-0.25
F 3	0.03	-0.72	-0.62	0.54	-0.22	-0.29	-0.48	-0.08	0.10	-0.2
attitude	16	17	18	19	21	22	23	24	Expl.Var	Prp.Totl
F 1	0.88	0.88	0.76	-0.67	-0.52	-0.45	-0.45	-0.48	5.71	0.32
F 2	0.10	0.11	0.09	0.31	0.66	0.61	0.77	0.65	3.12	0.17
F 3	-0.23	-0.14	-0.09	0.09	-0.31	-0.46	0.02	0.17	2.04	0.11

Table 4 presents the factor structure of the questionnaire on coaches' knowledge. The analysis extracted three latent dimensions, which explain 60% of variability of the manifest space. Attitudes 14, 16, 17 and 18 were isolated with statistical significance on the first factor, attitudes 21, 22 and 23 on the second factor, while attitude number 3 was the representative of the third factor.

Discussion

Out of the 16 questions assessing knowledge on nutrition and doping, 12 questions met the reliability criterion, so the total test retest overlap rate is 80%. The percentage is not ideal, but it is close to the results obtained by other authors in similar studies on reliability of the questionnaire (Dvorak et al., 2008; Ozdogan & Ozcelik, 2011; Spendlove et al., 2012), low level of coaches' knowledge on the investigated problems (60%) contributes to the decrease of answer overlap. The lower the knowledge, the higher the possibility for learning between test and retest; which is a common occurrence (Kondric et al., 2013). Reliability of the questionnaire section related to wrestling coaches' attitudes on nutrition and doping was tested by Spearman's rank correlation coefficient. Because of the low correlation, it can be suggested for attitudes 2, 4, 7, 13, 14, 20 and 24 to be excluded from the questionnaire so it would have 15 questions of satisfactory reliability. Extremely good reliability should be looked for in a questionnaire on athletes' self-reported doping use (Petroczi et al., 2011). Lack of correlation in some answers and high percentage of the *I don't know* answer suggests that wrestling coaches do not have clear attitudes on nutrition and doping. The fact is that only 60% of correct answers were recorded in both test and retest regarding knowledge on nutrition and doping. Therefore, a conclusion can be drawn that coaches' low level of knowledge on nutrition and doping affects their attitudes.

In the questionnaire section related to coaches' knowledge on supplements and doping, two latent dimensions were extracted. The first latent dimension refers to coaches' practical knowledge related to training or losing weight. The second latent dimension refers to coaches' knowledge in the field of physiology. Factor analysis of the questionnaire section related to coaches' attitudes towards supplements and doping extracted three latent dimensions. The first one refers to critical attitudes towards doping, the second one represents affirmative attitudes towards doping and the third one refers to attitudes towards supplements. Percentage of the total explained variance is 50% for knowledge and 60% for attitudes. Even though a high percentage of explained variance is common in natural sciences, in social sciences, whose research is often based on these kinds of questionnaires, scientists often opt for solutions of 60% of the explained variance or even less (Stewart, 1981).

There were 60.4% of correct answers in the test and 60.7% in the retest. Though it seems that reliability was not caused by learning between test and retest, when questions of low reliability are excluded the ratio of correct answers is increased in favour of the retest. It can be inferred that the problematic reliability is caused by learning after all. Some questions of low reliability are actually too difficult for this subject sample. For questions 4, 5 and 5 (knowledge), the percentage of correct answers was 19-25%. The problem with attitudes is mainly related to knowledge; if a subject does not have sufficient knowledge, he will not have clear attitudes about the problem. The fact that a large number of questions and attitudes were excluded from the questionnaire suggests that, due to their lack of knowledge on the subject, coaches guessed the answers.

Conclusions

The aim of this study was to determine the metric characteristics of the newly constructed questionnaire for assessing knowledge and attitudes about supplements and doping on a sample of wrestling coaches. After some questions had been excluded, good reliability and factor structure for attitudes and knowledge on nutrition and doping was determined. A certain number of questions cannot be applied because they are too difficult for this sample, which indicates a relatively low level of coaches' knowledge about these problems; that is why there was insecurity in some attitudes. Based on this study, the authors can suggest further education of coaches regarding problems related to nutrition and doping.

References

1. Benardot, D. (2011). *Advanced Sports Nutrition: Human Kinetics*.
2. Dvorak, T. E., Jordan, K. C., Dolan, S. H., Wing-Gaia, S. L., Manore, M. M., & Meyer, N. L. (2008). The Adolescent Sport Nutrition (SN) Knowledge Questionnaire: Validity and Reliability. *Medicine and Science in Sports and Exercise*, 40(5), S218-S218. doi: 10.1249/01.mss.0000322395.05935.e9
3. Hoffman, J. R., & Maresh, C. M. (2011). Nutrition and Hydration Issues for Combat Sport Athletes. *Strength and Conditioning Journal*, 33(6), 10-17. doi: 10.1519/SSC.0b013e318237247e
4. Horswill, C. A., Curby, D. G., Bartoll, W. P., Stofan, J. R., & Murray, R. (2006). Effect of carbohydrate intake during wrestling practice on upper-body work in adolescents. *Pediatric Exercise Science*, 18(4), 470-482.
5. Kara, E., Gunay, M., Cicioglu, I., Ozal, M., Kilic, M., Mogulkoc, R., & Baltaci, A. K. (2010). Effect of Zinc Supplementation on Antioxidant Activity in Young Wrestlers. *Biological Trace Element Research*, 134(1), 55-63. doi: 10.1007/s12011-009-8457-z

6. Karnincic, H. (2013). Glucose Dynamics Can Evaluate State of Anaerobic Fitness in Wrestling?! *Collegium Antropologicum*, 37, 101-106.
7. Karnincic, H., Krstulovic, S., & Baic, M. (2013). The Influence of Body Weight on Chosen Physiological Parameters in Wrestling. *Journal of Human Kinetics*, 37, 119-127.
8. Kondric, M., Sekulic, D., Uljevic, O., Gabrilo, G., & Zvan, M. (2013). Sport Nutrition and Doping in Tennis: An Analysis of Athletes' Attitudes and Knowledge. *Journal of Sports Science and Medicine*, 12(2), 290-297.
9. Kraemer, W. J., Fry, A. C., Rubin, M. R., Triplett-McBride, T., Gordon, S. E., Koziris, L. P., . . . Fleck, S. J. (2001). Physiological and performance responses to tournament wrestling. *Medicine and Science in Sports and Exercise*, 33(8), 1367-1378. doi: 10.1097/00005768-200108000-00019
10. Kraemer, W. J., Vescovi, J. D., & Dixon, P. (2004). The physiological basis of wrestling: Implications for conditioning programs. *Strength and Conditioning Journal*, 26(2), 10-15. doi: 10.1519/00126548-200404000-00001
11. Lindqvist, A. S., Moberg, T., Eriksson, B. O., Ehrnberg, C., Rosen, T., & Fahlke, C. (2013). A retrospective 30-year follow-up study of former Swedish-elite male athletes in power sports with a past anabolic androgenic steroids use: a focus on mental health. *British Journal of Sports Medicine*, 47(15). doi: 10.1136/bjsports-2012-091340
12. McGuigan, M. R., Winchester, J. B., & Erickson, T. (2006). The importance of isometric maximum strength in college wrestlers. *Journal of Sports Science and Medicine*, 5, 108-113.
13. Montisci, M., El Mazloum, R., Cecchetto, G., Terranova, C., Ferrara, S. D., Thiene, G., & Basso, C. (2012). Anabolic androgenic steroids abuse and cardiac death in athletes: Morphological and toxicological findings in four fatal cases. *Forensic Science International*, 217(1-3), E13-E18. doi: 10.1016/j.forsciint.2011.10.032
14. Ozdogan, Y., & Ozcelik, A. O. (2011). Evaluation of the nutrition knowledge of sports department students of universities. *Journal of the International Society of Sports Nutrition*, 8. doi: 1110.1186/1550-2783-8-11
15. Petroczi, A., Uvacek, M., Nepusz, T., Deshmukh, N., Shah, I., Aidman, E. V., . . . Naughton, D. P. (2011). Incongruence in Doping Related Attitudes, Beliefs and Opinions in the Context of Discordant Behavioural Data: In Which Measure Do We Trust? *Plos One*, 6(4). doi: e1880410.1371/journal.pone.0018804
16. Ratamess, N. A., Hoffman, J. R., Kraemer, W. J., Ross, R. E., Tranchina, C. P., Rashti, S. L., . . . Faigenbaum, A. D. (2013). Effects of a competitive wrestling season on body composition, endocrine markers, and anaerobic exercise performance in NCAA collegiate wrestlers. *European Journal of Applied Physiology*, 113(5), 1157-1168. doi: 10.1007/s00421-012-2520-8
17. Rodek, J., Idrizovic, K., Zenic, N., Perasovic, B., & Kondric, M. (2013). Differential Analysis of the Doping Behaviour Templates in Three Types of Sports. *Collegium Antropologicum*, 37, 211-217.
18. Sossin, K., Gizis, F., Marquart, L. F., & Sobal, J. (1997). Nutrition beliefs, attitudes, and resource use of high school wrestling coaches. *International Journal of Sport Nutrition*, 7(3), 219-228.
19. Spendlove, J. K., Heaney, S. E., Gifford, J. A., Prvan, T., Denyer, G. S., & O'Connor, H. T. (2012). Evaluation of general nutrition knowledge in elite Australian athletes. *British Journal of Nutrition*, 107(12), 1871-1880. doi: 10.1017/s0007114511005125
20. Stewart, D. W. (1981). The application and misapplication of factor-analysis in marketing-research. *Journal of Marketing Research*, 18(1), 51-62. doi: 10.2307/3151313
21. Tepšić, G., Francis, C., & Johnson, B. (2002). Doručak šampiona: tajne sportske farmakologije: Lexia. [Breakfast of champions: secrets of sports pharmacology].

MODELING ISOKINETIC STRENGTH IN RECREATIONAL ADOLESCENT KARATE ATHLETES

Gun Do Kim¹ and Willy Pieter²

¹*Semyung University, Republic of Korea*

²*Masaryk University, Czech Republic*

Abstract

The purpose of this study was to model isokinetic strength in adolescent recreational karate athletes. Subjects (7 males, 17.21±2.63 years, 1.67±0.05 m, 57.68±10.19 kg and 5 females, 18.50±1.28 years, 1.64±0.04 m, 58.22±6.43 kg) were recruited from a local karate club. Gravity-corrected strength was assessed on a Biodex 3 isokinetic machine at 120°/s and 300°/s during extension and flexion of the dominant kicking leg. Collapsed over gender, absolute peak torque during extension at 120°/s (148.12±35.63 Nm) was higher than during flexion at 120°/s (66.15±18.49 Nm) ($d=3.03$, 95% CI: -17.13–13.49). Flexion at 120°/s (23.91±6.07 Nm^{3.069}) was lower than extension at 300°/s (36.96±7.58 Nm^{3.069}) ($d=1.65$, 95% CI: -5.60–5.94). It is suggested that geometric similarity may not apply to isokinetic strength in adolescent karate athletes.

Key words: *Scaling, peak torque, karate, dimensionality*

Introduction

Isokinetic strength in young combat sport athletes was investigated before. Pieter and Bercades (2005) studied young American (inter)nationally competitive taekwondo athletes (boys: 14.51±1.51 years, girls: 14.54±1.66 years) to assess isokinetic peak torque of the main kicking leg during extension and flexion at the knee joint in absolute terms and relative to body mass and lean body mass at 180°/s, 240°/s and 300°/s. There was no gender and angular velocity interaction for absolute isokinetic peak torque, although the effect was not clear ($\eta^2=0.051$, 95% CI: -0.008–0.436). It was higher during leg extension in the boys (63.17±18.09 Nm vs. 34.21±10.38 Nm, $d=1.92$, 95% CI: -3.49–5.77) and flexion (47.96±8.98 Nm vs. 26.67±6.75 Nm, $d=2.63$, 95% CI: -0.06–5.13) but the effects were not clear. Relative to body mass, peak torque was higher for the boys (0.91±0.13 vs. 0.73±0.10 Nm/kg, $\eta^2=0.403$, 95% CI: 0.144–0.551). The ratio standard adequately controlled for the effect of body mass ($r=-0.02$, 95% CI: -0.318–0.282 for the boys and $r=-0.12$, 95% CI: -0.472–0.265 for the girls). Few studies are available on isokinetic strength in young karate athletes.

Previous work on Malaysian female recreational karate and taekwondo athletes showed a large Movement*Angular velocity interaction for both absolute peak torque ($\eta^2=0.909$, 95% CI: 0.418–0.997) and when scaled to height² ($\eta^2=0.905$, 95% CI: 0.427–0.997) (Aiwa and Pieter, 2006). The purpose of this study, then, was to assess isokinetic strength characteristics in adolescent recreational *karateka* (karate athletes/practitioners).

Materials and Methods

Subjects (5 females, 18.50±1.28 years, 1.64±0.04 m, 58.22±6.43 kg and 7 males, 17.21±2.63 years, 1.67±0.05 m, 57.68±10.19 kg) were members of a karate state team in Malaysia. Isokinetic concentric strength was assessed on a Biodex System 3 (Biodex Medical Systems, Inc. New York, NY, USA) during extension and flexion of the preferred kicking leg at the knee joint at 120°/s and 300°/s (3 repetitions at each angular velocity with a 1-minute rest between angular velocities). Percent fat was estimated from equations based on Asians (Deurenberg-Yap et al., 2000) and lean body mass (LBM) subsequently derived.

Peak torque was calculated as the highest torque in the isokinetic phase of the range of motion at the preset angular velocity. The dominant leg with which the athletes kicked was used. Gender differences were first assessed in absolute terms. Isokinetic strength was also compared relative to height and lean body mass using the theoretical exponents: h^2 and $kg^{0.67}$ LBM (lean body mass) (e.g., Åstrand et al., 2003). Relative peak torque was subsequently compared using empirically derived exponents for height and LBM.

A 3-way (Gender*Movement*Velocity) ANOVA with repeated measures on the second and third factors was used to determine differences between gender, extension/flexion and angular velocity. The level of significance was set to an effect size of 0.20.

Results

Table 1 depicts the means and standard deviations of absolute peak torque in Malaysian adolescent recreational *karateka*. There was a Movement*Angular velocity interaction for absolute peak torque ($\eta^2=0.881$, 95% CI: 0.792–

0.983). Table 2 shows the probability matrix resulting from the simple effects analysis. There also were main effects for Movement ($\eta^2=0.754$, 95% CI: 0.586–0.962) and Angular velocity ($\eta^2=0.923$, 95% CI: 0.863–0.989).

Table 1: Descriptive statistics for absolute peak torque (Nm) in male and female karateka

	Males (n=7)	Females (n=5)
Extension 120°/s	159.26 ± 43.83	132.52 ± 9.27
Flexion 120°/s	73.89 ± 19.34	55.32 ± 11.28
Extension 300°/s	107.57 ± 25.67	94.08 ± 14.91
Flexion 300°/s	80.84 ± 23.09	64.24 ± 24.09

Table 2: Probability matrix (95% CI) of the simple effects analysis of the Movement*Angular velocity interaction for absolute peak torque (Nm)

	A. 'E120/s	B. 'F120/s	C. 'E300/s	D. 'F300/s
A. 148.12 ± 35.63	--			
B. 66.15 ± 18.49	d = 3.03 (-17.13 – 13.49)	--		
C. 101.95 ± 22.10	d = 1.60 (-18.5 – 14.10)	d = 1.76 (-10.74 – 12.23)	--	
D. 73.93 ± 23.98	d = 2.49 (-17.67 – 16.06)		d = 1.22 (-11.29 – 14.78)	--

'E = extension; F = flexion

When peak torque was scaled to height (m^2), there again was a Movement*Angular velocity interaction ($\eta^2=0.870$, 95% CI: 0.773–0.981). Table 3 displays the probability matrix resulting from the simple effects analysis. There also were main effects for Movement ($\eta^2=0.740$, 95% CI: 0.565–0.960) and Angular velocity ($\eta^2=0.913$, 95% CI: 0.847–0.988).

Allometric scaling using the theoretical exponent controlled for the effect of the body size variable in the boys at 120°/s for leg extension ($r = -0.07$, 95% CI: -0.62–0.53), at 120°/s for flexion ($r=0.16$, 95% CI: -0.46–0.67), at 300°/s for extension ($r = 0.04$, 95% CI: -0.55–0.60) as well as at 300°/s for flexion ($r=0.16$, 95% CI: -0.46–0.67) but all effects were unclear. The values for the girls were: $r=-0.57$ (95% CI: -0.86–0.01) for extension at 120°/s, $r=0.41$ (95% CI: -0.21–0.80) for flexion at 120°/s, $r=0.03$ (95% CI: -0.55–0.59) for extension at 300°/s and $r=0.22$ (95% CI: -0.41–0.71) for flexion at 300°/s. However, the effects were also unclear.

Table 3: Probability matrix (95% CI) of the simple effects analysis of the Movement*Angular velocity interaction for peak torque relative to height (Nm/m²)

	A. 'E120/s	B. 'F120/s	C. 'E300/s	D. 'F300/s
A. 53.78±12.82	--			
B. 23.91±6.07	d=3.16 (-4.09–6.60)	--		
C. 36.96±7.58	d=1.65 (-5.60–5.94)	d=1.91 (-2.38–5.35)	--	
D. 26.72±8.29	d=2.56 (-4.69–7.25)		d=1.29 (-3.00–5.98)	--

'E=extension; F=flexion

With 0.67 as the scaling exponent for LBM, there was a Movement*Angular velocity ($\eta^2=0.875$, 95% CI: 0.779–0.982). Table 4 displays the probability matrix resulting from the simple effects analysis. There also were main effects for Movement ($\eta^2=0.738$, 95% CI: 0.562–0.960) and Angular velocity ($\eta^2=0.914$, 95% CI: 0.847–0.988).

Table 4: Probability matrix (95% CI) of the simple effects analysis of the Movement*Angular velocity interaction for peak torque relative to LBM (Nm/kg^{0.67})

	A. 'E120/s	B. 'F120/s	C. 'E300/s	D. 'F300/s
A. 11.70±2.56	--			
B. 5.17±1.11	d=3.56 (2.11–4.19)	--		
C. 8.04±1.51	d=1.80 (0.35–2.65)	d=2.19 (1.34–2.82)	--	
D. 5.78±1.66	d=2.84 (1.36–3.74)		d=1.43 (0.57–2.37)	--

'E = extension; F = flexion

Allometric scaling using the theoretical exponent controlled for the effect of the body size variable in the boys at 120°/s for leg extension ($r=-0.10$, 95% CI: -0.64–0.50), at 120°/s for flexion ($r=0.35$, 95% CI: -0.28–0.77), at 300°/s for

extension ($r=-0.03$, 95% CI: $-0.59-0.55$) as well as at 300°/s for flexion ($r=0.26$, 95% CI: $-0.37-0.73$). The values for the girls were: $r=-0.45$ (95% CI: $-0.81-0.17$) for extension at 120°/s, $r=0.78$ (95% CI: $0.37-0.94$) for flexion at 120°/s, $r=0.34$ (95% CI: $-0.29-0.77$) for extension at 300°/s and $r=0.70$ (95% CI: $0.21-0.91$) for flexion at 300°/s. However, for both boys and girls, the effects were unclear

Regression diagnostics revealed that height had the same effect on peak torque in boys ($a=3.132$, SE=1.321, 95% CI: $0.416-5.848$) and girls ($a=2.598$, SE=2.141, 95% CI: $-1.901-7.097$). The exponent for height was 3.069 (SE=2.233, 95% CI: $-1.429-7.567$), which was statistically not different from the theoretical exponent of 2.

When peak torque was scaled to height^{3.069}, there was a Movement*Angular velocity interaction ($\eta^2=0.862$, 95% CI: $0.758-0.980$). Table 5 displays the probability matrix resulting from the simple effects analysis. There also were main effects for Movement ($\eta^2=0.732$, 95% CI: $0.554-0.959$) and Angular velocity ($\eta^2=0.906$, 95% CI: $0.833-0.987$).

Table 5: Probability matrix (95% CI) of the simple effects analysis of the Movement*Angular velocity interaction for peak torque relative to height using an empirically derived exponent ($Nm/m^{3.069}$)

	A. 'E120°/s	B. 'F120°/s	C. 'E300°/s	D. 'F300°/s
A. 53.78±12.82	--			
B. 23.91±6.07	d=3.16 (-4.09–6.60)	--		
C. 36.96±7.58	d=1.65 (-5.60–5.94)	d=1.65 (-5.60–5.94)	--	
D. 26.72±8.29	d=2.56 (-4.69–7.25)		d=1.29 (-3.00–5.98)	--

'E=extension; 'F=flexion

Allometric scaling using the empirically derived exponent controlled for the effect of body size in the boys at 120°/s for leg extension ($r=-0.18$, 95% CI: $-0.68-0.44$), at 120°/s for flexion ($r=0.03$, 95% CI: $-0.55-0.59$), at 300°/s for extension ($r=-0.10$, 95% CI: $-0.64-0.50$) as well as at 300°/s for flexion ($r=0.04$, 95% CI: $-0.55-0.60$), although the relationships were not clear. The values for the girls were: $r=-0.72$ (95% CI: $-0.92-0.24$) for extension at 120°/s, $r=0.25$ (95% CI: $-0.38-0.72$) for flexion at 120°/s, $r=-0.16$ (95% CI: $-0.67-0.46$) for extension at 300°/s and $r=0.14$ (95% CI: $-0.47-0.66$) for flexion at 300°/s. However, the effects were not clear.

Regression diagnostics revealed that LBM had the same effect on peak torque in boys ($a=1.119$, SE=2.348, 95% CI: $-3.707-5.946$) and girls ($a=-2.975$, SE=4.421, 95% CI: $-12.265-6.314$). The exponent for LBM was 1.167 (SE=0.55, 95% CI: $0.050-2.284$), which is statistically not different from the theoretical exponent of 0.67.

When peak torque was scaled to LBM^{1.167}, there was a Movement*Angular velocity interaction ($\eta^2=0.866$, 95% CI: $0.581-0.962$). Table 6 displays the probability matrix resulting from the simple effects analysis. There also were main effects for Movement ($\eta^2=0.720$, 95% CI: $0.249-0.916$) and Angular velocity ($\eta^2=0.902$, 95% CI: $0.680-0.972$).

Table 6: Probability matrix (95% CI) of the simple effects analysis of the Movement*Angular velocity interaction for peak torque relative to lean body mass using an empirically derived exponent ($Nm/kg^{1.167}$)

	A. 'E120/s	B. 'F120/s	C. 'E300/s	D. 'F300/s
A. 11.70 ± 2.56	--			
B. 5.17±1.11	d=3.56 (2.11–4.19)	--		
C. 8.0± 1.51	d=1.80 (0.35–2.65)	d=2.19 (1.34–2.82)	--	
D. 5.78±1.66	d=2.81 (1.36–3.74)		d=1.43 (0.57–2.37)	--

'E=extension; 'F=flexion

Allometric scaling using the empirically derived exponent controlled for the effect of the body size variable in the boys at 120°/s for leg extension ($r=-0.33$, 95% CI: $-0.76-0.30$), at 120°/s for flexion ($r=0.02$, 95% CI: $-0.56-0.59$), at 300°/s for extension ($r=-0.310$, 95% CI: $-0.75-0.32$) as well as at 300°/s for flexion ($r=-0.02$, 95% CI: $-0.59-0.56$). The values for the girls were: $r=-0.75$ (95% CI: $0.31-0.93$) for extension at 120°/s; $r=0.64$ (95% CI: $0.10-0.89$) for flexion at 120°/s; $r=0.02$ (95% CI: $-0.56-0.59$) for extension at 300°/s and $r=0.65$ (95% CI: $0.12-0.89$) for flexion at 300°/s. However, not all relationships were clear.

Discussion

In American adolescent counterparts competitive at the (inter)national level, there also was a Movement by Angular velocity interaction ($\eta^2=0.538$, 95% CI: $0.121-0.891$) for absolute peak torque (Pieter and Bercades, 2005). Since the Americans were younger than the Malaysians, the differences between the two studies may be due to maturity status (Malina et al., 2004; Rowland, 2005).

According to Froberg and Lammert (1996), the relationship between maturity and strength is more pronounced in boys than in girls. The difference in strength between early maturing boys and their normal and late maturing counterparts is especially evident between 13 and 16 years of age. Once the normal and late maturing boys catch up in late adolescence, absolute strength differences decrease. In girls, the strength difference between early maturing and normal and late maturing counterparts is most apparent between 11 and 15 years. The difference in late adolescence is smaller than in boys (Froberg and Lammert, 1996).

The age range of the American taekwondo athletes was between 11.50–17.67 years in boys and 11.92–17.33 years in girls. The median of self-assessed pubic hair development according to the Tanner stages was 4 in both boys and girls. However, 21.43% of the girls were pre-menarcheal (W. Pieter, unpublished data). No maturity assessment was done for the Malaysians, but the age range for the boys was 13.75–20.08 years and for the girls, 15.42–17.92 years.

The difference in age and maturation between the American and Malaysian adolescents and their effect on strength may also have been mediated by neuromotor maturation and control (Blimkie and Sale, 1996). More mature or older boys and girls may be better able to exert a higher level of neural drive and motor units recruited (Froberg and Lammert, 1996). This information is based on both isometric and isokinetic strength investigations, so it might be that the biological differences between the Americans and Malaysians had their effect on not only the statistical interactions and main effects as alluded to above, but also with regards to the effect sizes.

As mentioned above, according to dimensionality theory, peak torque should be scaled to height² to control for size differences when comparing groups, since strength is related to cross-sectional area of the contracting muscles (Åstrand et al., 2003; Malina et al., 2004; Rowland, 2005). However, it was also found that strength increased at a greater rate to height than predicted by geometric similarity theory (Rowland, 2005), while others have suggested that humans, both athletic and sedentary, may not be geometrically similar in strength (Nevill et al., 2004). The empirically derived exponent for our subjects was 2.418 (95% CI=-0.960–5.797), which is statistically not different from 2, but this may be due to the small sample size (Malina et al., 2004).

Scaling isokinetic peak torque to height² did not control for the effect of the body size variable in the boys. In other words, peak torque in the girls could sufficiently be explained by muscle cross-sectional area. In the boys, strength may be more a function of size-independent factors, such as neurological factors, muscle contraction and fiber architecture (Rowland, 2005), i.e., qualitative dimensions. Muscle tissue may not lend itself to scaling according to geometric expectations due to individual variations in fiber length, angle of pennation, type of bony insertion, and division of fibrous septa (Rowland, 2005).

Conclusions

Scaling isokinetic peak torque to height² did control for the influence of the body size variable in the girls but not in the boys. Qualitative factors are suggested to be at the basis of this difference. The results seem to partially support the claim that, as far as isokinetic strength is concerned, geometric similarity may not apply (Nevill et al., 2004). Future studies should compare theoretical strength exponents to those empirically derived in a larger sample.

References

1. Aiwa, N. and Pieter, W. (2006). Isokinetic strength in Malaysian adolescent female athletes. Southeast Asia Women in Sports Conference 2006, Kuala Lumpur, September 21-22.
2. Åstrand, P. O., Rodahl, K., Dahl, H. A. & Stromme, S. (2003). Textbook of Work Physiology. Physiological Bases of Exercise. 4th ed. Champaign, IL: Human Kinetics.
3. Blimkie, C. J. R. and Sale, D. G. (1996). Strength development and trainability during childhood. In: E. Van Praagh (ed.), Pediatric Anaerobic Performance (pp. 193-224), Champaign, IL: Human Kinetics.
4. Deurenberg-Yap M., Schmidt G., Van Staveren W. A. and Deurenberg P. (2000), The paradox of low body mass index and high fat percentage among Chinese, Malays and Indians in Singapore, International Journal of Obesity. 24: 1011-1017.
5. Froberg, K. and Lammert, O. (1996). Development of muscle strength during childhood. In O. Bar-Or (Ed.), The Child and Adolescent Athlete (pp. 25-41). Volume VI of the Encyclopedia of Sports Medicine. An IOC Medical Commission Publication, Oxford: Blackwell Science.
6. Malina, R. M., Bouchard, C. and Bar-Or, O. (2004). Growth, Maturation, and Physical Activity, Champaign, IL: Human Kinetics.
7. Nevill, A. M., Stewart, A. D., Olds, T. and Holder, R. (2004). Are adult physiques geometrically similar? The dangers of allometric scaling using body mass power laws. Am J Phys Anthro, 124, 2: 177-182.
8. Pieter, W. and Bercades, L. T. (2005). Isokinetic peak torque in American Junior Olympic athletes. 2005 KASPERD International Sport Science Congress, Chuncheon, Korea, August 25-27.
9. Rowland, T. W. (2005). Children's Exercise Physiology. Champaign, IL: Human Kinetics

Acknowledgments

The authors are grateful to Aiwa, Erie, Nawawi and Jamaayah for assistance with data collection.

THE ASSOCIATION BETWEEN PHYSICAL DEVELOPMENT AND SPORTS TRAINING IN SPECIALIZED ICE HOCKEY CLASSES

Marek Kokinda

Faculty of Sports, University of Prešov, Slovačka

Abstract

Effective selection of children with talent for sports requires longitudinal research based on innovative approaches in confrontation with training practice and scientific knowledge. The paper presents a partially innovated approach to the selection and sports training of children with talent for sports. The process of primary assessment included a measurement procedure assessing 4 body dimensions: *body height*, *body mass*, *chest girth* and *head girth*. These data form the basis for the evaluation of the symmetry of body morphology. The state of the musculoskeletal system was assessed through administration of muscle balance tests in 6th and 7th grade hockey players during 2013/2014 hockey season. After baseline assessment of muscle balance, hockey players participated in an intervention program that included exercises aimed to moderate the extent of muscle imbalance. Upon the completion of the intervention program statistically significant changes were observed in shoulder and hip joint flexibility.

Key words: *somatic parameters, physical conditioning, team sports*

Introduction

Each sport bears stable characteristics that can be utilized in predicting potential results. Among relevant parameters in young athletes are anthropometric and morphological parameters that underlie strength, speed, endurance, flexibility and adaptation to various environmental conditions. These parameters determine work capacity, recovery and competition results. The control over the dynamics of anthropometric and morphological parameters allows for continuous monitoring of physical development. This enables both to recommend a specific type of sport to beginning athletes and to continuously plan the training process. One-sided exercise sustained by young ice hockey players overstrains the musculoskeletal system, especially hips, lumbar spine, trunk rotators and the shoulder girdle, which may contribute to the decrease in sports performance. Muscle imbalance originates due to decline in the elasticity of the postural muscles and the loss of active tone in the phasic muscles (Jarkovská & Jarkovská, 2005). To exercise major muscle groups within kinetic chains of hockey players compensatory exercises seem to be one of the most effective methods. These exercises affect not only the passive part of the locomotor system, but also the active part of the system consisting of respective muscle groups. Compensatory exercises aid in harmonizing the physical development and positively affect the functioning of body organs (Bursová, 2005).

Methods

The study participants were U12 to U14 ice hockey players of hockey team HC Košice. Descriptive characteristics of study participants are presented in Table 1.

Table 1: Sample characteristics

n	Age	Body height (cm)		Body mass (kg)		Chest girth (cm)		Head girth (cm)		Stick holding	
	x	x	s	x	s	x	s	x	s	Right	Left
27	13	158.2	8.6	49.1	9.2	79.6	6.9	53.9	1.5	5	22

Present study is based on a longitudinal research study conducted in Russia. The study analyzed body dimensions and circumferential measures on large population samples. The analysis was carried out to continuously assess body height, body mass, chest girth and head girth according to actual morphological and phenotypic measures (Guba, 1999; Guba, 2008). This method enables to monitor gains in body height, body mass, chest and head girths together with sport-specific exercise volume and intensity, which are used to assess the harmoniousness of the morphological state of human organism. Proportional physical development determined according to maximal difference between values of percentile scales in measures of body height, body mass, chest girth and head girth:

- 0 – 2 harmonious development
- 3 disharmonious development
- 4 – 7 accelerated disharmonious development.

If the numeral difference between percentile intervals between two measures does not exceed the value of 1, development is considered to be harmonious. In case the difference between two values equals 2, development is regarded as disharmonious. If the difference exceeds the value of 3, development is considered to be accelerated, disharmonious and heterogeneous. This method is based on the knowledge that all variants of the studied measure are distributed over ranges from minimal to maximal values via mathematical procedure, which divides the scale into 100 equal parts. Percentile tables enable to assign children according to age and gender into respective groups. The scale used proposes the limits of corridors expressed in percentiles 3%, 10%, 25%, 50%, 75%, 90%, 97%. Their dimension is not identical. Physical development is most frequently controlled using two versions of percentile standards:

- Univariate percentile scales (*the assessment of the distribution of measures according to age and gender*).
- Graphical illustration via nomograms (*the assessment of body mass distribution to body height*).

Each parameter measured is located in the respective percentile interval shown in Table 2.

Test battery used to assess muscle balance and joint flexibility was devised by Neumann (2003) and is used to assess:

- Body posture in upright stance *Matthiase test*.
- Abdominal muscles, back muscles and flexibility of lumbar spine *Kraus-Weber test*.
- Leg raises in supine position.
- Sit and reach.
- Broomstick twists.
- Side bends.

Ice hockey players were tested at the beginning of 2013/2014 season. Players performed compensatory exercises for 60 minutes twice per week. The intervention included exercises to strengthen body core in the pelvic floor area and to increase the maximal range of motion to improve muscle and joint flexibility. Post-intervention testing was administered at the end of the season. The effect of the intervention program was determined using t-test for dependent samples. The level of significance between pairs of data was set at $p < .05$; $p < .01$.

Results

According to the measure of dispersion of a distributed random variable (*percentile*) percentage performance was expressed by median (50%) on a scale ranging from 3% to 97%. This parameter indicates the placement of players within the reference group. Investigated measures classified above an average morphological profile may be considered to be indicative of high degree of physical development (see Table 2).

Table 2: Percentile interval of body height, body height, chest girth and head girth

AGE	BODY HEIGHT							BODY MASS						
	Percentile interval							Percentile interval						
	1	2	3	4	5	6	7	1	2	3	4	5	6	7
	3%	10%	25%	50%	75%	90%	97%	3%	10%	25%	50%	75%	90%	97%
12	143.7	145.2	147.0	150.5	157.0	160.0	162.2	33.3	36.0	39.5	42.5	47.6	58.2	62.1
13	145.0	150.6	152.5	155.0	157.5	170.4	176.1	34.2	38.6	41.7	45.2	55.0	65.5	66.3
14	153.3	155.7	160.5	164.5	168.8	173.8	178.5	42.8	46.0	49.2	53.9	58.2	67.2	67.6
	CHEST GIRTH							HEAD GIRTH						
12	67.8	69.0	70.8	74.5	79.3	86.1	88.6	51.4	52.0	53.0	54.3	55.0	56.0	56.7
13	65.0	72.2	75.0	80.0	85.0	90.4	92.5	51.5	52.0	53.0	54.0	54.5	55.2	56.0
14	68.0	73.2	77.8	82.5	84.8	85.5	87.8	52.0	52.0	53.6	54.0	55.0	55.6	57.0

Physical development in ice hockey players aged 12, 13 and 14 years was found to be predominantly disharmonious or both accelerated and disharmonious. The numerical difference between percentile intervals between corridor values 3, 4 and 5 showed harmonious development for both circumferential measures of the head. Table 3 shows the assessment of body height, body mass, chest girth and head girth.

Table 3: Assessment of body height, body mass, chest girth and head girth

Percentile interval (%)	Assessment of measures	Number of percentile corridor
1 – 3	Very low	1
3 – 10	Low	2
10 – 25	Below average	3
25 – 50	Average	4
50 – 75	Moderately above average	5
75 – 90	Above average	6
90 – 97	High	7

The analysis of the musculoskeletal system aimed to assess muscle balance and joint flexibility is a means of finding alternatives to training activity. Binary assessment, i.e. *pass/fail* met standards reported by Neuman (2003). The administration of *Matthias test* (Bös et al., 2001) did not reveal poor body posture. *Kraus-Weber test* consists of 6 items, which the participants completed successfully. Table 4 shows statistically significant changes between pre-intervention and post-intervention measurements. For hip flexibility, statistically significant changes were recorded in sit and reach test ($p < .01$). According to Bunc et al. (2000) performance in the sit and reach test can be classified as above average. However, the changes induced by intervention were not statistically significant. Compared to results on shoulder girdle flexibility reported by Memi and Carbono (1992), pre-intervention values in shoulder flexibility test were classified as average. Upon completion of intervention, there was a statistically significant improvement in shoulder girdle flexibility ($p < .05$). For the side bends test, it is logical to assume differences between side bend to the right and to left side due to holding the stick to either of two sides. Such assumptions were found to be untrue as there were no statistically significant differences between side bend to the right and to the left.

Table 4: Arithmetic means, standard deviations and paired “t” test values of pre-testing and post-testing (n = 27)

VARIABLES:		X ₁ X ₂	S ₁ S ₂	t test
Leg raises in supine position	right	96.85 105	9.82 7.59	-5.14**
	left	95.18 101.11	9.65 9.02	-3.20**
Sit and reach		12.62 13.31	4.71 4.66	-1.51
Broomstick twist		73.14 70.22	12.58 13.71	2.21*
Side bend	right	37.40 36.92	3.42 3.06	0.68
	left	37.70 38.07	3.30 3.36	-0.70

Discussion and conclusions

The rate of biological development in children of various ages was determined on the basis of computed constants (percentage of children in initial and final stage of physical development). The subsequent analysis was conducted to collect data on developmental measures at the level of 25% – 50% – 75% percentile (Guba, 2008). The application of this method with respect to continuous assessment enables to track gains in body height and mass, chest girth and head girth together with the sport-specific exercise volume and intensity. Body surface is not a measure determining individual functional and morphological characteristics of human organism. Analogous testing in sports games reveals errors made during initial orientation phase and its overall biomechanical disproportion in particular types of sport. Previous research reports that sporting achievements between 10 and 13 years of age in cyclic sports are determined 80 percent by biological development. This approach is based on sporting success at a particular age. With respect to stages of development, morphological and biomechanical characteristics along with rational technique, which meets the criteria of the most appropriate body types, are one of primary preconditions. Compensatory exercise enables to moderate the effects of one-sided exercise sustained by ice hockey players. In some cases, such one-sided exercise may lead to overload of human organism. The assessment of the musculoskeletal system is the basis for designing exercises including mobility, stabilization and strengthening forms of exercise. Compensatory exercises applied in specialized 6th and 7th grade ice hockey players appears to be one of training alternatives in young players. With regard to physical development the present method may be applied to monitor gains in particular parameters in relation to somatic characteristics of players.

References

1. Bös, K., et al. (2001). *Handbuch motorische Tests*. Göttingen: Hogrefe.
2. Bunc, V., et al. (2000). *Školní mládež v konci dvacátého století (Projekt VS 97 131: Závěrečná správa)*. Praha: UK FTVS Praha.
3. Bursová, M. (2005). *Kompenzační cvičení*. Praha: Grada Publishing, a. s.
4. Guba, V.P. (1999). Morfobiomechanický podchod kak osnova vozrastnogo fizičeskogo vospitanija i sporta. *Naučno-metod. žurnal. Fiz.Kul't.*, No 3-4, 11-29.
5. Guba, V.P. (2008). Innovacionnaja metodologija i tehnologija rannej sportivnoj orientaciji i otbora. *XII. Meždunarodnyj naučnyj kongress "Sovremennyj olimpijskij i paraolimpijskij sport i sport dľa vsech"*. Tom I. Moskva: 2008. RGUFKS, 157-158. UDK 796.032 S 56.
6. Jarkovská, H., & Jarkovská, M. (2005). *Posilování s vlastním telem 417 krát jinak*. Praha: Grada Publishing, a.s.
7. Merni, F., Carbonaro, G., & Dal Monte, A. (1992). *Test motori. Per la valutazione dei giovani dagli 11 ai 14 anni*. Roma: Scuola dello Sport.
8. Neuman, J. (2003). *Cvičení a testy obratnosti, vytrvalosti a síly*. Praha: Portál.

CHANGES IN PHYSICAL DEVELOPMENT, PHYSICAL FITNESS AND FUNCTIONAL CAPACITY OF YOUNG BASKETBALL PLAYERS AGED 16-19 YEARS

Rūtenis Paulauskas¹, Rūta Dadelienė¹ and Mindaugas Balčiūnas²

¹Lithuanian University of Educational Sciences, Vilnius, Lithuania

²Lithuanian Sports University, Kaunas, Lithuanian

Abstract

The most capable young Lithuanian basketball players demonstrate higher anthropometric indices than their non-athlete peers, but in the period of 16-19 years of age, their growth rates are similar. It was established that muscle mass rapidly grew from 17 and static muscle strength significantly increased from 18 years of age. This was affected by both physical load and physiological patterns of growth.

We found that although the single muscle contraction power increased during the study period, the results were insufficient due to low jump height and take-off speed. It can be assumed that the individual muscle power adaptation of each player throughout the season has not been focused on the increase of those abilities.

Key words: *anthropometry, power, agility, reaction time*

Introduction

Lithuanian basketball players have achieved many significant sports victories in the world sports arenas: winners of the third place in the Olympic Games (1992, 2000, 2004), European champions (1938, 1939, 2004), and prize-winners (2013). For this reason the selection of young players and their training in Lithuania is given a high priority. Sport affects some somatic physical development indicators (Janz et al., 2000; Maiton et al., 2007); however, the effect of basketball practice sessions on the physical development and fitness of young players has not been studied enough, especially little research has been carried out on the changes of these indicators in the period of several years aiming at high performance. It is important to highlight characteristic features of young basketball players' physical development, physical fitness and functional capacity.

Research object was changes in physical development, physical fitness and functional capacity of Lithuanian young basketball players aged 16-19 years aiming at high performance (candidates of the Lithuanian national teams in different age groups).

Research aim was to investigate changes in physical development, physical fitness and functional capacity of Lithuanian young basketball players aged 16-19 years, candidates of the Lithuanian national teams of those ages, in the period of four years and establish characteristic features for basketball players.

Subjects. The study involved 16-19-year-old basketball players (n=14) who were in Lithuanian national teams in different age groups.

Methods

Research was carried out four times in 2004-2007 – in summer of each year during the period of the preparation for the European and world championships for basketball players of this age.

Physical development was studied using the proposed methodology by North, Olds (1996) measuring the players' height (cm), the height of the arm reach (cm), lung volume (LV), arm grip strength of the right and the left hands (kg), fat and muscle mass.

The power of single muscle contraction (Bosco et al., 1983) and anaerobic alactic muscle power (AAMP) were established (Margaria et al., 1966). Agility was tested using the "hexagonal test" - measuring the time it takes to jump three circles behind all the sides of a rectangle (Brittenham, 1998). Psychomotor simple reaction time (SRT) to visual stimulus was measured as well as movement frequency (Tapping test) within 10s. The functional capacity of the circulatory system was tested determining the heart rate (HR) at rest (beats / min), as well as in response to a standard physical load (30 squats within 45 s) and during 60s recovery. The blood pressure was measured at rest.

Research findings were processed using methods of mathematical statistics, calculating the arithmetic mean (\bar{X}), standard deviation (S), dispersion range was calculated as the difference between the smallest and the largest values in the data. Reliability of the difference between the mean indices of the groups of subjects was established applying the method of the analysis of variance (ANOVA).

Results

Studies showed that the tested basketball players grew little in three years (Table 1), the average increase in height (3.86 cm) was not statistically significant ($p > 0.05$). The height the players' arm reach increased by 7.41 cm, but the difference was not statistically significant ($p > 0.05$). Body weight was increasing every year, and within three years it increased by 13.3 kg, and this increase was statistically significant ($p < 0.004$). BMI also changed with the changes in body height and weight. Every year it was increasing and it increased from 20.85 to 23.44 ($p < 0.01$). Muscle mass increased mainly between 17 and 18 years of age, which made up 4.58 kg ($p < 0.04$). Within three years, muscle mass increased even by 8.16 kg ($p < 0.01$). During the research period body fat mass altered insignificantly - from 7.66 to 9.56 kg on average.

Analysis of the physiometric physical development indices (Table 1) showed that during the first year of study the average handgrip strength indices did not increase and even tended to decrease. Comparing the handgrip strength indices of the second and the third study we observed the tendency of increase, the handgrip strength of the right and the left hands increased by 3.97 and 3.86 kg, but the difference was not statistically significant. The handgrip strength mostly increased from the third to the fourth study – it was 9.59 and 12.50 kg ($p < 0.002$ and 0.001). The analysis of changes in the lung volume indices during the period of three years did not reveal any significant changes.

The data in Table 2 show that the jump height of the young basketball players during the first three years decreased by 4.59 cm on average. This negative change was statistically significant, but it could be hardly explained theoretically. In other years of the studies the changes in the jump height were insignificant. Take-off time in the first year did not get any shorter, but in the second year it decreased by 26.68 ms ($p < 0.04$), in the third year the decrease in the take-off time was low. Changes in single muscle contraction power (SMCP) were similar to those in the jump height indices. In the first year, this power decreased by 139 W, but that was not statistically significant. In the second year, SMCP increased significantly – by 417 W ($p < 0.01$). In the third year, the increase was lower - 216 W and statistically insignificant. SMCP total increase over the three years (494 W) was statistically significant ($p < 0.001$). AAMP gradually increased during the three years and the group average increase from 1252 to 1517 W was statistically significant ($p < 0.001$). The agility averages of the groups were better and better each year and improved from 13.99 to 10.83 s ($p < 0.001$).

The average simple reaction time (SRT) of the group did not change in the first year, in the second year it became slightly shorter, and in the third year the progress was considerable, it decreased from 183.08 to 170.00 ms ($p < 0.02$). Movement frequency did not increase during the first year, during the second year the progress was low, and in the third year it significantly increased. The overall increase in the frequency of movements by 7.33 in 10 s was statistically significant ($p < 0.03$).

Discussion

Young basketball players' height did not significantly change within the three years of studies, and their growth rates were similar to those of non-athletes in the same age cohort (Eurofitas, 2002). The best Lithuanian young basketball players are almost 10 percent higher than non-athletes of the same age (Eurofitas, 2002). Previous studies have shown that sports training does not affect the height; the height is determined by selection and genetically inherited growth rates (Malina, 1997, Torres-Unda et al., 2013).

The height of arm reach shows what advantage a basketball player gains fighting in the vertical plane, blocking the throw and making a shot. Although this indicator has been little studied, it remains one of the most important anthropometric parameters of basketball players.

Basketball players have larger muscle mass than long-distance runners, but lower than sprinters and weightlifters (Spent et al., 1993). For our players, significant muscle mass gain was observed between the ages of 17 and 18 years. This indicates that only at this time of training more attention was paid to develop hypertrophic muscular strength. It is also the time when the natural increase in power is observed (Carter et al., 2007). Some researchers argue that the development of dynamic strength is possible not only in adolescence, but even in childhood (Faigenbaum et al., 2009). That would help basketball players achieve better muscle power indicators and use that in matches. Basketball players' fat body mass and body mass during the entire study period remain of the optimal level (Hoffman, 2006).

The jump height of the best 16-year-old Lithuanian basketball players is not significantly different from that of the strongest players of the same age from Croatia (Trninič et al., 2001). Hoffman (2006) argues that the 62.67 cm result is assessed as moderate. Young basketball players' jump height statistically significantly decreased during the first year. Although it is difficult to explain, the result varied from moderate to poor. The average jump height of 18-year-old U.S. players is 70.4 ± 6.1 cm, and those from Australia - 65.5 ± 7.1 cm (Hoffman, 2006; Ellis et al., 2000). This suggests that the issues of long-term training of players in Lithuania are really relevant.

During the study period, the increased single muscle contraction power is associated with a significant increase in the take-off speed and body weight. The high speed of muscle contraction can compensate the lack of strength aiming at high muscle power in a very short activity (Kawamori, Haff, 2004).

Throughout the study period, alactic anaerobic muscle power level of our investigated young basketball players can be assessed as moderate (Fox et al., 1993). During the three years of training it statistically significantly increased. However, a comparison of these results with those of elite players shows that young players are not yet comparable to adults (Hoffman, 2006). There are therefore very rare cases when 16-18-year-old players could successfully compete in men's teams.

Agility is a complex physical ability which is also affected by other physical and functional parameters of the body (Young, Farrow, 2006). During the study period, agility significantly improved, and this shows improved movement speed, accuracy, strength, body balance and motor control.

During the game, there are a lot of situations where the speed of psychomotor reaction is evidenced: catching, passing, blocking the ball. This is related to the complex activity of the human nervous system and muscle function (Ratamess, 2012). We can see that simple psychomotor reaction speed increased during the last phase of the investigation - from 18 to 19 years of age, but the achieved result was moderate (Hoffman, 2006). Another important indicator of the nervous system flexibility is the movement frequency, which shows the ability of the players' central nervous system to quickly switch from excitation to inhibition, and vice versa. This determines the frequency of athletes' movements. Within the period of four years, our players' frequency of movements improved and reached the average indices of elite players.

Table 1: Changes in the physical development indices of Lithuanian young basketball players aged 16-19 years ($\bar{X} \pm S$)

Studies, age	Index	Height, cm	Standing arm reach, cm	Body mass Kg	BMI kg/m ²	Handgrip strength, kg		LV, l	Fat, Kg	Muscle, kg
						R	L			
I	\bar{X}	193.33	249.92	77.58	20.85	42.33	37.50	5.30	7.66	41.27
16 yr.	S	6.46	10.62	8.73	1.87	6.68	5.88	0.77	1.99	5.24
II	\bar{X}	195.82	254.45	81.77	21.32	39.36	34.36	5.59	8.30	43.65
17 yr.	S	7.13	11.64	6.85	1.20	8.27	7.79	0.44	1.51	4.62
III	\bar{X}	197.17	256.83	86.50	22.19	43.33	38.25	5.71	9.24	48.23
18 yr.	S	6.18	9.81	9.00	1.78	5.80	5.79	0.49	2.14	5.74
IV	\bar{X}	197.29	257.33	90.88	23.44	52.92	50.75	5.76	9.56	49.43
19 yr.	S	7.03	9.05	7.21	1.58	7.69	3.93	0.43	1.86	7.31
I-II	p<									
I-III	p<									0.02
I-IV	p<			0.004	0.01	0.001	0.001			0.01
II-III	p<									0.04
II-IV	p<			0.005	0.001	0.001	0.001	0.37	0.09	0.03
III-IV	p<					0.002	0.001			

Table 2: Changes in the physical fitness indices of Lithuanian young basketball players aged 16-19 years 16-19 ($\bar{X} \pm S$)

Studies, age	Index	Jump height cm	Take-off time Ms	SMCP W	AAMP W	SRT mls	MF k/10s	Agility s
I	\bar{X}	62.67	243.08	2019	1252	185.92	75.42	13.99
16 yr.	S	6.40	27.70	278.5	128.4	13.77	5.21	1.50
II	\bar{X}	58.08	246.85	1880	1315	185.92	74.62	11.21
17 yr.	S	4.55	29.69	279.1	123.5	15.15	7.30	0.79
III	\bar{X}	58.25	220.17	2297	1430	183.08	77.50	11.10
18 yr.	S	4.31	31.20	493.5	112.1	12.09	8.33	1.29
IV	\bar{X}	60.75	217.08	2513	1517	170.00	82.75	10.83
19 yr.	S	5.08	29.66	369.5	96.68	13.05	10.00	1.45
I-II	$p <$	0.04						0.001
I-III	$p <$				0.001			0.001
I-IV	$p <$		0.03	0.001	0.001	0.008	0.03	0.001
II-III	$p <$		0.04	0.01	0.02			
II-IV	$p <$		0.02	0.001	0.001	0.01	0.02	
III-IV	$p <$				0.05	0.02		

Conclusions

The most capable young Lithuanian basketball players demonstrate higher anthropometric indices than their non-athlete peers, but in the period of 16-19 years of age, their growth rates are similar. It was established that muscle mass rapidly grew from 17 and static muscle strength significantly increased from 18 years of age. This was affected by both physical load and physiological patterns of growth.

We found that although the single muscle contraction power increased during the study period, the results were insufficient due to low jump height and take-off speed. It can be assumed that the individual muscle power adaptation of each player throughout the season has not been focused on the increase of those abilities. Young basketball players' alactic anaerobic muscle power improved during the three years of training, but the results could not be compared to those of highly skilled basketball players.

References

- Carter A.B., Kaminski T.W., Douex A.T., Knight C.A., Richards J.G. (2007) Effects of high volume upper extremity plyometric training on throwing velocity and functional strength ratios of the shoulder rotators in collegiate baseball players. *Journal of Strength and Conditioning Research*. 21:208–215.
- Eurofit, (1993), Eurofit Tests of Physical Fitness, 2nd Edition, Strasbourg.
- Eurofitas. (2002) Fizinio pajėgumo testai, metodika, Lietuvos moksleivių fizinio pajėgumo rezultatai. Vilnius, LSIC.
- Ellis L., Gatin P., Lawrence S., Savage B., Buckeridge A., Stapff A., Tumilty D., Quinn A., Woolford S., Young W. (2000) Protocols for the physiological assessment of team sport players. *Physiological tests for elite athletes*. Australian Sports Commission. 128-144.
- Ernsberger P. (2012) BMI, Body Build, Body Fatness, and Health Risks. *Fat Studies* 1, (1), 6-12.
- Faigenbaum AD, Kraemer WJ, Blimkie CJ, et al. (2009) Youth resistance training: updated position statement paper from the National Strength and Conditioning Association. *Journal of Strength and Conditioning Research*; 23, 60–S79.
- Fox E., Bowers R., Foss M., (1993) *The physiological basis for exercise and sport*, 5th ed. Dubuque, IA: W.C. Brown.
- Hoffman J. (2006) *Norms for fitness, performance, and health*. Human Kinetics, Inc. Champaign, IL.
- Housh T.J., Housh D.J., de Vries H.A. (2006) *Applied Exercise and Sport Physiology*. 2nd ed. Scottsdale (AZ): Holcomb Hathaway Publishers, 57–80.
- Kawamori N., Haff G.G. (2005) The optimal training load for the development of muscular power. *Journal of Strength and Conditioning research*, 19, 698-708.
- Malina R. M. (1997) Prospective and Retrospective Longitudinal studies of the Growth, Maturation and Fitness of Polish Youth Active in Sport. *International Journal of Sports Medicine*. - Themie. 1, 179 -185

12. Spent L.F., Martin A.D., Drinkwater D.T. (1993) Muscle mass of competitive male athletes. *Journal of Sports Sciences*. 1(11), 3-8.
13. Torres-Unda J., Zarrasquin I., Gila J., Ruiz F., Irazusta A., Kortajarena M., Seco J., Irazusta J. (2013) Anthropometric, physiological and maturational characteristics in selected elite and non-elite male adolescent basketball players. *Journal of Sports Sciences*, 2(31), 196-203.
14. Trninič S., Markovič G., Heimer S. (2001) Effects of Developmental Training of Basketball Cadets Realised in the Competitive Period. *Collegium Antropologicum*, 2 (25) 591–604.
15. Young W.B, Farrow D. A. (2006) Review of agility: practical applications for strength and conditioning. *Strength and Conditioning Journal*, 28, 24–29.

ECCENTRIC EXERCISE IN TREATMENT OF TENDINOPATHY

Denis Pudja, Ana Forko and Cvita Gregov

Faculty of Kinesiology, University of Zagreb, Croatia

Introduction

Tendinopathy is a term used to describe various tendon pathologies (paratendinitis, tendinitis and tendinosis) in the absence of biopsy-proven histopathologic evidence (Maffulli et al., 1998). The typical symptoms are pain and decreased range of motion and strength in the affected joint. In everyday use the terms tendinopathy or tendinosis are used to describe an inflammatory condition. However, a frank inflammation of the tendinous tissue - a complex biological reaction of the vascular tissue on detrimental stimulus (Ferrero-Miliani et al., 2007) - is actually a rare condition associated mostly with tendon ruptures. Therefore, it is necessary to precisely define and differentiate the following terms: *paratendinitis* - inflammation of the tendon sheath; *tendinitis* - the precise term for an inflammatory condition of the tendon which is treated with non-steroidal anti-inflammatory drugs, rest, gradually return to the activity; *tendinosis* - tissue degeneration without signs of intratendinous inflammation (Maffulli i sur., 1998).

Mechanisms of tendinopathy occurrence are not clearly understood. However, Satyendra and Byl (2006) state repeated overload as a main factor for occurrence of tendinosis. This leads to matrix denaturation and tenocyte death which results in decreased collagen and ground substance production (Satyendra i Byl, 2006). This process leads to weak adaptive response on future loading and occurrence of tendinopathy symptoms.

The treatment is mainly conservative and includes: NSAIDS (non-steroidal anti-inflammatory drugs), corticosteroids, laser therapy, sclerotherapy, ultrasound, stretching and strengthening - *eccentric exercises* and other means of rehabilitation (Andres and Murrell, 2008).

In studies of tendinopathy treatment eccentric exercises are emphasized as the most effective and simplest option of rehabilitation, alone or in combination with other methods. However, like in the case of tendinopathy occurrence, the mechanisms of eccentric exercise effectiveness are not completely understood (Satyendra and Byl, 2006). Common regions affected (and mostly covered by research) are the Achilles tendon, patellar tendon and lateral side of elbow. In everyday use the syndromes of patellar tendinopathy (PT) and lateral elbow tendinopathy (LET) are referred as "jumper's knee" and "tennis elbow", respectively.

Allison and Purdam (2009) emphasize the next main factors of EE effectiveness for AT: (1) *Improved homogeneity of the passive structures*. It is assumed that the occurring high velocities and extreme range in the joint during eccentric contractions provide a differential loading on different parts of the tendon. Controlled performing of EE has a potential to decrease the heterogeneity of the tendon substance. (2) *Modulation of the neurological stretch responses*. The SSC (*stretch-shortening cycle*) relies on the optimal utilisation of the mechanical and neurological properties of locomotor system. The pathogenesis of tendinopathy may be a manifestation of a mismatch of the neurological and mechanical factors. EE may cause peripheral and central neurological modulation of thresholds of activation (3) *Increased shear forces between the tendon and paratendon structures*. The forces which appear during EE between the tendon and the paratendon may inhibit, and possibly decrease vascular infiltration into the tendon and alter the nociceptive inputs. (4) *Other mechanisms* include desensitisation that may alter the reflex drive to the lower limb muscles and the adaptation of mechanotransduction signalling in the passive tendon structures and the proximal aponeurosis or muscle fibres (Allison and Purdam, 2009).

In general, the effects of EE treatment result in pain reduction and improvement in strength and range of motion. In most studies, the intensity of pain was evaluated with a VISA questionnaire (*Victorian Institute of Sport Assessment*) or a VAS scale (*Visual Analog Scale*). In VISA the patients are asked about the duration and intensity of perceived pain and evaluated on a scale from 0 to 100 (higher values describe less pain). In the VAS scale the interval is from 0 to 10 (or 0 to 100 in the 100 mm version), where 0 means completely absence of pain and 10 as unbearable pain. Strength and function of movement was tested in certain studies with an isokinetic dynamometer or assessed with tests like squat jump.

Hence, the aim of this work is a systematic review of effects under treatment with eccentric exercises on rehabilitation of tendinopathy and defining an effective protocol, including the most appropriate means, loads and duration of treatment.

Selection of research

Considering that the aim of this work is to expose the most effective ways of using eccentric exercises in treatment of tendinopathy, the studies were included on the next primary criterions: the use of eccentric exercises, a precisely defined protocol and described tendinopathy symptoms. Case studies or papers in which the effects or subjects aren't described

in detail, in some cases where included because of the well described program and exercises which can be helpful in the practise.

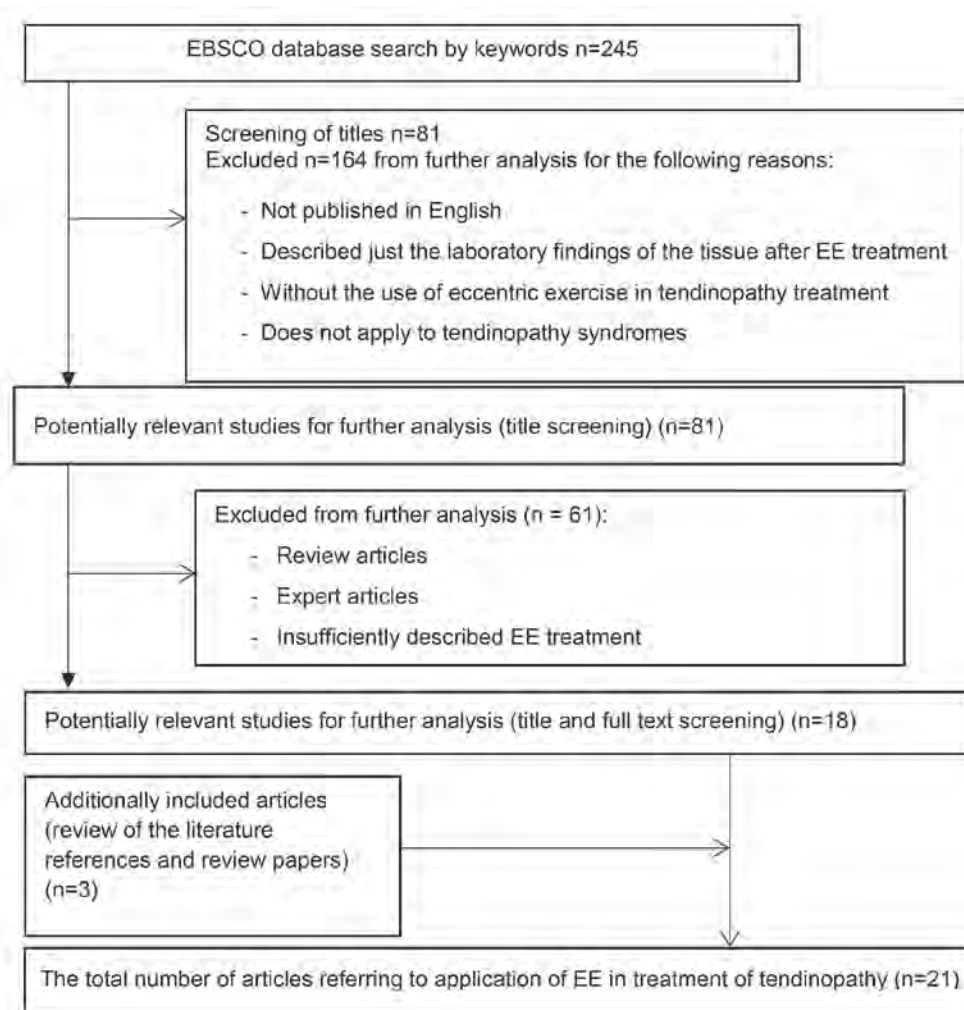

Figure 1: Diagram of article selection

Research considering effects of eccentric exercise on rehabilitation of achilles tendinopathy

Considering rehabilitation of Achilles tendinopathy (AT), it is necessary to accentuate that most articles describe treatment of mid-portion Achilles tendinopathy. The reason is that significant effects of EE use are not observed in insertional Achilles tendinopathy.

Mid-portion Achilles tendinopathy is a chronic condition characterized by localized Achilles tendon pain and swelling, often leading to loss of performance. It affects both recreational participants and professional athletes. In sport activities which include jumping and running 9% of elite athletes suffer from AT. Although mostly associated with elite sport, 33% of patients are sedentary individuals, particularly men aged between 35 and 45years (Rowe et al., 2012).

Above mentioned various factors represent potential mechanisms of tendinopathy occurrence in general. Rowe et al. (2012) also mention more possible causes of AT including overuse, adverse lower limb bio-mechanics (e.g. excessive foot pronation), and inappropriate footwear. Conservative treatment is the first option for rehabilitation of AT, usually applied for 3-6 months before alternative options or eventually surgery. A retrospective study concluded that in average a period of 11 months was needed for returning to competition after surgery.

Thus, it is necessary to precisely define which form of conservative treatment is most adequate for treatment of AT (Rowe et al., 2012). Eccentric exercises are shown, with or without other therapy modalities, as the most effective method for management of Achilles tendinopathy.

Table 1: Studies considering effects of eccentric exercises on rehabilitation of Achilles tendinopathy

Authors and year	Exercise	Volume	Duration of treatment	Number of subjects	Outcome
Alfredson et al. (1998)*	Heel drops and raises: a) extended leg, b) flexed leg	Day 1 – 2: 1 x 15; day 3 – 4: 2 x 15; day 5 – 7: 3 x 15; after that: 3 x 15 The load is increased to a level of tolerable pain	12 weeks	15 recreational athletes (12 m i 3 f) Average age 44,3 years.	Increase of strength measured on a isokinetic dynamometer, significant decrease of pain measured with a 100 mm visual analogue scale (from 81,2 +/-18.0 to 4,8+/-6,5 points).
Jonsson et al. (2008)	Heel raise and drop without dorsiflexion	3 x 15 repetitions 2 times a day, 7 days a week	12 weeks	27 subjects (12 m, 15 f) Average age 53,4 years	18 patients satisfied, 9 not satisfied with the treatment. Measured with the VAS scale, in average decreased from 69,9 to 21 points
de Vos et al. (2012)	Alfredson protocol	180 repetitions a day Increase of load based on perceived pain (gradually by 2 kg)	16 weeks	23 subjects	Decrease of pain evaluated with VISA (average improvement for 11,3 points)
Morrissey et al. (2011)	Alfredson protocol	Day 1 – 2: 1 x 15; day 3 – 4: 2 x 15; day 5 – 7: 3 x 15; after that: 3 x 15 The load is increased to a level of tolerable pain	6 weeks	19 subjects (6 m i 13 f) Average age 21,6 years	Decreased Achilles tendon stiffness and increased jump height.
Ram et al. (2013)	Alfredson protocol	Day 1 – 2: 1 x 15; day 3 – 4: 2 x 15; day 5 – 7: 3 x 15; after that: 3 x 15 The load is increased to a level of tolerable pain	12 weeks	20 subjects	Decreased pain evaluated with VISA and VAS questionnaires. Hence, just two patients expressed satisfaction with the program.
McCormack (2012)	Alfredson protocol + acupuncture	2 x 10 - 20 repetitions 2 times per week	5 weeks	1 subject: a female recreational tennis player, age 56 years	Complete healing, return to previous activities without functional restrictions, absence of pain.
Croisier et al. (2001)	Eccentric calf contractions on an isokinetic apparatus	1 - 3 x 30 repetitions (progression to 3 - 5 x 30) 3 times per week	20 - 30 training sessions	9 subjects (6 m i 3 f)	Effects: complete recovery: 5 subjects, significant: 2, moderate: 1, without changes: 1
Roos et al. (2004)	Alfredson protocol+ Splint	1 x 15 repetitions (progression to 3 x 15)	12 weeks	31 subject group 1: eccentric exercises only, group 2: eccentric exercises and splint	Significant pain reduction in both groups: 27% in the EE only group, 18% in the EE + splint group
Papa (2012)	Eccentric contractions of the calf muscle + acupuncture and electrostimulation	3 x 10 repetitions (progression to 3 x 15, 5 times per week) In office and home	8 weeks	1 subject, age: 77 years	Complete recovery, absence of all symptoms
Maffulli et al. (2008)	Heel drops	1 x 10 repetitions (progression to 3 x 15, with gradual increase by 5 kg)	2 times daily, 7 days weekly, 12 weeks	45 active athletes, 29 m (average 26 years) i 16 f (average 28 years)	Pain decrease evaluated with VISA (from 36 to 52 points). From 45 subjects by 27 stated significant recovery, by 5 subjects recovery with pharmacological means, others without recovery
Nørregaard et al. (2007)	Alfredson protocol	3 x 15 repetitions 2 times a day, 7 days a week	3 months	Number of affected tendons: 23	9 complete recovery, 12 significant, 1 slight improvement, 1 without change

* Alfredson et al. (1998), protocol used in a larger number of studies, in detail described in further text

The search identified eleven studies that investigated eccentric training in the treatment of Achilles tendinopathy. The researchers examined the influence of Alfredson's protocol which is based on the eccentric activation m.triceps surae. The exercises were carried out in two basic versions: with and without flexion in the knee joint. In practice the prone knee emphasized the activation of the m.gastrocnemius, while the version with a bent knee emphasized activation of m.soleus. The first two days of the program are executed from one series of fifteen repetitions, the other two days of the two sets of fifteen repetitions, and at the end of the three sets of fifteen repetitions. The load was increased to a level of a tolerable pain. The program usually lasts twelve weeks, with the exercise carried out every day of the week twice a day.

Alfredson *et al.* conducted a pilot study of recreational athletes who were awaiting surgery for chronic painful Achilles tendinosis. Heavy-load eccentric calf muscle exercises were taught to 15 athletes, who were told they could expect some pain with their exercises. The 15 other patients were not given any intervention. At the end of 12 weeks, all 15 in the exercise group were satisfied with their improvement and did not have surgery (100% successful) whereas all of the control group subjects went on to have surgery (0% successful). The Absolute Risk Reduction (ARR) for the proportion failing conservative treatment was 0; all went on to have surgery. In the study by Roos *et al.* the eccentric exercise group reported greater pain reduction than both splint only group and the eccentric exercise plus splint group. In addition, in this study, the effect-size was 62.5% in the eccentric group compared to 37.5% in the splint and exercise group and 10% in the splint only group. The difference in the treatment effect ranged from 25% (eccentric group compared to splint and exercise group) to 52.5% (eccentric group compared to the splint only group; Satyendraa, and Bylb 2006).

Of the three remaining studies (Papa, 2012; Maffulli *et al.*, 2008; Jonsson *et al.*, 2008), one evaluated the effects of eccentric training and medical acupuncture with electrical stimulation of a 77-year old female patient. The second compared eccentric strengthening exercises in athletic patients to previous results in non-athletic patients. Eccentric strengthening exercises are a viable option for the management of Achilles tendinopathy in athletes, but, in this study, only around 60% of athletic patients benefited from an intensive, heavy load eccentric heel drop exercise regimen alone. The last study included 27 patients with diagnosed insertional Achilles tendinopathy, and they performed a new model of painful eccentric training regimen without loading into dorsiflexion. This was done twice a day, 7 days/week.

Research considering effects of eccentric exercise on rehabilitation of patellar tendinopathy

Patellar tendinopathy (PT) is also known by the term “jumpers knee” and refers to a overuse syndrome which manifests in occurrence of pain in the front part of the knee, mostly on the apex of the patella, i.e. on the origin of the patellar tendon. Although the ethology of the PT is not completely understood, it is considered that the pathogenesis of this condition is of degenerative nature, and not inflammatory like it was thought before. It is assumed that the degenerative changes are a consequence of continuous loading on the knee extensor mechanism (Dimnjaković *et al.*, 2010). The occurrence of the PT is mostly common in sports which include frequent jumps, like long and high jump, volleyball, basketball, handball and other team sports. PT is significantly more frequent in the population of active athletes than in the recreational population. PT can be caused by different internal and external factors, like training intensity, hard surface, restricted upper leg flexibility etc. Stasinopoulos *et al.* (2011) state that PT mostly occurs in the dominant leg (93%).

The first choice for PT treatment is conservative management, mainly during a period of 12 weeks, before some alternative methods or surgery. It is important to accentuate that the EE must always be performed very slowly and sometimes under pain, and the load is increased by adding weight (Dimnjaković *et al.*, 2010).

Table 2: Studies considering use of eccentric exercises in rehabilitation of patellar tendinopathy

Authors and year	Exercise	Volume	Duration of treatment	Number of subjects	Outcome
Stasinopoulos <i>et al.</i> (2011)	Unilateral squat with and without load (decline 25°) + static stretching of quadriceps and hamstrings	3 x 15 repetition, 5 x a week	4 weeks	22 recreational athletes, (16 m i 6 f)	Decrease of pain and improvement of function in the knee joint. No withdrawal was recorded during treatment, as well as the occurrence of adverse effects in any patient after completion.
Cannell <i>et al.</i> (2001)	Drop squat with and without load	3 x 20 repetitions, 5 x a week	12 weeks	10 athletes	Decrease of pain: complete recovery in 4 patients, significant decrease of pain in 5 patients, 1 patient reported increased pain. Significant increase of knee extensor strength was not reported.
Dumont <i>et al.</i> (2008)	Drop squat	3 x 10 repetitions 7 x a week	6 weeks	4 (3 f i 1 m)	Improved knee function and increased quadriceps strength in both legs (n=3).
Purdam <i>et al.</i> (2004)	Unilateral squat with and without 25° decline	3 x 15 repetitions two times a day	12 weeks	17	Significant decrease of pain and return to previous activity in the decline group (evaluated with the VAS scale). Poorer outcomes in the group which exercised without the decline.
Bahr <i>et al.</i> (2006)	Unilateral squat on a 25° decline board	3 x 15 repetitions two times a day	12 weeks	35	Significant decrease of pain by more than 50% subjects evaluated with VISA.
Young <i>et al.</i> (2005)	Unilateral squat with and without load (decline 25°)	3 x 15 repetitions two times a day	12 weeks	17	Significant decrease of pain evaluated with VISA and VAS.

A total of six studies were identified and included in this study. From the data we can see that the studies most often applied decline eccentric training. Duration of the program is usually conducted over a period of twelve weeks, and measurement results used VAS and VISA questionnaires. Load patellar tendon during decline eccentric exercises is greater than the normal squat, and they increase the efficiency of the exercise. The reason for this is the centre of gravity of body weight which increases the load on the patellar tendon (Kongsgaard et al., 2006). Also, performing decline eccentric exercise provides better performance.

Young et al. compared eccentric exercise with a decline board against a traditional eccentric exercise (non-decline) protocol in 17 elite volleyball players. They did not withdraw athletes from sport, as the purpose of the study was to investigate the efficacy of these treatment modalities during a competitive season. Both groups (n=10, n=7) had a significant improvement in VISA and VAS scores at 12 weeks and 12 months. The authors concluded that clinicians could confidently use these protocols to positively affect pain and the ability to play sport stating a 94% likelihood of achieving the smallest improvement of 20 points on the VISA scale at 12 months with the decline protocol. *Bahr et al.* compared a decline eccentric training program against surgery in 35 recreational athletes (40 knees). Patients were withdrawn from sports specific training for the first 8 weeks. After 4 weeks they were allowed to cycle and jog on a flat surface if pain free. No evidence was presented to support this rationale but it is likely that such a methodology was chosen to standardize the rehabilitation with those patients in the surgery arm of the trial. Despite withdrawal from sport 5 knees (25%) failed eccentric exercise and went on to surgery, 7 made a full recovery, and 8 had some improvement but were still symptomatic at 12 months. The authors concluded that there was no advantage of surgery over eccentric exercises and that eccentric exercise should be tried for 12 weeks prior to surgery (Saithna, A. et al. 2012).

Purdam et al. compared 19 single-leg eccentric training on a decline board performing the same exercise with the foot on a flat surface. The training programme was the same for both groups; the only difference was the use of a decline board. The exercise was completed with the trunk in an upright position, and subjects were instructed to perform the exercise by slowly bending the knee to 90° of flexion. They were told to perform the eccentric loading on the quadriceps muscles only and to return to the starting position using the non-injured side. If they had bilateral tendinopathy, the arms and both legs were used to return to starting position. Subjects were asked to increase the load with weights in a backpack only once so the exercise could be completed without pain. Subjects were not allowed to continue their competitive sporting activity during the first 8 weeks of the treatment period. After 4 weeks of the eccentric training regimen, they were allowed to complement it with slow jogging on flat ground, and cycling and water activities, if these could be performed without sharp pain in the patellar tendon. After 8 weeks, the patients were allowed to return gradually to previous activity. The results showed that after 12 weeks, there was a significant decrease in the amount of pain during activity in nine patients in the decline squat group, and no change in the flat floor group. Only one of nine returned to sport in the standard flat floor group, compared with six of eight patients in the decline board group. However, of these six, only four were still active at pre-injury levels when they were followed up after 15 months (Visnes et al., 2007).

Stasinopoulos et al. also compared the effects of eccentric training and static stretching exercises of quadriceps and hamstrings in the treatment of patellar tendinopathy. Patients who had patellar tendinopathy for at least three months were allocated in two groups (n=22, n=21). Eccentric training was the same for both groups: three sets of 15 repetitions of unilateral squat on a 25° decline board. The squat was performed at a slow speed and the non-injured leg was used to get back to the start position. When the squat was pain free the load was increased by holding weights in their hands. Pain and function were evaluated using the VISA-P score. Standard eccentric exercises offer adequate rehabilitation for tendon disorders, but many patients with tendinopathies do not respond to this prescription alone. Eccentric training and static stretching exercises produced the largest effect.

Another frequently used exercise is drop squat. *Cannell et al.* compared the efficacy of drop squats against leg extensions in 19 athletes. They did not withdraw athletes from sport but instead allowed them to participate provided their initial symptoms were relieved. Compliance was good and all participants completed at least 55 out of 60 sessions. Both groups were associated with significant pain reduction after 12 weeks. In the eccentric exercise group nine out of ten athletes had been able to return to sport by that time. No long-term outcomes were reported (Saithna et al., 2012).

Also *Dumont et al.* in their study evaluated the effects of six-week performed drop squat. None of the patients achieved full recovery, but three of four patients had increased isometric quadriceps peak force of the ipsilateral, and four of the contralateral side.

According to Stasinopoulos et al. (2011), even more significant effects were achieved through a combination of eccentric training exercises and static stretching. Likewise, it is important to point out that the performance of exercises gives greater effects if it is carried out under the supervision, because in this way the motivation significantly increases as the quality of performance in the patients. Although the mechanisms of tendinopathy and changes in tendons are still insufficiently understood, eccentric exercises are very effective and have shown significant effects in terms of healing and change in the structure of the tendon.

Research considering effects of eccentric exercises on rehabilitation of lateral elbow tendinopathy

Elbow tendinopathy occurs in form of medial or lateral elbow tendinopathy (LET). In most articles the topic is lateral elbow tendinopathy, or the so called “tennis elbow syndrome”. Hence, Table 3 includes only studies with this form of elbow tendinopathy.

LET affects individuals of all age groups and occurs in the dominant hand 1-3 times more frequent than in the non-dominant hand. The occurrence of LET is not influenced by the gender factor, but the symptoms last longer and are more serious. The diagnosis is simple to make, for example with palpation of the lateral epicondyle, resisted palm extension or resisted middle finger extension (Stasinopoulos et al., 2005). The recommended treatment is mainly conservative, with best effects shown by use of eccentric exercise.

Table 3: Studies considering use of eccentric exercise in rehabilitation of lateral elbow tendinopathy

Authors and year	Exercise	Volume	Duration of treatment	Number of subjects	Outcome
Manias and Stasinopoulos (2006)	Eccentric activation of the hand extensors in pronation (forearm lies on surface) and static stretching (with or without use of ice)	3 x 10 repetitions Stretching: 3 x before and after exercise, 5 times a week	4 weeks	40 (13 m i 27 f)	Significant decrease of pain evaluated with VAS: EE + STR ↓ 8,80 – 1,90 EE + STR + ice ↓ 8,60 – 1,70 use of EE and stretching are decreasing independent of using ice.
Croisier et al. (2007)	Eccentric activation of the hand extensors and supinators of the forearm on a isokinetic apparatus	2 x 10 repetitions 3 times a week	9 weeks	46	Significant decrease of pain already after one month of treatment, increase of hand extensor and forearm supinator strength and increase of tendon thickness.
Stasinopoulos et al. (2010)	Eccentric activation of the hand extensors + stretching	3 x 12, 5 times a week	12 weeks	35	Significant decrease of pain and increase in range of motion. No withdrawal was recorded during treatment, as well as the occurrence of adverse effects in any patient after completion.
Svernlöv and Adolfsson (2001)	Eccentric activation of the hand extensors + stretching	3 x 5, 2 times a week	12 weeks	15	Increased hand grip strength, decreased LET symptoms: 54% subjects complete recovery, 43% improvement, 2% unchanged and by 2 patients recorded deterioration of LET symptoms.

The search identified four studies that investigated eccentric training in the treatment of lateral elbow tendinopathy. The exercise programme mainly consisted of slow progressive eccentric exercises of wrist extensors. Outcome measure was pain using a visual analogue scale. All programmes are similar and gave positive results.

Stasinopoulos et al. compared a home exercise programme and supervised exercise programme five times a week for 12 weeks. The exercise programme consisted of slow progressive eccentric exercises of wrist extensors and static stretching of the extensor carpi radialis brevis tendon. Outcome measures were pain, using a visual analogue scale, and function, using a visual analogue scale and the pain-free grip strength. Patients were evaluated at baseline, at the end of treatment (week 12), and 3 months (week 24) after the end of treatment. At the end of treatment, there was a decline in pain and a rise in function in both groups compared with baseline. The supervised exercise programme produced the largest effect and it is superior to home exercise programme to reduce pain and improve function in patients with LET at the end of the treatment and at the follow-up.

Manias, and Stasinopoulos also compared eccentric exercise programme but with or without ice. The ice was applied after the exercise programme for 10 minutes in the form of an ice bag to the facet of the lateral epicondyle. Outcome measures used were the pain visual analogue scale and the dropout rate. There were no significant differences in the magnitude of reduction between the groups at the end of treatment and at the three month follow up. An exercise programme consisting of eccentric and static stretching exercises had reduced the pain in patients with LET at the end of the treatment and at the follow up whether or not ice was included.

Another research also compared the similar programme, for example *Croisier et al.* compared standardised rehabilitation programme that excluded strengthening exercises and eccentrically trained group. Ninety-two patients with unilateral chronic lateral epicondylar tendinopathy were assigned either to a control group (n = 46) or to an eccentrically trained group (n = 46). The control group underwent a passive standardised rehabilitation programme that excluded strengthening exercises. In addition to this programme, the trained group also performed eccentric exercises based on

the repetitive lengthening of the active musculo-tendinous unit. The latter exercises started with submaximal contraction intensity and slow speed movement.

Following observations were made in the eccentrically trained group: a significantly more marked reduction of pain intensity, mainly after one month of treatment; an absence of strength deficit on the involved side through bilateral comparison for the forearm supinator and wrist extensor muscles; an improvement of the tendon image as demonstrated by decreasing thickness and a recovered homogenous tendon structure; and a more marked improvement in disability status during occupational, spare time and sports activities. These results highlight the relevance of implementing isokinetic adapted eccentric training in the management of chronic lateral epicondylar tendinopathy.

Svernlov, and Adolfsson in their research randomly allocated patients in two groups and compared them in stretching and eccentric exercise programme. Evaluation included subjective assessment of symptoms using visual analogue scales and grip strength measurements. 86% of patients reported complete recovery or improvement. Reduced pain and increased grip strength were seen in both treatment groups but 12 out of 17 patients (71%) in group eccentric exercise programme rated themselves as completely recovered as compared to 7 out of 18 (39%) in group stretching. There was a larger statistically significant increase in grip strength after 6 months in eccentric exercise group.

Exercise programmes are commonly used in the treatment of LET, more research is needed to assess, firstly, their effectiveness and, secondly, the mechanism of action of both their components (Stasinopoulos et. al., 2005)

Although the current literature is limited, eccentric training has demonstrated promising results in the management of LET (Malliaras et al. 2008).

A review of the main eccentric exercise in treatment of tendinopathy

The exercises used in most of the referenced articles are shown in this chapter.

1. Demonstration of the eccentric exercises for Achilles tendinopathy – Alfredson protocol (Alfredson et al., 1998; figure 2a, 2b, 2c)

- Heel drops with extended leg (accentuated activation of *m. gastrocnemius*; figure 2a)
- Heel drops with flexed leg accentuated activation of *m. soleus*; figure 2b)
- Heel drops with load (different variations; figure 2c)

Description:

Initial position – stand with the front part of the foot elevated.

Performing the exercise – dropping the heel on one leg (standing leg), the other leg is raised.

The final position is equal to the initial.



Figure 2: a) Heel drops with extended leg



Figure 2: b) Heel drops with flexed leg



Figure 2: c) Heel drops with load

2. Demonstration of eccentric exercises for patellar tendinopathy (figure 3 and 4)

a) Unilateral decline squat (25°) (figure 3)

Description:

Initial position – hip-wide stance.

Performing the exercise – unilateral squat to a parallel position with the affected leg; raising with the healthy leg. The exercise should be performed slowly and controlled to a level of tolerable pain.

Final position is equal to the initial.



Figure 3: Unilateral decline squat (25°)

b) Drop squat (figure 4)

Description:

Initial position – hip-wide stance.

Performing the exercise – dropping from the initial position into the squat position.

Final position is equal to the initial.



Figure 4: Drop squat

3. Demonstration of an eccentric exercise for lateral elbow tendinopathy (figure 5)

Eccentric activation of hand extensors (with dumbbell)

Description:

Initial position – forearm rests in pronation on a stable surface, hand extended as much as possible.

Performing the exercise – slowly lowering the dumbbell into flexion; raising the exercising hand with the help of the other hand.

Final position is equal to the initial.



Figure 5: Eccentric activation of hand extensors (with dumbbell)

Conclusion

Tendinopathy of some regions, particularly Achilles tendon, patellar tendon and lateral elbow, is a relatively common pathology both in recreational population and elite athletes, respectively. In general, eccentric exercise is considered as the most effective method of treatment. The protocols mainly include a volume of 1-3 series with 10-15 repetitions within a period of 4-12 weeks. Research outcomes suggest that the best effects are expected when the exercises are performed slowly and that the sport or exercise activity should be stopped for the first 4 weeks of rehabilitation. All studies determined positive effects which is stimulating for further research of eccentric exercise effects and exploring the mechanisms which induce these effects. Although, it is necessary to accentuate a relatively low number of subjects as a general lack of the mentioned researches (Dimnjaković et al., 2010) which indicates the need for a larger number of subjects in the future works.

The results of eccentric exercise use in management of tendinopathy indicate significant decrease of pain and improvement of function in sense of increase of strength and range of motion, often with complete recovery and return to previous activity. Main advantages of this kind of treatment is simplicity of use, and assuming an adequate level of education of the coach/expert in this area, almost none financial expenditure. Thus, it can be concluded that, considering the present base of knowledge, the eccentric exercise is definitely the first choice in the rehabilitation of tendinopathy, compared to any other conservative method or surgery.

References

1. Alfredson, H., Pietilä, T., Jonsson, P. i Lorentzon, R. (1998). Heavy-Load Eccentric Calf Muscle Training For the Treatment of Chronic Achilles Tendinosis. *American Journal of Sports Medicine*, 26, 360.
2. Allison, G.T. i Purdam, C. (2009). Eccentric loading for Achilles tendinopathy – strengthening or stretching? *British Journal of Sports Medicine*, 43, 276 - 279.
3. Andres, B. A. i Murrell, G. (2008). Treatment of Tendinopathy. What works, what does not, and what is on the horizon. *Clinical Orthopaedics and Related Research*, 466, 1539 - 1554.
4. Bahr, R., Fossan, B., Løken S. i Engebretsen, L. (2006). Tendinopathy (Jumper's Knee) A Randomized, Controlled Trial Surgical Treatment Compared with Eccentric Training for Patellar. *The Journal of Bone and Joint Surgery American Volume*, 88, 1689 - 1698.
5. Cannell, L.J., Taunton, J.E., Clement, D.B., Smith, C. i Khan, K.M. (2001). A randomised clinical trial of the efficacy of drop squats or leg extension/leg curl exercises to treat clinically diagnosed jumper's knee in athletes: pilot study. *British Journal of Sports Medicine*, 35, 60 – 64.
6. Chessin, M. (2012). Achilles Tendinosis Stopping the Progression to Disability. *Journal of Dance Medicine and Science*, 16, 3, 109 - 115.
7. Cook, J. L., Khan, K.M., Harcourt, P.R., Grant, M., Young, D.A. i Bonar, S.F. (1997). A cross-sectional study of 100 athletes with jumper's knee managed conservatively and surgically. *British Journal of Sports Medicine*, 31, 332 - 336.
8. Croisier, J.L., Foidart-Dessalle, M., Tinant, F., Crielaard, J.M. i Forthomme, B. (2007). An isokinetic eccentric programme for the management of chronic lateral epicondylar tendinopathy. *British Journal of Sports Medicine*, 41, 269 – 275.

9. Croisier, J.J., Forthomme, B., Foidart-Dessalle, M., Godon, B. i Crielaard, J.M. (2001). Treatment of recurrent tendinitis by isokinetic eccentric exercises. *Isokinetics and Exercise Science*, 9, 133 – 141.
10. Dimnjaković, D., Dokuzović, S., Mahnik, A., Smoljanović, T. i Bojanić, I. (2010). Ekscentrične vježbe u liječenju skakačkog koljena. *Hrvatski športskomedicinski vjesnik*, 25, 43 - 51.
11. Dumont, T.L., MacIntyre, D.L. i Harris, S. (2008). Effects of a Six-Week Eccentric Exercise Program on Patients with Patellar Tendinopathy: Single-Subject Research Study. *Physiotherapy Canada*, 58, 2, 130 - 147.
12. Ferrero-Miliani, L., Nielsen, O.H., Andersen, P.S., Girardin, S.E. (2007). “Chronic inflammation: importance of NOD2 and NALP3 in interleukin-1beta generation”. *Clinical and Experimental Immunology*, 147, (2), 227 – 235.
13. Jonsson, P., Alfredson, H., Sunding, K., Fahlstrom, M. i Cook, J. (2008). New regimen for eccentric calf-muscle training in patients with chronic insertional Achilles tendinopathy results of a pilot study. *British Journal of Sports Medicine*, 42, 746 – 749.
14. Kongsgaard M, Aagaard P, Roikjaer S, Olsen, D., Jensen M., Langberg H. i Magnusson S. P. (2006). Decline eccentric squats increases patellar tendon loading compared to standard eccentric squats. *Clinical Biomechanics (Bristol,Avon)*, 21, 748 - 54.
15. Maffulli, N., Kahn, K. M., Puddu, G. (1998). Overuse tendon conditions: Time to change a confusing terminology. *Arthroscopy*, 14, 840 - 3.
16. Maffulli, N., Walley, G., Sayana, M. K., Longo, U. G. i Denaro, V. (2008). Eccentric calf muscle training in athletic patients with achilles tendinopathy. *Disability and Rehabilitation*, 30, (20-22), 1677 - 1684.
17. Malliaras, P., Maffulli, N. i Garau, G. (2008). Eccentric training programmes in the management of lateral elbow tendinopathy. *Disability and Rehabilitation*, 30, (20–22), 1590 – 1596.
18. Manias, P. i Stasinopoulos, D. (2006). A controlled clinical pilot trial to study the effectiveness of ice as a supplement to the exercise programme for the management of lateral elbow tendinopathy. *British Journal of Sports Medicine*, 40, 81 – 85.
19. McCormack J. R. (2012). The management of mid portion achilles tendinopathy with astym and eccentric exercise: a case report. *The International Journal of Sports Physical Therapy*, 7, 6, 672 – 677.
20. Morrissey, D., Roskilly, A., Twycross-Lewis, R., Isinkaye, T., Screen, H., Woledge, R. i Bader, D. (2011). The effect of eccentric and concentric calf muscle training on Achilles tendon stiffness. *Clinical Rehabilitation*, 25, 238 – 247.
21. Nørregaard, J., Larsen, C. C., Bieler, T. i Langberg, H. (2007). Eccentric exercise in treatment of Achilles tendinopathy. *Scandinavian Journal of Medicine and Science in Sports*, 17, 133 - 138.
22. Papa, J. A. (2012). Conservative management of Achilles Tendinopathy: a case report. *The Journal of the Canadian Chiropractic Association*, 56, 3, 216 - 224.
23. Purdam, C.R., Johnsson, P., Alfredson, H., Lorentzon, R., Cook, J. L. i Khan, K. M. (2004). A pilot study of the eccentric decline squat in the management of painful chronic patellar tendinopathy. *British Journal of Sports Medicine*, 38, 395 – 397.
24. Ram, R., Meeuwisse, W., Patel, C., Wiseman, D. A., Wiley, J. P. (2013). The limited effectiveness of a home-based eccentric training for treatment of achilles tendinopathy. *Clinical & Investigative Medicine*, 36 (4), 197-206.
25. Robert J. de Vos, Heijboer, M.P., Weinans, H., Verhaar, J.A.N. i T.M. van Schie. (2012). Tendon Structure’s Lack of Relation to Clinical Outcome After Eccentric Exercises in Chronic Midportion Achilles Tendinopathy. *Journal of Sport Rehabilitation*, 21, 34 – 43.
26. Roos, E.W., Engstrom, M., Lagerquist, A. i Soderberg, B. (2004). Clinical improvement after 6 weeks of eccentric exercise in patients with mid-portion Achilles tendinopathy - a randomized trial with 1-year follow-up. *Scandinavian Journal of Medicine and Science in Sports*, 14, 286 - 295.
27. Rowe, V., Hemmings, S., Barton, C., Malliaras, P., Maffulli, N., Morrissey, D. (2012). Conservative Management of Midportion Achilles Tendinopathy. *Sports medicine*, 42, 11, 941 - 967.
28. Saithna, A., Gogna, R., Baraza, N., Modi, C. and Spencer, S. (2012). Eccentric Exercise Protocols for Patella Tendinopathy: Should we Really be Withdrawing Athletes from Sport? A Systematic Review. *The Open Orthopaedics Journal*, 6, (3), 553 – 557.
29. Sandrey, M. A. (2004). Using eccentric exercise in the treatment of lower extremity tendinopathies. *Human Kinetics ATT*, 9, (1), 58 – 59.
30. Satyendra, L., Byl, N. (2006). Effectiveness of physical therapy for Achilles tendinopathy: An evidence based review of eccentric exercises. *Isokinetics and Exercise Science*, 14, 71 - 80.
31. Stasinopoulos, D., Manias, P. i Stasinopoulou, K. (2011). Comparing the effects of eccentric training with eccentric training and static stretching exercises in the treatment of patellar tendinopathy. A controlled clinical trial. *Clinical Rehabilitation*, 26, 5, 423 – 430.
32. Stasinopoulos, D., Stasinopoulou, K. i Johnson, M. I. (2005). An exercise programme for the management of lateral elbow tendinopathy. *British Journal of Sports Medicine*, 39, 944 – 947.
33. Stasinopoulos, D., Stasinopoulos, I., Pantelis, M. i Stasinopoulou, K. (2010). Comparison of effects of a home exercise programme and a supervised exercise programme for the management of lateral elbow tendinopathy. *British Journal of Sports Medicine*, 44, 579 – 583.
34. Svernlöv B. i Adolfsson L. (2001). Non-operative treatment regime including eccentric training for lateral humeral epicondylalgia. *Scandinavian Journal of Medicine and Science in Sports*, 11, 328 – 334.
35. Visnes, H. and Bahr, R. (2007). The evolution of eccentric training as treatment for patellar tendinopathy (jumper’s knee): a critical review of exercise programmes. *British Journal of Sports Medicine*, 41, 217 – 223.
36. Young, M.A., Cook J.L., Purdam C.R., Kiss Z.S. i Alfredson H. (2005). Eccentric decline squat protocol offers superior results at 12 months compared with traditional eccentric protocol for patellar tendinopathy in volleyball players. *British Journal of Sports Medicine*, 39, 102 – 105.

KICKING ACCURACY OF CROATIAN U-16 SOCCER PLAYERS

Ante Rada, Marko Erceg and Zoran Grgantov

Faculty of Kinesiology, University of Split, Croatia

Abstract

The main goal of this research was to determine the differences in kicking accuracy between young soccer players of different playing positions when shooting with maximum power. Players were separated into two groups by coaches (starters and nonstarters) and were tested with 8 soccer – specific field tests that evaluate kicking accuracy with standing ball and after dribbling, both with instep and side-foot kicks. Kicking accuracy with side-foot (dominant and non-dominant leg) and instep kick with non-dominant leg were a distinction between more efficient (starters) and less efficient (nonstarters) soccer players. Side-foot kicks with both legs indicate better accuracy in comparison to instep kicks. Furthermore, an overview of all tests shows that starters were more accurate than nonstarters and shots with dominant leg were more accurate than ones with non-dominant leg.

Key words: Kick precision, instep kick, side-foot kick

Introduction

Soccer is one of the most popular team sports in the world (Lees, Nolan 1998, Kellis, Katis 2007). It consists of various types of movements and actions like tackling, jumping, sprinting and kicking (Lees, Nolan 1998). Team that shoots more shots on the opponent's goal, as well as team that shoots more accurately over the course of match is more likely to be successful or win more games than its opponent (Kellis, Katis 2007, Katis et. al. 2013). Previous studies were focused on kicking velocity and instep kick as a major determinant for soccer success (Lees, Nolan 1998). Side-foot kick is widely and most frequently used for passing, shooting from shorter distances or shooting when shot accuracy is more important than the shot velocity. Furthermore, if the ball is kicked in such way that ball has a higher spin, lower speed, longer and a more curved path, it could also lead to accurate kicks. Instep kick on the other hand is frequently used from greater distances and in situations when shot power is more important than precision.

Kicking accuracy is to lesser extent explored (Kellis, Katis 2007), mostly because it is hard to measure it reliably and make adequate tests for evaluating precision of soccer kicks, further research should focus on establishing adequate tests for evaluate kicking accuracy because optimal approach speed generates accurate kick. It is also important to analyze differences between playing positions in kicking accuracy. Throughout the game, players, depending on the playing position, perform a large number of tasks with many different shots and passes. The main goal of this research was to determine the differences in kicking accuracy when shooting with maximum power between young soccer players of different playing positions.

Methods

This research was conducted on a sample of 44 young soccer players ($15,7 \pm 1,5$ years) members of NK "Adriatic" and HNK "Krilnik" from Split, Croatia. Both teams train 4 times per week and play one competitive match per week. Players were separated in two groups by coaches (starters and nonstarters) and were tested with 8 soccer – specific field tests that evaluate kicking accuracy with standing ball and after dribbling, both with instep and side-foot kicks. Respondents were tested in July at the end of competitive season 2012/2013. The tests took place two days in a row, beginning at 8. A.M. Prior to the tests, players warmed up and stretched for 20 minutes (running with and without the ball – 13 minutes, dynamic stretching 7 minutes). After that they had 8 warming shots, one for each shooting style they would shoot afterwards. All tests were conducted on a natural grass surface in dry, consistent weather conditions. Players wore their own soccer boots during the test. After having performing the shot all respondents waited for others to shoot. That way all players had enough time to recover for the next shot. The same order was kept for each player across all tests. Goal was divided into 5 equal parts (center, and four sideway parts). Players' aim for all 8 soccer-specific field tests was a center of the goal and they were kicking ball from 16 meters as powerful as they can. In four tests ball was stationary on 16 meter line (IKDL – instep kick dominant leg, IKNDL – instep kick non dominant leg, SFKDL – side foot kick dominant leg, SFKNDL – side foot kick non dominant leg), and in other four tests the task was to dribble the ball from 25 meters distance and shoot from 16 meter line after using arbitrary technique and touching the ball at least 3 times. If a player would hit central part of goal his accuracy score was 3. If a player would hit one of the four sideway

parts his score was 2 and 1 respectively, if they would miss the goal accuracy score was 0. During the tests examiner was standing behind the ball vertical to the goal.

Basic descriptive statistics were calculated; means (AS), standard deviation (SD), minimum and maximum results (Min., Max.), normality analysis (KS-test). Two factors 3x2 ANOVA with Fisher LSD post-hoc analysis was used to determine interaction effects between starters and nonstarters.

Results

Tables 1, 2, and 3 show the basic statistical parameters: means (AS), standard deviation (SD), minimum and maximum results (Min., Max.), normality analysis (KS-test) for defenders, midfielders and attackers of different quality level.

Table 1: Basic descriptive statistics for less and more efficient defenders: arithmetic mean (Mean), standard deviation (SD), minimum and maximum results (Min., Max.), normality analysis (K-S p)

Variables	Less efficient defenders (N=10)					More efficient defenders (N=6)				
	Mean	Min	Max	SD	K-S p	Mean	Min	Max	SD	K-S p
IKDL	4,15	0,00	7,00	2,08	p > .20	5,00	3,00	8,00	2,65	p > .20
IKNDL	3,92	0,00	7,00	1,75	p > .20	4,67	3,00	6,00	1,53	p > .20
SFKDL	5,46	3,00	7,00	1,05	p > .20	7,33*	6,00	9,00	1,53	p > .20
SFKNDL	3,31	1,00	6,00	1,70	p > .20	5,67*	3,00	9,00	3,06	p > .20
DIKDL	4,69	1,00	7,00	1,80	p > .20	6,00	5,00	7,00	1,00	p > .20
DIKNDL	4,46	2,00	8,00	1,76	p > .20	4,33	3,00	6,00	1,53	p > .20
DSFKDL	5,62	0,00	9,00	2,36	p > .20	6,00	4,00	8,00	2,00	p > .20
DSFKNDL	4,38	1,00	8,00	1,66	p > .20	6,00	4,00	8,00	2,00	p > .20

Legend: *p<0,05 – significance of differences between the less and more efficient defenders, IKDL – instep kick dominant leg, IKNDL – instep kick non dominant leg, SFKDL – side foot kick dominant leg, SFKNDL – side foot kick non dominant leg, DIKDL – instep kick dominant leg (after dribbling), DIKNDL – instep kick non dominant leg (after dribbling), DSFKDL – side foot kick dominant leg (after dribbling), DFKNDL – side foot kick non dominant leg (after dribbling).

Table 2: Basic descriptive statistics for less and more efficient midfielders: arithmetic mean (Mean), standard deviation (SD), minimum and maximum results (Min., Max.), normality analysis (K-S p)

Variables	Less efficient midfielders (N=7)					More efficient midfielders (N=11)				
	Mean	Min	Max	SD	K-S p	Mean	Min	Max	SD	K-S p
IKDL	4,57	2,00	7,00	1,99	p > .20	4,09	0,00	8,00	2,21	p > .20
IKNDL	2,86	0,00	5,00	1,57	p > .20	4,45*	1,00	7,00	1,81	p > .20
SFKDL	6,86	6,00	8,00	0,90	p > .20	7,00	4,00	9,00	1,34	p > .20
SFKNDL	4,00	1,00	6,00	1,67	p > .20	5,29*	4,00	6,00	0,76	p > .20
DIKDL	4,14	1,00	7,00	2,73	p > .20	5,36	3,00	9,00	1,75	p > .20
DIKNDL	2,43	0,00	5,00	1,72	p > .20	3,55	0,00	7,00	2,66	p > .20
DSFKDL	5,71	3,00	8,00	1,98	p > .20	4,91	2,00	7,00	2,02	p > .20
DSFKNDL	4,57	2,00	7,00	1,72	p > .20	4,64	2,00	8,00	1,91	p > .20

Legend: *p<0,05 – significance of differences between the less and more efficient midfielders, IKDL – instep kick dominant leg, IKNDL – instep kick non dominant leg, SFKDL – side foot kick dominant leg, SFKNDL – side foot kick non dominant leg, DIKDL – instep kick dominant leg (after dribbling), DIKNDL – instep kick non dominant leg (after dribbling), DSFKDL – side foot kick dominant leg (after dribbling), DFKNDL – side foot kick non dominant leg (after dribbling).

Table 3. Basic descriptive statistics for less and more efficient attackers: arithmetic mean (Mean), standard deviation (SD), minimum and maximum results (Min., Max.), normality analysis (K-S p)

Variables	Less efficient attackers (N=5)					More efficient attackers (N=5)				
	Mean	Min	Max	SD	K-S p	Mean	Min	Max	SD	K-S p
IKDL	5,25	4,00	7,00	1,26	p > .20	4,25	2,00	6,00	2,06	p > .20
IKNDL	3,00	1,00	7,00	2,71	p > .20	2,25	1,00	5,00	1,89	p > .20
SFKDL	6,00	4,00	7,00	1,41	p > .20	6,75	5,00	8,00	1,50	p > .20
SFKNDL	4,25	2,00	6,00	2,06	p > .20	4,50	4,00	5,00	0,58	p > .20
DIKDL	4,50	3,00	5,00	1,00	p > .20	3,75	1,00	6,00	2,06	p > .20
DIKNDL	3,50	3,00	4,00	0,58	p > .20	3,75	2,00	7,00	2,22	p > .20
DSFKDL	6,25	5,00	7,00	0,96	p > .20	5,50	3,00	8,00	2,08	p > .20
DSFKNDL	5,25	4,00	7,00	1,26	p > .20	4,75	3,00	6,00	1,26	p > .20

Legend: IKDL – instep kick dominant leg, IKNDL – instep kick non dominant leg, SFKDL – side foot kick dominant leg, SFKNDL – side foot kick non dominant leg, DIKDL – instep kick dominant leg (after dribbling), DIKNDL – instep kick non dominant leg (after dribbling), DSFKDL – side foot kick dominant leg (after dribbling), DFKNDL – side foot kick non dominant leg (after dribbling).

Two factors 3x2 ANOVA with Fisher LSD post-hoc analysis showed significant differences in the interaction effects between the starters and nonstarters.

By analyzing tables 1, 2, and 3, it is visible that in almost every variable more efficient (starters) players are more accurate than less efficient (nonstarters) players. In subsample of defenders, it is evident that in 2 of the 8 variables there are statistically significant differences in favor of the starters. More efficient defenders showed better accuracy with side-foot both with dominant and non-dominant leg when compared to less efficient defenders. More efficient midfielders showed statistically better results in 2 out of the 8 variables. Kicking accuracy with instep and side-foot kick with non-dominant leg was better in comparison with less efficient midfielders.

Table 4: Results of two factors 3x2 ANOVA with Fisher LSD post-hoc analysis

	LED	MED	LEM	MEM	LEA	MEA
Side-foot kick dominant leg						
LED						
MED	0,02					
LEM	0,02	0,57				
MEM	0,00	0,68	0,81			
LEA	0,44	0,16	0,27	0,17		
MEA	0,05	0,53	0,89	0,73	0,39	
Instep kick non-dominant leg						
LED						
MED	0,53					
LEM	0,22	0,16				
MEM	0,49	0,86	0,08			
LEA	0,39	0,24	0,90	0,18		
MEA	0,12	0,05	0,60	0,05	0,57	
Side-foot kick non-dominant leg						
LED						
MED	0,03					
LEM	0,31	0,74				
MEM	0,02	0,13	0,12			
LEA	0,33	0,27	0,32	0,80		
MEA	0,22	0,36	0,45	0,61	0,83	

Legend: LED - less efficient defenders, MED - more efficient defenders, LEM - less efficient midfielders, MEM - more efficient midfielders, LEA - less efficient attackers, MEA - more efficient attackers

Discussion and conclusion

Side-foot kicks with dominant and non-dominant leg as well as instep kick with non-dominant leg proved to be some of the major factors when it comes to differentiating more and less efficient players. Throughout all tests starters were more accurate than nonstarters and shots with dominant leg were more accurate than ones with non-dominant leg which is similar to previous findings (Bjelica et. al. 2011). Table 4. showed significant differences between the starters and the nonstarters of different playing positions in 3 of the overall 8 variables: kicking accuracy with side-foot (dominant and non-dominant leg) and instep kick with non-dominant leg made a distinction between less and more efficient players. Less efficient defenders were more inaccurate than all midfielders and more efficient (starters) attackers and defenders. Such results were expected considering that midfielders use side-foot kick frequently throughout the games for passing, maintaining ball possession and creating chances for attackers. More efficient attackers use this kick to score goals from various situations and angles; therefore it's more likely for them to score better with side-foot kick than defenders. More efficient (starters) defenders were also better than less efficient (nonstarters) defenders. Usually defenders are taller and heavier than other players, maintaining dominance in duels and heading the ball. Often it's the kicking accuracy, passing and shooting, that are the elements of distinction. Results of instep kicking with non-dominant leg suggest differences between more efficient (starters) attackers, midfielders and defenders with attackers having been the most inaccurate ones. Similar results were obtained with side-foot kick with non-dominant leg. It's likely that attackers from lower level of competition need more time to prepare for shot on an opponent's goal, adjusting themselves on dominant leg. Simultaneously defenders do not have an opportunity to adjust because every mistake could mean a chance for an opponent, so they must kick ball away from the goal with any leg at the given time. Overall, looking at tables 1, 2, and 3 this research showed better kicking accuracy while using side-foot kick in comparison to instep kick. These findings

match previous studies (Kellis, Katis 2007, Sterzing et. al. 2009). This research highlights differences in kicking accuracy between starters and nonstarters, within different playing positions. Further research should focus on dominant versus non-dominant leg asymmetry in kicking accuracy and to take in consideration different playing positions and quality level for players.

References

1. Bjelica, D., Georgiev, G., & Popović, S. (2011). Comparison of instep kicking between preferred and non-preferred leg in young football players. In *Proceedings of the 1st International Conference in Science and Football* (Vol. 58).
2. Katis, A., Giannadakis, E., Kannas, T., Amiridis, I., Kellis, E., & Lees, A. (2013). Mechanisms that influence accuracy of the soccer kick. *Journal of Electromyography and Kinesiology*, 23(1), 125-131.
3. Kellis, E., & Katis, A. (2007). Biomechanical characteristics and determinants of instep soccer kick. *Journal of sports science & medicine*, 6(2), 154.
4. Lees, A., & Nolan, L. (1998). The biomechanics of soccer: a review. *Journal of sports sciences*, 16(3), 211-234.
5. Sterzing, T., Lange, J. S., Wächtler, T., Müller, C., & Milani, T. L. (2009). Velocity and accuracy as performance criteria for three different soccer kicking techniques. In *ISBS-Conference Proceedings Archive* (Vol. 1, No. 1).

INTRAINDIVIDUAL ASSESSEMENT OF AEROBIC AND ANAEROBIC FITNESS IN ICE HOCKEY PLAYERS THROUGHOUT ANNUAL TRAINING CYCLE

Pavel Ruzbarsky, Viera Smerecka and Jozef Moroscak

Faculty of Sports, University of Presov in Presov, Slovakia

Abstract

The purpose of the study was to intraindividually assess aerobic (AE) and anaerobic (ANA) fitness in ice hockey players throughout annual training cycle. The sample consisted of 5 players on elite team (age 15.8 years). AE fitness was assessed using Beep test (distance covered) and spiroergometric testing W_{170} (VO_2 max). ANA fitness was determined by 30-second Wingate test [peak power (PP), average anaerobic power (AP) and fatigue index (FI)]. Aerobic fitness of players increased gradually throughout the annual cycle except play-offs. PP and AP increased in forwards but decreased during play-offs in defensemen. Mean value of PP classified as average and above-average was 10.55-12.1 W/kg. Mean value of AP was 9.13-9.86 W/kg. Mean value of VO_2 max was 46.5-61.9 ml/kg/min and average distance covered ranged from 2136 to 2612 meters.

Key words: peak power, average power, fatigue index, maximal oxygen uptake, ice hockey

Introduction

Current trend in elite sport requires a complex, systematic and long-term intra-individual approach to athletes in order to increase the efficiency of regulatory processes within the long-term athletic preparation (Laczo, 2003). Content analysis of sports performance in ice hockey has confirmed the relevance of sport-specific fitness under both aerobic and anaerobic conditions (Laczo, 2011). Sports performance in ice hockey is determined by overall physical fitness and strength together with aerobic and anaerobic capacity (Cox et al., 1995; Twist, 1997; Spencer et al., 2005; Green et al., 2006; Petrella et al., 2007; Buchheit, et al., 2011).

Physiological profiles of ice hockey players have confirmed the benefits of aerobic endurance, muscular endurance, anaerobic power, flexibility and skating speed (Montgomery, 1988; Twist & Rhodes, 1993). In terms of bioenergetic systems, ice hockey performance relies 69 % on anaerobic capacity and 31 % on aerobic endurance (Montgomery, 1988). The utilization of the anaerobic system can to certain extent depend on the level of the oxidative system (Cox et al., 1995). The determination of intra-individual adaptation effect induced by various types of training stimuli in compliance with the formation of structural changes in sport-specific fitness and their incorporation into the adequate dynamics of changes in the structure of sports performance is crucial in terms of achieving maximal level of performance. Effective development of individual qualities of conditioning abilities requires optimal manipulation of exercise dosage within different time frames so as to ensure effective intra-individual adaptive process in respective bioenergetic zones (Laczo, 2003).

Methods

The study sample consisted of 5 ice hockey players with average age 15.81 ± 0.48 years. Two players were members of the U16 and U17 Slovak ice hockey national teams. Changes in sport-specific fitness were determined via aerobic and anaerobic testing in order to assess the relation between variables, i.e. test scores and volume of training sustained throughout the individual phases of the annual training cycle. Aerobic and anaerobic fitness were measured at the beginning and at the end of off-season preparation phase, during the preseason preparation phase and 3 measurements were conducted during the in-season (see Table 1).

Table 1: Organization of measurement during the annual training cycle in ice hockey players

ATC		Wingate test	Beep test	Spiroergometric testing
Off-season	OS1	5/7/2012	5/3/2012	5/4/2012
Off-season	OS2	7/2/2012	6/21/2012	6/18/2012
Preseason	PS	8/31/2012	9/7/2012	8/27/2012
In-season	IS1	10/23/2012	10/23/2012	10/26/2012
In-season	IS2	1/2/2013	12/15/2013	12/14/2012
Play-offs	PO	3/1/2013	3/8/2013	3/15/2013

Aerobic fitness was assessed using a laboratory-based spiroergometric test performed on a cycle ergometer and a field-based running Beep test. The organism's internal response to exercise was expressed by maximal oxygen uptake (VO_{2max}), which is considered to be an integral measure of organism's oxidative metabolic capacity and capacity of the circulatory system. To determine the value of maximal oxygen uptake ($VO_{2max.kg^{-1}}$), incremental spiroergometric test to maximum was conducted. The initial load was 1.5 watts per kilogram body mass. The load increased 20 watts every minute and the test was performed to volitional exhaustion, or until achieving 1.05 value of respiration quotient. Aerobic fitness was assessed using the field-based running Beep test, which consisted of running over 20-meter distance. The intensity of running increased after first minute. The starting speed of 8 kph increased 0.5 kph every minute. Parameters measured were distance covered (m) and maximal oxygen uptake (ml/kg/min). Anaerobic fitness was measured from 30-second Wingate test performed on the cycle ergometer Monark Ergomedic 894E. The test was conducted to volitional exhaustion by pedaling against constant flywheel resistance set at 7.5 % subject's body mass. Parameters measured were peak anaerobic power (W/kg), average anaerobic power (W/kg) and fatigue index (%).

Results and discussion

The purpose of physical conditioning in ice hockey is to develop strength and speed, maintain high level of anaerobic and aerobic capacity during matches and to resist lactate accumulation in the working muscles for as long as possible. Gradual change in the aerobic to anaerobic work ratio is desired in terms of the nature of the hockey games (Cox et al., 1995; Spencer et al., 2005; Twist, 1997).

In terms of aerobic conditioning, aerobic power increased throughout the individual macrocycle phases except play-offs. The level of anaerobic conditioning expressed by peak and average anaerobic power increased throughout the entire macrocycle in forwards only. In defensemen, the values of both parameters increased during the macrocycle except play-offs, during which the values of parameters decreased.

Table 2: Aerobic and anaerobic fitness in forward P.H.

P.H.	Wingate test			Beep test		Spiroergometric testing
	Pmax (W/kg)	Pavg (W/kg)	FI (%)	VO_{2max} (ml/kg/min)	Distance (m)	VO_{2max} (ml/kg/min)
OS1	10.76	9.32	35	55.42	2140	46.31
OS2	10.12	9.03	31	55.99	2180	49.90
PS	11.06	9.25	34	51.45	1880	43.40
IS1	11.65	9.58	38	56.38	2200	52.07
IS2	11.36	9.37	38	58.28	2340	46.50
PO	11.46	9.68	37	54.57	2080	41.00

Note: Pmax – peak power, Pavg – average power, FI – fatigue index, VO_{2max} - maximal oxygen uptake

Training during the off-season preparation phase is targeted at the development of general endurance, speed endurance and strength. Specific on-ice training was not incorporated into the content of the training units. During this phase aerobic conditioning improved in every player as expressed by the increased level of maximal oxygen uptake. The values of VO_{2max} in ice hockey players range from 55 to 60 ml/min.kg (Tóth et al., 2010) with the elite players exceeding the value of 65 ml/min.kg (Grasgruber & Cacek, 2008). Our findings correspond with other studies (Bukač, 2005) reporting VO_{2max} values between 50 and 70 ml/min.kg. As reported by Tóth et al. (2010), higher VO_{2max} values are usually measured on a treadmill rather than on a cycle ergometer. Higher level of aerobic capacity was consistent with fatigue index, which was higher at the end of the preseason as compared to the baseline testing (see Tables 2-5).

As compared to the results of exercise testing conducted in elite Slovak ice hockey players, the value of fatigue index in most players was at the elite level 35.1 % (Tóth et al., 2010), which according to norms devised by Laczo (2011) may be classified as excellent. The results of anaerobic testing during the off-season preparation phase showed decline in the parameters measured. Such organism's adaptation was caused by the content of the off-season preparation. In terms of anaerobic power assessment, the parameters of anaerobic fitness in the sample subjects were lower than the values of anaerobic fitness found in elite Slovak ice hockey players during the entire off-season and preseason.

Table 3: Aerobic and anaerobic fitness in forward L.S.

L.S.	Wingate test			Beep test		Spiroergometric testing
	Pmax (W/kg)	Pavg (W/kg)	FI (%)	VO ₂ max (ml/kg/min)	Distance (m)	VO ₂ max (ml/kg/min)
OS1	10.29	9.23	27	56.56	2220	42.60
OS2	9.47	8.55	29	57.18	2260	49.70
PS	9.98	8.80	27	57.73	2300	42.60
IS1	11.16	9.56	43	62.90	2660	61.80
IS2	10.21	8.97	31	60.64	2500	63.20
PO	12.20	9.64	40	58.28	2340	53.30

Note: Pmax – peak power, Pavg – average power, FI – fatigue index, VO₂max - maximal oxygen uptake

The highest value of anaerobic power in 4 players was recorded during the in-season. Anaerobic power in player J.M. (see Table 4) was stable and was maintained at a high level during the entire macrocycle. This finding was probably associated with high level of endurance of the player. Changes in this parameter do not significantly manifest during the individual phases of the annual training cycle.

Table 4: Aerobic and anaerobic fitness in forward J.M.

J.M.	Wingate test			Beep test		Spiroergometric testing
	Pmax (W/kg)	Pavg (W/kg)	FI (%)	VO ₂ max (ml/kg/min)	Distance (m)	VO ₂ max (ml/kg/min)
OS1	12.54	9.48	43	61.70	2580	63.00
OS2	10.93	9.24	33	63.29	2700	66.10
PS	10.87	8.76	38	61.96	2600	65.40
IS1	10.84	8.95	32	-	-	-
IS2	-	-	-	63.00	2680	64.60
PO	11.63	9.33	37	60.64	2500	50.30

Note: Pmax – peak power, Pavg – average power, FI – fatigue index, VO₂max - maximal oxygen uptake

In the following phases of the season the level of peak and average anaerobic power gradually increased probably due to the content of training, which during the in-season was designed to maintain the level of aerobic power and to improve anaerobic capacity. Emphasis was placed on the improvement of game skills, game systems and combinations. During the latter part of the in-season (IS2), both peak and average anaerobic power increased in every player. The highest values were recorded in 2 forwards during the play-offs (see Tables 2-4). The volume of training declined while training intensity increased.

Table 5: Aerobic and anaerobic fitness in defenseman J.M.

J.M.	Wingate test			Beep test		Spiroergometric testing
	Pmax (W/kg)	Pavg (W/kg)	FI (%)	VO ₂ max (ml/kg/min)	Distance (m)	VO ₂ max (ml/kg/min)
OS1	12.46	9.90	38	60.19	2480	51.40
OS2	11.25	9.27	36	57.18	2260	60.00
PS	12.15	9.99	35	58.28	2340	56.00
IS1	12.59	10.04	39	64.82	2820	63.20
IS2	12.67	10.02	41	65.72	2900	64.15
PO	11.47	9.94	34	62.90	2660	51.70

Note: Pmax – peak power, Pavg – average power, FI – fatigue index, VO₂max - maximal oxygen uptake

We may therefore hypothesize that positive adaptation in anaerobic fitness was induced by training. This was expressed by increased level of anaerobic power as compared to the off-season preparation phase. As the macrocycle progressed, such course of changes was recorded in forwards only. During the play-offs, the level of anaerobic fitness in forwards increased while that of defensemen decreased (see Tables 5 and 6). The decline in anaerobic fitness of defensemen may

be attributed to lower game and training intensities as expressed by their 1:3 ratio unlike forwards with the ratio 1:1-2 with regard to previous phases.

Table 6: Aerobic and anaerobic fitness in defenseman E.K.

E.K.	Wingate test			Beep test		Spiroergometric testing
	Pmax (W/kg)	Pavg (W/kg)	FI (%)	VO ₂ max (ml/kg/min)	Distance (m)	VO ₂ max (ml/kg/min)
OS1	11.37	9.48	37	54.57	2080	48.40
OS2	11.23	9.15	41	54.00	2040	51.55
PS	11.16	9.11	37	58.00	2320	56.70
IS1	11.71	9.72	39	55.70	2160	52.20
IS2	12.19	9.94	41	57.25	2260	55.70
PO	10.93	9.64	29	54.00	2040	47.70

Note: Pmax – peak power, Pavg – average power, FI – fatigue index, VO₂max - maximal oxygen uptake

Conclusions

When assessing performance level of players, the individual specifics of each player have to be taken into consideration. Every person adapts to exercise in a specific way despite identical content of training. In such situations, intra-individual monitoring of players seems crucial in order to uncover the individual specifics and to make the exercise testing more complex by testing higher number of parameters that can determine performance itself. To make the fitness testing of players more complex, future research is going to be complemented by measurement of somatic parameters and post-exercise biochemical analysis.

References

1. Bukač, L. (2005). *Intelekt, učení, dovednosti a koučování v ledním hokeji*. Praha: Olympia.
2. Buchheit, M., et al. (2011). Reliability, usefulness, and validity of the 30-15 intermittent ice test in young elite ice hockey players. *Journal of Strength and Conditioning Research*, 25(5), 1457-1464.
3. Cox, M.H., et al. (1995). Applied physiology of ice hockey. *Sports Medicine*, 19(3), 184-201.
4. Grasgruber, P., & Cacek, J. (2008). *Sportovní geny*. Brno: Computer Press.
5. Green, H., et al. (2006). Relationship Between Physiological Profiles and On-ice Performance of National Collegiate Athletic Association Division I Hockey Team. *Journal of Strength and Conditioning Research*, (20)1, 43-46.
6. Laczó, E. (2003). Rozvoj a priebežná kontrola špeciálnych kondičných schopností vo vrcholovom športe. In *Telesná výchova a šport v treťom tisícročí* (pp. 34-37). Prešov: FHPV.
7. Laczó, E. (2011). Využitie vybraných biochemických a fyziologických parametrov hokejistov v riadení tréningového a zápasového zaťaženia. Retrieved January 15, 2014 from: <http://www.hockeyslovakia.sk/userfiles/file/Informacie%20zo%20sveta/Eugen-Laczó-SVK-senior.pdf>
8. Montgomery, D.L. (1988). Physiology of Ice Hockey. *Sports Medicine*, (5)2, 99-126.
9. Petrella, N.J., et al. (2007). Validation of the fast skating protocol to predict aerobic power in ice hockey players. *Applied Physiology, Nutrition and Metabolism*, (32), 693-700.
10. Spencer, M., et al. (2005). Physiological and Metabolic Response of Repeated-Sprint Activities. *Sports Medicine*, (35)2, 1025-1044.
11. Tóth, I. et al. (2010). *Tréner ľadového hokeja. Vysokoškolská učebnica pre trénerov špecializácie v ľadovom hokeji*. Bratislava: TO-MI Ice Hockey Agency v spolupráci so SZĽH a FTVŠ UK.
12. Twist, P., & Rhodes, T. (1993). A Physiological Analysis of Ice-Hockey Positions. *National Strength and Conditioning Association Journal*, (15)6, 44-46.
13. Twist, P. (1997). *Complete conditioning for hockey*. Champaign, IL: Human Kinetics.

CAFFEINE INTAKE ENHANCES ENDURANCE PERFORMANCE IN SUB-ELITE BUT NOT IN ELITE ATHLETES

Ondřej Smolka¹, Michal Kumstát² and Iva Hrnčířiková²

¹Department of Kinesiology, Faculty of sports studies in Brno, Masaryk University, Czech Republic

²Department of Health Support, Faculty of sports studies in Brno, Masaryk University, Czech Republic

Abstract

The aim of our contribution is to evaluate the influence of caffeine (CAF) ingestion on maximal power output (MPO) during endurance performance. Two groups of men - 10 sub elite cyclists and 8 elite cyclists completed the randomized, crossover, double-blind study. During three days participants completed three identical experimental tests (60 min cycling time trial on 70 % VO_{2max} followed by test to exhaustion). Three experimental meals - combination of 500 ml water, gel supplement and specific dose of caffeine: placebo (PLA, no caffeine), CAF2 (2 mg/kg BW) and CAF7 (7 mg/kg BW) were administered 45 min prior to the start of the experimental tests. Results show significant differences (0.018 and 0.019) between MPO_{PLA} and MPO_{CAF7} and maximal MPO_{CAF2} and MPO_{CAF7} ($p=0.05$) only in group subelite cyclists. These findings indicate that caffeine intake at recommended levels is not associated with improved performance in professional level cyclist.

Key words: caffeine, maximal power output, aerobic exercise, cycling

Introduction

Dietary supplements are an essential part of every athlete's diet. The appropriate use and the timing of dietary supplements intake may positively influence athletic performance and recovery. One of the most commonly used dietary supplements is caffeine. It is a natural component of many foods and beverages available to the general public. Caffeine is a stimulant that has a number of physiological and psychological effects. For this reason, it is widely used as a food supplement in the manufacture of sports nutrition. For many athletes, caffeine is part of the dietary regime. Its application is found before or during the competition, and the training effect of caffeine is dependent on its source, adopted quantity dosage, sex, nutritional status and other factors related to each individual (Magkos, F. & Kavouras, S.A., 2004). The influence of caffeine on the human body is studied in relation to the possible improvement of sports performance. The body has a number of effects associated with the direct influence on performance - stimulation of the central nervous system; increasing cAMP and influence on the activity of adrenaline are associated with increased lipolysis in adipose and muscle tissue, thereby increasing the availability of energy substrates to working muscles (Burke, L. & Deakin, V., 2002). This glycogen sparing potential is not the only mechanism explaining the ergogenic effect of caffeine. There is evidence of an increase in performance after caffeine without affecting the oxidation of nutrients. It has been recently demonstrated, that caffeine ingestion (3 mg/kg BW) is a possible strategy, that might enhance power output independently of muscle glycogen availability (Lane et al., 2013)

Contemporary protocols for CAF intake on the day of training or competition are based on recent evidence, that low doses of CAF (1-3 mg/kg BW) are equally effective as the traditionally used larger doses (6-9 mg/kg BW) (Ganio et al., 2009; McNaughton et al., 2008).

In the context of a potential ergogenic effects, caffeine was tested many times, and has already been administered to athletes in many different sources - chewing gum (Ryan et al., 2013), sports gels, Coca Cola, capsules and coffee (Jenkins et al., 2008; Cureton et al., 2007; Cox et al., 2002; Conway et al., 2003; Graham, T.E., 2001); Ganio et al., 2009).

The evidence for an ergogenic effect of caffeine on high-intensity performance is scant compared to the data with endurance tasks. From a practical point of view, it must be however noted, that the majority of performance-enhancing findings was generally verified in recreationally trained males. Whether findings could be extrapolated to the elite athletes, remains controversial. Above that, it is necessary that all evidence-based, though theoretical proposals and conclusions are clearly translated into the real training and/or competition practise. Therefore the aim of our study is to assess the variance between two groups of athletes with different training-fitness status.

Materials and methods

Research was precisely designed with respect to the caffeine-supplementation scientific trials. Ten male subjects, sub elite cyclist and 8 male subjects, elite cyclist (Table 1.) completed the randomized, crossover, double-blind study. The sample group was divided into sub-elite and elite category according to the training volume (km per year, training hours/week) and corresponding fitness status (VO_{2max}). Before giving their written informed consent, every participant became familiar of the possible negative consequences of all procedures. The study was reviewed and approved by the Ethics Committee of Faculty of Sports studies.

Table 1: Characteristics of the elite and sub-elite cyclists (Mean \pm SD, range)

Parameters	Sub-elite cyclists (n=10)		Elite cyclist (n=8)	
	Mean \pm SD	Range	Mean \pm SD	Range
Age (years)	27.7 \pm 4.1	22 – 35	23.5 \pm 5.6	18-35
Height (cm)	181.4 \pm 7.9	168 – 191	183.4 \pm 5.5	174 - 194
Body weight (kg)	77.6 \pm 8.0	68 – 92	76.4 \pm 9.0	63 - 89
VO_{2max} . (ml/kg)	56.9 \pm 6.6	50 – 67	66.4 \pm 8.7	59 - 79
BMI (kg/m ²)	23.6 \pm 1.5	22 – 28	22.7 \pm 1.8	21 – 26
FFM (kg)	68 \pm 6.8	61 – 82	67.7 \pm 7.6	57 – 79
Training volume*	(km / year)	5000 - 7000	18 000-22 000	
	h/week	10-15	30-35	

Legend: BMI – body mass index, FFM – fat free mass, *expressed in terms of mean volume of training over the last 3 years

Experimental design

The experimental measurements were preceded by the incremental cycling test to exhaustion. Maximal oxygen consumption tests (VO_{2max}) were undertaken one week before the first experimental trial. The maximal test was used to determine the power output corresponding to 70 % of each subjects VO_{2max} to be used in the experimental trials. During the three non-consecutive experimental days (within 1 month) participants completed three identical experimental trials (60min drive at the 70 % of VO_{2max} intensity followed by test to exhaustion). All tests were completed on a software controlled bicycle ergometer (Lode ExcaliburSport) using cardio metabolic unit Cortex MetaLyzor3B.

Three experimental liquid meals (combination of 500ml water, gel supplement and specific dose of anhydrous form of caffeine): placebo (PLA, no caffeine), CAF1 (2 mg/kg BW) and CAF2 (7 mg/kg BW) were administered 45min prior to the start of the experimental tests. Time and maximal power output (MPO [Watts]) during the exhaustion phase of the experimental trials were measured during. Rating of perceived exertion was determined during the measurements at a 2min interval using the Borg scale.

Participants were excluded if they are smokers, take medication that might affect physical performance or metabolism, or lack the ability to perform the laboratory tests or participate in moderate-intensity exercise. Each participant was asked to follow a particular specific pre testing carbohydrate-rich diet (8 g/kg BW) to eliminate the possible detrimental effects of the experimental measuring. Finally, participants were given instructions about caffeine-containing food and beverages and asked to abstain from caffeine ingestion at least 72 hours before the experimental measuring.

Statistical analysis

The data obtained were statistically analysed in the software NCSS 9 (Hintze, J., 2013) and presented as mean, standard deviation (SD) and range (minimum and maximum values). To determine the differences in maximal power output a t-test was used. The level of significance was set at the $p < 0.05$ level.

Results

Results show significant differences (Table 3.) between MPO_{PLA} and MPO_{CAF7} and maximal MPO_{CAF2} and MPO_{CAF7} ($p = 0.05$). The level of substantive significance was assessed using the Cohen's coefficient effect and was found middle and small "size of effect" (0.43 and 0.29). There was no significant effect of specific doses of caffeine on MPO in group B (Table 3.)

Table 2: Maximal power output during experimental trials

		Maximal power output (W)	
Experiment	Sample group	Mean \pm SD	Range
PLA	subelite (A)	361.1 \pm 24.7	325 – 404
CAF2		365.2 \pm 26.7	332 – 422
CAF7		372.9 \pm 28.4	338 – 421
PLA	elite (B)	432.4 \pm 44.0	360 – 480
CAF2		437.4 \pm 48.9	381 – 494
CAF7		434.5 \pm 64.1	287 – 500

Table 3: Statistical analysis of experimental trials within sub-elite (n=10) and elite (n=8) groups

	sub elite (p)	elite (p)
MPO _{PLA} vs MPO _{CAF2}	0,459	0,444
MPO _{PLA} vs MPO _{CAF7}	0,018	0,863
MPO _{CAF2} vs MPO _{CAF7}	0,019	0,803

Discussion

Caffeine is a substance, which is chronically integrated in sports dietary supplements. In 2004, caffeine was erased from the list of banned substances, but currently it is still a substance listed as a monitored (WORLD ANTI-DOPING AGENCY, 2013).

There is ample evidence in the literature that caffeine administered prior exercise enhances performance (Cox. et al., 2002; Ganio, et al., 2009; Jenkins, et al., 2008), however data, where positive ergogenic effect of caffeine dose on performance was not established are still available (Jacobson, et al., 2001; Hunter, et al. 2002). Contemporary research dominantly works with sub elite athletes. By incorporating a subgroup of elite (professional) athletes we tried to identify the possible superiority of dietary supplement intake in the context of various training status of athletes. Therefore we focus particularly on elite (professionally trained) athletes and make comparison with subelite group.

The primary aim of our specific research was to identify the variations in possible ergogenic effect of specific dose of caffeine (0,2 and 7 mg/kg BW) on maximal power output between well-trained (sub elite) and professionally trained (elite) athletes. We chose a methodology that is standardized by a number of corresponding studies. Experimental cycling trial was performed ~60 min after oral caffeine administration (Jenkins, et al., 2008; Cureton, et al., 2007; Cox. et al., 2002)

The measured data (Table 2) demonstrate that the ingestion of caffeine significantly increases maximal power output only in sub-elite group A (Table 3). The mean power output during experimental test was enhanced following caffeine ingestion (7 mg/kg BW) compared with placebo (361.1 \pm 24.7 vs. 372.9 \pm 28.4 W, p=0.05).

Furthermore, we found the dose response trend in sub-elite athletes. It must be noted that maximal power output was significantly enhanced both in CAF2 and CAF7 trial and it is assumed that the more caffeine well trained sub-elite (but not elite) athletes would ingest the better performance. However growing body of evidence suggests that moderate to low doses of caffeine (~ 3 mg/kg BW) are adequate.

Despite the fact we confirm the ergogenic role of caffeine intake on endurance performance consistently with recent well-designed study of Lane et al. (2013), yet these findings are not consistent with several other recent studies. In the study of Ryan et al. (2012) authors suggest that low-dose CAF (200 mg) administered in chewing gum has no effect on cycling performance in recreational athletes (VO_{2max} 45.5 \pm 5.7 ml·kg⁻¹·min⁻¹). Whether the form of CAF ingestion might modulate the performance outcome, remains to be established. McNaughton et al. (2008) in a study with well-trained athletes of similar fitness status (VO_{2max} 65.0 \pm 6.3 ml·kg⁻¹·min⁻¹) and CAF ingestion (6mg/kg BW) concluded that cycling performance was improved significantly.

There was no rationale for direct statistical comparison of sub elite and elite group, since the main effect of caffeine was only detected in the group of subelite cyclists.

It is therefore suggested a superiority of training status (the general state of preparedness of an athlete, characterizing the current level of adaptation to the requirements of the relevant sports specialization – in our case, cycling performance) above the supplementation of caffeine. These findings indicate that caffeine intake at both recommended (low) levels, i.e. 1-3 mg/kg BW and, moderate levels (6-9 mg/kg BW) previously thought to be ergogenic, is not associated with improved performance in professional level cyclist.

Conclusion

According to the results we suggest that caffeine supplementation represents lower ergogenic benefit for professional (elite) athletes compared to sub-elite.

References

1. Beedie, C., Stuart, E., Coleman, D., Foad, A. (2006). Placebo effects of caffeine on cycling performance. *Medicine and Science in Sports and Exercise*, 38 (12), 2159-2164.
2. Burke, L. & Deakin, V. (2010) *Clinical Sports Nutrition*. (4th ed, 715p.) Sydney: McGraw-Hill companies.
3. Cox, G.R., Desbrow, B., Montgomery, P.G., Anderson, M.E., Bruce, C.R., Macrides, T.A. et al. (2002). Effect of different protocols of caffeine intake on metabolism and endurance performance. *J. Appl. Physiol.* 93: 990-999.
4. Cureton, K.J., Warren, G.L., Millard-Stafford, M.L., Wingo, J.E., Trilk, J. and Buyckx, M. (2007). Caffeinated sports drink: ergogenic effects and possible mechanisms. *Int. J. Sport Nutr. Exerc. Metab.* 17: 35-55. Ganio, M.S., Klau, J.F., Casa, D.J., Armstrong, L.E., Maresh, C.M. (2009). Effect of caffeine on sport-specific endurance performance: A systematic review. *Journal of Strength and Conditioning Research* 23 (1), 315-324.
5. Graham, T.E. (2001). Caffeine and exercise: metabolism, endurance and performance. *Sport Med. Can. J. Appl. Physiol.* 26: S103-S108.
6. Hintze, J. (2013). NCSS 9. NCSS, LLC. Kaysville, Utah, USA. www.ncss.com
7. Hunter, A.M.; St Clair Gibson, A.; Collins, M.; Lambert, M. and Noakes, T.D. (2002) Caffeine ingestion does not alter performance during a 100-km cycling time trial performance. *Int. J. Sport Nutr. Exerc. Metab.* 12: 438-452.
8. Jacobson, T.L., Febbraio, M.A., Arkininstall, M.J. and Hawley, J.A. (2001). *Effect of caffeine co-ingested with carbohydrate or fat on metabolism and performance in endurance-trained men.* *Exp. Physiol.* 86: 137-144 doi: 10.1113/eph8602072. PMID: 11429627.
9. Jenkins, N.T., Trilk, J.L., Singhal, A., O'Connor, P.J. and Cureton, K.J. (2008). Ergogenic effects of low doses of caffeine on cycling performance. *Int. J. Sport Nutr. Exerc. Metab.* 18: 328-342.
10. Lane, SC., Areta, J.L.; Bird, SR.; Coffey, V.G.; Burke, LM.; Desbrow, B.; Karagounis, L.G.; Hawley, J.A. (2013) Caffeine ingestion and cycling power output in a low normal muscle glycogen state. *Med Sci Sports Exerc.* Aug;45(8):1577-84.
11. Magkos, F.; Kavouras, S.A. (2004) Caffeine and Ephedrine - Physiological, Metabolic and Performance-Enhancing Effects. *Sports Med. Sports Med.* 34 (13): 871-889.
12. McNaughton, L.R.; Lovell, R.J.; Siegler, J.; Midgley, A.W.; Moore, L.; Bentley, D.J. (2008) The effects of caffeine ingestion on time trial cycling performance. *Int J Sports Physiol Perform.* 2008 Jun;3(2):157-63.
13. Ryan, E.J.; Kim, C.H.; Muller, M.D.; Bellar, D.M.; Barkley, J.E.; Bliss, M.V.; Jankowski-Wilkinson, A.; Russell, M.; Otterstetter, R.; Macander, D.; Glickman, E.L.; Kamimori, G.H. (2012) Low-dose caffeine administered in chewing gum does not enhance cycling to exhaustion. *J Strength Cond Res.* Mar;26(3):844-50.
14. Ryan, E.J.; Kim, C.H.; Fickes, E.J.; Williamson, M.; Muller, M.D.; Barkley, J.E.; Gunstad, J.; Glickman, E.L. (2013) Caffeine gum and cycling performance: a timing study. *J Strength Cond Res.* Jan;27(1):259-64.
15. Sökmen, Bülent; Armstrong, Lawrence E; Kraemer, William J; Casa, Douglas J; Dias, Joao C; Judelson, (2008) Caffeine use in sports: consideration for athletes. *Journal of Strength and Conditioning Research*; 8; 22, 3; WORLD ANTI-DOPING AGENCY (2013) *THE 2013 MONITORING PROGRAM* http://www.wada-ama.org/Documents/World_Anti-Doping_Program/WADP-Prohibited-list/2013/WADA-Monitoring-Program-2013-EN.pdf

Acknowledgement

This project was financed by Masaryk university specific research MUNI/A/0935/2012. The authors thank to Peter Huta and participants for their helpfulness.

DIFFERENCES IN MORPHOLOGICAL AND MOTORICAL ABILITIES BETWEEN JUNIORS AND SENIORS IN BASEBALL

Marijan Tomašić, Marijana Čavala and Ratko Katić

Faculty of Kinesiology University of Split, Split, Croatia

Abstract

This research has been done on 33 baseball players, males, from 16 to 27 years of age. The aim of the study was to determine which tests measuring morphological characteristics and motor skills can detect the difference between the two groups. The difference was determined by analysis of variance, and the tested male players were divided into two qualitative groups, seniors and juniors. The results in relation to the players rank showed the greatest difference in the testing of motor skills that estimated the speed and explosive strength (force) and morphological measurement. The results can help coaches when planning training programs and the training process involving baseball players when selecting junior players to advance into the senior group.

Key words: baseball, morphology, motor skills, differences

Introduction

Baseball (base and ball) is a complex team sport game from the "bat and ball" games which is played on fields of a specific shape (Mandić, D. and Horvatin- Fučkar, M., 2010). Though still quite unknown in our country, baseball is one of the most popular sports in the world, especially in Northern America and East Asia. It is a dynamic and complex sport and its interesting rules make it attractive and popular. The complex technical elements of its performance (hitting the ball, defense, throwing the ball, running from base to base) demands that a player has a high level of developed motor skills: speed, strength, precision, agility, balance and flexibility. Given the kinesiological diversity involved with different playing positions, it is noted that the morphological and motor skills of baseball players have been the subject of much research (Agapov D.V., Krovnykov V.F., Boyko U.G., Hodorchenko V.M.; Wiliam Carvajal, MS, Andrés Ríos, MD, Ivis Echevarría, Miriam Martínez, Julio Miñoso, Dialvis Rodríguez, 2009; Szymanski i sur., 2010; Mandić, D., 2010). In particular, numerous studies are related to the throwing position (Lin, W.B., 2011; Gray, R., 2009), in many researches the velocity of the bat impact is observed (Lachowetz i sur., 1998; Escamilla i sur., 2010) and the importance of agility, especially at infield players (Mandić, D. i Horvatin-Fučkar, 2011). The intention of this study was to determine the morphological and motor characteristics of junior and senior in baseball, and compare their differences.

In this paper differences have been determined in the morphology and basic motor skills of baseball players from 16- 27 years, divided into two groups, the juniors and seniors. Although extended research has been done on players in America and Japan, one of the reasons for this paper was to research results in Europe, specifically Croatia. The tests showed that the senior group lacked the motivation for maximum results in all motorical testing compared to juniors who were motivated by the eventual possibility of being offered a position in the senior group. It is presumed that there will be an important statistical difference because the players are not equally physically developed. Apart from that, among the tested players there was also the difference in age and that they didn't have the same ability to perform certain motor tasks- they do not have the same motor and morphological features.

You also have to take into account that juniors are still physically developing (physically and psychologically) while seniors, they are in the peak of their baseball performance(for baseball players that peak is at 25-34 years of age, if you take into account that there is always the exception). Furthermore, one of the problems is also choosing the right test which will highlight the differences between the groups. With baseball being a sport where fast and forceful movements prevail, the battery of tests is therefore set in that way.

The aim of this research is to determine the differences between the junior and senior groups using a battery of morphological and motor skill tests, for easier planning and programming of training programs. The goal being the progress of the individual player as well as the entire team and the selection of junior players to advance to the senior team.

Methods

Variable sample

The sample is defined as a set of 33 male players (junior and senior) aged 16-27 years from the baseball club “Nada SSM” Split, Croatia. The players were selected in to groups by age, juniors (N = 17) and seniors (N = 16). In addition to age, the requirement for testing was that all players were clinically healthy and without any motor abnormalities, and that they voluntarily accessed the testing.

The sample of variables

The sample of variables in this study represents a battery of 10 tests, of which two tests that assess the morphological characteristics and eight tests that assess motor performance. To assess the motor abilities we selected eight measures: ball flight speed (MPH), 20m run from a standing start (20M), crossed arms sit-ups in 60s (TRB), throwing the medicine ball of 1kg (MED1KG), standing long jump (SDM), seated straddle stretch (FLEX), bent-arm hang (IZVIS) and obstacle course backwards (POLNAT). Measures of anthropometric characteristics were represented by body height (VIS) and body weight (TEZ) variables.

Methods of data processing

With descriptive procedures we identified the characteristics of the variables we used. It calculated the mean, standard deviation, minimum and maximum results, asymmetry coefficient (Skewness) and coefficient of curvature distribution (Kurtosis). The distributions were tested for normality with the Kolmogorov-Smirnovljjenim procedure; calculated the maximum difference between the real and theoretical cumulative frequencies. To determine the statistical significance of differences in morphology and motorical area between the average and the quality group of subjects, we used univariate (ANOVA) analysis of variance.

Results

In table 1 were entered the basic statistical parameters for each variable: the mean (AM), standard deviation (SD), the minimal (MIN) and maximum (MAX) range of results, coefficient of asymmetry (a_3) and coefficient of curvature (a_4), the maximum difference between the calculated and the expected cumulative frequency (MAXD). The values of the Kolmogorov-Smirnov test showed that all variables are normally distributed, and that we can proceed with further data processing.

Table 1: Descriptive statistics (N=33)

VAR	AM	MIN	MAX	SD	a_3	a_4	MAXD
VISI	178,64	161,00	191,00	8,05	-0,22	-0,59	0,09
TEZ	75,00	42,00	114,00	17,01	0,63	0,15	0,11
MPH	66,00	46,80	80,00	8,86	-0,47	-0,62	0,11
20M*	3,19	2,80	3,90	0,23	1,39	2,48	0,22
TRB	48,97	36,00	63,00	7,44	0,20	-0,87	0,14
MED1KG	10,12	3,40	14,80	2,55	-0,39	0,13	0,09
SDM	2,02	1,55	2,48	0,26	-0,08	-1,02	0,10
FLEX	71,73	42,00	99,00	14,31	-0,01	-0,60	0,07
IZVISI	44,99	13,37	78,47	19,09	0,03	-0,88	0,07
POL*	12,55	9,13	14,67	1,23	-1,05	1,78	0,12

TEST= 0, 24

Legend: AS- the mean, MIN-minimal result, MAX- maximum result, SD- standard deviation, SKEW- , coefficient of asymmetry (Skewness), KURT- coefficient of curvature (Kurtosis), MAXD- K-S test for normality.

In table 2 to determine the statistical significance of differences in morphology and motorical area between junior and senior players, we used univariate (ANOVA) analysis of variance.

Table 2: The results of univariate analysis of variance of the morphological and motorical space (ANOVA) between the junior and senior players

VAR	JUNIORS		SENIORS		F	P
	AS	SD	AS	SD		
VISI	173,30	6,30	184,31	5,41	28,86	0,00
TEZ	63	8,84	87,75	14,03	37,22	0,00
MPH	60,41	7,92	71,937	5,24	23,95	0,00
20M	3,31	0,25	3,07	0,11	9,23	0,00
TRB	46,65	8,05	51,43	6,05	3,90	0,06
MED1KG	8,48	2,20	11,87	1,54	25,86	0,00
SDM	1,88	0,24	2,18	0,20	15,00	0,00
FLEX	65,65	14,74	78,18	10,89	7,65	0,01
IZVISI	40,72	21,40	49,52	15,71	1,83	0,18
POL	12,78	1,26	12,30	1,20	1,76	0,19

Legend: AS-the mean, SD- standard deviation, F- the value of the F-test, p- level of significance.

From table 2 we can determine that the juniors and seniors differ in all variables. The seniors proved better in all of the tests, especially in the tests where strength and force prevailed. This was expected because only the best players were used from the senior group. Because baseball is a sport where explosive strength and force are used (throwing, running, leaping and jumping), this difference in tests gives us a clear insight into how big these differences are. Seeing that these three tests are easy to conduct and are often used to test the readiness of players, it is clear that seniors always show better results. Statistical differences in some tests are not visible and through the results of prior research they should have been (Kohmura Y., Aoki K., Yoshigi H., Sakuraba K., Yanagiya T.). Results such as those can only be explained, in the lack of motivation of seniors in all motorical tests for maximum results.

Conclusion

The aim of this research was to determine the differences between the junior and senior groups using a battery of morphological and motor skill tests, for easier planning and programming of training programs. The goal being the progress of the individual player as well as the entire team and the selection of junior players to advance to the senior team.

From the given results it is clear that the juniors and seniors differ in all variables. As mentioned earlier it is obvious that the seniors were not motivated on a higher level while performing these tests. If the seniors, compared to the juniors, were motivated more the differences would have probably been greater. As the test was primarily intended for juniors to be eventually included into the senior group and not for seniors who have been playing for a longer period of time and playing well, therefore no incentive to prove themselves. Given also the difference in age between the two groups it was expected that the seniors would be better in all the tests, for example running for 20m or throwing a fast ball(MPH). With running at 20m difference we can justify through the long stride of the fully developed longitudinal skeleton of a fully grown man opposed to the still developing structure of the junior. This also explains the test of throwing a ball. Seniors have a wider stretch of the arm allowing them to throw the ball faster and longer.

The differences would have been more apparent if research was done on a larger group of players. However since the testing was conducted on the best junior and senior players of the baseball team Nada SSM, the number of players tested was therefore limited. This research is valuable because it gives a significant insight into how certain players can correct certain anthropological features as well as detailed planning for the whole training program.

References

1. Escamilla, R. F., Fleisig, G. S., Yamashiro, K., Mikla, T., Dunning, R., Paulos, L., Andrews, J. R. (2010). Effects of a 4-week youth baseball conditioning program on throwing velocity. *Journal of Strength & Conditioning Research* 24(12):3247-54.
2. Gray, R.(2009). A Model of Motor Inhibition for a Complex Skill: Baseball Batting. *Journal of Experimental Psychology* 15 (2):91-105.
3. Lachowetz, T., Evon, J., Pastiglione, J. (1998). The Effect of an Upper Body Strength Program on Intercollegiate Baseball Throwing Velocity. *Journal of Strength & Conditioning Research* 12(2):116-119.
4. Lin, W. B., Tung, I. W., Chen, M. J., Chen, M. Y. (2011). An analysis of an optimal selection process for characteristics and technical performance of baseball pitchers. *Perceptual and Motor Skills* 113(1):300-310.

5. Mandić, D. (2010.). Specifične vježbe za razvoj i održavanje motoričkih sposobnosti u baseball-u. (diplomski rad). Zagreb: Kineziološki fakultet Sveučilišta u Zagrebu.
6. Mandić, D., Horvatin-Fučkar, M. (2011). Razvoj agilnosti kod igrača baseball-a. Zbornik radova s 9. godišnje međunarodne konferencije – *Kondicijska priprema sportaša/* Jukić, I. i sur. (ur.) 347-351.
7. Kohmura Y., Aoki K., Yoshigi H., Sakuraba K., Yanagiya T. Development of a baseball-specific battery of tests and a testing protocol for college baseball players. *Doctoral Program in Health and Sports Science, Juntendo University, Chiba, Japan.* 2008 Jul;22(4):1051-8.
8. Szymanski, D. J., Szymanski, J. M., Schade, R. L., Bradford, T. J., McIntyre, J. S., DeRenne, C., Madsen, N. H. (2010). The relation between anthropometric and physiological variables and bat velocity of high-school baseball players before and after 12 weeks of training. *Journal of Strength and Conditioning Research* 24(11):2933-2943.
9. Carter JE, Heath BH. Somatotyping: development and applications, 1st edition. New York: Cambridge University Press; 1990
10. Wiliam Carvajal, MS, Andrés Ríos, MD, Ivis Echevarría, Miriam Martínez, Julio Miñoso, MD, Dialvis Rodríguez, MS., Body Type and Performance of Elite Cuban Baseball Players, 2009.
11. Agapov D.V., Krovykov V.F., Boyko U.G., Hodorchenko V.M. Method of estimation of technical preparedness level of baseballs aged 12-14 years. *Physical Education of Students, Vol 2, Pp 3-10* (2013).

THE EFFECT OF SPECIFIC WARM-UP ON REACTIVE AGILITY IN TABLE TENNIS

Pavel Vacenovský and Tomáš Vencúrik

Faculty of Sport Studies, Masaryk University, Brno, Czech Republic

Abstract

The purpose of this study was to compare reactive agility of table tennis players before and after specific warm-up based on sport-specific game exercises. Twenty two table tennis players participated in our study (average age 21.8, height 178.2cm, weight 77.1kg). We used a modified Agility test for Table Tennis using the FiTRO Agility Check before (pre-test) and after warm-up (post-test) and compared the results. The effect of the warm-up was evident. We have proved a statistically significant improvement of reaction movement time. Reaction movement time was better by 4.87% equivalent 43.14 ms in our test (4.42% when using hands, 5.3% when using feet). Based on our findings, we recommend applying sport-specific exercises in the warm-up.

Key words: *Reaction movement time, FiTRO Agility Check*

Introduction

Warm-up (WU) is definitely part of every training session and pre-game process and should optimize athletes performance preparedness. Many have indicated, that the general purpose of warm-ups is to increase muscle and tendon suppleness, increase body temperature, stimulate blood flow to the periphery and enhance free coordinated movement (Smith, 1994, Martens, 2004, Dovalil, 2002, Holienka, 2001). Recent studies have mostly focused on the different effect of static and dynamic stretching. The study of Mcmillian et al. (2006) indicates agility and power performance enhancement with dynamic WU. Amiri-Khorasani et al. (2010) found that dynamic stretching during the WU was most effective as preparation for agility performance. Van Gelder & Bartz (2011) indicates that in comparison to static stretching or no stretching, dynamic stretching significantly improves performance on closed agility skills. According to Magner et al. (2012) dynamic WU had a greater impact on a single step choice reaction time than static WU. Gabbett et al. (2008) did not find a significant difference for speed, change of direction speed, reactive agility among two different dynamic WU; one that was inclusive of open skills and one that included only closed skills.

Table tennis claims high demands on the neuromuscular functions of the body and force players, in very short periods of time to react immediately to newly occurred game situations. That is why table tennis has been classified as a reaction sport according to Yoshida et al. (1995). With ball speeds that can reach more than 97 km/h, players have only a fraction of a second to judge the direction, speed, and amount of spin on opponents return, move into position and execute a stroke (McAfee, 2009). Getting into the correct position, the player starts from a ready position. Due to the speed of the game, by being in the ready position as frequently as possible, the player will hit cleaner shots more often than his opponents (Seemiller & Holowchak, 1997). For this reason a speedy reaction, decisiveness, quick movement and coordination as a part of agility are very important. Agility has been defined as a rapid, whole-body movement with change of velocity or direction in response to a stimulus (Sheppard & Young, 2006). No study focused on the effect of dynamic stretching or game exercises on reactive agility in table tennis has been found. Therefore we decided to detect and compare the level of reactive agility table tennis players before WU and after specific table tennis WU based on game exercises.

Methods

Twenty two well trained male players (1st-3rd czech league) participated in our study (24.3±5.64 years old, height 179.4±8 cm and weight 74.8±10.4 kg).

Agility test using using FiTRO Agility Check (FTVŠ UK, Bratislava, Slovakia) has been described in detail elsewhere (Zemková & Hamar, 2009) and has been used in sport games (Zemková & Hamar, 1999, Vala 2009), including racket sports (Pechova & Korvas, 2013). We applied a modified agility test for table tennis at the beginning of the session before WU (pre-test) and after specific WU (post-test) in the middle of the season. Subjects started the test 0,75 m from the table. They had to touch as fast as possible (with feet or hands) one of the four mats, two of which were located on the floor under the table and the other two in the corners of the table (figure 1). Width of the table 1.525 m. Mats had to be touched in accordance with the location of the visual stimulus appearing in one of the corners of the screen. The disposition of mats was in accordance with a sport-specific tasks of table tennis. Subjects had to touch the mats with the hand holding the racket, thus dominant hand and foot. Right-handers had to touch the mats with their right hand or right foot and left-

handlers with left hand or left foot. The test consisted of 16 visual stimuli (4 in each direction) with random generation of their localization and fixed time generation of 2000 ms. The test result is an average of the best reaction times (4 in each direction) in better of the two repetitions.

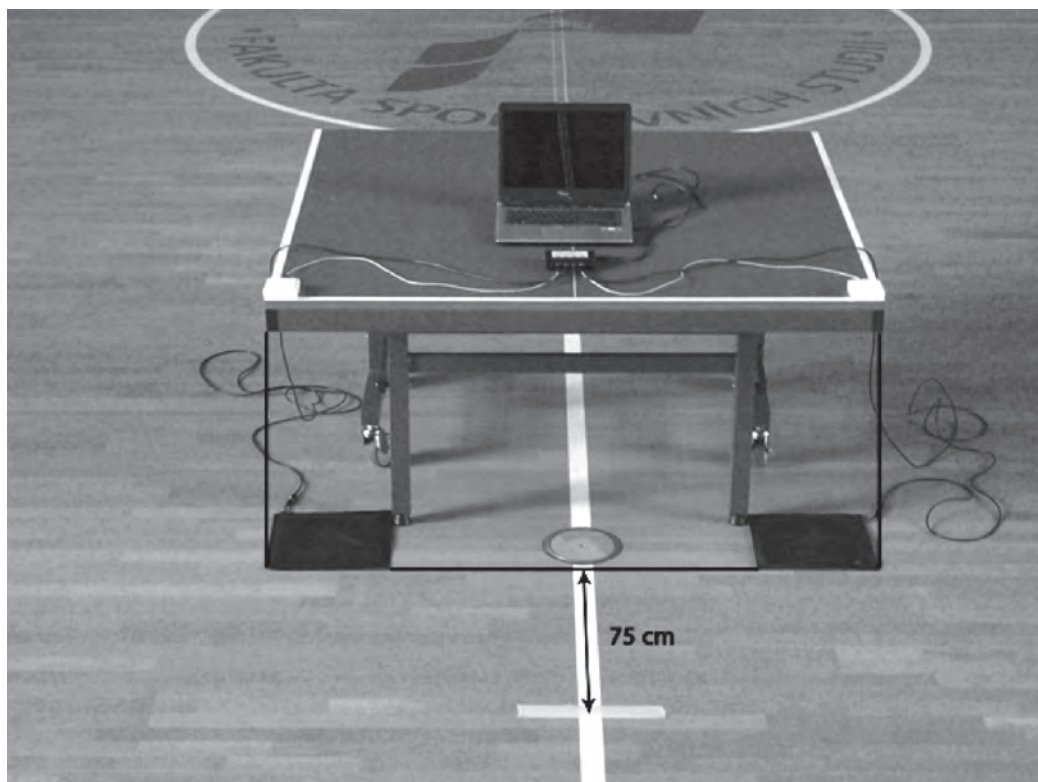

Figure 1: Modified agility test for table tennis

Each athlete performed a standardized 5-minute WU consisting of general movement and static and dynamic stretching. After general WU players continued 15-minute specific WU based on basic game exercises, gradually progressing from simple to more complex. We used closed game combination drills for forehand and backhand counter strokes.

Acquired data was processed statistically using basic descriptive statistics and Shapiro-Wilk test of distribution normality. Data from the pre-test and post-test (reaction movement time of feet, hands and the total reaction time) were compared using the dependent samples t-test. The statistical software Statistica 12 (StatSoft Inc., Tulsa, USA) was used for statistical calculations. Statistical significance was set at $p < 0.05$.

Results

Results of the modified test using FiTRO Agility Check are presented in table 1 and figure 2. There we can find the average reaction movement time in every direction before and after the WU. Almost each of the participants achieved better results after the specific WU. Average movement reaction time of all players was 885.94 ± 122.69 ms before warm-up and 842.80 ± 119.48 ms after the warm-up, an improvement of 43.14 ms (4.87%). Average movement reaction time in directions, where players had to use hands was 862.86 ± 118.52 ms before warm-up and 824.77 ± 118.73 ms after the warm-up, an improvement of 38.1 ms (4.42%). Average movement reaction time in directions, where players had to use feet was 909.02 ± 122.79 ms before warm-up and 860.84 ± 117.82 ms after the warm-up, which is better by 48.18 ms (5.3%). We detect statistically significant differences ($p > 0.05$) when these pre-test and post-test results were compared. Also we detect statistically significant differences ($p > 0.05$) in each direction except upper left.

Table 1: Average reaction movement time of table tennis player in ms

player	before warm-up					after warm-up				
	lower left	lower right	upper left	upper right	total avg	lower left	lower right	upper left	upper right	total avg
1	935	828,25	847,75	783,75	848,6875	883,5	917,5	861,25	771	858,3125
2	907,5	863	852,25	802	856,1875	841	862,5	752,75	739	798,8125
3	920	913,75	911,5	874,25	904,875	933,25	843	840,5	856,75	868,375
4	888,25	814,75	793	776	818	877,75	742,75	813,75	768	800,5625
5	1081	910	969,25	1098,25	1014,625	954,5	823,25	960,25	950,75	922,1875
6	1008,5	999	875,75	928,25	952,875	911,5	940,25	772,25	881,5	876,375
7	923	969,5	815,5	864,25	893,0625	943	766	953,25	804	866,5625
8	774,5	799,75	783,25	761	779,625	791,5	762	738	734	756,375
9	954,25	962	814,25	885,75	904,0625	937	910,5	821	816,5	871,25
10	729,25	845,75	734	832,25	785,3125	730,5	832,75	777,5	802,25	785,75
11	1016,75	970	1011	953,75	987,875	961	962,5	997,75	1018	984,8125
12	956,25	979	1023	919,75	969,5	849,25	920	947,5	807	880,9375
13	1004,75	854,25	871,25	898,75	907,25	859,5	774,5	846,25	704,5	796,1875
14	864,75	783	743,75	854,75	811,5625	842,75	820	751,25	819,25	808,3125
15	913,5	874,5	841,75	865,5	873,8125	840,75	772	762,5	716,5	772,9375
16	1025,5	1163	946,75	1037,25	1043,125	958,25	1046,5	874,25	975,25	963,5625
17	784,25	754,5	764,25	797	775	784,75	720,25	852	825	795,5
18	926,5	880,75	928,5	823,5	889,8125	833,75	778,75	907	828,5	837
19	954,25	1012	947	974,25	971,875	1016,5	997	967,25	1011,25	998
20	894,75	861,25	834,5	797,5	847	864,5	880,75	763,25	819	831,875
21	813,25	756,75	730	665,25	741,3125	709,5	695,25	623	530	639,4375
22	1073,25	853	893	841,75	915,25	939,5	845,5	765	764,25	828,5625
all players	924,9545	893,0795	860,5114	865,2159	885,9403409	875,6136	846,0682	833,9773	815,5568	842,8039773

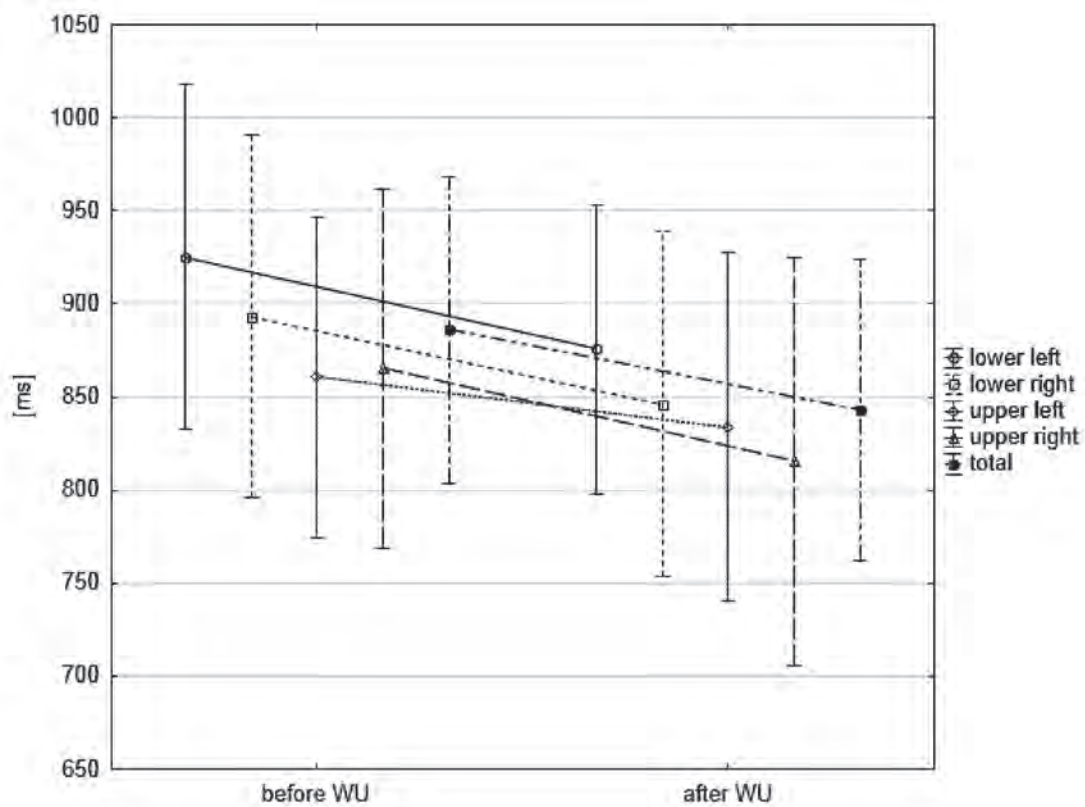

Figure 2: Reactive agility before and after WU

Discussion and conclusions

Table tennis players train regularly and this fact contributes to their reaction ability, as demonstrated in their study Vidja et al. (2012), which states that the longer players play table tennis, the better visual reaction time they have. The fact that table tennis players are among athletes with the best reaction time confirms Strešková (2002). However, the reactive agility can be influenced even on the day of training or match if WU is carried out effectively. Our study showed an overall statistically significant improvement of almost 5 percent, which in a game like table tennis is a substantial improvement. Statistically significant difference was not found in direction upper left, despite average improvement of 26.5 ms. That might be influenced by the fact that all players prefer attacking style and use topspin stroke with different movement structure. Difference in improvement, when compared using the foot resp. the hand, was found negligible. This is due to the fact that all players are very well-trained individuals who are able to prepare for the performance due to the warm-up in complex and have good control of the movement of the whole body.

Based on our findings, we strongly recommend to include sport-specific exercises to the WU. It does not matter whether it is an open or closed skills, as we mentioned above (Gabbett et al., 2008). Inclusion of dynamic sport-specific activities also recommended Chaouachi et al. (2010). The WU also has significant impact on the player performance as a whole, not just physical abilities and coordination. Further research should continue including the deepening of knowledge that we have developed in this our primary research.

References

1. Amiri Khorasani, M., Sahebozamani, M., Tabrizi, K., & Yusof, A. (2010). Acute effect of different stretching methods on Illinois agility test in soccer players. *Journal of Strength and Conditioning Research*, vol. 24(issue 10), pp. 2698-704.
2. Chaouachi, A., Castagna, C., Chtara, M., Brughelli, M. ... Behm, D. (2010). Effect of warm-ups involving static or dynamic stretching on agility, sprinting, and jumping performance in trained individuals. *Journal of Strength and Conditioning Research*, vol. 24(issue 8), pp. 2001-11.
3. Dovalil, J. (2002). *Výkon a trénink ve sportu*. (Vyd. 1., 331 s.) Praha: Olympia.
4. Gabbett, T., Sheppard, J., Pritchard-Peschek, K., Leveritt, M., & Aldred, M. (2008). Influence of closed skill and open skill warm-ups on the performance of speed, change of direction speed, vertical jump, and reactive agility in team sport athletes. *Journal of Strength and Conditioning Research*, vol. 22(issue 5), pp. 1413-5.
5. Holienka, M. (2001). *Rozcvičenie vo futbale*. Bratislava: Slovenský futbalový zväz,
6. Magner, A., Chatham, K., Spradley, B., Wiriyanit, S. ... Akins, T. (2012). Static Stretching versus Dynamic Warm Up: The Effect on Choice Reaction Time as Measured by the Makoto Arena II. *The Sport Journal*, Vol.15(No.1). Retrieved from: <http://thesportjournal.org/article/static-stretching-versus-dynamic-warm-up-the-effect-on-choice-reaction-time-as-measured-by-the-makoto-arena-ii/>
7. Martens, R. (2004). *Successful coaching*. (3rd ed., viii, 509 p.) Champaign, Ill.: Human Kinetics.
8. McAfee, R. (2009). *Table tennis: steps to success*. (xx, 203 p.) Champaign, Ill.: Human Kinetics.
9. Memillian, D., Moore, J., Hatler, B., & Taylor, D. (2006). Dynamic Vs. Static-Stretching Warm Up: The Effect On Power And Agility Performance. *Journal of Strength & Conditioning Research (Allen Press Publishing Services Inc.)*, vol. 20(issue 3), pp. 492-499.
10. Pechová, L., & Korvas, P. (2013). Analýza reakčně- rychlostních schopností u rekreačních hráčů badmintonu (pilotní výzkum). *Studia Sportiva*, roč. 2013(č. 1), s. 135 - 140.
11. Seemiller, D., & Holowchak, M. (1997). *Winning table tennis*. (vi, 177 p.) Champaign, IL: Human Kinetics.
12. Sheppard, J., & Young, W. (2006). Agility literature review: Classifications, training and testing. *Journal of Sports Sciences*, vol. 24(issue 9), pp. 919-932.
13. Smith, C. (1994). The Warm-Up Procedure: To Stretch or Not to Stretch. A Brief Review. *Journal of Orthopaedic*, vol. 19(issue 1), pp. 12-17. DOI: <http://dx.doi.org/10.2519/jospt.1994.19.1.12>.
14. Strešková, E. (2002). Prínos zisťovania disjunktívnych reakčno-rýchlostných schopností v stolnom tenise. *Acta Facultatis Educationis Physicae Universitatis Comenianae*, 43, 147-151
15. Vala, R. Diagnostika reakčně-rychlostních schopností hokejistů pomocí testu Fitro Agility Check. *Acta Facultatis excercitationis corporis universitatis Presoviensis*. 2009, roč. 3(sv. 3), s. 50-54.
16. Van Gelder, L., & Bartz, S. (2011). The effect of acute stretching on agility performance. *Journal of Strength and Conditioning Research*, vol. 25(issue 11), pp. 3014-21.
17. Vidja, K., Dodhia, S., Bhabhor, M., Bhanderi, P. ... Jani, H. (2012). Long Term Playing of Table Tennis Improve the Visual Reaction Time. *International Journal of Scientific Research*, 1(6), Retrieved from <http://theglobaljournals.com/ijst/file.php?val=Mjgy>
18. Yoshida K., Hiruta, S., Shimaoka, M., K., F., Ilmoto, Y., & Yuza, N. (1995). A study on spin control techniques for chop and float services in table tennis. Proceedings FISU/CESU Conference: The 18th Universiade 1995 Fukuoka, Japan
19. Zemková, E., & Hamar, D. (2009). *Toward an understanding of agility performance*. (1st ed., 65 s.) Boskovice: Albert.
20. Zemková, E., & Hamar, D. (1999). Disjunktívne reakčno-rýchlostné schopnosti u športovcov rôznych špecializácií. *Slovenský lekár*, roč. 9(č. 4 – 5), s. 145.

EVALUATING THE INFLUENCE OF BIOENERGY ON PHYSIOLOGICAL PARAMETERS IN THE RECOVERY AFTER HIGH - INTENSITY STIMULATION

Vlatko Vučetić¹, David Zubčić¹, Gordana Jukić² and Igor Jukić³

¹*Sports Diagnostic centre, Faculty of Kinesiology, University of Zagreb, Croatia*

²*Biotherapist according to the method of Zdenko Domančić, Croatia*

³*Faculty of Kinesiology, University of Zagreb, Croatia*

Abstract

The aim of this study is to determine the influence of bioenergy healing in recovery after high intensity stimuli on physiological parameters, which are already accepted as indicators of fatigue. Specifically to evaluate the influence of bioenergy on the values of heart rate (HR), lactate concentration and oxygen uptake (VO₂). Based on still unconfirmed scientific mechanisms of bioenergy action, the hypotheses are set in a way that receiving of bioenergy may affect physiological indicators of fatigue, speed and quality of recovery. The study included fourteen male (24.35 ± 2.87 years, body height 186.02 ± 8.40 and body mass 84.96 ± 10.37) who underwent testing on four occasions. Protocol of the testing has always been the same while the modalities of recovery altered. During the first test a placebo bioenergy was used, during the second and fourth tests standard mode of recovery, while in the third protocol testing the subjects received bioenergy in precisely defined periods. Differences in arithmetic means in the twenty-two variables between the four protocol tests were determined using ANOVA and Bonferroni test. Results indicated that receiving of bioenergy accelerate more the process of decline in heart rate and decrease in oxygen uptake than other two modes of recovery. The values of blood lactate concentrations indicated that treatment of bioenergy healing does not affect acceleration of their removal, in fact, during the third protocol testing while receiving bioenergy the slowest removal of blood lactate was observed in two of the three variables. The results, with emphases on the heart rate value and oxygen uptake, indicate that bioenergy healing treatment can be useful phenomenon in the field of sport recovery. Since the paradoxical relationship between heart rate and receiving oxygen with the values of lactate in the blood is noted, these results also indicate many additional questions that will be an object of future research.

Key words: *bioenergy healing, high intensity stimulus, recovery, heart rate, oxygen uptake, blood lactate*

Introduce

Modern top sport has reached unimaginable high value of training volume. High competition, constellation in society and media who glorifies sport, and enormously huge investment in sport industry, simply do not allow to be different. Most athletes, especially the elite, practiced two or more strenuous training on day where they go to their physiological and psychological limits. Despite, it seems that Henry Didon's monitoring motto "citius, altius, fortius" has no end, and there is an evident tendency of modern top sports to additional increase extensiveness and intensity of training. This is only possible by regular planning and programming of training work and recovery. In sports is constantly present pursuit of experts to using the best possible methods that can increase the quality and quantity of work. Certain methods are highly represented and used for many years, while the influence of some are not evaluated yet and are not exist in the official categorization of recovery. One of these is Biotherapy Healing according to the method of Zdenko Domančić, which is so far the only hypothetically explained. This study contributes modestly to review and possibly changing the current condition by objectively evaluating the effects of bioenergy healing, as well as complementary methods, on the values of heart rate, which is accepted as a good indicator of the degree of fatigue, and recovery. Interpretation of results is significantly more difficult because this area is not sufficiently explored and that there are no studies which examined the impact of bioenergy on selected physiological parameters. Hypotheses are set on the basis of scientific verification biotherapist Zdenka Domančića which occurred 1985th, 2003rd and 2007th year, and based on hypothetical mechanisms of action of bioenergy that are described in the books of Radovan Starc, Phd.

Methods

Subjects

The study group consisted of 14 males anamnesticly healthy and ready to carry out measurements. The subjects were aged 24.3 ± 2.87 years, body height 186.02 ± 8.40 cm and weight 84.96 ± 10.37 kg. Measurements were carried out at Sports Diagnostic centre, Faculty of Kinesiology, University of Zagreb. All the protocol tests are conducted in accordance

with ethical principles. For each subject was verbally explained the procedure before beginning research, after which subjects were given consent for participating.

Procedure

The study lasted for four weeks during June and July of year 2013. During this period, each subject was involved in four protocol tests. Protocol testing was always the same, only the modalities of recovery altered. Each protocol test consisted of four phases: the initial measurement of RMR (resting metabolic rate), warm - up, the main part of the protocol testing and finally measuring of RMR. Basal metabolism or RMR was measured on a computerized system Quark b2 (Cosmed, Italy) for 15 minutes at the beginning and at the end of each protocol testing. During this test, subjects were in a completely peaceful lying position on his back and were breathing through respiratory mask connected to a system for continual recording of the results. The parameter observed in this test is the oxygen uptake (VO_2) which is expressed in ml /min. The main part of the testing was consisted of highly intensive stimuli or three sets in which subjects were running 120 steps with maximum speed. Typically anaerobic glycolytic load is selected to be caused high value of heart rate and lactic acid in the blood. Observing the performance of all subject the fastest performance in one set was 41,02 seconds while the slowest performance was 70,57 seconds. During the rest between sets, which lasted for five minutes, heart rate value and blood lactate concentration were noted.

During the first protocol of testing used placebo transferring bioenergy and the subjects thought to receive bioenergy, but by biotherapist not transmitted. Periods in which it occurred: during the initial measurement of RMR, in recovery between sets anaerobic glycolytic stimulus and on the finally measurement of RMR. In a second (SR1) and fourth (SR2) protocol of testing, during the above mentioned period, used standard or normal modality of recovery. This would mean that the subjects was not stimulated by either placebo or bioenergy treatment. In the third protocol testing subjects were stimulated bioenergy that is passed according to the method of Zdenko Domančić.

Variables

Twenty-three variables were analyzed in this study. Eighteen variables related to the heart rate which three are related to peak heart rate during high insensitive set (HR peak1, HR peak2, HR peak3), and the remaining fifteen related to indices of HR decrease during recovery. Decreasing indices are obtained by subtracting the HR peak 1., 2., or 3. with heart rate in a particular minute of recovery and divided with product of number sixty and the minute of recovery: $HR_{In_{xy}} = (HR_{peak X} - HR Y) / 60 * Y$. The first index number indicates the set number and the second represents the time of recovery when recorded heart rate value. Three variables related to the blood lactate concentration (Lac In1, Lac In2, Lac In3) are representing declining of indices calculated by subtracting the concentration of lactate in the first minute of recovery with the value of the fifth minute of recovery. The indicator of energy consumption, oxygen uptake was measured before and immediately after intense stimulation (VO_2 1 and VO_2 2).

Statistical analysis

Statistica for Windows 8.0 and Microsoft Office Excel 2007 were used for storage and statistical analysis of the results. Univariate analysis of variance (ANOVA) and Bonferroni Post hoc method were used to analyze the differences between group means.

Results

In both variables related to oxygen uptake (VO_2 1 and VO_2 2) the lowest average values were observed when receiving bioenergy. The highest average value in variable VO_2 1 was recorded during the second protocol of testing, or during standard modality of recovery. When it comes to variable VO_2 2, the highest average value was recorded during placebo modality. Statistical significance of differences was found in both variables. (Table 1.)

Table 1: Results in variables of oxygen uptake

	PLACEBO M ± SD	SR1 M ± SD	BIOENERGY M ± SD	SR2 M ± SD	F - value	p - value
VO_2 1 (ml/min)	391,7 ± 50,8	408,4 ± 46,2	368,5 ± 28,6	398,2 ± 37,6	3,48	<0,05 A
VO_2 2 (ml/min)	558,0 ± 58,2	546,8 ± 60,7	512,7 ± 54,1	540,7 ± 49,53	3,13	<0,05 B
A = significant difference was found between SR1 and Bioenergy						
B = significant difference was found between Placebo and Bioenergy						

Analysis of the data revealed that in all three variables of peak heart rate minimum average values achieved in the third protocol testing, or when receiving bioenergy. In all fifteen variables indices of HR decrease highest average values were observed also when receiving bioenergy. Opposite values were observed during the placebo modalities of recovery, which is attributed to the first protocol of testing, which carries a certain number of psycho - physical problems. Statistically significant differences of the average values were found in 6 out of 18 variables, or in 33,3 %. (Table 2.)

Table 2: Results in variables of heart rate

	PLACEBO M ± SD	SR1 M ± SD	BIOENERGY M ± SD	SR2 M ± SD	F - value	p - value
HR peak1 (bpm)	182 ± 7,01	177,14 ± 8,42	176,21 ± 6,90	178,71 ± 7,72	5,53	<0,05 A
HR peak2 (bpm)	181,29 ± 6,29	177,79 ± 7,03	177,14 ± 6,5	179,57 ± 7,35	7,03	<0,05 B
HR peak3 (bpm)	179,93 ± 6,24	178,43 ± 6,60	177,36 ± 6,3	179,29 ± 7,22	2,17	0,1
HR In ₁₁ '	0,550 ± 0,19	0,620 ± 0,13	0,634 ± 0,16	0,579 ± 0,21	1,80	0,16
HR In ₁₂ '	0,510 ± 0,07	0,514 ± 0,06	0,547 ± 0,09	0,500 ± 0,08	3,72	<0,05 C
HR In ₁₃ '	0,399 ± 0,04	0,419 ± 0,06	0,429 ± 0,06	0,399 ± 0,05	4,78	<0,05 D
HR In ₁₄ '	0,314 ± 0,02	0,322 ± 0,04	0,332 ± 0,04	0,318 ± 0,04	1,58	0,2
HR In ₁₅ '	0,250 ± 0,03	0,266 ± 0,03	0,276 ± 0,03	0,261 ± 0,02	2,53	0,07
HR In ₂₁ '	0,520 ± 0,14	0,620 ± 0,12	0,626 ± 0,14	0,545 ± 0,16	5,40	<0,05 E
HR In ₂₂ '	0,474 ± 0,08	0,457 ± 0,05	0,475 ± 0,07	0,460 ± 0,06	0,96	0,42
HR In ₂₃ '	0,369 ± 0,05	0,370 ± 0,05	0,372 ± 0,05	0,360 ± 0,04	0,83	0,48
HR In ₂₄ '	0,292 ± 0,03	0,290 ± 0,03	0,295 ± 0,03	0,287 ± 0,04	0,41	0,74
HR In ₂₅ '	0,240 ± 0,03	0,242 ± 0,03	0,246 ± 0,03	0,238 ± 0,03	0,88	0,45
HR In ₃₁ '	0,542 ± 0,16	0,585 ± 0,12	0,592 ± 0,15	0,523 ± 0,13	2,33	0,08
HR In ₃₂ '	0,450 ± 0,08	0,461 ± 0,08	0,477 ± 0,06	0,445 ± 0,08	1,60	0,2
HR In ₃₃ '	0,359 ± 0,05	0,359 ± 0,05	0,361 ± 0,04	0,345 ± 0,05	1,19	0,32
HR In ₃₄ '	0,279 ± 0,03	0,284 ± 0,04	0,296 ± 0,03	0,272 ± 0,03	4,09	<0,05 F
HR In ₃₅ '	0,232 ± 0,03	0,232 ± 0,03	0,241 ± 0,02	0,231 ± 0,03	1,11	0,3
A = significant differences were found between Placebo and Bioenergy, and between SR1 and Placebo						
B = significant differences were found between Placebo and Bioenergy, and between SR1 and Placebo						
C = significant difference was found between SR2 and Bioenergy						
D = significant differences were found between Placebo and Bioenergy, and between SR2 and Bioenergy						
E = significant differences were found between Placebo and Bioenergy, and between SR1 and Placebo						
F = significant difference was found between SR2 and Bioenergy						

As far as the value of blood lactate concentration, it was recorded that indices of decrease were minimum in 2 out of 3 variables during the receiving of bioenergy, precisely in variables Lac In1 and Lac In3. In variable Lac In2 minimum average value was recorded during the fourth protocol of testing, or during the standard modality of recovery. Statistically significant difference was not determined in any of variables. (Table 3.)

Table 3: Results in variables of blood lactate concentration

	PLACEBO M ± SD	SR1 M ± SD	BIOENERGY M ± SD	SR2 M ± SD	F - value	p - value
Lac In1	0,46 ± 1,68	0,57 ± 0,99	0,33 ± 0,82	0,37 ± 0,60	0,17	0,91
Lac In2	0,70 ± 1,00	0,95 ± 1,05	0,73 ± 0,89	0,66 ± 0,64	0,34	0,79
Lac In3	1,47 ± 1,21	1,25 ± 1,72	0,66 ± 0,64	1,22 ± 0,84	1,64	0,19

Discussion and Conclusion

Since the topic is very sensitive and relatively unexplored, interpretation of results is not an easy task. To facilitate, this work focuses on two basic principles. The first of these is the fact that the human body aims to maintain homeostasis, or constant conditions in the internal environment. During physical activity and recovery afterwards there is the same tendency, so all organs and tissues in the body perform functions that help maintain a steady state. Another determinant, the results of explanation are based on, is the assumption that the surplus or deficit of bioenergy disrupts the harmony of the energy of the body, making it more difficult or even completely postponed achievement of homeostasis. Following the hypothesis that bioenergy represents an informed energy which knows at all times what to do for the good of the organism, the transfer of bioenergy by biotherapist comes to balancing the energy body, and accelerate the establishment of homeostasis. The assumption is that bioenergy, which transmits biotherapist aligned with the resonant frequencies of the Earth and Schumann cavity, by his informing further activates the sympathetic or parasympathetic system which leads to equilibrium. The increased activity of the sympathetic or parasympathetic part will cause the autonomic imbalance, and that consequently leads to increased sensitivity to changes in the opposite direction. In this case, the hypothesis is that after sympathetic stimulation, i.e. highly intense stimulus, receiving bioenergy with the aim of re-establishing homeostasis further excites the parasympathetic part of the vegetative nervous system through its nerve impulses, mainly vagus, influences on vasodilatation of all systems by enhancing circulation globally organism. Such as, consequently, leads to decrease in blood pressure, increase blood flow, reduce heart rate and oxygen consumption, and reduced level of lactate. When the above findings and hypotheses connect with the results of this study, then, following the principles of recovery enthroned, contradictory picture is received. The results of heart rate and oxygen consumption show a clear tendency to a faster decline in their value when receiving bioenergy, while the concentration of lactate shows diametrically opposite response. The question is how to interpret these results. Perhaps the expected occurrence to receive informed energy forms lactate in the blood decrease, but knowing the physiological fact that the diffusion of lactate from the muscle into the bloodstream is relatively slow process a different interpretation of the results imposes. If the goal of every organism is, as quickly as possible, to establish a steady state at all levels, particularly in the previously active muscles, then knowing the mechanisms, it is logical to assume that receiving bioenergy goes in the direction to speed up this process. The hypothesis that the bioenergy accelerates diffusion of lactate from the muscle into the blood in order muscle cells to be restored as soon as possible and to generally accelerate the transformation and removal of lactate in the body. The assumption is that such a process affects rapidly decrease the concentration of lactate in the muscles, but also the short-term increase in the value of the blood. Thus speeding up the removal of lactate watching the entire system and thus depleting the increased concentration of lactate in the blood are not a negative phenomenon, but they are transitional station, which contributes to speed up the whole process. The argument for such a flow of things is the results of the decline in heart rate and oxygen uptake, which should be highly correlated with the rate of lactate removal, so it is very contradictory to expect that the rapid decrease in heart rate and oxygen uptake are accompanied by reduced removal of lactate at the global level. Based on the obtained results it can be concluded that there are indications that bioenergy with its effects helps optimize postoperative recovery phase, but for more accurate conclusions in the new research the measurement of intramuscular lactate values and long-term measurement of blood lactate concentration during recovery should be included. (Domančić, 1987; Guyton i Hall, 2003; Starc 2012; Viru 1995)

References

1. Domančić, Z. (1987). Neslućene sposobnosti čovjeka u uskoj vezi s njegovim mentalnim i fizičkim zdravljem. Poljana: Autorsko izdanje.
2. Guyton, A.C., Hall, J.E. (2003). Medicinska fiziologija. Zagreb: Medicinska naklada.
3. Starc, R. (2012). Liječenje bioenergijom prema metodi Zdenka Domančića. Ljubljana: Sirius.
4. Viru, A. (1995). Adaptation in sports training. Boca Raton, Florida: CRC Press.

THE EFFECT OF AQUATIC PLYOMETRIC TRAINING ON PHYSICAL PERFORMANCE

Vlatka Wertheimer

Faculty of Kinesiology, University of Zagreb, Croatia

Abstract

Many team and individual sports require complete athletes with great functional capacities, motor abilities and skills. One big aspect of requirements can be developed using plyometric training regime that can be very useful but on the other hand, it can present a great threat for musculoskeletal apparatus because of great eccentric loads and high rate of force development in combination with low basic jumping skills. Water environment can offer lower eccentric loads and greater concentric resistance due to physical properties such as density, viscosity and buoyancy. The goal of this study is to analyze if eight week long aquatic plyometric training program can result with better physical performance in physically active men. Results showed significant differences between control group and treatment group, with main differences in vertical jump, speed and agility variables with “middle” and “high” effect sizes on the same variables. In conclusion, physically active man can achieve greater performance as a result of aquatic plyometric program but with no observed underlying mechanisms of improvement.

Key words: aquatic training, jumping exercises, eccentric loads

Introduction

Plyometric exercises are regularly used by athletes to improve strength, power, speed, joint function and stability, balance and neuromuscular control during landing (Donoghue et al., 2011; Martel et al., 2005; Markovic, 2007). These exercises incorporate stretch-shortening cycle that involves rapid and intensive eccentric contraction, storing elastic energy, which is immediately followed with rapid concentric contraction producing explosive movement (Markovic, 2007; Miller et al., 2001; Miller et al., 2007). High forces generated during eccentric phase are associated with lower extremities injuries (Almeida et al., 1999; Jamurtas et al., 2000).

Aquatic plyometric training (APT) presents a concept of training that has recently become popular method for improving jumping abilities but with great potential of reduced muscle soreness and musculoskeletal injury in contrast to land plyometric training (LPT) (Donoghue et al., 2011; Robinson et al., 2004; Shiran et al., 2008; Triplett et al., 2009). Water environment can offer lower eccentric loads and greater concentric resistance due to physical properties such as density, viscosity, buoyancy and hydrostatic pressure. Because there is no such amount of eccentric loading, buoyancy reduces myotactic stretch reflex, but during concentric movement subjects encounter greater resistance because of viscosity of water.

At the moment there are several studies regarding APT. Martel et al. (2005) tested nineteen female volleyball players, pre and post six week long aquatic treatment. They concluded that combination of APT and volleyball training can result in large improvement in vertical jump abilities. Triplett et al. (2009) concluded on twelve junior handball players that one of the benefits of this type of exercise and training is performance without compromising speed while reducing the potential for joint injury and also reported significant higher values for peak concentric force and rate of force development, but lower for impact forces. Robinson et al. (2004) compared changes in performance indicators and muscle soreness between APT and LPT. Thirty-two women were randomly assigned to groups with identical plyometric program for eight weeks. Results of this study showed that APT can be effective in enhancing power, torque and velocity in physically active women with less reported muscle soreness. Coleman (2011) also investigated the effects of plyometric program on sprint performance on high school sprinters. After six weeks of plyometric training both aquatic and land group had similar scores in vertical jump height, 20 meters sprint and muscle soreness, while land group was significantly better in 10 meter block sprint. Both groups improved their scores with plyometric training indicating that both forms of training were effective and providing that APT could be just as effective as traditional LPT. On the other hand, Miller et al. (2007) found no significant differences in average force and power after performing APT concluding that water depth should be wisely chosen because the eccentric and concentric movement could be delayed in water causing slower overall movement and therefore decreasing stretch-shortening cycle. Same authors (2002) found no significant changes among both experimental groups (aquatic and land) for muscle soreness, power and vertical jump.

Inconsistent and inconclusive findings could be result of water depth, treatment length and also investigation on different population. The goal of this study is to analyze if eight week long aquatic plyometric training program can result with better physical performance in physically active men. Main characteristic of this APT program design was larger number of single-leg jump exercise and repetitions in overall number of jumps.

Methods

To achieve the purpose of this study, there was 21 physically active and healthy kinesiology student randomly distributed into two groups with 11 and 10 participants each; a control group (CG) and aquatic plyometric training group (AQG), respectively. All students had no previous issues with lower extremities injuries and they all had the same level of physical activity. Six selected variables measured level of physical performance. Speed was assessed using the time for a 5 meter sprint running (v5), 10 meter sprint running (v10) and 20 meter sprint running (v20). Agility, also referred as change of direction speed was assessed using the time for running 20 yards (20y) with changing direction two times. Explosive power was assessed using height for a standing vertical jump (VJ) and length for a standing horizontal (long) jump (SLJ). Speed test were measured using photocell system (Newtest, Finland). Aquatic training group underwent experimental treatment for 8 weeks, 2 days per week for 45-60 min. Every participant was positioned in water at hip-depth level with arms positioned on hips. Each training included warm-up in water for 5-10 min that included running and hopping in water. After that AQG performed following bilateral aquatic plyometric exercises: 1. Ankle jumps; 2. Countermovement jumps; 3. Drop jump (30 cm) and unilateral (single-leg) aquatic plyometric exercises: 4. Single leg ankle hops; 5. Single leg countermovement jumps; 6. Single leg forward jumps; 7. Alternate-leg bounds; 8. Single leg lateral hops; 9. Lateral bounds. Experimental program had progressive character from 150 to 200 jumps weekly.

All participants were pretreatment and post-treatment measured in all variables. Software program Statistica 10.0 was used to analyze collected data with analysis of variance (ANOVA/MANOVA) for repeated measurements and additionally Tuckey posthoc test was conducted. Cohen's d effect size was used to determine the magnitude of a treatment effect, suggesting that level of 0,2 represents "small" effect, 0,5 represents "medium" effect and 0,8 represents "large" effect.

Results

Participants of this study were physically active males with average basic descriptive means presented in Table 1. In the pretreatment measurements, there were no significant differences among the participants of control and aquatic group regarding physical performance variables. 2x2 analysis of variance (ANOVA/MANOVA) yielded significant difference in the means among the groups by trial (Table 2). Table 3 shows average means during pretreatment and post-treatment measurements with effect size and there were no observed significant changes in control group in any of tested variables (Wilks lambda=0,962, F(6,15)=0,98, p=0,995). Table 3 also shows the same parameters for aquatic group with higher effect sizes and significant changes in tested variables (Wilks lambda=0,417, F(6, 13)=3,032, p=0,044). A Tuckey posthoc tests was used to identify which variables means were significantly different and indicated that four variables (v5, v10, VJ, 20y) elicited significant difference between groups (Table 4).

Table 1: Basic descriptive parameters

GROUP	NUMBER	AGE(godine)	BODY WEIGHT (kg)	BODY HEIGHT (cm)	BODY FAT (%)
CG	11	22,18 ± 2,40	74,3 ± 4,34	177,21 ± 3,92	10,64 ± 2,37
AQG	10	21,90 ± 1,73	78,68 ± 10,24	178,58 ± 6,28	13,27 ± 5,20

Table 2: 2x2 ANOVA/MANOVA(*p<0,05)

	Wilks lambda	F	Effect df	Error df	p
R1*GROUP	0,286	5,839	6	14	0,003*

Table 3: Pretest-posttest measurement with effect size values

CG	PRETREATMENT MEASUREMENT					POST-TREATMENT MEASUREMENT				d	ES
	N	Mean	Std.Dev.	Skewness	Kurtosis	Mean	Std.Dev.	Skewness	Kurtosis		
v5	11	1,58	0,09	-0,12	-0,18	1,57	0,06	-0,05	1,14	-0,02	0,26
v10	11	2,36	0,11	0,33	-0,88	2,34	0,08	0,39	-0,68	-0,02	0,22
v20	11	3,67	0,14	0,46	-1,39	3,64	0,14	0,27	-0,69	-0,04	0,27
VJ	11	52,91	5,29	1,47	2,09	53,97	4,15	0,11	-0,44	1,06	0,23
SLJ	11	228,88	14,69	-0,32	-0,94	231,33	13,72	-0,76	0,01	2,45	0,18
20y	11	5,03	0,26	0,23	-0,33	5,02	0,16	0,15	-0,96	-0,01	0,03
AQG	PRETREATMENT MEASUREMENT					POST-TREATMENT MEASUREMENT				d	ES
	N	Mean	Std.Dev.	Skewness	Kurtosis	Mean	Std.Dev.	Skewness	Kurtosis		
v5	10	1,59	0,08	-0,03	-0,03	1,52	0,07	0,13	-0,28	-0,07	0,99
v10	10	2,35	0,13	0,01	-1,42	2,27	0,09	0,60	-0,44	-0,08	0,80
v20	10	3,69	0,23	0,38	-1,27	3,56	0,15	1,08	0,70	-0,13	0,70
VJ	10	57,13	10,33	0,28	-1,28	62,20	9,54	0,73	-0,04	5,07	0,54
SLJ	10	237,67	25,73	0,18	-1,15	240,07	19,86	-0,71	0,20	2,40	0,11
20y	10	5,12	0,49	0,74	-0,33	4,85	0,21	0,73	-0,46	-0,28	0,77

Table 4: Significant results by Tukey posthoc tests (* $p < 0,05$)

Tukey HSD test							
v5	AQG	v10	AQG	VJ	AQG	20y	AQG
CG	$p=0,045^*$	CG	$p=0,040^*$	CG	$p=0,009^*$	CG	$p=0,015^*$

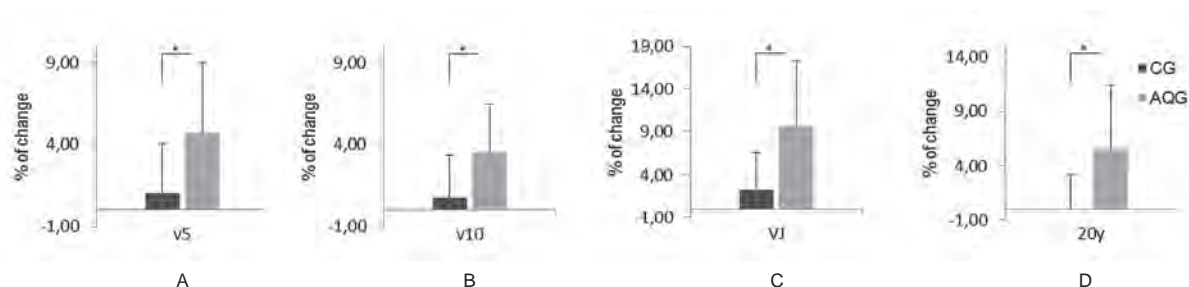
Figure 1: A, B, C, D. Percentage of change in selected variables for both groups with significant differences between groups (* $p < 0,05$).

Discussion

This study was performed to determine whether there are any significant differences in physical performance as a result of participating in an APT program after eight weeks, and the main result revealed significant differences between groups. Results of the other studies with similar goals also showed significant differences between groups (Robinson et al., 2004; Arazi and Asadi, 2011) but other authors mainly observed differences in single parameters such as vertical jump. Martel et al. (2005) reported significantly higher VJ for 11%. Robinson et al. (2004) reported approximately 33% better vertical performance and power and in study done by Miller et al. (2007) physically active participants in chest and waist deep water improved their vertical jump for 2.5% and 5%, respectively. Stemm and Jacobson (2007) also reported significantly better vertical jump results for approximately 5,8 % but concluded that the depth of the water is fundamental factor when the goal is to improve muscle power. In this research physically active men improved their vertical jump 9,67% with Cohen's d 0,54 which presented a medium magnitude of treatment. Observation on sprint parameters (v5 and v10) showed 4,67% and 3,53% better performance after APT program with high effect size (0,99 and 0,80, respectively). Other authors also reported significant improvements, but on different sprint test such as 36,5 m and 60 m (Arazi & Asadi, 2011), 40m (Robinson et al., 2004), so the tested parameters from this study are mainly presenting reaction and sprint acceleration. Miller et al. (2006) in his study reported significant improvements in three different agility test (T-test - 4.86%, Illinois agility test - 2.93%, and the force plate test – over 10%) which are result of motor recruitment and neural

adaptations. Shiran et al. (2008) reported 8,5% better results in agility T-test which are approximately similar to results of this study in which AQG is significantly different from CG and have improved agility by 5,5% with almost “large” effect size (0,77). Regarding to horizontal component of explosive power, results of this study showed no differences between groups and almost none treatment effect and there wasn’t found studies which investigated effect of APT on horizontal component of explosive power.

Previous studies that showed improvements in power, force and sprint as a result of aquatic plyometric training (APT) have been conducted over six to twelve week training period, but on the other hand most of those studies did not found differences between aquatic and land plyometric groups, so several authors (Robinson et al., 2004; Miller et al., 2006) recommended that longer training period will allow more time for progressing and adaptation to plyometric training and therefore give opportunity to improve patterns of jumping movements on land, but especially in water.

In conclusion, encouraging results from this study are presenting benefits of eight week aquatic plyometric training program in physical active men that can help other researchers and trainers who are searching “new” forms of training with possibilities of lower muscle soreness and musculoskeletal stress. Although this study did not determine underlying mechanisms of improvement in physical performance it is assumed that aquatic plyometric programs can promote changes in neuromuscular system and enhance efficiency possibly due to lower loads as a result of buoyance which can slower the downward phase but facilitate faster transition from eccentric to concentric phase of jump. Also this program design incorporated a larger contribution of single leg jumps in overall number of jumps that are more appropriate for athletes, as a functional movement in specific sport performance, but also in everyday activities of physically active men.

References

1. Almeida, S.A., Williams, K.M., Shaffer, R.A., and Brodine, S.K. (1999). Epidemiological patterns of musculoskeletal injuries physical training. *Medicine and Science in Sports and Exercise*, 31(8), 1176–1182.
2. Arazi, H. & Asadi, A. (2011). The effect of aquatic and land plyometric training on strength, sprint, and balance in young basketball players. *Journal of Human Sport and Exercise*, 6(1), 101-111.
3. Coleman, M.M. (2011). The effects of aquatic plyometrics on sprint performance on high school sprinters. Sacramento: California State University.
4. Donoghue, O.A., Shimojo, H., and Takagi, H. (2011). Impact forces of plyometric exercises performed on land and in water. *Sports Health*, 3(3), 303-309.
5. Jamurtas, A.Z., Fatouros, I.G., Buckenmeyer, P., Kokkinidis, E., Taxildaris, K., Kambas, A., And Kyriazis, G. (2000). Effects of Plyometric Exercise on Muscle Soreness and Plasma Creatine Kinase Levels and Its Comparison with Eccentric and Concentric Exercise. *Journal of Strength and Conditioning Research*, 14(1), 68–74.
6. Markovic, G. (2007). Does plyometric training improve vertical jump height? A meta-analytical review. *British Journal of Sport Medicine*, 41 (6), 349-354.
7. Martel, G.F., Harmer, M.L., Logan, J.M. & Parker, C.B. (2005). Aquatic plyometric training increases vertical jump in female volleyball players. *Medicine and Science in Sports and Exercise*, 37(10), 1814–1819.
8. Miller, M.G., Herniman, J.J., Ricard, M.D., Cheatham, C.C., and Michael, T.J. (2006) The effects of a 6-week plyometric training program on agility. *Journal of Sports Science and Medicine*, 5, 459-465.
9. Miller, G.M., Berry, D.C., Bullard, S. & Gilders, R. (2002). Comparisons of land-based and aquatic-based plyometric programs during 8-week training period. *Journal of Sport Rehabilitation*, 11, 268-283.
10. Miller, M.G., Cheatham, C.C., Porter, A.R., Ricard, M.D., Hennigar, D. & Berry, D.C. (2007). Chest- and waist-deep aquatic plyometric training and average force, power, and vertical-jump performance. *International Journal of Aquatic Research and Education*, 1, 145-155.
11. Potach, D. & Chu, D. Plyometric training. In: Earle RW, Baechle TR, eds. *Essentials of Strength Training and Conditioning*. Champaign, IL: Human Kinetics, 427-470.
12. Robinson, L.E., Devor, S.T., Merrick, M.A. & Buckworth, J. (2004). The effects of land vs. aquatic plyometrics on power, torque, velocity, and muscle soreness in women. *Journal of Strength and Conditioning Research*, 18(1): 84–91.
13. Shiran, M.Y., Kordi, M.R., Ziaee, V., Ravasi, A. & Mansournia, M.A. (2008). The effect of aquatic and land plyometric training on physical performance and muscular enzymes in male wrestlers. *Research Journal of Biological Sciences*, 3(5), 457-461.
14. Stemm, J.D. & Jacobson, B.H. (2007). Comparison of land- and aquatic-based plyometric training on vertical jump performance. *Journal of Strength and Conditioning Research*, 21(2), 568–571.
15. Triplett, N.T., Colado, J.C., Benavent, J., Alakhdar, Y., Madera, J., Gonzalez, L.M., and Tella V. (2009). Concentric and Impact Forces of Single-Leg Jumps in an Aquatic Environment versus on Land. *Medicine and Science in Sports and Exercise*, 41 (9), 1790–1796.

THE EFFECTS OF DIFFERENT TRAINING MODALITIES ON BONE MASS: A REVIEW

Cvita Gregov and Sanja Šalaj

Faculty of Kinesiology, University of Zagreb, Croatia

It is evident that there are a large number of studies dealing with the problem of osteoporosis due to the exponential growth of fracture occurrence in elderly population (Riggs & Melton, 1995). The risk for fracture is closely related to the natural loss of bone mass in women and men as a result of aging (Gomez-Cabello, Ara, Gonzalez-Aguero, Casajusand, & Vicente-Rodriguez, 2006). Due to obvious demographic changes in age, i.e. an overall process of population aging, the number of fractures is higher than expected which indicates that bone quality is deteriorating from one generation to the next. In order to prevent the deterioration it is necessary to come up with appropriate prophylactic and therapeutic methods. Apart from standard methods comprising of calcium and vitamin D supplementation which don't have a great effect on bone density (Jackson et al., 2006), one of the best non-pharmacological methods for lifelong improvement of bone mass is physical exercise, or participation in quality training, as evidenced by number of studies (Vicente-Rodriguez, 2006). Of course, practical work and scientific research indicate that not all modalities of exercising are equally efficient in improving bone mass, i.e. there are modalities that can significantly affect the bone quality and there are those that don't have a notable influence on the same. Therefore, it is necessary to determine most efficient physical exercise modalities for in improving bone mass quality in different age groups through inspection of previous studies. The importance of physical activity in enhancing bone quality, i.e. increasing bone mass and strength is evidenced by number of studies showing positive effects of sport and various types of training on above mentioned properties. This is supported by results of studies which indicate that training is potentially superior to supplementation of essential minerals for metabolism and bone mass formation (Hemayattalab, 2010; Arab Ameri, Dehkhoda, & Hemayattalab, 2012). Regarding type of training, or type of physical activity with the highest potential for increasing bone mass, there are two activities that stand out – performing with great loadings and jump exercises, that is, strength training and plyometric training (Gaudalupe-Grau et al., 2009; Markovic and Mikulic, 2010). Another type of training focused on increasing bone mass that stands out lately is vibration training, but compared to other two which are more appropriate for young population, due to its simplicity and safety it is appropriate for elderly population (Dolny & Reyes, 2008; Von Stengel et al., 2011; Pioreschi, Oosthuysse, Avidon, & McVeigh, 2012). Aerobic training significantly effects cardiovascular health and shows certain indications for improving or at least maintaining bone mass (Dalsky et al., 1988; Blumenthal et al., 1991; Nelson, Fisher, Dilmanian, Dallal, & Evans, 1991; Hatori et al., 1993; Martin & Notelovicz, 1993). Therefore, if we want to maintain optimal bone mass throughout life it is recommended to participate in systematic sports training from early childhood and to regularly involve oneself in physical activities, especially those creating greater ground reaction forces and with external loading larger than those of everyday life, on a regular basis over longer periods of time. It is a challenging task to give valid conclusion about optimal loading parameters for specific types of training due to inconsistency in methodological approaches and, often, controversial findings. Hence, future research should focus on: a) determining optimal loading parameters for specific types of training and age groups with a uniform methodology; b) topological effects of specific exercises, especially in strength and jump trainings; c) determining effects of agility training as a potential protocol for developing bone mass in young population; and d) determining residual effects of training focused on gaining bone mass, that is, the effects of detraining.

Keywords: *bone mineral density, osteoporosis, exercise, strength, plyometrics*

References

1. Arab Ameri, E., Dehkhoda, M.R. & Hemayattalab, R. (2012). Bone mineral density changes after physical training and calcium intake in students with attention deficit and hyper activity disorders. *Research in Developmental Disabilities*, 33 (2), 594 - 599.
2. Blumenthal, J.A., Emery, C.F., Madden, D.J., Schniebolk, S., Riddle, M.W., Cobb, F.R., Higginbotham, M., & Coleman, R.E. (1991). Effects of exercise training on bone density in older men and women. *Journal of American Geriatric Society*, 39 (11), 1065-1070.
3. Dalsky, G.P., Stocke, K.S., Ehsani, A.A., Slatopolsky, E., Lee, W.C., & Birge, S.J. Jr. (1988). Weight-bearing exercise training and lumbar bone mineral content in postmenopausal women. *Annals of Internal Medicine*, (6), 824 -828.
4. Dolny, D.G., & Reyes, G.F. (2008). Whole body vibration exercise: training and benefits. *Current Sports Medicine Reports*, 7 (3), 152 - 157.
5. Guadalupe-Grau, A., Fuentes, T., Guerra, B., & Calbet, J.A. (2009). Exercise and bone mass in adults. *Sports Medicine*, 39 (6), 439 - 468.

6. Gomez-Cabello, A., Ara, I., Gonzalez-Aguero, A., Casajusand, J.A., & Vicente-Rodriguez, G. (2012). Effects of training on bone mass in older adults. A systematic review. *Sports Medicine*, 42 (4), 301 - 325.
7. Hatori, M., Hasegawa, A., Adachi, H., Shinozaki, A., Hayashi, R., Okano, H., Mizunuma, H., & Murata, K. (1993). The effects of walking at the anaerobic threshold level on vertebral bone loss in postmenopausal women. *Calcified Tissue International*, 52 (6), 411 - 414.
8. Hemayattalab, R. (2010). Effects of physical training and calcium intake on bone mineral density of students with mental retardation. *Research in Developmental Disabilities*, 31 (3), 784 - 789.
9. Marković, G. & Mikulić, P. (2010). Neuro-musculoskeletal and performance adaptations to lower-extremity plyometric training. *Sports Medicine*, 40 (10), 859 - 895.
10. Martin, D., & Notelovitz, M. (1993). Effects of aerobic training on bone mineral density of postmenopausal women. *Journal of Bone and Mineral Research*, 8 (8), 931 - 936.
11. Nelson, M.E., Fisher, E.C., Dilmanian, F.A., Dallal, G.E., & Evans, W.J. (1991). A 1-y walking program and increased dietary calcium in postmenopausal women: effects on bone. *American Journal of Clinical Nutrition*, 53 (5), 1304 - 1311.
12. Pioreschi, A., Oosthuysen, T., Avidon, I., & McVeigh, J. (2012). Whole body vibration increases hip bone mineral density in road cyclists. *International Journal of Sports Medicine*, 33 (8), 593 - 599.
13. Riggs, B.L. & Melton, L.J. 3rd. (1995). The worldwide problem of osteoporosis: insights afforded by epidemiology. *Bone*, 17 (5 Suppl), 505S - 511S.
14. Vicente-Rodriguez G. (2006). How does exercise affect bone development during growth? *Sports Medicine*, 36 (7), 561 - 569.
15. Vicente-Rodriguez, G., Jimenez-Ramirez, J., Ara, I., Serrano-Sanchez, J.A., Dorado, C., & Calbet, J.A. (2003). Enhanced bone mass and physical fitness in prepubescent footballers. *Bone*, 33 (5), 853 - 859.
16. Von Stengel, S., Kemmler, W., Pintag, R., Beeskow, C., Weineck, J., Lauber, D., Kalender, W.A., & Engelke, K. Power training is more effective than strength training for maintaining bone mineral density in postmenopausal women. *Journal of Applied Physiology*, 99 (1), 181 - 188.

EFFECT OF MOTOR ABILITIES TO RESULT IN SWIMMING 11-YEAR OLD BOYS

Dajana Jašić

Faculty of Kinesiology, University of Zagreb, Croatia

The aim of this research was to determine the influence of motor dimensions on result efficiency in 50 m freestyle swimming discipline in swimmers aged 11 years. The group of 15 motor tests was used on the sample of 150 swimmers. Factor analysis isolated four factors: 1. Arms and trunk repetitive strength regulation mechanism; 2. Coordination and speed integration mechanism; 3. Trunk muscle tone regulation mechanism; 4. Shoulder joint muscle tone regulation mechanism. Regression analysis determined significant interrelation between all the isolated factors and the swimming result, in following order: 1. Arms and trunk repetitive strength regulator; 2. Coordination and speed integration mechanism; 3. Trunk muscle tone regulator; 4. Shoulder joint muscle tone regulator. Regression analysis determined that the group of isolated factors was a good predictor of 50 m freestyle result, with multiple correlation of 0,74 and determination coefficient of 0,55. Regression coefficients indicate the dominant influence of arms and trunk repetitive strength regulator and the coordination and speed integration mechanism on the achieved result, while the influence of muscle tone regulator was significant, but with somewhat lower values.

Key words: *freestyle swimming, factor analysis, result efficiency*

THE IMPACT OF AEROBIC GYMNASTICS PHYSICAL LOADS ON THE 6-11 YEARS GIRLS' PHYSICAL AND FUNCTIONAL STATUS

Egle Kemeryte-Riaubiene, Nijoje Jascaniniene, Sniegina Poteliuniene and Virginija Juodvirse

Lithuanian University of Educational Sciences, Lithuania

Training conditions are very demanding for young athletes, creating in some cases different type of pressures which negatively affect their health. In order to detect potential health problems that can be worsened with daily sports practice of young girls who practicing aerobic gymnastics we analyze the impact of one year aerobic gymnastics training program on the physical and functional development of girls aged 6-11 years. The subject of the research - the girls aged 6-11 who attend Vilnius gymnastics school and belong to aerobic gymnastics teams. Girls were divided into 3 groups by age - 6-7, 8-9, 10-11 years. We evaluated girls' physical development and functional status three times per year: before the competition season, during the competition season and after the recovering period.

We carried out the tests of physical development (height, weight, muscle and fat mass), physical condition (according Eurofit and specialized tests) and tests to determine girls functional status (spirometry, rytmography, Rufje tests).

All groups of aerobic gymnastics team' girls performed the tests of physical condition better comparing to nonsporting girls, especially Flamingo test. Their physical development was the same, except the muscle mass which has a tendency to be higher in sporting girls groups.

Even all the performed tests of physical condition as a flamingo balance (n/1 min.); teping (ms); long jump (cm); sit- lie (n/ 30s); 10 x 5 m running - shuttle(s) were improved in all the sporting girls age groups during the year training cycle, and comparing to the Eurofit scales were better than in the same age groups of nonsporting girls, but the functional tests (especially spirometry) in competition training season in all researched groups has a tendency to be lower comparing the same indices in precompetition and recovering training periods.

We come to the conclusions that anaerobic physical loads, which were dominating in aerobic gymnastics sport during competition training season does not have a positive effect on girls cardiorespiratory system, especially in the youngest group, aged 6-7 years girls.

COMPARISON OF FOUR METHODS FOR DETERMINING THE ANAEROBIC THRESHOLD

Marko Sukreški, Josip Zekić and Tajana Geršić

Center for scientific research, Croatia

Purpose

In previous studies we can find existence of disagreement among researchers concerning the definition, detection and names of anaerobic threshold (ANT). It is an indisputable fact that the ANT is subject of great interest of scientific and professional community. The cause of this is a great practical application of ANT. In practice, the most famous are the three basic, commonly used methods for determining the anaerobic threshold, the method based on the analysis of changes in heart rate, methods based on changes in blood lactate concentration and method based on ventilation parameters. In this paper we will compare four methods: heart rate deflection point (DF), V-slope (VS) method as representatives of ventilatory method, 4mmol (4M) and D-max (DM) as representatives of lactate method.

Methods

The sample consisted of 12 amateur soccer players. Each subjects performed an incremental treadmill test (KF1), strat at 3 km/h and have 0.5 km/h speed increase each 30 seconds, and 7x800 test (L78), start at 8 km/h and have 2km/h speed increase each level. In KF1 test we used the VS based on ventilation parameters, and in L78 we used DM based on blood lactate concentration. The ANOVA and the Bonferoni test was used to determine differences in observed variables.

Results

	VS	DF	4M	DM	F	p
	avg±sd	avg ±sd	avg ±sd	avg ±sd		
	min-max	min-max	min-max	min-max		
V_{anp} (km/h)	13,4±0,9	13,9±1,3	13,2±1,0	14±1,2	1,62	0,19
	11,5-14,5	13-16	12-14	12-14		
V_{max} (km/h)	18,0±0,9	18,0±0,9	19,5±1,2	19,5±1,2	7,27	0
	17-19,5	17-19,5	18-22	18-22		
HR_{anp} (bpm)	177,8±9,1	181,7±5,9	177,4±12,1	182,3±8,2	0,94	0,42
	157-193	168-190	153-191	165-191		
HR_{max} (bpm)	193,8±7,8	193,8±7,8	194,8±7,1	194,8±7,1	0,07	0,97
	175-204	175-204	179-205	179-205		

V_{anp} -intensity at ANT, V_{max} -maximal intensity in test, HR_{anp} -heart rate at ANT, HR_{max} -maximal heart rate

Conclusion

Protocol KF1 is much more accurate and sensitive in assessing the ANT because the degree of speed increase is 0.5 km / h per level, while in the L78 is 2 km/h. For the analysis method we can conclude that all four methods with great credibility estimate ANP. V-slope method can be taken as the most accurate. Authors proposal for future research is to develop mathematical algorithms that accurately determined the specific parameters of the 4M and DM, modification of the L78 protocol: reduce the degree of speed increase and that the level is determined by time, not by distance.



Satellite Symposium

Adaptation of Human Organism to Disuse and Ageing

**7th INTERNATIONAL
SCIENTIFIC
CONFERENCE ON
KINESIOLOGY**

**FUNDAMENTAL
AND APPLIED
KINESIOLOGY – STEPS
FORWARD**

Editors:

**Prof. Rado Pišot, PhD
Uroš Marušič, PhD**

Peer Reviewers:

**Mitja Gerževič, PhD
Uroš Marušič, PhD
Prof. Marco Narici, PhD
Rado Pišot, PhD
Matej Plevnik, PhD
Prof. Boštjan Šimunič, PhD
Dorjana Zerbo Šporin, PhD**



TENSIOMYOGRAPHY – PAST AND FUTURE DIRECTIONS?

Boštjan Šimunič

Institute for Kinesiology Research, Science and Research Centre, University of Primorska, Koper, Slovenia

Abstract

Tensiomyography is a simple to use selective and non-invasive method for detecting skeletal muscle contractile parameters using the linear displacement sensor. It was designed to assess skeletal muscle thickening and low frequency lateral oscillations of active skeletal muscle fibres during twitch contractions and overcomes the limitations of mechanomyographic methods such as: low signal to noise ratio; low reliability; complex measuring setup; the need for complex post-processing. Since its first scientific publication in 1990 more than 30 articles show its use and purpose: in the estimation of muscle composition; for evaluating muscle atrophy; for measuring adaptation to different pathologies; for measuring adaptation to specific training; and for measuring muscle fatigue. Future directions should be multidimensional: further validation especially with muscle force; increasing the research power of established theories; determining the trends of physiological processes and adaptations through longitudinal designs; characterising muscle fatigue, and developing its application in dynamic muscle contractions.

Key word: TMG, skeletal muscle, muscle fibre, mechanomyography

What is tensiomyography?

From 1990, i.e. from the first publication (Valenčič, 1990), presenting the principles of tensiomyography (TMG), more than 30 publications have described its applications in the field of skeletal muscle physiology. In general, TMG was developed at the Faculty of Electrical Engineering of the University of Ljubljana (Slovenia) as a non-invasive, selective and simple-to-use method that allows the assessment of skeletal muscle contractile properties. Furthermore, TMG proved to be a highly reliable method (Šimunič, 2012).

So far, TMG has been applied: (i) to estimate muscle composition (Šimunič, 2011), (ii) to evaluate atrophy related muscle stiffness loss (Pišot et al., 2008); (iii) to measure adaptation to pathologies such as muscle spasticity, peripheral arterial disease, paralytic poliomyelitis, above knee leg amputation, and multiple sclerosis; (iv) to measure adaptation to specific training; and to measure muscle fatigue.

Theoretical background

TMG was designed to assess skeletal muscle thickening and low frequency lateral oscillations of active skeletal muscle fibres during twitch contractions (Figure 1; Valenčič 1990) and by the origin of measured signals it has been listed in the group of mechanomyographic (MMG) methods. Several MMG methods have been developed so far, for instance: in phonomyography or soundmyography or acoustic myography microphones are used to transform muscle fibre mechanical

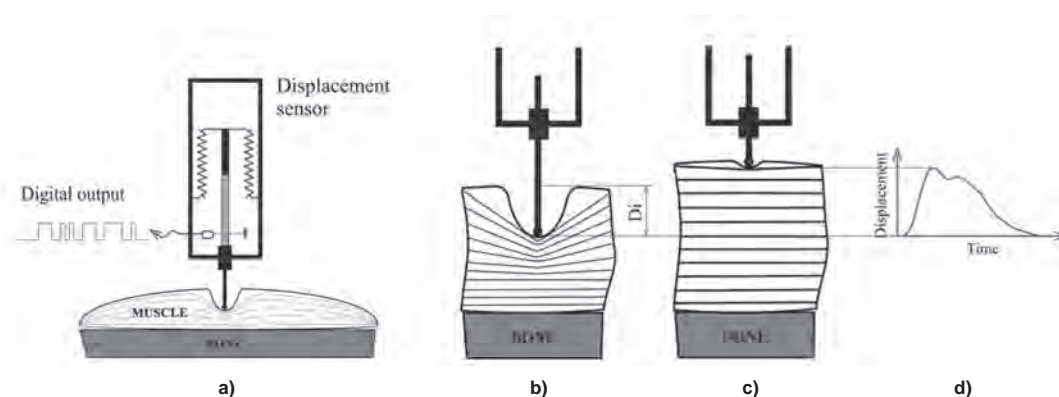

Figure 1: The principles of tensiomyographic measurement: linear displacement sensor (a) is pressed against the resting muscle (b) and during twitch muscle contraction muscle belly thickens and vertically presses the displacement rod (c) to measure a mechanical twitch response (d) (Adopted from previous publication of Šimunič, with permission).

oscillations at its resonance frequency into audible sound, while in vibromyography accelerometers and laser beams are used to detect thickening and vibration of the entire muscle belly. Promising results have been obtained using MMG methods, but there are several difficulties, such as a low signal to noise ratio and consequently high variability, complex measuring setup and/or expensive hardware and necessary post-processing of signals; however, by using the displacement sensor TMG overcomes those limitations.

The constancy of the muscle volume during contraction is one of the most important assumptions that must be met to allow for valid measurements in the transversal plane – thickening of the muscle belly. Interestingly, this was proven already in 1667 by Swammerdam.

Estimation of skeletal muscle composition

Tensiomyographic twitch response reaches peak amplitude approx. 50 ms prior to torque twitch response. This finding confirms that other than just elastic component distinguish both mechanical responses. Mathematically, damping during longitudinal contraction (the source of torque twitch response) must be present to delay torque twitch amplitude more than the TMG twitch amplitude is delayed.

Later on we correlated the TMG-based contraction time to muscle fibre type distribution and a significant correlation was confirmed between contraction time and the percentage of type I fibres ($r = 0.93$). However, the correlation was calculated when comparing biopsy and TMG data sets of seven muscles obtained from different populations (biopsy of cadavers and TMG in healthy males).

A more valid study was introduced by Šimunič et al. (2011) where both data sets were obtained from the same sample of 27 participants. Authors found that not only contraction time (T_c), but also delay time (T_d) and half relaxation time (T_r) could contribute significantly in the estimation of myosin heavy chain (MHC) distribution (Figure 2). A multiple linear regression analysis confirmed a significant correlation ($R = 0.933$) between MHC-I proportion and three TMG response based predictors ($MHC-I [\%] = 2.829 \cdot T_d + 2.980 \cdot T_c + 0.127 T_r - 121.023$), with standard error of approx. 6.08% and within-day, between-day and inter-rater reliability higher than 0.88 (Šimunič, 2012).

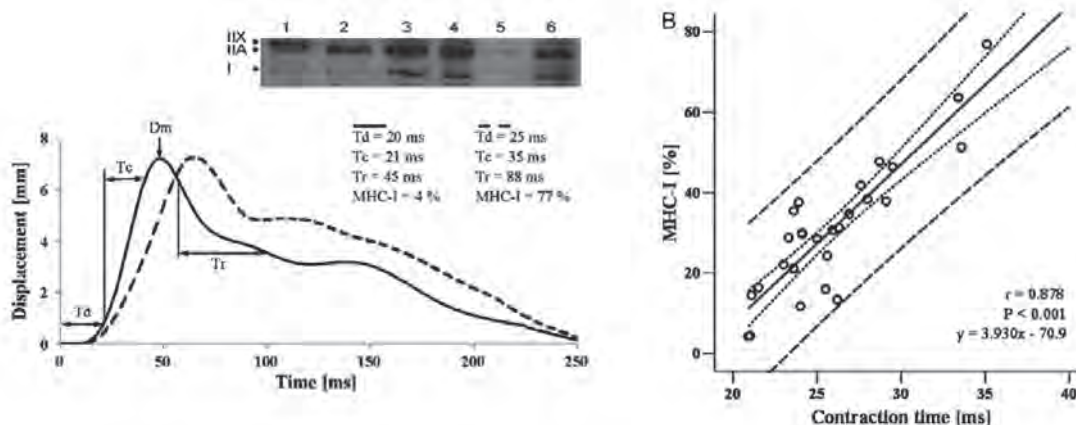

Figure 2: Tensiomyographic twitch responses, with standard contractile parameters defined, of predominantly fast-twitch and slow-twitch vastus lateralis (left) and a Pearson correlation between tensiomyographic contraction time with myosin heavy chain composition type I – MHC-I (Adopted from Šimunič et al., 2011, with permission).

Estimation of muscle tone

The maximal displacement (D_m) as a maximal amplitude (in millimetres) of the TMG twitch response has never been explained in greater detail. However, when Pišot et al. (2008) compared D_m before and after 35-day bed rest, it was evident that after bed rest D_m values for lower limb muscles increased by about 25–30%. Even more, there was a significant negative correlation ($r = -0.70$) between the increase in D_m and the decrease in muscle belly thickness (Pišot et al., 2008) due to bed rest atrophy. This indicated that higher the atrophy (lower muscle thickness or CSA), higher the D_m increase. Furthermore, we measured muscle thickness (using ultrasound) and maximal TMG displacement during 35-day bed rest and found nonlinear relationship between both adaptations. Tensiomyographic amplitude increased very rapidly already after the first day of bed rest and plateau after the 28th day of bed rest. Different results were found in muscle thickness, which decreased after the sixth day of bed rest with the following linear decrease during 35-day bed rest. During the recovery period that followed, similar principles were confirmed: a higher rate in TMG amplitude recovery than in muscle thickness (Figure 3).

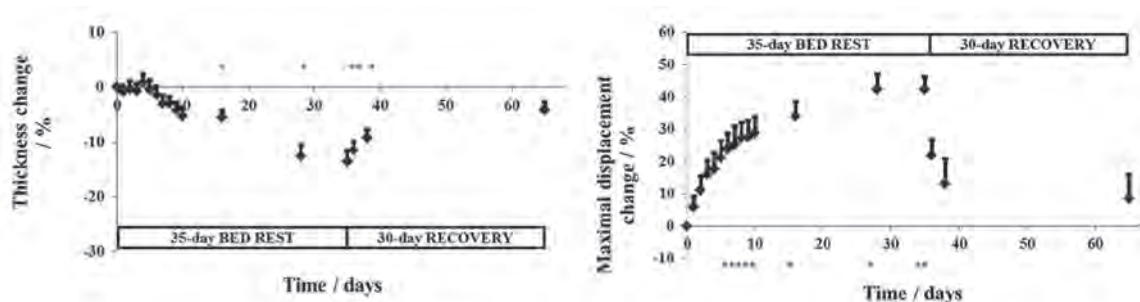

Figure 3: Mean with standard error of vastus lateralis thickness (left) and maximal displacement (right) time-dynamics during 35-day bed rest and after 14-day recovery that followed (Adopted from previous publication of Šimunič, with permission).

To confirm TMG high sensibility to muscle tone, two studies were performed also for spastic muscles, where we found lower amplitudes in spastic muscles, while others in a case study found an amplitude increase after the treatment of spastic muscle with BTX-A.

Future directions

The non-invasiveness and selectiveness with simplicity are three most important advantages of TMG. It was applied in children, athletes and patients and it could give us an opportunity to increase the research power of established findings without major ethical drawbacks.

Three validation studies were performed comparing TMG to muscle composition (Šimunič et al., 2011) but little is known about its relation to muscle force. Only one study confirmed the non-linear relation between tensiomyography and torque peak twitch amplitudes and significant differences in other extracted contractile parameters. However, the mechanisms are not fully explained and it is crucial to clearly show the potential of TMG – to calculate the electromechanical efficiency of a muscle.

Recently, more researches have been performed in studying the central and peripheral fatigue, while in the future; the major concern should be to explain discrepancies found from well-established theories. It seems that TMG could be used for detecting different types of central fatigue and maybe tensiomyography could be applied to distinguish between its central and peripheral part.

Dorđević et al. (2011) pointed out another future direction in the development of tensiomyography. In the newly developed methodology MC (muscle contraction) method they proposed the sensor to assess dynamic muscle contractions. The proposed MC method measures the force on the subject's skin above the skeletal muscle as a result of changed muscle contractile tension. Skeletal muscles are able to produce varying levels of contractile force, which induce different levels of tension in the skeletal muscle (Figure 4). The sensor used in MC method consists of a sensor tip, force meter and the supporting part. The sensor is constructed in such a way that its pressure on the subject's skin causes the sensor tip to compress the skin surface and the intermediate layer, ultimately putting pressure on the measured skeletal muscle.

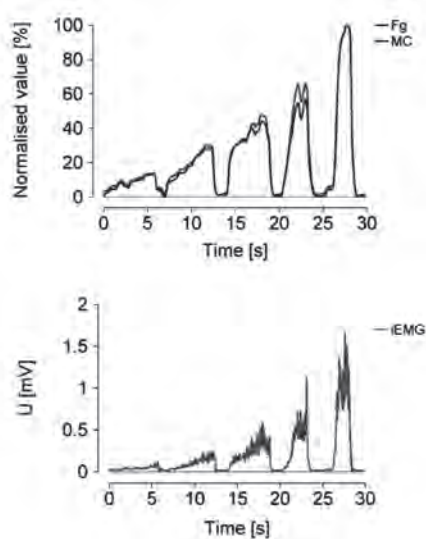

Figure 4: Normalised Force (Fg) and force estimated from MC method and integrated electromyography (iEMG) in five contractions at different intensities (Adopted from Dorđević et al., 2011, with permission).

References

1. Đorđević S, Stančin S, Meglič A, Milutinović V, & Tomažič S. (2011). MC sensor-a novel method for measurement of muscle tension. *Sensors (Basel)*, 11(10), 9411–25.
2. Pišot, R., Narici, M.V., Šimunič, B., De Boer, M., Seynnes, O., Jurdana, M., Biolo, G. & Mekjavić, I.B. (2008). Whole muscle contractile parameters and thickness loss during 35-day bed rest. *European Journal of Applied Physiology* 104(2), 409–14.
3. Šimunič B., Degens H., Rittweger J., Narici M., Mekjavić I.B., & Pišot, R. (2011). Noninvasive estimation of myosin heavy chain composition in human skeletal muscle. *Medicine and Science in Sports and Exercise*, 43(9), 1619–25.
4. Šimunič B. (2012). Between-day reliability of a method for non-invasive estimation of muscle composition. *Journal of Electromyography and Kinesiology*, 22, 527–30.
5. Valenčič V. (1990). Direct measurement of the skeletal muscle tonus. In Popović D., editor. *Advances in external control of human extremities*. Beograd: Nauka, 102–8.

GENDER RELATED DIFFERENCES OF PHYSICAL ACTIVITY AMONG OLDER ADULTS

Saša Pišot and Uroš Marušič

Institute for Kinesiology Research, Science and Research Centre, University of Primorska, Koper, Slovenia

Abstract

The present study of gender related differences of older adults' physical activity (PA) and self-rated health using GPAQ in some parts confirm consistency with previous research in Slovenian older population. A selective sample of healthy older adults showed that all exceed the HEPA active level of PA (>3000 mean MET total), which is opposite to the rate of inactive population of the elderly in Slovenia. The fact that women's physical activity originates mostly from PA at domestic work and walking for the purpose of travel has to be considered more carefully. According to the WHO recommendation domestic work should not present the major part of total activity, but it should include vigorous and moderate PA in leisure time and recreation. In relation to self-rated health as an established indicator of general health status of a population and life satisfaction, data showed us that in the 60-70 years group there is a positive correlation between women's self-assessment of physical exercise capacity and total quantity of PA (MET total ($r = 0.249$, $p < 0.001$, $N = 200$) and self-health care and MET total ($r = 0.175$, $p = 0.012$, $N = 205$). Meanwhile there was also a positive correlation in men between the assessed self-general health status and MET total ($r = 0.250$, $p = 0.010$, $N = 105$) as well as physical exercise capacity and MET total. An active lifestyle (HEPA active) in old age generates better self-esteem regarding physical exercise capacity, general health status and self-health care, and this results on a multidimensional level of its benefits.

Key words: *assessment of physical activity, GPAQ, self-rated health, older women, older men*

Purpose

Nowadays there is no doubt that adequate quality and quantity of physical activity is an essential element of successful ageing. Despite the health benefits of physical activity (American College of Sports Medicine, 1998) the majority of population, not only the older adults, are not active enough to enjoy these benefits.

Recent research of Slovenian population "Health and life-style of inhabitants of Slovenia - trends from CINDI" showed us that in 2008, 61.6% of interviewees achieve World Health Organisation guidelines on physical activity – if the whole physical activity is taken into account where physical activity at the workplace encompassed 57.0%. Only 21.7% of them achieve the recommendations by leisure time physical activity alone what reflects that the majority of PA is performed at vigorous and moderate intensity at the workplace, or at home as housework and gardening. Such physical activity could satisfy the guidelines, only if it does not have a harmful effect on health due to high loads or repetitive movements. Positively, the percentage of regular recreational physical activity increased significantly during the period from 2004 to 2008, but the percentage remained higher in men's PA. According to the majority of research, women are considered to be less active than men as well as those who are less educated and have a lower social status.

In the Report on nutrition and health enhancing physical activity of the elderly (National Institute for Public Health, 2011) stated that even though regular and sufficient exercise is key to preserving a healthy, high-quality and especially independent life of the elderly, recent research in Slovenia shows that almost two fifths of those over 65 years old are not active. Especially those who were not frequently active in the previous life, stop playing sports or exercising as they get older. On the other hand, those who were regularly active remain faithful to their lifestyle in their old age. Today's drop in sports activity moved after 65 years of age where the elderly in the mentioned study prefer walking, followed by sports that do not cost much, take little time and are available to a wide range of people. In the research (Pori M. et al., 2009) conducted on a sample of 1,313 older adults (+65 years) from six Slovenian regions showed that 59% of them are not active at all, 9% were active 1 hour/week and 10% 2 hours/week, yet 4% 3 hours/week. Among those who were active, only 18% exercised in organised activities. Nevertheless, that data showed us the evidence base of PA of older adults in Slovenia, but there is no clear evidence of gender and age related differences in PA of older adults. In this study total physical activity of the older adults population of 55–64 years declined from 52% in 2004 to 49% in 2008, with a slight increase, from 12.5% to 13.8 %, on the recreational level (PA in leisure time) but as we have already mentioned, there is no data about gender and age related differences although it has been reported that women in general are involved in more organised forms of PA (especially from 25 to 39 years of age).

According to the presented fact our research interest was oriented also in the context of relation of Self-rated health and the amount of PA in older adults population. Self-rated health is an established indicator of general health status of a population and life satisfaction. Data from the Health Monitoring Surveys 2001–2004–2008 showed that more than one half of the interviewees estimated their health as good or very good (2001: 52.6%; 2004: 54.3%; 2008: 58.1%), whilst less than one tenth of them evaluated it as bad or very bad (2001: 9.1%; 2004: 9.2%; 2008: 8%). There has been a significant overall improvement of self-rated health in the observed period. Men, younger adults with higher education level, members of the upper social class, urban residents and inhabitants of western and central Slovenia tend to rate their health better than the other groups what is consistent with other western world's studies.

Those presented facts which encompassed data for the Slovenian population in general provided additional unanswered questions in the research of PA of older adults in Slovenia. With that purpose we used the data gathered in the frame of the PANGeA Project – Physical activity and nutrition for great ageing, using the GPAQ (General Physical Activity Questionnaire, WHO) as a part of the PANGeA questionnaire. Our goal was to analyse the quantity of PA as well as the relationship of PA and self-assessment of general health status, physical condition, psychological well-being and general quality of life of the population of older adults (60–80 years of age). The Global Physical Activity Questionnaire (GPAQ), was developed by the WHO for physical activity surveillance in countries with the purpose to collect information on PA participation in three domains as well as sedentary behaviour; activity at work/domestic activity, travel to and from places (active transport) and recreational sports activities. To assess self-rated health and general well-being Likert scale from 1 – poor to 5 – excellent was used. Subjects were asked to estimate four domains: a) general health status, b) physical condition, c) psychological well-being, d) general quality of life and e) how much do they care for their health (1 – do not care at all; 2 – very little, too little; 3 – quite good; 4 – very good; 9 – don't know).

Methods

The data were collected with a survey questionnaire in the frame of mass measurement – the activity undertaken within the standard PANGeA project: Physical activity and nutrition for great ageing which was co-financed by the Cross-border Cooperation Programme Slovenia – Italy 2007–2013.

Questionnaires (paper form) were sent to the older adult population; to each one who expressed the interest to participate in the mass measurement and signed the consent. The criteria to enter the mass measurements were: age limit (60 to 80 years of age), health status in a way that s/he is able to walk 2 km without support, and completing and submitting the PANGeA Questionnaire. The questionnaire was divided in several different parts to cover general health status, well-being and lifestyle (PA, nutrition and habits) of older adult population.

Among all answers that we had received, we were able to measure 445 subjects [women N = 284 (64%), age 66.9 ± 5.1 years, BMI = 27.0 ± 4.6 kg/m²), men N = 161 (36%), age 68.4 ± 5.6 years, BMI = 27.7 ± 3.3 kg/m²], from three Slovenian towns: Koper, Ljubljana and Kranj.

Aware of the obstacles and limits of understanding the questionnaire by older adults (especially the segment of physical activity – GPAQ) we checked the answers together with the participants and filled in the gaps at the end of the measurement day, so we avoided any misunderstandings and irrelevant answers. We were able to check over 90% of questionnaires.

Data from the GPAQ in general as well as specific domains were transferred to METs (Metabolic Equivalent), which are commonly used in the analysis of physical activity and represent the ratio of the work metabolic rate to the resting metabolic rate. One MET is defined as 1 kcal/kg/hour and is equivalent to the energy cost of sitting quietly. A MET is also defined as oxygen uptake in ml/kg/min with one MET equal to the oxygen cost of sitting quietly, around 3.5 ml/kg/min (WHO, GPAQ).

IBM SPSS Statistics 19.0 software (SPSS, Inc., Chicago, Ill, USA) was used for descriptive statistics and Spearman's bivariate correlation coefficient analysis of Self related Health and PA. Statistical significance was set at the level of $p < .05$.

To assess physical activity MET (WHO, GPAQ, IPAQ) scores were calculated separately for individual domains and sub-domains: vigorous and moderate activity at work/domestic work, walking and vigorous and moderate PA in sports. For the calculation of a categorical indicator, the total time spent for physical activity during a typical week, the number of days as well as the intensity of physical activity is taken into account. The following MET values were used:

- Walking MET-minutes/week = $3.3 * \text{walking minutes} * \text{walking days}$
- Moderate MET-minutes/week = $4.0 * \text{moderate-intensity activity minutes} * \text{moderate days}$
- Vigorous MET-minutes/week = $8.0 * \text{vigorous-intensity activity minutes} * \text{vigorous-intensity days}$
- Total physical activity MET-minutes/week = sum of Walking + Moderate + Vigorous MET minutes/ week scores.

In the further analyses we used the three levels of physical activity suggested for classifying (IPAQ)

1. *Inactive*. This is the lowest level of physical activity. Those individuals who do not meet the criteria are considered as insufficiently active, (<600 MET-min/week).
2. *Minimally active*. The minimum pattern of activity to be classified as sufficiently active is any one of the following criteria, (600–3000MET-min/week): 3 or more days of vigorous activity of at least 20 minutes per day or 5 or more days of moderate-intensity activity or walking of at least 30 minutes per day or 5 or more days of any combination of walking, moderate-intensity or vigorous intensity activities achieving a minimum of at least 600 MET-min/week, Individuals meeting at least one of the above criteria are to be considered as minimally active.
3. *HEPA active* (health enhancing physical activity; a high active category). HEPA active care people who exceed the minimum public health physical activity recommendations, and are accumulating enough activity for a healthy lifestyle. The criteria of HEPA active are: vigorous-intensity activity for at least 3 days achieving the minimum of 1500 MET-minutes/week or 7 days of any combination of walking, moderate-intensity or vigorous intensity activities or achieving a minimum of at least 3000 MET-minutes/week, (> 3000 MET-min/week, 1.5–2 hours of total activity per day).

Results

Data presented in Table 1 and Graph 1 are in general accordance with our hypothesis that the population to be measured are supposed to be healthy, in general they all exceed the limit of > 3000 mean MET/minutes/week (women = 4412.03 MET \pm 3414.74; men = 5268.78 MET \pm 4242.76), what classified them as HEPA active population (IPAQ). Both populations are showing big standard deviations, reflecting individual differences in the quantity of PA. These optimistic results probably reflect the healthy and active way of life of participants which was also the criteria to participate in the mass measurement and it is an interesting point for further analysing other determinants of active life of older adults, i. e. their living standards, possibilities for active LS (gardening, sports facilities etc.). At in-depth analyses of gender differences women did not achieve the recommended vigorous and mediate PA in MET for HEPA active standards (> 1500 mean MET) but they achieved standards in total MET in favour of reported activity at domestic work.

Table 1: Gender differences in mean PA – METs (metabolic equivalent) in older adult population

	MET vigorous at work	MET moderate at work	METwalking	MET vigorous PA	MET moderate PA	Total MET
Women						
mean	84.26	2080.98	818.96	148.79	1279.04	4412.03
SD	1015.03	2388.24	897.38	604.12	1186.36	3414.74
Men						
mean	323.97	2304.47	624.95	468.32	1547.06	5268.78
SD	1707.81	2938.21	784.89	1340.92	1307.14	4242.76

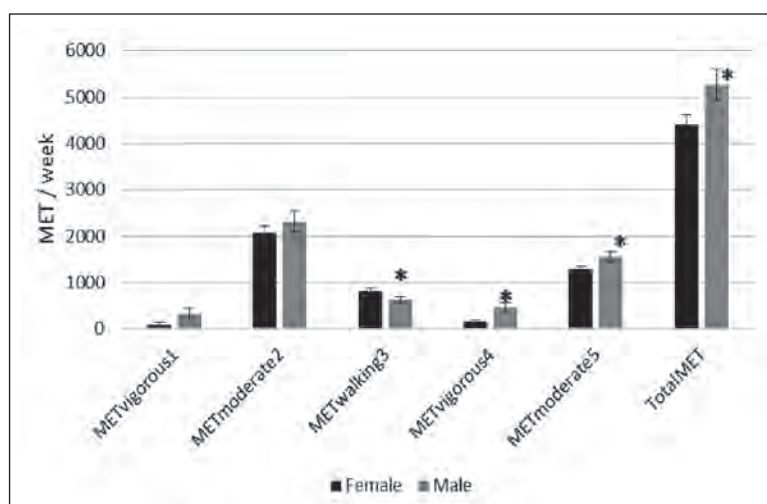

Note: * Statistically significant differences between two groups ($p < .05$).

Graph 1: Gender differences in PA in MET by sub-domains.

Additional analyses (Graph 1) showed some gender differences in mean MET of walking (active transport) where women walk more for the purpose of transport, and in mean MET of vigorous and moderate PA activity where men do more sports activity also in Total MET than women, what is consistent with data in Table 1 and previous studies of NIPH (2008).

Furthermore, we split both groups (men and women) in two age groups to see the correlation between the PA and self-related health (60–70 years of age and 71–80 years of age). A positive correlation between women's self-assessed physical exercise capacity (score assessment from 1 – poor to 5 – excellent) and total quantity of PA calculated in MET ($r = 0.249$, $p < 0.001$, $N = 200$) and on the other hand, self-health care and MET total ($r = 0.175$, $p = 0.012$, $N = 205$) mean that women who are more active assessed their physical exercise capacity better as well as they care for their health more than those who are not that active. A positive correlation was also found in male older adults (group of 60–70 years of age) between the assessed general health status and MET total ($r = 0.250$, $p = 0.010$, $N = 105$) as well as physical exercise capacity and MET total ($r = 0.282$, $p = 0.004$, $N = 105$) that showed that active men estimated their general health status and as well physical condition better than those that are less active. In population of old adults (71–80 years of age, women $N = 76$; men $N = 55$) we found no statistically relevant correlation.

Conclusions

Active ageing is a process that continually encourages and increases the chances for health and the quality of life in old age. The study confirmed that older adults who declared themselves as healthy achieved recommended amount of PA (> 3000 mean MET total), so HEPA active older adults can be a useful indicator of general health status and life satisfaction of older population. Gender differences in sub-domains of women's PA (vigorous and moderate PA in leisure time) asset us a challenge to improve the participation of older women in PA by offering programmes tailored to their needs.

We would like to thank the participants of mass measurements, research teams of all partners, the head of the project Prof. Rado Pišot and the students of Applied Kinesiology at the University of Primorska for their contributions for the success of PANGeA activities.

References

1. American College of Sports Medicine. Exercise and physical activity for older adults. *Med Sci Sports Exerc* 1998; 30:992–1008. [PubMed: 9624662]
2. Health and life-style of inhabitants of Slovenia - trends from CINDI. Retrieved from: http://www.ivz.si/Mp.aspx/?ni=0&pi=7&_7_Filename=attName.png&_7_MediaId=6321&_7_AutoResize=false&pl=0-.
3. Inštitut za varovanje zdravja Republike Slovenije (2011) Prehrana in telesna dejavnost za zdravje pri starejših - pregled stanja. (Nutrition and health enhancing physical activity of elderly – state of the field). On-line report. Retrieved form: http://www.ivz.si/telesna_dejavnost?pi=5&_5_Filename=attName.png&_5_MediaId=4940&_5_AutoResize=false&pl=9-5.3.
4. IPAQ. Available at: http://www.institutferran.org/documentos/Scoring_short_ipaq_april04.pdf
5. Pori M, Pori P, Sila, B. (2010). Ali starost vpliva na izbor najbolj priljubljenih športno rekreativnih
6. dejavnosti? Šport – revija za teoretična in praktična vprašanja športa 1-2-; priloga:112-114.
7. WHO, GPAQ Analysis guide. Global Physical Activity Questionnaire (GPAQ). Analysis guide. available at: http://www.who.int/chp/steps/resources/GPAQ_Analysis_Guide.pdf and <http://www.who.int/chp/steps/GPAQ%20Instrument%20and%20Analysis%20Guide%20v2.pdf>

COMPARISON OF WALK FORCE CHARACTERISTICS OF CZECH ADULT WOMEN

Dušan Hupka

Faculty of Sport Studies, Masaryk University, Brno, Czech Republic

Abstract

In this study we compared, intra and inter group, force differences in four age groups of healthy adult Czech women. Subjects were according to their age divided into four groups, A= 18 – 30 years, B= 31 – 45 years, C= 46 – 60 years and D= 60+ years. Data were collected in laboratory conditions on Bertec force plates as a display of ground reaction force vector. Each subject performed 5 attempts of normal walk. Followed forces were maximal force characteristics F_1, F_2, F_3 (N) and average force characteristics F_m, F_{m1}, F_{m2} (N) as well as their recalculation into percentage of body weight. No statistically significant differences were found between groups, or in each specific group.

Key words: foot, step, absorption stage, propulsive stage, women, age

Introduction

Walking as a basic and most natural forma of human locomotion is performed every day (Zvonař, 2011). Walking and it's manifestation is highly individual activity determined by age, sex body build, temperament, fatigue and many others factors (Hughes, Jacobs, 1979). With increasing age and changing of body composition some postural and walking strategy changes could develop. Majority of them could inhibit further mobility and so involve serious threat to individual's quality of life (Bennett, Duplock, 1993). Locomotion is movement of human body often described as a combination of motion and force effect between surface and feet, (Hughes, Jacobs, 1979). Each individual's force characteristics of step are evolving with age not only in children (Müller et al., 2011), but also in adult age (Korvas et al., 2012).

Methods

For this study were recruited 115 healthy female subjects. Average age of whole group was 45,1 years, average weight 67 kg, average height 166, 4 cm and average Body Mass Index (BMI) was 24,2. Subjects were divided according to their age to four groups. Group A consists 31 women in age from 18 to 30 years, group B, 50 women in age 31 – 45 years, group C of 20 women in age 46 – 60 years and group D of 14 women in age 60 + years. Mean values and standard deviation for basic anthropometric characteristics shows table 1.

Table 1: Mean values of basic anthropometric characteristics for each age group

Group	n	Age (yrs.)		Weight (kg)		Height (cm)		BMI	
		M	SD	M	SD	M	SD	M	SD
A	31	25,0	3,9	62,3	7,1	167,5	5,7	22,3	2,3
B	50	37,2	4,1	65,4	10,6	167,9	5,5	23,2	3,4
C	20	52,0	4,7	68,2	13,6	165,8	6,1	24,6	4,1
D	14	66,1	4,3	72,2	13,4	164,5	6,1	26,6	4,4

All measurements were performed in laboratory conditions to avoid discomfort factors of surround and angle or inequality of ground surface. Each subject accomplished 5 repetitions of natural walk, where measured track consisted of at least 3 full steps. For collecting force data we used effect of body weight during walking identified by the ground reaction force vector (GRFV) (Perry, 2010). Collected data on four serial Bertec force plates, with collecting speed 1000Hz and accuracy ± 5 N, are forces created as a response of floor in opposite direction magnitude equal to body weight force.

The measured force parameters were:

F_1 – maximal vertical ground reaction force peak during absorption stage (loading response, LR),

F_2 – lowest force during decline between both peaks (F_1, F_3)

F_3 – maximal vertical ground reaction force peak during propulsive stage (terminal stance, TSt)

F_m – average vertical force of whole stance

F_{m1} – average vertical force in absorption stage (loading response, LR),

F_{m2} – average vertical force in propulsive stage (terminal stance, TSt)

(according to Ayyappa., 1997)

All force characteristics ($F_1, F_2, F_3, F_m, F_{m1}, F_{m2}$) were also recalculated in percentage of body weight (according to Došla et al., 2012). Acquired data were compared intra and inter group in software Statistica using Scheffe Test, with level of statistically significant differences at $p = 0,05$. The intra and inter group comparison of force characteristics were evaluated for each foot individually, as well as for both feet together.

Results

Values of force characteristics of left foot

According to increasing age of our testing group, also numerical grown of mean value of maximal force characteristics F_1, F_2, F_3 (N) can be observed in table 2, same as decreasing tendencies of relative forces characteristics F_1, F_2, F_3 (%BW). Those differences could be evocated by higher weight values in higher age, but they are not statistically significant ($p < 0,05$) yet. Again not statistically significant ($p < 0,05$), but apparent are higher mean values of F_3 force characteristics in group than mean values of F_1 force characteristics (Table 2).

Table 2: Mean values of force maximal characteristics F_1, F_2, F_3 of left foot and their recalculations in percentage of body weight (%BW)

Group	n	F_1 (N)		F_2 (N)		F_3 (N)		F_1 (%BW)		F_2 (%BW)		F_3 (%BW)	
		M	SD	M	SD	M	SD	M	SD	M	SD	M	SD
A	31	669,3	88,4	435,3	77,3	729,4	99,9	109,5	10,1	70,7	10,4	119,6	12,4
B	50	689,9	115,1	446,9	89,6	743,3	115,6	107,9	11,8	69,6	8,8	115,9	9,3
C	20	710,2	161,3	482,5	106,8	769,9	162,8	106,5	13,1	73,9	10,7	115,6	12,0
D	14	714,4	172,9	492,8	161,8	773,4	141,6	101,3	18,4	68,5	13,5	109,7	8,9

Table 3: Mean values of force average characteristics F_m, F_{m1}, F_{m2} of left foot and their recalculations in percentage of body weight (%BW)

Group	n	F_m (N)		F_{m1} (N)		F_{m2} (N)		F_m (%BW)		F_{m1} (%BW)		F_{m2} (%BW)	
		M	SD	M	SD	M	SD	M	SD	M	SD	M	SD
A	31	546,1	81,7	490,9	69,1	500,8	69,6	89,6	9,4	80,2	8,1	82,2	9,7
B	50	540,4	92,4	513,0	80,8	521,6	85,7	84,4	9,4	80,1	7,0	81,3	6,9
C	20	553,6	110,1	528,9	112,3	543,8	104,5	83,8	10,4	79,8	9,2	81,7	8,6
D	14	575,0	167,1	512,9	114,7	538,9	85,4	80,5	10,0	72,5	8,8	76,6	5,4

The characteristics of average forces F_m, F_{m1}, F_{m2} (N) in table 3 also shows increase of values according to growing of age, although those were not statistically significant ($p < 0,05$). Mean values of F_m force characteristics are for each age group higher than values of forces F_{m1} or F_{m2} . At the same time mean values of forces F_{m1} did not reach amount of force F_{m2} for the same group. All of these detected differences were not statistically significant ($p < 0,05$). Similar results has comes up for average force characteristics recalculated in percentage of body weight F_m, F_{m1}, F_{m2} (%BW), where mean value of F_m forces for each group are numerically, without statistical significance ($p < 0,05$), higher than mean values of F_{m1} or F_{m2} forces in the same age group, as well as mean values of forces F_{m2} are numerically higher than values of F_{m1} forces.

Values of force characteristics of right foot

The data in table 4 are picturing similar results for right foot as they were for left foot. Maximal force characteristics F_1, F_2, F_3 (N) are increasing according to age. Mean values of F_3 forces are higher than mean values of F_1 forces for each age group, but all those differences were not statistically significant ($p < 0,05$). Differences in values of relative forces characteristics F_1, F_2, F_3 (%BW), even if no statistically significant ($p < 0,05$), has decreasing tendencies according to age, and also higher values of relative force F_3 than F_1 in same group can be seen. For right foot were detected numerical higher values of relative parameters F_1 and F_3 (%BW) in youngest group and lowest values in oldest group, in propulsive stage of step, however with no statistical significance ($p < 0,05$).

Table 4: Mean values of force maximal characteristics F_1, F_2, F_3 of right foot and their recalculations in percentage of body weight (%BW)

Group	N	F_1 (N)		F_2 (N)		F_3 (N)		F_1 (%BW)		F_2 (%BW)		F_3 (%BW)	
		M	SD	M	SD	M	SD	M	SD	M	SD	M	SD
A	31	666,9	77,7	431,3	76,1	702,9	150,6	109,4	10,6	70,1	1,0	114,9	22,1
B	50	688,1	120,5	451,0	100,5	735,1	121,6	107,4	12,5	69,7	9,8	114,4	9,9
C	20	698,0	145,9	482,9	116,8	754,3	167,0	104,9	13,7	73,8	11,5	113,4	12,7
D	14	719,9	136,9	490,3	176,1	797,5	205,5	102,6	15,3	67,9	14,8	112,3	13,2

Table 5: Mean values of force average characteristics F_m, F_{m1}, F_{m2} of right foot and their recalculations in percentage of body weight (%BW)

Group	N	F_m (N)		F_{m1} (N)		F_{m2} (N)		F_m (%BW)		F_{m1} (%BW)		F_{m2} (%BW)	
		M	SD	M	SD	M	SD	M	SD	M	SD	M	SD
A	31	544,5	83,4	487,4	58,3	501,4	64,1	89,4	10,5	80,1	9,0	82,3	8,0
B	50	539,1	98,3	514,7	82,3	517,5	93,7	84,0	9,3	80,2	6,5	80,4	7,7
C	20	540,9	161,0	531,8	105,8	537,2	115,4	80,0	19,1	80,5	8,9	80,8	9,4
D	14	591,2	182,2	517,2	85,5	548,2	110,4	82,7	11,6	73,9	9,7	77,6	6,7

According to increasing age were right foot average force characteristics F_m, F_{m1}, F_{m2} (N) rising as well, and right foot relative force characteristics F_m, F_{m1}, F_{m2} (%BW) were lowering, table 5, with any statistical significance ($p < 0,05$) between groups. Mean values of F_m (N) forces were in each group numerically higher than mean values of F_{m1} or F_{m2} (N) forces, as well as lower values of F_{m1} (N) than F_{m2} (N) forces. All with no statistical significance ($p < 0,05$). Statistical significance ($p < 0,05$) was also not found in differences between higher mean values of F_{m2} (%BW) and F_{m1} (%BW) in same group.

Values of force characteristics of both feet

According to similar results for left and right foot individually, results for both feet together are corresponding with previous. Increasing of maximal forces F_1, F_2, F_3 (N) according to age, was present for both feet, table 6, but with any statistical significance on level $p = 0,05$. Mean values of relative force characteristics F_1, F_2, F_3 (%BW) for both feet are no more lowering according to age.

Table 6: Mean values of force maximal characteristics F_1, F_2, F_3 of both feet and their recalculations in percentage of body weight (%BW)

Group a	N	F_1 (N)		F_2 (N)		F_3 (N)		F_1 (%BW)		F_2 (%BW)		F_3 (%BW)	
		M	SD	M	SD	M	SD	M	SD	M	SD	M	SD
A	31	668,1	79,2	433,3	75,6	716,1	112,9	105,9	21,8	68,2	16,0	113,4	25,4
B	50	689,0	115,6	448,9	93,0	739,2	117,3	105,5	19,0	68,3	13,3	110,9	18,7
C	20	704,1	150,0	482,6	111,5	762,1	163,8	95,2	34,7	66,4	25,0	103,1	37,1
D	14	717,1	153,7	491,5	167,6	785,5	172,7	102,0	16,5	68,2	13,9	111,0	10,5

Table 7: Mean values of force average characteristics F_m , F_{m1} , F_{m2} of both feet and their recalculations in percentage of body weight (%BW)

Group	N	F_m (N)		F_{m1}		F_{m2}		F_m (%BW)		F_{m1} (%BW)		F_{m2} (%BW)	
		M	SD	M	SD	M	SD	M	SD	M	SD	M	SD
A	31	545,3	81,9	489,2	60,6	501,1	64,8	86,6	18,7	77,6	16,4	79,6	17,0
B	50	539,8	94,7	513,9	80,4	519,5	88,1	82,5	15,0	78,6	13,0	79,2	13,3
C	20	547,3	127,2	530,4	107,5	540,5	108,9	73,7	27,2	72,1	26,0	73,1	26,3
D	14	583,1	174,3	515,1	95,2	543,5	96,1	81,6	10,7	73,2	8,4	77,1	5,5

Similar results, table 7, for average forces F_m , F_{m1} , F_{m2} (N) characteristics, left and right foot individually, are reflected in results for both feet together. Mean values of F_m force characteristics are for each age group higher than values of forces F_{m1} or F_{m2} , but not statistically significant ($p < 0,05$), as well as not statistically significant higher mean values of F_{m2} forces, than mean values of F_{m1} forces for each group. Inter group differences between relative force F_m , F_{m1} , F_{m2} (%BW) mean values has no tendencies according to age, and numerical aberrancies were small with no statistical significance ($p < 0,05$).

Discussion

Acquired results of force characteristics in research group shows similar results for left and right foot as well as for each foot individually and both feet together. All vertical force characteristics had similar tendencies of increase according to growing age, however after recalculation into the percentage of body weight this appears to be decreasing with age growth. Distribution of forces in each group shows higher mean values in every F_3 force characteristics than in F_1 force characteristics (maximal and relative). In average force characteristics, average vertical force in propulsive stage (F_{m2}) has reached higher values than average vertical force in absorption stage (F_{m1}).

By using Scheffé Test on level of $p = 0,05$ there wasn't found any intra or inter group statistically significant differences in research group of healthy adult women, so age as a single factor has no considerable effect on changes in vertical force distribution in female Czech population.

Conclusions

Maximal force characteristics of Czech adult women were numerically growing in measured parameters according to age for left foot, right foot and both feet together but it's relative values recalculated in percentage of body weight shows opposite trend, when they were decreasing with age. Anyway each of those changes and differences between age groups were not found as statistically significant in Scheffé Test on level of $p = 0,05$ for left foot or right foot individually, nor for both feet together.

References

1. Ayyappa E. Normal Human Locomotion, Part 1: Basic Concepts and Terminology, Source: *Journal of Prosthetics and Orthotics* 1997; Vol 9, Num 1, p 10 URL:http://www.oandp.org/jpo/library/1997_01_010.asp
2. Bennett P. J., Duplockl. R. Pressure Distribution Beneath the Human Foot. *Journal of American Pediatric Medical Association*. Vol. 83, Number 12, dec. 1993.
3. Hughes J., Jacobs N. Normal human locomotion. *Prosthetics and Orthotics International*, 1979, 3, 4-12.
4. Korvas P., Musil R., Dosla J., Cacek J. Cross-sectional comparison of selected gait characteristics of women of different ages. *European Association for Sport Management*; 2012.
5. Muller S., Carlsohn A., Muller J., Baur H., Mayer F. Static and dynamic foot characteristics in children aged 1-13 years: A cross-sectional study. *Gait & Posture*, 2011; 35(3):389-94
6. Perry J., Burnfield J.m., Gait analysis: normal and pathological function. 2010.
7. Zvonař, M., Duvač, I. a kol.: Antropomotorika pro magisterský program tělesná výchova a sport. Masarykova univerzita, Brno, 2011.

EFFECTIVENESS AND TRANSFER OF COMPUTERIZED COGNITIVE TRAINING ON COGNITIVE AND PSYCHOMOTOR FUNCTIONS IN OLDER ADULTS DURING PROLONGED INACTIVITY

Uroš Marušič

Institute for Kinesiology Research, Science and Research Centre, University of Primorska, Koper, Slovenia

Abstract

The effects of reduced physical activity or increased physical inactivity on the human body, in particular on cognition and psychomotor functions are less known and less thoroughly investigated than the effects of physical activity on human health and general well-being. Bed rest studies were recognized as a valid model for simulating and studying an acute stage of human adaptation to the microgravity in space flights, the impact of long-term postoperative immobilization and sedentary lifestyle. We tested the hypothesis whether CCT could be an intervention of choice to prevent the negative effects of bed rest not just on cognitive, but also on psychomotor functions of human body. To the best of our knowledge, this was the first bed rest study with a computerized cognitive training (CCT) intervention. The results showed that after a 14-day bed rest and 12 sessions of CCT, the participants in the Intervention group significantly improved their performance in the virtual maze ($p = .076$, $\eta^2 = 0.239$) with some additional transfer on the subtest ($p = .040$, $\eta^2 = 0.67$), which measured attention and psychomotor speed. Moreover, our intervention was also found to be an effective tool for preventing the negative effects of bed rest on the psychomotor level of the human body. Participants in the Intervention group significantly reduced dual-task costs ($p = .008$, $\eta^2 = 0.313$) during their gait performance at the end of the bed rest. The results from our study suggest a possible link between CCT and psychomotor output and open a new perspective on basic research on developing new methods for preventing the detrimental effects of prolonged inactivity.

Key words: *Spatial navigation training, Bed rest, Gait parameters, Dual-task cost, cognitive function*

Introduction

Prolonged inactivity due to immobilization (i.e., a protracted stay in bed) following disease or injuries, in addition to long-term human exposure to microgravity (e.g., spaceflight), may have detrimental effects on several sub-systems of the human body, including cardio-vascular, skeletal or muscular systems (Pavy-Le Traon, Heer, Narici, Rittweger, & Vernikos, 2007), with additional evidence of potential deficits in sensory-motor functioning and cognition (Lipnicki & Gunga, 2009). Hospitalizations lasting longer than 8 days are associated with significant changes in body composition, aerobic capacity and lower extremity strength and power in older persons. The development of new and effective approaches for mitigating or preventing the detrimental effects of prolonged inactivity is thus critical to both healthcare cost containment and to improving the quality of life. In this study, a computerized cognitive training (CCT) approach with spatial navigation was proposed as a potentially useful tool for this purpose.

Cognitive training aimed at optimizing cognitive functioning and/or slowing brain aging has been extensively used, especially with healthy elderly subjects. A variety of tasks and approaches have been used for CCT, and most of the reviewed studies reported significant improvements in performance across the specific cognitive functions trained (e.g., Ball et al., 2002). Verghese et al. (2010) have demonstrated that CCT can even lead to improved mobility performance in sedentary seniors. They suggest that CCT targeting attention and executive functions may result in improved cognitive functioning and more efficient walking patterns due to a close link between these areas of cognition and mobility control.

The purpose of the present study was to investigate the effects of 14 days of CCT on subsequent cognitive function and a far transfer to sensorimotor functions. To completely control for possible confounding factors related to changes in nutrition and physical or cognitive activity, the study was conducted in individuals undergoing 14 days of bed rest in a highly controlled environment.

Methods

The 14-day bed rest was a controlled interventional study. To achieve the aim of the study and to simulate physical inactivity (microgravity conditions), the participants had to rest in bed for 14 days. During the bed rest, the participants were only allowed to turn on all sides of the body or put no more than two pillows under the head and were not allowed to stand up, sit on the bed, or raise their arms above the level of their head.

Participants. Sixteen healthy older men aged 53–65 years (59.6 ± 3.4 years, height 174.5 ± 4.8 cm, body mass 79.6 ± 13.0 kg) were recruited through community advertisements. Eight were randomly selected for the CCT (Intervention group), while the other eight served as controls (Control group). In separate rooms, the Interventional group performed cognitive training, while the Control group watched documentaries for 50 minutes. All participants were right-handed, had normal or corrected-to-normal vision, and reported no history of cardiovascular, neurological, or psychiatric conditions. All procedures were carried out in accordance with the Declaration of Helsinki and were approved by the National Medical Ethics Committee. Written informed consent was obtained from all participants prior to the study.

Computerized cognitive training. From the 2nd to the 13th day of the BR, the Intervention group performed 50 minutes of CCT spatial navigation training each day. During the periods of training, all the participants were lying in bed and moved through the virtual environment using a Trust Predator Joystick GM-2550. The tasks were presented on a 17-inch flat panel LCD monitor situated at a distance of approximately 60 centimeters in front of each participant. The training program consisted of virtual mazes representing a series of interconnected corridors, with three available paths at each intersection or decision-making point. For each maze, either a pair of verbal or pictorial cues were displayed at each decision-making point, placed at either opposite corner of the intersection and in corridors at various non-decision-making points. Verbal cues consisted of signs with country names, city names, and animal names. Pictorial cues consisted of country flags, animal pictures, and human faces. After being familiarized with the joystick and navigation in the virtual maze environment, participants were instructed to select the correct path as quickly and efficiently as possible in order to move toward the goal area. The training was performed using several virtual maze environments, each of increasing difficulty, designed using a modified version of Unreal Tournament 2003 and the Unreal Editor 3.0 (Epic Games, Inc.) software package.

CogState assessment battery. CogState is a computerized battery, comprised of tasks covering several cognitive domains: information processing, attention, working memory, episodic memory, memory for spatial location and executive ability. The following subtests were administered: Detection (DET), a simple reaction time measure evaluating psychomotor speed and attention, Identification (IDN) a choice reaction time measure evaluating attention and executive function, One Back-Working Memory (WM) evaluating working memory, One Card Learning (OCL) evaluating memory. We also applied Groton maze timed chase test (GMCT, measuring Speed of visual processing, maze task), Groton maze learning test (GML), and Groton maze learning test - delayed recall (GMR). The test battery required approximately 25 minutes to complete.

Gait Measurements. Gait spatio-temporal parameters were measured with the OptoGait system (Microgate, Bolzano, Italy). Ten transmitting and ten receiving bars were placed in parallel to each other along a 10 m x 2 m hall and the first bar was placed approximately 30 cm from the starting point. Data were sampled at 1000 Hz and analyzed with OptoGait software, version 1.6.0.

Participants were asked to walk two times for 1 minute in two different conditions; walking at their preferable self-selected speed and the same under a dual-task condition. The dual-task condition was composed of walking, while at the same time subtracting by threes from a randomly chosen number between 400 and 500. The primary outcome variable chosen for the analyses was dual-task cost (DTC), a sensitive measure allowing the comparison of combined simple and dual-task walking across groups and time. The DTC model has been employed (Lindenberger et al., 2000) as a measurement of the slowing of gait that occurs when cognitive demands are high (e.g., a dual-task condition when a person is asked to complete a cognitive task while walking) as compared to when they are minimal (e.g., simple walking). DTCs were calculated as follows: $[(\text{dual-task walking condition} - \text{single-task walking condition}) / (\text{single-task walking condition})] \times 100$.

Statistical analysis. The data were analyzed with IBM SPSS Statistics 19.0 software (SPSS, Inc., Chicago, Ill, USA). The normality of the distribution of the parameters was tested with the Shapiro-Wilk's test. Post hoc comparisons were carried out with the Least Squares Means approach.

The effectiveness of cognitive training was assessed with a virtual maze testing environment. Mean errors were entered into 2X2 mixed design ANOVA with Group (Intervention and Control group) as the between subject variable and Time (BRd1 and BRd14) as the within subject variable.

The first measurement for gait performance was performed before bed rest (BRd-1). The second one was administered immediately after the end of the bed rest study (RECD1). The last measurements were administered to assess mobility performance after the completion of the 28-day recovery program (RECD28). DTCs were entered into a 2X3 mixed design ANOVA with Group (Intervention and Control group) as the between subject variable and Time (BRd-1, RECD1 and RECD28) as the within subject variable.

Statistical significance for interaction effect was set at the level of $p < .10$ and for time effect at the level of $p < .05$.

Results

Baseline measurements. At baseline both groups performed a virtual maze learning task to assess baseline navigation performance. The Intervention and Control groups did not differ in the number of errors committed during maze learning (1.97 vs 1.92 respectively, $p = .930$), nor did they differ in their gait performance measured with DTCs (-11.53 % vs -5.07 % respectively, $p = .400$).

Cognitive training effectiveness. Results for average errors showed that there was a significant main effect of Time [$F(1,12) = 5.743$, $p = .034$, $\eta^2 = 0.324$] and interaction [$F(1,12) = 3.774$, $p = .076$, $\eta^2 = 0.239$] (see Figure 1, right panel). Post hoc analysis showed that the Intervention group significantly reduced the number of average errors after the CCT on the last day of the bed rest study ($p = .034$), while the Control group remained the same ($p = .740$).

Transfer effectiveness. We evaluated transfer with the CogState computerized test battery. The only significant interaction effect between the Intervention and Control groups was obtained with the Graton maze test (GMCT). CogState results were entered into a 2X3 mixed design ANOVA which demonstrated a significant effect of time [$F(1,13) = 58.12$, $p = .025$, $\eta^2 = 0.82$] and an interaction between time and group [$F(1,13) = 26.93$, $p = .040$, $\eta^2 = 0.67$].

Gait performance measurements. DTCs were entered into a 2 X 3 mixed design ANOVA which demonstrated a significant effect of time [$F(2,26) = 12.69$, $p < .001$, $\eta^2 = 0.494$] and an interaction between time and group [$F(2,26) = 5.93$, $p = .008$, $\eta^2 = 0.313$]. Post-hoc comparisons of interest demonstrated that the significant effect of time was driven by the Intervention group: while there was no significant difference in the DTCs between BRd-1 and RECd1 for the Control group (-5.07 % vs. -1.13 %, $p = .124$), participants in the Intervention group showed a significant reduction of DTC (Figure 1– right panel) in RECd1 as compared with BRd-1 (-8.66 % vs. 9.22 %, $p < .001$) and significant return after the bed rest, as compared with the recovery period (9.22 % vs. -1.62 %, $p = .048$).

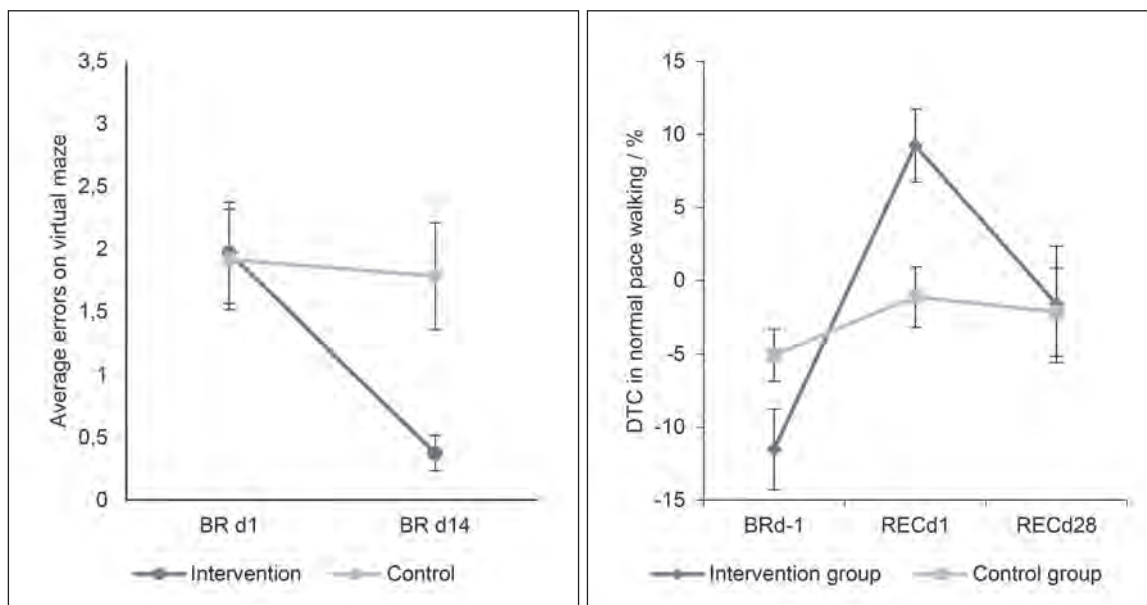

Figure 1: Left panel: Average errors (from the 2nd to the 5th virtual maze trial) at the first day of bed rest (BRd1), at the last day of bed rest (BRd14) and at the end of the recovery period (RECd28). Right panel: Dual task costs during normal pace walking before bed rest (BRd-1), immediately after bed rest (RECd1) and at the end of the recovery period (RECd28).

Discussion and conclusions

The results from the present study demonstrated that CCT based on virtual spatial navigation was effective: Participants in the Intervention group who underwent 12 sessions of virtual spatial navigation training showed a significant reduction of errors made at the end of bed rest, while the Control group remained at the same level. Our study is in accordance with the other studies which reported significant improvements in performance across the specific cognitive functions trained (Ball et al., 2002). Furthermore, our interest was to assess whether our CCT was effective for other cognitive functions that were not specifically trained, e.g., transfer of cognitive training. We obtained a significant transfer only with GMCT, a subtest which measures attention and psychomotor speed.

Our results show that CCT could also be an effective tool to reduce the deterioration that occurs during prolonged inactivity on the motor level of the human body. Participants in the Intervention group showed a significant reduction on DTC gait performance at the end of the bed rest study. Surprisingly, the effects of CCT were present immediately at the end of CCT and could not be noticed at the end of the recovery period (28 days after the intervention), when both

groups performed at the same level. Our results are in general agreement with the study of Vergheze et al. (2010), who demonstrated that CCT can improve mobility in sedentary seniors.

The effectiveness and transfer of CCT, which included spatial navigation, may relate to two potential mechanisms: i) CCT during the bed rest improved cognitive functions specifically involved with facilitating other closely related cognitive functions (memory, working memory and attention) and dual-task performance (executive functioning) and/or ii) CCT engaged brain areas involved in mobility and hence “rehearsing” walking while the patient was on bed rest. It has been well established that success in spatial navigation is associated with superior spatial memory and speed of processing as well as executive functions.

The results of this study could aid in the development of new intervention programs, as well as rehabilitation protocols, to be used in situations of long term inactivity or immobilization caused by illness, injuries, sedentary jobs or space flights.

References

1. Ball K, Edwards JD, Ross LA. The impact of speed of processing training on cognitive and everyday functions. *J Gerontol B-Psychol.* 2007;62:19-31.
2. Lindenberger U, Marsiske M, Baltes PB. Memorizing while walking: Increase in dual-task costs from young adulthood to old age. *Psychol Aging.* 2000;15:417-436.
3. Lipnicki, D. M., & Gunga, H. C. (2009). Physical inactivity and cognitive functioning: results from bed rest studies. *European Journal of Applied Physiology*, 105(1), 27–35.
4. Pavy-Le Traon, A., Heer, M., Narici, M. V., Rittweger, J., & Vernikos, J. (2007). From space to Earth: advances in human physiology from 20 years of bed rest studies (1986 –2006). *European Journal of Applied Physiology*, 101(2), 143–194.
5. Vergheze J, Mahoney J, Ambrose AF, Wang CL, Holtzer R. Effect of Cognitive Remediation on Gait in Sedentary Seniors. *J Gerontol a-Biol.* 2010;65:1338-1343.

ISOKINETIC STRENGTH IN LEUKEMIA PATIENTS PRIOR TO AND AFTER TREATMENT – PILOT STUDY

Tomáš Vodička, Martin Zvonař and Martin Sebera

Department of Kinesiology, Faculty of Sports Studies, Masaryk University, Brno, Czech Republic

Abstract

Purpose: to compare isokinetic strength in oncological patients before and after medical treatment.

Methods: 3 males (40.67 ± 26.63 years, 183.00 ± 7.32 cm, 80.17 ± 6.48 kg) and 6 females (57.67 ± 10.68 years, 168.17 ± 9.01 cm, 77.85 ± 16.04 kg) were assessed on a Humac Norm at $30^\circ/\text{sec}$ and $60^\circ/\text{sec}$ during extension and flexion of the legs. A 2-way (Gender x Time) mixed Anova with repeated measures on the second factor was used to assess the differences between men and women over time.

Results: There was a Gender x Time interaction for peak torque ($\eta^2 = 0.32$, 95% CI: 0.13 – 0.82). The men (161.33 ± 25.95 Nm) scored higher than the women (63.25 ± 25.94 Nm) during the pre-test ($d = 3.78$ (95% CI: -25.58–24.54 Nm). They also scored higher at the post-test (153.33 ± 26.99 Nm vs. 70.83 ± 26.99 Nm, $d = 3.06$, 95% CI: -27.48–24.65 Nm).

Conclusion: Isokinetic peak torque did not differ between the pre- and post-test in both men and women after medical treatment for leukemia.

Key words: leukemia, isokinetic strength, medical treatment

Introduction

The strength of extensors and flexors of the knee joint plays a key role for human locomotion. After chemotherapeutic treatment, the muscle mass reduces, which is connected to a decrease in strength. As a consequence, physical activities of the patients decrease, which results in problems with usual walk or walking upstairs. Muscles employed while walking are quadriceps and hamstring. The aim of the present pilot study is to diagnose strength abilities of the stated muscles both during treatment and subsequently after chemotherapeutic treatment. The period between the first and second testing was 6 months.

Methods

The research group included 9 patients (3 men, 40.67 ± 26.63 years, 183.00 ± 7.32 cm, 80.17 ± 6.48 kg) and six women (57.67 ± 10.68 years, 168.17 ± 9.00 cm, 77.85 ± 16.04 kg), who were recruited from the Fakultní nemocnice (University Hospital) in Brno, Czech Republic. The second measurement was carried out after 6 months. All patients were free of any orthopedic problems or injuries which could have affected the results. Isokinetic strength was assessed on a Humac Norm CSMI (Stoughton, MA, USA) dynamometer at $30^\circ/\text{sec}$ and $60^\circ/\text{sec}$. The subjects were seated against a backrest of a chair and were tightly fixed with belts in the areas of the hips and shoulders. Another belt fixed the leg just above the knee so that employing other muscle groups could be minimized.

Each measurement was preceded by a warm-up which included (sub-)maximal repetitions as suggested by Johnson et al. (1978). Subjects subsequently performed 5 repetitions at each angular velocity (Baltzopoulos et al., 1998; Freedson, 1993) with a break was of 2 minutes in between (Stratford et al., 1990).

A 2-way (Gender x Time) mixed Anova with repeated measures on the second factor was employed to assess the differences in isokinetic strength between males and females over time. The level of significance was set to an effect size of 0.20.

Results

Table 1 displays the descriptive statistics of peak torque over time at $30^\circ/\text{s}$ and $60^\circ/\text{s}$ in males and females. There was a Gender x Time interaction for peak torque ($\eta^2 = 0.32$, 95% CI: 0.13 – 0.82). Table 2 shows the effect sizes ($d \pm 95\%$ CI) for the simple effects analysis of the Gender x Time interaction. There also was a main effect for Gender ($\eta^2 = 0.60$, 95% CI: 0.24 – 0.95) and for Time ($\eta^2 = 0.72$, 95% CI: 0.43 – 0.97).

Table 1: Descriptive statistics of peak torque (Nm) for right and left leg extension and flexion by gender over time

Movement	Men		Women	
	Pre-test	Post-test	Pre-test	Post-test
Right leg				
Extension at 30°/s	204.33±35.11	186.33±52.17	84.17±22.16	94.00±24.92
Flexion at 30°/s	115.67±32.01	127.67±40.46	94.00±24.92	52.00±10.79
Left leg				
Extension at 30°/s	198.67±51.00	172.67±58.94	83.50±22.49	90.00±27.90
Flexion at 30°/s	112.00±37.99	105.33±29.69	44.00±11.49	50.33±14.26
Right leg				
Extension at 60°/s	208.67±50.84	192.00±59.81	83.17±30.29	91.83±29.86
Flexion at 60°/s	95.33±54.63	114.67±38.55	42.50±9.94	47.50±10.82
Left leg				
Extension at 60°/s	189.33±61.16	168.67±62.00	73.67±21.88	79.83±29.94
Flexion at 60°/s	100.33±44.79	106.67±42.22	33.50±10.45	42.83±10.87

Table 2: Simple effects analysis of the Gender x Time interaction (d ± 95% confidence interval)

Gender	Test (M±SD)	Men pre-test	Men post-test	Women pre-test	Women post-test
Men	Pre-test 161.33±25.95	--			
Men	Post-test 153.33±26.99		--		
Women	Pre-test 63.25±25.94	3.78 (-25.58–24.54)	3.43 (-27.11–24.19)	--	
Women	Post-test 70.83±26.99	3.39 (-25.97–24.99)	3.06 (-27.48–24.65)		--

Discussion

The main objective of this study is to show the changes in power skill patients with leukemia at the beginning and end of treatment. We are aware that this is a pilot study involving a small number of test subjects and can thus adhere to the resulting conclusions. The pilot study served us to determine the trend in force skills under the selected angular velocities. According to the findings of the authors, there is a tiny amount of similarly focused studies that addressed the diagnostic power in patients with leukemia. Data collection will continue to take place and we hope that we will be revealing conclusions.

Conclusions

The above study is a result of a pilot research which presents the initial results of diagnosing strength abilities of extensors and flexors of the knee joint. The range of the group does not allow us to make any essential generalizations. We will further continue in collecting data which will make it possible to make the results more precise and to find the influence of chemotherapeutic treatment on the level of strength abilities in the context of success of the treatment. At the same time, we are planning another research focused on comparing the strength of extensors and flexors including a comparison with usual population.

References

1. Baltzopoulos, V., & Brodie, D.A. (1989) Isokinetic dynamometry: Applications and limitations. *Sport Medicine*, 8, 101- 116.
2. Freedson P S, Gilliam T B, Mahoney T, Maliszewski A F, Kastango K (1993) Industrial torque levels by age group and gender. *Isokinetics and Exercise Science* 3: 34-42
3. Johnson, J., & Siegel, D. (1978). Realibility of an isokinetic movement of the knee extensors. *Research Quarterly*, 49, 88-90
4. Perrin, D.H. (1986). Reliability of isokinetic measures. *Athletic Training*, 10, 319-321
5. Stratford, P.W., Bruulsema, A., Maxwell, B., Black, T., & Harding, B. (1990). The effect of inter-trial rest interval on the assessment of isokinetic thigh muscle torque. *Journal of Orthopedic and Sports Physical Therapy*, 11, 362-366

Adaptation of Human Organism to Disease and Ageing

EFFECTS OF TWO WEEKS OF BED REST AND SUBSEQUENT REHABILITATION ON SIZE AND FUNCTION OF SINGLE MUSCLE FIBRES

Lina Cancellara, Luana Toniolo, Tatiana Moro, Katja Koren, Antonio Paoli and Carlo Reggiani

Dept of Biomedical Sciences, University of Padova, Italy

Muscle biopsies were obtained from the vastus lateralis before and after 15 days of bed-rest from seven young (age 20-30) and sixteen elderly (age 60-65) male subjects. A third biopsy was taken after 15 days of rehabilitation based on three sessions/week of exercise. All subjects were healthy normally active sedentary people. Single fibres were dissected, cross sectional area (CSA) and isometric force (Fo) during maximal activation were measured and myosin isoform determined with SDS_PAGE to classify fibres as slow, fast 2A, 2X and hybrid.

Before bed rest, significant differences were present between young and elderly subjects as the proportion of slow fibres and slow myosin isoforms was greater in the elderly, while the average CSA and isometric force of single muscle fibres were greater in the young subjects.

Average fibre CSA showed a decrease in both groups, which was followed, during rehabilitation by a recovery to initial values in the young but not in the elderly group. Average isometric force underwent to a decrease during the bed rest period without any increase during the rehabilitation period.

Taken together the results point to the high sensitivity to disuse of muscle fibre function and size in the elderly and to the slow and incomplete recovery during the rehabilitation period.

AGEING IS ASSOCIATED TO A LOWER DEGREE OF INSULIN RESISTANCE DEVELOPMENT, AS INDUCED BY 14-D EXPERIMENTAL PHYSICAL INACTIVITY

Filippo Giorgio Di Girolamo¹, Sara Mazzucco¹, Martina Lanza¹, Nina Mohorko², Roberta Situlin¹, Rado Pišot² and Gianni Biolo¹

¹*Dept. Medical, Surgical and Health Sciences, University of Trieste, Italy*

²*Institute for Kinesiology Research, Science and Research Centre, University of Primorska, Koper, Slovenia*

Purpose

The increased prevalence of insulin resistance, an early symptom of type 2 diabetes, is mainly associated to the increased lifespan. Physical inactivity is another well-recognised key factor in the impairment of insulin metabolism. Nevertheless, the impact of ageing on the development of insulin resistance, induced by physical inactivity, is poorly investigated.

Methods

Two groups, “Young” (n=7; 23±1y; body mass index, BMI=24.0 ± 0.9 kg/m²) and “Elderly” (n=8; 59±1y; body mass index, BMI=26.8 ± 1.5 kg/m²), participated to 14-d experimental bed-rest. Before and after bed-rest insulin sensitivity was assessed (i) in the fasting state (HOMA index of insulin resistance); (ii) during an oral glucose tolerance test, using the Matsuda index and the ratio between the area-under-the curve (AUC) of insulinemia (AUCIns) and the AUC of glycaemia (AUCGlyc), indexes of insulin sensitivity and resistance, respectively. Repeated-measure ANOVA was used to define the impact of bed-rest and bed-rest×group interaction. Student t-test was applied to compare baseline differences and bed-rest-induced changes in the two groups.

Results

At baseline assessed anthropometric and metabolic parameters were comparable between groups. After bed-rest, the significant (p=0.02) increase in HOMA index was greater in Young (1.11±0.23 to 1.82±0.35) as compared to Elderly (from 1.27±0.20 to 1.34±0.21) (bed-rest×group interaction p<0.05). This is associated to no changes in fasting glucose and to significant bed-rest-induced changes in fasting insulin (+16±12% in Elderly, +74±21% in Young; bed-rest effect p<0.01, bed-rest×group effect p<0.05). At baseline, after glucose load, AUCIns was comparable between groups whereas AUCGlyc was slightly (p=0.05) higher in Elderly (372±24mg/h) than Young (312±4mg/h). After bed-rest, AUCIns significantly increased in both groups (p<0.01). The increase was greater (p=0.02) in Young (+113±19%) than Elderly (+49±14%). AUC Ins/AUCglyc significantly (bed-rest effect p<0.001; bed-rest treatment interaction p=0.02) increased by +39±13% in Elderly and by +98±17% in Young. Bed-rest induced a reduction in the Matsuda index (p<0.001), that was double in Young (+46±5%) than Elderly (20±9%) (p=0.04).

Conclusions

Physical inactivity-induced insulin resistance, assessed in fasting and post-prandial states, occurred both in young and elderly population although it was double in young. Elderly population was more resistant, or more adapted, to metabolic alteration induced by sedentary lifestyle.

Key words: *Insulin sensitivity; Experimental physical inactivity; Elderly population*

COMPARATIVE STUDY OF YOUNG AND SENIOR PEOPLE ELECTROENCEPHALOGRAPHY ACTIVITY DURING SENSORY ORGANIZATION BALANCE TEST IN RESPECT OF VISUAL FUNCTION

Tariq Ali Gujar^{1,2} and Anita Hökelmann¹

¹*Otto-von-Guericke-University Magdeburg, Germany*

²*NED University of Engineering and Technology Karachi, Pakistan*

Introduction

Balance maintenance is a fundamental ability of human movement (Winter, 1995), which plays a role in repeated falls of older adults beside having gait disorders (Tinetti, Speechley & Ginter, 1988). A common problem in people at the age of 65 and above is falling down due to disequilibrium. That may result into serious injuries and in some cases leads to death (Droller, 1955). The maintenance of equilibrium depends on integration of input from multi-modal sensory sources, including visual, vestibular and proprioceptive systems (Mergner et al., 2003). The aim of this study is to find out electroencephalography (EEG) responses, during balance activity in young and senior people with reference to visual function. The outcome of this study will be helpful to make the fitness and neuro rehabilitation plan. Fifteen young people (25 ± 3.2 years) and fifteen senior people (70 ± 3.2 years) respectively have been analyzed on balance master, with coupling of brain vision 32 electrode wireless EEG system during Sensory Organization Test. IIR filter 0.5 Hz low pass, 32 Hz high pass has been used for EEG Data. Semiautomatic method was used for artifact rejection with 50 μV/ms and ICA Ocular Correction method was used for Ocular artifacts. Further exported data has been analyzed on a statistics software (SPSS 17). From the results we have found that the balance score of young samples has been found significantly higher in stable platform condition ($p = 0.001$), along with significant low beta values in visual function of brain in comparison to senior samples ($p = 0.02$). In moving condition of platform and surrounding no significant differences has been found in balance scores between both groups, but beta values in visual function of seniors has been found significant higher ($p < 0.01$). During Sensory Organization Test, balance scores of young people were higher with less brain beta activity during stable platform and surrounding condition as compared to senior people. However during moving condition of platform and surrounding, high visual function beta values has been found along overall increase in electroencephalography activity in senior group as compare to young group, which indicates higher activity in the brain.

Key words: *Balance, Injury, Sensory Organization Test (SOT), Electroencephalography activity*

References

1. Droller, H. (1955). *Falls and accidents in a random sample of elderly people living at home*. In: Old Age in the Modern World, Report of the III Congress of the International Association of Gerontology Edinburgh: Livingstone.
2. Mergner T., Maurer C. & Peterka, R. (2003). A multisensory posture control model of human upright stance. *Prog Brain Res*, 142, 189–201.
3. Tinetti, M. E., Speechley, M. & Ginter, S. F. (1988). Risk factors for falls among elderly persons living in the community. *New England Journal of Medicine*, 319, 1701-1707.
4. Winter, D. A. (1995). Human balance and posture control during standing and walking. *Gait & Posture*, 3(4), 193–214.

EFFECTS OF AGEING ON THE DEVELOPMENT OF ANABOLIC RESISTANCE DURING EXPERIMENTAL BED-REST, AS ASSESSED BY A SIMPLIFIED STABLE ISOTOPE-BASED METHOD

Sara Mazzucco¹, Filippo Giorgio Di Girolamo¹, Martina Lanza¹, Nina Mohorko², Roberta Situlin¹, Rado Pišot² and Gianni Biolo¹

¹Dept. Medical, Surgical and Health Sciences, University of Trieste, Italy,

²Institute for Kinesiology Research, Science and Research Centre, University of Primorska, Koper, Slovenia

Abstract

Purpose

Anabolic sensitivity, i.e., the capability of anabolic stimuli as exercise and amino acid to stimulate protein synthesis, is impaired during physical inactivity and can be considered one of the key mechanisms leading to muscle atrophy during bed rest. The gold standard to assess anabolic sensitivity is based on complex and expensive isotope tracer methods. The effects of ageing on physical inactivity-induced anabolic resistance is poorly investigated.

Methods

Two groups, “Young” (n=7; 23±1y; body mass index, BMI=24.0 ± 0.9 kg/m²) and “Elderly” (n=8; 59±1y; body mass index, BMI=26.8 ± 1.5 kg/m²), participated to 14-d experimental bed-rest. Before and after bed-rest, anabolic sensitivity was assessed during a meal test by oral administration of 0.3g [ring-²H₅]-phenylalanine. Blood was collected at several time over 6 hours to determine plasma isotopic enrichment and concentrations of [ring-²H₅]-phenylalanine and ²H₄-tyrosine, produced by the irreversible hydroxylation of [ring-²H₅]-phenylalanine, as well as the area-under-the curve of [ring-²H₅]-phenylalanine (AUCD5-Phe) and ²H₄-tyrosine (AUCD4-Tyr), over 6 hours. The anabolic resistance index had been calculated as AUCD5-Phe-to- AUCD4-Tyr ratio. Repeated-measure ANCOVA was used to define the impact of bed-rest and bed-rest×group interaction. Student t-test was applied to compare parameters at baseline.

Results

At baseline parameters of anabolic sensitivity were comparable between groups. Index of anabolic resistance significantly decreased after bed-rest in both group (bed-rest effect p<0.01), with a statistically significant bed-rest×group interaction (p=0.01). Anabolic resistance increased more in “Elderly” (18.5% ± 7.3%) than in “Young” (5.2% ± 9.4%). The same index, calculated after 2 hours from meal and [ring-²H₅]-phenylalanine load, requiring 2 blood draws, over the 7 planned, and 2, over 6, hours of observation, displayed similar results (bed-rest effect p<0.05; bed-rest×group interaction p<0.05) (R=0.75; p<0.001).

Conclusions

Anabolic sensitivity to anabolic stimulus is negatively impaired by both experimental physical inactivity and ageing. Therefore, elderly people are at greater risk of sarcopenia and frailty after unloading. Moreover, the new simplified method allows to monitor anabolic sensitivity to anabolic stimulus in a easier and cheaper way.

EFFECTS OF 14 DAYS OF BED REST AND FOLLOWING PHYSICAL TRAINING ON THE MAXIMAL EXPLOSIVE POWER OF LOWER LIMBS IN ELDERLY AND YOUNG HEALTHY MALES

Enrico Rejc¹, Alberto Botter¹, Mirco Floreani², Rado Pišot³, Pietro di Prampero² and Stefano Lazzer¹

¹Department of Medical and Biological Sciences, University of Udine, Italy

²School of Sport Sciences, University of Udine, Italy

³Institute for Kinesiology Research, Science and Research Centre, University of Primorska, Koper, Slovenia

Changing demographics make it important to understand the risk factors for loss of independence with ageing. Lack of strength is a relevant factor in compromised wellbeing in elderly. In this study, we investigated the negative effects of 2 weeks of complete inactivity (bed rest, BR) on muscle function in elderly (59.6±3.4 years) and young (23.1±2.9 years) healthy volunteers. After BR, subjects underwent to 6 sessions of physical training (PT) in order to recovery muscle function. Anthropometric characteristics were similar between elderly and young. Elderly generated lower Maximal Explosive Power of lower limbs (MEP) than young ($P<0.001$) both before (pre) (-31%) and after (post) BR (-34%). The level of muscle activation of vastus lateralis (VL), biceps femoris (BF), gastrocnemius medialis (GM) and tibialis anterior (TA) was not affected by age both pre- and post-BR. TA-GM co-contraction during the explosive lower limbs extensions was greater post-BR than pre-BR in both groups (+28%, $P<0.05$). Age did not affect muscle thickness of VL, GM and TA. BR decreased muscle thickness of VL and GM in both groups ($P<0.05$). After PT, the difference in MPE between elderly and young was 34% ($P<0.001$). In both groups, PT was not sufficient to bring MEP back to pre-BR values: the difference was 8% in elderly and 6% in young ($P<0.05$). In both groups *i*) TA-GM co-contraction was greater post-PT than pre-BR (+31%, $P<0.05$) and *ii*) PT brought thickness of the investigated muscles back to values similar as pre-BR.

In conclusion, 14 days of BR reduced MEP by about 13%. Six PT sessions following BR were not sufficient to restore MEP to pre-BR values in both groups. Subjects' age did not affect these changes in MEP. Finally, it can be hypothesized that muscle fiber properties may explain a substantial part of the MEP difference between elderly and young.

Key words: ageing, disuse, rehabilitation



Satellite Symposium

University Sport and Physical Activity

**7th INTERNATIONAL
SCIENTIFIC
CONFERENCE ON
KINESIOLOGY**

**FUNDAMENTAL
AND APPLIED
KINESIOLOGY – STEPS
FORWARD**

**Editor:
Prof. Sanja Ćurković, PhD**

**Peer Reviewers:
Prof. Romana Caput Jogunica, PhD
Prof. Sanja Ćurković, PhD
Zrinko Čustonja, PhD**



MONITORING THE SUBJECTIVE EXERCISE EXPERIENCE IN PHYSICAL EDUCATION STUDENTS

Ensar Abazović¹, Đurdica Miletić¹ and Erol Kovačević²

¹Faculty of Kinesiology, University of Split, Croatia,

²University of Sarajevo, Faculty of Sport and Physical Education, Bosnia and Hercegovina

Abstract

Subjective exercise experience is an important factor that can affect the process of motor learning. The first aim of this research was to determine gender differences in kinesiology students exercise experience scale results during various classes. Second aim was to analyse the differences in kinesiology students subjective exercise experience scale results before and after physical activity in different teaching classes. Sample examinees were 43 Junior Students at Faculty of Sport and Physical Education, Sarajevo University, in the academic 2013/14 year. The sample was consisted of 31 male and 12 female students. There are no gender differences in the subjective exercise experience scale results before classes but they are present after classes. The results also show that there are significant differences between the subjective exercise experience scale results measured before and measured after classes. It can be concluded that the optimal choice of movement tasks and proper methodological approach can affect and induce positive subjective feelings.

Key words: learning process, gymnastics, sport training

Introduction

In the past ten years, there is an expansion of recent scientific studies and textbooks dealing with the problems of motor learning (Edwards, 2010). According to Coker (2009) motor learning can be defined as a change in internal processes that determine an individual's ability to perform a specific motor task. According to these authors, there are numerous factors that can affect the process of motor learning which can be classified in three areas: individual, environment and task. According to the first criteria, it is assumed that the same learning process can have variety of different effects on individuals, due to their personal characteristics and differences. Any form of physical activity, so as the psychical exercise, causes specific physical and psychological effects. Monitoring the psychological effects of exercise was the subject of many previous studies. Based on their results, many authors (Cox et al., 2001) came to the conclusion that most of those effects are positive.

When it comes to subjective psychological effects, the best means for evaluating their relation to physical activity is questionnaire called SEES (Subjective Exercise Experience Scale), or scale used for assessing the subjective feelings associated with exercise, which was created by McAuley and Courneya (1994), which tries to determine the general psychological response that can be positively or negatively oriented. This questionnaire was used in this study to determine the level and nature of subjective feelings of students in the motor learning process.

When it comes to the performance of complex motor tasks, or learning complex skills (in this case, participation in class), subjective feelings resulting of these activities were very important. Also, it is important to establish subjective feelings that occur prior to the accession to learning process, so it is necessary to assess subjective feelings before and after the learning process. In addition, there is a need for an assessment in male and female student population because of eventual need for comparison.

The first aim of this research was to determine whether there are gender differences in kinesiology students exercise experience scale results during various sports skills learning. Classes they attended were: sports training, artistic gymnastics and rhythmic gymnastics. Second aim was to analyse the differences in kinesiology students subjective exercise experience scale results before and after physical activity in different teaching classes, including: sports training, artistic and rhythmic gymnastics.

Methods

Sample examinees were 43 Junior Students (third year) at Faculty of Sport and Physical Education, Sarajevo University, in the academic 2013/14 year. The sample was consisted of 31 male and 12 female students.

The sample of variables in this study consisted of three factors that point to subjective feelings related to physical activity. Specifically, the questionnaire that was used (SEES) was constructed by McAuley and Courneya (1994) to

determine the global, negative and positive psychological effects of physical activity. SEES is made up of 12 items, for which assessment, the Likert scale (7 degrees) is used, which respectively define three subjective exercise experience factors (each factor is constituted by 4 claims). These factors are: PWB - Subjective feeling of positive well being; PD - Subjective feeling of psychological distress; F - Subjective feeling of fatigue. All students filled out a SEES questionnaire at the beginning and at the end of the class. They were instructed to fill the questionnaire in accordance with their current feelings. The questionnaire was filled out before and after the class of: 1) Rhythmic Gymnastics, 2) Sports Gymnastics and 3) Sport training. Participants did not know the purpose of testing neither the results of previous studies so that eventual results objectifying could possibly be avoided.

Statistical analysis was conducted using Statistica 11 for Windows OS. For all dependent variables in all measurements, standard descriptive parameters were calculated: mean (M), standard deviation (SD), and the value of KS test to evaluate distribution normality. Gender differences were analysed by using independent samples t-test for normally and the Mann - Whitney U test with abnormally distributed variables. Results obtained before and after different activities were analysed by univariate analysis of variance (ANOVA) if the variable had normal, or Kruskal-Wallis test for variables which did not have normal distribution.

Results

Gender differences in kinesiology students exercise experience scale results before and after classes are presented in Table 1.

Table 1: Mean ± standard deviation and KS test values for all subjective exercise experience scale factors before and after activities and T-test and Mann-Whitney U results ($p < 0,05$)

	Before activity				After activity			
	M	F	M	F	M	F	M	F
Sport training								
PWB	19,2±5	.12	17,5±5,9	.19	19,4±4,8	.11	15,8±4,3*	.19
PD	8±3,7	.18	9,2±6,9	.34	7,1±3,2	.16	10,6±7,6	.23
F	13±4,9	.12	16,5±7,2	.18	13,9±5,6	.15	16,1±6,9	.22
Sport gymnastics								
PWB	18,5±4,9	.08	20,9±4,4	.10	17,3±4,9	.12	18,5±5,6	.13
PD	8,8±6,0	.23	7,8±4,0	.17	9,3±3,9	.14	9,8±6,5	.25
F	11,5±5,2	.14	11,6±6,4	.13	15,6±4,6	.11	15,1±7	.14
Rhythmic gymnastics								
PWB	20,1±5,2	.13	20,7±6,4	.19	21,5±5,4	.16	20±3,6	.16
PD	5,9±2,3	.20	8,7±5,9	.31	5,6±2,6	.27	8,2±5,4	.30
F	9,5±4,9	.15	11,5±5,4	.18	9,1±4,2	.13	13,2±6,3*	.17

Kinesiology students subjective exercise experience scale results before class and after class and its comparison are presented in Graph 1a, b and Table 2.

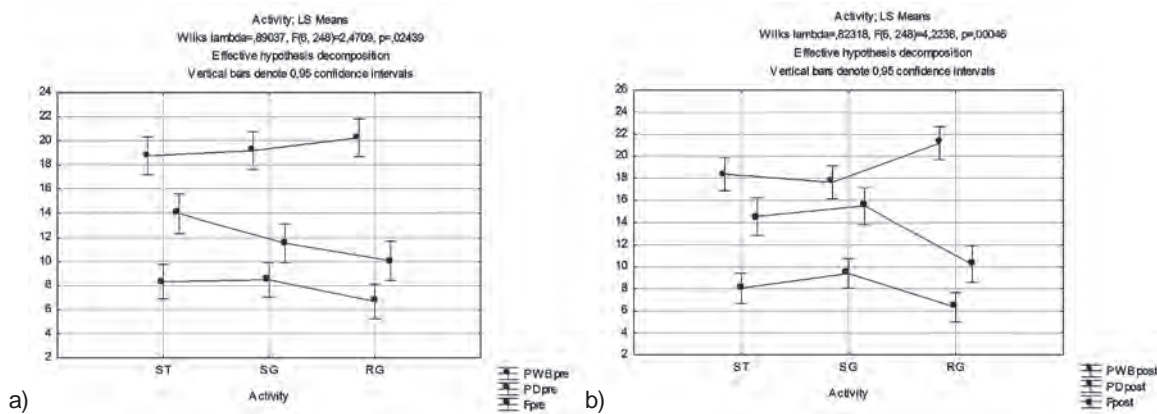

Graph 1a, b: Differences in initial values and in final values of subjective exercise experience scale results (Anova)

Table 2: Differences in initial values and in final values of subjective exercise experience scale results (Kruskall-Wallis test)

	Test Statistics	
	PDPRE	PDPOST
Chi-Square	3.452	12.785
df	2	2
Asymp. Sig.	.178	.002

Discussion and conclusion

Results (table1) show that there is no significant difference in subjective feelings of health, psychological distress and fatigue before classes between male and female students, so there are no gender differences in the subjective exercise experience scale results before classes where they learn various motor skills. Possible reason for this could be the fact that they have not formed opinions about different activities. This could be explained with the fact that the students were interviewed for the purpose of this research at the beginning of the semester, before they had a chance to familiarize themselves with the type of activities they will perform, and the kind of motor skills that they will learn. Other factors that could possibly affect their attitudes are professors personal characteristics.

Analysing the same variables after each activity, it is apparent that after the sports training class, the PWB factor is significantly different between male and female students. These results suggest that the subjective exercise experience scale results vary upon sports training class completion, and that they are more suited to male students. Therefore, positive feelings are more expressed in male than in female students after sports training class. The reason for this may be the content, or type of activity in which they are involved during the class. Considering the fact that this class often includes the use of weights, there is a possibility that the contents of class activities were more favoured by male student population. Furthermore, female students feel more expressed discomfort, so it was possible that the content of their motor learning was not appropriate. This is supported with the results of study by Van Landuyt et al. (2000) who reported that very high intensity physical activity has a negative effect on subjective feelings.

In artistic gymnastics there were no differences between male and female students before or after class in any factor. For this, there is a simple explanation. When it comes to sports gymnastics, men and women are in separate groups because the learning curriculums differ so that shows result that shows same or similar subjective feelings in both genders indicates that the content of the curriculum and the intensity were adapted to both populations.

When it comes to rhythmic gymnastics, there was significant difference between male and female students in the variable that represents the subjective feeling of fatigue. The differences which emerged after the class, and weren't there before, were in favour of the male population. Factor F was significantly lower among male than female students. The reason for this may be twofold. First, there is intensity load. Since the students learning activities did not differ, there is a possibility that class intensity is more suited for the male population. However, the second reason which is more likely the cause, may be the higher level of motivation due to the fact that it is a "feminine" sport and so the female students should be more successful at it. Attitude of that kind could really be the reason for female students greater commitment during these activities, which eventually results with higher fatigue level.

The second aim of this research was to analyse the differences in kinesiology students subjective exercise experience scale results before and after physical activity in different teaching classes. The results show that there are significant differences between the subjective exercise experience scale results before classes. This difference does not occur in all activities, nor is it noted at all the factors. The difference exists only when it comes to factor F. A closer look and the analysis of the results suggest that this difference was statistically significant only between physiological states in which students come to sports training and rhythmic gymnastics classes. Students generally arrive more tired to the sports training class. This could be the result of a schedule in which the pause between previous activities and sports training class is not optimal, regardless of whether it is a theoretical or practical class. This can refer to both types of classes because this is just subjective feeling. Furthermore, when it comes to the value of the other two factors (PWB and PD), although not statistically significant, it may be noted that they were most convenient before the rhythmic gymnastics class. Specifically, PWB factor was most expressed, while the PD factor had smallest value before this activity class.

When it comes to the situation after the class, it is in many ways different from that on the beginning. Results show that there is statistically significant difference in results of all factors. Subjective feeling of positive well being after the rhythmic gymnastics class, just like it was before the activity, was most expressed. In addition, that result was significantly higher than the result value measured after the other two classes. This indicates that the rhythmic gymnastics class causes the most positive effects on students which can be attributed to aesthetic movements involved in this activity. This is thoroughly explained in study by Miletić (2012).

Just as other factors, the value of subjective feelings of psychological distress (PD) after rhythmic gymnastics class is more favourable than in other two cases, therefore, it is lower after this class than after other two classes. This difference is statistically significant only between values measured after sports and rhythmic gymnastics classes. These results suggest that the subjective feeling of psychological distress has the strongest decline after the rhythmic gymnastics class. The factor F has the lowest value after rhythmic gymnastics class. Differences in the subjective feeling of fatigue that were recorded after these three activities are significantly different between groups. It is evident that the mean value of this factor is the lowest after rhythmic gymnastics class, when compared to the other two, and it was significant in both cases. It is important to note that these are subjective feelings and that these results can probably be attributed to the good effects of the class which depends on class teacher, the appropriateness of class content and the music which is present during this activity (Potteiger et al., 2000).

Based on these results, it can be noted that rhythmic gymnastics class has the best effects on students. This indicates that the contents of rhythmic gymnastics class is more appropriate and more adapted to the students than the contents of the other two activities included in this study. In support of this found goes the conclusion of Focht and Koltyn (1999) - if physical exercise is adapted to population, similar results occur regardless of the type of activities. With this in mind, and based on the results, we can conclude that some classes don't have appropriate class-content for the population, or it is not gender specific.

With the results of this study, it can be concluded that motor learning process caused significant physiological responses. On the other hand, it is evident that the subjective feelings in students vary greatly due to the relation to the type of activity that is realized, and that well-designed curriculum and good teaching methods can elicit extremely positive subjective feelings and then result with positive class effects.

Last but not least, it can be concluded that the optimal choice of movement tasks and proper methodological approach can certainly affect and induce positive subjective feelings and thus the quality of the learning process.

References

1. Coker, C. A. (2009). *Motor Learning and Control for Practitioners*. US: Holcomb Hathaway Publishing.
2. Cox, R. H., Thomas, T. R., & Davis, J. E. (2001). Positive and negative affect associated with an acute bout of aerobic exercise. *Journal of Exercise Physiology online*, 4(4), 13-20.
3. Edwards, W. H. (2010). *Motor Learning and Control: From Theory to Practice*. Wadsworth, USA: Cengage Learning.
4. Focht, B. C., & Koltyn, K. F. (1999). Influence of resistance exercise of different intensities on state anxiety and blood pressure. *Medicine & Science in Sports & Exercise*, 31(3), 456-63.
5. McAuley, E., & Courneya, K. S. (1994). Sport Psychology The Subjective Exercise Experiences Scale (SEES): Development and Preliminary Validation. *Journal of Sport & Exercise Psychology*, 16(2), 163-77.
6. Miletic, Đ. (2012). The Subjective Exercise Experience and Aesthetic Activities. *Acta Facultatis Educationis Physicae Universitatis Comenianae*, 52(1), 5-12.
7. Potteiger, J. A., Schroeder, J. M., & Goff, K. L. (2000). Influence of music on ratings of perceived exertion during 20 minutes of moderate intensity exercise. *Perceptual and Motor Skills*, 91(3), 848-54.
8. Van Landuyt, L. M., Ekkakis, P., Hall, E. E., & Petruzzello, S. J. (2000). Exercise Psychology Throwing the Mountains Into the Lakes: On the Perils of Nomothetic Conceptions of the Exercise-Affect Relationship. *Journal of Sport & Exercise Psychology*, 22(3), 208-34.

ATHLETES AND EDUCATION: What should we do to support athletes in dual career development?

Romana Caput Jogunica¹, Biserka Vrbek² and Sanja Ćurković¹

¹*Faculty of Agriculture, University of Zagreb, Croatia*

²*Croatian Olympic Committee, Croatia*

Abstract

The main aim of this paper is to introduce public society, especially academic and sport public about the problems that young talented athletes experience in the educational system. In 2012 Croatian Olympic Committee has started the new Project Athletes and Education (2012-2016) which is based on the results of previous studies on Croatian perspective athletes, European best practices and European dual career guidelines. European countries and its secondary schools, vocational colleges and universities in general have different positions and legal/moral responsibility for supporting students – athletes. The examples of European studies include advice and support, careers counselling, employment opportunities, financial support and incentives to return to education. Many studies have confirmed that student-athletes have a highly developed time management, skills, high self-esteem and discipline. Helping athletes to prepare themselves in dual career development should be a primary concern for different European and National cross-sector stakeholders.

Key words: Croatian project, analysis, EU guidelines, best practices

Introduction

According to the results of the pilot study on sample of female Croatian perspective athletes (Caput-Jogunica, 2007, Matković, 2007, Caput-Jogunica & Razbornik, 2009, Vrbek et al., 2010), Croatian Olympic Committee in cooperation with the Ministry of Science, Education and Sport has started the Project “*Perspective Athletes in the Croatian Educational System*” (2008-2010) and “Athletes and Education 2012-2016”. The main objective of the Project is introducing the education (secondary and high schools, universities) and sports public to the problems young talented athletes are experiencing in the educational system. The Ministry of Science, Education and Sport in cooperation with the Croatian Olympic Committee drafted the national document “Recommendation for the Study Conditions of Perspective and Top level athletes at the universities and vocational colleges”. The major aim of this document is to motivate high level educational institutions to support the education of athletes by implementing some of the following recommendations: flexibility of lessons attendance, study time and exam dates, support from teachers, tutors, flexible disposition of teachers, e-based learning, etc. In 2011 we made analysis of the effects related to implementation that has been prescribed from the Ministry and National Council for Sport. There is a variety of explanations why athlete’s long term career prospects does not have enough support in both: Governmental (Ministry, educational system, counties, towns, etc...) and Non-Governmental sectors (NOC, NSF, etc.). Consequently, we have proposed the new project “Athletes and education” (2012-2016) which is based on the analysis of actual state in Croatia, European model of best practices and European dual career guidelines.

The purpose of this paper is to present European best practices and actual situation of Croatian athletes in education with the goal to examine what we have to do to support young athletes in dual career development. For these purpose we made short review of the European best practices and results of the studies provided on the Croatian young athletes as well as the study on the sample of active and former top level athletes in Split.

European best practices

The White paper on Sports regulates sporting careers and education: “*In order to ensure the reintegration of professional sportspersons into the labour market at the end of their sporting careers, the Commission emphasises the importance of taking into account an early stage the need to provide “dual career” training for young sportsmen and sportswomen and to provide high quality training centres to safeguard their moral educational and professional interests.*” Once the compulsory school is terminated, athletes are confronted to several different choices: to abandon their studies and keep on training and competing or to keep on training and continue their professional education through the available ways in their country (the Study on training of young sportsmen/women in Europe, 2008). Following the European Council’s Declaration 2008 to address the question of “dual careers”, the European Commission has emphasised the importance of ensuring that young high-level athletes are offered a quality education in parallel to their sport training. Many efforts have

been made in the most European countries with the aim to allow high level young athletes to combine higher education studies and high level sport. According to the several studies, the practice often shows that this is not sufficient and that many high level athletes cannot go on studying efficiently if they want to reach the high level on the sports side.

According to Espwall at all, (2004) sport and the educational involvement are characterised by increasing time-consume during childhood and particularly adolescence: at late youth age, in most sports, 15 to 25 training hours per week are suggested in federations' concepts. During the same age, time expenditure in school ranges from 25 to 35 hours per week. In universities, these values are widely exceeded. Additional demands result from homework, studying, changeover, passages, and competition trips. In order to facilitate the compatible and successful coupling of individual sporting and educational development, manifold structural models of cooperation between high-performance sport organisations and educational institutions were built up in diverse systems in Europe. Particular attention has been focussed on flexible solutions for time-management.

Henry (2010) made analysis based on findings of four studies: Amara at all, 2004, Aquilina, 2009 and Aquilina at all, 2005 and Review of Performance Lifestyle initiatives in UK, 2010. These studies identified the kinds of specialist provisions evident in higher education institutions seeking to meet athletes' needs: 1. Facilitation by Universities of the academic experience of elite athletes by providing services such as: flexibility and time tabling (Cyprus, Germany), distance learning (Denmark, Sweden) and transfer between campuses and unlimited tenure of student status (Greece, Latvia), 2. Enhancement by Universities of the sporting experience of elite athletes by providing services such as: sport scholarships (Austria, Ireland, Slovenia, Poland, Portugal), elite sport development programmes (Finland, Spain, Germany, Sweden, UK) and professional supporting services (Belgium, France, Spain, UK) and 3. Universities providing assistance with post-athletic career opportunities through: study grants (Germany, France, Finland, UK) and new programmes (Sweden, The Netherlands). It is well known that the Government regulation and approval is important in the whole process.

Analysis of the Croatian athlete's actual situation

To determine the Croatian athlete's actual situation we have taken in consideration the results of several Croatian studies. First study has provided on 654 pupils (ages 15-20, 337 male athletes (55,42%) and 227 female athletes, who have participated of the Croatian Sports Secondary Schools Sports Association (handball, basketball, volleyball, track and field, table tennis, badminton and cross) held in Poreč in May, 2013. For this study purposes we analyzed 26 questions about personal data (ages, sports career duration, sports' categorization and the rights related to the sports status), top sports achievements, interest related education and career, environment support and special conditions in educational system. Statistical parameters were calculated for individual variables (answer frequency, cumulative percent and percent). The majority of the participants, 88 pupils, have been involved in sport for 10 years (14%), while 61 – 66 (totally 42%) participating in sports training and competition for 6 or more years. A reason for these results may be explained with the fact that most of them trained sports games (basketball, handball, volleyball and football) where the serious training used to be organised in elementary schools in third or fourth grade. To confirm the status of participants in the National competition for secondary schools association, analysis of the answers related the sports achievements, top level results and participation on the international world and sports competition as well as the sports categorisation could describe the sample in this study (Table 1).

Table 1: Data relating sports (experience, status and training) of young athletes

Level of competition (n/%) N=654		Level of categorization N=96		Training frequency N= 602	
OI	4 (0,5%)	I top level	1 (0,16%)	3x per day	19 (3,12%)
World (ISF)	31 (5%)	II top level	10 (1,64%)	twice a day	78 (12,8%)
European (EYOF)	28 (4,6%)	III top level	16 (2,63%)	once a day	212 (34,8%)
National	391 (64,3%)	IV gifted	28 (4,60%)	3-4x per week	250 (41,1%)
County	94 (15,5%)	V perspective	26 (4,27%)	less than 3x per week	43 (7%)
Others	106 (10,1%)	VI perspective	15 (2,46%)		

Table 1 shows that 96 participants in this study are recognized as top level, gifted or perspective athletes. The minority of them have had experience on sports competitions at international level, majority (64,3%) at national level. Altogether 212 (34,8%) athletes participated daily in sports training, 78 (12,8%) twice a day, 19 (3,1%) up to 3 times per day.

Analysis of the answers relating adjustment obligations in elementary school and sports career showed that 192 (31,7%) athletes-pupils have had problems in school rarely and 46 (7,6%) very often. During the secondary school education, problems with adjustment and professors comprehension have had more athletes-pupils; 262 (43,1%) rarely and 62 (10%) very often. The majority of athletes 252 (41,4%) absence from school several time per month up to couple school hours,

until minority 39 (6,4%) absence most part of schools year or several months in school year. Several times per week per several hours absence 54 (8,8%) athletes. The dual career of athletes (education and sport) are mostly supported by parents (522, 85,5%), after parents 277 (45,5) it is confirmed that coaches and friends (153, 25,1%) have a very important influence in their career. These findings confirmed previous studies and projects, (Hoch, 1999, Harmon, 2010, Trninic et al., 2009, Stambulova et al., 2009, as well as the results of the Projects: Education of young sportspersons, 2004, Athletes2Busines project, 2011, etc.) as well as the EU guidelines where the key persons in dual career are parents, coaches and quality of cooperation in the whole system (school-sport clubs / athletes- parents-coach).

Table 2: Special conditions for athletes in educational system

Recognized and confirmed conditions for athletes in educational system	F	%
1. mentor or coordinator	119	19,57
2. opportunity for negotiation of an exams time	365	60,03
3. opportunity for on-line homework	31	5,09
4. agreement and cooperation between sports club and school	269	44,24

Table 2 shows the related data recognized and confirmed special conditions for athletes in educational system. Opportunities for negotiation with teachers or professors for time of exams emphasized 365 (60%) athletes, quality of cooperation between school and sport club 242 (44,2%), until 119 (19,6%) athletes expressed mentor have recognized in this study as the most important conditions. These results indicated lack of quality support for young athletes in educational system which depends on sensibility of leaders in schools very often. The analysis of athletes opinion showed the necessity of better cross sector legislation (education – sport - health, communication, etc.) where professional support (advisory team, coordinator, network of the coordinator on different level, etc.) should be recognized for the active athletes as well as the athletes who planned to complete sports career.

Munivrana et al., 2013 made analysis on the sample of 73 top level former and active athletes in Splitsko-Dalamatinska County. The participants in the study were those who competed and achieved the medal at Olympic Games, or at World or European competitions. Analysis shows that the majority of athletes have secondary education (42%), while athletes with vocational college education (37%) and with higher education (14%). 7% athletes have the student status at the University in Split. Results related to employment showed that 4 (5%) of athletes are unemployed (all of them have secondary education), while 12 (6%) are still professional athletes and 28 (38%) are employed in sport and other services. Majority of athletes (17) with higher education are employed in other services, while the athletes with secondary education are mostly employed in sport as coaches, secretaries in different sports organisation (sports clubs, sports association, etc.) The main conclusion of the study is that athletes with higher education have more chances in different services, in private and public sector.

Conclusion

The field of athletes and education has been the subject of significant studies and projects. How do schools and universities perceive students-athletes and what can they do to support them? Some of the European countries (UK, France, Germany, Belgium (Flanders), Sweden and Finland) offer a wide spectrum of advice and support of lifestyle, careers and education, as well as job opportunities, whereas other European and non European countries offer limited or no elements of support. The examples of mentioned European studies include advice and support, careers counselling, employment opportunities, financial support and incentives to return to education. The cooperation between high sport performance and general education is crucial for the goal of compatibility of sporting success and educational prospects of young athletes. According to the study results on sample of Croatian young athletes, Croatian educational system has to find the solution of implementation conditions in legislation as well as to support the higher educational institution to develop e-learning study programme for the special educational groups such as top level athletes, young people with disabilities, young mothers, etc. The majority of the Croatian young athletes (385, 63,2%) are interested in studies programme in social and humanities science and studies of biomedicine and natural science (108 or 17,7%). Interest for the professional work in sport showed 258 athletes (42,4%), mostly for sports coach (186 or 30,6%) and 41 (6,7%) for sports manager. The authors of this article have received positive feedbacks from the young athletes relating needs to organise promotion day of career after sports career (386 athletes, 63,4% confirmed necessity). Young athletes support idea and needs to prepare the draft of the document National programme of developing dual career (437 athletes, 71,6% answered as very important or important) based on the European Commission document EU Guidelines on Dual Careers of Athletes.

Many studies (Alfermann, 2004, Stambulova, 2009, Harmon, 2010) show that student-athletes have highly developed time management, skills, high self-esteem and discipline, and a well developed self-concept and have little time to explore other aspects (Ferrante et al., 2002). In addressing the issue of athlete educational development and preparations for post-athletic careers a number of European and national governmental and non-governmental bodies have demonstrated

awareness and support on different levels. “Former athletes might be seen as a good investment for society. They are used to working hard and can be a good resource for a society in case of successful adaptation after sports career termination” (Alfermann et al., 2004). One step forward has realized by this Conference where dual career topic is recognized as important and implemented in the Conference programme.

References

1. Alfermann, D., Stambulova, N. & Zemaityte, A. (2004) Reactions to sport career termination: a cross-national comparison of German, Lithuanian, and Russian athletes. *Psychology of Sport and Exercise*, 5:61-75.
2. Amara, M., Aquilina, D., Henry, I., & PMP Consultats (2004) Education of Elite Young Sportspersons in Europe. Brussels: European Commission: DG Education and Culture.
3. Aquilina, D. (2009) Degrees of Success: Negotiating Dual Career Path sin Elite Sport and University Education in Finland, France and the UK. Loughborough University, Loughborough.
4. Aquilina, D., Argent, E., & Henry, I. (2005) A Review of Data on the Non-sporting Activities of Elite Athletes: Research Report Commissioned by UK Sport: Loughborough: Institute of Sport and Leisure Policy, Loughborough University.
5. Caput-Jogunica, R. (2007) Attitudes and intersts of Croatian female athletes and equality and education. International seminar: Sportswoman: from results to career in sports. Croatian Olympic Committee. pp 41-49. Zagreb.
6. Caput-Jogunica, R., Razbornik, S. (2009) The role of distance learning study for the Croatian top level athletes. In Lužar-Stifer, Jarec, I., Bekić, Z. (Eds.) Proceeding book of 31st International Conference on Information Technology Interfaces “ITI 2009“, Cavtat, 2009 (pp 349-352). Zagreb: SRCE University of Zagreb.
7. Espwall, S., Olyslager, M., Parker, R., Rus, V., Hiersemann, D., Langen, H.J., Emrich, E. and Gullich, A. (2004) Education in Elite Sport in Europe. Brussels: European Commission. Technical Report.
8. Harmon, N. (2010) Overscheduled and overcommitted. Published on line in Wiley InterScience. www.interscience.wiley.com
9. Henry, I. (2010) Elite Athletes and Higher Education: Lifestyle, Balance and the Managment of Sporting and Educational Performance. International Olympic Committee, University Relation Olympic Studies Centre.
10. Hoch, D. (1999) Why Athletes Quit a team and What to Do About it. *Coach and Athletic Director*. 4-5.
11. Matković, B. (2007) Analysis of the attitudes and interest of students of the Faculty of Kinesiology of the Zagreb University on education and gender equality in sport. International seminar: Sportswoman: from results to career in sports. Croatian Olympic Committee. pp 49-55, Zagreb.
12. Munivrana G. (2013) Report about education and employment of active and former top level athletes in Splitsko-Dalamtinska County. Unpublished material presented in the Promotion day “Career after sports career” in Split, October, 17th, 2013.
13. Stambulova, N., Alfermann, D., Statler, T. & Cote J. (2009) ISSP Position stand: Career Development and Transition of Athletes. *Career Development and Transisition*. 395-412.
14. Trninić, M., Papić, V. & Trninić, V. (2009) Influence of coach’s leadership behaviour and process of training on performance and competition efficacy in elite sport. *Acta Kinesiológica* 3., 1;18-25.
15. Vrbek, B., Caput-Jogunica, R, Kovačević, Z. & Muždalo, N. (2010) Perspective and Top level atheltes in the Croatian Educational System. Romana Caput-Jogunica & Željko Klarić (eds) Abstract book 13th ENGSO Forum Social inclusion and Education through sport. Dubrovnik, 2010. Ministry of Science, Education and Sport of the Republic of Croatia. pg 57

Documents

- EU Guidelines Guidelines on Dual Careers of Athletes, Recommended Policy Actions in Support of Dual Career in High-Performance Sport. Brussels, September, 2012.
- Recommendation for the Study Conditions of Perspective and Top level athletes at Croatian Universities and Colleges, Ministry of Science, Education and Sport
- White paper on Sport. European Commission (2007).
- Study of training of young sportsmen/women in Europe, Brussels: European Union: Ineum consulting, (2008)
- Communication from the Commission to the European parliament. The Council, The European economic and soical committee and the committee of the regions, Developing the Dimension in Sport, (2011)
- Education of young sportspersons, final report. Institute of Sport and Leisure Policy, Loughborough University (2004)
- AthletesToBusiness - Guidelines Promoting Dual Career. Brussels: EOC EU office (2011)
- Athletes and Education 2012-2016 (www.hoo.hr)

GENDER DIFFERENCES OF MOTIVATIONAL FACTORS IN STUDENTS FOR SPORTS ACTIVITIES

Katja Cerar¹ and Miran Kondrič²

¹*University of Ljubljana, Center for University Sport, Slovenia*

²*University of Ljubljana, Faculty of Sport, Slovenia*

Purpose

The main aim of this study was to examine differences in motivation to participate in sport activities and the frequency of engaging in sports activities among male and female students at University of Ljubljana. On a sample of 5271 students we studied what motivates and interest in being sports active and the frequency of engaging in sports activities according to gender.

Methods

The participants in our research were 5,271 students of the University of Ljubljana, 3,238 (61.4%) female students and 2,033 (38.6%) male students, which represents a 9.8 percent sample of University of Ljubljana in the 2010/2011 academic year. Most students (25.6%) were enrolled in the first year of study. The age of the participants was between 19 and 42 years.

All students have completed the “EMI-2, The Exercise Motivations Inventory” questionnaire (Markland and Hardy, 1993) which was developed as a means for assessing participation motives in order to examine issues such as the influence of motives on exercise participation, how such motives might influence the choice of activities undertaken, how affective responses to exercising may be influenced by reasons for exercising and how involvement in sports activity might have a reciprocal influence on participation motives.

The questionnaire comprises 51 questions in the area of motives for participating in sports activities and it may be used without the authors' permission. A six-point Likert scale was used. Respondents answered the stem “To have a healthy body...”, indicating their preferences from 0 (“not true at all”) to 6 (“very true”). In addition, we added 12 socio-demographic parameters to the EMI-2 (faculty, year of study, gender, age, region of residence and residence at the time of study, engagement in sports activities, etc.). Questionnaires were sent to respondents by e-mail with instructions on the basis of personal data sheets completed when the students were enrolling in the University of Ljubljana.

The data were processed with the IBM SPSS Statistics (20.0) software. The basic descriptive parameters were calculated (mean, standard deviation, frequency of answers). Univariate ANOVA was used to test the differences in the motives according to gender. The results were compared with other scientific research on student motivation for sport.

Results

The results reveal that male students engage in sports activity more often than female students and also show differences in the motives according to gender. For male students sport is potentially a tool for achieving Enjoyment, Social Recognition, Challenge, Affiliation, Competition, Health Pressures, Strength and Endurance, while women experience sport more as Stress Management, Revitalization, Ill-Health Avoidance, Positive Health, Weight Management and Appearance.

Most of the students engage in unorganized sports activities and are on average active almost 3 hours per week. Male students engage in sports activities more often than female students. Male students are on average active almost 5 hours per week, while female students are on average active 3.5 hours per week. Students who are engaged in organized sports activities are on average active slightly more than 1 hour per week.

The results of several foreign studies show that men and women have different motives for participating in sport activities. Shao-hua et al. (2006) also found gender differences in motives for participating in sports activities, along with interest in the sport, training methods and unorganized sports activity. Santos Legnani et al. (2011) demonstrated a statistically significant difference in five motivational factors (Affiliation, Competition, Weight Management, Rehabilitation, and Social Recognition). Similar results were found by Sirard et al. (2006). They determined that the primary factors motivating men's participation in sport are Competition, Social Interaction and Health while in first place for women there are Social Contacts, then Competition and Health. Men are more motivated by internal factors (Power, Competition, Challenge, Fitness) while women are more motivated by external factors (Weight Management, Appearance) (Egli et al., 2011; Guedes et al., 2012a). A comparison between men and women in all age groups shows greater motivation and a higher level of participation in sports activity among men than among women. In relation to both genders, negative factors observed for non-engaging in sports activity are a lack of interest and limited time (Sirard et al., 2006).

Conclusion

In our research we found that most of the students engage in unorganized sports activity. We also found that male students engage in sports activity more often than female students. The results also showed statistically significant differences in the motives according to gender.

Key words: students, motivation, gender differences, sports activity, University of Ljubljana

THE CONSTRUCT VALIDITY OF THE FIGURE RATING SCALE BASED ON ESTIMATES OF FEMALE STUDENTS AT THE UNIVERSITY IN OSIJEK

Josip Cvenić¹ and Renata Barić²

¹University of J.J. Strossmayer Osijek, Department of Mathematics, Croatia

²Faculty of Kinesiology, University of Zagreb, Croatia

Abstract

The aim of this research is to determine the construct validity of the FigureRating Scale (Stunkard, Sorenson and Schlusinger, 1983) on selfestimated body size perceived by female students at the University of Osijek. In order to determine the construct validity of the survey and the estimates obtained by it, following anthropometric variables were measured: height, weight and skinfolds (triceps, suprailiac and thigh). On base of the obtained results the fat percentage and the BMI were calculated. The fat percentage was measured by two methods: skinfold thickness measurements using Harpenden Caliper and bioelectrical impedance on the Omron BF500 Body Composition scale. The sample comprised 84 female students enrolled in the first academic year in 2012./13. at the University of Osijek from the Departments of Mathematics, Chemistry and Physics. A statistically significant correlation was noticed between BMI and assessment of current body size, fat percentage and perceived body appearance as well as between the BMI and the discrepancy or dissatisfaction with the own body size.

Key words: *body image, body size dissatisfaction, BMI, fat percentage*

Introduction

The picture of one's own body, the body perception or the *body image* denotes the mental picture of one's body size, the evaluation of his/her appearance and the influence of these self-perceptions and attitudes on the behaviour of a person (Rosen, 1992). The body image perception is part of a broader construct of self image and thus the satisfaction with one's body size can considerably contribute to one's self-esteem, particularly among adolescent girls (Clay et al., 2005). In the sensible years of adolescence, the feeling girls have concerning their own body and appearance is formative important. With affective colored attitude toward one's own body, girls tie and some typical ways of behavior depending on the degree of the satisfaction with their own body and appearance in this respect. The girls inclined to frequently check how they look, to use various strategies of weight control like dieting, skipping meals as well as frequent exercising (Shisslak et al., 1998). They also often tended to changes of dressing style, all that in order to avoid the anxiety related to their appearance, or to highlight their body as an important source of pleasure to their own selves.

During their studying period female students are under immense academic and social pressure since the society nowadays emphasizes the imperative of being slim and attractive so they connect the attractive body image directly with the success in dating young men but also with success in life in general (Forestell et al., 2004). The culture we live in and imposed standards of an ideal female body size strongly affects the body selfperception especially among the young generation and consequently creates conditions for the inevitable development of dissatisfaction with the own body image. The person begins to think that he/she is too heavy, too big or rounded up and because of such a deviating appearance from the standard feels unattractive.

The dominating research findings in the field of body dissatisfaction is that most women and girls who express their dissatisfaction with the body size believe that they are overweight and keep trying to lose weight by dieting (Rosen, 1992). If such a large number of women becomes engaged in these issues, then body dissatisfaction cannot be considered a disorder but it more likely seems to be about the attitudes that have become almost normative. Body dissatisfaction significantly affects the development of many eating disorders such as anorexia, bulimia and binge eating mostly in the women population (Pokrajac-Bulian, 1998; Pokrajac-Bulian et al., 2005; Beato-Fernandez et al., 2004). The essence of the dissatisfaction with one's own body is a discrepancy between perceived and desired whether it is about our inner ideals or the ones imposed by society (Furnham and Greaves, 1994).

As one of the most common methods of assessment in measuring satisfaction or dissatisfaction with one's own body the Figure Rating Scale (Stunkard, Sorenson and Schlusinger, 1983) has been constructed, and the evaluations of this scale is usually diagnosed by graphical instruments showing figure drawings and parts of it (such as belly and hips), and through questionnaires containing questions on body weight and other aspects concerning the level of body image acceptance (Stice and Beaman, 2001). The Figure Rating Scale (Stunkard et al., 1983) was mainly linked to one

anthropometric variable – the BMI, and its construct validation has been confirmed many times in many countries and on different populations (Bulik et al., 2001; Scagliusi et al., 2006, Rodriguez-Cano et al., 2006; McCabe et al., 2005). Considering that, there is an evident lack of researches in confirming the validation of this scale related to some other anthropometric variables.

So the goal of this study is therefore to determine the construct validity of the Figure Rating Scale (Stunkard et al., 1983) based on the estimated body size of female students in Osijek who were related to their anthropometric variables (BMI and FP) in order to describe their body size self-perception.

Three basic hypothesis have been set: 1) students with larger BMI results will identify larger figures; 2) students with a greater fat percentage will identify larger figures; 3) students who choose larger figures thus will show greater discrepancy between current and ideal body size and as well a greater dissatisfaction with their bodies.

Methods

The research sample comprised 84 female students ($M = 18,64$ years, $SD = 0,50$), 42 of whom being students at the Department of Mathematics and 42 at the Department of Physics and Chemistry of the University of Osijek and all of them enrolled in the first year of study.

The study was carried out in groups on their departments. Having completed the questionnaires, their weights and heights were measured and the skinfold measurement was taken three times in a row. All measurements were performed by experienced experts. Before the very implementation of the testing the students were explained the purpose of the research and given a brief instruction. They were also asked to give their approval in accordance to the ethical principles of scientific research implementation policy.

The *Figure Rating Scale - FRS* (Stunkard, Sorenson i Schlusinger, 1983) comprises a set of nine figures depicting women or men ranging in body size from very thin to very heavy and a scale from one (the thinnest) to nine (the heaviest). Respondents were asked to indicate which of the figures looked most like their present body shape (percieved body size) and which of the figures showed the way they would like their body to look like (ideal body size). The body size discrepancy is calculated by suptracting the percieved body size score from the ideal body size score. A negative discrepancy indicates that a participant's ideal size is smaller than her percieved body size whereas a positive discrepancy indicates that a participant's ideal size is bigger than her percieved body size. From the results can also be found out for example how realistic do students percieve their own figure, whether they overestimate or underestimate their body weight, which figure tends to be their ideal appearance and which of the students belong to risk groups of either underweight or obese.

Body height is a measure of the so-called longitudinality of the skeleton which according to previous interpretation is responsible for bone growth in length, in this study was measured by an anthropometre within an accuracy of 0.1 cm.

Body weight is a measure used to estimate the general body mass and was in this study performed by the Omron BF500 Body Composition within an accuracy of 0.1 kg. By this same instrument also the amount of fat was calculated (FPOMR) according to the method of bioelectrical impedancy.

On base of the participants' both body height and weight data the body mass index (BMI) was calculated. The BMI is a measure that helps to determine whether a person is underweight, normal, overweight or obese. It is calculated as the weight in kilogramms divided by the height in meters squared. A BMI value less than 17.5 indicates an extreme underweight and a BMI value lower than 18.5 increases the probability of negative malnutrition consequences whereas the normal BMI values range between 20.0 and 24.9. On the other hand a BMI value between 25.0 - 29.9 indicates overweight and the one above 30 indicates obesity (Pokrajac-Bulian et al., 2005).

Skinfold measurement was performed according to International Biological Programme (IBP) on three site system (triceps, suprailiac and thigh) using the Harpenden caliper with an accuracy of 0.2 mm. The applied equation for determining the body density, based on the sum of three skinfold measurements (Jackson and Pollock, 1985). The resulting value of body density is being included into the Siri equation to calculate body fat (1956, according to Mišigoj-Durakovic, 2008) and is most frequently used to determine fat percentage based on the known density of one's body.

Results and discussion

The results aquired showed that the female students in a percentage of 64.3 express even a slight dissatisfaction with their body and wishes to reduce their weight; only 26.2% of the girls are satisfied with their weight and only 9.5% wants to gain weight. Markland (2009) recieved similar results on a sample of adult women where 74.8% of them gave a negative discrepancy, with 20.5% there was no discrepance and only 4.7% of those women wanted to gain weight. Pokrajac-Bulian (2005) got her results on a sample of female students of the University in Rijeka ($N=73$): 55.5% female students want to be slimmer and only 5.6% of them wanted to gain weight.

Table 1. shows arithmetic means, standard deviations and correlations of the measured variables. The present body image the students picked on average equaled the figure 4 on the scale whereas the ideal picked body size on average responded to figure 3 on the scale. From the previous two data the discrepancy or the index of deviation was calculated

from which is visible that most students tend to the ideal figure being one or two figures less (discrepancy=-0.64) and only seven students identified the negative discrepancy being two figures less. The highest correlation between the discrepancy and the other variables was shown by the variable current body size ($r=-.69$, $p<.05$) which means that the students who picked the bigger figures of their current body size are at the same time the less satisfied.

For the evaluation of the construct validity of the figure drawing scale (*Figure Rating Scale* – FRS; Stunkard, Sorenson i Schlusinger, 1983.) and the answer to the first hypothesis in the research – the one that the students with a higher BMI will choose bigger figures on the scale we analysed the results of the variable BMI in correlation with variable FRS-CBS (estimating the students' current body size perception) and came to a significant positive correlation of $r=0.69$ confirming the first hypothesis.

Both of the fat percentage measures (FPOMR and FPHAR) being for the first time compared with the image stimulations showed also high correlations with the variable of the students' current body size ($r=0.67$ and $r=0.66$, $p<0.05$) which confirmed the second hypothesis of the research.

As expected the BMI is statistically significantly related to the variables of body weight ($r=.87$, $p<.05$), fat percentage ($r=.88$, $r=.76$ $p<.05$) and the discrepancy ($r=-0.57$, $p<0.05$) from which can be drawn that the participants of a higher BMI have a greater body weight and more fat percentage and are thus less satisfied with their body image. High correlations are received between the discrepancy values and new anthropometric variables for fat percentage used in this study ($r=-.58$, $r=-.59$ $p<.05$). This confirms the third hypothesis and can be a confirmation for the construct validity of the *Figure Rating Scale* being applied the same on the student population.

Except for the relations to BMI that were most frequently compared in such researches (Wertheim et al., 2004; Bulik et al., 2001; Scagliusi et al., 2006) the scale was used in relation with different eating disorders such as bulimia symptoms (Pokrajac-Bulian, 1998), appliance of diets and binge eating (Zakin,1989) and as well sexual attractiveness (Tovee et al., 1998).

Table 1: Means, standard deviations and correlations among the variables (N=84)

	M	SD	BH	BW	BMI	FPHAR	FPOMR	FRS-CBS	FRS-IBS	DISK
BH	167.30	67.08	1.00							
BW	6.17	9.87	0.49	1.00						
BMI	22.02	3.18	0.01	0.87	1.00					
FPHAR	27.33	6.60	-0.07	0.63	0.76	1.00				
FPOMR	30.47	5.60	-0.05	0.74	0.88	0.84	1.00			
FRS-CBS	4.11	1.14	-0.15	0.53	0.69	0.67	0.66	1.00		
FRS-IBS	3.46	0.83	-0.09	0.31	0.40	0.38	0.35	0.72	1.00	
DISK	-0.64	0.78	0.12	-0.45	-0.57	-0.58	-0.59	-0.69	0.00	1.00

Legend: M-arit.mean, SD-std. deviation, BH-body height, BW-body weight, BMI-body mass index, FPHAR-fat percentage using Harpenden caliper, FPOMR-fat percentage using OMRON scale, FRS-CBS-perceived current body size on FRS, FRS-IBS- perceived ideal body size on FRS, DISK- discrepancy between current and ideal body size

Table 2. presents mean values of variables selected according to each figure of current body image perception picked. As the scale consists of 9 images ranged from the slimmest to the extreme obese the participants were also divided into 9 groups. The results show that none picked figures 1,8 and 9 thus no answer was given in that category which means that none of the students had a selfperception of being extremely slim (figure 1) nor extremely obese (figures 8 and 9). The same results have been observed in similar studies (Mahajan, 2009) where young female adolescents (9-14 yrs) have none denoted their image according to figure 1 as well as to no figure higher than 6 on the scale.

Furthermore, only three participants perceived their image according to each figure 2 and 7 what caused a great dispersion of results and a bigger mistake in the average value of the belonging BMI. Most students find themselves in group 3-6 which is in accordance to normal body weight value (CDC, 2007) the BMI being between 20.0-25.0. Comparing this study with the representative one (Bulik i sur., 2001) done on a sample of 3069 young women at age of 18-30 there can certain similarities be found in choosing figures 2,3,4 but from figure 5 onwards the difference becomes significantly bigger (Table 2). Such differences can be attributed on the limitations of Bulik's research that could be due to the fact that the participants of that study e-mailed the values of their height and weight and couldn't be properly controlled. The participants were also of a higher age than the student sample in the current study ($M=18.76$), so the differences in weight which on average rises progressively with age can also be taken in consideration. Thus the difference in number between the participants of both studies could also be a possible reason for a diverse distribution of estimations in the given categories.

As for the result in given variables of fat percentage there is an obvious difference between the applied methods: the bioelectrical impedancy on the Omron BF500 Body Composition scale shows higher values (0.90-6.83%) than the skinfold thickness measurements by Harpenden's Caliper, which has proved itself a more reliable, available and widespread method at the present and has also the greatest correlation with hydrostatic weighing measurement $r=0.85$ (Jackson i Pollock, 1985). The correlation between the two variables shows a high $r=0.84$, $p<0.05$. Based on the criterium that with women the index of obesity is above 30 (Mišigoj-Duraković et al., 1999) we would get totally different results and conclusions by applying solely this measurement technique than by applying BMI. In that case 27 students of this sample (all who estimated their appearance according to figures 5 onward) would be considered obese. Figures 3 and 4 would be considered as average values of body fat percentage, whereas figure 2 would denote ideal values. There is a clear linear trend with all variables where the groups don't overlap in neither of the results given.

Table 2: Anthropometric variables averages for each drawing in FRS.

Figures	1	2	3	4	5	6	7	8	9
N	-	3	25	29	17	7	3	-	-
BW		56.8	57.3	60.3	64.1	70.6	83.4		
FPOMR		25.7	26.7	30.3	32.5	35.9	43.8		
FP HAR		18.9	22.7	27.2	31.6	32.3	39.8		
BMI		19.4	20.1	21.6	23.2	24.7	31.7		
BMI (Bulik i sur., 2001)	17.8	18.8	20.3	22.6	26.4	31.3	36.7	40.8	44.1

Legend: BW-body weight, BMI-body mass index, FP HAR-fat percentage using Harpenden caliper, FPOMR- fat percentage using OMRON scale, 1-9 number of drawings on FRS

Conclusion

This study analysed the construct validity of the Figure Rating Scale (Stunkard, Sorenson and Schlusinger, 1983) on estimated body size selfperception on female students at the University of Osijek. All three established hypotheses have been confirmed: a positive high correlation between current body size (FRS-CBS) and BMI was proved; a positive high correlation between the current body size (FRS-CBS) and the variables denoting fat percentage (FPOMR and FP HAR) was found out; also a greater level of dissatisfaction with their own body image of the students with a higher BMI was noticed.

According to the BMI results only one of the students showed extremely underweight ($BMI < 17.5$) and two of the students can be considered obese ($BMI > 30.0$) what makes the results on this sample very satisfying. However, 27 of the students show a BMI between 25.0 and 30.0 which can be considered a result worth worrying.

The greatest contributing result of the research is that the Figure Rating Scale (Stunkard, Sorenson and Schlusinger, 1983) this time correlated with another anthropometric variable – the fat percentage giving way more precise and reliable information about the body composition than merely the BMI which cannot reliably estimate the person's physical constitution, whereas the two methods of measuring skinfold thickness can more or less find out about the body composition, the difference between body fat and the lean body mass.

Finally, from the aspect of construct validity, on base of the obtained results that showed a considerably high correlation of selfestimated body image on the Figure Rating Scale and other methods by which the body appearance is estimated in respect to medical standards, it is possible to conclude that this scale is a valid instrument in estimating the level of satisfaction with one's own body, despite of the fact that it is about one's own and individual experience of his/her body. The results showed that the selfperceptions of the participants are in correlation to the objective indicators their body appearance.

References

1. Beato-Fernández, L., Rodriguez-Cano, T., Belmonte-Llario, A., and Martinez-Delgado, C. (2004). Risk factors for eating disorders in adolescents: A Spanish community-based longitudinal study. *European Child and Adolescent Psychiatry*, 13, 287-294.
2. Bulik, C. M., Wade, T. D., Heath, A. C., Ng, M., Stunkard, A. J., i Eaves, L. J. (2001). Relating body mass index to figural stimuli: Population-based normative data for Caucasians. *International Journal of Obesity*, 25, 1117-1524.
3. Center of Disease Control (CDC). (2007). *BMI- Body Mass Index*.
4. Available at <http://www.cdc.gov/nccdphp/dnpa/healthyweight/assessing/bmi/>
5. Clay, D., Vignole, L.V., Dittmar, H. (2005). Body Image and Self-Esteem Among Adolescent Girls: Testing the Influence of Sociocultural Factors. *Journal of Research on Adolescence*, 15(4), 451-477.

6. Forestell, C.A., Humphrey, T.M., and Stewart, S.H. (2004). Involvement of body weight and shape factors in ratings of attractiveness by women: a replication and extension of Tassinary and Hansen. *Personality and Individual Differences*, 36, 295-305
7. Furnham, A. and Greaves, N. (1994). Gender and locus of control correlates of body image dissatisfaction. *European Journal of Personality*, 8, 183-200.
8. Mahajan, A.Y.(2009). Comparing self and others' perceptions of adolescent girls' body size figural stimuli and 3D body scans. (Master thesis). Alabama: Auburn.
9. Markland, D. (2009). The mediating role of behavioural regulations in the relationship between perceived body size discrepancies and physical activity among adult women. *Hellenic Journal of Psychology*, 6, 169-182.
10. McCabe, M.P., Ricciardelli, L.A. (2005). A prospective study of pressures from parents, peers, and the media on extreme weight change behaviors among adolescent boys and girls. *Behaviour Research and Therapy*, 43, 653-668.
11. Mišigoj-Duraković, M. (2008). Kinanthropology - biological aspects of physical exercise. Zagreb: Faculty of kinesiology. University in Zagreb.
12. Pokrajac-Bulian, A. (1998). Dissatisfaction with body and bulimic symptoms in the student population. *Društvena istraživanja*, 36-37, 581-601
13. Pokrajac-Bulian, A., Živčić-Bećirević, I., Vukmanović, S., and Forbes, G. (2005). Body dissatisfaction and eating habits in college students and their mothers. *Psihologijske teme*, 14 (1), 57-70.
14. Rodriguez-Cano, T., Beato-Fernández, L., Llarío, A.B. (2006). Body dissatisfaction as a predictor of self-reported suicide attempts in adolescents: A Spanish community prospective study. *The Journal of Adolescent Health*, 38, 684-688.
15. Rosen, J.C. (1992). Body-image disorder Definition, development, and contribution to eating disorders. In: J.H. Crowther, D.L. Tennenbaum, S.E. Hobfoll and M.A. Parris Stephens (Eds.), *The Etiology of Bulimia Nervosa: The Individual and Familial Context* (157-177). Washington: Hemisphere Publishing Corporation.
16. Scagliusi, F.B., Alvarenga, M., Polacow, V.O., Cordás, T.A., Queiroz, G.K.O., Coelho, D., Philippi, S.T., and Lancha, A.H. Jr (2006). Concurrent and discriminate validity of the Stunkard's figure rating scale adapted into Portuguese. *Appetite*, 47,77-82.
17. Stice, E., and Bearman, S.K. (2001). Body image and eating disturbances prospectively predict increases in depressive symptoms in adolescent girls: a growth curve analysis. *Developmental Psychology*, 37, 597-607.
18. Stunkard, A., Sørensen, T., and Schulsinger, F. (1983). Use of the Danish Adoption Register for the study of obesity and thinness. In: S. Kety, L. Roland, R. Sidman i S.Matthysse (eds), *The genetics of neurological and psychiatric disorders*. New York: Raven Press
19. Tovee, M. J., Reinhardt, S., Emery, J. L., & Cornelissen, P. L. (1998). Optimal BMI and Maximal sexual attractiveness. *The Lancet*, 352, 548
20. Zakin, D. F. (1989). Eating disturbance, emotional separation, and body image. *International Journal of Eating Disorders*, 8, 411-416.

PHYSICAL ACTIVITY BEHAVIORS AMONG UNIVERSITY STUDENTS

Sanja Ćurković¹, Mirna Andrijašević² and Romana Caput-Jogunica¹

¹Faculty of Agriculture, University of Zagreb, Croatia

²Faculty of Kinesiology, University of Zagreb, Croatia

Abstract

Despite the well documented benefits of an active lifestyle, lack of physical activity is a significant health problem in university students. The aim of this study was to determine the attitude towards physical activity through previous involvement in sport, recreational activity, preferences of activities at different levels of engagement. Also, it will explore the differences in engagement in kinesiological activities of student population by sex and age. The results indicate a significant reduction in engagement in kinesiological activities during the transition from high school to university and lack of physical activity in daily life. Results show a statistically significant difference in engagement in kinesiological activities with regard to gender but not age.

Key words: *physical activity, university students, sport, motivation*

Introduction

The benefits of a physically active lifestyle are well documented and can lead to improvements of physiological and psychological health (Jeffrey, 2010). PA provides positive effects on mental health and mood such as reduced depression and anxiety, positive well-being, enhance vigor, and better cognitive function (Centers for Disease Control, 2011, Guven et al 2013). Studies regarding the physical activity behaviours of university students found approximately 35% to 75% of students fail to obtain the recommended amount of physical activity. PA participation statistics indicate a significant decline in physical activity in the 18-24 year old age group (Jeffrey, 2010, Gomez-Lopez, 2010). A critical point in the decline of PA rates appears to be happening when young people transition from high school (adolescence) to university (young adults) (Bray, 2007, Ćurković, 2010, Kwan and Faulkner, 2011). Reasons for this decline in physical activity may be due to the pressure on university students to perform well academically and a decline participation in sports activity. Another plausible reason for the decline is due to the limited number of physical activity intervention tailored to meet the needs of young adults (Keating, 2005, Han, 2008).

The decline in physical activity in young adults is a particularly disturbing trend because many adult health behaviours are established during the study years. Thus, further research is needed to investigate how to increase university students' physical activity levels. The first step in the process of increasing physical activity levels is to gain knowledge about university students' physical activity patterns and key physical activity determinants (Keating, 2005, Gomez-Lopez, 2010). Knowledge and understanding university students' PA behavior and its determinants can provide a fundamental basis for changing their physical activity and improving the overall health of this population (Gokee-LaRose et al., 2009).

The aim of this study was to determine the attitude toward physical activity through previous involvement in sport, recreational activity, preferences of activities at different levels of engagement. Also, it will explore the differences in engagement activities in kinesiology student population by sex and age.

Methods

The representative sample was composed of 1651 students from the University of Zagreb (Croatia) of whom 745 were male and 906 female. Sample selection followed a stratified multistage sampling procedure with proportional allocation. Due to the socio-cultural environment in which we live and the specifics of the student population it was not possible to fully use previous questionnaires in the world. We decided to construct a new measuring instrument that would be closer to the Croatian living conditions, and the instrument is based on current scientific knowledge. Gathering of the data was carried out by means of the anonymous Questionnaire consisting of 52 questions including: levels of physical activity, the main reasons for not participating in physical activity, preferences of different sports and recreational activities, involvement in PA in the last week and month. Data analysis was performed with the Statistica 7.1 (StatSoft, Inc., 2006) and SAS 8.0 (SAS, 1999).

Results

The study included a total of 1651 students (745 male and 906 female students). By age, in the sample was the majority of students aged 19-22 years old (88.5%). Percentage of older students in the sample was 11.4%, while the percentage of youngest students (18 years) was only 1% of this sample.

Broken down by year of study enrolled, the study included mostly students from the first year (35%), third year (27.2%) and second year (23.4%). The older students were represented by 14.4% of students. In terms of location and size of the village most of the students of this sample are from the City of Zagreb (38.7%), 34.6% of students come from small towns (up to 20,000 inhabitants). Then, 12.9% came from towns up to 50,000 inhabitants, 15% from cities up to 300,000 inhabitants.

Based on the analysis of the entire area of engagement in kinesiological activities we can say that 8.7% of students have never engaged in sports at any level. χ^2 analysis shows gender differences noting that the majority of female students had never been involved in kinesiological activities.

As for the reasons most often are stated that they have no interest in sport and that in their hometown it was not possible to engage in the desired sport.

58.8% of students participated exclusively in recreational forms of kinesiological activities. Male students ($<.0001$) compared to female students, were significantly more involved in following activities: football (13.65% students; 2.12% students), basketball (8.90% versus 3.88%) and table tennis (8.73% versus 4.53%). Female students are much more involved in cycling (23.44% vs. 13.39%), roller-skating (11.03% vs. 3.2%), volleyball (9.51% vs. 4.40%), dance (17.08% vs. 2.84%), aerobics (16.09% vs. 1.88%) and badminton (8.72% vs. 3.02%). Differences by age showed no statistical significance. Examination of the recreational activities in which the students have participated several times in the last month shows that they have mostly done bike riding, running in nature, playing volleyball and have participated in aerobics and dance.

In the examined sample was 32.4% of students who are actively involved in sports, of which 20% competed at the regional level, and 12.4% participated in the national and international level. χ^2 analysis showed a statistically significant difference noting that significantly more male students participate in sports (20.77% male vs. 11.38% female students).

An analysis of previous engagements in kinesiological activities shows that most kids were included into sport at 8 and 9 years of age (13.4%) and between 10 and 11 years of age (9.4%). Their weekly engagement was between three days and each day, and the training lasted between one and two hours (18.8%) and 2-3 hours (10.7%). However, the research of the sport shows that the initial rise from sport happens at the age of 13-14 years (3.0%), from 15 to 16 years of age that number had increased to 9.0%, and at 17 years of age 16.2% of young athletes rose from sport. Overall, by the enrollment at a university 28.2% of surveyed students have given up on sports, showing that by enrollment in university below 5% of students (4.2%) remain in sports. Students have cited common reasons for discontinuation of active participation in sport are the impossibility of harmonizing school and sporting commitments (9.2%), injuries (8.1%) and inadequate training periods (6.4%).

Engagement in kinesiological activities in the last month shows that 9.3% of students did not participate in any form of activity. 70.5% were not engaged sufficiently while only 20.2% of students were active at the recommended level (at least three times a week for a minimum of 30 minutes). Weekly involvement gives similar results provided that the increased number of students in this week did not participate in any form of activity (17.7%).

Logistic regression analysis shows that according to the Wald criteria, there are two predictors associated with the sex of respondents: current activity and weekly activity. From the signs of regression coefficients (B) and changes in the ratio of probabilities that the respondent is male (OR), we can conclude that men had significantly higher scores compared to female students.

Table 1: Comparison of a model with and without predictor

		Hi2	df	P
Model 1	Model	105,311	3	,000
	Blok	105,311	3	,000
	Model	105,311	3	,000

Table 2: Forecasting power of the model

Forecasting power of the model			
Model 1	-2 Log likelihood	Cox & Snell R2	Nagelkerke R2
	2161,722 ^a	,062	,083

Table 3 shows the regression coefficients (B) with a standard error and statistical significance (Wald), as well as changes in the ratio of probabilities that the respondent is male (OR).

Tablica 3: Logistic regression analysis of the association of sex differences and sporting activities

		B	St. pog.	Wald	df	P	OR
Model 1 ^a	DOSADAK	+,420	,062	45,759	1	,000	1,522
	AKTIMJE	,064	,075	,731	1	,393	1,066
	AKTITJE	+,154	,062	6,206	1	,013	1,167
	Constant	-1,807	,177	104,073	1	,000	,164

From the attached it can be concluded that *current activity* is the best independent predictor of sex. On the basis of the analysis it showed that age was not significantly associated with measures of sporting activities ($R^2 = .004$, $F(3,1640) = 2.176$, $p > .05$). According to the results, no single measure of sporting activities is a statistically significant predictor of age.

Discussion

The results are consistent with previously conducted research that highlight the high percentages of inactivity or low activity in the population of students around the world (Keating et al., 2005; Reed, 2006th, Seo et al., 2007, Han et al., 2008, Wengreen and Moncur, 2009), stating that 40% to 70% of inactive students, especially female students, are depending on the socio-cultural environment in which they live.

Research of Nelson and colleagues (2007), Gook-LaRose and Wing, (2009), Jeffrey, (2011) indicates that in the period of transition from high school to university was observed a large leak in the number of people engaged in kinesiological activities, which was also observed in Croatian students. The results indicate the importance of motivating young people to continue in the programs of physical activity (Curkovic, 2010, Guven et al., 2013). The reasons for this are numerous. On one hand, health care, maintaining physical and mental fitness, improving satisfaction and self-actualization, on the other hand to prevent obesity and various diseases that arise as a result of unhealthy eating habits and no movement. Given that students are exposed to a number of social conditions and norms of behaviour, higher education institutions have a special environment in which it is possible to promote an active lifestyle through physical activity and affect the consciousness of a large number of students.

Miller and colleagues (2005) suggest that the gender is one of the better predictors when it comes to participation in sports. The reason is that men are significantly more involved in sports than women and that we reaffirm with our research. Everything that is tied to active participation in sports (daily and weekly engagement) is tied to the male population. About participation in recreational activities literature gives inconsistent results. Some claim that significantly more male students participate in recreational activities, and another that it applies to female students. Our results show that female students (37.3%) are more prone to recreational form of kinesiological activity compared to male students (21.5%). Read and Philips (2005) and Seo and colleagues (2007) had similar results. Individual preferences of kinesiology content are an important factor in motivating students to participate in kinesiological activities (Martin, 2008). Male students prefer and are more involved in kinesiological activities such as football, basketball and table tennis. Female students are more involved in cycling, roller-skating, volleyball, dance, aerobics and badminton. To similar results have come Buckwort and Nigg (2004), Gomez-Lopez (2010) stating that male students prefer team sports and lifting, while the female students are more interested in programs such as aerobics, dancing, cycling, etc.

An analysis of difference in engagement in kinesiological activities by age in our study did not show a statistically significant difference, which is not in accordance with earlier conducted studies. The Read and Phillips (2005), Garman and colleagues (2004) studies showed that younger students are more active than their older colleagues. As teaching of physical education is mandatory in the first two years of university, it was expected there, that these differences would be visible through the age of the respondents. It is possible that we did not get the difference in participation in kinesiological activities by age because a part of the older students is enrolled in the first or second year of college.

Conclusion

Results of the study indicate the importance of educating adolescent population to adopt a healthy lifestyle. Research in the young population, especially in the student population constantly stress the need for changes in behaviour, especially towards physical activity and eating habits. The above stated behaviours are featured in all relevant documents and action plans around the world when it comes to young people and their behaviour towards health. Universities, as well as teachers in charge of classes and sports in higher education should continuously monitor the preferences of students in kinesiological activities in order to create better motivational kinesiology programs for students. There is a need for better cooperation with the Ministry of Science, Education and Sport, COC, Croatian National Institute of Public Health, sports federations and all departments of the University who take care of the students in order to create conditions so student athletes can achieve their athletic and academic careers. For other students there is a need to find better motivational factors that

would enhance the greater involvement of the student population in kinesiology programs both within PE classes and in their spare time, as an essential prerequisite for changing behavior and adopting a healthy lifestyle.

References

1. Bray, S.R. (2007). Self-efficacy for coping with barriers helps students stay physically active during transition to first year university. *Research Quarterly for Exercise and Sport*, 78, 61-70..
2. Buckworth, J., & Nigg, C. (2004). Physical activity, exercise and sedentary behavior in college students. *Journal of American College Health*, 53, 28-34.
3. Center for Disease Control and Prevention (2011). Physical activity for everyone. Retrieved from <http://www.cdc.gov/physicalactivity/everyone/guidelines/inex.html>
4. Ćurković, S. (2010). Tjelesna aktivnost i rizična ponašanja studenata. Disertacija, Sveučilište u Zagrebu Kineziološki fakultet.
5. Gokee-LaRose, J., Gorin, A. Wing, R. (2009). Behavioral self-regulation for weight loss in young adults: A randomized controlled trial. *Int J Behav Nutrition and PA*, 6, 10-19.
6. Gomez-Lopez, M. Gallegos, G.A., Extremera, B.A. (2010). Perceived barriers by university students in the practice of physical activities. *Journal of Sports Science and Medicine*, 9 , 374-381.
7. Guven, D.S., Ozcan, A., Tasgin, O. Arslan, F. (2013). The relationship between health college students' physical activity status and life satisfaction. *International Journal of Academic Research*, vol.5 327-331.
8. Han, J.L., Hull, M.K., Randall, N.B. Heesch: Fields, D. (2008). Changes in women's physical activity during transition to college. *Am J H Educ*, 39, 194-199.
9. Jeffrey, P. (2010). Physical activity behaviors, motivation and self-efficacy among college students. *College Students Journal*, 64-74.
10. Keating, D.X., Guan, J., Pinero, H.C., Bridges, D.M. (2005.) A meta-analysis of College Students Physical Activity Behaviors. *Journal of American College Health*, 54, (2), 116-125.
11. Kwan, M., Faulkner, G. (2011). Perceptions and barriers to physical activity during the transition to university. *Am. J. of Health Studies* 26(2), 87-96.
12. Martin, A.J. (2008). Enhancing student motivation and engagement: the effects of a multidimensional intervention. *Contemporary Educational Psychology*, 33 , 239-269.
13. Read, J.A., Phillips, D.A. (2005). Relationships between physical activity and the proximity of exercise facilities and home exercise equipment utilized by undergraduate university students. *Journal of American College Health*, 53(6), 285-290.
14. Seo, D. C., Nehl, E. N., Agle, J., Ma, S. (2007). Relations between physical activity and behavioral and perceptual correlates among midwestern college students. *Journal of American College Health*, 56(2), 187 -197. .
15. Wengreen, H. Moncur, C. (2009). Change in diet, physical activity and body weight among young adults during the transition from high school to college. *Nutrition Journal*, 8, 32-42.

MOTIVATIONAL CHARACTERISTICS OF LITHUANIAN STUDENTS' IN PHYSICAL EDUCATION

Stanislav Dadelo

Vilnius Gediminas Technical University, Lithuania

Abstract

In order to work out an efficacious health-educating system it is urgent to inquire into the characteristics of students' views on physical education, particularly, of the students who choose the physical education curriculum and the students who don't. Purpose of this research is to determine the characteristics of views on physical education held by students who choose and who do not choose physical education curriculum. The people who chose physical education module and who didn't, have appraised physical education measures applied at school differently; their motives for going in for sports are different. Because the lack of time is a large portion of students wish that physical education exercises would be organized by including them into the academic time table. Differences determined between groups under study encourage the many-sided development of the physical education process landmarks at school.

Key words: physical education curriculum, reason, choice

Introduction

The process of personal behaviour formation is based on incentives and appraisals by programming and controlling the behaviour of a trainee (Robertson, 2013). Determined by the European standards and the democracy development, changes in the Lithuanian education system prompted the rejection of a part of obligatory non-profile study subjects. Many higher schools in Lithuania give their students a chance to choose non-profile curriculum, including the physical education curriculum and the healthy living curriculum, independently. The state has delegated the issue of young people's health to its citizens. It is believed that the progressive part of future society (students) will be able to develop a need for physical activity all by itself. In order to work out an efficacious health-educating system it is urgent to inquire into the characteristics of students' views on physical education, particularly, of the students who choose the physical education curriculum and the students who don't. Purpose of this research is to determine the characteristics of views on physical education held by students who choose and who do not choose physical education curriculum.

Methods

Subject of the research: Vilnius Gediminas Technical University (VGTU) bachelor degree study 20-22 year old students (boys), group 1 (n=348) consisting of students who have chosen the physical education curriculum, group 2 (n=224) – students who have not chosen physical education curriculum. Object of the research: views on and relation with physical education demonstrated by VGTU students who have and who haven't chosen physical education models. Suggested hypothesis of the research – it will show the distinctive characteristics of the view on and relation with physical education demonstrated by VGTU students who have and who have not chosen the physical education curriculum; this will facilitate more efficacious organisation and optimisation of the study process, influencing favourably the physical activity of students and helping to develop a need for systematic physical activity, and improving students' health. Research was performed in 2012/13 academic year, during the second term. Participants were selected by means of a random selection method. Survey was carried out observing the principles of participants' anonymity, information about the research purpose and progress. The method of a questionnaire-type written survey was applied. An approved variant of a modified questionnaire was used (Poteliūnienė et al., 2003). The questionnaire consisted of 11 questions with supplied possible answer options. Part of the questions were closed-type ones (it is possible to choose only one of the supplied answer options), part of the questions was open-type ones (it is possible to choose several of the supplied answer options and to suggest one's own answer variant). Significance of the data distribution difference was checked by calculating χ^2 .

Results

VGTU students who had chosen physical education curriculum at the university were more enthusiastic about their physical education training at school ($\chi^2=5.240$; $p<0.05$). Physical education measures applied at school were regarded with pleasure by 84% of students who had chosen the curriculum, and only by 56% of students who had not chosen the

physical education curriculum. Good teachers (27%) and a good sports basis (17%) may account for the positive appraisal of physical training at school. The greatest difference between the groups under study was determined in the appraisal of these factors ($p < 0.05$) (table 1). Appraisal of school teachers' contribution to the learning of physical education measures as reflected in the responses given by groups under study revealed essential differences between students (table 2), 55% of students who chose physical training curriculum stated that their physical education teacher had taught them sufficiently well to do their morning exercises independently, 53% indicated that their teacher had taught them sufficiently well to train independently (table 3), 87% stressed that they had sufficient knowledge and skills to go in for sports methodically. However the greater part of students who had not chosen physical education curriculum stated that their physical education teacher had failed to teach them at school to do their morning exercises independently (54%), had failed to teach them to train independently (45%), and upon completion of their school they did not have any clue about how to go in for sports methodically (52%). Essential difference in opinions expressed by the surveyed student groups about the quality of physical training at school was observed ($p < 0.05$).

Students who choose physical education at the university give higher evaluations to the results of physical education process at school, stressing the influence of their physical education teacher, high quality sports basis and stock on their motivation, knowledge, abilities and skills for systematic application of physical activity. Poorer appraisal of one's own skills and knowledge about physical education is reflected also in the indicators of independent engagement in sports activities. Group 2 students go in for sports at the university less readily. 45% of students belonging to group 1 state that they go in for sports independently at least 4 hours per week, however only 29% of group 2 students allot 4 hours or more time for independent sports activities per week ($\chi^2 = 14.100$; $p < 0.05$). It must be noted that the portion of students who acquired at school a sufficient stock of knowledge and skills concerning correct going in for sports and doing one's morning exercises is proximate to the portion of students who train actively on a systematic basis. The analysis of causes determining the willingness to engage in sports independently or to attend organised training courses shows (table 4) that the basic reason articulated by students who have chosen physical education curriculum is the wish to become physically strong (30%), the rate of such students among those who have not chosen physical education curriculum was only 16% ($\chi^2 = 39.000$; $p < 0.05$). The basic motive for going in for sports among students who have not chosen physical education curriculum is the willingness to have a beautiful body – 26% responses, the rate of such students among those who have chosen physical education curriculum was only 15% ($\chi^2 = 9.860$; $p < 0.05$). A substantial part of students (those who have chosen – 13%, those who have not – 14%) state that their basic reason for going in for sports is the wish to strengthen their health and to eliminate the shortcomings of their physical development. Physical activity as a means helping to restore spiritual powers after intensive mental work was specified by 15% of students who have chosen and 12% of students who have not chosen physical education curriculum. A very small rate of individuals seeking for high results in sports was found among students (students who have chosen – 7%, students who have not chosen – 5%). The basic motive for not choosing physical education curriculum provided by students who have not chosen them is having not time – 42%. Physical activity is not a priority on the value scale of this group of participants. Essential differences were determined in the wishes for the status of physical education subject at the university (table 5). 49% of students who have chosen physical education curriculum at the university wish that physical education has the status of an obligatory subject, yet the rate of individuals wishing this among the students who have not chosen physical education curriculum is only 28% ($\chi^2 = 23.320$; $p < 0.05$).

Discussion

Higher school is entered by youth with attitudes, beliefs, motives, knowledge, skills and behaviour characteristics formed at school. This influences the further style of living, and psychophysical development (Fisher et al., 2013). Physical education training exercises produce favourable influence on physical health and the development of psychosocial health, for this reason the significance of physical activity does not become smaller at the higher school. It is important to form a need for active physical exercise. Physical education helps to recover after intensive mental work (Toker, Biron, 2012), and systematic physical loads activate the physiological functions of the organism (Nijs et al., 2011) and psychosocial condition (Ajay, 2011). Student groups appraise the physical education process at school differently. Students who had chosen physical education curriculum at the university were much more enthusiastic about physical education at school compared to students who had not chosen physical education curriculum. This is also connected with their relatively poorer physical activity. The role of physical education teachers in the area of physical activity promotion at school is important, however, teachers make little effort in teaching students to train independently, in imparting necessary theoretical knowledge, and forming special motor skills. Having entered a higher school at which organised obligatory training is missing youth is compelled to adapt to new conditions, and search for the ways of independent physical activity. However a big portion of students do not have sufficient knowledge, skills and abilities necessary for a smooth process of physical self-education, although such abilities, skills and knowledge ought to be formed at school. Following the introduction of essential changes in higher education, physical education subjects have become free-elective ones. Within our society, an opinion that the principles of democracy will help to optimize studies by students' needs is promoted. Individualised approach to learning is more likely if the student possesses abilities and motivation for independent learning as well as abilities and motivation

for controlling the education process (Gettinger, Seibert, 2002). The research shows that students who have more skills and knowledge on the physical activity issues are more physically active in their independent exercise, choosing study subjects which are related with physical activity more often. At the same time it must be noted that more physically active students wish to have more obligatory physical training. The most common reason given by students for not choosing physical education exercise is lack of time. Also, physically more active students, compared to less active ones, differed in terms of their motivation for going in for sports. Knowledge about physical education is related with students' desire for physical power; however, inadequate knowledge about physical education is related with the elaboration of their body image. Smooth development of physiological processes of the human organism determines the efficacy of personal functioning in all areas of life (Sirgy, 2012). In order to achieve optimal study results, it is necessary to manage the study process so that students can develop skills necessary for their self-development, to form a need for going in for sports in leisure time and encourage students to seek for sports (Dadelo, 2011). In order to make physical activity education, as a basis for healthy style of living, an efficacious tool in the study system, it is necessary to create the physical education teaching (learning) environment developing communication, independence and critical thinking (Liubicich et al., 2012). Efficacious teaching (learning) process necessarily demands adequate choice of modern teaching methods, application of new teaching forms which modify the process of education and boost students' activity.

Conclusions

The people who chose physical education module and who didn't, have appraised physical education measures applied at school differently; their motives for going in for sports are different. Because the lack of time is a large portion of students wish that physical education exercises would be organized by including them into the academic time table. Differences determined between groups under study encourage the many-sided development of the physical education process landmarks at school. It is necessary to create two-direction of physical education study programmes: oriented to students avoiding the choice of physical education subjects and wishing to be physically active in the study process. The research showed that views on physical education and physical activity formed at school remain alive during the study period and probably after.

Table 1: View on physical education at school by the students who have chosen physical education curriculum and the ones who haven't

Did you like the physical education subject at school?		Chosen	Not chosen	χ^2 and p values
1. Liked	n	261	125	$\chi^2=51.240$ $p<0.05$
	%	84	56	
2. Did not like	n	50	99	
	%	16	44	
In total	n	311	224	
	%	100	100	
If you liked the physical education subject, please, specify why?		Chosen	Not chosen	χ^2 and p values
1. No answer	n	52	52	$\chi^2=2.760$ $p=0.0968$
	%	15	20	
2. Good teachers	n	94	44	$\chi^2=8.830$ $p<0.05$
	%	27	17	
3. Good programme	n	66	36	$\chi^2=2.730$ $p=0.0988$
	%	19	14	
4. Good sports basis, stock	n	59	26	$\chi^2=5.900$ $p<0.05$
	%	17	10	
5. Other	n	77	101	$\chi^2=20.390$ $p<0.05$
	%	22	39	
In total		n	348	259

Table 2: Appraisal of physical education teacher's efforts to teach morning exercises at school by the students who have chosen physical education curriculum and the ones who haven't

Did your physical education teacher teach you to do your morning exercises independently?		Chosen	Not chosen	χ^2 and p values
1. Did not teach	n	63	121	$\chi^2=65.770$ $p<0.05$
	%	20	54	
2. Taught insufficiently	n	76	46	$\chi^2=1.130$ $p=0.2886$
	%	24	21	
3. Taught sufficiently well	n	172	57	$\chi^2=47.420$ $p<0.05$
	%	55	25	
In total	n	311	224	

Table 3: Appraisal of physical education teacher's efforts to teach to train independently at school by the students who have chosen physical education curriculum and the ones who haven't

Did your physical education teacher teach you to train independently?		Chosen	Not chosen	χ^2 and p values
1. Did not teach	n	75	101	$\chi^2=25.950$ $p<0.05$
	%	24	45	
2. Taught insufficiently	n	72	54	$\chi^2=0.070$ $p=0.7971$
	%	23	24	
3. Taught sufficiently well	n	164	69	$\chi^2=25.470$ $p<0.05$
	%	53	31	
In total	n	311	224	

Table 4: Motives for going in for sports independently by the students who have chosen physical education curriculum and the ones who haven't

What particular motives determined your wish to go in for sport independently or attend organised exercise sessions?		Chosen	Not chosen	χ^2 and p values
1. No answer	n	26	12	$\chi^2=1.380$ $p=0.2394$
	%	3	2	
2. Wish to be physically strong	n	263	96	$\chi^2=39.000$ $p<0.05$
	%	30	16	
3. Wish to have a beautiful body	n	131	157	$\chi^2=9.860$ $p<0.05$
	%	15	26	
4. Wish to strengthen health and eliminate the shortcomings of physical development (posture, curved spine, etc.)	n	114	85	$\chi^2=0.330$ $p=0.5629$
	%	13	14	
5. Recover after intensive mental work	n	131	73	$\chi^2=2.500$ $p=0.1137$
	%	15	12	
6. Develop character, will power, persistence, etc.	n	105	91	$\chi^2=3.370$ $p=0.0663$
	%	12	15	
7. Wish to achieve physical and spiritual harmony	n	44	60	$\chi^2=13.150$ $p<0.05$
	%	5	10	
8. Wish to achieve high results in sports	n	61	30	$\chi^2=2.490$ $p=0.1148$
	%	7	5	
In total	n	875	604	

Table 5: Wish concerning the physical education status by the students who have chosen physical education curriculum and the ones who haven't

Would you prefer the physical education subject at the university:		Chosen	Not chosen	χ^2 and p values
1. Obligatory	n	152	63	$\chi^2=23.320$ $p<0.05$
	%	49	28	
2. Free elective	n	159	161	
	%	51	72	
In total	n	311	224	

References

1. Ajay, K. (2011). Importance of Physical Education, Games & Sports Activities. *VSRD Technical & Non-Technical Journal*, 2(11), 570-573.
2. Dadelo, S. (2011). *The effectiveness of physical education, its diagnostics as an educational factor*. Vilnius: Technika.
3. Fischer, H.F., Binting, S., Bockelbrink, A., Heusser, P., Hueck, C., Keil, T., Roll, S., Witt, C. (2013). The Effect of Attending Steiner Schools during Childhood on Health in Adulthood: A Multicentre Cross-Sectional Study. *Plos One*, 9(8), 1-14.
4. Gettinger, M., Seibert, J.K. (2002). Contributions of Study Skills to Academic Competence. *School Psychology Review*, 3(31), 350-365.
5. Liubicich, M.E., Magistro, D., Candela, F., Rabaglietti, E., Ciairano, S. (2012) Low physical fitness is a strong predictor of health problems among young men: a follow-up study of 1411 male conscripts. *Advances in Physical Education*, 2(2), 54-60.
6. Nijs, J., Senne Aelbrecht, S., Meeus, M., Van Oosterwijck, J. Zinzen, E., Clarys, P. (2011). Tired of being inactive: a systematic literature review of physical activity, physiological exercise capacity and muscle strength in patients with chronic fatigue syndrome. *Disability and Rehabilitation*, 17-18(33), 1493-1500.
7. Robertson, M.J. (2013). *The Philosophical Works of Francis Bacon*. Routledge.
8. Sirgy, M.J. (2012). Philosophical Foundations, Definitions, and Measures. *The Psychology of Quality of Life, Social Indicators Research Series*, 50, 5-29.
9. Toker, S., Biron, M. (2012). Job burnout and depression: Unraveling their temporal relationship and considering the role of physical activity. *Journal of Applied Psychology*, 97(3), 699-710.

THE LEVEL OF PHYSICAL ACTIVITY OF UNDERGRADUATE STUDENTS AT THREE FACULTIES OVER A SEVEN-DAY PERIOD

Ksenija Fučkar Reichel¹, Natalija Špehar² and Jelka Gošnik³

¹University of Zagreb, Faculty of Science, Croatia

²Technical Polytechnics Zagreb, Croatia

³University of Zagreb, Faculty of Humanities and Social Science, Croatia

Abstract

Regular physical activity stimulates at the level of the whole body a series of positive adaptive transformations that contribute to the enhancement of functional capabilities, and advance health and quality of life. Our study includes 2000 undergraduate students (M=47.98%; F=48.98%, and the rest of forms were not usable) of the first year at the three institutions of higher education in Zagreb. The goal of our study was to determine the level of physical activity over the last seven days with the criterion of minimum of 30 minutes of physical activity per day, and if there is difference between genders of students from different faculties. The results show that the level of physical activity over the last seven days in male students is higher than in the female students, particularly evident in the level of physical activity in 3 days and more. The most active students are of the Technical Polytechnic of Zagreb, and they are the most statistically distinguished group in our study.

Key words: university, young adults, physical education, sport, free time

Introduction

The physical activity is the most efficient and the healthiest way to properly maintain our bodies. German biologist, Wilhelm Roux (1850-1924) coined the phrase “function maintains function” more than a century ago. A lack of muscular activities lowers functionality of all physical and biochemical mechanisms related to the motion and aging. However, our modern times are characterized by a longer and longer educational periods that require less and less physical activity, from the earliest age to maturity, while exposing students to more and more psychological demand and stress. Today students experience growing educational load, rapid lifestyle changes during the transition from high school to the undergraduate study, longer commute and fast-changing socio-economic elements of our society that all together contribute to less attention being devoted to proper nutrition and physical activities, and thus to their health.

Regular physical activity (PA) is the essential element during the whole lifetime to maintain good health and to improve the overall quality of life (CDC, 2008; WHO, 2009; Vouri, 2010). The hypokinesia is the fifth most common cause of the increase in the mortality rate after a high blood pressure, an elevated glucose in blood, smoking and obesity (WHO, 2009). People that do not exercise regularly have 20-30% higher mortality risk in comparison to people that workout at least 30 minutes at moderate intensity at least four days in a week (WHO, 2010). A lack of PA is especially problematic in minors and adolescents (Huddleston et al., 2002). This is also confirmed in a survey of undergraduate students at the University of Zagreb that shows a decrease of PA right at the beginning of their undergraduate program with respect to preceding level of PA in high school (Gošnik et al., 2002; Matković et al., 2010). Adults in Croatia continue to contribute to a unhealthy trend of insufficient PA with progressing age as shown by various methodological studies (Action plan, 2010; Eurobarometar 2005; Milošević et al., 2009; Jurakić et al., 2009).

Numerous international and national studies show that positive habit of regular exercise adopted at early age has beneficial influence on healthy habits of young adults (Telama et al., 2005). Especially the role of teachers of the physical and health culture is of significant consequence for the formation of the positive, as well as negative, attitude towards exercise (Luke and Sinclair, 1991), which can be transformed in the regular engagement in the sports and recreational activities for the rest of one's life.

The goal of this study is to establish the level of physical activities in undergraduate students at three institutions of higher education in different fields over the last seven days with criterion of at least 30 minutes of physical activity per day. Also, we want to determine the differences between genders and different faculties.

Methods

Sample of students

This study was conducted on a quota sample (N=2000) comprised of the 1st year undergraduate students from three institutions of higher education (three faculties in different fields of science) at the University of Zagreb recorded in Table 1. This sample consists of 47.98% male students, 48.98 female students and 3.04% questionnaire were not properly filled in.

Table 1: Frequency (N) and percentage (%) of the 1st year undergraduate students at the Faculty of Humanities and Social Sciences (FF), the Faculty of Sciences (PMF) and the Technical Polytechnic of Zagreb (TVZ)

Gender	FF		PMF		TVZ	
	N	%	N	%	N	%
Male (M)	177	23.76	234	34.16	541	86.01
Female (F)	568	76.24	430	62.77	50	7.95
missing	0	0.00	21	3.07	38	6.04
total	745	100%	664	100%	591	100%

Data collection and sample of variables

The 1st year undergraduate students at three faculties from at the University of Zagreb participated in a survey during the winter semester of the 2011-12 academic year. Students completed a questioner for the purpose of improving the education in the course of Physical education. It is voluntary and anonymous survey and the results are interpreted at the level of group. The motivation and the goal of the study was explained to the students prior to them taking this survey which contains of 26 questions divided into a several groups for the purpose of determining the following three points. 1) The participation in regular physical activities over the last seven days over at least 30 minutes; 2) Gender of student; 3) The faculty at which student is studying. In this survey we did not include the questionnaire of specific intensity of physical activity, but only participation according to recommendation of the World Health Organization for adults that considers a minimum of 30 minute of exercise per day as necessary condition to maintain a good health.

Method for data analysis

Collected data from students' questionnaire was processed with statistical software package STATISTICA 7.0. All variables are analyzed through basic descriptive parameters to determine their key statistic properties (frequency, percentage, mean value and standard deviation). The Student t-test for independence of sample was used to determine statistical significance of differences. The analysis of variance and Newman-Keuls test was employed to establish difference in mean values of the variables grouped by gender and attending specific faculty. The entire analysis was conducted at the level of significance of $p < 0.05$.

Results

The level of physical activity over the last seven days with criterion of at least 30 minutes of exercise (PA 7/30) was determined with the scale of basic descriptive parameters for a number of PA days. The students had to select the number from 1 for not a single day, to 6 for 5 days or more of PA lasting at least 30 minutes. This created 6 groups according to the level of PA presented in table 2.

Table 2: Frequency (N) and percentage of students (%) according to level of physical activity over the last seven days (TA 7/30) as three faculties – FF, TVZ, PMF total and according to gender

Faculty	Gender	Frequency Percentage	Not a 1 day	1 day	2 days	3 days	4 days	5 days or more	Missing
FF	M	N	31	35	44	20	18	29	0
		%	17.5	19.8	24.9	11.3	10.2	16.4	0.00
	F	N	139	140	136	77	31	44	1
		%	24.47	24.65	23.94	13.56	5.46	7.75	0.18
	Total	N	170	175	180	97	49	73	1
		%	22.82	23.49	24.16	13.02	6.58	9.80	0.13

PMF	M	N	38	92	64	27	13	18	3
		%	14.90	36.08	25.10	10.59	5.10	7.06	1.18
	F	N	57	199	101	39	22	11	1
		%	13.26	46.28	23.49	9.07	5.12	2.56	0.23
	Total	N	95	291	165	66	35	29	4
		%	13.87	42.48	24.09	9.64	5.11	4.23	0.58
TVZ	M	N	58	85	105	121	79	131	0
		%	10.02	14.68	18.13	20.90	13.64	22.63	0.00
	F	N	12	7	12	9	4	6	0
		%	24.00	14.00	24.00	18.00	8.00	12.00	0.00
	Total	N	70	92	117	130	83	137	0
		%	11.13	14.63	18.60	20.67	13.20	21.78	0.00

We have calculated the mean value and the standard deviation for the level of PA over the last seven days (PA 7/30). We have also tested the significance of difference between the results for male and female students with the Student t-test.

Table 3: Statistical parameters (Mean, and Standard deviation) and the t-test for PA 7/30 variable

Faculty	M		F		t-test	
	Mean	±SD	Mean	±SD	t	p
FF	3.26	1.69	2.74	1.49	3.92	.000*
PMF	2.77	1.37	2.54	1.15	-2.29	.022*
TVZ	3.84	1.64	3.08	1.65	-3.13	.001*

The results of t-test (Table 3) show that there is statistically significant difference in variable PA 7/30 between male and female students at all three faculties. Variance analysis grouped according to gender and faculty shows that there is statistically significant difference ($F=48.56$, $p=0.00^*$) so we can reject the null hypothesis. We also performed the Newman-Keuls test to determine what specific difference had the most importantly contributed to statistically significant results (Table 4).

Table 4: Results of the Newman-Keuls test for PA 7/30 variable grouped according to gender and faculty

Gender/Faculty	{1}	{2}	{3}	{4}	{5}	{6}
M/FF {1}		.006*	.000*	.007*	.000*	.265
M/PMF {2}	.006*		.000*	.853	.329	.055*
M/TVZ {3}	.000*	.000*		.000*	.000*	.000*
F/FF {4}	.007*	.853	.000*		.216	.090
F/PMF {5}	.000*	.329	.000*	.216		.004*
F/TVZ {6}	.265	.055	.000*	.090	.004*	

Discussion and Conclusions

Regular physical activity stimulates many beneficial changes in a body that contribute to the enhancement of functional capabilities, improvement of health and quality of life (Šarić and Heimer, 2012). The education of physical education (PE) at the undergraduate level should be continuation and expansion of the program of PE in high school. Students enter undergraduate programs with different knowledge and awareness of physical activities, as well as different motoric and functional skills influenced by different attitudes and habits. Every semester students can select kinesiological program according to their needs and personal preferences depending on material and support conditions at a specific faculty. Due to a typical decrease of PA and common spread of sedentary lifestyle it is necessary to educate and motivate young adults to make regular PA healthy habit for lifetime.

The results of our study show that the level of PA over the last seven days is higher for male students than for female students, and it is particularly evident for the level of physical activity with three days or more. The results of a higher PA in male students with the respect to female students confirm the results of some of previous studies conducted on undergraduate students at the University of Zagreb (Gošnik et al., 2002; Fučkar et al., 2006; Fučkar et al., 2012; Gošnik et al., 2011). The analysis of variance for the PA 7/30 variable grouped according to gender and faculty confirms the statistical significance of difference, while the Newman-Keuls test shows what variables are the most important contributors to the statistically significant results. Male student at the Technical Polytechnic of Zagreb are the most active and statistically distinguished from all other test groups, while female students at the Technical Polytechnic of Zagreb are statistically different from their male colleagues and female students from the Faculty of Sciences. Male students at the Faculty of Humanities and Social Sciences are statistically different from all groups except female students at the Technical Polytechnic of Zagreb. Male students at the Faculty of Science are different from all other male students and female students at the Technical Polytechnic of Zagreb. Female students at the Faculty of Sciences are significantly different only from male students at the Faculty of Sciences and the Technical Polytechnic of Zagreb, and they are not significantly different from their male colleagues.

The results of this study conducted on the total sample of 2000 male and female undergraduate students at three faculties of the University of Zagreb confirms downward trend of activity among younger generations. According to a study of physical activity of Croatia population from 2009, 60% of adults do not participate in any form of physical exercise. The alarming indicator is that the lowest level of physical activity is characteristic for adolescent and young adults (15-25 years of age) which makes this group a priority target for the promotion of physical activities (Jurakić et al., 2009). Modern lifestyle with increasing sedentary characteristics and passive free time requires community and educational effort to stimulate development of positive attitude and habit in students towards the physical activity and improvement of the quality of life. The role of teachers is becoming more and more critical because we have to motivate students and offer them interesting and rewarding kinesiological program through the course of Physical education.

This study is based on only one generation of the 1st year undergraduate students, hence in the future we aim to repeat it on the following generations to conduct longitudinal analysis on a bigger sample encompassing several successive age cohorts across a number of different faculties at the University of Zagreb. We also plan to refine investigation of a scale of intensity, types and length of activity to obtain more complete picture and thus establish more precise guidelines that can better motivate students to pursue regular exercise and quality use of the free time for the lifetime.

References

- Centers for Disease Control and Prevention (CDC) 2008 Physical Activity Guidelines for Americans [displayed 08 february 2012]. Available at <http://www.health.gov/paguidelines/pdf/paguide.pdf>
- European Commission (EC). Special Eurobarometer 246/Wave 64.3 - TNS Opinion & Social. Health and food [pristup 17. srpnja 2013.]. Dostupno na http://ec.europa.eu/public_opinion/archives/ebs/ebs_246_en.pdf
- Fučkar-Reichel K., Vulić J., Švaic V. (2006): Kvaliteta rada u nastavi Prirodoslovno-matematičkog fakulteta Sveučilišta u Zagrebu, U: V. Findak (ur.) *Zbornik radova 15. ljetne škole kineziologa Republike Hrvatske, Rovinj, 2006.*, "Kvaliteta rada u područjima edukacije, sporta i sportske rekreacije", (str.293/298) Zagreb: Hrvatski kineziološki savez, ISBN 953-95082-1-5
- Fučkar-Reichel, K., Gošnik, J., Vulić, J. (2012.) Ineteresi studenata/ica Prirodoslovno-matematičkog fakulteta za teoretske kineziološke teme, U: V. findak (ur.) *Zbornik radova 21. ljetne škole kineziologa Republike Hrvatske – Intenzifikacija procesa vježbanja u područjima edukacije, sporta, sportske rekreacije i kineziterapije* (p.p. 133-138). Poreč: Hrvatski kineziološki savez
- Gošnik, J., Bunjevac, T., Sedar, M., Prot, F., Bosnar, K. (2002). Sport experience of undergraduate students U: *Proceedings Book 3rd International scientific conference Kinesiology New Perspectives.* (457-461). Kineziološki fakultet Sveučilišta u Zagrebu. ISBN 953-6378-36-1.
- Gošnik, J., Fučkar-Reichel, K., Špehar, N., Sedar, M. (2011). Povezanost bavljenja sportom s interesima za akademske teme iz kineziologije, U: V. Findak (ur.) *Zbornik radova 20. ljetne škole kineziologa Republike Hrvatske, Poreč, 2011*, 183-189. Huddleston, S., Mertesdorf, J., Araki, K. (2002). Physical Activity Behavior and Attitudes toward Involvement Among Physical Education, Health, and Leisure Services Pre-Professionals. *College Student Journal*, Vol. 36(4): p555.
- Jurakić D, Pedišić Ž, Andrijašević M. (2009.) Physical activity of Croatian population: cross-sectional study using International Physical Activity Questionnaire. *Croat Med J* 2009;50(2):165-73
- Luke, M. D., Sinclair, G. D. (1991.) Gender Differences in Adolescents' Attitudes Toward School Physical Education. *Journal of Teachino in Physical Education*, 1991.11, 31-46
- Matković, A., Nedić, A., Meštrov, M., Ivković, J. (2010.) Uobičajena tjelesna aktivnost studenata Medicinskog fakulteta Sveučilišta u Zagrebu. *Hrvat. Športskomed. Vjesn.* 2010; 25: 87-91
- Milošević, M., Golubić, R., Mustajbegović, J., Doko Jelinić, J., Janev Holcer, N., Kern, J. (2009.) Regional Pattern of Physical Inactivity in Croatia. *Coll Antropol* 33 (2009) Suppl. 1:35-8.
- Ministarstvo zdravstva i socijalne skrbi Republike Hrvatske (2010.) Akcijski plan za prevenciju i smanjenje prekomjerne tjelesne težine za razdoblje od 2010. do 2012. godine. [pristup 08. srpnja 2013.]. Dostupno na www.zdravlje.hr/content/download/7981/60835/file/AKCIJSKI_PLAN_ZA_PREVENCIJU_I_SMANJENJE_PREKOMJERNE...14.07.2013

12. Šarić M. i S. Heimer (2012). Editoria. *Arh Hig Rada Toksikol* 2012;63 Supplement 3:1-2
13. Telama, R., Yang, X., Viikari, J., Valimaki, I., Wanne, O., Raitakari, O. (2005). Physical Activity from Childhood to Adulthood - A 21-Year Tracking Study. *Am J Prev Med* 28(3):267-273.
14. Vuori, I. (2010.) Physical Activity And Cardiovascular Disease Prevention In Europe: An Update, *Kinesiology* 42, 1:5-15
15. World Health Organization. Global Health Risks - Mortality and burden of disease attributable to selected major risks. 2009. [displayed 25 February 2012]. Available at http://www.who.int/healthinfo/global_burden_disease/GlobalHealthRisks_report_full.pdf
16. World Health Organization (2010.) Global Recommendations on Physical Activity for Health. [displayed 25 February 2012]. Available at http://whqlibdoc.who.int/publications/2010/9789241599979_eng.pdf

ABILITY REALIZATION OF COMPLEX MOTOR STRUCTURES WITH FACULTY OF TEACHER EDUCATION STUDENTS

Marija Lorger and Mateja Kunješić

Faculty of Teacher Education, University of Zagreb, Croatian

Abstract

The purpose of the study was to analyze measuring characteristics of three standard instruments in the area of coordination and to assess the ability of mastering complex motor structures in Faculty of Teacher Education first and second year students. Applied tests have proved suitable for application in practice, among others with high coefficient of reliability. Factor analysis isolated two factors of coordination: factor of manipulation and control of the body in space and lateral agility factor. More detailed assessment of the mastering complex motor structures ability in first-year students, seeks a series of wide range researches in this area of the motor space in order to define a coordination model for Faculty of Teacher Education students.

Key words: motor performans, motor skills, coordination model

Introduction

- Why do we observe coordination space?
- It is a complex biomotor ability closely related with speed, strength, endurance and flexibility
- It is greatly important for the learning, development and application of techniques and tactics in unusual conditions as in balance disruption
- Athlete with good coordination can perfectly perform specific movements and quickly resolve unexpected tasks in training (so as student during class of physical education)
- Coordination is responsible for the multilateral development of subject
- Coordination is the most successfully adopted in early age (Bompa, 2006).

It is expected for future teachers to be able to “transfer” certain coordination motor programs to students through their own motor experience. Therefore, it is advisable to explore their ability to overcome complex motor structures. The ability of learning more complex movements should enable easier transfer of the motor skills from teachers to students. This is extremely important because the impact on the development of coordination skills through the class of physical education must not be neglected as the optimal age for the coordination program learning is between six and eleven (Cenizo Benjumea, J.M.; Ravelo Afonso, J.; Morilla Pineda, S.; Ramírez Hurtado, J.M. Fernández-Truan, J.C., 2013).

The measurement conducted in order to diagnose the current state of their colleagues will serve them as an excellent introduction to the procedures and methods of kinesiometry work, given that diagnostic procedures in the field of coordination are very complex. The complexity of diagnostic procedures arises from the term of coordination. Unevenness of terminological concepts in kinesiology makes the generalization and classification of coordination very difficult. Coordination skills require diagnostics of each coordination factor due to its complexity. It is important to choose the diagnostic procedures (used to analyze the level of coordination abilities) which can be applied without costly, sensitive and sophisticated equipment and can be performed in conditions in which physical education takes place. Given the above criteria, three tests that assess the ability of complex motor structure realization (in the area of coordination) have been elected. The aim of the study was to analyze measuring characteristics of three standard instruments in the area of coordination and to assess the ability of mastering complex motor structures in Faculty of Teacher Education first and second year students. Analysis of the tests metric characteristics was conducted for the purpose of their hypothetical use in evaluating coordination abilities in newly enrolled students. For the purpose of this study, field of coordination was analyzed through the ability to assess ways and directions of motion (eight with bending), the ability of fast movement in an unusual way (polygon backwards) and the ability to quickly change the direction of movement (side steps), (Metikoš, Prot, Hofman, Pintar, Oreb, 1989).

Methods

Table 1: The sample of participants

Test	Sample number
Eight with bending (MAGOSS)	118
Polygon backwards (MRGPOL)	110
Side steps (MAGKUS)	133

The sample of participants in the study consisted of 133 students of the first and second year of Faculty of Teacher Education, University of Zagreb (average age of 19 years). Given that the measurement was conducted in the first two weeks of December it was difficult to have the same number of subjects in every measurement, so the number varied from 110 to 133. The highest number of subjects participated in the measurement of the side steps test and the lowest in measuring of backwards polygon test.

The sample of variables

The survey was conducted with a battery of three standardized tests that illustrate the space of coordination, which is in this case defined by the ability of modes and motion direction assessment (MAGOSS - eight with bending); speed of moving body in an unusual way (MRGPOL – backwards polygon) and fast change of direction (MAGKUS – side steps), (Metikoš and all, 1989).

Methods of data processing

Three consecutive measurements of test particles were made, and analysis and data processing was performed in the package Statistica 7.0. The basic statistical parameters of test particles were shown, coefficients of internal tests reliability were calculated ($C\alpha$) and reliability coefficients were obtained on standardized test particles ($S\alpha$) (Dizdar & Maršić, 2000). Factorial structure of test particles was determined.

Results and Discussion

Table 2: Descriptive statistics

	N	Mean	Std.Dev.	Skewness	Kurtosis	Max D	K – S
MAGOSS 1	118	21,662	2,286	0,339	-0,308	0,070	$p > .20$
MAGOSS 2	118	20,494	1,855	0,140	-0,528	0,087	$p > .20$
MAGOSS 3	118	20,217	2,016	0,450	0,031	0,090	$p > .20$
MRGPOL1	110	13,424	3,144	1,482	3,700	0,106	$p < .20$
MRGPOL2	110	12,443	2,586	1,396	3,970	0,107	$p < .20$
MRGPOL3	110	12,078	2,550	1,207	2,180	0,131	$p < .05^*$
MAGKUS1	133	10,896	1,361	0,723	1,782	0,066	$p > .20$
MAGKUS2	133	10,459	1,040	0,906	5,045	0,071	$p > .20$
MAGKUS3	133	10,176	1,057	0,811	2,972	0,055	$p > .20$

By analyzing the results in Table 2, a reduction of result values is noticed, meaning they improved in the third attempt (third test particle) compared to the first one. Although these tests should be well known and practiced, it is very likely that the improved results occurred as a result of motorical learning and not as current improvement of coordination skills. Given that this is a non-selected sample, such movement of measurement results is expected. Also, the impact of self-motivation to achieve better personal results should be taken into account with most participants. Testing distribution normality showed a significant deviation from the normal distribution only in the third test particle – backwards polygon. Considerable average results improvement during the third measurements caused a significant deviation from normal distribution which led to the classification of results in a lower, more desirable values, zone.

Table 3: Reliability coefficients

	Cα	Sα	M correlation
MAGOSS	0.96	0.95	0.87
MRGPOL	0.89	0.90	0.77
MAGKUS	0.92	0.93	0.82

Legend: Cronbach alpha (C α), Standardized alpha (S α), average inter-item correlation (AIC)

Good reliability of tests is confirmed by the value of Cronbach's alpha (C α) as an internal reliability measure and reliability values obtained on standardized particles (S α). Reliability coefficients are very high (above 0.80), which is considered as satisfactory confidence limit (Marsh, Richards, Johnson, Roche, Tremayne, 1994; Momirović, Štalec, Wolf, 1975; Horvat, 1978; Strahonja, Janković, Šnajder, 1982; Benjumea, Afonso, Pineda, Hurtado, Fernández-Truan, 2013). The values of the average correlation between the test particles are also satisfactory, with a slightly lower but still satisfactory correlation of test particles in the backwards polygon test (0.77).

Table 4: Eigenvalues - Principal components

	L	%	Cum %
1	1.169	38.995	38.995
2	1.010	33.697	72.693

Legend: Eigenvalue (L), percentage of explained variance intercorrelation matrix of items (%), cumulative percentage of variance (cum %)

Results of component analysis showed that two characteristic roots were extracted, and that explains about 73% of the total variance of the particles intercorrelation matrix. Each component represents one object of measurement indicating the existence of at least two coordination factors.

Table 5: Factor Loadings (Varimax normalized) Marked loadings are $>.70$

Variables	Factor 1	Factor 2
MAGOSS	0,776	-0,181
MRGPOL	0,750	0,207
MAGKUS	0,009	0,968
Expl.Var	1,166	1,014
Prp.Totl	0,388	0,338

Two factors (according to the G-K criteria) were obtained by factor analysis (orthogonal rotation: varimax normalized). Table 5 presents the factors structure which clearly shows the expectations that of all three test results will be projected on the first principal component (first factor) were not confirmed. Considering the presented results it can be seen that eight with bending and backward polygon tests belong to one factor of coordination. This factor insists on manipulating and controlling the movement of body in space, and it can be called factor of manipulation and control of the body in space. Side steps test describes second factor of coordination that insists on fast lateral change of direction (lateral agility) and it can be called lateral agility factor. The existence of this factor was confirmed by lot of authors in their researches (Rupčić, Matković, Knjaz, 2010; Ivković, 2007; Bobić, Trošt-Bobić, 2009; Rodić, Gruić, Ohnjec, 2011...). Although it was expected due to their structure, the applied tests did not produce the same latent dimension on the examined sample. Since these are standardized tests (which showed good metric characteristics in this research), their usage is possible in collecting information about the coordination abilities of future Faculty of Teacher Education students.

Coordination abilities of students

Tablica 6: T-test for Independent Samples

T-test for Independent Samples (t- test kinesiology, 2014.sta) Note: Variables were treated as independent samples					
First comapracion	M 1	M 2	t-value	df	p
MAGOSS 1: MAGOSS 2 Third-year female students FK: 1 st & 2 nd - year female students TE	18,580	20,786	-4,969	4	0,007
MRGPOL 1: MRGPOL 2 Third-year female students FK: 1 st & 2 nd - year female students TE	9,5900	12,643	- 7,581	4	0,001
MAGKUS 1: MAGKUS 2 Third-year female students FK: 1 st & 2 nd - year female students TE	8,9100	10,503	-7,603	4	0,001
Second comapracion					
MRGPOL 1: MRGPOL 2 female anathletes high school : female students UF	19.670	12.643	17.446	4	0.000
MAGKUS 1: MAGKUS 2 female anathletes high school 17 year : female students UF	13.050	10.503	12.153	4	0.000

Variables: figureof eight with a bend (MAGOSS), obstacle course backwards (MREPOL), side-steps (MAGKUS)

Given the impossibility of comparing measurement results with other similar measurements (especially in the eight with bending test) it is very difficult to say what are the current abilities of future teachers in the area of coordination. Reviewing the literature, we can mainly find the results of the measurements performed on active sportswomen because these specific tests (side steps and eights with bending) are not part of the usual tests battery used in physical education measuring. For the purpose of measurements evaluation, the authors compared results with the participating categories that may be similar to students of first and second year. Those are regular third-year students of the Faculty of Kinesiology, who have passed the dances course (Vlašić, Oreb, Furjan-Mandić, 2007). It can be said that this is selected sample in two ways. The first selection was made during an entrance exam and the other one was made by passing the dances course exam. Given that most of dance structures relate with coordination, it is expected for students of the Faculty of Kinesiology to be significantly better in the coordination abilities than first and second year students of Faculty of Teacher Education. Table 6 shows that t-test results confirmed this assumption. However, a positive indicators are significantly better results in side steps and polygon backwards tests by students of Faculty of Teacher Education, obtained by comparison with the non-selected sample (which is perhaps more similar to students sample in this study). Side steps test results have been compared with the results of 17 years old schoolgirl non-athletes (Bobić, Trošt - Bobić, 2009) while the value of the polygon backwards test result was compared with the results of non-athletes highschool students (Telebar, 2009). It is assumed that this comparison (regardless of its shortcomings) can provide the first landmark for the creation of a coordination model for the first year students of Faculty of Teacher Education.

Conclusion

Applied coordination tests showed good metric characteristics and are suitable for practical use. Test particles are normally distributed except for third particle (backwards polygon test). This is probably due to significantly better results in the third attempt and the results alignment in the lower zone, in this case, a more preferable value. Factor analysis extracted two factors, factor of manipulation and control of the body in space and lateral agility factor. More detailed assessment of the mastering complex motor structures ability in first-year students, seeks a series of wide range researches in this area of the motor space in order to define a coordination model for Faculty of Teacher Education students.

References

1. Benjumea, C.J.M., Afonso, R.J., Pineda, M.S., Hurtado, R.J.M., Fernández-Truan, J.C. (2013). Design and validation of assessment tool for motor coordination in primary education. *Rev.int.med.cienc.act.fis.deporte*. 10 (10); ISSN: 1577-0354 (In press)
2. Bobić, G., Trošt-Bobić, T. (2009). Utjecaj izvanškolskih športskih aktivnosti na motoričke i funkcionalne sposobnosti te antropometrijske karakteristike učenika 2. i 3. razreda srednje škole. In V. Findak (Ed.), *Zbornik radova 18. Ljetne škole kineziologa Republike Hrvatske "Metodički organizacijski oblici rada u područjima edukacije, sporta, sportske rekreacije i kineziterapije"* (pp. 114 – 119). Zagreb: Croatian Kinesiology Association
3. Bompa, O. T. (2006). *Periodizacija. Teorija i metodologija treninga*. Zagreb: Gopal.
4. Dizdar, D., Maršić, T. (2000.). *Priručnik za korištenje programskog sustava Statistika*. Zagreb
5. Horvat, V. (1978). Metrijske karakteristike testova za određivanje funkcionalnih sposobnosti kardiovaskularnog sistema. *Kinesiology*. 8(1 – 2):17 – 48.

6. Ivković, G. (2007). Razlike u nekim motoričkim sposobnostima između trinaestogodišnjih i četrnaestogodišnjih djevojčica koje se sustavno bave košarkom i onih koje se sustavno ne bave nijednim sportom. In V. Findak (Ed.), *Zbornik radova 16. Ljetne škole kineziologa Republike Hrvatske „Antropološke, metodičke, metodološke i stručne pretpostavke rada u područjima edukacije, sporta, sportske rekreacije i kineziterapije”* (pp.118 – 123). Zagreb: Croatian Kinesiology Association
7. Marsh, H., Richards, G. E., Johnson, S., Roche, L., Tremayne, P.(1994). Physical self-description Questionnaire: Psychometric Properties and a multitrait – Multimethod Analysis of relations to Egsiting Instruments. *Journal of Sport & Exercise Psychology*. 16: 270 -305.
8. Metikoš, D., Prot. F., Hofman, E., Pintar, Ž. Oreb, G. (1989). *Mjerenje bazičnih motoričkih dimenzija sportaša*. Zagreb: Faculty of Physical Education
9. Momirović, K., Štalec, J., Wolf, B. (1975). Pouzdanost nekih kompozitnih testova primarnih motoričkih sposobnosti. *Kinesiology*.5(1-2): 169 -191.
10. Rodić, S., Gruić, I., Ohnjec, K. (2011). Relacije između bazične i specifičnih manifestacija agilnosti u rukomet. In I. Prskalo, D. Novak (Eds.), *Zbornik radova 6. kongres FIEP-a Europe, „Tjelesna i zdravstvena kultura u 21.stoljeću – kompetencije učenika”* (pp. 668–674) Zagreb: Croatian Kinesiology Association
11. Rupčić, T., Matković, B., Knjaz, D. (2010). Antropološki profil košarkaških sudaca. *Croatian Sports Medicine Journal*. 25: 16-22
12. Strahonja, A., Janković, V., Šnajder, V. (1982). Analiza pouzdanosti i faktorske valjanosti situaciono – motoričkih testova u odbojci. *Kinesiology*. 14(5): 161 – 175.
13. Telebar, B. (2009). Analiza razlika u morfološkim obilježjima i motoričkim sposobnostima između učenica odbojkašica i učenica nespportašica. In V. Findak (Ed.), *Zbornik radova 18. Ljetne škole kineziologa Republike Hrvatske* (pp. 250-253). Zagreb: Croatian Kinesiology Association
14. Vlašić, J., Oreb, G., Furjan-Mandić, G. (2007). Motor and morphological characteristics of female university students and the efficiency of performing folk dances. *Kinesiology*,39(1):49-61.

GENDER DIFFERENCES IN SOME ANTHROPOMETRIC AND MOTOR CHARACTERISTICS AMONG STUDENTS OF ZAGREB UNIVERSITY SCHOOL OF MEDICINE

Tonći Mašina¹, Miroslav Zečić² and Davor Pavlović³

¹University of Zagreb, School of Medicine, Croatia

²Croatian Tennis Association, Croatia

³University of Zagreb, Faculty of Forestry, Croatia

Abstract

This study tested some dimensions of morphological status among students of Zagreb University School of Medicine with the aim of determining gender differences. Results showed statistically significant differences by gender in 11 out of 14 dimensions of morphological status. Male students achieved expected higher values in variables describing skeleton dimensions, whereas female students achieved higher values in variables such as percentage of body fat, triceps skinfold thickness, and flexibility. We conclude that students of both genders participate insufficiently in kinesiology activity programs, so a continuous education on the importance of healthy lifestyle should be provided, especially among future medical doctors.

Key words: anthropometric characteristics, motor characteristics, kinesiology activity, healthy lifestyle, medical students, gender differences

Introduction

Among morphological characteristics, gender differences (sexual dimorphism) are the most prominent between 10 any 15 years of age (Kovačević, Kvesić and Kuna, 2011). Until puberty, both genders show a parallel development of those characteristics that are influenced by growth and development. From the healthy lifestyle perspective, the most important characteristics are those that we can influence considerably by regular physical activity and balanced diet. These include, in the first place, body weight, body mass index (BMI), percentage of body fat, percentage of muscle mass, visceral fat, basal metabolic rate, skinfold thicknesses, and waist circumference. Also, some motor characteristics, such as flexibility and repetitive trunk strength, are necessary for healthy functioning of the human body, with the potential of influence by regular physical exercise (Mitchel et al., 2008; Pribis et al., 2010; Kovačević, Kvesić and Kuna, 2011).

Student population lifestyle is greatly determined by their academic engagement both at the university and in their leisure time. Lectures, seminars, and practical classes, along with a great number of study hours on a daily basis, all require 'sedentary lifestyle'. This results in reduced physical activity, poorer dietary habits, reduced social activities, increased stress and diminished ability to cope with stress, and a number of other factors affecting healthy lifestyle. Studies have shown high percentages of reduced physical activity in young populations between 18 and 24 years of age (Kilpatrick et al., 2005; Levy and Cardinal, 2006; Sullivan et al., 2008; Čurković, 2010), which has been studied worldwide. Many studies have confirmed the trend of reduced physical activity at the point of university entry (Pribis et al., 2010), and increased body weight, percentage of body fat and BMI (Racette et al., 2008; Pribis et al., 2010; Mašina and Milošević, 2012; Gropper et al., 2012). A positive correlation has been observed between percentage of body fat and BMI in Japanese and Thai female students, as well as moderate negative correlation between percentage of body fat and daily step counts (Morinaka et al., 2012).

Upon entry at a university, student participation in physical activity programs declines, the same being true for medical students. Tempski et al. (2012) found that first-year medical students in Brasil have insufficient physical activity, sleep hours, and social activities, which affects their quality of life. Also, students report physical activity as one of the coping mechanisms for a demanding engagement at the medical school.

Studies among first-year medical students indicate that their previously acquired habits of participating in physical activity correlate positively with certain morphological characteristics. Good results in test for functional ability assessment (VO₂ max) correlate positively with better dietary habits and lower blood pressure. High correlation has been observed between physical activity and lower BMI, diastolic blood pressure, and lower heart rate at rest (Peterson et al., 2003). Multiple studies have confirmed that female students are less physically active than their male counterparts (Mašina and Milošević, 2012; Rao et al., 2012; Varela and Mato, 2012).

Gender differences by healthy lifestyle have been confirmed among university students in South Africa, with female students reporting stress, smoking and excessive eating more often than male students (Janse van Rensburg and Surujlal, 2013).

The constant decline of physical activity in student populations, with a lifestyle including elements of risk behaviour, results in higher numbers of overweight and obese students (Sareen et al., 2012; Racette et al., 2008; Pribis et al., 2010), as well as in a series of other conditions that might affect their health in the future. It is necessary to systematically provide education for students on the importance of healthy lifestyle, but also to implement measurements so that students have specific information about their own morphological status. This is of particular importance for medical students as future medical doctors, whose role will be to provide preventive care for patients by counselling them on healthy lifestyle (Mašina and Milošević, 2012; Holtz et al., 2013).

Methods

This study examined a convenient sample of 175 students (120 female and 55 male), aged 18 to 22 years, of the first and second year of medical studies at Zagreb University Medical School. We measured four skinfold thicknesses with Harpenden skinfold caliper: triceps skinfold (TSF); biceps skinfold (BSF); subscapular skinfold (SSF); and abdominal skinfold (ASF). Waist circumference (WC) was assessed with tape measure. Body composition was analysed by digital scale OMRON BF-511, which gave data on body mass index (BMI), percentage of body fat (BFAT), percentage of muscle mass (MMASS), visceral fat (VISCFAT), and basal metabolic rate (BMR). Motor abilities were analysed by two tests: sitting wide-legged forward bend (SWLFB), for flexibility assessment; and 60-second trunk lifting to sitting position (TLSP), for repetitive trunk strength assessment.

Data were analysed by IBM SPSS Statistics for Windows, version 19.0.0.1 (www.spss.com).

Results

This study involved first- and second-year medical students aged 18 to 22 years. A total of 175 students were examined (55 male – 31.42%; 120 female – 68.57%). Results indicate statistically significant gender differences in 11 out of 14 variables (Table 1). Statistically significant difference ($p < 0.00$), favoring male students, was found in the following variables: body height, body mass, BMI, percentage of muscle mass, visceral fat, basal metabolism rate, waist circumference, and repetitive trunk strength. Statistically significant difference ($p < 0.00$), favoring female students, was found in the following variables: percentage of body fat, triceps skinfold, and flexibility. Obtained results were expected and confirmed findings of previous studies on student populations in Croatia (Mraković S. Horvat V. Brčić K., 2007; Mašina and Milošević, 2012) and worldwide (Racette et al., 2008; Pribis et al., 2010; Gropper et al., 2012).

Table 1: Independent *t*-test, $p < 0,01$

	mean males	mean females	t-test	df	p
GOSTUD	1.36	1.50	-1.69	173	0.09
TV	182.01	168.31	13.38	173	0.00
TM_LOG	1.89	1.78	10.57	173	0.00
BMI	23.62	21.59	4.27	173	0.00
MMASS_L	1.60	1.46	13.49	173	0.00
BFAT	19.98	29.13	-7.95	173	0.00
VISCFATL	0.63	0.46	5.23	173	0.00
BMR_LOG	3.24	3.13	18.11	173	0.00
WC	84.49	75.45	6.23	173	0.00
BSF_LOG	0.87	0.92	-1.62	173	0.11
TSF	14.22	18.13	-3.97	173	0.00
ASF	15.17	15.97	-0.63	173	0.53
SSF_LOG	1.14	1.12	0.62	173	0.53
SWLFB	52.87	60.40	-3.53	173	0.00
TLSP	43.04	35.92	4.92	173	0.00

Discussion

Observed differences in height, favoring male students, are conditioned by biological differences between men and women, where men in Europe are on the average 10 cm higher than women (Mikšić, 1997). Differences in body mass are justified considering the skeletal dimension differences between men and women. However, body weight is greatly influenced by lifestyle and could be changed over lifetime by regular physical activity and balanced diet.

Body mass index (BMI) represents the ratio of body weight (in kg) to height (in meters squared). It is used as a quick and rough estimate of nutritional status. It has been implemented in clinical settings, in public health studies, and for evaluation of training programs designed for overweight individuals (Mišigoj-Duraković et al., 1995). Male students showed statistically higher BMI values compared to female students, which is logical considering the parameters involved. Mean BMI values for male students (23.62) and female students (21.59) indicate that both groups were within the limits of 'optimal body weight'. Analysis of BMI by gender showed none of male students but 17 (14.16%) female students in the 'underweight' category. The 'normal body weight' category included 69% male students compared to 80% female students. The 'overweight' category included 15 (27%) male students and 5 (16%) female students. Obesity of the first grade was found in 2 male and 2 female students, and higher grade obesity was found in none of the students of both genders.

Considering digital scale OMRON BF 511 manufacturer's data on body composition analysis (McCarthy et al., 2006; Gallagher et al., 2000), *percentage of muscle mass* (MMASS) met the criteria in both genders. Male students achieved 40.34%, which places them into 'high percentage of muscle mass' category, ranging from 39.4 to 44.0. Female students achieved on the average 29.3% muscle mass, placing them into category of normal values, ranging from 24.3 to 30.3. Muscle mass within normal limits was found in 34% of male and in 56.6% of female students. Low levels of muscle mass were found in 7.2% of male and 8.3% of female students, whereas high levels were found in 58.18% of male and 35% of female students. Muscle mass or active mass is necessary for various daily activities irrespective of gender. Regular strength training may greatly increase muscle mass (muscular hypertrophy), depending on individuals' needs. This is the most famous effect of muscle adaptation to strength training, with increase of muscle cross-sectional area leading to increased force and strength (Marković G. 2008). Accordingly, a quality muscle mass serves primarily as a skeletal support and to keep the skeleton in the proper shape, particularly in the old age.

Visceral fat is determined by the amount of fat surrounding the internal organs. People with high values of visceral fat and higher levels of fat in the circulatory system are at risk of developing conditions such as hyperlipidemia and diabetes, regardless of the normal body weight. This study revealed values for medical students that placed them into low index value category: 5.05 for male, and 3.05 for female students. As much as 92.7% of male and 100% of female students had low visceral fat levels. High visceral fat values were found in 7.27% of students, and extremely high values in none of the students.

Basal metabolic rate represents the amount of calories needed to be taken into the organism every day by ingesting food so as to ensure the energy for basic life functions. A larger amount of muscle mass requires greater input of food necessary for supply of energy. Since male students had considerably greater muscle mass compared to female students, their basal metabolic rate values were normally higher.

The relative repetitive strength represents multiple suppression of one's own body weight. As previously shown, female students had almost identical lean and adipose mass (17.78 kg compared to 17.72 kg), whereas male students had 15.69 kg of adipose and 31.68 kg of lean mass. A better ratio of adipose and lean mass enables more effective muscle functions, as reported in this study. Male students achieved on the average 43 repetitions, and female students 36 repetitions. Considering normative values for secondary school population (Findak, 1996), male students achieved the 'average' result leaning towards 'below average', whereas female students achieved 'below average' results.

Average waist circumference values favored male students again, with 84.49 cm compared to 75.45 cm found in female students. Both genders were in the 'safe zone' considering that the upper threshold is 102 cm for men and 88 cm for women. Despite that fact, 10 female students (8.3%) had above normal values, which, along with increased body weight and first grade obesity, places them in the risk group and high risk group for developing a disease (WHO, 2008).

Body mass consists of adipose and lean component, where adipose or fat component consists of essential and storage fat. Essential fat accounts for 2-5% of body fat, whereas storage fat consists mainly of subcutaneous adipose tissue. Considering the quantity of individual components, there is a marked sexual dimorphism with considerably greater fat proportion in women than in men (Mišigoj-Duraković et al., 1995). This study confirmed these findings, showing that male students had on the average 19.98% body fat, and female students 29.13%. Taking into account the normative values defined by the manufacturer of the measuring instrument, both genders were within the normal ranges for percentage of body fat, with male students being at the threshold of the higher category indicating high percentage of body mass, and consequently increased risk of excessive weight.

Due to specific body structure, women achieve better results in tests for flexibility assessment, as confirmed in this study. Male students achieved on the average the score of 52.87 cm, whereas female students achieved 60.40 cm. Compared to secondary school population, both genders achieved markedly poor results.

Since no normative skinfold values for student populations were available for this study, data on skinfolds for male and female sports participants were taken as a rough estimate (Fox, 1979). Both genders achieved values that place them between 'acceptable' and 'excessive weight' categories.

Conclusion

Results of this study show a very low student involvement in the structured programs of kinesiology activity. Since only a structured kinesiology activity (covering planning and programming of exercising) may safely and at a high quality level transform the individual dimensions of the morphological status, it is necessary to systematically provide education to students on the importance of healthy lifestyle, primarily on physical activity and balanced diet. For prevention and educational purposes, measurements need to be implemented so that students are given specific information about their own morphological status and the opportunity to influence them, taking into account gender differences. This is of particular importance for medical students as future doctors, whose role will be to provide preventive care to patients counselling them on how to acquire healthy lifestyle (Mašina and Milošević, 2012; Holtz et al., 2013). Finally, for the purposes of further research but also for education, it is necessary to develop orientation values of as many different dimensions of morphological status as possible, for student population of both genders.

References

1. Ćurković, S. (2010). Kineziološke aktivnosti i rizična ponašanja studenata. PhD thesis, Kineziološki fakultet, Sveučilište u Zagrebu.
2. Findak, V., D. Metikoš, M. Mraković, B. Neljak (1996): Primjenjena kineziologija u školstvu NORME, Fakultet za fizičku kulturu, Sveučilišta u Zagrebu
3. Fox. E., (1979), Sports Physiology. Philadelphia. Saunders College Publishing, 1979, p. 249
4. Gropper S.S., Simmons K.P., Conell L.J., Ulrich P.V.: (2010). Changes in body weight, composition, and shape: a 4-year study of college students, *Appl. Physiol. Nutr. Metab.* 37:1118-1123 (2012)
5. Holtz K.A., Kokotilo K.J., Fitzgerald B.E. And Frank E. (2013). Exercise behaviour and attitudes among fourth-year medical students at the University of British Columbia. *Can Fam Physician* 2013, 59; e26-32
6. Janse van Rensburg Ch. Surujlal J. (2013). Gender differences related to the health and lifestyle patterns of university students, *Health SA Gesondheid* 18(1), Art. 735, 8pg
7. Kilpatrick, M., Hebert, E., Bartholomew, J. (2005). College students' motivation for physical activity: differentiating men's and women's motives for sport participation and exercise. *Journal of American College Health*, 54 (2), 87-94.
8. Kovačević A., Kvesić M., Kuna D.: (2011) Antropološka obilježja srednjoškolaca kao spolni dimorfizam. In: Zbornik radova 6^t Kongres FIEP – a Europe, Tjelesna i zdravstvena kultura u 21 stoljeću - Kompetencije učenika, Poreč 18 – 21 June, 2011
9. Levy, S.S., Cardinal B.J. (2006). Factors associated with transitional shifts in college students physical activity behaviour. *Research Quarterly for Exercise and Sport*. 77(4), 476-485
10. Marković G. (2008). Jakost i snaga u sportu: Definicija, determinante, mehanizmi prilagodbe i trening. In: Zbornik radova 6. godišnja međunarodna konferencija, Kondicijska priprema sportaša 2008, Zagreb, 22-23 February, 2008
11. Mašina T, Milošević M. (2012), Neke odrednice ponašanja prema zdravlju studenata medicinskog fakulteta Sveučilišta u Zagrebu, Cvahtetovi dnevni javnoga zdravlja 2012, u Kongres športne rekreacije 2012 Javnozdravstveni vidiki telesne dejavnosti, 105-110
12. Mikšić D. (1997). Uvod u ergonomiju; Fakultet strojarstva i brodogradnje, Zagreb, 1997
13. Mišigo-Duraković et al. (1995), Morfološka antropometrija u športu, Fakultet za fizičku kulturu, 1995
14. Mitchell S.D., Eide BA; R , Olsen C.H., and Stephens M.B., (2008), Body composition and physical fitness in a cohort of US military medical students. *J. Am. Board Fam Med* 2008; 165-167
15. Morinaka T., Limtrakul P., Makonkawkeyoon L., Sone Y.: (2012) Comparison of variations between percentage of body fat, body mass index and daily physical activity among young Japanese and Thai female students. *Journal of Physiological Anthropology*
16. Mraković S. Horvat V. Brčić K. (2007). Razlike u nekim morfološkim karakteristikama dvije skupine studentica učiteljskog fakulteta u Zagrebu. In: Zbornik radova "16. ljetna škola kineziologa" (ed. Findak V.), Poreč 19–23 June, 2007. Hrvatski kineziološki savez
17. Peterson D.F., Degenhardt B.F. I Smith C.M. (2003). Corelation between prior exercise and present health and fitness status of entering medical students. *JAOA* 2003;103.8
18. Pribis P. ,Burtnack C.A., McKenzie S.O. , and Thayer J (2010), Trends in body at, body mass index and physical fitness among male and female college students. *Nutrients* 2010,2,1075 – 1085
19. Racette S.B., Deusinger S.S., Strube M.J., Highsein G.B., Deusinger R.H. (2008): Changes in weight and health behaviours from freshman through senior year of college. *Journal of Nutrition Education and Behavior*, 2008;40:39-40
20. Rao Ch. R., Darshan BB., Das N., Rajan V., Bhogun M. And Gupta A. (2012). Practice of physical activity among future doctors: A cross sectional analysis. *Int J prev Med.* 2012 May; 3(5); 385-369
21. Sullivan, S.L., Keating, X.D., Chen, L., Guan, J. Delzeit-McIntyre, L., Bridges, D. (2008). Physical education and general health courses and minority community college student risk levels for poor health and leisure-time exercise patterns. *College Student Journal*. 42(1) 132-151
22. Tempksi P. Bellodi L.P., Paro H.B.M.S., Enns S.C., Martins M.A., and Schraiber L.B. (2012). What do medical students think about their quality of life? A qualitative study. *BMC Medical Education* 2012, 12:106
23. Varela-Mato V. Cancela J.M. Ayan C. Martin V. and Molina A. (2012). Lifestyle and health among Spanish university students: differences by gender and academic discipline. *It.J. Environ. Res. Public Health* 2012. 9, 2728-2741
24. World Health Organization (WHO). Waist circumference and waist-hip ratio: report of a WHO expert consultation Geneva, 8-11 Dec, 2008

MOTIVATIONAL DIFFERENCES FOR PLAYING FUTSAL AMONG ZAGREB UNIVERSITY STUDENTS

Tihana Nemčić¹ and Mladen Sedar²

¹Physical Doctorate Student, Faculty of Kinesiology, University of Zagreb, Croatia

²Faculty of philosophy, University of Zagreb, Croatia

Abstract

Scope of exercise during college days becomes insufficient to cause positive effects on health and physical fitness. It is very important for physical education teachers to create interesting and qualitative subjects for students in order to satisfy needs for physical exercise. One of the sports that student can choose from is futsal. The aim of this paper is to determine the motives why students choose futsal. Furthermore, the goal is to determine motivational differences between male and female students. 169 students, 55 female and 114 male aged between 18 and 25 years, participated in this research. Descriptive statistics parameters were calculated (arithmetic mean and standard deviation) for 18 items. Results were analyzed so that specific distributions are matched for every item, as well as for overall result distribution. Results showed that female students most common motive for playing futsal was to relax and forget about everyday worries (95%), while male students most common motive was to meet new people (84%).

Key words: differences, motivation, futsal, students

Introduction

Physical exercise is essential for every person's health. According to Healthy People (2010) everyday exercise brings physical and psychical wellbeing. Minimum exercise which leads to health improvement is 150 minutes moderate or 75 minutes vigorous activity weekly (Harvard's Women Health Watch, Physical Activity Guidelines for Americans, 2008). Exercise is especially important for student population because the amount of exercise during college is insufficient and can't cause positive effects on health and fitness. Douglas et al. (1995) showed that only 38% of students regularly participate in some kind of vigorous activity, while 20% participate in moderate activity. Reasons for reduced exercise among student population can be easily explained with: lack of free time (Ebben and Brudzynski, 2008), too much time needed to exercise (Grubbs and Carter, 2002) and learning and college activities overload (Gyurcsik et al., 2004). In order to be successful in academic field, student must work hard, have a great self-control, be determined, concentrated and focused. These exact factors determine success in sport (Simons et al., 1999). Students who participate in a recreational sports program during their college years open themselves up to a wide range of life enhancing benefits. Such benefits include discovering ways of coping with stress, creating a sense of accomplishment, finding ways to control body weight and maintaining physical wellbeing, building friendships and close contacts, as well as improving various sport skills (Banta, Bradley & Bryant, 1991). Essential factor that determines success in sport is motivation. Motivation is important for success in sport - both in recreational and in competitive sport (Matsumoto and Takenaka, 2004). Motivation can be defined as an interaction of internal factors (unconscious and conscious psychological compulsions) and external factors (social and familial gratification and recognition), which are combined with a variety of drives (basic drives, self-image, experience) that can evolve and change over time" (Recours, Souville, Griffet, 2004). Past research and literature reviews have identified four main factors that motivate people to participate in recreational activities, such as club sports (Beard & Ragheb, 1983). These factors are (1) intellectual, (2) social, (3) competence-mastery, and (4) stimulus-avoidance. The intellectual aspect of these motivational factors involves mentally stimulating components such as learning, using logic, strategizing, creating, discovering or imagining. The social aspect of these motivational factors encompasses both meaningful interpersonal relationships (i.e. friendships) and acquiring the esteem of others. Competence-mastery encompasses the students' need to compete, master, challenge, and achieve a status level. This factor may involve more physically natured activities. The stimulus-avoidance factor involves the extent to which students may participate in a recreational club sport to escape from stimulating factors of daily life, to seek mental and physical relaxation or to refresh and rejuvenate themselves. University of Zagreb counts nearly 60 000 students from all over Croatia with different interests and sport activity knowledge. Specificity of Croatian universities, compared to other European universities, is PE (physical education). PE is obligatory during first and second year of studying and has been introduced as electoral subject on senior years. Contemporarily and attractiveness are significant characteristics of PE education. They tribute in educational sense and have general positive influence on the anthropological status of students. It primarily refers to the imperative of preserving health and its improvement, as well as acquisition of certain volume of motor information

for rational and substantial use of free time (Furjan- Mandić et al., 2010). Furthermore, their research involved Zagreb University students participating in table tennis competition. They found out that the top four motives for choosing table tennis are: “I want to stay in good physical shape and healthy”, “I want to keep myself in form”, “I like to do what I am successful at” and “I want to have fun”. Some researchers showed that there are motivational differences for exercise between female and male students. According to Egli et al. (2011) male students show greater motivation for challenge, competition, strength and social aspect (Kilpatrick et al., 2005), while female students show greater extrinsic motivation considering body weight control and good appearance (Egli et al., 2011.; Kilpatrick et al., 2005). One of the content that Zagreb University students can choose from is futsal. Zagreb University regularly organizes futsal competition for male and female students. Futsal has its origin in Spanish or Portuguese word FUTbol or FUTebol (football) and SALon or SALão (gym), so it’s translated as indoor football (Fútbol de sala). Students train futsal once or twice a week and participate in the competition every week. The aim of this paper was to determine students’ motives for choosing and participating in futsal as well as the motivational differences among male and female students for playing futsal.

Method

Participants

The sample consisted of 169 students aged 18-25 at the University of Zagreb. 55 were female (32.54%) and 114 were male (67.46%). Students participate in Zagreb university futsal competition.

Measures

Questionnaire for exercise motivation (Campbell, 2000. - V. Švaić) was used. Questionnaire consisted of 18 items. For every item, students marked answers rated on the Likert- type scale ranging from 1. It’s not relevant at all, 2 - it’s not relevant, 3 - I don’t find that to be important or unimportant, 4 - it’s important and 5 - it’s very important. Students were measured during futsal competitions, most often on Saturdays, after or before their game was played.

Methods

Statistical package STATISTICA 9 was used to analyze data. The basic descriptive statistic parameters for every variable were calculated (arithmetic means, standard deviation). Every item distributions were also calculated.

Results

Questionnaire for futsal motivation for female students is shown in Table 1. and for male students in Table 2. Tables also show percentages of every answer (%), arithmetic means (AS) and standard deviations (SD).

Table 1: Questionnaire for futsal motivation among female students

N	During exercises I find very important to....	It's not relevant at all	It's not relevant	I don't find that to be important or unimportant	It's important	It's very important	AS	SD
1.	Improve health.	-	-	12.72	56.36	30.9	4.18	0.51
2.	Meet and interact with new people.	1.82	-	5.45	54.55	38.18	4.27	0.56
3.	Good appearance.	5.45	12.73	30.9	38.18	12.73	3.4	0.87
4.	Relax and forget about worries.	1.82	-	3.64	47.27	47.27	4.38	0.58
5.	Learn new stuff and find new knowledge.	-	1.82	12.73	54.55	30.9	4.13	0.54
6.	Find adventure and excitement.	3.64	1.82	9.09	49.09	36.36	4.13	0.63
7.	Go outside.	3.64	1.82	23.64	40	30.9	3.93	0.72
8.	Have fun during sport activities.	-	-	7.27	49.09	43.64	4.36	0.56
9.	Maintain or reduce body weight	9.09	9.09	23.64	41.82	16.36	3.47	0.94
10.	Feel vivid.	1.82	3.64	18.18	49.09	27.27	3.96	0.60
11.	Feel self-confident.	3.64	1.82	25.45	43.64	25.45	3.85	0.71
12.	Feel free, independent and be part of the team	3.64	-	14.55	50.9	30.9	4.05	0.58

N	During exercises I find very important to....	It's not relevant at all	It's not relevant	I don't find that to be important or unimportant	It's important	It's very important	AS	SD
		Percentage %						
13.	Achieve good results and victories	5.45	1.82	30.9	38.18	23.64	3.73	0.81
14.	Improve body and spirit	-	-	12.73	60	27.27	4.15	0.47
15.	Accept and obey rules.	5.45	5.45	14.55	56.36	18.18	3.76	0.72
16.	Be and remain disciplined.	3.64	3.64	29.09	45.45	18.18	3.71	0.73
17.	Learn to respect others whether I win or lose	-	-	14.55	54.55	30.9	4.16	0.52
18.	Enjoy in competing with others.	-	-	14.55	47.27	38.18	4.24	0.58

Table 2: Questionnaire for futsal motivation among male students

N	During exercises I find very important to....	It's not relevant at all	It's not relevant	I don't find that to be important or unimportant	It's important	It's very important	AS	SD
		Percentage %						
1.	Improve health.	1.75	6.14	11.4	43.86	36.84	4.08	0.94
2.	Meet and interact with new people.	-	1.75	14.91	51.75	31.58	4.13	0.72
3.	Good appearance.	3.51	13.16	23.69	35.09	24.56	3.64	1.1
4.	Relax and forget about worries.	0.88	0.88	18.42	37.72	42.1	4.19	0.83
5.	Learn new stuff and find new knowledge.	0.88	4.39	25.44	42.11	31.58	3.99	0.9
6.	Find adventure and excitement.	1.75	3.5	21.93	45.61	27.19	3.93	0.9
7.	Go outside.	0.88	11.4	26.32	35.96	25.44	3.74	1
8.	Have fun during sport activities.	0.88	4.39	14.03	36.84	43.86	4.18	0.9
9.	Maintain or reduce body weight	5.26	14.91	23.68	33.33	22.81	3.54	1.15
10.	Feel vivid.	2.63	8.77	24.56	38.6	25.44	3.75	1.02
11.	Feel self-confident.	1.75	7.9	23.69	38.6	28.1	3.83	0.99
12.	Feel free, independent and be part of the team	2.63	7.9	20.2	42.11	27.2	3.83	1
13.	Achieve good results and victories	1.75	5.26	14.91	43.86	34.21	4.04	0.93
14.	Improve body and spirit	0.88	3.51	17.54	43.86	34.21	4.07	0.86
15.	Accept and obey rules.	3.51	7.9	29.82	34.21	24.56	3.68	1.04
16.	Be and remain disciplined.	0.88	6.14	21.05	45.61	26.32	3.9	0.89
17.	Learn to respect others whether I win or lose	0.88	7.02	23.69	33.33	8.77	3.95	0.98
18.	Enjoy in competing with others.	-	5.26	16.67	41.23	36.84	4.1	0.86

Discussion

Results of the Questionnaire for futsal motives have shown that the most important thing for female students in this activity is relaxation and forgetting the worries. Almost 95% of the female students consider this aspect important (47.27%) and very important (47.27%). The goal of recreational activities is to forget about everyday worries and stress. Importance of this aspect is understandable because the stress is very common among student population, especially during the exam period. Main motive for male students is to meet and interact with new people (nearly to 84%) and have fun during sport activities (very important- 43.86%; important- 36.84%). 93% of female students find both of these aspects meaningful. Free time activities should never be stressful and good results shouldn't be the main goal. The main goal among student population should be to learn new skills through fun, laugh and relaxation. Motive to meet and interact with new people shows that all the students find very important to have social contacts. Next motive for both, female and male students

refers to health improvement. Almost 87% of the female students and 81% of male students find health as important motive to start exercising. 87% of female students and 78% of male students find body and spirit improvement important. This confirms that student population understands the priceless role of physical activity in qualitative development of the human body. Fourth motive for male students refers to relaxation and forgetting the worries (very important - 42.1%; important - 37.72%), while female students value this motive as the most important. This can be explained by the fact that male students consider achieving good results and victories (very important - 43.86%; important - 34.21%) and enjoying competing with others (very important - 41.23%; important - 36.84%) important. According to these results, male students are more competitive oriented than female students. To compare, 31% of female students find achieving good results and victories neither important nor important. This fact shows that the specific number of female students understands that certain values in life are not always achieved through victories, great results and achievements and that the activity they chose for their free time is a way to get all the other: experience, socialization, learning, developing abilities and whole being. Furthermore, female students consider that futsal help them to learn and develop new skills, to respect others when they are better or worse and enables them to enjoy competing with others and experience adventure and excitement while playing futsal (85.45%). Although futsal is recreational activity, female students understand the importance of competing with others because it activates more of their abilities and lift their own boundaries. This results in learning new knowledge and skills. Futsal is a specific sport which most important demands are: to manage in space, think quick, perception, decision making and reaction. All these demands develop these characteristics among people who participate in it. Arithmetic means that show greatest positive values refer to relaxation and forgetting the worries in both female (4.38%) and male (4.19%) students as well as fun during sport activities in both female (4.36%) and male (4.18%) students. It is also important among male students to mention the motive for meeting and interacting with new people (4.13%). These results are correlated with prior mentioned number of female students that participate in futsal in order to satisfy the need for relaxation and forgetting the worries (95%) and have fun while playing futsal (93%). This is also the case with male students. The goal of recreational activities is to get away and have a break from every day student activities. A standard deviation value among female students is the lowest in item no. 14: body and spirit development (0.47). The female student population understands the importance of physical exercise for their personal improvement so they find body and spirit health essential and consider exercising as a great way to affect this aspect. Among male students, standard deviation value is the lowest in the item no. 2: meeting and interacting with new people (0.72). Male students find playing futsal as a great way to achieve social contacts and satisfy the need for social acceptance through this competition. Standard deviation values are the highest in both female (0.94) and male (1.15) students in the item no. 9: maintain or reduce body weight. Large number of students involved in futsal competition play futsal once or twice a week. Only small number of students is more active and plays it several times a week. Having that in mind, the amount of futsal exercise is too little and couldn't be used to regulate body weight. Furthermore, high standard deviation values among male student population in the item no. 2: maintain or reduce body weight (1.15) and no. 3- good appearance (1.1) may be the results of non-fit variables for male population. Perhaps they should be adjusted for better consistency.

Conclusion

Zagreb University Sports Association successfully organizes Zagreb University Futsal Championship for male students for more than 10 years in a row and for 4 years in the row for female students. Every year the number of teams and active participants in futsal grows. There are few researches in the field of futsal on the academic level, especially among female students. In order to make this segment of student sports bigger and better, it is very important to find ways to motivate and activate students to participate in physical activity and futsal.

References

1. Banta, T. W., Bradley, J., & Bryant, J. (1991). *Quality and importance of recreational services: Technical manual and survey*. Corvallis, OR: NIRSA.
2. Beard, J. G., & Ragheb, M. G. (1983). The leisure motivation scale. *Journal of Leisure Research*, 15 (3), 219-228.
3. Douglas, K.A., Collins, J.L., Warren, C. et al. (1997). Results from the 1995. National College Risk Behaviour Survey. *J Am Coll Health*. 46:55-66.
4. Ebben, W. and Brudzynski, L. (2008). Motivations and barriers to exercise among college students. *Journal of exercise physiology*. 11(5) ISSN 1097-9751
5. Egli, T., Bland, H.W., Melton, B.F. and Czech, D.R. (2011). Influence of age, sex and race on college students' exercise motivation of physical activity. *Journal of American College Health* 59(5), 399-406.
6. Furjan- Mandić, G., Kondrić, M., Tušek, M., Rausavljević, N., Kondrić, L. (2010). Sports Students' Motivation for Participating in Table Tennis at the Faculty of Kinesiology in Zagreb. *International Journal of Table Tennis Sciences*. 6:44-47.
7. Grubbs L and Carter J. The relationship of perceived benefits and barriers to reported exercise behaviors in college undergraduates. *Fam Community Health* 2002; 25:76-84.

8. Gyurcsik NC, Bray SR, and Brittain DR. Coping with barriers to vigorous physical activity during transition to university. *Fam Community Health* 2004; 27:30-142.
9. HarvardsWomens Health Watch (2009). Harvard Health Publications. Copyright by President and Fellows of Harvard College.
10. Matsumoto, H. and Takenaka, K. (2004) Motivational profiles and stages of exercise behavior change. *International Journal of Sport and Health Science* 22, 89-96.
11. Physical Activity Guidelines for Americans (2008). U.S.: Department of Health and Human Services. Retrieved February 12, 2013 from: <http://www.health.gov/paguidelines/guidelines/default.aspx>
12. Recours, R. A., Souville, M., &Griffet, J. (2004). Expressed motives for informal and club/ association-based sports participation. *Journal of Leisure Research*, 36 (1), 1-22.
13. Simons, H.D., Van Rheenen, D., Covington, M.V. (1999). Academic Motivation and the student athlete. *Journal of College Student Development*. 40(2)
14. US Dept of Health and Human Services. *Healthy People* (2010). Washington, DC: US Dept of Health and Human Services. 2000.

THE INFLUENCE OF RHYTHMIC GYMNASTICS TREATMENT ON FLEXIBILITY OF FEMALE STUDENTS FACULTY OF KINESIOLOGY

Josipa Radoš, Gordana Furjan Mandić and Maja Horvatin Fučkar

Faculty of Kinesiology, University of Zagreb, Croatia

Abstract

The aim of this research is to determine the flexibility of female students of Faculty of Kinesiology University of Zagreb after completing rhythmic gymnastics treatment for a period of one year. The research was conducted on sample of 45 second year female students of Faculty of Kinesiology at the age 20 to 23. The students were measured in 3 tests to assess flexibility of different parts of the body before treatment starts (initial measurement) and immediately after completion of the program (final measurement). The T-test for dependent sample was used to establish the differences between the initial and final measurement. The results of T-test showed that there was a statistically significant difference between the initial and final measurement in all variables (MFLISK, MFLPRK, MFLRLK). This study confirm that the stretching exercises that are largely represented in teaching rhythmic gymnastics lead to an increase in functional range of motion, and also have a positive impact on mental and physical health.

Key words: *rhythmic gymnastics, female students, flexibility, T-test*

Introduction

Rhythmic gymnastics is acyclic sport and requires well-developed physical abilities, especially flexibility, which makes up around 60% of the specification equation (Wolf-Cvitak, 2004). Term flexibility involves performing maximum possible range of motion in a joint or series of joints (Fox, Bowers, Foss, 1989; Corbin, Noble, 1980). It is usually classified as ballistic, dynamic or static (Alter, 1996). Flexibility encompasses all components of the musculoskeletal system, which differs from person to person and from joint to joint. Furthermore, flexibility is an important component of physical fitness and plays various roles in a general health and sport performance (Fleck, Kraemer, 1997). Although an optimal level of flexibility can increase functional range of motion, improve posture and muscle symmetry, reduction injury, prevention and alleviation of muscle soreness after exercise and increase level of certain skills and muscular efficiency (Cross, Worrell, 1999; Tyler, et al., 2001., Pope, et al., 2000; Shrierer, Gossal, 2000).

Rhythmic gymnastics is rich movements that require large, sometimes extreme mobility of the joints whether the pivots, balance or jumping as basic physical elements. Program rhythmic gymnastics at the college is based on flexibility exercises all joint system with (rope, hoop, ball, clubs and ribbon) and without apparatus, through introductory, preparatory, primary and final part of a class. Concern should always be focused on the safe, systematic and effective application of the range of motion techniques utilized.

So, the goal of this research was to determine the flexibility of female students of Faculty of Kinesiology after completing rhythmic gymnastics treatment for a period of one academic year. During these period students attended classes four hours a week.

Methods

The presented research were carried out in academic year 2012./2013. on the sample of 45 female students of Kinesiology at the age of 20-23.

The subject performed 3 tests for the evaluation of the flexibility of different parts of the body. The *shoulder circumduction* test (MFLISK) consisted of an extended arms circle backwards with a stick while maintaining the grip as narrow as possible. The task was performed three times and result was recorded in centimetres. The *forward bend test* (MFLPRK) requires a forward bend of the trunk from a standing position on a bench with the legs extended. The task was also performed three times and recorded in centimetres. The last test was *leg split* (MFLRLK) lying on the back. A surface with marked degrees of movement was placed on the wall in front of the subject. The examiner registered the degrees of movement. The task was performed three times. Metric characteristics of all tests were well known and previously reported (Metikoš, et al., 1989).

The data were analysed using the Statistical Package for Social Sciences (ver. 11.0). The descriptive statistics for all variables were calculated (mean, minimum, maximum, range, standard deviation, skewness and kurtosis). The normality of the distributions was examined using the Kolmogorov-Smirnov test. The t-test for dependent samples was used to calculate the differences between initial and final measurement. All the coefficient were considered significant at $p < .05$.

Results and discussion

Descriptive data for all variables is presented in Table 1. According to the Max D values, the results of the subjects in all the measured tests are normally distributed (Max D). The results of Skewness demonstrate that for the female students of Kinesiology all test except test shoulder circumduction have negative asymmetry distribution what means that tests for them are easy for execute. The cause could be that students are well-known in applied tests. On the other hand test FMFLRLK have positive asymmetry distribution ($a_3 > 0$) since it is not familiar for them. Reason for this could be that students are afraid of the test because of the possibility of injury. The results of Kurtosis show high dispersion of results in all motor variables.

Table 1: Descriptive statistics for all variables for the students Faculty of Kinesiology

	Mean	Minimum	Maximum	Range	Std.Dev.	Skewness	Kurtosis	Max D	K-S
IMFLISKX	63,11	22,33	94,00	71,67	17,68	-0,55	-0,40	0,13	$p > .20$
FMFLISK	56,49	16,00	90,00	74,00	18,12	-0,40	-0,41	0,11	$p > .20$
IMFLRLK	122,89	90,00	165,00	75,00	14,94	0,31	0,36	0,11	$p > .20$
FMFLRLK	134,44	105,00	180,00	75,00	15,05	0,47	0,83	0,13	$p > .20$
IMFLPRK	15,74	5,67	27,67	22,00	5,11	0,21	-0,28	0,08	$p > .20$
FMFLPRK	19,26	7,33	32,00	24,67	5,15	-0,05	0,08	0,08	$p > .20$

Legend: IMFLISK (initial shoulder circumduction), FMFLISK (final shoulder circumduction), IMFLRLK (initial leg split), FMFLRLK (final leg split, leg abduction), IMFLPRK (initial forward bend on the bench), FMFLPRK (final forward bend on the bench)

The t-test for dependent sample (Table 2) showed marked statistical differences in arithmetic means between initial and final measurement in all motor tests ($p=0.00$). These founds were expected because the students perform many exercises (with and without apparatus) for developing flexibility on collegiums of Rhythmic Gymnastics. The frequency, intensity, and duration of exercise are affective for producing differences between measurements.

Also, the main selection factors in rhythmic gymnastics are dictated by the very rigid demands that distinguish this sport from others. In the specification equation for rhythmic gymnastics the main criterion are flexibility and aesthetic of movement (Jurinec et al., 2008).

Similar results were obtained by some other research. In the work of Raab et al. (1998) on the samples of 46 woman examinees authors study the impact after 25-week exercise program. Exercise generally increased shoulder flexibility and may be capable of reversing loss in flexibility due to disuse. Further, Roberts and Wilson (1999) investigate effect of stretching program in duration of three times a week for a five week period on the sample of 24 university members at the age of 20,5 years. The authors concluded that the results of treatment program showed greater improvement in flexibility.

Table 2: Results of the t-test for dependent sample

	Mean	Std.Dv.	N	Diff.	Std.Dv.	t	df	p
IMFLISK	63,11	17,68						
FMFLISK	56,49	18,12	45,00	6,62	5,72	7,76	44,00	0,00
IMFLRLK	122,89	14,94						
FMFLRLK	134,44	15,05	45,00	-11,56	6,47	-11,98	44,00	0,00
IMFLPRK	15,74	5,11						
FMFLPRK	19,26	5,15	45,00	-3,51	1,75	-13,49	44,00	0,00

Legend: IMFLISK (initial shoulder circumduction), FMFLISK (final shoulder circumduction), IMFLRLK (initial leg split), FMFLRLK (final leg split, leg abduction), IMFLPRK (initial forward bend on the bench), FMFLPRK (final forward bend on the bench)

Conclusion

The obtained results indicate that the female students have achieved significant results in relation to the initial state flexibility after a year of teaching in the collegiums rhythmic gymnastics. This study confirms that the stretching exercises that are largely represented in teaching rhythmic gymnastics lead to an increase in functional range of motion.

In general, exercise for flexibility has many benefits including: improving sports performance, reduce injuries and also have a positive impact on mental and physical health.

References

1. Alter MJ. (1996). *Science of Flexibility*. Champaign: Human Kinetics, 173-196.
2. Corbin, C.B., Noble, L. (1980). Flexibility: A major component of physical fitness. *The Journal of Physical Education and Recreation*; 51:23-24.
3. Cross, K.M., Worrell, T.W. (1999). Effects of a static stretching program on the incidence of lower extremity musculotendinous strains. *J. Athl. Training* 34:11-4.
4. Fleck, S.J., Kraemer, W.J. (1997). Designing resistance training programs. *Human Kinetics*.
5. Fox, E.L., Bowers, R.W., Foss, M.C. (1989). *The Physiological Basis of Physical Education and Athletics*. Dubuque, Iowa: Wm. C. Brown Publishers.
6. Jurinec, J., Hraski, M., Hraski, Ž. (2008). A simple method for the selection of preschool girls in rhythmic gymnastics. U I. Prskalo, V. Findak, J. Strel (ur.), *The 2nd International Conference on Advances and Systems Research, Zadar, 2008, "2nd Special Focus Symposium on Kinesiological Education - the answer of the contemporary school"* (str. 112-119). Zagreb: Faculty of Teacher Education of the University of Zagreb.
7. Metikoš, D., Prot, F., Hofman, E., Pintar, Ž., Oreb, G. (1989). Measuring basic motor dimensions of athletes. Zagreb: Faculty of Kinesiology University of Zagreb.
8. Pope, R.P., Herbert, R.D., Kirwan, J.D. (2000). A randomised trial of preexercise stretching for prevention of lower limb injury. *Med. Sci. Sport Exerc.* 32:271-277.
9. Raab, D.M., Agre, J.C., McAdam, M., Smith, E.L. (1998). Light resistance and stretching exercise in elderly woman: effect upon flexibility. *Arch Phys Med Rehabil.*: 268-272.
10. Roberts, J.M., Wilson, K. (1999). Effect of stretching duration on active and passive range of motion in the lower extremity. *Br J Sports Med.*: 33(4): 259-263.
11. Shrierer, I., Gossal, K. (2000). Myths and truths of stretching. *Phys Sportsmed.* 28(2):57-63.
12. Tyler, T.F., Nicholos, S.J., Campbell, R.J., McHugh, M.P. (2001). The association of hip strength and flexibility with the incidence of adductor muscle strains in professional ice hockey players. *Am. J. Sports. Med.* 29(2):124-128.
13. Wolf-Cvitak, J. (2004). *Rhythmic Gymnastics*. Zagreb: Kugler d.o.o.

ANALYSIS OF THE IMPACT OF HEALTH-RELATED HABITS ON THE BODY COMPOSITION OF STUDENTS IN DUBROVNIK

Aleksandar Selmanović¹, Matija Čale-Mratović² and Đivo Ban¹

¹University of Dubrovnik, Croatia

²Institute of Public Health of Dubrovnik-Neretva County, Croatia

Abstract

The aim of this research was to determine the nutritional status of students in Dubrovnik, their daily eating habits, as well as their regular physical activity. The analysis was conducted on a sample of 198 first-year students based on the anonymous data collected during the physical examination of students. The results revealed that 75% of female and approximately 40% of male students lack physical activity. Still, this doesn't have negative effects on BMI since the majority of respondents have appropriate body weight. This occurs due to the relatively healthy eating habits of students. In the forthcoming studies the authors will suggest a more detailed evaluation of anthropometric body composition, examine the way and amount of food intake, and thoroughly explore the ways of daily energy expenditure, whereby more accurate information about the health of students would be obtained.

Key words: nutrition, BMI, students, physical activity, health habits

Introduction

The rate of physical activity changes over the course of life; it significantly decreases throughout schooling, especially in urban areas. There is less need for physical effort, while at the same time the activities related to seating and passive leisure time increase. In conjunction with the excessive and unbalanced diet, the sedentary lifestyle often leads to overweight already in the age of puberty and adolescence. (Reichel - Fučkar, Vulić, Krošnjari, 2008). Solid scientific evidence indicates that many diseases or disease precursors occur more often in people who practice either rarely or never than in regularly active people. (Vuori, 2004). Many researches point to the importance of physical activity at any age. The impact of proper and regular exercises is evident in the level of general psychophysical abilities that are considerably higher in people who exercise.

It is in today's fast pace of life that health and healthy lifestyle increasingly gain in importance. Factors leading to healthy lifestyle are the following: increased physical activity, avoiding harmful habits, prevention of obesity and high blood pressure, creation of physical, mental, and spiritual harmony, as well as healthy eating habits. Food is not only a pleasure of life, it is also an important way of improving and maintaining health. Lifetime overeating and inadequate exercise, culminate in an unhealthy aging process. (Clark, 2000).

The aim of this research is to determine basic health-related habits of students in Dubrovnik. Morphological status in terms of nutrition was assessed with BMI and it is interpreted in correlation with eating habits and physical activities.

Research methods

The sample consists of 198 first-year students from different departments, enrolled in the academic year 2012/2013 at the University of Dubrovnik. Respondents were randomly selected. For the sake of more precise analysis respondents were divided according to gender: 118 male students (n=118) and 80 female students (n=80). The sample of variables was collected from the regular physical examination of students, and the data taken into account were the following: BMI, eating habits, regular exercises. The results of BMI were grouped according to the following classification slightly modified in line with the WHO criteria:

BMI	Classification
<20	Underweight
20 - 25	Ideal body weight
25 - 30	Overweight
>30	Obesity

Eating habits were analysed using a questionnaire in two variables which relate to the frequency of eating breakfast and cooked meals. Regular breakfast was evaluated according to the following categories:

1. I never eat breakfast
2. I eat breakfast occasionally
3. I eat breakfast every day

Diet that included cooked meals was evaluated according to the following categories:

1. I rarely eat cooked meal
2. I occasionally eat cooked meal
3. I eat cooked meal every day

Furthermore, the questionnaire was used to examine students' weekly physical activities classified into three categories:

- Up to 1 to 2 hours a week – defined as “Insufficient”
- 3 to 4 hours a week – defined as “Recreational”
- 5 hours or more – defined as “Active”

Data processing methods included frequency and percentage analysis (descriptive parameters) so as to gain an insight in the ratio between genders, while the differences among respondents were analysed with the parametric method – chi square test. Statistical package *Statistica 8.0* was used for data analysis.

Results and discussion

Analysis of the sample's anthropometric status was estimated with body mass index (BMI). BMI is widely used in clinical practice for assessment of nutritional status of adult population in the epidemiological studies and for individual assessment of the nutritional status of persons involved in the physical exercise programme and of overweight persons. (*Mišigoj Duraković, 2008*). However, such a measurement does not include the composition of particular tissues but only a measurement of respondents' body mass and height, and thus the results interpretation should be taken with some reservation.

Table 1: Descriptive BMI indicators according to gender

Gender	n	AS	min	max	SD
Female	80	22,50	16,4	30,5	2,82
Male	118	23,89	18,2	36,1	3,26

Basic information on the Dubrovnik students BMI shows that the arithmetic mean is within the ideal body weight (Table 1). From the perspective of medical experts and nutritionists special attention should be paid to individual cases with extreme values.

A more detailed analysis of differences in the individual categories of index in terms of gender shows that there is no statistically significant difference between female and male students (at $p=0,05$). According to the results of this research nearly 30% of female and slightly more than 40% of male students fall into the category of students with inadequate body mass in relation to height. According to percentage ratio male students have twice as much excess body mass than female students, while there is a small difference in percentage in favour of male students in the obese category. On the other hand, malnutrition (underweight) prevails among female students by slightly more than 3%. (Table 2).

Table 2: Difference in BMI according to gender

Gender		Underweight	Ideal	Overweight	Obesity	Total
Female	freq.	11	57	10	2	80
	%	13,75%	71,25%	12,50%	2,50%	
Male	freq.	12	69	31	6	118
	%	10,17%	58,47%	26,27%	5,08%	
All groups	freq.	23	126	41	8	198
Chi square=6,904				df=3	p=0,0750	

Further results indicate that more than half (54%) of respondents lack regular exercises. The number of active (22,7%) and recreational (24,2%) participants involved in some kind of sporting activities show similar results. However, according to gender analysis, results indicate that there is a significant difference between male and female students ($\chi^2=24,129$; $p=0,00001$). Among male students there are approximately 40% insufficiently active respondents, 30% recreationists and 30% active athletes (Table 3). Special attention should be paid to female students whereby 75% of them are not active, i.e. they exercise insufficiently. Only 15% of female respondents are recreationists, while 10% are active athletes. Similar study (Selmanović, Bagarić, 2007) conducted at the University of Dubrovnik in the academic year 2005/2006 ($n=465$) showed that there were 14% active athletes, 38% recreationists, while 48% were not active in sports. Back then only 5% of female students were active in sports, 16% were recreationists, and 79% did not practice sports. Comparison of these two academic years indicates that there are no major changes in terms of students engaged in sports.

Table 3: Difference in physical activity by gender

Gender		Insufficient	Recreational	Active	Total
Female	freq.	60	12	8	80
	%	75,00%	15,00%	10,00%	
Male	freq.	47	36	35	118
	%	39,83%	30,51%	29,66%	
All groups	freq.	107	48	43	198
Chi square=24,129			df=2	p=0,0001	

Since regular physical activity has positive impact on the overall health and contributes to the better quality of body composition, the analysis of inappropriate engagement in physical activity raises the question of possible negative effect on BMI. Still, in this case the results have shown the lack of significant proportional link between inadequate involvement in physical activities and higher BMI. (Table 4).

Table 4: The ratio of practicing physical activity and BMI among male and female respondents

Gender	Physical activity	Underweight	Ideal body weight	Overweight	Obesity	Chi -square	df	p
Female	Insufficient	4	31	11	1	8,621	6	0,1962
		8,51%	65,96%	23,40%	2,31%			
	Recreational	7	16	10	3			
		19,44%	44,44%	27,78%	8,33%			
	Active	1	22	10	2			
		2,86%	62,86%	28,57%	5,71%			
Male	Insufficient	10	41	7	2	4,757	6	0,5750
		16,67%	68,33%	11,67%	3,33%			
	Recreational	0	11	1	0			
		0,00%	91,67%	8,33%	0,00%			
	Active	1	5	2	0			
		12,50%	62,50%	25,00%	0,00%			

In further studies it would certainly be advisable to conduct a more thorough analysis of composition of soft tissues and their share in total body mass, as well as the ways of energy expenditure in students' daily life.

Within the standard physical examination among student population that was conducted by the Institute of Public Health of Dubrovnik-Neretva County, two following measures of eating habits were evaluated: eating breakfast and cooked meal.

The results related to regular breakfast consumption showed significant differences among genders ($\chi^2=7,937$; $p=0,019$). Overall results support male students who said they ate breakfast on a daily basis (55%), as opposed to 46% of female students (Table 5), which can be considered a good result. Approximately the same percentage of respondents (slightly more than 40%) said they ate breakfast occasionally, while a great discrepancy between male and female respondents occurred in the criteria of not eating breakfast, namely 2.5% of male and 12.5 of female students said they never ate

breakfast. There may be various reasons for this: late getting up, lack of time to prepare breakfast (unlike lunch and dinner which are mainly served) or lack of knowledge reflected in the attitude that avoiding breakfast prevents the intake of “unnecessary” calories.

Table 5: Differences in breakfast consumption among respondents of both genders

Gender		Every day	Occasionally	Never	Total
Female	freq.	37	33	10	80
	%	46,25%	41,25%	12,50%	
Male	freq.	65	50	3	118
	%	55,08%	42,37%	2,54%	
All groups	freq.	102	83	13	198
Chi square=7,937			df=2	p=0,0189	

On the other hand, there is no statistically significant difference in eating habits between male and female students in terms of regular consumption of cooked meals ($\chi^2=0,868$; $p=0,648$). That fact is not surprising since it is known that almost all students in Dubrovnik either eat at home or in canteens. In both cases food is mostly served with a special attention to preparation and nutritional value. Although it is not advisable to eat cooked meal rarely, such habits occur in approximately 10% of cases, which is not alarming (Table 6), and more female than male students eat cooked meal almost every day. The awareness about the benefits of daily consumption of cooked meals is slightly more present in male (44%) than in female students (approximately 40%), while in terms of daily consumption of cooked meals percentages speak in favour of female students. Slightly more than 10% of male students and a bit less than 9% of female students never eat cooked meals.

Table 6: Differences in regular consumption of cooked meal among respondents of both genders

Gender		Every day	Almost every day	Rarely	Total
Female	freq.	31	42	7	80
	%	38,75%	52,50%	8,75%	
Male	freq.	52	54	12	118
	%	44,07%	45,76%	10,17%	
All groups	freq.	83	96	19	198
Chi square=6,904			df=2	p=0,0750	

It can generally be concluded from the presented results that most of students in Dubrovnik do not eat unhealthy food. However, the applied analysis of eating habits is not complete enough to discriminate respondents according to their body structure. The results have shown that the habit of having breakfast and cooked meal, seen separately, does not have a considerable impact on BMI (Table 7). It proves that the specified variables make part of a more complex system which could be defined as the factor of eating habits.

Table 7: The ratio of breakfast and cooked meal consumption on the students' BMI categories

Gender	meal	χ^2	df	p
Female	breakfast	4,741	6	0,578
	cooked meal	2,231	6	0,897
Male	breakfast	8,814	6	0,184
	cooked meal	5,438	6	0,489

In further analysis of students' eating habits it is necessary to explore the number and amount of meals, any potential snacks, and their nutritional values. Apart from the aspect of energy intake, it is important to know the effect of taken ingredients on the body composition which is different for each person.

Conclusion

The research of eating habits and physical activities in correlation with the BMI in case of student population in Dubrovnik has shown some interesting results. Despite the appropriate measures of body structure according to BMI, the habits of regular physical activities among students show poor results. Since there is a gradual decline in physical activities from the first to the fourth year of secondary school, and this trend continues at the university largely due to a number of objective reasons, it is necessary to act in an attempt to change habits in the qualitative sense. The encouraging fact is that students in Dubrovnik did not succumb to the great popularity and convenience of the so-called "fast food" products despite the today's fast pace of life. The research shows that breakfast and cooked meals are widely consumed, but the situation is not ideal. This can be improved primarily with education about the importance of eating breakfast and cooked meals, and in general with the appropriate intake of high quality nutrients.

References

1. Clark, N. (2000). Nancy Clark's sports nutrition guidebook (Sportska prehrana – priručnik za sportaše, trenere, rekreativce). Zagreb: Gopal.
2. Mišigoj-Duraković, M. (2008). Kinantropologija - biološki aspekti tjelesnog vježbanja. Zagreb: Kineziološki fakultet Sveučilišta u Zagrebu.
3. Olvaszto, Z. (2010). Životni stil i tjelesna aktivnost studenata pedagogije. *Život i škola*, 2 (24), 91-102.
4. Reichel-Fučkar, K., Krošnar, N., Vulić, J. (2008). Analiza tjelesne aktivnosti studenata PMF-a u slobodno vrijeme. U Zbornik radova "Sport za sve u funkciji unaprjeđenja kvalitete života" (str. 285-289). Zagreb: Kineziološki fakultet.
5. Selmanović, A., Bagarić, I. (2007) Interes za sportske aktivnosti dubrovačkih studenata. Zbornik radova međunarodne znanstveno-stručne konferencije - Sport za sve u funkciji unaprjeđenja kvalitete života. Zagreb, 2007.
6. Vuori, I. (2004). Physical inactivity is a cause and physical activity is a remedy for major public health problems. *Kinesiology*, 36 (2), 123-153.

A ROLE OF PHYSICAL ACTIVITY IN EXPLANATION OF MENTAL AND PHYSICAL HEALTH SYMPTOMS AMONG UNIVERSITY STUDENTS

Katja Bilić

Croatian Academic Sports Federation, Croatia

Purpose

There is evidence of increment of depression, anxiety and stress symptoms among students at University of Rijeka (Bezinović et al., 1998). Research in health and sports psychology shows regular physical activity helps in improvement of mental and physical health symptoms, such as in decrement of symptoms of depression, anxiety and cardiovascular disease, among others. The purpose of present study was to examine effects of regular physical activity on perception of mental and physical health symptoms in University of Rijeka students.

Methods

A questionnaire study was conducted, where symptoms of mental health were measured by Symptom Check List -90 (SCL-90; Derogatis, 1977). Physical health symptoms were measured by Croatian version of Pennebaker Inventory of Limbic Languidness (PILL; Pennebaker, 1982), while personality dimensions were assessed by Big Five Inventory (John, Donahue & Kentle, 1991).

Results

Data exploration revealed differences in perception of mental and physical health symptoms among students who are physically active and students who are not.

Conclusion

Results are interpreted in context of health and personal well-being, with moderating effects of personality dimensions taken into account.

Key words: *physical activity, mental health, physical health, university sports*



Satellite Symposium

Health Kinesiology

7th INTERNATIONAL SCIENTIFIC CONFERENCE ON KINESIOLOGY

FUNDAMENTAL
AND APPLIED
KINESIOLOGY – STEPS
FORWARD

Editors:
Prof. Stjepan Heimer, PhD, MD
Natalija Babić

Peer Reviewer:
Prof. Ilkka Vuori, PhD, MD



HEALTH KINESIOLOGY STUDY

A precondition for successful cooperation of health service and kinesiology

Stjepan Heimer

Faculty of Kinesiology, University of Zagreb, Croatia

One of the basic public health issues in developed countries, and ever more in developing countries, is related to chronic non-contagious diseases (NCD) whose incidence and prevalence in the entire population is constantly growing. Their morbidity and mortality rates threaten health of our populations and our economies. In the background of these diseases are the so called health risk factors and most of them are depending on personal behaviors and health habits. New and innovative thinking is essential to foster new creative approaches that leverage and integrate evidence through the support of big data, technology and design thinking.

Appropriate regular, or habitual daily physical activity (PA) is a major component in the prevention of chronic diseases, along with a healthy diet and non-smoking. For individuals, it is a powerful means of preventing chronic diseases; for nations, it can provide a cost-effective way of improving public health across the population. Available experience and scientific evidence show that regular physical activity provides people, both males and females, of all ages and conditions - including those with disabilities - with a wide range of physical, social and mental health benefits. Physical activity interacts positively with strategies to improve diet; discourages the use of tobacco, alcohol and drugs; facilitates reducing violent behavior; enhances functional capacity and promotes social interaction and integration.

World health organization (WHO) statements regarding PA are as follows:

- Physical activity is a fundamental means of improving people's physical and mental health. It reduces the risks of many non-communicable diseases and benefits society by increasing social interaction and community engagement. Physical activity is not just a public health issue; it also promotes the well-being of communities and the protection of the environment, and comprises an investment in future generations.
- Appropriate regular physical activity is a major component in preventing the growing global burden of chronic disease.
- At least 60% of the global population fails to achieve the minimum recommendation of 30 minutes moderate intensity physical activity daily.
- The risk of getting a cardiovascular disease increases by 1.5 times in people who do not follow the minimum physical activity recommendations.
- Inactivity greatly contributes to medical costs - by an estimated \$75 billion in the USA in 2000 alone.
- Increasing physical activity is a societal, not just an individual problem, and demands a population-based, multi-sector, multi-disciplinary, and culturally relevant approach.

HEPA - Health Enhancing Physical Activity

In 2005 the European Network for the Promotion of Health-Enhancing Physical Activity (HEPA Europe) was founded. The aim was to respond to the noticeable lack of a platform for sharing the development and implementation of evidence-based policies and strategies in the field of physical activity and health.

Activities of the network support cooperation, partnerships and collaboration with other related sectors, activities and approaches.

The term "health-enhancing physical activity" is frequently used across the European region. It emphasizes the connection with health by focusing on "any form of physical activity that benefits health and functional capacity with undue harm of risk".

Health system and kinesiology cooperation

Complementary area of kinesiology and public health (health kinesiology) is a new discipline with many opportunities of mutual cooperation fulfilling needs of indispensable cooperation in a very broad area:

- in scientific research;
- in routine;

- in common education system from volunteer up to the university level;
- in common policy and activity planning;
- in common activity towards politicians, GO and NGO;

In scientific research:

- common scientific projects in HEPA
- common laboratory research and field surveys
- common development of research methodology
- common presentation of scientific evidences

In routine:

- health and physical ability checking and determining of possible health contraindications for exercise starting of middle age and older persons;
- joint work in PA and exercise counsel units - health, functional and motor diagnostics, counseling and directing to the most appropriate program or club;
- counseling in specific health states;
- persuade or dissuade the physical-medicine preventive procedures;

In common education system from volunteer up to the university level:

- basic courses for volunteers in Sport for all;
- advanced and specialized courses for experienced volunteers and professionals;
- curriculum development of professional study
- curriculum development of university study
- curriculum development of doctoral study.

In common policy and activity planning:

- intervention activities in micro- (individual and family), middle- (schools, factories, companies, settlements, community) and macro-levels (county, national);
- quality managing activity in Sport for all and in sport-recreation units;

In common activity towards politicians, GO and NGO:

- lobbying for political and social support;
- lobbying for official public-health service support;
- lobbying for acts and regulations;
- struggle for the favor in public information media;
- struggle for stakeholders and sponsorships.

In 2006, a new professional organization was established in the United States. The National Society of Physical Activity Practitioners in Public Health (NSPAPPH) is a dedicated group of professionals interested in advancing the capacity of professionals in physical activity and public health in the United States. People with training in this area, particularly at the university level, are employed in state and local health departments working on public health programming for physical activity promotion.

The actual situation in Europe is that medical studies are, as a rule, oriented onto treatment of clinical diseases, while the epidemiological and public health issues in the population are only informatively covered. So, physicians have limited knowledge about chronic diseases epidemiology and epidemiology of risk factors responsible for their development. That is the reason why it is difficult to expect from the primary care physicians and from health service in general, to have an insight into the problem, and even less to undertake planning and implementation of appropriate contemporary measures of primary and secondary chronic diseases prevention.

On the other hand, personnel in kinesiology are not enough, if at all, educated for cooperation with health system. They must become aware of the need of regular PA as a health factor and fulfill quality criteria in their education, sites and programs.

Healthy lifestyle promotion and behavior change in this direction are the basis of risk factors prevalence decreasing in the population and in its strata. To attain this goal, a political decision is needed and inclusion of the problem in the national strategy, as well as appropriate acts and regulations together with the provision of sufficient funding and professional competent personnel.

According to experience from some countries, for making and adopting the strategy, the cooperation of experts from different fields as well as from several government sectors and NGOs is essential. Countries that have already established guidelines and recommendation, that are implementing successfully, have specifically focused scientific research and operative institutions to explore and implement measures to remove the risk factors and the development of chronic diseases. In these countries specialized professional and academic studies of health were introduced, usually associated with the so-called health kinesiology. In the region of South-Eastern Europe such a study does not exist, leading to the lack of collaboration between the sectors of health and kinesiology. This is also one of the reasons for the lack of effective national strategies for physical activity promotion as an irreplaceable health factor in the fight against the most common chronic non-communicable diseases.

Graduates of health kinesiology acquire competence in public health work in kinesiology specific sub-fields of primary and secondary prevention of chronic non-communicable diseases and sports injuries. They are also trained to work in the bodies of the municipal and regional administration as well as in national government in the health care and sports sectors with the task of coordinating these two areas in order to promote HEPA. Their theoretical and practical knowledge and experience in promoting health, physical activity, healthy diet and avoiding or giving up bad habits threatening health, focuses on the implementation and evaluation of necessary measures to improve national health.

The education degree in health kinesiology should give a competence to work in research-educational and research institutions related to research and education areas that connect physical activity and health. In the recreational and rehabilitation centers and federations they are competent to plan, program and implement specific measures of primary and secondary prevention of certain chronic non-communicable diseases and sports injuries as well as of appropriate kinesitherapeutic procedures.

KINESIOLOGY AND HEALTH SYSTEM PARALLEL OPERATIVE COOPERATION LEVELS	
KINESIOLOGY	HEALTH SYSTEM
SPECIAL COMPLEMENTARY HEALING PA PROGRAMMES	CLINICAL CONDITIONS AND INDICATIONS
SPORT CLUBS FOR HEALTH PROGRAMMES (targeted primary and secondary prevention) SPORT CLUBS FOR HEALTH PROGRAMMES (targeted primary and secondary prevention)	HEPA MEDICAL COUNSEL (medical examination, fitness assessment)
Self-chosen individual no-organized physical activity; SPORT FOR ALL clubs with general exercise programmes	PRIMARY CARE PHYSICIANS (GENERAL SUGGESTIONS AND RECOMMENDATIONS FOR PA)

KINESIOLOGY AND HEALTH SYSTEM PARALLEL AND VERTICAL COOPERATION IN HEPA PROMOTION	
KINESIOLOGY	HEALTH SYSTEM
NATIONAL SPORT FOR ALL, FITNESS AND HEPA ASSOCIATIONS (joint national policy planning with health system)	HEPA OFFICERS IN MINISTRIES OF HEALTH AND SPORT AND NATIONAL PUBLIC HEALTH INSTITUTE (cooperation with scientific institutes and national level stakeholders; personnel education system)
REGIONAL (COUNTY) SFA FITNESS AND HEPA ASSOCIATIONS (joint regional policy planning with health system)	HEPA OFFICERS IN COUNTY HEALTH ADMINISTRATION AND PUBLIC HEALTH INSTITUTES (coordination with SFA, other sectors and stakeholders)
LOCAL SPORT FOR ALL (SFA), HEPA ASSOCIATIONS AND CLUBS (appropriate HEPA policy and programmes offer)	HEPA OFFICER IN LOCAL HEALTH ADMINISTRATION (coordination with SFA, other sectors and stakeholders)

In the region of South-Eastern Europe (SEE) such a study does not exist and there is no appropriate collaboration between the domains of health system and kinesiology. The countries from the region lack effective national strategies of PA promotion in the fight against the most common chronic non-communicable diseases. These diseases with their incidence, prevalence and mortality are predominant in developed countries, and their rates increase in developing countries.

This satellite symposium in Opatija is aimed to provoke experts from public health and kinesiology to put their heads together and in a subsequent process compose the syllabus of HEALTH KINESIOLOGY as an international postgraduate study, primary for students from the SEE countries.

Reference

1. World Health Organization, The Regional Office for Europe. (2007). Steps to health: A European framework to promote physical activity for health.
2. World Health Organization, The Regional Office for Europe. (2006). Physical activity and health in Europe: evidence for action. Editors: Nick Cavill, Sonja Kahlmeier and Francesca Racioppi.
3. Edwards, P., & Tsouros, A. (2009). Promoting physical activity and active living in urban environments: The role of local governments. World Health Organization, The Regional Office for Europe.
4. Hartmann, H. (2006). Quality criteria in Sport for all. Lecture at the seminar of the Croatian Sport Medicine Society. Zagreb Fair.
5. Heimer, S. (2008). Sports-recreational medicine. A manuscript. Faculty of Kinesiology, University of Zagreb.
6. Heimer, S. (2010). Sports-recreational medicine – An important part of public health. 2nd International Symposium of Sports Medicine, Palić, Serbia.
7. Kohl, H., & Murray, T. (2012). Foundations of Physical Activity and Public Health. Champaign, IL: Human Kinetic.
8. Prevention and management of non-communicable disease: the IOC consensus statement, Lausanne 2013. *British Journal of Sports Medicine*, 47, 1003-1011.

HEALTH-ENHANCING PHYSICAL ACTIVITY IN WHO EUROPEAN REGION

Joao Breda

WHO Regional Office for Europe

The global burden and threat of noncommunicable diseases (NCDs) constitute a major challenge for development in the twenty-first century, one that undermines social and economic development throughout the world and threatens the achievement of internationally-agreed development goals in low-income and middle-income countries. An estimated 36 million deaths, or 63% of the 57 million deaths that occurred globally in 2008, were due to NCDs. Around 80% of all deaths (29 million) from noncommunicable diseases occurred in low-income and middle-income countries, and a higher proportion (48%) of the deaths in those countries are premature (under the age of 70) compared to high-income countries (26%).

The High-level Meeting of the United Nations General Assembly on the Prevention and Control of Non-communicable Diseases and the adoption of the Political Declaration in September 2011 (United Nations General Assembly resolution 66/2) represented a breakthrough in the global struggle against these diseases. For the first time, all Member States of the United Nations agreed that noncommunicable diseases constitute a major challenge to socioeconomic development, environmental sustainability and poverty alleviation.

The focus of the United Nations' Political Declaration of the High-level Meeting is on the four categories of disease that make the largest contribution to morbidity and mortality due to noncommunicable diseases: cardiovascular diseases, cancers, chronic respiratory diseases and diabetes. These four noncommunicable diseases can be largely prevented or controlled by means of effective interventions that tackle shared risk factors, namely: tobacco use, unhealthy diet, physical inactivity and the harmful use of alcohol as well as through early detection and treatment.

The Political Declaration called upon WHO, in collaboration with the Member States, UN agencies and other relevant regional and international organizations, to prepare recommendations for a set of voluntary global targets for the prevention and control of non-communicable diseases. The Global Monitoring Framework, adopted by the World Health Assembly in May 2013, includes a set of 25 indicators and 9 voluntary global targets for 2025.

The three essential components of the Global Monitoring Framework are:

1. Outcomes (morbidity and disease specific mortality);
2. Exposures (behavioural and biological risk factors); and
3. National system response, including national capacity to prevent NCDs in terms of policies and plans, infrastructure, human resources and access to essential health care including medicines.

There is great diversity in the WHO European Region, with very different needs both within countries and between countries. This diversity calls for close collaboration with partners to bring policy coherence and support implementation. The importance of partnerships and collaboration is reflected in Health 2020, the new health policy which was adopted by the 53 Member States of the WHO European Region in 2012. The area of physical activity is probably one of those where no progress will be possible in case no intersectoral measures are taken. Adequate governance mechanisms and fostering multi-stakeholder action is therefore a critical element for the needed increase in physical activity levels of the population in European countries.

The WHO European Region is playing a leading role in the fight against noncommunicable diseases. It already developed an Action Plan and in 2013 the World Health Assembly endorsed a new global action plan for NCDs with global monitoring framework developed. Furthermore new policy frameworks on diet and physical activity are being developed as mandated by the Vienna Declaration on Nutrition and Noncommunicable Diseases. The WHO European Ministerial Conference on Nutrition and Noncommunicable Diseases in the context of Health 2020 hosted by the government of Austria was an enormous success and a key event. 48 Member States attended and approved the Vienna Declaration which constitutes a milestone in public health in Europe. You have agreed to take coordinated action to effectively tackle unhealthy diets, obesity and malnutrition, as well as physical inactivity. However, much remains to be done in this area.

In the last decade we have reversed the Regional epidemic of circulatory diseases. All parts of the Region are now in steady decline, and, we should be able to report a dramatic fall in both East and West by the target dates of 2020 in Europe and 2025 globally. However working on health determinants and risk factors that are modifiable like diet and physical activity is critical to achieve the targets by 2025.

Note however that, at current rates, in 2025, a citizen of Central or Eastern Europe will still have six times higher risk of dying from heart disease or stroke compared to a citizen in the West. Physical activity improvements at the population level will have therefore a strong role to play here.

Physical inactivity has been identified as one of the leading risk factors for global mortality and is associated with many non-communicable diseases (NCDs) such as coronary heart disease, stroke, cancers, diabetes and obesity. In addition, regular physical activity is associated with positive mental health, healthy growth and development and healthy aging.

National policy and its implementation has been a key area for development since the launch of the WHO Global Strategy for Diet, Physical Activity and Health in 2004 and the subsequent WHO NCD Action Plan 2008-2013.

Formulating a national policy on health-enhancing physical activity will give support, coherence and visibility at the political level, and at the same time make it possible for the institutions involved, such as national government sectors, regions or local authorities, stakeholders and the private sector, to be coherent and consistent by following common objectives and strategies as well as to negotiate and to assign roles and responsibilities. It also fosters greater allocation of resources and accountability. Therefore, country level action on policy implementation is of great interest.

Recent country comparisons have identified important elements of country level action and highlighted the similarities and differences between countries and their progress on increasing participation in physical activity.

Finally it becomes clear that as childhood obesity becomes a priority within the WHO European Region as well as the EU it becomes clear that without decisive action in the area of physical activity promotion in children targets will be difficult to achieve.

As such National policy response in the area of HEPA needs to consider specific contribution to the alleviation of the burden and prevention of childhood obesity.

Childhood obesity is one of the most serious public health challenges of the 21st century. Over the past three decades the prevalence of overweight and obesity has increased substantially. The problem is global and is steadily affecting all countries, particularly in urban settings. The prevalence has increased at an alarming rate, in some countries the number of overweight children has tripled since 1980. Overweight and obese children are likely to stay obese into adulthood and more likely to develop noncommunicable diseases like diabetes and cardiovascular diseases at a younger age. Overweight and obesity, as well as their related diseases, are largely preventable. Prevention of childhood obesity therefore needs high priority. The fundamental causes behind the rising levels of childhood obesity are a shift in diet towards increased intake of energy-dense foods high in fat and sugars but low in essential micronutrients, and a trend towards decreased levels of physical activity. Childhood obesity control efforts should focus on three components with solutions that have proved effectiveness and feasibility for Member States:

- Countries develop structures within and across government to support childhood obesity prevention policies and interventions. These are structural aspects such as leadership, monitoring systems, workforce capacity, and networks and partnerships that need to be in place in order to support and enhance the effectiveness of the more direct policy initiatives and community-based interventions.
- Population-wide policies and initiatives. These are direct policy actions, including regulations and legislations that help to create environments that support healthy diets and physical activity. These policy instruments include regulations, availability and affordability of healthy foods, physical activity spaces and social marketing campaigns. An example is the “Set of Recommendations on the marketing of foods and non-alcoholic beverages to children”.
- Community-based interventions. Experience in several countries has shown that successful obesity prevention and behaviour change during childhood can be achieved through a combination of population-based measures, implemented both at the national level and as part of local ‘settings-based’ approaches.

PUBLIC HEALTH AND HEALTH KINESIOLOGY – THE CORE FIELDS FOR MUTUAL COOPERATION

Sanja Musić Milanović

Croatian Institute of Public Health, Zagreb, Croatia

Promoting participation in physical activity, exercise and sports can make an important contribution to the prevention of disease, promotion of health and community well-being. An active lifestyle can reduce a significant risk factor of physical inactivity contributing to the development of the most common chronic diseases, like heart diseases, stroke, cancers, diabetes type 2 and mental disorders. Inactivity is, namely, an independent risk factor for these health outcomes and physical activity (PA) is, conversely, an important contributor to prevention and treatment of hypertension, blood cholesterol and obesity. Moreover, physical activity diminishes risk of depression, prevent falls in the elderly, may enhance cognitive function and improve academic performance in children.

In spite of numerous current evidence on the health benefits of PA, it seems that relevant policies in many countries are not aware of that, neglect knowledge and experience gained in population health oriented societies, or are very slow in implementation of the issue in political strategy documents and even slower in their applying into practise. Reality takes even more time to translate an evidence-based fact into the public health policy and action. Recent years have witnessed the increased recognition of the need for a broader focus on PA as an irreplaceable sanogenic factor. This postulate gave the initiative for forming and developing HEPA Europe network (HEPA - health-enhancing physical activity), an open system promoting evidence-based health beneficial physical activity, exercise and sport targeting wide population.

In reality, countries interested in implementation of population-based approaches to PA encounter several challenges. Firstly, actions of PA promotion are not resourced commensurate with its potential to promote health and community well-being. This calls for ongoing advocacy efforts within and outside government to foster political commitment and policy development (Bull). Besides that, setting objectives, strategies and action plans oriented to realize them requires cooperative action of a number of state, public and academic institutions and non-governmental organizations, but primarily the profession of public health and kinesiology. Successful predictable approach requires partnership among the mentioned structures where education, transport and urban planning sectors have also an important role.

The Republic of Croatia is one of the developing countries in which among experts in public health and kinesiology awareness of the health significance of PA exists, but also that none of these areas by itself alone can set the goals or perform all tasks according to possible political decisions to take all the steps to create the necessary personnel, material, organizational, financial and other infrastructural requirements for the implementation of strategies and action plans. We here in health system have a very good experience of making national action plans for enhancing PA, but practically nothing was realized. It is to assess that in operative part of the health system (primarily in the primary care) there is no awareness and knowledge and there is a lack of complementary kinesiological infrastructure that would be able to offer programmes and contents encompassing the public health needs of including people of all ages into regular both non-organized or programmed forms of physical activity.

We have recognized that among all potential stakeholders, for the beginning it is important to form a partnership between public health and kinesiology. So, it was quite a natural step to make link with the Faculty of Kinesiology and with their professionals in HEPA deliberate on common efforts in promoting and implementing the idea of broad fan of health enhancing exercise programmes. We assess that close cooperation of health promoting and kinesiology professionals presents a nucleus of further development of the field.

In front of the team there is a difficult and a strenuous task. There are several directions we have to act in, from influence to policy up to prepare education of primary care physicians and leaders and instructors of the Sport for all and fitness organizations and centres.

Here are some of the tasks to be realized for good practice in public health and health kinesiology cooperation.

1. **Consultation** with relevant stakeholders during development of physical activity policy and action plans
2. Adoption of a comprehensive approach to PA promotion using **multiple strategies** (e.g., individual-oriented as well as environmental focused interventions) targeting different population groups (e.g. children, adolescents, women, older adults, disabled people, indigenous people)
3. Working at **different levels** (local, state and national as well as individual, whole community and physical environment level)

4. Development and implementation of the policy and action plan across multiple agencies and settings by **working through coalitions, alliances and partnerships** (e.g. involving cross government, non-government as well as relevant private sector partners)
5. **Integration** of physical activity policy within other health and non-health related agendas (e.g. in the field of health, nutrition, transportation, environment)
6. **Stable base of support and resources** to implement the policy and action plan (e.g. from politicians and government with or without support from other supporting organisations)
7. Development of an **identity** for the physical activity programme by means of a logo, branding and/or slogan. This may include identifying and cultivating a spokesperson or ‘champion’ for the initiatives as well as an advocacy / communication plan;
8. A clear statement of the **timeframe** for implementation of the physical activity plan;
9. Development of **quality management and control** related patient referral and to sport facilities, programmes and instructors’ competences
10. Specific plans and resources for **evaluation** of the efforts to promote physical activity
11. Development and/or maintenance of physical activity **surveillance or monitoring systems** which includes suitable population-level measures of levels of physical (in)activity and related factors;
12. Statement of recognition of existing **national guidelines / recommendations on physical activity** or intent to develop them.

To carry out all the listed items, besides all other things, it is necessary to have well educated and experienced leading staff, combined not only of physicians and kinesiologists, but of a number of experts in various professions as well. Nevertheless, here we are paying attention to the close cooperation of public health and kinesiology professionals. Their collaboration is a driving force for all the activities, from political decisions, strategies, legal documents, action plans and practical implementation from the state to local levels.

So, at the end we are coming to the conclusion that neither physicians nor kinesiologists have necessary knowledge and experience to respond to demands for contemporary approach to health protection and CND prevention by means of appropriate physical activity. As health is the field of medicine and medical personnel and physical activity is the field of kinesiology and kinesiologists, there is a necessity to enable them to get information, knowledge and experience to cooperate in the common field. Therefore the public health strongly recommends the common postgraduate study covering issues of common interest that is in the same time interest of the entire society.

References

1. US Department of Health and Human Services. (2002). Physical Activity Fundamental to Preventing Disease,
2. Bull Fiona, Promoting participation in physical activity, sports and exercise: A public health perspective. British Heart Foundation National Centre for Physical Activity and Health. Paper at personal disposal.
3. World Health Organization. (2004). The WHO Global Strategy on Diet, Physical Activity and Health. Geneva: World Health Organization.
4. Bouchard, C., Blair, S.N., & Haskell, W.L. (Eds.) (2006). Physical Activity and Health. Champaign, IL: Human Kinetics.
5. HEPA, European network for the promotion of health enhancing physical activity. (<http://www.euro.who.int/hepa>)
6. Heimer, S., Jurakić, D., & Rakovac, M. (2011). The Republic of Croatia national action plan for health enhancing physical activity. The agreement with WHO (Registration file 2010-106562).
7. Ministarstvo zdravstva i socijalne skrbi RH. (2007). Akcijski plan za prevenciju i smanjenje prekomjerne tjelesne težine. Ministry of Health and Social Care of Croatia. Action plan for prevention and reduction of overweight.
8. Ministarstvo zdravlja Republike Hrvatske. (2013). Strateški plan razvoja javnog zdravstva 2013. - 2015. (Republic of Croatia Health Ministry. Strategic plan of public health development 2013-2015).

GRASSROOTS SPORTS – A FIELD FOR REALISATION OF HEALTH KINESIOLOGY IDEAS

Rationales for considering sports organisations as stakeholders in health promotion

Herbert Hartmann

German Gymnastic Federation, Germany

The role of grassroots sports in health promotion and prevention

In a recently published review article about setting-based health promotion one can read: *“Sports clubs have a long and traditional history in many countries, yet they remain underdeveloped and underutilized settings for health promotion. Leisure time settings, in general, have been in minor role among settings-based health promotion initiatives”* (Koko, et al., 2013). Is this conclusion correct? Yes and no. On the one hand, it is true that organised sport is a rather undiscovered and neglected stakeholder in the field of health enhancing physical activity promotion and prevention of diseases. Furthermore, organised sport has not been well recognized through the Health Policy, in Public Health Care and particularly in the professional medical-health systems. Organised sport is always confronted with the critical question: would the sport sector be able to offer qualified activities with sufficient and evident health effects? And this was hard to be answered positively in the past.

However, in the meantime the situation has, at least partly, changed. The resistance had been reduced step by step since the sport sector, especially in the area of grassroots sports –together with recreation and fitness organisations and centres –has started to implement quality controlled health enhancing activity- and exercise-programmes in some European countries.

The sport sector is now explicitly mentioned and recognized as an important stakeholder in some National Action Plans aiming at improving the level of people’s physical activities. The “EU Physical Activity Guidelines” (2008, p.14) has assigned an even more prominent position to the organised sport in regard to the improvement of health promoting activities and, particularly, exercise programmes:

“Sport organisations contribute to the social well-being of communities and can ease pressure on the public budget. Through their versatility and cost effectiveness, clubs can help meet the need of the population for physical activity.

A major future challenge for the organised sport sector should be to offer high-quality health related exercises programmes nationwide.”

In this regard some sport organisations in Europe, which operate in the field of grassroots sport as well recreation and fitness organisations and centres can be identified, that have taken up this particular challenge and set up strategies to provide health enhancing sport exercise programmes.¹

Evaluation studies investigating the success of interventions in promoting physical activity suggest placing those actions into well-structured, thematically adequate environments with a big range of coverage (setting orientation).

Mostly, sport organisations follow certain goals in a structured way. Through their versatility and cost-effectiveness they can help to meet the needs for physical activities in their members and in the general population. Grassroots sport organisations in particular have at their disposal educated instructors with the necessary expertise to provide “Health Enhancing Physical Activity” (HEPA) programmes. They are in this regard potentially preferable settings for health prevention and promotion.

Successful interventions in physical activity promotion in settings need considerations in four main fields of action, which are interdependent of each other:

- Appropriate infrastructure (internal policy; working conditions; ...)
- Fitting activity programs
- Defined target groups as participants
- Engaged and qualified instructors and leaders.

Such a holistic intervention need to be based on strategic planning and implementation.

¹ “Health enhancing sport exercise” (HESE) programmes are proven to be more effective and more specific for health effects than customary physical and sportive activities since they, using well-structured physical activity programmes, enhance systematically the fitness factors like endurance, strength, flexibility, coordination and relaxation.



Grassroots sport organisations in action for health promotion

The challenge to provide health enhancing exercise (HESE) programmes as a special type of health enhancing physical activities has been taken up already in Europe by some but few grassroots sport organisations as well as recreation and fitness organisations.

The most active promoter in the non-for-profit area on the international level is the International Sport and Culture Association (ISCA). ISCA has developed its Health Promotion Program and Strategy already in 2007. Several projects were carried out in this field of action under leadership of ISCA with the financial support from the European Commission (PATHE; SANTE; MOVE) including app. 15-20 European grassroots-sport organisations.

The German Gymnastic Federation (DTB) has undoubtedly been the driving force of HEPA initiatives in the sport sector in Germany and wider in Europe. Experience of 20-year-long involvement in HEPA programmes will be outlined.

The general concept of health orientated physical activities as an objective and segment of Sport for All has a long tradition in the DTB, which is the second biggest sport organisation in Germany (5 mill. members) with the focus on grassroots sports. Health enhancing physical activities have been developed as the biggest part of DTB activities (80%) since the first boom of grassroots sports in the beginning of the seventies. But an important step in developing the health perspective was when the Federation started to implement special fitness and health enhancing exercise programmes in the middle of the eighties. The section of HESE-programmes has become a real success story in the Federation:

- 72% of 20,000 gym-clubs offer special HESE-programmes
- 20% of all sport activities within DTB are HESE-programmes
- 25,000 valid instructor licenses for this sector
- 50% of the gym-clubs cooperate with health insurance companies.

But this success, of course, has not occurred from nothing. Sometimes, serious disputes had to be overcome and it took a long way to go. It started in the middle of the 80s with some special fitness and health exercise programmes to reach the current level of scientifically evaluated, evidence-based exercise programmes with quality management system, which have widely been recognised in the health sector.

Development periods of HEPA/HESE programmes in the German Sport System

- The naive period (end of the 80s):
- Characterised by the consideration of new, specific, effect-related programmes for fitness and health promotion. At the same time (first part of the 80s) the commercial fitness-market became more important in Europe (influenced by the professional American companies) and this had retroactive effects on organised sports as well.
- Transition period (1990-1995):
- A turn over from a more general approach to fitness and health (based on activity campaigns) to more specific, highly structured, dose-response related exercise programmes aiming at particular fitness- and health-effects.
- Quality offensive period (1995-2005)
- Renovation period (2006-.....)

Milestones to quality improvement of HEPA/HESE activities in German grassroots sports:

- 1995 DTB launched the first edition of the quality certificate “Pluspunkt Gesundheit. DTB”. More or less a public relation tool with rather indefinite criteria.
- 1996 DSB passes the first edition of the “Quality Criteria to provide HEPA/HESE programmes in club-sport”
- 1997/98 DSB ordered an expert report to analyse health-orientated activities in sport clubs (published in 2002)
- 1998 The Committee for Health in the German Association for Sport Science published the „Concept of Health-Sport“, which is based on 6 core objectives (derived from the WHO-Charter on Health Promotion and the New Public Health discussion)
- 1999 DTB ordered a research project on „Quality Management of Health-Sport in Clubs“.
- 2000 Prevention through physical activity became a legal obligation for health insurance companies. The insurance companies passed common guidelines, fixing special quality standards, demanding high effectiveness.
- 2000 DSB creates the quality certificate „Sport pro Gesundheit“ as an umbrella certificate for all HESpA exercise programmes, getting recognition by the German Medical Council.
- 2001 DTB adopted its „Quality Management Concept“, based on the outcomes of the research project.
- 2005 DTB introduced standardised, evaluated, evidence-based exercise programmes and awarded those programmes with a special mark „Proved for prevention“. (The insurance guidelines had been made more rigorous and demanded evidence-based programmes).
- 2010 DTB changed from a predominantly exercise-programme oriented approach to a more setting orientated approach, including the health perspective of all prevailing conditions of club life (facilities, sanitary installations, food and drinks in club restaurants, co-operation with public health partners,...)



At the beginning of the enforced engagement in explicitly health enhancing exercise programmes we also had been confronted with the resistance from the professional health systems. The main reason for this situation was that the Health System doubted the Sport System would be able to fulfil basic quality criteria of HEPA programmes and to keep them controlled, particularly through sufficiently qualified instructors. Yet, the sport system managed to adapt, in cooperation with the official health institutions (e.g. “German Medical Health Council”), Public Health and Kinesiology experts, to the needs of the health sector.

The DTB created its Quality Management Concept with 10 different elements:

- Instructor qualification with specific profiles related to fitness, health and prevention
- A Brand Mark („Sport Pro Gesundheit“/“Pluspunkt Gesundheit. DTB”), which can be awarded if particular quality criteria are assured.
- Certificate “Präventionsgeprüft”
- Quality circles for the instructors to exchange their experience and to learn from each other (instructor consultation)
- Instructor manuals (10 of them scientifically evaluated) with program-planning according to target groups, health effects, contents, methods of teaching
- Folders for the participants (participant consultation)
- Evaluation forms; e.g. questionnaires for participants at the beginning and the end of a course
- Regular public-relation through the “Pluspunkt-Magazine”
- On-line documentation of all actually carried out certified courses (web-page)
- Scientific advisory group.

The core of this quality management building are scientifically evaluated, evidence-based exercise programmes and particularly educated instructors. Until now the DTB has at its own disposal 10 of these programmes and more than 25,000 instructors to provide these HESE programmes.

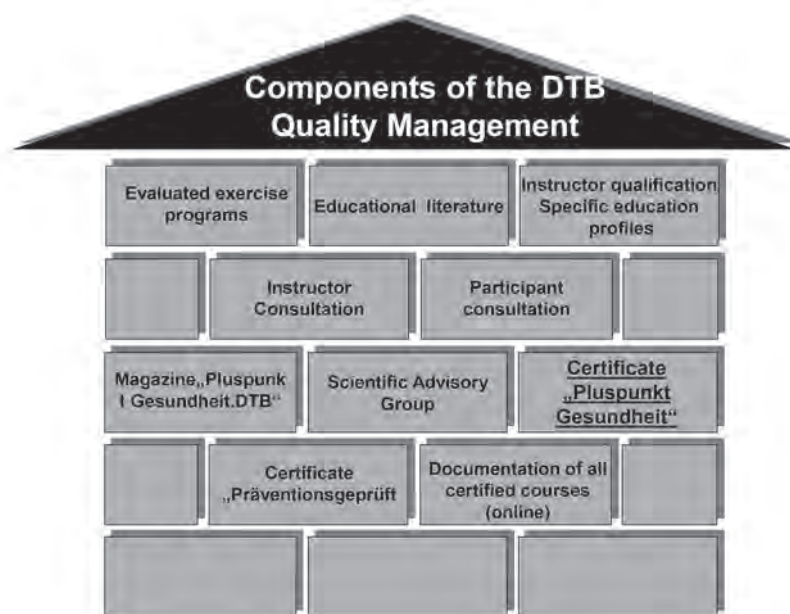

The German quality offensive on HESE interventions has achieved the following so far:

- The Federation was accepted as a member in the national Public Health Organisation and was also welcomed as a partner in other government and non-government health platforms.
- Sport clubs are mentioned as important settings in political documents for prevention strategies.
- Opportunities for public support on HESE related projects increased dynamically.
- Health prevention became a legal obligation for health insurance companies. HESE programmes, offered by sport-clubs, are accepted to be supported by health insurance companies.
- Today the health insurance companies accept the quality mark in the field of primary prevention. However, some insurance companies made quality criteria more rigorous and accept only evidence-based HESE programmes.
- In some German Federal States medical doctors can officially prescribe a “Green Receipt” as a recommendation for patients to visit HESE courses.



**10 evaluated evidence-based HESE-programmes
awarded by the certificate “Präventionsgeprüft”
(proofed for prevention)**

- Cardio Aktiv
- Back fit
- Walking /Nordic Walking
- Healthy and fit – mobilisation
- Appetite for movements – overweight kids
- Training for the back – gentle and effective
- Optiwell – against overweight, for woman
- MOBILIS light – to loose weight, to be more active
- Fit bis ins hohe Alter – prevention from falls
- Safari TurnKids – to loose weight, for kids

Based on a special contract the health insurance companies accept this quality mark without any verification from their side. They pay 80% of the course fee for their members twice a year.

Conclusion

In our days it will be much easier to implement the health perspective and to build capacities in sport organisations than it was 20 years ago:

- The individual and social consciousness for fitness and health has improved.
- National and international political documents can be used as door opener. And they now recognise sport organisations as a competent partner.
- The health sector has become more open to accept the sport sector as a competent stakeholder in the field of health-prevention.
- The way sport organisations with focus on grassroots sport see themselves in their social-political responsibility, has changed to a large extent.
- Cross-sector cooperation between the health- and the sport-sector is recommended in national and international policy documents.
- On the doorstep the cooperation between health professionals, particularly primary care physicians, and grassroots sport organisations with their instructors has been put into practise much more, but need even more attention.
- Medical practitioners are an important door opener and mediator for regular health enhancing physical activity!

Looking back to the last 15-20 years of involvement in HESE programs as a branch of activities within the sport sector one can identify that “quality” and “systematic quality management” are the key words for success and the door opener for the cross-sector cooperation.

THE PROFESSIONAL AND SOCIAL SIGNIFICANCE OF HEALTH KINESIOLOGY FOR EXPERTS IN KINESIOLOGY

Danijel Jurakić and Daniel Bok

Faculty of Kinesiology, University of Zagreb, Croatia

Introduction

Kinesiology is defined as a discipline, or body of knowledge, that focuses on physical activity (Hofman & Harris, 2013). According to the US National Academy of Kinesiology (NAK), the term kinesiology is used to describe a multifaceted field of study which focuses on movement, or physical activity (*National Academy of Kinesiology, 2014*). Although there are many definitions of physical activity, kinesiology professionals usually define physical activity as movements that are intentional, voluntary, and directed towards achieving an identifiable goal (Hofman & Harris, 2013). According to the previously mentioned definition, physical activity includes not only doing sports or exercising for an improvement of fitness and health, but also involvement in daily activities in the domains of work, transportation/commuting, home, and leisure-time. The discipline of kinesiology can be divided into several sub-disciplines such as exercise physiology, movement sciences (motor learning, motor control, and biomechanics), sport and exercise psychology, athletic training and sports medicine, sports administration, physical education, and health promotion. Traditionally, professionals in the field of kinesiology were directed towards physical education, exercise physiology, and movement sciences, but nowadays the attention is being given more and more to other sub-disciplines of kinesiology. One particularly interesting and rapidly developing kinesiology sub-discipline is health promotion. Due to the recognition of physical inactivity as one of the independent risk factors for numerous chronic diseases, which represent a leading cause of premature death worldwide (*World Health Organization, 2013*), the need for collaboration between professionals from the fields of both kinesiology and public health has emerged. Public health is a field that encompasses all the organized measures to prevent disease, promote health, and prolong life among the different populations (*World Health Organization, 2014*). Although back in the 1950s, public health professionals did not recognize the importance of physical activity (PA) for health of the population, numerous scientific studies conducted between 1950 and the mid-1980s led to a change of the mentioned paradigm. As evidences of risk factors (which include poor dietary habits and lack of physical activity) for chronic diseases emerged, the need for studying the previously mentioned risk behaviors increased. In the light of those new evidences, the limits of traditional epidemiology (basic discipline of public health), which had traditionally been oriented towards distribution and etiology of diseases, became apparent (*Sallis, Owen, & Fotheringham, 2000*). Traditional epidemiological data did not provide guidance on how to change behaviors so obviously related to the development of numerous chronic diseases. This has led to the development of a sub-discipline of epidemiology that is called *behavioral epidemiology*. Behavioral epidemiology can be defined as a subset of research that studies the distribution and etiology of health-related behaviors in populations (*Sallis, Owen, & Fotheringham, 2000*). Within behavioral epidemiology, *physical activity epidemiology* has developed as a new field of study that focuses on frequency, patterns, and determinants of PA in different populations and its relations to health and diseases. The other important focus of physical activity epidemiology is evaluation of strategies and interventions created to increase PA of specific populations. With the development of physical activity epidemiology as a study discipline, new professions and specializations in the field of kinesiology have been also developed.

In the following text, we will describe new professions and careers in kinesiology that are related to the field of public health.

Careers in the field of physical activity and public health

People with a graduate degree in kinesiology, especially in Eastern Europe, traditionally have sought their professional careers as physical education teachers, athletic trainers, coaches, and physical recreation specialists. In the recent years, professionals in kinesiology have started being recognized as important team members in clinics and hospitals that are dealing with the prevention and rehabilitation of chronic diseases such as cardiovascular diseases, diabetes, osteoporosis, cancer, and obesity. In the last decade, kinesiology professionals have been seeking their professional careers in the field of public health. There are several titles connected to this profession such as *physical activity practitioner in public health, physical activity and public health specialist, epidemiologist – physical activity*, and *physical activity and health promotion specialists* (The British Association of Sport and Exercise Sciences, 2008; Kohl & Murray, 2012; *American Kinesiology Association, 2013*). That specific profession is growingly present in the United States of America where, in 2006, a new professional organization has been established under the title “The National Society for Physical Activity Practitioners in Public Health” (NSPAPPH). Physical activity and public health specialists can be employed at state and local public health departments working on public health programming for physical activity promotion (Kohl & Murray,

2012). The main characteristics of the previously mentioned job are: cooperating with key agencies and institutions within the public health system to raise the profile of PA by increasing awareness of the health benefits from the participation in it; creating guidelines for physical activity promotion by translating research and Government policy into practice to produce evidence-based source and practical tools for sport, leisure, health and physical activity professionals; developing and promoting initiatives to help health professionals encourage more people to be regularly physically active (The British Association of Sport and Exercise Sciences, 2008); creating and implementing different kinds of physical activity promotion strategies and interventions to increase the level of PA among specific populations. Besides public health departments, physical activity and public health specialists can be employed at private foundations, governmental and non-governmental organizations, charitable organizations, colleges and universities, or anywhere where research is being carried out to promote public health through physical activity, exercise and an active lifestyle (The British Association of Sport and Exercise Sciences, 2008; Kohl and Murray, 2012).

Work in this, in Croatian circumstances new, field, opens for the professionals in kinesiology quite a new place in society. They are becoming close co-workers in health system and share the responsibility for health protection of patients and population with health personnel. This gives them not only a new professional, but also a new social profile, the profile of experts who actively take care for public health on national and local level.

Conclusion

With the recognition of the importance of physical activity for public health, new professions and specializations in the field of kinesiology have been developed. Physical activity and public health specialists are “new” specialists in the field of kinesiology with specific knowledge about frequency, patterns, and determinants of physical activity at population level and its relations to health, as well as with knowledge about methods of physical activity promotion among different populations. These specialists can be employed by the state and local public health departments, private foundations, governmental and non-governmental organizations, charitable organizations, colleges and universities, or anywhere where research is being carried out to promote public health through physical activity.

References

1. American Kinesiology Association. (2013). *Career Center* /on-line/. Retrieved April 10, 2014 from: <http://www.americankinesiology.org/careers-in-kinesiology>
2. Hoffman, S., & Hariss, J.C. (2013). *Introduction to Kinesiology*. In S. Hoffman (Ed.), *Introduction to Kinesiology* (pp. 1-26). Champaign, IL: Human Kinetics.
3. Kohl, W.H., & Murray, T.D. (2012). *Foundations of Physical Activity and Public Health*. Champaign, IL: Human Kinetics.
4. National Academy of Kinesiology (NAK). (2014). *Kinesiology: The Discipline and Related Professions* /on-line/. Retrieved April 10, 2014 from: <http://www.nationalacademyofkinesiology.org/what-is-kinesiology>
5. Sallis, J.F., Owen, N., & Fotheringham, M.J. (2000). Behavioral epidemiology: a systematic framework to classify phases of research on health promotion and disease prevention. *Annals of Behavioral Medicine*, 22(4), 294-298.
6. The British Association of Sport and Exercise Sciences. (2008). *A Guide To Careers in Sports and Exercise Science*. Retrieved April 10, 2014 from: <http://www.bases.org.uk/write/documents/BASES%20Careers%20Guide%20BM%2016%20May%2008%20.pdf>
7. World Health Organization. (2013). *The top 10 causes of death* /on-line/. Retrieved April 10, 2014 from: <http://www.who.int/mediacentre/factsheets/fs310/en/>
8. World Health Organization. (2014). *Public Health* /on-line/. Retrieved April 10, 2014 from: <http://www.who.int/trade/glossary/story076/en/>

SOUTH-EAST EUROPEAN POSTGRADUATE HEALTH KINESIOLOGY STUDY – A PROPOSAL

Goran Sporiš and Stjepan Heimer

Faculty of Kinesiology, University of Zagreb, Croatia

As the fields of physical activity (PA) and public health have developed, it has become clear that many factors at many levels affect behavior related to physical activity. In developed communities, experts have become aware that protection of health is not just a matter that should concern just an individual or only the health care system. Despite solid scientific evidence that regular and even life-long PA and exercise are powerful tools of health protection and prevention of chronic non-communicable diseases (CND), a large part of the population in many countries is not sufficiently active. People should not be left to themselves; they need support and help from closer and wider communities. State, regional and local governments have the obligation to provide legal documents allowing different sectors and non-governmental organizations to implement international and national guidelines and recommendations relating to the role of PA in enhancing health. In this sense, the health system and HEPA in the field of kinesiology have a special place

Another important item that must not be neglected is the national cost of insufficient PA and its influence on development of CND. International studies estimate that approximately 60% of the population in the western world is insufficiently physically active (in developing countries it is almost up to 90%), which rate contributes significantly to nearly 2 million deaths and approximately 10% of the overall burden of disease. The WHO has calculated the cost of physical inactivity for nations of the size of Sweden to be around 800 million euros per year if half of the population is inactive.

The idea of health kinesiology study has been conceived with the purpose to enable experts in kinesiology, public health, primary care and other medical disciplines to work together to advance the use of PA against disease risk factors to diminish and attenuate them in the joint struggle to prevent and treat chronic diseases and other health issues. The mission of the study is to combine knowledge, skills, and abilities related to the basic exercise sciences and public health, to explain and discuss professionally health benefits and risks of exercise and physical activity. Understanding of specific challenges that affect PA and exercise in professional exercise science jobs can clarify how the exercise sciences affect public health, and vice versa.

Physical activity targeting public health is an emerging discipline with many opportunities. Personnel with high education in the area of health kinesiology could be employed at state and local health departments working on public health programming for physical activity promotion. It is expected that many universities will have research opportunities for experts interested in the joint field of PA and public health. According to examples from developed countries, in developing countries future will foster an appropriate interest for such experts in private foundations and non-governmental organizations.

Areas listed below, according to our initial approach, represent the study core areas of the professional postgraduate study Health Kinesiology curriculum development. We expect your professional attention and activity in foreseen later discussion to give the task group valuable remarks and proposals. Your effective participation in the working group for the development of the curriculum will be of great importance in preparing the final document required for the approval and accreditation submission. So, inform us, please, on your competence and good will to join the group that will mainly work through Internet.

Here you may have a look at our initial proposal of the core subject area.

1. The group of basic kinesiology and public health subjects
2. The group of legal and WHO documents and recommendations
3. Subjects covering promotion and implementation of HEPA
4. PA promotion in cooperation with different sectors and NGOs.
5. PA counselling in health system and cooperation with sport recreation and fitness associations and clubs.

It is our opinion that future students/experts in health kinesiology should become familiar with the following topics:

1. The group of basic kinesiology and public health subjects

- Basics of Health Kinesiology
- Public Health
 - Introduction to Public Health
 - Physical Activity and Public Health
 - International Public Health
 - International Physical Activity and Public Health
 - Diagnostics in Public Health

2. The group of legal and WHO documents and recommendations

- International and national documents on nutrition and physical activity (WHO, EU, ACSM and AHA)
- National laws and documents on the activities of public health
- National laws and documents on the activities of sports
- National laws and documents on health and life insurance
- Sports/physical recreation of the persons with disabilities
- Research and methodology principles and techniques in health kinesiology

3. Subjects covering PA promotion and implementation of HEPA

- Sports and Recreational Medicine
- Sports/Physical Recreation and Fitness
- Basics of non-communicable disease epidemiology and causal factors
- Physical activity epidemiology
- Basics of nutrition and healthy eating + sports nutrition
- Ecology + Urban planning
- Organization and structure of the Sport for all

4. PA promotion in cooperation with different sectors and NGOs.

- Development and implementation of intervention strategies to promote public health policy (healthy behaviour, nutrition, PA)
- Development and implementation of relevant health and preventive measures at various levels and in different environments (business, schools, rehabilitation centres) and the target groups (children, adults, elderly, ethnic minorities, etc.), local and regional communities and nationally.
- Communication Science and Public Relations

5. PA counselling in health system and cooperation with sports/physical recreation and fitness associations and clubs.

- Health system cooperation with sport recreation and fitness associations and clubs.
- Theory and techniques of behaviour change to develop an active lifestyle
- Techniques for consultation, counselling and referring in HEPA programmes

6. Required practice.

- Visits to different institutions dealing with health, sport, laws and internship, discussions, round tables and discussions with responsible persons.

CURRICULUM FOR 4-SEMESTER POSTGRADUATE STUDY

No.	GENERAL PART	SEM.	HOURS	ECTS
1.	Introduction to general and health kinesiology	I.	30	
2.	Public health and WHO documents and recommendations	I.	30	
3.	Research and methodology principles and techniques	I.	30	
4.	Total	I.	90	60

No.	SPECIAL PART I.	SEM.	HOURS	ECTS
1.	Sports recreational medicine	II.	30	
2.	Sports recreation and fitness system	II.	10	
3.	Physical activity epidemiology	II.	20	
4.	Interdisciplinary aspects and cooperation in health kinesiology (roles of sectors, institutions and NGO-s)	II.	14	
5.	Legal documents and recommendations	II.	16	
	Total		90	60

No.	SPECIAL PART II.	SEM.	HOURS	ECTS
1.	Sports recreation and public health (HEPA)	III.	30	
2.	Development and implementation of PA and health preventive measures at different levels and domains and target groups	III.	20	
3.	PA counselling in health care system	III.	20	
4.	Evidence based HEPA programmes in sports recreation and fitness	III.	10	
5.	Sports recreation programmes for people with special needs	III.	10	
	Total		90	60

No.	SPECIAL PART III.	SEM.	HOURS	ECTS
1.	Quality criteria and quality mark in health kinesiology programmes offer	IV.	10	
2.	Communication and Public Relations in PA promotion	IV.	10	
3.	Information for clients (flyers, press, TV, Internet)	IV.	10	
4.	Economy and marketing in PA promotion and implementation	IV.	20	
5.	Graduate work	IV.	40	
	Total		90	60

Grand total			360	240
--------------------	--	--	------------	------------

THE EFFECT OF 14 DAYS OF BED REST ON THE LIPID AND INFLAMMATORY PROFILE ON THE ELDERLY

Mario Luca Morieri, Cecilia Soavi, Daniela Francesconi, Juana Maria Sanz,
Sonia Poma, Giovanni Zuliani and Angela Passero

*Department of Medical Sciences, Section of Internal Medicine, Gerontology and Clinical Nutrition,
University of Ferrara, Italy*

Introduction: Physical inactivity in the Elderly reduces quality of life, autonomy and implies higher healthcare costs. Bed Rest (BR) experimental model gives the opportunity to analyze functional and metabolic changes during physical inactivity free of disease bias. The PANGeA group set the horizontal BR model, for the first time in the elderly, to study the effect of the confinement to bed on body composition, lipid and inflammatory profile.

Methods. 23 healthy male subjects were enrolled, divided in “young group” (n=7, 18-25 years) and “elderly group” (n=16, 55-65 years) with similar BMI and body composition. Body composition and blood samples were collected at baseline and after 14 days of BR. Among the elderly, 8 subjects underwent specific Brain Training during BR (Elderly⁺).

Results: At baseline, Elderly group showed higher levels of total (204±39mg/dl vs 151±15mg/dl; P=0,002) and LDL cholesterol (137±34mg/dl vs 89±12mg/dl; P=0,002).

After BR total- and LDL-cholesterol were reduced by 13% and 16% in the Elderly (P<0,002), and by 4.3% and 4% in the Young (P=n.s.). HDL-cholesterol was reduced only in the Young (-17%; P=0,065). Conversely non-HDL cholesterol was significantly reduced only in the elderly (-16%).

C-Reactive Protein and TNF- α were similar at baseline between groups and just TNF- α levels increased significantly in both groups.

Significant weight loss was documented in both groups with decreased FreeFatMass (FFM), total body water (TBW), body cell mass (BCM) and muscular mass (MM).

Elderly⁺ increased HDL levels by 10%, although not significantly, while Elderly⁻ reduced it by 10% (P=n.s.). Total-Cholesterol/HDL-c ratio was reduced by 7% in the Elderly (Elderly⁻ +2%; Elderly⁺ -18%) while it increased by 15% in the Young (ANOVA P=0,03).

Conclusion: As expected BR was associated with weight loss, (decreased FFM, TBW and MM), both in young and elderly subjects, with increased TNF- α levels. While this “catabolic weight loss” was associated with a worsened lipid profile in Young group, in the Elderly an apparent unexpected improvement was observed. At least a part of this improvement seems boosted by Elderly⁺ subjects who performed Brain training. Further analysis are needed to study the possible association between Brain training and lipid profile.

Key words: *BED Rest, lipid Profile, body composition*

INDEX OF AUTHORS

- Abazović Ensar 688
Adamkova Radks 107
Akpinar Selçuk 477
Aleksandrović Marko 598
Ali Gujar Tariq 684
Andreff Wladimir 440
Andrijašević Mirna 369, 703
Antala Branislav 246
Antekolović Ljubomir 120, 196
Auersperger Irena 571
Babič Jan 218
Babić Janko 552
Baca Arnold 229
Bačić Petar 379
Badau Dana 131
Badrić Marko 247
Baić Mario 425, 602
Baković Marijo 120
Balaban Vlado 327
Balaz Jozef 192
Balciunas Mindaugas 615
Balent Boris 490, 537
Ban Đivo 734
Barbaros Tudor Petar 426
Barić Renata 427, 698
Barkidija Marina 348
Bartoluci Mato 479
Bartoluci Sunčica 495
Bašić Kes Vanja 67
Bazanov Boris 428, 434
Bednarik Jakob 440
Bednjarević Nemanja 137
Berčić Herman 334
Bernaciková Martina 77
Bešlija Tea 579
Bilak - Moconja Gorica 327
Bilić Katja 739
Bilinauskaite Milda 72
Biolo Gianni 683, 685
Bizovska Lucia 201
Bjelica Duško 477
Blanco Vega Humberto 370, 576
Blanco Ornelas José R. 370, 576
Blazkova Michaela 187
Bobić Goran 67
Bok Daniel 755
Bokor Igor 260
Boranić Živoder Snježana 451
Bosnar Ksenija 490, 537
Botter Alberto 686
Breda Joao 746
Brekalo Mate 582
Bučkova Kristina 227, 233
Bugala Martin 318
Bund Andreas 228
Cabell Lee 155, 181
Cancellara Lina 682
Caput-Jogunica Romana 692, 703
Casals Cristina 375
Casolo Francesco 575
Ceraj Saša 499
Cerar Katja 696
Cereda Ferdinando 575
Cesnaitiene Vida 328
Charvat Michal 363
Chen Haitao 114
Chovanová Erika 295
Cigrovski Vjekoslav 329
Ciliga Dubravka 27
Cizauskas Ginas 72
Cokorilo Nebojsa 355
Crnjak Matea 31
Csányi Tamas 330
Cvenić Josip 698
Cvijetić Maja S. 547
Čale-Mratović Matija 734
Čavala Marijana 642
Čeklić Urška 253
Čihounková Jitka 503, 544
Čišić Tea 71
Čoh Milan 379
Čorak Sanda 451
Čuić Tanković Ana 291
Čustonja Zrinko 483, 574
Ćurković Sanja 692, 703
Dadeliene Ruta 383, 615
Dadelo Stanislav 707
Dadić Lorena 456
Dadić Marin 588
Danelon Furio 575
Delaš Kalinski Sunčica 430
Di Prampero Pietro 686
Dinold Maria 22
Djordjevic-Šaranović Slavica 123
Do Kim Gun 607
Dolenc Petra 507
Dolibašić Josipa 298
Dopsaj Milivoj 150
Doupona Topić Mojca 572
Dovrtělová Lenka 107
Drapšin Miodrag 375
Drid Patrik 375
Drušković Petra 592
Duysens Jacques 130, 234
Đerek Ana 339
Đukić Branko 520
Đurković Tomislav 429
Elfmark Milan 155
Emeljanovas Arunas 331
Erceg Marko 630
Erceg Tina 257, 430
Filipović Branimir 27, 67
Finn Kevin 330
Floreani Mirco 686
Forko Ana 620
Franc Renata 573
Francesconi Daniela 760
Fučkar Reichel Ksenija 712
Fudurić Morana 478
Furjan Mandić Gordana 343, 731
Gaba Ales 201
Gajević Aco 137, 150
Gajewski Jan 237

Gallo Jiri 174, 575	Idrizović Kemal 598	Katić Ratko 642
Geršić Tajana 662	Ihász Ferenc 330	Kazazović Elvir 94
Geržević Mitja 142, 511	Issurin Vladimir B. 374	Kemeryte-Riaubiene Egle 661
Geržević Tjaša 511	Ivanković Zdravko B. 547	Kezić Ana 257, 579
Ghorbani Saeed 228	Ivanović Jelena 137, 150	Kilani Hashem 121
Filippo Giorgio Di Girolamo 683, 685	Ivaschenko Sergii N. 368	Klaričić Ivana 566
Glavurtić Zlatka 561	Ivković Gordana 82, 98	Knap Bojan 571
Gnezdilova Tatjana 232	Jadrić Ivana 461	Knežević Hrvoje 532
Gošnik Jelka 712	Jakovljević Saša 150	Knjaz Damir 120
Gračan Daniela 348	Jakšić Damjan 440, 477	Kohout Jan 107
Grajauskas Lauras 595	Jakuš Lukrecija 366	Kokinda Marek 611
Grčić-Zubčević Nada 128	Janik Zdenek 431	Kolar Edvard 440, 473
Grčić Vedrana 386	Janíková Andrea 107	Kolarova Katerina 221
Greblo Zrinka 369	Janura Miroslav 155, 174	Köll Ervin 432
Gregov Cvita 620, 658	Janjić Saša 165	Kondrič Miran 229, 696
Grgantov Zoran 630	Jarani Juel 236, 264	Koren Katja 231, 682
Grozdek Čovčić Gordana 366	Jascaniniene Nijoje 661	Korovljev Darinka 355
Gurbuz Bulent 367	Jašić Dajana 660	Korvas Pavel 214
Hadžić Rašid 477	Jelaska Igor 170, 274	Kovacikova Zuzana 201
Harasin Dražen 352	Jenko Miholić Srna 269	Kovačević Erol 94, 688
Hardon Marek 209	Jenko Pražnikar Zala 86	Kovačić Katija 465
Hartmann Herbert 750	Jerin Aleš 571	Krakan Ivan 247, 389
Hassmann Michaela 229	Jerkunica Alen 461	Kreivyte Rasa 393
Heimer Stjepan 742, 757	Jukić Gordana 650	Krespi Marino 274, 436
Heller Mario 229	Jukić Igor 650	Krikstaponyte Ingrida 480
Hirjakova Zuzana 227, 230	Junevicius Gytis 480	Krističević Tomislav 159
Hlavacka Frantisek 227, 230	Juodvirse Virginija 661	Krstulović Saša 386
Hoe Wee Eng 307	Juodzbaliene Vilma 72	Kršak Valerija 31
Hofmann Annette R. 482	Jurak Gregor 440	Kumštát Michal 77, 638
Hökermann Anita 684	Jurak Ivan 196	Kunitson Vladimir 232
Horvat Marina 366	Jurakić Danijel 339, 369, 755	Kunješić Mateja 717
Horvat Vatroslav 260	Jurdana Mihaela 86	Kurková Petra 40
Horvatin-Fučkar Maja 731	Jurgelaitiene Giedre 72	Kutilek Patrik 201
Hoškova Blanka 74	Jurikova Jana 90	Lainščak Mitja 571
Hraski Marijana 260	Kairyte Justina 328	Lanc Dan 322
Hraski Željko 146, 177	Kaj Mónica 330	Lanza Martina 683, 685
Hřebíčková Sylva 252	Kajtna Tanja 571	Laskowski Jacek 237
Hrgetić Marko 389	Kalentiž Živko 520	Laurson Kelly 330
Hrnčiriková Iva 638	Kaminek Petr 174	Lazzer Stefano 231, 686
Hrouzek Michal 107	Kapounková Kateřina 107	Leko Goran 396
Hrusa Petr 516	Karalejić Milivoje 150	Lenard Ana 339
Hrusova Dagmar 36	Karninčić Hrvoje 425, 602	Leskošek Bojan 571
Hupka Dušan 672	Karsai István 330	Lešnik Blaž 218
Hussein Talib 235	Kasa Agron 236	Li Dongjian 414

- Lobotková Jana 230, 233
Lorger Marija 717
Mach Jan 252
Macura Dušan 572
Mahnić Maja 165
Mala Alexandra 107
Malacko Julijan 278, 286
Mandić Jelaska Petra 170, 274
Mandić Miroslav 478
Marelić Nenad 429
Martinaskova Eliska 174
Martinec Petar 352
Marton Orsolya 330
Marušić Uroš 668, 676
Marušić Eli 465
Marušić Zrinka 451
Mašina Tonči 722
Matković Andro 122
Matkovic Branka R. 122
Matković Bojan 329, 426
Mavra Nevja 98
Mayorga-Vega Daniel 370, 576
Mazić Sanja 123
Mazurkiewicz Michał 529
Mazucco Sara 683, 685
McCormick Bryan 103
Medved Vladimir 165
Mendez-Gimenez Antonio 240
Mieziene Brigita 331
Mijić Marko 427
Mikalacki Milena 355
Mikalauskas Dovydas 331
Mikuletić Veronika 142
Milanović Dragan 400, 582
Milanović Luka 436, 588
Milanović Marko 389
Milanović Zoran 247, 436
Milasius Kazys 383
Milčić Lucija 322
Miletić Alen 386
Miletić Đurđica 170, 688
Milić Mirjana 430
Miljković Zvonko 247
Ming-Kai Chin 331
Misjuk Mikola 432
Mišigoj-Duraković Marjeta 303
Mitić Dušan 131
Mo Ching Mok Magdalena 331
Mohab Hamid 57
Mohamed Aboamaed Mabrouk 486
Mohar Sebastian 124
Mohorko Nina 683, 685
Moriari Mario Luca 760
Moro Tatiana 682
Moroscak Jozef 634
Mousa Sarmad Ahmed 57, 486
Možnik Marijo 177
Mraković Snježana 282
Mudronja Lucija 159
Musić Milanović Sanja 748
Mustapić Marko 573
Muvrin Helena 286
Napolitano Salvatore 433
Nedić Antonela 122
Nemčić Tihana 726
Nemec Bojan 218
Nemecek Petr 181
Nikolić Ivana 282
Nova Jana 447
Novak Dario 291
Ochiana Gabriela 43
Ochiana Nicolae 43
Ohnjec Katarina 371
Omrčen Darija 532
Oncu Erman 367
Oreb Goran 561
Ornelas Contreras Martha 370, 576
Ostojić Sergej 375
Ožegović Petra 122
Pacholik Viktor 525
Pantelić Saša 247
Paoli Antonio 682
Passero Angela 760
Paulauskas Rutenis 383, 615
Paušić Jelena 592
Pavlik Jindrich 314
Pavlović Davor 722
Peharec Stanislav 379
Pejčić Aleksandra 278, 286
Perasović Benjamin 573
Perić Marko 469
Petelin Ana 86
Petkus Einius 383
Petrak Slavenka 165
Petričević Duje 465
Petrić Vilko 291
Petrinović Lidija 50
Pieter Willy 607
Pietrzak Piotr 237
Pijnappels Mirjam 234
Pišot Rado 231, 683, 685, 686
Pišot Saša 473, 668
Plavšić Jadranka 132
Plevnik Matej 54
Podnar Hrvoje 329
Poma Sonia 760
Popović Stevo 440, 477
Pori Maja 334
Port Kristijan 232, 434
Poteliuniene Sniegina 661
Potocanac Zrinka 234
Prebeg Goran 131
Prebila Marina 269
Prochazkova Marketa 187
Prot Franjo 537
Prskalo Ivan 247, 269
Psalman Vladimir 192
Pudja Denis 620
Puškarić Radun Nensi 469
Radaš Josipa 343, 731
Radman Ivan 124, 329
Rađa Ante 630
Rađenović Ozren 196
Rafolt Leo 540
Rajua Ahmed 57
Rannama Indrek 432, 434
Raslanas Algirdas 383
Rastovski Dražen 282
Reggiani Carlo 682
Reguli Zdenko 77, 544
Rejc Enrico 231, 686
Rešetar Tomica 429

- Retar Iztok 54, 473
Rogozea Liliana 131
Roy Irina 73
Rupčić Tomislav 120, 122
Rusanov Andrey 73
Rusanova Olga 73
Ruzbarsky Pavel 634
Ružbarská Ingrid 295
Ružić Lana 124
Saint-Maurice Pedro 330
Salah Wisam 235
Sanz Juana Maria 760
Savičević Dejan S. 547
Sebera Martin 544, 680
Sedar Mladen 726
Segedi Ivan 404, 435
Sekot Aleš 359
Selmanović Aleksandar 400, 734
Seman Pavel 107
Sertić Hrvoje 404, 435
Singh Gurmeet 329
Siriški Damjan 525
Situlin Roberta 683, 685
Slačanac Kristijan 602
Smerecka Viera 634
Smolka Ondřej 638
Soavi Cecilia 760
Spahi Andi 236, 264
Sporiš Goran 247, 436, 757
Stančić Sabina 31
Stara Jana 363
Stasiulis Arvydas 127
Stejskal Pavel 107
Steven J. Fleck 578
Stibilj Batinić Tanja 552
Stojanović Marko 375
Strajnić B. 520
Stretch Richard 437
Strikinac Mirna 343
Stupuris Tomas 556
Sturza Milić Nataša 332
Sudarov Nenad 520
Sukreški Marko 662
Supej Matej 218
Svilar Luka 588
Svoboda Zdenek 187, 201
Svobodova Zora 107
Swalgin Kenneth 409
Szczepanowska Ewa 125
Šafarić Zlatko 247
Šalaj Sanja 658
Šarabon Nejc 63
Šenkýř Jan 318
Šerbetar Ivan 205
Šiljeg Klara 396
Šimunić Boštjan 231, 664
Škegro Dario 400, 574
Škof Branko 571
Škorić Sanela 479
Špehar Natalija 712
Šprem Dražen 425
Švaić Vjeran 552
Tafari Domenico 433
Tepla Lucie 187
Tilindiene Ilona 556
Todd Jeremy 592
Tomic Zvonimir 298
Tomašić Marijan 642
Tomljanović Mario 579
Tomljenović Braco 278
Toni M. 572
Toniolo Luana 682
Trajkovski Biljana 298, 303
Trošt Bobić Tatjana 27
Tumynaitė Laura 331
Tursi Daniela 433
Udvardy Michal 237
Ujaković Filip 165
Ushtelenca Keida 264
Vacenovský Pavel 646
Vago Paola 575
Valantine Irena 480
Van Dieën Jaap 234
Vaváček Martin 209
Vencúrik Tomáš 646
Verschueren Sabine 234
Vespalec Tomáš 314
Vetkasov Artem 74
Viciano Jesus 370, 576
Vít Michal 318, 503
Vlašić Jadranka 561
Vodička Tamas 107
Vodička Tomáš 680
Voglar Matej 63
Vorlickova Lucie 214
Vrbek Biserka 692
Vrcić Mensur 94
Vučetić Vlatko 436, 650
Vujanović Snežana 520
Vujkov Nebojša 520
Vujkov Sandra 355
Vuk Saša 417
Vuleta jr. Dinko 566
Waly Mostafa 121
Welk Gregory 330
Wertheimer Vlatka 654
Wessner Barbara 76
Wit Andrzej 237
Witte Kerstin 229
Wychowanski Michal 237
Xu Jianfang 126
Yamada Eiko 422
Zaicenkoviene Kristina 127
Zaletel Petra 582
Zavoreo Iris 67
Zec Josip 461
Zečić Miroslav 426, 722
Zekić Josip 662
Zerbo Šporin Dorjana 111
Zhou Weiai 114
Zhu Weimo 330
Zoretić Dajana 128
Zorko Martin 218
Zubčić Katarina 128
Zubčić David 650
Zuliani Giovanni 760
Zupan Anton 54
Zvonar Martin 221, 680
Žaja Marko 404
Žderić Ivan 98
Živčić Marković Kamenka 159, 322
Žnidarec Čučković Ana 371
Žvan Milan 379

