

# 6th International Scientific Conference on Kinesiology: Integrative power of kinesiology : proceedings book

---

**Andrijašević, Mirna; Antekolović, Ljubomir; Babić, Vesna; Baić, Mario;  
Baković, Marijo; Balent, Boris; Barbaros Tudor, Petar; Barić, Renata;  
Barišić, Valentin; Bartoluci, Mato; ...**

**Edited book / Urednička knjiga**

*Publication status / Verzija rada:* **Published version / Objavljena verzija rada (izdavačev PDF)**

*Publication year / Godina izdavanja:* **2011**

*Permanent link / Trajna poveznica:* <https://um.nsk.hr/um:nbn:hr:117:014109>

*Rights / Prava:* [In copyright](#)/[Zaštićeno autorskim pravom.](#)

*Download date / Datum preuzimanja:* **2025-02-06**



*Repository / Repozitorij:*

[Repository of Faculty of Kinesiology, University of Zagreb - KIFoREP](#)



# 6<sup>th</sup> INTERNATIONAL SCIENTIFIC CONFERENCE ON KINESIOLOGY

## INTEGRATIVE POWER OF KINESIOLOGY



# Proceedings Book

Editors:

**Dragan Milanović and Goran Sporiš**



Organiser: University of Zagreb, Faculty of Kinesiology, Croatia  
Under the patronage of Croatian Academy of Sciences and Arts





# **6<sup>TH</sup> INTERNATIONAL SCIENTIFIC CONFERENCE ON KINESIOLOGY**

**INTEGRATIVE POWER OF KINESIOLOGY**

**Zagreb, Croatia, September 08 – 11, 2011**

# **Proceedings Book**

**Editors:**

**Dragan Milanović and Goran Sporiš**

University of Zagreb, Faculty of Kinesiology  
Zagreb, 2011

- Publisher: University of Zagreb, Faculty of Kinesiology, Croatia
- For the Publisher: Igor Jukić, Dean
- Editors: Dragan Milanović  
Goran Sporiš
- Section Editors: Mirna Andrijašević, Mato Bartoluci, Ksenija Bosnar, Dubravka Ciliga,  
Dražen Harasin, Stjepan Heimer, Igor Jukić, Dragan Milanović, Vladimir Medved,  
Goran Marković, Branka Matković, Marjeta Mišigoj-Duraković, Benjamin Perasović,  
Franjo Prot, Ivan Prskalo
- Section Secretaries: Daniel Bok, Cvita Gregov, Danijel Jurakić, Mario Kasović, Dario Novak,  
Marija Rakovac, Maroje Sorić, Goran Sporiš, Sanja Šalaj, Dario Škegro,  
Sanela Škorić, Tatjana Trošt Bobić
- Indexers: Srećko Sertić, Natalija Babić
- Copyssetting: Srećko Sertić, Natalija Babić
- Layout and Cover: Srećko Sertić
- Printed by: Tiskara Zelina, Croatia
- Edition: 500 copies

Printed in Zagreb, Croatia

A CIP catalogue record for this book is available from the National and University Library in Zagreb under the number 777185

ISBN: 978-953-317-013-8

The statements and views expressed in the contributions are those of their authors and do not necessarily represent those of the Editors and the publisher.

This Proceedings Book includes all the conference communications (invited, oral and poster) received before the editing deadline. Those received later are not published in the book.

**Organiser:** University of Zagreb, Faculty of Kinesiology, Croatia

**Under the patronage of:** Croatian Academy of Sciences and Arts

**In cooperation with:** Faculty of Sport and Physical Education, University of Sarajevo, Bosnia and Herzegovina  
Faculty of Kinesiology, University of Split, Croatia  
Faculty of Physical education and Sports, Comenius University, Bratislava, Slovakia  
Faculty of Sport, University of Ljubljana, Slovenia

**Recognised by:** International Network of Sport and Health Sciences (INSHS)

**Supported by:** World Health Organisation (WHO)

## ORGANISING COMMITTEE

### Chairman:

**Prof. Dragan Milanović, PhD,**  
Faculty of Kinesiology, University of Zagreb, Croatia

### Vice-chairman:

**Dario Škegro, MagKin,**  
Faculty of Kinesiology, University of Zagreb, Croatia

### Conference Secretary:

**Natalija Babić,**  
Faculty of Kinesiology, University of Zagreb, Croatia

### Members:

**Mario Baić, PhD,**  
Faculty of Kinesiology, University of Zagreb, Croatia

**Prof. Mojca Doupona, PhD,**  
Faculty of Sport, University of Ljubljana, Slovenia

**Prof. Stjepan Heimer, PhD,**  
Faculty of Kinesiology, University of Zagreb, Croatia

**Željka Jaklinović, MagA,**  
Faculty of Kinesiology, University of Zagreb, Croatia

**Prof. Igor Jukić, PhD,**  
Faculty of Kinesiology, University of Zagreb, Croatia

**Drago Kalajžić, MagBA,**  
Faculty of Kinesiology, University of Zagreb, Croatia

**Ivan Krakan**  
Faculty of Kinesiology, University of Zagreb, Croatia

**Prof. Đurđica Miletić, PhD,**  
Faculty of Kinesiology, University of Split, Croatia

**Srećko Sertić, MagA,**  
Faculty of Kinesiology's subcontractor, Croatia

**Prof. Nusret Smajlović, PhD,**  
Faculty of Sport and Physical Education, University of Sarajevo, Bosnia and Herzegovina

**Prof. Lubor Tomanek, PhD,**  
Faculty of Physical Education and Sport, Comenius University, Bratislava, Slovakia

**Prof. Dinko Vuleta, PhD,**  
Faculty of Kinesiology, University of Zagreb, Croatia

## SCIENTIFIC COMMITTEE

### Chairman:

**Prof. Franjo Prot, PhD,**  
Faculty of Kinesiology, University of Zagreb, Croatia

### Secretary:

**Prof. Goran Sporiš, PhD,**  
Faculty of Kinesiology, University of Zagreb, Croatia

### CROATIAN MEMBERS:

**Prof. Mirna Andrijašević, PhD,**  
Faculty of Kinesiology, University of Zagreb, Croatia

**Prof. Mato Bartoluci, PhD,**  
Faculty of Kinesiology, University of Zagreb, Croatia

**Prof. Ksenija Bosnar, PhD,**  
Faculty of Kinesiology, University of Zagreb, Croatia

**Prof. Dubravka Ciliga, PhD,**  
Faculty of Kinesiology, University of Zagreb, Croatia

**Prof. Dražen Harasin, PhD,**  
Faculty of Kinesiology, University of Zagreb, Croatia

**Prof. Stjepan Heimer, PhD,**  
Faculty of Kinesiology, University of Zagreb, Croatia

**Prof. Igor Jukić, PhD,**  
Faculty of Kinesiology, University of Zagreb, Croatia

**Prof. Goran Marković, PhD,**  
Faculty of Kinesiology, University of Zagreb, Croatia

**Prof. Branka Matković, PhD,**  
Faculty of Kinesiology, University of Zagreb, Croatia

**Prof. Vladimir Medved, PhD,**  
Faculty of Kinesiology, University of Zagreb, Croatia

**Prof. Dragan Milanović, PhD,**  
Faculty of Kinesiology, University of Zagreb, Croatia

**Prof. Marjeta Mišigoj-Duraković, PhD,**  
Faculty of Kinesiology, University of Zagreb, Croatia

**Prof. Benjamin Perasović, PhD,**  
Faculty of Kinesiology, University of Zagreb, Croatia

**Prof. Franjo Prot, PhD,**  
Faculty of Kinesiology, University of Zagreb, Croatia

**Prof. Ivan Prskalo, PhD,**  
Faculty of Teacher Education, University of Zagreb,  
Croatia

### INTERNATIONAL MEMBERS:

**Prof. Branislav Antala, PhD,**  
Faculty of PE and Sport, University of Bratislava,  
Slovakia

**Prof. Arnold Baca, PhD,**  
Department of Biomechanics/Kinesiology and  
Applied Computer Science, University of Vienna,  
Austria

**Prof. Herman Berčič, PhD,**  
Faculty of Sport, University of Ljubljana, Slovenia

**Prof. David Bishop, PhD,**  
School of Sport and Exercise Science, Institute of  
Sport, Exercise and Active Living (ISEAL), Victoria  
University, Melbourne, Australia

**Prof. Julio Calleja-Gonzales, PhD,**  
Department of Research and Development, Athletic  
Club Bilbao Basque Country, Spain

**Prof. Laura Capranica, PhD,**  
Department of Human Movement and Sport Science,  
University of Rome, Foro Italico, Italy

**Prof. Jay Coakley, PhD,**  
Sociology Department, University of Colorado at  
Colorado Springs, USA

**Prof. Henriette Dancs, PhD,**  
University of West-Hungary, Savaria Campus,  
Institute of Sport Science, Szombathely, Hungary

**Prof. Gudrun Doll-Tepper, PhD,**  
International Council of Sport Science and Physical  
Education, Berlin, Germany

**Prof. Dario Farina, PhD,**  
Department of Neurorehabilitation Engineering,  
Bernstein Center for Computational Neuroscience,  
University Medical Center Göttingen, Germany

**Prof. Ingun Fjørtoft, PhD,**  
Faculty of Arts, Folk Culture and Teacher Education,  
University of Notodden, Norway

**Prof. Juri Hanin, PhD,**  
Research Institute for Olympic Sports, Jyväskylä,  
Finland

**Prof. Jay R. Hoffman, PhD,**  
University of Orlando, Orlando, FL, USA

**Prof. Anita Hökelmann, PhD,**  
Institut for Sport Sciences, Otto-von-Guericke  
University, Magdeburg, Germany

**Prof. Nic James, PhD,**  
University of Middlesex, London, UK

**Prof. Sigmund Loland, PhD,**  
Norwegian University of Sport Science, Oslo, Norway

**Prof. Erich Müller, PhD,**  
Department of Sport Science and Kinesiology,  
University of Salzburg, Austria

**Prof. Pekka Oja, PhD,**  
UKK Institute, Tampere, Finland

**Prof. Claude Sobry, PhD,**  
Faculty of Sport Sciences, University of Lille, France

**Prof. Jozsef Tihanyi, PhD,**  
Department of Biomechanics, Faculty of Physical  
Education and Sports Sciences, Semmelweis  
University, Budapest, Hungary

**Prof. Katarina Tomljenović-Borer, PhD,**  
Department of Movement Science, Division of  
Kinesiology, University of Michigan, USA

**Prof. Weimo Zhu, PhD,**  
University of Illinois at Urbana-Champaign, IL, USA

## HONORARY COMMITTEE

- Prof. Aleksa Bjeliš, PhD,  
Rector, University of Zagreb, Croatia
- Prof. Emeritus Vladimir Findak, PhD,  
Faculty of Kinesiology, University of Zagreb, Croatia
- Prof. Radovan Fuchs, PhD,  
Minister, Ministry of Science, Education and Sport of the Republic of Croatia
- Prof. Pilvikki Heikinaro-Johansson, PhD,  
President, International Association for Physical Education in Higher Education (AIESEP), Jyväskylä, Finland
- Prof. Miroslav Holienka, PhD,  
Dean, Faculty of Physical Education and Sport, Comenius University, Bratislava, Slovakia
- Prof. Hans Hoppeler, PhD,  
President, European College of Sport Science (ECSS), Bern, Switzerland
- Prof. Melita Kovačević, PhD,  
Vice-Rector for Science, University of Zagreb, Croatia
- FCA Zvonko Kusić, PhD,  
President, Croatian Academy of Sciences and Arts, Zagreb, Croatia
- Prof. Boris Maleš, PhD,  
Dean, Faculty of Kinesiology, University of Split, Croatia
- Zlatko Mateša, PhD,  
President, Croatian Olympic Committee, Zagreb, Croatia
- Prof. Izet Rađo,  
Dean, Faculty of Sport and Physical Education, University of Sarajevo, Bosnia and Herzegovina
- FCA Pavao Rudan, PhD,  
Secretary, Croatian Academy of Sciences and Arts, Zagreb, Croatia
- Prof. Włodzimierz Starosta, PhD,  
President, International Association of Sport Kinetics (IASK), Warsaw, Poland
- Prof. Valter Tokarski, PhD,  
President, European Network of Sport Science, Education and Employment (ENSSHE), Cologne, Germany
- Prof. Milan Žvan, PhD,  
Dean, Faculty of Sport, University of Ljubljana, Slovenia

## TECHNICAL STAFF

- Ivana Bašić, Faculty of Kinesiology, University of Zagreb, Croatia
- Ines Čavar, Faculty of Kinesiology, University of Zagreb, Croatia
- Ivana Degirmendžić, Faculty of Kinesiology, University of Zagreb, Croatia
- Stipe Gorenjak, Faculty of Kinesiology, University of Zagreb, Croatia
- Marko Korbar, Faculty of Kinesiology, University of Zagreb, Croatia
- Ivan Krakanić, Faculty of Kinesiology, University of Zagreb, Croatia
- Fedor Kulušić, Faculty of Kinesiology, University of Zagreb, Croatia
- Danijela Gudelj, Faculty of Kinesiology, University of Zagreb, Croatia
- Dorijan Jelinčić, Faculty of Kinesiology, University of Zagreb, Croatia
- Jurica Marković, Faculty of Kinesiology, University of Zagreb, Croatia
- Lucija Mudronja, Faculty of Kinesiology, University of Zagreb, Croatia
- Mirta Podvalej, Faculty of Kinesiology, University of Zagreb, Croatia
- Lucija Radovčić, Faculty of Kinesiology, University of Zagreb, Croatia
- Filip Ujaković, Faculty of Kinesiology, University of Zagreb, Croatia



## ***Dear colleagues, Conference delegates and Proceedings' readers,***

The Faculty of Kinesiology University of Zagreb is organising the International Conference on Kinesiology for the sixth time. Everything began more than 15 years ago when the initiators – Prof. Milanović, still bursting with new ideas, and the late Prof. Mraković, started to advocate the idea of an international conference as a forum for kinesiologists or sport scientists, as a place where their research findings could be presented and discussed, as a meeting point of globally recognized scientists, or authorities in their field of research and research novices. In those days, in 1997, before the First Conference in Dubrovnik, it all seemed so surreal. However, this conference is alive; it grows and becomes ever more sophisticated. Therefore, it is feasible to expect that the forthcoming discussions, talks, dialogues, or whatever kind of idea exchange will result, as they have until now, with new research ideas, insights, research teams and projects the eventual outcome of which is further advances in kinesiology and the cognate and adjacent scientific areas.

The motto of this year's conference is the "Integrative Power of Kinesiology". It indicates the close relationships among various scientific fields when they contribute to the promotion of physical exercise and various kinds of physical activities in the areas of kinesiological education, high performance sports, kinesiological recreation, health-enhanced kinesiology, kinesitherapy and rehabilitation, sport for physically and mentally challenged persons, school sports, military kinesiology, and many others.

Simultaneously with the organisation of the 6<sup>th</sup> Conference, the Faculty of Kinesiology is celebrating the 40<sup>th</sup> anniversary of the publication of the scientific journal KINESIOLOGY. Nowadays it is a recognized international scientific journal with an IF of 0.525 for the year 2010.

The Conference and the journal KINESIOLOGY have contributed considerably to the affirmation of the name "kinesiology" in the neighbouring European areas. Although both are focused on science, the Conference and the accompanying regular KINESIOLOGY International Editorial Board meetings have also been opportunities for scholars and institution delegates from all over the world to establish close personal contacts, thus opening doors for joint research projects. The basic scientific concept of the Conference, with the working sections that cover the fundamental and applicative disciplines of kinesiology, has been kept from the beginning. This year's conference will have 12 oral and poster sections in the framework of which the delegates will present 220 full text contributions and abstracts written by 300 authors from 32 countries. Each presented and published paper or abstract has been subjected to a review process performed by at least two prominent referees.

For the first time the Conference is hosting a satellite symposium HEPA (Health Enhanced Physical Activity). The purpose of the symposium is to inform delegates from the neighbouring countries, which have not yet become HEPA association member countries, with the basic principles and directives of the movement and to encourage them to become promoters of the idea of health-oriented physical activity in their communities. The World Health Organization has stimulated the design of the Croatian National Action Plan for the implementation and improvement of HEPA in the Republic of Croatia. A presentation of the Action Plan and the planned round table should also be stimulating to colleagues to undertake similar steps in their communities.

From the very beginning the Croatian Academy of Sciences and Fine Arts has given its highly respected patronage to the Conference, thus underpinning the recognition of kinesiology in the structure of sciences. The organisation of such conferences would not be viable without the powerful support from the Croatian Ministry of Science, Education and Sport and the University of Zagreb. The patronage and support are indicators of a notable position the Conference and its organiser, the Faculty of Kinesiology University of Zagreb (established in 1959), have in the Croatian academic and research community.

We wish to express much gratitude to all the authors of the papers, reviewers, conference participants, members of the Organisation Committee, Section Leaders, Section Secretaries, technical support staff, and sponsors for their contributions, time and effort inbuilt in the quality of the 6<sup>th</sup> Conference on Kinesiology and its Proceedings. Our special gratitude goes to the Croatian Office of the World Health Organization.

We wish success in the conference work to all the participants and enjoyable time in Opatija. We are convinced the Conference will give the expected impetus to further cooperation between scholars and institutions. Looking forward in advance to meeting you again at the 7<sup>th</sup> International Conference on Kinesiology in 2014.

The Organising Committee

## CONTENTS

**PREFACE** ..... 6

### KEY-NOTE LECTURES

#### OPENING CEREMONY LECTURES

**Sigmund Loland**  
SPORT SCIENCES – CURRENT CHALLENGES AND FUTURE POSSIBILITIES ..... 22

**David Bishop**  
THE FUTURE OF SPORT AND SCIENCE ..... 23

#### PLENARY LECTURES

**Branislav Antala**  
SCHOOL PHYSICAL EDUCATION YESTERDAY AND TODAY  
– COMPARISON OF SOME INDICATORS IN 1990 AND 2010 ..... 24

**Herman Berčič and Boris Sila**  
FINDINGS FROM THE RESEARCH STUDIES ON SPORTS  
RECREATIONAL ACTIVITIES OF SLOVENIAN PEOPLE ..... 31

**Laura Capranica**  
YOUTH COMPETITIONS: WHAT MODEL? ..... 37

**Jay Coakley**  
USING SOCIAL RESEARCH AND THEORY TO INFORM  
PUBLIC POLICIES INVOLVING SPORT ..... 38

**Gudrun Doll-Tepper**  
ADAPTED PHYSICAL ACTIVITY AND INCLUSION – TOWARDS IMPLEMENTING  
THE UN CONVENTION ON THE RIGHTS OF PERSONS WITH DISABILITIES ..... 39

**Dario Farina**  
THE EXTRACTION OF NEURAL STRATEGIES FOR MOVEMENT CONTROL  
FROM THE ELECTROMYOGRAM: LIMITATIONS AND POSSIBILITIES ..... 40

**Jay R. Hoffman**  
SPORT SCIENCE: BRIDGING THE GAP BETWEEN  
THE LABORATORY AND THE FIELD ..... 41

**Erich Müller**  
OPTIMIZING TRAINING QUALITY IN ELITE SPORT ..... 42

**Pekka Oja**  
HEALTH-ENHANCING PHYSICAL ACTIVITY: ROOTS, AIMS,  
ORGANISATION, CURRENT STATE AND PERSPECTIVES ..... 43

**Claude Sobry**  
FOR A RESPONSIBLE SPORTS TOURISM  
AND A LOCAL SUSTAINABLE DEVELOPMENT ..... 50

**Katarina Tomljenović Borer**  
WHY EXERCISE IS A NECESSARY ADJUNCT TO DIETING WHEN THE PURPOSE IS WEIGHT LOSS ..... 55

**Weimo Zhu**  
SETTING STANDARDS IN YOUTH FITNESS TESTING:  
PROBLEMS, SOLUTIONS, AND FUTURE DIRECTIONS ..... 59

## SECTIONS

### ADAPTED PHYSICAL ACTIVITY AND KINESITHERAPY

<b>Dubravka Ciliga, Tatjana Trošt Bobić and Angel Naumovski</b> DIFFERENCES IN CERTAIN MOTOR ABILITIES BETWEEN CHILDREN WITH SPEECH DISORDERS AND CHILDREN WITH HEARING IMPAIRMENT .....	62
<b>Lidija Petrinović Zekan, Dubravka Ciliga and Drena Trkulja-Petković</b> RESEARCH ON SPORT ACTIVITY IN PERSONS WITH DISABILITY IN CROATIA .....	67
<b>Bryan P. McCormick, Gretchen Snethen and Rachel L. Smith</b> EXAMINING CULTURAL DIFFERENCES IN PHYSICAL ACTIVITY AMONG PEOPLE WITH SCHIZOPHRENIA .....	73
<b>Asim Bradić, Erol Kovačević and Josipa Bradić</b> DIFFERENCES IN THE SIZE OF UNILATERAL ISOKINETIC EFFECTS WITH REGARD TO ANGULAR SPEED OF TRAINING .....	77
<b>Josipa Bradić, Erol Kovačević and Fuad Babajić</b> EFFECTS OF UNILATERAL STRENGTH TRAINING ON BALANCE PERFORMANCE .....	82
<b>Senka Rendulić Slivar, Oto Kraml and Jelena Pecikoza</b> KINESIOLOGICAL TRANSFORMATION WITHOUT KINESITHERAPY – EFFECTS OF INDIVIDUAL HYDROTHERAPY ON OSTEOARTHRITIS IN THE SPA PROGRAM .....	86
<b>Dagmar Travnikova and Jitka Koprivova</b> USE OF JUGGLING AS A SUITABLE PSYCHOMOTOR ACTIVITY IN PERSONS WITH SPECIAL NEEDS .....	90
<b>Raphael Béné, Iris Zavoreo and Vida Demarin</b> MIRROR BOX THERAPY FOR STROKE SURVIVORS: A NEW WAY TO VISUALIZE MOVEMENTS .....	93
<b>Frane Grubišić, Damjan Radulović, Mario Bagat and Josip Kovačević</b> DOES CERTAIN SOCIODEMOGRAPHIC FEATURES INFLUENCE THE FREQUENCY OF EXERCISING IN PATIENTS WITH ANKYLOSING SPONDYLITIS? .....	94
<b>Dagmar Králová</b> A CASE STUDY MODEL: THE ROLE OF KINESIO TAPE IN OPTIMALIZATION OF SHOULDER GIRDLE MOVEMENT STEREOTYPE OF VOLLEYBALL PLAYERS .....	95

### BIOLOGY AND MEDICINE OF SPORT AND EXERCISE

<b>Ingunn Fjørtoft</b> LEARNING LANDSCAPES: CONTEXTUAL RELATIONS BETWEEN ENVIRONMENTS, PHYSICAL ACTIVITY AND MOTOR LEARNING .....	98
<b>Petar Barbaros-Tudor, Ivan Radman and Gordan Janković</b> NUTRITIONAL KNOWLEDGE AND DIETARY HABITS OF CROATIAN TENNIS COACHES .....	102
<b>Vjekoslav Cigrovski, Branka Matković and Ivan Radman</b> NUTRITION KNOWLEDGE AND HABITS SURVEY AMONG STUDENTS OF SPORT FACULTIES OF ZAGREB AND BRATISLAVA .....	106
<b>Jelena Macan, Mario Baić and Goran Romić</b> FREQUENCY OF ALLERGIC DISEASES AMONG WRESTLING AND KARATE TRAINEES .....	111
<b>Petra Mandić-Jelaska, Fredi Fiorentini and Dario Bašić</b> DOPING, NUTRITION AND CHAMPIONSHIP RANKING CORELLATION IN THE CROATIAN FEMALE SOCCER .....	115
<b>Tomislav Rupčić, Andro Matković and Katarina Nabršnigg</b> AEROBIC CAPACITY OF BASKETBALL REFEREES .....	120

<b>Lise Kjoenniksen, Ingunn Fjørtoft and Nora Wium</b> PHYSICAL ACTIVITY IN SCHOOL – THE EFFECTS OF TWO EXTRA LESSONS OF PHYSICAL ACTIVITY ON 10 AND 12 YEARS OLD SCHOOLCHILDREN .....	123
<b>Anita Hökelmann, Peter Blaser, Wolfgang Lehmann and Kristinn Heinrichs</b> EFFECT OF CONTINUOUS MOTOR LEARNING WITH DANCE AND MUSIC ON PHYSICAL AND MENTAL FITNESS IN THE OLDER POPULATION: THE MAGDEBURG DANCE STUDY .....	124
<b>Gaizka Mejuto, Julio Calleja-González, Josean Lekue, Xabier Leibar, Julen Erauzkin, Maialen Beldarrain, Ramón Gárate and Nicolás Terrados</b> HEMATOLOGICAL ADAPTATION IN AN ELITE HIMALAYIST CLIMBER? A SINGLE CASE STUDY .....	125
<b>Pavle Mikulić, Allan M. Nevill and Goran Marković</b> MODELING LONGITUDINAL CHANGES IN MAXIMAL-INTENSITY EXERCISE PERFORMANCE IN YOUNG ROWING ATHLETES .....	126
<b>Antonela Nedić, Tomislav Rupčić and Marko Meštrov</b> MORPHOLOGICAL CHARACTERISTICS OF FEMALE HANDBALL PLAYERS .....	127
<b>Jadranka N. Plavšić, Nebojša S. Antić, Slavica A. Đorđević-Šaranović, Tamara D. Gavrilović and Sanja Mazić</b> CHANGES IN ANTHROPOMETRIC PARAMETERS AND OXYGEN CONSUMPTION IN SOCCER PLAYERS DURING THE CONDITIONING PERIOD .....	128
<b>Lana Ružić, Mario Kasović, Anton Tudor, Vjekoslav Cigrovski and Bojan Matković</b> THE INFLUENCE OF THE SKI HELMETS ON SOUND LOCALIZATION AND DISTANCE IDENTIFICATION ON SKI SLOPES .....	129
<b>Maroje Sorić, Mirjana Jembrek Gostović, Mladen Gostović, Marija Hoćevar and Marjeta Mišigoj-Duraković</b> TRACKING OF CARDIORESPIRATORY FITNESS AND FATNESS FROM ADOLESCENCE TO MIDDLE ADULTHOOD .....	130
<b>Gregor Starc, Marjeta Kovač, Gregor Jurak, Saša Dremelj, Petra Kovač, Marjeta Mišigoj-Duraković, Maroje Sorić and Janko Strel</b> DAILY ENERGY INTAKE, PHYSICAL ACTIVITY AND PHYSICAL FITNESS LEVELS AND SOME EATING HABITS OF 11-YEAR-OLD STUDENTS .....	131
<b>Tatjana Trivić</b> IMPACT OF WEIGHT LOSS ON HEMATOLOGICAL PARAMETERS IN MALE JUDOKAS .....	132
<b>BIOMECHANICS AND MOTOR CONTROL</b>	
<b>Arnold Baca</b> COMPUTER ASSISTED FEEDBACK IN PHYSICAL EDUCATION .....	134
<b>Jan Babiak, Branislav Strajnić, Nenad Sudarov, Jugoslav Vojinović and Žika Kalentić</b> MUSCLE FORCE HARMONIC CANON OF TOP KARATE ATHLETES AND WRESTLERS .....	138
<b>Duško Bjelica, Georgi Georgiev and Stevo Popović</b> COMPARISON OF INSTEP KICKING BY THE PREFERRED LEG AMONG VARIOUS STATES AND INTENSITIES IN YOUNG FOOTBALL PLAYERS .....	141
<b>Iva Blažević, Vesna Babić and Milan Čoh</b> CHILDREN'S 50 METRES RUNNING DYNAMICS .....	146
<b>Simone Ciacci and Elisa Bianchi</b> A 3D ANALYSIS OF GRAND JÉTÉ: COMPARISON BETWEEN GENDERS. A PILOT STUDY .....	151
<b>Grzegorz Juras and Kajetan Słomka</b> ANTICIPATORY POSTURAL ADJUSTMENTS IN THROWING TASKS .....	154
<b>Mario Kasović, Željko Heimer and Vladimir Medved</b> COLOURED SIGNAL CODING IN COMPUTERIZED HUMAN GAIT ANALYSIS .....	155

<b>Tomislav Krističević, Mladen Mejovšek and Saša Baščevan</b> COMPARATIVE KINEMATIC ANALYSIS OF PREPARATION PHASE OF TAKE-OFF IN ACROBATIC ELEMENTS FROM “STUFF POSITION” .....	158
<b>Mark L. Latash, Alexander S. Aruin, Miriam Klous, Vennila Krishnan and Pavle Mikulić</b> FEED-FORWARD POSTURAL ADJUSTMENTS TO ACTION .....	163
<b>Miha Marinšek</b> THE CENTRE OF PRESSURE OF THE DOMINANT AND NON-DOMINANT FOOT IN QUIET STANCE IN 5-YEAR-OLD CHILDREN .....	164
<b>Franco Merni, Silvia Fantozzi, Simone Ciacci, Laura Querin and Rocco Di Michele</b> TAKE-OFF KINEMATICS OF THE TRIPLE LUTZ IN ARTISTIC ROLLER SKATING .....	168
<b>Fadil Rexhepi and Željko Hraski</b> COMPARISON OF SOME BIOMECHANICAL, SPATIAL, TEMPORAL AND VELOCITY PARAMETERS IN THE JUDO THROWING TECHNIQUES OSOTO GARI AND UCHI-MATA .....	172
<b>Mirela Shao</b> WAYS OF IMPROVING VOLLEYBALL PLAYERS’ TECHNIQUE BY MEANS OF INTEGRATING DIRPAS-NS2006 SYSTEM WITHIN THEIR TRAINING .....	176
<b>Kajetan Slomka</b> POSTURAL CONTROL OF ADVANCED YOGA PRACTITIONERS .....	181
<b>Tatjana Trošt Bobić</b> UNILATERAL BALLISTIC ANKLE STRENGTH TRAINING IMPROVES CONTRALATERAL MAXIMAL STRENGTH AND BALANCE .....	182
<b>Romina Umer, Mitja Geržević and Vojko Strojnik</b> VALIDITY OF MEASURING MUSCLE ACTIVATION LEVELS WITH HYDRAULIC SYSTEMS .....	188
<b>KINESIOLOGICAL EDUCATION</b>	
<b>Ljubomir Antekolović, Marijo Baković and Hrvoje Ajman</b> CAN THE USE OF HANDHELD EXTRA WEIGHTS IMPROVE STANDING LONG JUMP PERFORMANCE? .....	194
<b>Marijana Arapović and Lejla Šebić</b> RELATIONS OF BASIC MOTOR SKILLS AND STYLIZED MOVE STRUCTURES OF FIGURE SKATING .....	198
<b>Marijo Baković, Saša Baščevan and Ljubomir Antekolović</b> PREDICTION OF HIGH JUMP RESULTS FOR KINESIOLOGY STUDENTS .....	203
<b>Ana Božanić, Jure Benić and Damir Mumanović</b> OVERWEIGHT AND OBESITY AS LIMITATION FACTORS OF AGILITY AND STRENGTH DEVELOPMENT .....	207
<b>Nevenka Breslauer and Kamenka Živčić Marković</b> CHANGES IN MOTOR ABILITIES OF THE FIFTH GRADE PUPILS DUE TO A ONE-YEAR MODIFIED PHYSICAL EDUCATION PROGRAMME .....	211
<b>Urška Čeklić, Matej Plevnik and Rado Pišot</b> SPEED OF CRAWLING IN 4- TO 5-YEAR-OLD CHILDREN .....	215
<b>Sunčica Delaš Kalinski, Petra Mandić Jelaska and Almir Atiković</b> INFLUENCE OF SOME MOTOR ABILITIES ON THE BASIC GYMNASTICS SKILLS PERFORMANCE THROUGH THE LEARNING PROCESS .....	219
<b>Vladimir Findak and Ivan Prskalo</b> KINESIOLOGICAL PREVENTION – AN IMPORTANT FACTOR IN THE INTEGRATIVE POWER OF KINESIOLOGY .....	223

<b>Jelka Gošnik, Natalija Špehar and Ksenija Fučkar Reichel</b> VALIDATION OF THE SCALES FOR ASSESSING SWIMMING ABILITIES OF STUDENTS AT THE FACULTY OF HUMANITIES AND SOCIAL SCIENCES IN ZAGREB .....	226
<b>Zrinka Greblo and Renata Barić</b> DETERMINANTS OF ENJOYMENT AND PRESSURE IN PE LESSONS AMONG ELEMENTARY AND HIGH SCHOOL STUDENTS .....	230
<b>Vatroslav Horvat, Nevenka Breslauer and Ksenija Pletenac</b> STUDENTS' STANDPOINTS ON THE NECESSITY OF PHYSICAL EXERCISE .....	234
<b>Marijana Hraski, Vatroslav Horvat and Iva Horvat</b> RELIABILITY OF AN INSTRUMENT FOR ASSESSING STANDING LONG JUMP PERFORMANCE IN PRESCHOOL CHILDREN .....	235
<b>Srna Jenko-Miholić, Andrea Čižmek and Josipa Peršun</b> DIFFERENCES IN MORPHOLOGICAL CHARACTERISTICS, MOTOR SKILLS AND BMI BETWEEN FEMALE HIGH SCHOOL STUDENTS AGE 14-18 ENGAGED IN SOME RECREATIONAL PROGRAM AND THOSE LACKING ANY .....	238
<b>Besalet Kazazović, Edin Mirvić and Almir Popo</b> VALIDATION OF THE REDUCED TRAINING PROGRAM FOR NON-SWIMMERS YOUNGER STUDENTS .....	244
<b>Katja Koren, Boštjan Šimunič and Rado Pišot</b> HOW HIGH PRESCHOOL CHILDREN JUMP? .....	245
<b>Jana Labudová, Oľga Kyselovičová and Veronika Tirpáková</b> CAREER OPTIONS OF AEROBICS AND AQUA FITNESS INSTRUCTORS IN LIFELONG LEARNING IN SLOVAKIA .....	250
<b>Julijan Malacko, Aleksandra Pejčić and Biljana Trajkovski</b> SEXUAL DIFFERENTIATION OF MORPHOLOGICAL CHARACTERISTICS AND MOTOR ABILITIES OF 11-YEAR-OLD CHILDREN .....	251
<b>Edin Mirvić</b> THE INFLUENCE OF MORPHOLOGICAL CHARACTERISTICS ON THE FREESTYLE SWIMMING AMONG VOCATIONAL HIGH SCHOOLS IN SARAJEVO .....	256
<b>Valentina Moisiej and Massimo Lanza</b> SCHOOL FOR HEALTH: PAQ-C QUESTIONNAIRE CORRELATION WITH FACTORS OF ACTIVE LIFESTYLE IN CHILDREN .....	259
<b>Snježana Mraković, Marijana Hraski and Marija Lorgner</b> DIFFERENCES IN PREFERENCES TOWARDS SPORT ACTIVITIES OF FEMALE STUDENTS WITH THE UNIVERSITY OF ZAGREB .....	260
<b>Miran Muhić</b> COMPETENCES OF EDUCATORS IN THE KINDERGARTEN IN THE FIELD OF SPORT .....	264
<b>Boris Neljak, Hrvoje Podnar and Ivan Krakanić</b> URBAN-RURAL DIFFERENCES IN MOTOR ABILITIES AMONG THE 7 <sup>TH</sup> GRADE PRIMARY SCHOOL BOYS IN THE REPUBLIC OF CROATIA .....	267
<b>Dario Novak, Ivan Zupčić and Hrvoje Podnar</b> ANALYSIS OF WORKLOAD DURING EXERCISE WITH THE IMPLEMENTATION OF VARIOUS CONTENTS IN THE MAIN PART OF THE LESSON .....	272
<b>Goran Oreb, Nikola Prlendić and Danijela Kostanić</b> DIFFERENCES BETWEEN MEN AND WOMEN IN EFFECTIVENESS OF WINDSURF TEACHING .....	276
<b>Aleksandra Pejčić, Biljana Trajkovski Višić and Julijan Malacko</b> CANONICAL RELATIONS BETWEEN THE SYSTEMS OF MORPHOLOGICAL AND MOTOR VARIABLES WITH THE PRESCHOOL-AGE GIRLS .....	279

<b>Josipa Peršun, Srna Jenko Miholić and Ivan Vrbik</b> DIFFERENCES IN MORPHOLOGICAL CHARACTERISTICS AND MOTOR SKILLS BETWEEN HIGH SCHOOL GIRLS AND BOYS .....	284
<b>Luka Pezelj, Damir Mumanović and Frane Žuvela</b> GENDER BASED MOTOR CONDITIONALITY OF FUDAMENTAL MOVEMENT SKILLS .....	290
<b>Saša Pišot</b> COVERT INACTIVE PARTICIPANT OBSERVATION OF SPORTS VENUE .....	294
<b>Matej Plevnik</b> FUNDAMENTAL MOTOR PATTERNS IN KINDERGARTEN .....	297
<b>Faris Rašidagić</b> INFLUENCE OF MOTOR ABILITIES ON SUCCESSFUL PERFORMAMANCE OF HANDBALL ELEMENTS IN THE TEACHING OF SPORT AND PHYSICAL EDUCATION .....	300
<b>Javier Sampedro, Jorge Lorenzo and Jesus Rivilla</b> EFFECT OF NEW TECHNOLOGIES ON THE ABILITY TO ANALYZE SPORTS SITUATIONS IN UNIVERSITY STUDENTS .....	305
<b>Nusret Smajlović and Slavenko Likić</b> LEVELS AND STRUCTURES OF SPEED AND STRENGTH QUALITIES OF BOYS OF DIFFERENT MAXIMUM RUNNING SPEED LEVELS .....	309
<b>Vesna Štemberger, Damir Knjaz and Ljubor Tomanek</b> COMPARISION BETWEEN ELEMENTARY SCHOOL TEACHER AND PHYSICAL EDUCATION TEACHER FROM SLOVENIA, CROATIA AND SLOVAKIA IN SOME OF THE HEALTH DIMENSIONS .....	314
<b>Braco Tomljenović, Ivan Radošević and Frane Tomljenović</b> DIFFERENCES IN ANTHROPOLOGICAL FEATURES AMONG PUPILS IN THE FIFTH, SIXTH, SEVENTH AND EIGHTH GRADES IN REGULAR CLASSES AND PUPILS ORGANIZED IN SPORTS ACTIVITIES IN GOSPIĆ .....	318
<b>Jadranka Vlašić, Stjepka Leščić and Goran Oreb</b> ATTENDANCE AT DANCE CLASSES IN RELATION TO DANCE RESULTS .....	321
<b>Kamenka Živčić Marković and Ines Čavar</b> THE DIFFERENCES IN THE MOTOR PREKNOWLEDGE OF ARTISTIC GYMNASTICS AMONG THE FEMALE STUDENTS OF FACULTY OF KINESIOLOGY .....	326
<b>Frane Žuvela, Saša Krstulović and Danijela Kuna</b> RELATIONSHIP BETWEEN MOTOR-FUNCTIONAL ABILITIES AND FUNDAMENTAL MOVEMENT SKILLS IN EIGHT-YEAR-OLD CHILDREN .....	330
<b>KINESIOLOGICAL RECREATION</b>	
<b>Sanja Čurković, Mirna Andrijašević, Romana Caput-Jogunica and Nenad Zvonarek</b> CHARACTERISTICS AND LEVELS OF PHYSICAL ACTIVITY AMONG UNIVERSITY STUDENTS .....	334
<b>Alena Cepková</b> ASSESS THE STATE OF POSTURE, PHYSICAL FITNESS AND MENTAL HEALTH OF STUDENT OF THE UNIVERSITY .....	338
<b>Lucija Mudronja, Tin Petračić and Željko Pedišić</b> PHYSICAL ACTIVITY AND BARRIERS TO EXERCISE AMONG STUDENTS FROM THE FACULTY OF PHILOSOPHY IN ZAGREB .....	343
<b>Jaromír Šimonek</b> LEVEL OF PHYSICAL ACTIVITY AND INACTIVITY OF SLOVAK ADOLESCENTS .....	347

<b>Vilko Petrić, Dario Novak and Boris Neljak</b> SPORTING ACTIVITY PREFERENCES OF PEOPLE OF DIFFERENT AGE AND GENDER IN RURAL AREAS .....	353
<b>Sorina Cernaianu and Claude Sobry</b> ASPECTS OF SPORTS TOURISM FOR PEOPLE WITH DISABILITIES: THE CASE OF FRANCE AND ROMANIA .....	358
<b>Samo Rauter and Mojca Doupona Topič</b> MASS SPORTS EVENTS AS A LIFESTYLE: AN EXAMPLE OF CYCLING MARATHON FRANJA 2011 .....	362
<b>Donald N. Roberson Jr. and Michal Kudlacek</b> GARDENING: NATURAL PANACEA FOR LIFE .....	363
<b>Danijel Jurakić, Željko Pedišić and Zrinka Greblo</b> RELATIONS BETWEEN PHYSICAL ACTIVITY AND ANXIETY SYMPTOMS .....	364
<b>Roman M. Kalina</b> “COMBAT SPORTS PROPEDEUTICS – BASICS OF JUDO” AS EMPIRICALLY VERIFIED PROPOSITION FOR ALL TYPES OF SCHOOLS AND AS MODERN HEALTH-RELATING TRAINING .....	365
<b>KINESIOLOGY AND SOCIAL SCIENCES (SOCIOLOGY, PSYCHOLOGY, HISTORY, PHILOSOPHY)</b>	
<b>Juri L. Hanin</b> EMOTION-CENTERED AND ACTION-CENTERED PROFILING IN SPORT: INCORPORATING THE CONCEPT OF INDIVIDUAL DIFFERENCES .....	368
<b>Renata Barić and Igor Čerenšek</b> COMPETITIVE ANXIETY AND GOAL ORIENTATION IN CROATIAN ATHLETES .....	375
<b>Sunčica Bartoluci and Diana Tomić</b> PROUD TO BE A CROAT – NATIONAL IDENTITY AND SPORTS IN THE ADVERTISING WORLD .....	379
<b>Zrinko Čustonja and Dario Škegro</b> ATTEMPTS TO ORGANISE AND ADVANCE EDUCATION IN CROATIA IN 1861 AND 1865 AND POSITION OF PHYSICAL EDUCATION .....	383
<b>Zoran Grgantov, Jelena Matešić and Mia Perić</b> ACHIEVEMENT GOAL ORIENTATION IN UNIVERSAL SPORTS SCHOOL PARTICIPANTS .....	386
<b>Zrinko Grgić and Zrinko Čustonja</b> NEW LAW AND REORGANISATION OF ELEMENTARY SCHOOLS IN THE CIVIL CROATIA IN 1874 – INTRODUCTION OF COMPULSORY PHYSICAL EDUCATION .....	389
<b>Črtomir Matejek and Jurij Planinšec</b> THE INFLUENCE OF PHYSICAL FITNESS ON PHYSICAL SELF-CONCEPT IN TEN-YEARS-OLD SLOVENIAN BOYS .....	392
<b>Jelena Matešić, Zoran Grgantov and Dražen Čular</b> COMPETITIVE STATE ANXIETY IN FEMALE VOLLEYBALL PLAYERS .....	396
<b>Ivana Musa and Đurđica Miletić</b> INTRINSIC AND EXTRINSIC ORIENTATION IN FOLK DANCES .....	399
<b>Benjamin Perasović, Marko Mustapić and Sunčica Bartoluci</b> SPORT AND KINESIOLOGICAL ACTIVITIES IN LEISURE TIME STRUCTURE OF ZAGREB STUDENTS .....	403
<b>Ersin Eskiler, İhsan Sarı and Fikret Soyer</b> THE EFFECT OF THE BASIC PSYCHOLOGICAL NEEDS ON SELF-CONFIDENCE OF UNIVERSITY STUDENTS .....	407



<b>Franja Fratrić, Snežana Vujanović, Dragana Golik-Perić, Vojin Jovančević, Nenad Sudarov, Damjan Jakšić and Branko Đukić</b>	
THE RELATIONSHIP BETWEEN MOTOR VARIABLES ASSESSING EXCITATION, TONUS AND SYNERGISTIC REGULATORY MECHANISMS AND THOSE ASSESSING MENTAL POTENTIAL OF HANDBALL, VOLLEYBALL AND BASKETBALL PLAYERS .....	408
<b>Felix Lebed</b>	
GAME PLAYING AS A “CHALLENGE”: FROM PHILOSOPHICAL DILEMMAS TO PEDAGOGICAL IDEAS .....	409
<b>İhsan Sarı, Fikret Soyer and Ersin Eskiler</b>	
THE RELATIONSHIP BETWEEN LIFE SATISFACTION, SELF-ESTEEM AND GENERAL SELF-EFFICACY OF UNIVERSITY STUDENTS .....	410
<b>KINESIOLOGY IN PHYSICAL CONDITIONING</b>	
<b>Erika Zemková and Dušan Hamar</b>	
POWER PRODUCTION DURING SETS OF RESISTANCE EXERCISES ON STABLE AND UNSTABLE SURFACE .....	412
<b>Tomáš Michalík and Marián Vanderka</b>	
ADAPTATION EFFECTS OF THE EXPLOSIVE WEIGHT TRAINING WITH VS. WITHOUT COUNTERMOVEMENT .....	416
<b>Igor Jukić, Daniel Bok, Luka Milanović and Tamara Despot</b>	
EFFECTS OF FATIGUE ON COORDINATION AND SKILL-RELATED PERFORMANCE IN TEAM SPORTS .....	419
<b>Martin Zvonar, Josef Maleček, Igor Duvač, Vladimír Psalman and Martin Sebera</b>	
HEART RATE MONITORING DURING TESTING OF ENDURANCE ABILITIES IN FOOTBALL .....	422
<b>Ivan Belčić, Alen Marošević and Saša Rodić</b>	
EFFECTS OF UNILATERAL HANDBALL TRAINING IN COMPARISON WITH EFFECTS IN SPORTS WITH DOMINANT BILATERAL LOADS IN TRAINING - DIFFERENCES IN MOTOR PERFORMANCE OF DOMINANT AND NONDOMINANT SIDE OF THE BODY .....	427
<b>Saša Vuk and Neven Čorak</b>	
TRENDS OF MORPHOLOGICAL CHARACTERISTICS OF A TOP-LEVEL BODYBUILDER: A CASE STUDY .....	430
<b>Sanja Šalaj, Cvita Gregov and Leonard Sovina</b>	
EFFECTS OF CONCENTRIC TRAINING ON POWER AND CHANGE-OF-DIRECTION SPEED .....	435
<b>Cvita Gregov, Sanja Šalaj and Dragan Milanović</b>	
CHANGES IN POWER MEASUREMENTS INFLUENCED BY A MEDICINE BALL BALLISTIC TRAINING PROGRAM .....	439
<b>Igor Jelaska, Marko Erceg and Boris Maleš</b>	
DISCRIMINATION OF FUNCTIONAL CHARACTERISTICS BY USING THREE DIFFERENT DEVICES WITH TRAINING LOAD SETUP .....	446
<b>Vlatko Vučetić and Tomislav Dokman</b>	
HEART RATE RECOVERY AFTER A GRADED EXERCISE TEST IN SPRINTERS, MIDDLE DISTANCE, LONG DISTANCE AND 400 METER RUNNERS .....	451
<b>Dušan Gutović, Nenad Sudarov, Franja Fratrić and Dragana Golik Perić</b>	
MAXIMUM AND RELATIVE ISOMETRIC MUSCLE FORCE IN JUNIOR AND CADET FOOTBALL, BASKETBALL AND VOLLEYBALL PLAYERS .....	457
<b>Ekrem Čolakhodžić, Almir Popo, Almir Pokvić, Admir Poturović and Meris Husanović</b>	
TRANSFORMATIONAL PROCESSES OF MOTOR ABILITIES OF YOUNG SOCCER PLAYERS UNDER THE INFLUENCE OF A SITUATIONAL MODEL OF TRAINING .....	461

<b>Lejla Šebić, Dženan Baždarević and Gordana Furjan-Mandić</b> THE EFFECTS OF A PILATES TRAINING PROGRAM ON DYNAMIC STRENGTH IN FEMALE SOCCER PLAYERS .....	465
<b>Amel Mekić, Husnija Kajmović, Adis Kapur and Nađa Katica</b> INFLUENCE OF MORPHOLOGICAL CHARACTERISTICS AND MOTOR ABILITIES ON THE PERFORMANCE OF SOME HAND JUDO TECHNIQUES OF BOSNIA AND HERZEGOVINA'S JUDOKAS .....	470
<b>KINESIOLOGY OF PHYSICALLY DEMANDING JOBS</b>	
<b>Daniel Bok, Dražan Dizdar and Tamara Despot</b> EFFECTS OF A 6-MONTH DEPLOYMENT TO AFGHANISTAN ON PHYSICAL FITNESS .....	472
<b>Dražen Harasin and Josip Šopar</b> EFFECTS OF TWO DIFFERENT 5-WEEK TRAINING PROGRAMS ON PHYSICAL FITNESS OF MILITARY RECRUITS .....	475
<b>Vladimir Manojlović, Mario Jovanović and Dražen Harasin</b> DIFFERENCES IN MOTOR STATUS OF ACTIVE AND SEDENTARY SOLDIERS .....	480
<b>Tomislav Pisačić and Vedran Naglić</b> DAILY LOAD OF CROATIAN SOLDIERS DURING THE PEACEKEEPING MISSION IN AFGHANISTAN .....	483
<b>Josip Šopar</b> WORKLOAD PARAMETERS OF SOME ACTIVITIES DURING SPECIAL FORCES TRAINING .....	484
<b>Vedran Naglić and Tomislav Pisačić</b> THE RELATIONS OF MORPHOLOGICAL DIMENSIONS AND PHYSICAL FITNESS AMONG CROATIAN ARMED FORCES MEMBERS .....	485
<b>KINESIOLOGY OF TOP-LEVEL SPORT</b>	
<b>Saša Cecić Erpič</b> SPORTS CAREER TERMINATION AND ADAPTATION TO POST-SPORTS LIFE: A REVIEW OF DEVELOPMENTAL-SPORT PSYCHOLOGICAL PERSPECTIVES .....	488
<b>Sigmund Loland</b> JUSTIFYING ANTIDOPING: FAIR OPPORTUNITY AND THE BIOLOGY OF PERFORMANCE ENHANCEMENT .....	494
<b>Nic James, Gethin Rees, Joe Taylor, Ian Grant and Phil Barter</b> FORMATION MAPS OF 5 MINUTES BEFORE AND AFTER SCORING IN SOCCER .....	495
<b>Mario Baić and Włodzimierz Starosta</b> PHYSICAL FITNESS LEVEL IN FREE STYLE JUNIOR WRESTLERS OF THREE DIFFERENT WEIGHT CATEGORIES .....	496
<b>Tomislav Đurković, Nenad Marelić and Tomica Rešetar</b> LATENT STRUCTURE OF ANTHROPOMETRIC DIMENSIONS IN ELITE CROATIAN VOLLEYBALL PLAYERS .....	500
<b>Marko Erceg, Igor Jelaska and Boris Maleš</b> DEVELOPMENT ANALYSIS OF SOCCER PLAYERS' FUNCTIONAL CHARACTERISTICS .....	505
<b>Borut Fonda, Andrej Panjan and Nejc Šarabon</b> REACTION TIME, RANGE AND VELOCITY OF THE REVERSE HANDPUNCH IN ELITE KARATE ATHLETES .....	510

<b>Gordana Furjan-Mandić, Lejla Šebić and Josipa Radaš</b> CORRELATION BETWEEN EFFICIENCY IN PERFORMING BODY ELEMENTS AND ELEMENTS WITH A ROPE AND RIBBON IN RHYTHMIC GYMNASTICS .....	514
<b>Mitja Geržević</b> COMPARISON OF SELF-PERCEIVED FATIGUE AND CHANGES IN SURFACE EMG PARAMETERS DURING AN ALL-OUT SIX-MINUTE ROWING EXERCISE .....	519
<b>Igor Gruić, Dinko Vuleta, Marina Bazzo and Katarina Ohnjec</b> SITUATIONAL EFFICIENCY OF TEAMS IN FEMALE PART OF TOURNAMENT IN THE WORLD BEACH HANDBALL CHAMPIONSHIP IN CADIZ .....	524
<b>Goran Leko, Klara Šiljeg and Dajana Zoretić</b> FULLY TETHERED SWIMMING VS. SPRINT SWIMMING .....	529
<b>Nuno M. Martins, Hugo M. Sarmiento and José C. Leitão</b> DEFENSIVE PROCESS OF THE WORLD CUP 2006 AND EURO CHAMPIONS 2008: T-PATTERN ANALYSIS .....	533
<b>Durđica Miletić, Sunčica Delaš Kalinski and Ana Božanić</b> HOW DOES THE PERFORMANCE OF ACROBATIC ELEMENTS EFFECT FINAL BEAM RESULTS IN ARTISTIC GYMNASTS .....	537
<b>Saša Rodić, Igor Gruić and Katarina Ohnjec</b> RELATIONS BETWEEN BASIC AND SPECIFIC AGILITY OF YOUNGER HANDBALL PLAYERS .....	541
<b>Hugo M. Sarmiento, Jorge M. Campaniço, Maria T. Anguera and José C. Leitão</b> A COMPARISON OF PLAYING TACTICS IN THE ENGLISH PREMIER LEAGUE, SPANISH LA LIGA AND ITALIAN SERIE A .....	546
<b>Gabriele Semprini and Gianluca Caimmi</b> KITESURFING FREESTYLE PERFORMANCE ANALYSIS .....	551
<b>Hrvoje Šašek, Tamara Glad and Boris Balent</b> EVALUATION OF IMPORTANCE OF DIFFERENT ELEMENTS IN PREPARATION, COMPETITION AND TRANSITION PERIOD AMONG TOP-LEVEL ATHLETES, TOP-LEVEL COACHES AND COACHES FROM AVERAGE POPULATION IN SHOOTING SPORT .....	555
<b>Boštjan Šimunič</b> SKELETAL MUSCLE CONTRACTION TIME IN PROFESSIONAL FOOTBALL PLAYERS .....	560
<b>Dario Škegro, Dražan Dizdar, Dragan Milanović and Asim Bradić</b> EVALUATION OF BASIC TYPES OF OFFENSE IN BASKETBALL ACCORDING TO ITS BEGINNING AND OUTCOME AND THE FINAL OUTCOME OF THE GAME .....	565
<b>Patrik Drid, Nebojša Majstorović, Gustav Bala, Milena Mikalacki and Miodrag Drapšin</b> DIFFERENCES IN COGNITIVE AND CONATIVE FUNCTIONING OF JUDOISTS, SHOOTERS AND VOLLEYBALL PLAYERS .....	570
<b>Jesus Rivilla, Jorge Lorenzo and Javier Sampedro</b> DIFFERENCES IN THE JUMP CAPACITY DEPENDING ON THE DEGREE OF OPPOSITION IN THE HANDBALL JUMP THROW .....	571
<b>Husnija Kajmović, Izet Rađo and Amel Mekić</b> THE EFFECT OF RULE CHANGES IN JUDO ON SITUATIONAL EFFICIENCY IN FEMALE JUDO BOUT .....	572
<b>Safet Kapo, Izet Rađo, Branko Cikatić and Erduan Kafedžić</b> TRENDS IN THE IMPORTANCE OF APPLYING HYPOTHETICAL PERSONALITY DIMENSIONS DURING TOP-LEVEL HEAVYWEIGHT K-1 FIGHTS .....	573
<b>Ifet Mahmutović, Nedžad Osmankač, Tine Sattler and Joško Milenkoski</b> THE EFFECT OF HYPOTHETICAL PREDICTORS ON THE REPRESENTATION OF CHARACTERISTICAL MODALITY SERVICES IN VOLLEYBALL .....	574

<b>Gethin Rees, Joe Taylor, Phil Barter and Ian Grant</b> ZONE 14 AS A STRATEGIC ATTACKING AREA IN CHAMPIONSHIP SOCCER .....	575
<b>Marian Uvaček and Alena Cepková</b> EVALUATION OF GAME PERFORMANCE IN BEACH VOLLEYBALL DEPENDENCY LEVELS ATTACK FROM LEVEL OF QUALITY RECORDINGS .....	576
<b>Petra Zaletel, Goran Vučković, Lygeri Dimitriou, Nic James, Andrej Rebula and Meta Zagorc</b> ANALYSIS OF DANCE POSTURES IN LATIN-AMERICAN DANCES USING ANNOTATION AND SAGIT TRACKING .....	577
<b>Grigory Popov, Eduard Malkhasyan and Vartanush Markaryan</b> MAGNETIC STIMULATION IN THE DEVELOPMENT OF THE FORCE COMPONENT OF MUSCLE CONTRACTILITY .....	578
<b>MANAGEMENT OF SPORT</b>	
<b>Part One: Management of Sport</b>	
<b>Gregor Jurak, Marjeta Kovač, Jakob Bednarik and Edvard Kolar</b> QUO VADIS, SLOVENIAN SPORT? .....	580
<b>Sanela Škorić</b> APPLICATION OF STRATEGIC MANAGEMENT ACTIVITIES IN THE CROATIAN NATIONAL SPORT FEDERATIONS .....	584
<b>Zlatko Hodak and Marina Hodak</b> CHARACTERISTICS OF MANAGERS IN SPORT ORGANISATIONS IN CROATIA .....	588
<b>Ivan Novak</b> INTEGRATIVE MARKETING MANAGEMENT AND ITS POSSIBILITY TO APPLY IN SPORT .....	592
<b>Darija Omrčen and Mato Bartoluci</b> PROMOTION AS A TYPE OF COMMUNICATION IN SPORTS MARKETING .....	597
<b>Hajer Naouali and Abdessatar Ati</b> THE SALARY OF A PROFESSIONAL FOOTBALLER: THE DETERMINING FACTORS .....	601
<b>Alen Jerkunica, Stipe Smoljanović and Denis Kosor</b> THE ROLE OF YOUTH ACADEMY IN CREATING NEW VALUES FOR THE PROFESSIONAL FOOTBALL CLUB .....	605
<b>Teo Bratinčević and Stipe Smoljanović</b> SMALL AND MEDIUM SPORTS ENTERPRISES .....	609
<b>Stevo Popović, Duško Bjelica, Georgi Georgiev and Selcuk Akpınar</b> COMPARISON OF ATTITUDES TOWARD ADVERTISING THROUGH SPORT BETWEEN MONTENEGRIN AND TURKISH STAKEHOLDERS .....	612
<b>Tibor Barna</b> WRESTLING AS A CASUALTY OF OLYMPIC PROFIT AND MEDIA .....	613
<b>Part Two: Sports Tourism</b>	
<b>Zlatko Verunica, Daniela Gračan and Ivana Ivančić</b> SPORT AND TOURISM AS COMPLEMENTARY SOCIOECONOMIC PHENOMENA .....	614
<b>Daniela Gračan, Zrinka Zadel and Andreja Rudančić-Lugarić</b> THE ROLE OF SPORT IN PROMOTION OF CROATIAN TOURISM .....	618
<b>Mato Bartoluci and Sanela Škorić</b> MANAGING WELLNESS DEVELOPMENT IN CROATIAN TOURISM .....	622
<b>Zvezdana Hendija and Snježana Boranić-Živoder</b> MANAGING WELLNESS OFFER BASED ON TOURIST ANALYSIS IN COASTAL CROATIA .....	626

<b>Kristina Bučar and Claude Sobry</b> GOLF TOURISM AND SUSTAINABLE DEVELOPMENT: FRANCE AND CROATIA, TWO EUROPEAN EXAMPLES .....	631
<b>Slobodan Ivanović, Romina Alkier Radnić and Tonći Jerak</b> SIGNIFICANCE OF GOLF FOR REPOSITIONING OF ISTRIA ON THE TOURIST MARKET .....	635
<b>Zdenko Cerović and Sanda Grudić Kvasić</b> SAILBOAT REGATTA MANAGEMENT AS A FACTOR OF THE TOURIST DESTINATION PROMOTION .....	639
<b>Marko Perić</b> PROFILES, SPORT HABITS AND TOURISM MOTIVES OF FITNESS CENTERS' VISITORS .....	644
<b>RESEARCH METHODOLOGY</b>	
<b>Rado Pišot, Peter Kokol and Franjo Prot</b> CONTEMPORARY APPROACH IN MEASURING AND ANALYSING FUNDAMENTAL MOTOR PATTERNS .....	650
<b>Hrvoje Sertić, Tihomir Vidranski and Ivan Segedi</b> EVALUATION OF A METHOD FOR OBJECTIVE ASSESSMENT OF SITUATIONAL EFFECT IN KARATEKAS THROUGH TECHNICAL - TACTICAL INDEKS FOR SITUATIONAL EFFICIENCY .....	651
<b>Nejc Šarabon</b> REPEATABILITY OF ELECTROMYOGRAPHIC PARAMETERS USED IN THE ASSESSMENT OF TRUNK STABILITY FUNCTIONS .....	656
<b>Mario Jovanović</b> RELATIONSHIP BETWEEN ANTHROPOMETRIC DIMENSIONS AND MOTOR ABILITIES IN SOCCER PLAYERS .....	662
<b>Goran Sporiš, Vlatko Vučetić and Davor Šentija</b> COMPARISON OF VENTILATION THRESHOLD AND HEART RATE DEFLECTION POINT IN FAST AND STANDARD TREADMILL TEST PROTOCOL .....	667
<b>Zvonimir Tomac, Željko Hraski and Goran Sporiš</b> THE INFLUENCE OF CHANGE IN KINESIOMETRIC CONDITIONS ON THE RESULTS OF HAND PLATE TAPPING TEST WITH PRESCHOOL CHILDREN .....	672
<b>Pense, M. and Turnagöl, H.</b> EFFECTS OF GLYCEROL-INDUCED HYPERHYDRATION ON TOTAL BODY WATER AND CORE TEMPERATURE IN ENDURANCE ATHLETES DURING THE COURSE OF TREADMILL EXERCISE PERFORMED AT 30° C FOR 90 MIN .....	676
<b>Yaman Lesinger, F., Turnagöl, H., Košar, N. and Pense, M.</b> EFFECTS OF THREE DIFFERENT FLUID HYPERHYDRATION ON CARDIOVASCULAR FUNCTIONS AND ENDURANCE PERFORMANCE IN ATHLETES DURING EXERCISE AT HIGH TEMPERATURES .....	677
<b>Zlatko Šafarić, Zoran Milanović, Nebojša Trajković, Aleksandar Joksimović, Valentin Barišić and Munir Talović</b> EFFECTS OF POWER PERFORMANCE ON KICKING VELOCITY IN YOUNG SOCCER PLAYERS .....	678
<b>Maja Horvatin-Fučkar, Ivana Hečimović and Ozren Radenović</b> DIFFERENCES IN THE EXPLOSIVE JUMPING STRENGTH OF DIFFERENT GENERATIONS OF FEMALE STUDENTS AT THE FACULTY OF KINESIOLOGY .....	682
<b>Boris Metikoš, Siniša Kovač, Marko Milanović and Željko Lukenda</b> STUDENTS' COMPETITION ACHIEVEMENTS ANALYSIS AT THE CITY OF ZAGREB UNIVERSITY SPORTS CHAMPIONSHIPS 2006 – 2010 .....	687

<b>Marko Sukreški, Ivan Krakán and Jozo Tomić</b> DIFFERENCES IN EXPLOSIVE POWER OF FOOTBALL PLAYERS OF DIFFERENT AGE CATEGORIES .....	692
<b>Elvir Kazazović, Mensur Vrcić, Edin Jelešković and Haris Alić</b> EFFECTS OF THE PROGRAMME OF ISOKINETIC EXERCISING ON STRENGTH OF KNEE EXTENSORS .....	695
<b>Boris Balent, Ivan Kepcija and Ksenija Bosnar</b> METRIC PROPERTIES OF DISPOSITIONAL FLOW SCALE-2 ON CROATIAN SAMPLE .....	700
<b>Igor Baran</b> CHANGES IN HEART RATE OF DIVING BEGINNERS: HEART RATE AS A RESPONSE TO THE LOAD PATTERN AND SIZE OF THE HYDROSTATIC PRESSURE .....	701
<b>Donald N. Roberson, Jr.</b> THE BASICS OF QUALITATIVE RESEARCH .....	702
<b>Pavol Horička</b> RELATIONSHIP BETWEEN INTELLIGENCE AND THE LEVEL OF MOTOR LEARNING .....	703
<b>Andrej Panjan</b> EVALUATION OF THE DYNAMIC BALANCE TRACKING TEST .....	708
<b>Valentin Barišić, Nebojša Trajković, Zoran Milanović, Aleksandar Joksimović, Fredí Fiorentini, Zlatko Šafarić and Munir Talović</b> DIFFERENCES IN SAQ PERFORMANCE BETWEEN FUTSAL AND VOLLEYBALL PLAYERS .....	712
<b>Ivan Segedi, Hrvoje Sertić and Tihomir Vidranski</b> SOME SPECIFICITIES DURING CONSTRUCTION AND VALIDATION OF A NEW INSTRUMENT FOR ASSESSMENT OF IMPORTANCE OF TECHNIQUES IN POLYSTRUCTURAL SPORT JUDO .....	716
<b>Muhedin Hodžić, Zrna Agačević and Naid Kadušić</b> STRUCTURAL CHANGES OF TRANSFORMATION OF MORPHOLOGICAL AND MOTOR ABILITIES OF STUDENTS IN ADDITIONAL CLASSES .....	720
<b>Zulfo Aruković, Salko Huskić and Midhat Mekić</b> INFLUENCE OF ANTHROPOLOGICAL FEATURES ON SPECIFIC BASKETBALL TESTS .....	731
<b>Satellite Symposium</b>	
<b>HEALTH ENHANCING PHYSICAL ACTIVITY</b>	
<b>Stjepan Heimer</b> HEPA AND SRM COOPERATION – A WIN-WIN APPROACH .....	734
<b>Ilkka Vuori</b> LIFESTYLE PHYSICAL ACTIVITY AND HEALTH .....	738
<b>Eva Martin-Diener</b> THE NATIONAL HEPA NETWORK IN SWITZERLAND – STEERING COMMITTEE, PLANS AND PROGRAMS, COOPERATION AMONG INSTITUTIONS, BODIES AND PERSONS .....	740
<b>Charlie Foster</b> BASIC HEPA IMPLEMENTATION GUIDELINES .....	741
<b>Zdenek Hamrik, Michal Kalman and Katerina Ivanova</b> DEVELOPMENT OF PHYSICAL ACTIVITY RECOMMENDATIONS FOR HEALTHY CITIES IN THE CZECH REPUBLIC .....	742

## LATE SUBMISSIONS

<b>Željko Kovač</b> RELATION BETWEEN MUSIC AND PHYSICAL TRAINING .....	748
<b>Kenneth Swalgin, Damir Knjaz, Lubor Tomanek and Ola Fosnes</b> A STUDY TO DETERMIN THE STATUS, IMPORTANCE, AND VALUE OF TAKING-A-CHARGE IN BASKETBALL BY COACHES IN THE UNITED STATES AND SELECTED EUROPEAN COUNTRIES .....	753
<b>Tatjana Trivić, Patrik Drid, Radovan Kalanj, Miodrag Drapšin and Milan Stanković</b> EVALUATION AND ANALYSIS OF INJURIES IN KICKBOXING .....	755
<b>Jugoslav Vojinović, Jan Babiak, Branislav Strajnić and Žika Kalentić</b> EXTROVERSION OF YOUNG SWIMMERS AND THEIR SPORT SUCCESS .....	756
<b>INDEX OF AUTHORS</b> .....	760



# Key-note Lectures

**6<sup>th</sup> INTERNATIONAL  
SCIENTIFIC  
CONFERENCE ON  
KINESIOLOGY**

Opening ceremony lectures

Plenary lectures

**“INTEGRATIVE POWER OF  
KINESIOLOGY”**





## **SPORT SCIENCES - CURRENT CHALLENGES AND FUTURE POSSIBILITIES**

**Sigmund Loland**

*Norwegian School of Sport Sciences, Oslo, Norway*

An overview is given of current challenges in the development of sport sciences. Studies of complex phenomena such as intentional human movement necessarily involve several scientific perspectives. An overview of paradigms in sport research is presented. With examples from studies in alpine skiing, particular attention is given to the challenges of disciplinary, multi-disciplinary and cross-disciplinary research. Future possibilities of sport research is discussed.

Particular attention is given to the growing research field of physical activity and public health and its impact on traditional research in the sport area.

## THE FUTURE OF SPORT AND SCIENCE

### David Bishop

*School of Sport and Exercise Science, Victoria University*  
*Institute of sport, Exercise and Active Living, Victoria University*

### Abstract

For sport science to really make a difference requires a radical departure from traditional practice. History is littered with examples of how difficult it is to predict what will make a difference in the future. Nonetheless, it is important because new ideas will not germinate if we focus only on what is deemed relevant at the moment, or on what is known at the present. Part of this presentation will be based on a report by the Commonwealth Scientific and Industrial Research Organisation (CSIRO) in 2010 titled “Our Future World”. Based on an analysis of over 100 trends, CSIRO identified five megatrends that will change the way people live and the technology products they will demand. These megatrends were

- 1) More from less;
- 2) A personal touch;
- 3) Divergent demographics;
- 4) People travelling around the world more often; and
- 5) i World: Everything in the natural world will have a digital counterpart.

This presentation will highlight some of the important implications that these megatrends could have for sport science. For example, simple genetic tests are already being used to identify if you (or your children) are naturally orientated towards sprint/power sports or endurance events, and will soon be used to personalise training. This presentation will also present an argument for more basic research and argue that it is erroneous to equate pure research with useless and applied research with useful.

## SCHOOL PHYSICAL EDUCATION YESTERDAY AND TODAY - COMPARISON OF SOME INDICATORS IN 1990 AND 2010

**Branislav Antala**

*Comenius University, Faculty of Physical Education and Sports, Bratislava, Slovakia*

### Abstract

As in the rest of the Europe, in Slovakia, PE in last two decades has gone through intensive development and many changes. In spite of attempts by PE professionals, PE teachers, pupils and parents still struggle, sometimes more, sometimes less successfully with a range of problems. We would like to present here comparison of choice indicators according to PE in schools during period 1990 – 2010: allocation time for PE in school curriculum, PE content and name of school subject, somatic parameters and motor performance of children and youth, involvement of children and youth in physical activities, school PE and sport facilities and equipment, numbers of pupils in PE hours and some other indicators

**Key words:** *Physical education, curriculum, sport facilities, motor performance*

### Introduction

The domain of school Physical Education (PE) is one of the fields that has received increased attention across the world in recent times from ministerial and other high level governmental officials with responsibility for physical education and sport as well as from international non-governmental organisations.

The last 30 years have seen the publication of a plethora of international Charters (UNESCO *International Charter of Physical Education and Sport*, 1978; *Council of Europe's European Sports Charter*, 1992; and *PANHALON Charter of Children's Sport Laws*, 1995), Declarations (EUPEA's *Declaration of Madrid*, 1991; and UNESCO Conference of Minister's *Declaration of Punta del Este*, 1999), Manifestos (FIEP *World Manifesto of Physical Education*, 2000), Resolutions (European Parliament's *Resolution on the Role of Sport in Education*, 2007) and Policy and Position Statements (European Commission's *White Paper on Sport*, 2008) concerned with school physical education and sport. School PE has also been the main theme of two PE World Summits (Berlin, 1999 and Magglingen, 2005) at which findings of two Worldwide School PE Surveys (Hardman – Marshall, 1999, 2008, Klein – Hardman, 2008).

As in the rest of the Europe, in Slovakia, PE in last two decades has gone through intensive development and many changes. In spite of attempts by PE professionals, PE teachers, pupils and parents still struggle, sometimes more, sometimes less successfully with a range of problems. We would like to present here comparison of choice problems according to physical education in schools during period 1990 – 2010.

### PE allocation time in school curriculum

One of the key factors for increasing the quality of PE and its influence on the pupil is the amount of PE allocation time in compulsory school curriculum. In 1990 by Guideline of Ministry of Education of Slovak Republic was number of lessons for all schools levels and in all grades to three hours of compulsory PE adapted. This positive trend did not exist long, because already in the process of creating new curriculum in 1997 was the amount of lessons adapted only for 2 hours per week at second grade of primary school and 1 - 2 hours per week at special high schools.

This situation remained until the reform of the entire system of education in 2008, when the new Educational Act was admitted. This Act has modernized school curriculum by allocating it to the state educational program, which represent the 70% of compulsory contents of education, and which curriculum is assigned by the state and school education programs, which represents approximately 30% of content and schools can created it completely on their own. Within those 70% of the state guaranteed hours, the number of hours in the majority of school subjects was reduced (except languages, computers), PE including. PE was included to the state education program at all types of school and all grades only in range of 2 hours per week. There is the possibility of an increase in the number of hours through school education programs (table 1).

Table 1. Amounts of compulsory P.E. per week

Schools	1990	1997	2008
Primary schools	3	3	2 + School educ. program
Secondary schools	3	2	2 + School educ. program
High schools	2 - 3	2 - 3	2 + School educ. program

Studies realised at the end of school years of 2008/2009 and 2009/2010 in schools show that there exists possibility to increase number of 2 hours physical and sport education (PSE) through school education programmes, but in practice this possibility is used by school managements only rarely (Antala 2009; Šimonek - Halmová - Kanášová 2009; Wiegnerová - Kršjaková 2009; Šimonek 2010). They prevail languages, informatics, mathematics and some other subjects. During first year of school reform on level ISCED 1 only 27,9% of schools, on level ISCED 2 only 28 % of schools and on level ISCED only 7% of classic grammar schools and 33% of eight year grammar schools implemented among free hours of school educational programme physical and sport education (table 2). Number of these lessons mainly on levels ISCED 1 and 3 had significantly fallen down comparing with the past. The same it was in the second school year, when for example only 16% of school on level ISCED 1 and 2 increased number of lessons from 2 to 3 hours per week.

Table 2. % of high schools with 1, 2 and 3 P.E. lessons in 1st grade in 1995, 2005, 2009

Amount of lessons per week	3 P.E. lessons	2 P.E. lessons	1 P.E. lesson
1995	78 %	22 %	0 %
2005	45 %	46 %	9 %
2009	7 %	89 %	6 %

Totally we can say that in the last 20 years there was a decrease of the number of lessons of compulsory PE for about 25 to 30% noticed, which means decrease at many schools about 1 hour of compulsory PE per week.

## PE content and name of school subject

The curriculum of PE from 1990 is determinate as a content of PE firstly thematic units which were consisted of traditional sports, they has been in this time most popular and used to have background at the club distinction and in the public also. Here belong mainly athletics, sports gymnastics, sport games, downhill skiing, swimming and martial arts. Space for incorporating of other physical activities was extensive primarily in PE extra educational time and school sport. Some advance in the variability of content was presented by curriculum for secondary schools in 1995 and by the curriculum for primary schools in 1997 which defined except listed traditional thematic units, also space for facultative learning, in which could be new sport branch and physical activities integrated by schools. The range of facultative learning was situated between 20 and 40 % of total content of education.

Cardinal change was PE curriculum in 2008 when a new Act of education was in Slovakia accepted. Besides the structural changes in the whole system of education has also brought a new approach to the teaching of PE, creating aims and content selection. In aims there are more significant connection to health care and generate healthy life style – physical and sport education should put together knowledge, habits, attitudes, abilities and skills about movement, sport, health and healthy life style. Those are created through realised forms of teaching a physical and sport education, adapted PE or by form of physical and sport education integration.

The educational content presents wide scale of knowledge and physical and sport activities offered to pupils. The content is divided into the following 4 modules:

- Health and its impairments  
Knowledge and movement content - basic gymnastics, health – related activities, relaxation and breathing gymnastics, posture exercise, technique of basic locomotion, starting positions, bench exercises, dancing steps and skips, specific exercises for different health impairments, stretching, exercises with bar, etc. Physical activities of this module constitute approx. 10 % from total educational content.
- Healthy life style  
Knowledge and movement content - exercises for general development, system of exercises Salutation to sun, massage, total relaxation, jogging, running and walking, seasonal activities, exercises in nature, motor games, didactical games, eye gymnastics, psychomotorics, target shots, hurdlers' tracks, etc. Physical activities of this module constitute approx. 10 % from total educational content.

- Physical fitness and motor performance  
Knowledge and movement content - sport activities mobilizing energetic sources and optimalizing its impact. To use exercises and tools of athletics, skiing, skating, swimming, shooting, minigolf, golf, etc and different physical and sport activities of 'keep-fit' gymnastics (power training in fitness club, power training with own body weight, exercises with tools or on different gymnastic equipment), aerobics, body styling, rope skipping, cycling etc. Physical activities of this module constitute approx. 30 % from total educational content.
- Sport activities of movement regime  
Physical and sport activities of this module constitute approx. 50 % from total educational content. Content is separated in 4 parts: Sport activities where by rules come to clash between individuals ( judo, wrestling, aikido, karate and other martial arts and tennis, table tennis and badminton); Sport activities realised in team, following given rules ( sport games and new movement games); Sport activities typical for creativity development and having skills for moving form on sport gear, with and without equipment, where different esthetical expressions and rhythm perceptions are emphasized (dance, sport gymnastics, modern gymnastics, basic gymnastics, swimming, synchronized swimming, yoga, Pilates, figure skating, trampoline jumping, rope skipping etc.); Outdoors sport activities, which are characteristic by moving in nature, by adapting for changes of this environment (cross-country skiing, alpine skiing, snowboarding, canoeing, orienteering, paddling, swimming, hiking, roller skating, Nordic walking, biathlon, jogging, climbing, camping, cycling, rappel, etc.)

The task of each PE teacher is to come out from main aims with taking account to pupils' competencies development as well as their preconditions, interests and school conditions, PE teacher should create the programs of PE process for different groups of pupils by him or her selves. Commission for physical education authorizes these programs.

The name of teaching subject was corrected from physical education to "Physical and sport education" on the level of ISCED 2 and 3.

In the last 20 years, the curriculum has been opened and content of education consist not only of traditional physical and sport activities, but also of new modern sports and physical activities, for which children and youth show more interest increasingly.

### **Somatic parameters and motor performance of children and youth**

Analysis of Zapletalová (2011), Antala (2010a) of long-term development of somatic parameters showed that in recent years due to various factors (relatively long-term good nutrition, and social and health care) the trend in body height and weight 11 - 15 year old school population, particularly girls, is constant. The relative body height and weight of boys and girls is rather similar to those of 20 years ago. In certain age periods, we find some differences, but they can be attributed to the acceleration of biological maturation. Preadolescent growth spurt in girls and significant deceleration of body height in boys is shifted one year forward than 20 years ago. The trend of stagnation in the final body height and slimming the population has been indicated 10 years ago by Moravec – Kampmiller - Sedláček (1996) and Moravec - Šelingerová (2009). In following 10 year period mainly in girls it was detected also in younger age groups. Contemporary 11 - 15 year old boys are usually higher by only 2 cm as the boys 20 years ago; in girls the differences are even smaller. It is surprising that despite of the changing lifestyle of our school population the average of relative weight (BMI) of our population is norm. 94% of girls and 90% of boys of analyzed contemporary population has a normal weight or they are underweighted, and only 1% of boys and girls are obese. Compared with the data of Cicchely (2010) this number is remarkable low. Eating habits of our children and youth seem to be appropriate, apparently due to meals during the day at school canteens.

The trend of motor performance is not as optimal as the trend of somatic parameters. Stagnation, or slight decrease in motor performance, which were detected in 90-ies (Moravec – Kampmiller - Sedláček, 1996; Zapletalová, 2002) have been intensified, more in boys than girls. Alarming is that with the exception of strength abilities of abdominal and lumbar muscles, the contemporary generation of 11 - 15 year old boys was nearly in all tests worse than their peers 20 years ago. Contemporary 11 - 13 year old boys have nearly the same the situation is slightly more favourable. In strength tests of upper extremities their performance reaches around girls' level of 1987. However, a negative trend of performance development was found in other basic motor capabilities - aerobic endurance, explosive leg strength, running speed and orientation in the space (example is on figure 1, 2) It is difficult to explain some differences between boys and girls. However, it seems that boys are probably due to their higher interest in information technologies a higher risk group regarding the sedentary behaviour than girls. This recorded also Atkin et al. (2008) in the British population. Generally, it must be concluded that the changed social conditions and the related changes of lifestyle of our children and youth strongly influenced their motor performance. This was caused also by gradual elimination of third lesson of PE at schools and reducing the quality of the PE lessons as a result of discouraging of teachers and poor material conditions.

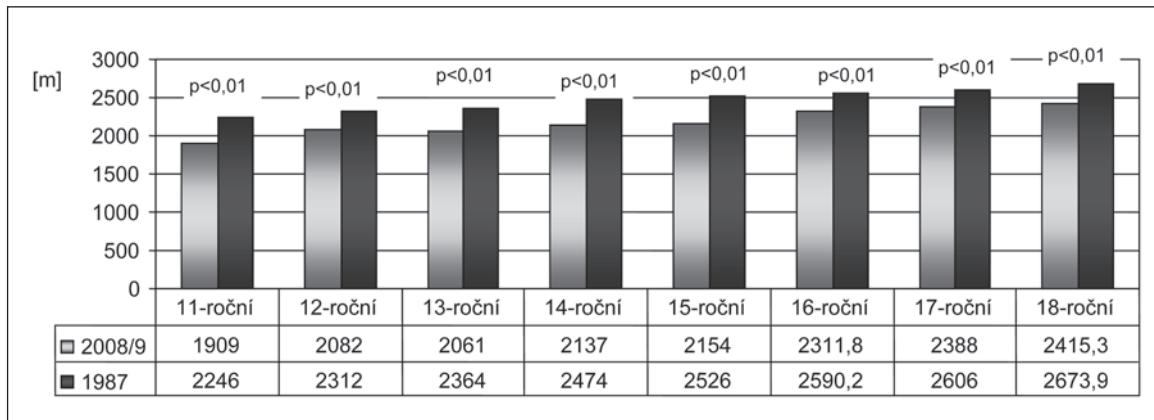

Figure 1. Secular trend in 12-minute running - boys (Zapletalová, 2011)

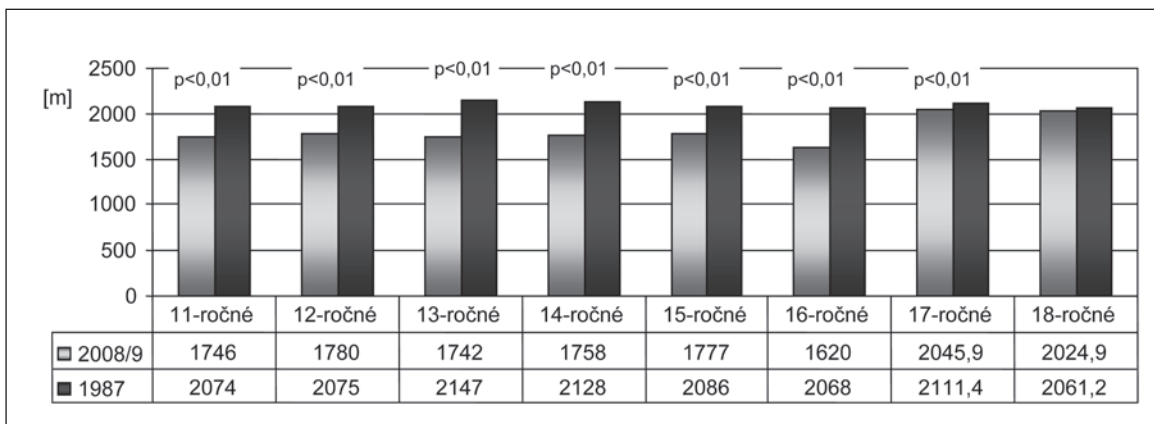
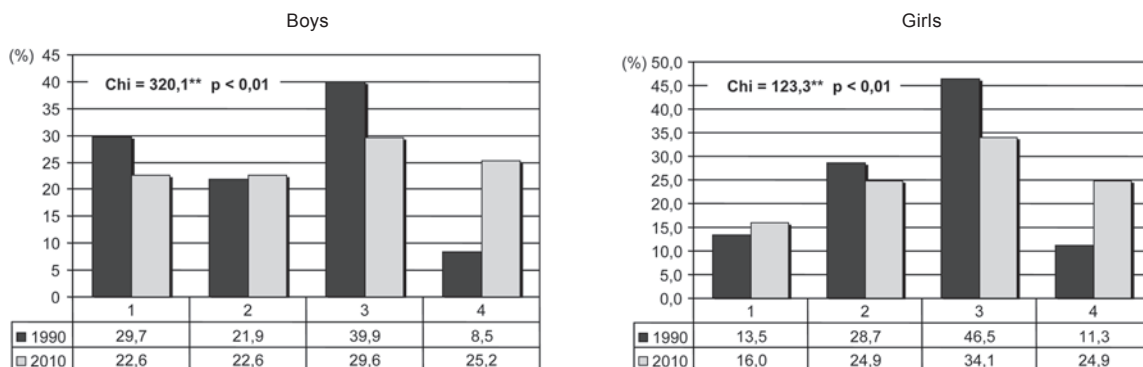

Figure 2. Secular trend in 12-minute running - girls (Zapletalová, 2011)

### Involvement of children and youth in physical activities

Results of recent studies (Antala, 2010; Zapletalová, 2011; Šimonek, 2010) show that in organized forms of physical activities is currently involved in approximately 70% of boys and 66% girls. Compared with the past we can talk about the increase of involving children and youth in non-organized physical activities and a slight increase in the involvement of children and youth in organized activities, slightly more for girls. For boys the increase represents approximately 10% and for girls something about 12%. This positive result must be viewed very carefully, because the structure of the involvement of children and youth in organized forms has been cardinally changed. In figures 3 we bring a comparing of average percentage representation of examined areas in different categories - boys for all age group 11 to 18 and girls for the category 11 to 15 year olds. Differences between 1990 and 2010 are significant at the 0.01 statistical significance level in boys category and girls category as well.



1 – Sport-performance activities; 2 – Recreational activities; 3 – Non-organized PE and sports activities; 4 – Physical activities only during the hours of compulsory PE

Figure 3. Involvement in physical activities in 1990 and 2010 - boys (11-18 years) and girls (11-15years) (Antala, 2010a)

In boys category we have seen in most age groups approximately equal representation of each examined types of organized physical and sport activity, in girls category is significantly lower representation in their involvement in the sport-performance activities. In the past girls less inclined to performance activities also, but while the interest of girls in such activities has note a slight increase (+2.5%), for boys we have seen lower engagement to this kind of physical and sport activities at average of 7%. By contrast, a significant change occurred in the group of children and youth, for which the compulsory school PE is the only performed physical activity.

The number of children for those is PE hours the only opportunity for movement was grown. Today it is approximately 25% of boys and girls. In the past it was only 8.5% of boys and 11.3% of girls. Compared with past – it is increasing three times in boys and more than two times in girls. Nowadays, in 11-15 aged children category we observe also a trend that with increasing age is increasing of the number of girls and boys for whom is the school PE the only physical activity. In the past it was mainly for boys contrary.

### School PE and sport facilities and equipment

Material and spatial conditions are an important prerequisite for effective educational process. On example of secondary schools in Bratislava we show how were these indicators changed in the last 20 years. In table 3 there are mentioned all the facilities, conversion to weights in the both years and percentage decrease or increase for compared years. The most significant decrease occurred for sport games facilities and athletics. The number of volleyball fields decreased for 53, 5% and the number of athletic complexes decreased for more than 17%. The number of gymnasiums decreased for 10% over 21 year's period. The most significant increase occurred in renting of the facilities of other schools or organizations for improving the physical education process. Nowadays schools rent a 120% more facilities compared to year 1990 (mainly swimming pools and gymnasiums). Significant increase (37, 5%) occurred in the number of handball fields. Number of football and basketball fields increased for 10%.

Table 3. Comparison of school PE and sport facilities (Rozboril – Antala, 2010)

Spatial provision	Sum in 1990	Sum in 2010	Per school 1990	Per school 2010	Index 2010/1990	Increase/decrease
<b>Number of schools</b>	<b>11</b>	<b>20</b>				
Gymnasium	17	28	1,5	1,4	90,6	-9,4
Room adjusted for physical education and sports	8	17	0,7	0,9	116,9	16,9
Swimming pool	1	1	0,1	0,1	55,0	-45,0
Athletic complex	6	9	0,5	0,5	82,5	-17,5
Football field	4	8	0,4	0,4	110,0	10,0
Basketball field	7	14	0,6	0,7	110,0	10,0
Volleyball field	13	11	1,2	0,6	46,5	-53,5
Handball field	2	5	0,2	0,3	137,5	37,5
General-purpose rooms	4	14	0,4	0,7	192,5	92,5
Rented space	3	12	0,3	0,6	220,0	120,0

When comparing the past and present equipment and apparatus provision, the most significant changes occurred in athletics facilities. Just one out of 20 schools has suitable spiked running shoes (in 1990 it were 6 out of 11 schools), which means 91% decrease. There was also decrease in the number and quality of starting blocks (-29%), in high jump kits (-63, 3%) and landing areas (-86, 3%), etc. In artistic gymnastics there was a decrease in the number of carpet foam floor rolls (-63%), mats (-23%), trampolines (-50%), as well as horizontal bars, beams, parallel bars. On the other hand there was almost 200% increase of barbells, dumbbells, skipping ropes and fitness equipments.

In general we can say that there was slight decrease in the number of gymnasiums, athletic complexes and more significant decrease of volleyball fields. On the other hand there was an increase of the number of handball fields, basketball fields, and general-purpose rooms. There were no significant changes in the overall number of physical education and sports facilities, however their structure changed.

### Numbers of pupils in PE hours

Inseparable part of PE is students. Optimal number of students in the PE classroom enables effective management of PE process. High number of students in the class causes problems mainly in class organization and in ensuring safety of the pupils.

Numbers of pupils in schools in Slovakia are varied depending on the demographic indicators. While in the 70 and early 80 the last century demographic curve was culminated and about 110 000 children per year were born in Slovakia, and in some years till 120 000 children per year, the number of newborn babies dropped down at the beginning of a new millennium about half - to 55 000 children per year and on this level it is staying up to present. This is the reason for reducing the number of schools and adjusting the number of pupils in classes and adjusting the numbers of PE groups and pupils in them also.

On the example of secondary schools in Bratislava we can show again how was those indicators changed in last 20 years. In 1990 the average number of students was 582, in 2010 it was 576, which can be considered as an approximately the same situation (table 4). There was more significant change in the average number of student per class. In 1990 the average number was 34, 5 students per class and in 2010 it were 27 students per class, which is 22% decrease. There was a change in the average number of students per PE group - in 1990 the average was 17, 7 students per group and in 2010 it was 15, 2 students per group, which is 14, 1% decrease. The number of groups of physical education increased for 9, 1%.

Table 4. Comparison of the number of students (Rozboril – Antala, 2010)

Students/Year	1990	2010		%
Average number of students	581,70	575,90	99,00	-1,00
Av. numb. of students/class	34,70	27,00	77,81	-22,19
Number of P.E. group	32,90	35,90	109,12	9,12
Ave. numb. of students/group	17,70	15,20	85,88	-14,12

Globally we can say that a lower number of pupils in groups and higher number of groups in PE at schools can be considered as a positive trend in terms of quality of PE. This trend is today influenced by economic and organizational possibilities of schools which lead to assembling the groups, resp. to the introduction of coeducation also.

### Some other indicators

Problems of PE education was in many studies analyzed from the perspective views of different groups, which are to education directly or indirectly involved, as a PE teachers, pupils, parents, school managers etc. One of the most discussed questions was for example the evaluation and grading of pupils in PE. In comparison opinions in 1990 and 2010 in this area it is obvious that the most similar are the opinions of PE teachers. Their opinions are the most decided at the same time. The greatest change we found out is in opinions of the parents, where there was a change in all of asked questions. The student's opinions were also quite similar, only in some questions were their opinions changed. For example in question about form of evaluation (grading or not in PE) the pupils are not united in their opinions and are divided into halves (figure 5) or in question about number of grading scales in past times the tendency was to have fewer grades, whereas today (for ex. PE teachers) they prefer more grades respectively on a wider scale of grades (figure 4).

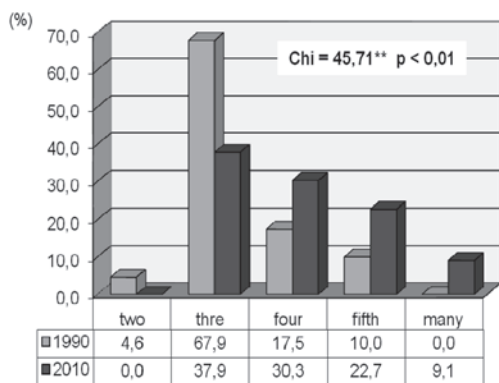

Figure 4. Number of grades in PE grading scale – PE teachers

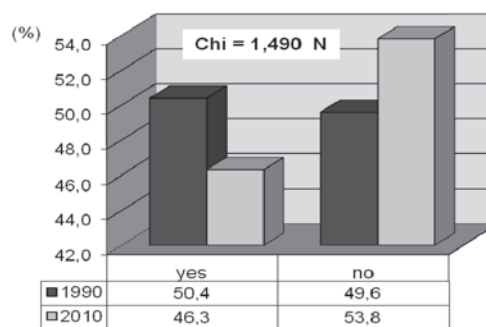

Figure 5. Grading in PE yes or no - students

Increasing of PE teachers' average age and low interest of young graduates to work in the field of PE - teachers are getting older and older and, therefore, the average age of PE teachers is increasing – from 37,2 in 1987 to 43.1 year old in 2006. After graduation, only 37.3 % work in the profession of PE teacher. Others work in sport clubs, sport organisations or in the private sector, and 36.4 % work out of school and sport sector.



Inadequate social and financial reward of PE teachers – Slovak teachers' salaries are today the lowest in the EU; the amount of dissatisfied PE teachers continues to increase; they are unhappy with their financial and social assessment – the percentage of dissatisfied teachers has increased from 75% in 1992 to 94.1% in 2006.

## Conclusion

The results show a stable or increasing importance of school PE, which is nowadays at the time of a sedentary lifestyle, increased inactivity and decreasing motor performance and physical fitness of children and youth, unfortunately, becoming the only physical activity for growing number of boys and girls. On the other hand it is also necessary to show on still underestimated importance of this school subject in the school curriculum, especially from the side of state school authorities. It is demonstrated by decreasing of the number of compulsory PE hours and stagnant resp. inadequate spatial and material conditions of schools. PE teaching staff is getting older and older, young people have not big interest to work in this profession. In the last 20 years the PE curriculum has been changed, the aims and content of PE have been changed also. Nowadays, they are more adapted to children's interests and conditions of schools which could have a positive influence on creation of the student's interest for PE and physical activities at all. Also, the numbers of pupils in PE groups can be considered as suitable.

The causes of the current problems should be seen not only in changed structure of interests of children and youth but also in terms which society creates for physical activity outside school. Little or almost no support from the state leads to the clubs and other organizations have no interest for working with children and youth. If they are working with them the funding must be involved by parents. In many sports it is a barrier for children's participation. The specific roles in creating of conditions for non-organized physical activities are not provide by towns, villages or schools properly because of absence finances.

At the global and national levels many programs (School Supporting health, Slovak children and Youth Olympic festivals, National Health Promotion Programme, Health in schools and etc.) were established to lead the children and youth to physical activity and healthy lifestyle. But their effect is not adequate.

## References

1. Antala, B.: Healthy life style as a part of PE school curriculum. Book of abstract. 5<sup>th</sup> FIEP European congress. Niš: University of Nis, 2009, s. 46.
2. Antala, B.: Pohybová výkonnosť detí a mládeže z hľadiska zapájania sa do telovýchovnej a športovej činnosti. In : Kol. Závěrečná správa výskumnej úlohy VEGA 1/0048/08 *Sekulárny trend v ukazovateľoch telesného rozvoja a pohybovej výkonnosti u 7- až 18-ročnej školskej populácie na Slovensku*. [On line]. www.minedu.sk. 2010a
3. Antala, B.: Zahraničné skúsenosti a názory na hodnotiacu činnosť v telesnej a športovej výchove na stredných školách. In: Antala, B. – Labudová, J. – Górný, M.: *Hodnotiaci činnosť v telesnej a športovej výchove*. Bratislava, END, 2010b, s. 6 - 71
4. Antala, A.J. - Gorely, T. - Biddle, J.H. - Marshal, S.J., - Cameron, N.: Critical Hours: Physical Activity and Sedentary Behaviour of Adolescent after School. In *Paediatric Exercise Science*, 2008, 20, pp. 446-456.
5. Cicchela, A.: Obesity Diffusion among Children and Adolescents: Trends, Methodical Problems and Countermeasures at European Level. In *European Journal of Physical Activity & Health Education*, 2010, Vol. 4 (2), pp. 97-102.
6. Hardman, K. - Marshall, J.: *Word - wide Survey of the State a Status of School Physical Education*, University of Manchester, 1999.
7. Hardman, K. - Marshall, J.: *Update on the State a Status of Physical Education World - Wide*, Magglingen, 2008
8. Klein, G. – Hardman, K.: *Physical Education and Sport Education in European Union*. Editions Revue EPS, Paris, 2008, 453 p.
9. Kršjaková, S.: Nové kurikulum telesnej výchovy v primárnom stupni vzdelávania. *Telesná výchova a šport*, 2008, č.2, s. 2 – 4.
10. Moravec, R. - Sedláček, J. - Kampmiller, T. a kol.: EUROFIT. *Telesný rozvoj a pohybová výkonnosť školskej populácie na Slovensku*. Bratislava: SVSTVŠ, 1996. 180 s. ISBN 80-967487-1-8.
11. Moravec, R. - Šelingerová, M.: Sekulárne zmeny v telesnom rozvoji a motorickej výkonnosti u 7- až 18-ročnej slovenskej populácie. In *Výsledky somatických a antropomotorických výskumných meraní v oblasti mládežníckeho športu*. Bratislava: ICM Agency, 2009., s. 48-57. ISBN 978-80-89257-17-1.
12. Šimonek, J.: Materiálno-technické a personálne zabezpečenie vyučovania telesnej a športovej výchovy na slovenských základných školách. *Telesná výchova a šport*, 2010, č.4., s. 21-27
13. Šimonek, J. – Halmová, N. - Kanášová, J.: The impact of the new Act the curricula in physical and sport education in Slovak schools. Book of abstract. 5<sup>th</sup> FIEP European congress. Niš: Univeristy of Nis, 2009, s. 96.
14. Rozboril, P. – Antala, B.: Telovýchovné a športové zariadenia na bratislavských gymnáziách. *Telesná výchova a šport*, 2010, č.4, s. 24 - 27
15. Weignerová, A. - Kršjaková, S.: Aplikácia modelu kurikula vzdelávacej oblasti Zdravie a pohyb v školských vzdelávacích programoch na Slovensku. In.: Najvarová, V. – Sebestová, S.: *Kurikulum a výuka v promenách školy*. Brno: PdF MU, 2009, s. 67-76
16. Zapletalová, L.: *Ontogenéza motorickej výkonnosti 7 – 18-ročných chlapcov a dievčat Slovenskej republiky*. Bratislava: SVSTVŠ, 2002. 93 s. ISBN 80-89075-17-7.
17. Zapletalová, L.: Changes in somatic parameters and motor performance of children and youth of Slovakia across the period of last 20 years. In: Labudová, J. – Antala, B. at al: *Healthy active life style and PE*, 2011, manuscript.

## FINDINGS FROM THE RESEARCH STUDIES ON SPORTS RECREATIONAL ACTIVITIES OF SLOVENIAN PEOPLE

Herman Berčič and Boris Sila

*University of Ljubljana, Faculty of sport Ljubljana, Slovenia*

### Abstract

The present article reveals the results and findings of long-term research work in the field of sports recreation in Slovenia as well as findings from the last – 17th study within the framework of longitudinal research project »Sports recreational activities of Slovenian people«. Data were collected through studying Slovenian public opinion (SJM); interviews were carried out by the Centre for research of public opinion and mass communication at the Faculty for social sciences, University of Ljubljana. Data for the last study in 2008 were collected in the same way. Findings indicate that the number of Slovenian people, who are sportingly active on a regular basis, is gradually increasing; furthermore, individual types and forms of sports recreational participation of both genders in Slovenia were shown. Likewise, the last study revealed a correlation between certain socio-demographic characteristics of interviewed subjects and their sports recreational participation. Their activity decreased with age. Higher level of education still resulted in more frequent of activity; on the other hand, the differences between genders were no longer statistically significant. The most popular sports activities continue to be walking, swimming and cycling.

**Key words:** *sports activity, Slovenian people, types and forms of participation, socio-demographic characteristics*

### Introduction

Long-term research work has been carried out at the Faculty of sport and at the Faculty for social sciences, University of Ljubljana, since 1974. Studies have provided basis for identification of the status and trends in the area of sports recreational activity in Slovenia. In the last 35 years, the results of studies revealed sports habits of Slovenian people, inclusion of sport in a lifestyle of people and indirectly also the attitude towards recreational sport in general throughout the individual developmental periods. Previous 17 studies have examined and classified forms of participation in sports activity as organised, non-organised or competitive. Similarly, the types of sports activity according to their frequency were categorized as regular, occasional or inactive. Each snapshot of longitudinal study also analysed the correlation between the stated activities and some selected socio-demographic characteristics, such as gender, age, level of education, job position, area of residence and others. Authors of the present study have participated as joint authors in some of the previous studies (Petrović et al, 2001; Berčič, 2002; Berčič, Sila, 2007), whereas in the last one they examined the results and findings of researchers (Sila, Doupona Topič, Pori, 2010). The article presents some of the more important findings from the last study.

The topic, examined by the experts and researchers in the field of sports recreation in Slovenia, derive from aspiration to use each of the studies as a tool for verifying status and trends throughout the individual developmental periods. It is interesting to scrutinize the extent of gender influence on sports recreational participation in Slovenia; it is also fascinating to notice how the age is affected by participation. Long-term research has gradually revealed increase of proportion of women in sports recreational activity. Consequently, the level of life quality of female population has increased in certain developmental periods, thus allowing women to strengthen their position in a society. The latter also depended on education, professional career, economic independence and the autonomy of women in the decision-making process regarding their way of living. In addition, age as one of selected socio-demographic characteristics has significantly distinguished young and old population throughout the individual developmental periods. In spite of this, the age threshold for sports recreational participation has been gradually increasing in the last observed period (Doupona Topič, Sila, 2007). Namely, ever more old people include sports recreational practice into their lifestyle. Previous studies have also shown positive correlation between the level of education and sports recreational participation. Higher level of education has always resulted in higher frequency of participation in chosen sports recreational activities. Individual studies have also included certain other variables of social status and demographic characteristics (profession, (un)employment, amount of salary, size of the residential town). Particularly interesting issue posed the frequency of participation, where three categories were formed – “regular, occasional and zero participation”. In addition to evaluation of development of sports recreation among the Slovenian population, systematic examining and monitoring of selected variables also allowed the assessment of the degree and quality of attitude towards this important human activity. Researchers were always interested in a matter of organised, non-organised and competitive sports recreational participation. The sporting profession has in the past decades claimed that organised and professionally led sports recreational participation is more useful and

more compliant with health demands in comparison with non-organised activity. Similarly, the matter of selection and popularity of individual sports discipline was in the centre of discussion, the findings of studies from individual periods revealing no significant differences for many years. The most popular were always aerobic activities, such as walking, swimming and cycling. Similar findings were shown when analysing the correlation of stated variables with selected socio-demographic characteristics of interviewed subjects.

## Methods

All the previous researches have been carried out on a representative sample of adult Slovenian population, age 18 and more, including both male and female subjects with different level of education and from different residential areas and regions across Slovenia. With Slovenia joining the EU, its research projects (Eurobarometer, EUROSTAT) allowed the researchers in more recent studies to move the age limit of interviewed subjects down to 15 years. Data were collected with the help of selected interviewers from the Faculty of social sciences, University of Ljubljana, within the framework of research project "Slovenian public opinion". The interviewing process in the last study included representative sample of 1286 people of both genders, age 15 and more and the data were analysed with suitable statistical-mathematical procedures. The questionnaire for the field of sports activity has been prepared by the experts from the research team at the Faculty of sport in Ljubljana.

## Results and discussion

The main and standard topic, which the interviewed subjects had to answer, was "How often do you participate in sport or sports recreation in your leisure time?" The results of individual studies show gradual increase in the proportion of sportingly active Slovenian population throughout the individual developmental periods. Furthermore, the results also revealed high correlation of sports activity with variables determining the socio-demographic status of interviewed subjects. It has to be particularly emphasised that the answers to this question in the last study (2008) for the first time ever revealed no statistically significant differences between the genders. It is interesting to compare results in the last 12-year period – from 1996 to 2008 (see Charts 1 and 2).

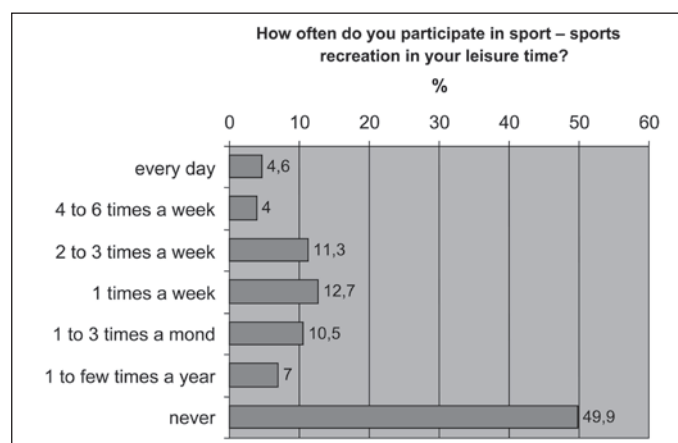

Chart 1. Frequency of sport participation in 1996

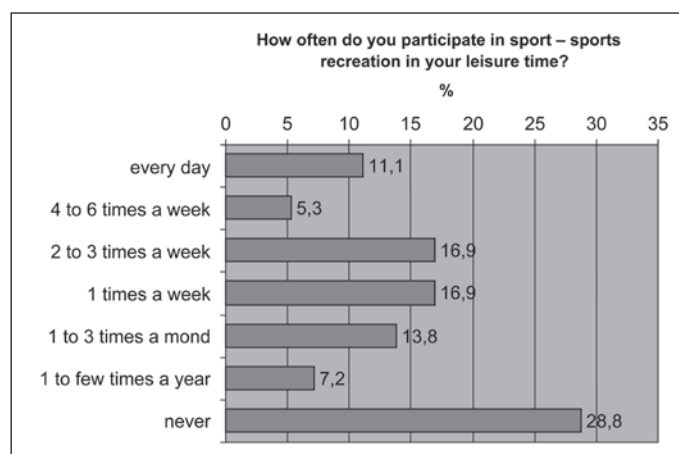

Chart 2. Frequency of sport participation in 2008

The participation of Slovenian population in sport has changed significantly in the observed 12-year period. In almost all the categories, representing at least some sports activity (at least once a month or more often), an increase of percentage values can be noticed. The biggest difference has been revealed in the proportion of sportingly inactive people. In previous years, more than half of population did not practice sport at all (see chart 1), whereas in the last observed period this percentage had significantly decreased, as approximately one third of interviewed subjects described themselves as sportingly inactive.

Similarly to previous studies and in order to provide better differentiation, the 7-point scale of sporting (in)activity was in the last study changed into a three-point scale when correlating sport to individual markings of socio-demographic status (see Table 1). Results in table 1 show that Slovenian population is divided into three similar size groups. Slightly more than a third of people are sportingly inactive, slightly less than a third of people are active occasionally (once a week or less) and a third of Slovenian people participate in sports activity regularly (at least twice a week or more). It can be concluded that at least a third of Slovenian people are aware of the importance of sports recreational activity; moreover, the area of sports recreation provides according to Findak (2009) answers not only to questions about the influence of sports activity on individual dimensions of psychosomatic status of participants, but also about the effects of sport on health in widest sense of the word.

Table 1. Proportion of sportingly active people according to the frequency of participation

Sports activity	%		%
I do not participate in sport, recreation	28.9	inactive	36.1
once or a few times a year	7.2		
1 to 3 times per month	13.8	occasionally	30.7
once a week	16.9		
2 – 3 times per week	16.9	regularly	33.2
4 – 6 times per week	5.3		
every day	11.1		

Table 2. Comparison of the proportion of sportingly active population from 1973 until 2008

	1973	1996	2001	2006	2008
Inactive	57.8	56.5	53.0	40.6	36.1
Occasionally	30.7	22.7	22.6	31.4	30.7
Regularly	11.5	20.8	24.4	28.0	33.2

The above shown data indicate that among the Slovenian population there has been a constant change in the opinion about sports recreation being a part of system values and consequently in decisions to actively participate in one or more sports recreational activities. Therefore, it can be justifiably assumed that increasingly more people will move from the category of occasionally sportingly active population into a category of regularly active people; similarly, sportingly inactive people will move into a category of occasionally or even regularly active people. This will contribute towards the enrichment of leisure time and the life quality of the entire population.

As previously stated, individual studies have always examined the correlation of selected variables of socio-demographic characteristics of interviewed subjects with their sporting or sports recreational participation. Sports activity of women has been lagging behind that of men for many years; however, the results of 2008 study have shown for the first time in 35 years that in this variable statistically significant difference between the genders have disappeared (see Chart 3). The results have been brought about due to appealing activities, aiming at girls and women, such as aerobics, different types of dance activities and various and interesting types of group exercising.

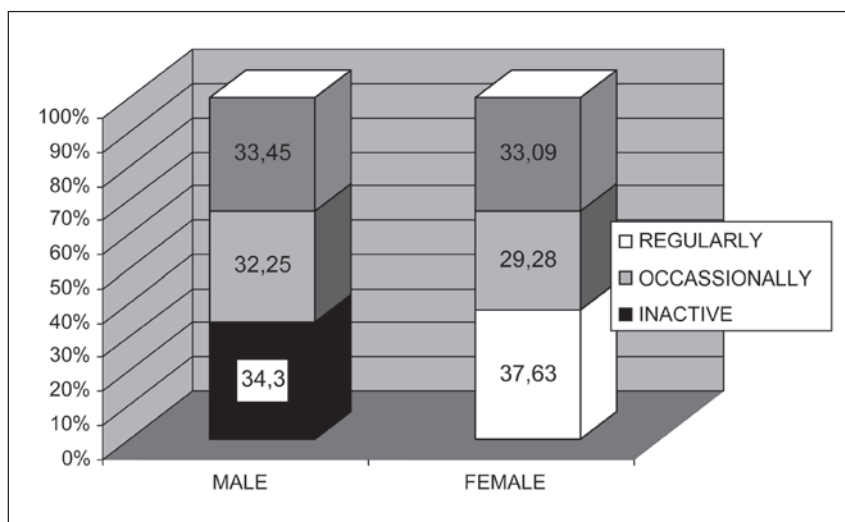

Chart 3. Frequency of sport activity in correlation with gender in 2008

The analysis of correlation between the sports activity and age has revealed as in previous also in the last study a high level of correlation. Although with age sports activity decreases (see Chart 4), this is more caused by a decrease of occasional and irregular activity. Only a small number of regularly active older people stopped to participate in this useful life activity. Older people, who have been more or less active throughout their lives, carry on with participation also in the transition from mature years to old age, as they cannot imagine their daily routine without regular activity and sports recreational participation.

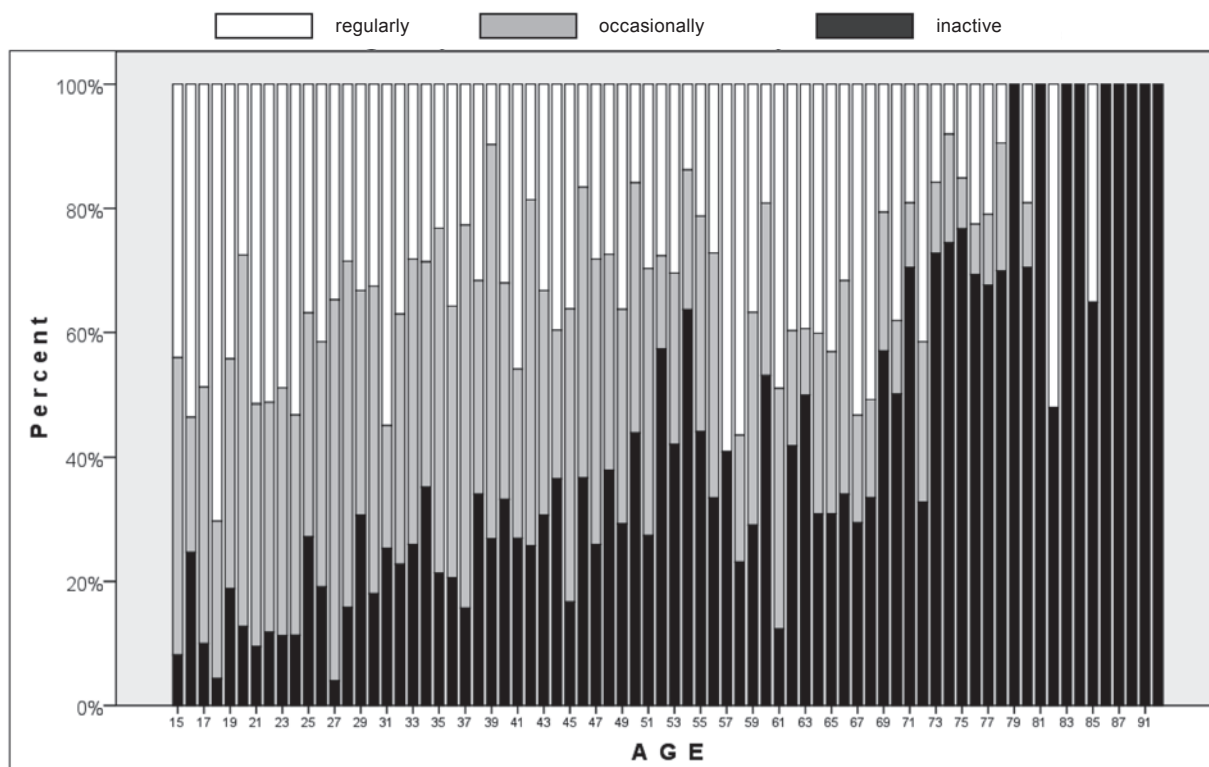

Chart 4. Frequency of sports activity according to age in 2008

The relationship of sports recreational activity and the level of education has also in the last study confirmed the correlation, albeit slightly smaller than in previously studied periods. It can be concluded that nowadays sports activity depends less on the level of education and it also indicates that physical and sports activity is becoming increasingly more important ingredient of healthy lifestyle for many Slovenian men and women.

Data from the last study reveal that walking is still the most popular motor activity of Slovenian people. Notably 58% of interviewed subjects prefer to walk, followed by swimming (34.8%), road cycling (24.9%), alpine skiing (16.6%), trekking and mountaineering (14.6%) and others. Analysis of popularity of sports activity in correlation with gender (see Chart 5) shows that walking, swimming and cycling are in the top three places in both men and women; nevertheless a higher proportion of women chose walking. The biggest differences between genders are in most strenuous sports activities, which require more sports skills. Men more often participate in team ball games – basketball and football, whereas women prefer aerobics and dance, which is correlated with the rhythm and music accompaniment (Pori, Sila, 2010).

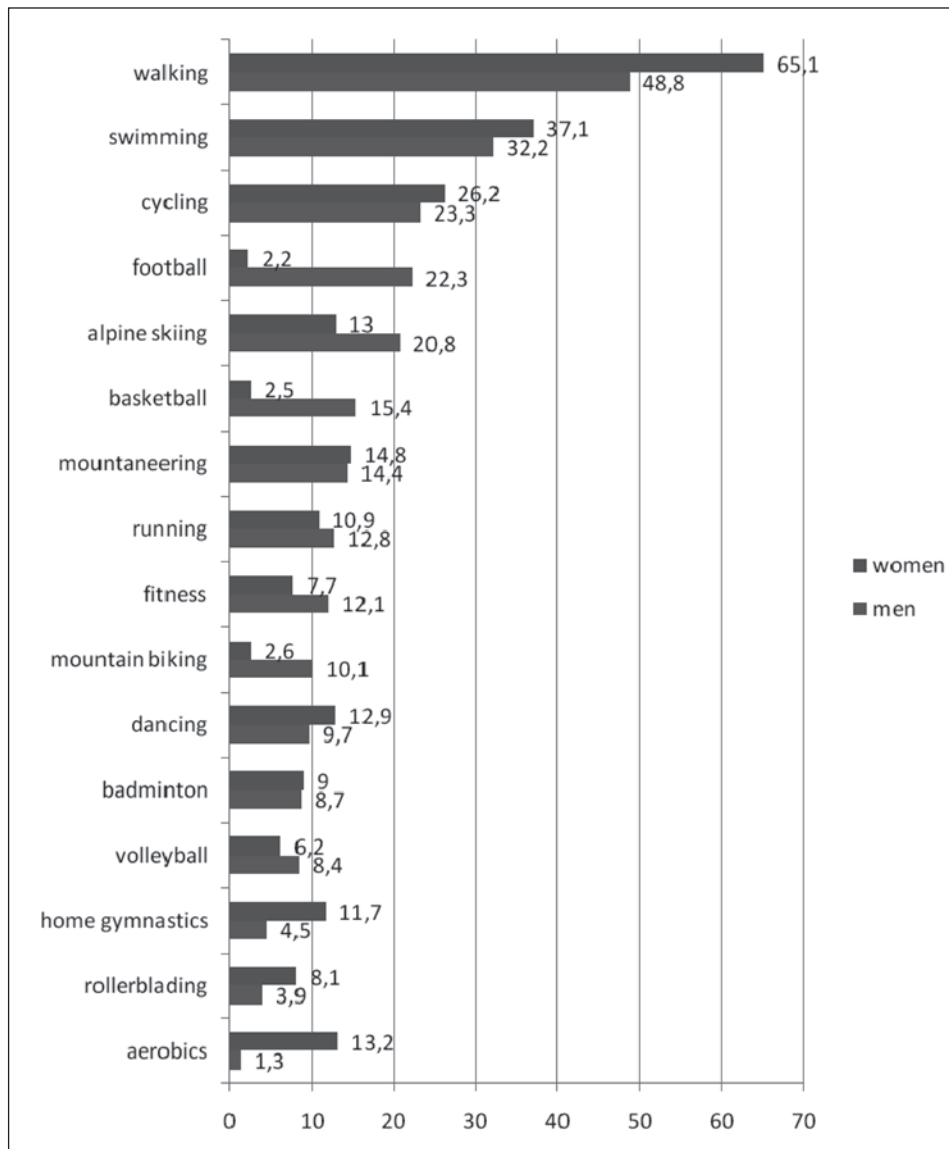

Chart 5. Most popular sports recreational activities according to gender in 2008

## Conclusions

Research work in the field of sports recreation of Slovenian population has been carried out at the Faculty of sport together with the Faculty of social sciences for a long time. Longitudinal study reveals sporting habits of Slovenian men and women in individual research periods as well as trends, which enable various experts in practice to suitably plan and programme specific awareness activities. In the centre of research are the types and forms of sports recreational participation in Slovenia as well as the popularity of individual sports disciplines. Each study has always analysed the correlation of sports recreational activity with the selected socio-demographic characteristics of interviewed subjects. The findings revealed an improvement in the attitude of people towards sports recreational participation throughout the 35-year study period. The proportion of regularly sportingly active people has been increasing and the results from the last study (2008) show that 63.9% of Slovenian population are active in one way or another. Statistically significant differences between men and women have faded away, sports activity decreases with age, although in people with established motor pattern and regular sports habits it stays at the same level. Level of education is to a certain extent still a factor of differentiation also in sports recreation of people, although its influence is gradually diminishing. Among the most popular sports are still traditional sports and aerobic motor activities and there are some differences between the genders in the participation in individual sports recreational activities.

## References

1. Berčič, H. (2002). Analysis of recreational sports activity of Slovenes. V: Milanović, D., Prot, F. (ur). *Kinesiology new Perspectives, Proceedings book*. 394-397. Zagreb, Faculty of Kinesiology, University of Zagreb.
2. Berčič, H., Sila, B. (2007). Ukvarjanje prebivalstva Slovenije s posameznimi športnimi zvrstmi. [*Participation of Slovenian population with individual sports disciplines*] Šport, 55 (3), 17-26.
3. Doupona Topič, M., Sila, B. (2007). Oblike in načini športne aktivnosti v povezavi s socialno stratifikacijo. [*Types and forms of sports activity in correlation with social stratification*] Šport, 55 (3), 12-16.
4. Findak, V. (2009). Kineziološko motrenje na upravljanje slobodnim vremenom. V: Andrijašević, M. (ur), *Upravljanje slobodnim vremenom sadržajima sporta i rekreacije*. Medjunarodna znanstveno-stručna konferencija, Kineziološki fakultet Sveučilišta u Zagrebu, Zagrebački velesajam, str. 25-31.
5. Petrović, K., Ambrožič, F., Bednarik, J., Berčič, H., Sila, B., Doupona Topič, M. (2001). Športnerekreativna dejavnost v Sloveniji 2000. [*Sports recreational activity in Slovenia in 2000*] Šport, 49 (3), 1-48.
6. Pori, M., Sila, B. (2010). Priljubljenost športnerekreativnih dejavnosti v povezavi s spolom in izobrazbo. [*Popularity of sports recreational activities in correlation with gender and level of education*] Šport, 58 (1-2), 108-111.
7. Sila, B. (2010). Športnerekreativna dejavnost Slovencev 2008. [*Sports recreational activity of Slovenian people in 2008*] Šport, 58 (1-2), 89-93.
8. Sila, B., Doupona Topič M., Pori, M. (2010). Športnerekreativna dejavnost Slovencev 2008. [*Sports recreational activity of Slovenian people in 2008*] Šport, 58 (1-2), 89-114.

## YOUTH COMPETITIONS: WHAT MODEL?

**Laura Capranica**

*DiSMUS, University of Rome Foro Italico, Rome, Italy*

At present, youth competitions are organized according to the gender and chronological age of the children, not considering their biological maturation and behavioral development. To ensure a proper development and to prevent an excessive psycho-physiological strain of a young athlete, youth competitions are generally based on a progression, adopting scaling down adult competition models in relation to the age of the children. To ascertain whether scaled youth competition codes are suitable for children to develop their discipline-specific skills, a multi-disciplinary (i.e., physiological, psychological, technical and tactical) measurement approach has been applied to the study of several real-life youth competitive settings. Findings showed that youth competitions pose a high physiological load on children independently from competition duration, pitch dimension, or simplified rules. Conversely, considerably different situational and contextual aspects between competitions played by young and elite athletes emerged from notational and match analyses. In particular, a better cooperation between teammates was observed during scaled down youth soccer matches, whereas young water polo players showed a high fragmentation in play and swimming patterns different from those reported for adult players when the youth code included a drastic reduction of pitch and goal dimensions, number of players, and ball size. Furthermore, youth athletes involved in individual sports showed tactical strategies opposite to that observed in elite athletes, probably due to the shorter duration or reduced distance of their competitions. Therefore, a coordinated effort to examine the complexities of youth sport performance is needed, especially considering the recent establishment of Youth Olympic Games.

**Key words:** *competitions, children and youth, model*



## USING SOCIAL RESEARCH & THEORY TO INFORM PUBLIC POLICIES INVOLVING SPORT

**Jay Coakley**

*University of Colorado, Colorado Springs, USA*

### **Abstract**

As sports have become increasingly visible and socially significant in national cultures, they have also become a concern among policy makers at the local and national levels. At the same time, citizens increasingly hold officials accountable for the consequences of their policy decisions and expect them to be able to justify those decisions with a combination of evidence and sound theories. Although sport policies in the past have often been based on untested assumptions, wishful thinking, and the personal testimonies of former athletes, there now is a need to use research and theories from a combination of disciplines when making sport policy and designing and implementing sport programs. This presentation identifies the ways that existing social science research and knowledge can contribute to the effectiveness of decision-making processes and maximize positive outcomes associated with sport policies and programs.

This is especially the case for policies intended to nurture and sustain national identity and programs intended to foster individual and community development. Examples are provided and suggestions are made for establishing a formal process to bring decision makers and sport scientists together for their mutual benefit and the benefit of the people they represent.

## **ADAPTED PHYSICAL ACTIVITY AND INCLUSION – TOWARDS IMPLEMENTING THE UN CONVENTION ON THE RIGHTS OF PERSONS WITH DISABILITIES**

**Gudrun Doll-Tepper**

*Freie Universität Berlin*

### **Introduction**

Since the introduction of “Adapted Physical Education” and “Adapted Physical Activity” as multi-disciplinary areas of theory and practice various approaches with regard to different settings (schools, rehabilitation centres, sport clubs etc.) were developed and implemented. During the last three decades emphasis has increasingly been placed on “integration” and “inclusion” and on equity issues related to persons with disabilities.

### **The un convention on the rights of persons with disabilities**

In December 2006 the United Nations General Assembly adopted the Convention on the Rights of Persons with Disabilities which is currently being implemented in many states around the world. In article 30(5) ”Participation in cultural life, recreation, leisure and sport” a description of measures is given to ensure participation of persons with disabilities on an equal basis in recreational, leisure and sporting activities:

- Encouragement and promotion of participation in mainstream sporting activities,
- Organisation, development and participation in disability-specific sporting and recreational activities,
- Ensuring access to venues and to services, and
- Ensuring equal access for children to participate in sport and physical education in schools.

Currently action plans are being developed and monitoring systems are put in place at national and local levels.

### **Linking “ape/apa” to the un convention**

With regard to schools the UN Convention clearly states that children and youth with disabilities should have access to an “inclusive education system at all levels”. A similar demand for inclusion was already published in 1994 in the Declaration of Salamanca by UNESCO.

The 1st World Summit on Physical Education 1999 in Berlin, Germany, and the 2<sup>nd</sup> World Summit on Physical Education in 2005 in Magglingen, Switzerland, emphasised the importance of quality physical education for all young people, including those with a disability.

In order to ensure quality physical education it is necessary to make curriculum time, resources and highly trained teachers available in schools and to provide all persons involved with basic knowledge about disabilities and inclusion.

With regard to the systems of sport and recreation it is important to train instructors, coaches and trainers who work with persons with disabilities, to organise events – inclusive and disability-specific where requested – and to encourage persons with disabilities to take up leadership positions in sport. Many Adapted Physical Activity experts have been and still are strong promoters of equity in sport and in society in general. A particular focus should be given to identifying relevant research questions and to intensifying scientific research.

### **The outlook**

Many questions need to be raised in the context of the UN Convention on the Rights of Persons with Disabilities, e.g.

- How can full participation and inclusion be ensured and practiced?
- What changes need to be made in the school and in the sport systems?
- What are the recommendations for practical implementation based on existing knowledge and experiences?

The presentation will address these issues and will initiate an open debate between researchers and practitioners.

## THE EXTRACTION OF NEURAL STRATEGIES FOR MOVEMENT CONTROL FROM THE ELECTROMYOGRAM: LIMITATIONS AND POSSIBILITIES

**Dario Farina**

*Department of Neurorehabilitation Engineering  
Bernstein Center for Computational Neuroscience  
University Medical Center Göttingen  
Georg-August University, Germany*

The electromyogram (EMG) contains information on the times of discharge of motor units and therefore it has often been used for measuring the neural drive to muscles.

In this lecture, I will review classic and advanced methods that have been applied for inferring the neural control of movement from the EMG. These methods can be divided in two categories: those that extract information from the interference signal that is indirectly related to the degree or type of muscle activation and those that aim at the identification of individual motor unit behavior.

The first class of methods include the amplitude and spectral analysis of the surface EMG, whose applications and limitations will be exemplified. The second class consists in methods for the decomposition of either intramuscular or surface EMG signals.

Special focus will be devoted to recent advances for the decomposition of the surface EMG which allow a direct, non-invasive, and accurate decoding of motor unit behavior. It will be shown that recent methods for automatic surface EMG decomposition can now be used in a variety of conditions, including dynamic contractions.

## **SPORT SCIENCE: BRIDGING THE GAP BETWEEN THE LABORATORY AND THE FIELD**

**Jay R. Hoffman**

*Sport and Exercise Science*

*University of Orlando, Orlando, FL, USA*

The ability to maximize talent is dependent upon a strong sport science effort. Talent alone will not be enough, as Calvin Coolidge once said “nothing is more common than unsuccessful men with talent”, it is the ability to study, examine and research that will maximize athletic performance. Sport science examines specific questions that arise on the field of competition by both coaches and athletes, and uses research to find the most appropriate response. From talent identification and methods of training used to maximize athletic performance, the approach is not only science driven but coach oriented. Questions that a coach may have regarding optimization of performance, maximizing recovery, prevention of overtraining and related issues can generate research ideas that provide important feedback to the success of a team. Sport science involves not only study of physiological adaptations to training, nutrition, psychology and biomechanics, but how these different systems interact with one another. The importance of sport science is not only recognized for coaches, but also sports administrators such as general managers and player personnel directors who need to have a solid background in sport science. On the professional level, athletes are often signed based upon what they have done, not what they will do. Understanding of expected performance declines or performance maintenance based upon fitness evaluation would potentially make contractual decisions more scientific and not to chance.

The focus of discussion in this talk will be to provide specific examples of how the interaction between a sport science program and various athletic teams in a University setting interact, and how specific needs of teams were used to develop research agendas and how results were used to benefit the athletes and teams. Specific discussion on methods of training for both in-season and off-season training, including the use of different training modalities and nutritional interventions will be covered.

## OPTIMIZING TRAINING QUALITY IN ELITE SPORT

**Erich Müller**

*University of Salzburg, Institute of Sport Science, Austria  
Christian Doppler Laboratory "Biomechanics in Skiing"*

Science plays an important role in optimizing the training quality in elite sport. The areas of applying science in the training process of elite athletes are very diverse. Parameters which essentially influence performance have to be analysed. In seasonal sports like skiing these investigations have to be done during field studies using highly developed measurement systems. The scientific challenges lie in the precision of the parameters determined (accuracy of the measurement system) and in the fact that the athlete should not be interfered severely by the measurement system during performance. The results of such investigations lead to a better understanding of movements used and provide coaches and athletes valuable support in directing training goals.

The efficiency of the training also depends on the quality of performance tests available. The efficiency of the training process also depends on the quality of performance tests available. If possible, valid and standardised tests should be built into the training process for all performance-relevant features of the sport in question, especially in more complex sports like game sports. The training plan must be organised as corresponds to the results of these tests. Within the framework of long-term cooperation with various Austrian Sports Associations, we have developed sport-specific test systems for tennis and soccer players as well as for alpine and nordic ski racers.

But the quality of training relies also to a great extent on the availability of specific training exercises. For the development of specific training exercises the principle of kinematic and kinetic correspondence has to be taken into consideration. This principle states that the special exercises must be in harmony with those parameters of movement which characterise the structure of competition technique. A coordinative affinity between training and competition exercises has the advantage that it results in favourable training stimuli in the musculature relevant to the specific movement. It has the further advantage in that the specific neuronal mechanisms are developed, which improve the strength utilizability in concrete execution of movement, as defined by the technique-specific muscle innervations schema. Both, training exercises as well as training devices have to be evaluated.

Alongside general guidelines of the long-term training plan, age and performance-specific benchmarks for the most important performance characteristics of the particular sport can also be made available. However, such benchmarks can be obtained for the respective sport only after pain-staking investigations of numerous athletes at various ages. Thus, for example, for Alpine ski conditioning training, an age- and sex-specific demand and conditioning capacity profile was generated after a ten-year longitudinal study in which all elite ski racers of the Austrian Skiing Association between the ages of 10 and 19 were tested.

Likewise in selecting training methods one needs to attend particularly to the aspect of developmental appropriateness. On the one hand, following the principle of variation, training exercises and training methods must be varied in regular intervals in order to be able to reach long-term performance improvements; on the other, the organismic load capacity of the child or youth must be taken into account in selecting the practice regimen.

## HEALTH-ENHANCING PHYSICAL ACTIVITY: ROOTS, AIMS, ORGANISATION, CURRENT STATE AND PERSPECTIVES

**Pekka Oja**

*UKK Institute, Tampere, Finland*

### Introduction

During the past several decades there has been a progressive decline of physical activity in people's daily living in industrialised countries. For majority of people, little physical effort is involved any more in their work, domestic chores, transportation and leisure. Estimates of current levels of physical activity in EU countries suggest that about two thirds of the adult population do not reach recommended levels of physical activity for health (Sjöström et al., 2006). The activity levels vary widely across the countries ranging from 45% to 23% of sufficiently active people. Available information from North America, Australia and some other countries suggest a similar situation in many other parts of the world. Thus, a majority of the world's industrialised populations, and increasingly also in the developing world, is insufficiently active for their health and could greatly benefit public health through physical activity.

Driven by the fact that physical inactivity is a major risk factor for the most common non-communicable diseases and that physical activity can counteract many of the ill effects of inactivity, the study of the interrelationships between physical activity and health and the promotion of physical activity for health have emerged as new areas of health-related research and health promotion.

Although the research interest on physical activity and health dates back to 1950's, the breakthrough in the scientific evidence on health benefits of physical activity took largely place in the 1980's and 1990's. "Health-enhancing physical activity" (HEPA) has emerged as a research field drawing its substance from diverse areas of physical activity and health sciences with strong elements of both basic and applied research. The accumulating evidence-base of the health benefits of physical activity is increasingly being adopted in major health policies of World Health Organisation, regional organisations, such as the European Union, and national governments. The current HEPA movement is an open multidisciplinary network of scientists, policy makers and practitioners aiming at the realisation of the health potential of physical activity for public health.

This paper briefly reviews the development of the scientific knowledge base of health-enhancing physical activity research and promotion and their policy context, and describes the current network of HEPA dedicated international organisations.

### Knowledge base

#### Research approaches

The research field of HEPA has developed in order to provide knowledge base for the understanding of the significance and the role of sport, exercise and physical activity for the health, function and well-being of all people. It is a multi-disciplinary research field encompassing a wide spectrum of sport and health science disciplines. These include established sport science disciplines such as exercise physiology, sport psychology, sociology of sport and adapted physical activity. Pertinent medical and health science disciplines are epidemiology, clinical medicine, rehabilitation, sports medicine, preventive medicine, behavioural medicine, health education and health promotion. In addition, the knowledge of related research and policy areas such as environmental and urban planning, transport and geography is being increasingly applied in the study and promotion of physical activity for health. The research focuses on establishing the links between physical activity, fitness and health, identifying the determinants of physical activity, developing methods for measuring health-related physical activity and fitness, and developing and evaluating ways to promote physical activity for health.

#### Health benefits of physical activity

Systematic collection, review and analysis of the scientific evidence of the health benefits of physical activity have taken place largely during the past two decades. In the 1990's two consecutive consensus conferences in Canada reviewed and evaluated the existing evidence on the interrelationships between physical activity, fitness and health (Bouchard et al. 1990 and 1994). A further critical evaluation was conducted by the U.S. Surgeon General (U.S. Department of Health and Human Services 1996). This report concluded that "Promotion of physical activity is important in the whole population, because it benefits growth and development in children and youth, prevents many diseases in adults, helps maintaining functional capacity in elderly, and supports independent life-style in ageing people".

Recent research on physical activity and health provides continuing, consistent and increasingly specific evidence for the support of the importance of physical activity for public health. The extensive systematic review of the scientific evidence undertaken by the U.S. Department of Health and Human Services (2008 Physical Activity Guidelines Advisory Committee) presents the most comprehensive summary of the current state of knowledge. By collecting and systematically evaluating the published literature on the relationships between physical activity and health and by assessing the strength of the evidence it concluded the following:

In children and adolescents there is strong evidence for: improved cardio-respiratory endurance and muscular fitness; favourable body composition; improved bone health; improved cardio-vascular and metabolic health biomarkers; and moderate evidence for reduced symptoms of anxiety and depression.

In adults and older adults there is strong evidence for: lower risk of early death; heart disease, stroke, type 2 diabetes, high blood pressure, adverse blood lipid profiles, metabolic syndrome, colon and breast cancers; prevention of weight gain; weight loss when combined with diet; improved cardio-respiratory and muscular fitness; prevention of falls; reduced depression; and better cognitive function (older adults). In addition, there is moderate to strong evidence for better functional health (older adults) and reduced abdominal obesity; and moderate evidence for weight maintenance after weight loss; lower risk of hip fracture; increased bone density; improved sleep quality; and lower risk of lung and endometrial cancers.

### Physical activity recommendations

Simultaneously with the accumulating evidence of the health benefits of physical activity the understanding of the specific characteristics of health-enhancing physical activity has evolved. The broadly adopted HEPA recommendation by the U.S. Centre for Disease Control and Prevention and the American College of Sports Medicine (Pate et al. 1995) stated: "Every US adult should accumulate 30 minutes or more of moderate-intensity physical activity on most, preferably all, days of the week."

The 1995 recommendations were updated by American College of Sports Medicine (ACSM) and American Heart Association (AHA) for adults (Haskell et al., 2007) and for elderly people (Nelson et al., 2007). These were followed by the U.S. Department of Health and Human Services's (U.S. DHHS) recommendations (U.S. DHHS 2008) (see table 1), which are based on an extensive review of literature (Physical Activity Guidelines Advisory Committee 2008). The latter recommendations for adults and older adults are in principal similar to the 2007 ACSM & AHA recommendations, but they recommend total weekly time (150 minutes) rather than the number of sessions per week (five times 30 minutes per week). The 2008 document includes also specific recommendations for young people, for people with disabilities and for pregnant and postpartum women. Accordingly, children and adolescents should do at least one hour physical activity every day, which should include moderate- and vigorous-intensity aerobic activities and muscle-strengthening and bone-strengthening activities. The recommendation for older adults is similar to the adult recommendation in regard to aerobic and muscle-strengthening activity and also includes activities for flexibility and balance. Also the recommendation for adults with disabilities follows largely the adult recommendation, but activities should be done according to people's abilities. Healthy pregnant and postpartum women are advised to engage in moderate-intensity physical activity according to the adult recommendation, and those who habitually engaged in vigorous-intensity activities can continue to do so during pregnancy and postpartum period with the support of their health-care provider.

As general principles the U.S. DHHS 2008 recommendations state:

- some activity is better than no activity
- many health benefits increase with the increase of the intensity, frequency and/or duration of activity
- the health benefits of physical activity greatly outweighs the health risks
- the health benefits of physical activity are largely independent of gender, race and ethnicity.

The U.S. 2008 recommendations were largely adopted by the World Health Organisation in its global physical activity recommendations published in 2010 (WHO 2010). They include recommendations for children and youth, adults and older adults. Children and youth are advised to do at least one hour of moderate- to vigorous-intensity physical activity every day. This should be mostly aerobic, but it should include also muscle- and bone-strengthening activities. Adults are recommended to do a minimum of 150 minutes moderate-intensity or 75 minutes vigorous-intensity aerobic activity or their equivalent combination per week, and in addition muscle-strengthening activities on at least two days a week. For additional health benefits double the amount of weekly activity is recommended. The recommendation for older adults is the same as for adults with regard to aerobic and muscle-strengthening activities. Older adults with poor mobility should also do activities that enhance balance and prevent falls.

Meanwhile many European countries, e.g. England (Department of Health 2004), Switzerland (Swiss Federal Office of Sports 2004), Finland (Fogelholm et al., 2006), and most recently Austria (Titze et al., 2010) have issued their own recommendations for health-enhancing physical activity taking into account not only the adult population but also children and adolescents and elderly people.

Table 1. US Department of Health and Human Services' recommendations (US DHHS, 2008).

Children and adolescents (aged 6-17)	<p>Children and adolescents should do 60 minutes (1 hour) or more of physical activity daily.</p> <p><b>Aerobic:</b> Most of the 60 or more minutes a day should be either moderate- or vigorous-intensity aerobic physical activity, and should include vigorous-intensity physical activity at least 3 days a week.</p> <p><b>Muscle-strengthening:</b> As part of their 60 or more minutes of daily physical activity, children and adolescents should include muscle-strengthening physical activity on at least 3 days of the week.</p> <p><b>Bone-strengthening:</b> As part of their 60 or more minutes of daily physical activity, children and adolescents should include bone-strengthening physical activity on at least 3 days of the week.</p>	It is important to encourage young people to participate in physical activities that are appropriate for their age, that are enjoyable, and that offer variety.
Adults (aged 18-64)	<p>Adults should do at least 150 minutes (2 hours and 30 minutes) a week of moderate-intensity, or 75 minutes (1 hour and 15 minutes) a week of vigorous-intensity aerobic physical activity, or an equivalent combination of moderate- and vigorous-intensity aerobic activity. Aerobic activity should be performed in episodes of at least 10 minutes, and preferably, it should be spread throughout the week.</p> <p>For additional and more extensive health benefits, adults should increase their aerobic physical activity to 300 minutes (5 hours) a week of moderate-intensity, or 150 minutes a week of vigorous-intensity aerobic physical activity, or an equivalent combination of moderate- and vigorous-intensity activity. Additional health benefits are gained by engaging in physical activity beyond this amount.</p> <p>Adults should also do muscle-strengthening activities that are moderate or high intensity and involve all major muscle groups on 2 or more days a week, as these activities provide additional health benefits.</p>	All adults should avoid inactivity. Some physical activity is better than none, and adults who participate in any amount of physical activity gain some health benefits.
Older adults (aged 65 and older)	<p>The guidelines for older adults are the same as for adults regarding aerobic and muscle-strengthening activities.</p> <p>In addition older adults should do exercises that maintain or improve balance if they are at risk of falling.</p>	<p>When older adults cannot do 150 minutes of moderate-intensity aerobic activity a week because of chronic conditions, they should be as physically active as their abilities and conditions allow.</p> <p>All older adults should avoid inactivity. Some physical activity is better than none, and older adults who participate in any amount of physical activity gain some health benefits.</p>
Women during pregnancy and the postpartum period	<p>Healthy women who are not already highly active or doing vigorous-intensity activity should get at least 150 minutes (2 hours and 30 minutes) of moderate-intensity aerobic activity per week during pregnancy and the postpartum period. Preferably, this activity should be spread throughout the week.</p> <p>Pregnant women who habitually engage in vigorous-intensity aerobic activity or are highly active can continue physical activity during pregnancy and the postpartum period, provided that they remain healthy and discuss with their health-care provider how and when activity should be adjusted over time.</p>	
Adults with disabilities	<p>Adults with disabilities, who are able to, should get at least 150 minutes per week (2 hours and 30 minutes) of moderate-intensity, or 75 minutes (1 hour and 15 minutes) per week of vigorous-intensity aerobic activity, or an equivalent combination of moderate- and vigorous-intensity aerobic activity. Aerobic activity should be performed in episodes of at least 10 minutes, and preferably, it should be spread throughout the week.</p> <p>They should also do muscle-strengthening activities of moderate or high intensity that involve all major muscle groups on 2 or more days per week as these activities provide additional health benefits.</p>	<p>When adults with disabilities are not able to meet the guidelines, they should engage in regular physical activity according to their abilities and should avoid inactivity.</p> <p>Adults with disabilities should consult their health-care providers about the amounts and types of physical activity that are appropriate for their abilities.</p>

## HEPA promotion

### Theoretical bases

Health-enhancing physical activity research is primarily practice-oriented in that its eventual goal is a positive impact on public health. The key HEPA message from the population perspective – a modest increase in daily physical activity – has significant promotional implications on individual, community, environmental and policy level. Physical activity needs to be promoted not only as sports and exercise but also as lifestyle activity that can be incorporated into everyday activities. Promotional measures need to foster cultural, social and environmental support for people to engage in physical activity as part of day-to-day living.

While the evidence on the health risks of inactivity and health benefits of increased activity as well as the characteristics of HEPA are becoming well established the ways how to effectively increase physical activity on individual, group, community and population levels remains a challenge for the research community. Yet, theoretically based models and



practices of physical activity promotion are developing based on the principles of health promotion (Green & Kreuter 1991), health behaviour change (Glanz et al., 1997) and ecological models of health behavior (Sallis & Owen 1999). The latter suggests that in addition to individual factors also the social and physical environment should be targeted for interventions on population physical activity.

The HEPA research on individual physical activity behavioural change is anchored on a number of behavioral modification theories and models. An integrated construct, The Trans-theoretical Model (Prochaska & Marcus 1994), provides theoretical bases for individual physical activity counselling and guidance in different settings. Ecological models of health behaviour describe multiple levels of social, cultural and physical environment factors relevant to health behaviour change (Sallis & Owen 1999) and provide directions for environmental and policy interventions. Brassington and King (2004) reviewed recently the literature on the theoretical bases for HEPA promotion. The current evidence on individual and small group interventions has been reviewed by Biddle (2004), on community interventions by Cavill and Foster (2004), and on environmental interventions by Owen and Salmon (2004).

### Policy development

The World Health Organisation has taken physical activity firmly on its policy agenda. In 2004 WHO issued the “Global Strategy on Diet and Physical Activity” (WHO 2004) followed by guidelines how to implement the strategy (WHO 2007). The World Health Organisation Europe has published the “European Charter on Counteracting Obesity” (WHO Europe 2006) and its follow-up on physical activity (WHO Europe 2007). The European Union has also adopted physical activity in its nutrition (European Commission 2007a) and sport (European Commission 2007b) policies.

The WHO’s guide for population-based approach to physical activity (WHO 2007) is meant to assist the member states and other stakeholders in the development and implementation of a national physical activity plan and provide guidance on policy options for effective promotion of physical activity at the national regional and local level. The guide lists the following elements to be important for successful policies and plans: high-level political commitment, integration in national policies, identification of national goals and objectives, overall health goals, specific objectives, funding, support from stakeholders, cultural sensitivity, integration of physical activity within other related sectors, multi-sectorial coordination, multiple intervention strategies, targeting whole populations as well as specific population groups, clear identity, implementation at different levels within the local setting, leadership and workforce development, dissemination, and monitoring and evaluation. This guide further provides a stepwise framework for planning and implementation and examples of areas for action.

The guidebook by WHO Europe (2007) presented a European framework for the promotion of physical activity. It was targeted to policy makers and experts in member states to design and implement physical activity-promoting policy and action as part of national public health agenda and through multi-sectorial cooperation. The document includes sections on the challenge, guiding principles for action, guidelines for action, and on setting goals and measuring success.

HEPA Europe, the European network for the promotion of health-enhancing physical activity, conducted in close collaboration with the WHO Regional Office for Europe an analysis of national policy documents on the promotion of physical activity (Daugbjerg et al., 2007). Forty-nine national policy documents were identified: 29 in health promotion, 12 in transport, 7 in sports, and one in environment. The policies addressed important project elements such as goals, implementation, timeframe, responsible body and evaluation, but there was limited consideration for inter-sectorial collaboration and targeting groups most in need for increased physical activity.

### National physical activity programmes

In addition to global, European and national physical activity policy development, evidence and experiences on physical activity programmes are increasing. Cavill et al. (2006) illustrated a theory-based promotional approach by analysing national physical activity promotion programmes from Finland, England, and Switzerland. The general approach was based on four tasks: (1) using the evidence for the health benefits of physical activity to make the case and increase action by policy makers, (2) conducting surveillance to collect evidence on the prevalence of physical activity, (3) reviewing evidence on ‘what works’ in increasing physical activity and influencing practice, and (4) evaluating practice.

In task one all three countries took a similar approach by drawing together the existing evidence on the health benefits of physical activity. In task two Finland and Switzerland collected systematic trend data and used them for advocacy, while in England many changes in survey methodology provided poor trend data. In task three England used a systematic approach to reviewing the evidence on what works while the other countries relied mainly on individual evaluation studies. Concerning the evaluation of practices a significant challenge for improvement remains, because all three countries relied much on experience rather than on evidence. The analysis showed clear differences in how the four tasks were undertaken in these countries and demonstrated how cultural and political factors strongly influence the promotional efforts.

Another HEPA Europe project analysed different approaches to physical activity and sport promotion in children and adolescents using case studies from six European countries (Kelly et al. 2009). The case projects came from the

Netherlands, Sweden, Germany, Spain, Finland and Switzerland. The analysis was aimed at discovering the experiences and lessons learned from implementing a physical activity promotion project. According to the analysis the following project elements were identified as important:

- allowing enough time for project planning and development, utilizing formative evaluation and stakeholder piloting and testing
- involving parents and teachers in the design, recruitment and delivery of a project is crucial
- short event type sub-project provides flexibility and the possibility to tailor approaches to different target audiences
- continuing reaching the active should be considered a success but to reach the inactive may need tailored approaches
- drop out from sports often seen in adolescence may be due to pressures from the sport community associated with performance related goals over participation for all objectives
- the internet is emerging as an important tool for such projects, both to engage children and adolescents and to support and communicate with implementers, teachers and parents
- schools are a good setting to reach many targets and certain sub groups; sports clubs have the resources and facilities to offer a wide range of activities
- evaluation of projects is improving, but it is important to continue to understand target groups needs and inform refinements and improvements for future work.

### Interventions

An extensive review by WHO (2009) identified 395 published studies reporting 261 interventions on diet and physical activity. The evidence was presented under eight categories: (1) policy and environment, (2) mass media, (3) school setting, (4) the workplace, (5) the community, (6) primary health care, (7) older adults, (8) religious settings. Multi-component interventions that are adapted to the local context were found to be the most successful. Interventions that used the existing social structures of a community, such as schools or the weekly meetings of older adults, reduced barriers to implementation. Effective interventions invariably involved participants in the planning and implementation stages. This review provides an up-to-date summary of findings from tried and tested diet and physical activity interventions that aim to reduce the risk of chronic non-communicable diseases.

### Organisational network

The international health-enhancing physical activity research and promotion community has been loosely organised and operates mainly as part of relevant scientific organisations' activities or as informal and unstructured networks. Only recently focused HEPA-dedicated organisations have been established.

HEPA research is integrated into the activities of several international scientific organisations. These organisations include International Society of Behavioural Medicine (ISBM), International Society of Behavioural Nutrition and Physical Activity (ISBNPA), and International Society of Physical Activity and Health (ISPAH). International HEPA networks include Global Alliance on Physical Activity (GAPA), Agita Mundo, International Physical Activity and Environment Network (IPEN), European Network for the Promotion of Health-Enhancing Physical Activity (HEPA Europe), and Physical Activity Networks of the Americans (RAFA/PANA).

While HEPA is being introduced increasingly in the programs of sport and health science universities and research institutions throughout the world only a few institutions focus primarily on HEPA research. Three WHO collaborating centres have HEPA as their special focus area:

UKK Institute for Health Promotion Research in Tampere, Finland,

Physical Activity and Health Branch of the U.S. Centres for Disease Control & Prevention in Atlanta, USA, and Department of Preventive Medicine and Public Health of Tokyo Medical College in Tokyo, Japan.

### Future perspectives

Although a solid scientific evidence base on the relationships between physical activity, fitness and health has been established, considerable challenges continue to face the HEPA research and promotion. Of particular importance is to pursue further the understanding of the dose-response relationships of physical activity and different health outcomes. This kind of knowledge is needed to effectively apply physical activity as part of health promotion. As much of the current knowledge on the health benefits of physical activity comes from epidemiological studies, more experimental research remains to be done to better understand the dose-response relationships of physical activity and specific health outcomes and the biological mechanisms underlying the relations.

Scientific basis of how to make individuals, communities and populations more active remains still relatively unexplored. In order to fully materialise the public health potential of physical activity more research-based knowledge

is needed. This requires multidisciplinary efforts including not only sport and health sciences but also environmental, transportation, urban and community planning, architectural and economical research approaches.

Research concerning health-enhancing physical activity needs to be practice-driven also in the future. It has to serve the needs of populations and guide decision makers and professionals to design and implement effective health policies and practices through physical activity.

## References

- Biddle, S. (2004). Individual and small group interventions. In: Oja, P. & Borms, J. (eds.) *Health Enhancing Physical Activity*. ICSSPE, Perspectives: The Multidisciplinary Series of Physical Education and Sport Science, Vol. 6. Oxford, Mayer & Mayer Sport.
- Bouchard, C., Shephard, R.J., Stephens, T., Sutton, J.R., & McPherson, B.M., (Editors), (1990). *Exercise, Fitness and Health. A Consensus of Current Knowledge*. Champaign, IL: Human Kinetics Publishers Inc.
- Bouchard, C., Shephard, R.J. & Stephens, T. (Editors), (1994). *Physical Activity, Fitness and Health. International Proceedings and Consensus Statement*. Champaign, IL: Human Kinetics.
- Brassington, G. & King, A. (2004). Theoretical considerations. In: Oja, P. & Borms, J. (eds.) *Health Enhancing Physical Activity*. ICSSPE, Perspectives: The Multidisciplinary Series of Physical Education and Sport Science, Vol. 6. Oxford, Mayer & Mayer Sport.
- Cavill, N. & Foster, C. (2004). Community interventions. In: Oja, P. & Borms, J. (eds.) *Health Enhancing Physical Activity*. ICSSPE, Perspectives: The Multidisciplinary Series of Physical Education and Sport Science, Vol. 6. Oxford, Mayer & Mayer Sport.
- Cavill, N., Foster, C., Oja, P., Martin, B. W. (2006). An evidence-based approach to physical activity promotion and policy development in Europe: contrasting case studies. *IUHPE – Promotion & Education* 2006; 13: 20-27.
- Daughjerg, S. B., Kahlmeier, S., Racioppi, F., Martin-Diener, E., Martin, B., Oja, P., Bull, F. (2009). Promotion of physical activity in the European region: Content analysis of 27 national policy documents. *Journal of Physical Activity and Health* 6: 805-817.
- Department of Health, Physical Activity, Health Improvement and Prevention (2004). *At least five a week. A report from the Chief Medical Officer*. ([www.dh.gov.uk/PublicationsAndStatistics/Publications](http://www.dh.gov.uk/PublicationsAndStatistics/Publications))
- European Commission (2007 a). *White Paper on Nutrition* ([http://ec.europa.eu/health/ph\\_determinants/life\\_style/nutrition/keydocs\\_nutrition\\_en.htm](http://ec.europa.eu/health/ph_determinants/life_style/nutrition/keydocs_nutrition_en.htm))
- European Commission (2007 b). *White Paper on Sport* ([http://ec.europa.eu/sport/whitepaper/wp\\_on\\_sport\\_en.pdf](http://ec.europa.eu/sport/whitepaper/wp_on_sport_en.pdf))
- Fogelholm, M., Suni, J., Rinne, M., Oja, P., Vuori, I. (2005). Physical Activity Pie: a graphical presentation integrating recommendations for fitness and health. *Journal of Physical Activity and Health* 2:391-396.
- Glanz, K., Lewis, F. M. & Rimer, B. K. (Editors), (1997). *Health Behavior and Health Education*. 2<sup>nd</sup> ed. San Francisco: Jossey-Bass Inc.
- Green, L.W. & Kreuter, M.W. (1999). *Health promotion planning: an educational and ecological approach*. 3<sup>rd</sup> ed., Mountain View, Ca: Mayfield.
- Haskell, W., Lee, I-M., Pate, R., Powell, K., Blair, S., Franklin, B., Macera, C., Heath, G., Thompson, P., Bauman, A. (2007). Physical Activity and Public Health: Updated Recommendations for Adults from the American College of Sports Medicine and the American Heart Association. *Med. Sci. Sports Exerc.* 39(8), 1423-1434.
- Kelly, P., Cavill, N., Foster, C. (2009). An analysis of national approaches to promoting physical activity and sports in children and adolescents. World Health Organisation Europe. Retrieved January 30, 2011 from [http://www.physicalactivityandhealth.ch/hepaeurope/materials/09\\_Oxford\\_children\\_analysis\\_summary\\_report.pdf.pdf](http://www.physicalactivityandhealth.ch/hepaeurope/materials/09_Oxford_children_analysis_summary_report.pdf.pdf)
- Nelson, M., Rejeski, W., Blair, S., Duncan, P., Judge, J., King, A., Macera, C., Castaneda-Sceppa, C. (2007). Physical Activity and Public Health in Older Adults: Recommendation from the American College of Sports Medicine and the American Heart Association. *Med. Sci. Sports Exerc.* 39(8), 1435-1445.
- Owen, N. & Salmon, J. (2004). Environmental interventions. In: Oja, P. & Borms, J. (eds.) *Health Enhancing Physical Activity*. ICSSPE, Perspectives: The Multidisciplinary Series of Physical Education and Sport Science, Vol. 6. Oxford, Mayer & Mayer Sport.
- Pate, R., Pratt, M., Blair, S., Haskell, W.L., Macera, C.A., Bouchard, C. et al. (1995). Physical Activity and Public Health. A Recommendation from the Centres for the Disease Control and Prevention and the American College of Sports Medicine. *Journal of American Medical Association*, 273(5), 402-407.
- Physical Activity Guidelines Advisory Committee (2008). Physical Activity Guidelines Advisory Committee Report, 2008. Washington, DC: US Department of Health and Human Services. [<http://www.health.gov/paguidelines>]. Accessed 9 February 2011.
- Prochaska, J.O. & Marcus B.H. (1994). The transtheoretical model: applications to exercise. In: Dishman, R. K. (editor). *Advances in Exercise Adherence*. Champaign, IL: Human Kinetics.
- Sallis, J. F. & Owen, N. (1997). Ecological models. In: Glans, K., Lewis, F.M., Rimer, B.K. (Eds.), *Health Behavior and Health Education*. 2<sup>nd</sup> Edition. San Francisco: Josey Bass Inc.
- Sallis, J.F., & Owen, N. (1999). *Physical activity and behavioral medicine*. Thousand Oaks: SAGE Publications Inc.
- Sjöström, M., Oja, P., Hagströmer, M., Smith, B., Bauman, A. (2006). Health-enhancing physical activity across European Union countries: the Eurobarometer study. *Journal of Public Health* 14; 291-300.
- Swiss Federal Office of Sports (2004). *Health Enhancing Physical Activity Recommendations*. [http://www.hepa.ch/gf/gf\\_baspo/HEPA\\_recommendations\\_e.pdf](http://www.hepa.ch/gf/gf_baspo/HEPA_recommendations_e.pdf)

25. Titze, S., Ring-Dimitriou, S., Schober, P.H., Halbwachs, C., Samitz, G., Miko, H.C., Lercher, P., Stein, K.V., Gäbler, C., Bauer, R., Gollner, E., Windhaber, J., Bachl, N., Dorner, T.E. & Arbeitsgruppe Körperliche Aktivität/Bewegung/Sport der Österreichischen Gesellschaft für Public Health (2010). Bundesministerium für Gesundheit, Gesundheit Österreich GmbH, Geschäftsbereich Fonds Gesundes Österreich (Hrsg.). Österreichische Empfehlungen für gesundheitswirksame Bewegung. Wien: Eigenverlag. <http://www.fgoe.org/presse-publikationen/downloads/forschung/bewegungsempfehlungen/2010-04-28.1864800615>. Accessed 24 February 2011.
26. U.S. Department of Health and Human Services, Centres for Disease Control and Prevention, National Centre for Chronic Disease Prevention and Health Promotion (1996). *Physical Activity and Health: A Report of the Surgeon General*. Pittsburg, Pa: President's Council on Physical Fitness and Sports.
27. U.S. Department of Health and Human Services (2008). 2008 Physical Activity Guidelines for Americans. Washington, DC: US Department of Health and Human Services. <http://www.health.gov/paguidelines>. Accessed 28 January 2011.
28. World Health Organisation (2004). *Global Strategy on Diet, Physical Activity and Health*. ([www.who.int/dietphysicalactivity/strategy/eb11344/strategy/](http://www.who.int/dietphysicalactivity/strategy/eb11344/strategy/))
29. World Health Organisation (2007). A Guide for Population-based Approaches to Increasing Levels of Physical Activity. Implementation of the WHO Global Strategy on Diet, Physical Activity and Health. <http://www.who.int/entity/dietphysicalactivity/PA-promotionguide.pdf>. Accessed 20 January 2011.
30. World Health Organisation (2009). Interventions on diet and physical activity: what works: summary report. Geneva, World Health Organisation. <http://www.who.int/dietphysicalactivity/summary-report-09.pdf>. Accessed 30 January 2011.
31. World Health Organisation (2010). Global recommendations on physical activity for health. [http://whqlibdoc.who.int/publications/2010/9789241599979\\_eng.pdf](http://whqlibdoc.who.int/publications/2010/9789241599979_eng.pdf). Accessed 30 January 2011.
32. World Health Organisation, Regional Office for Europe (2006). *European Charter on Counteracting Obesity*. WHO Regional Office for Europe, Copenhagen, Denmark. (<http://www.euro.who.int/Document/E89567.pdf>).
33. World Health Organisation, Regional Office for Europe (2007). *Steps to Health. A European Framework to Promote Physical Activity for Health*. WHO Regional Office for Europe, Copenhagen, Denmark.

## FOR A RESPONSIBLE SPORTS TOURISM AND A LOCAL SUSTAINABLE DEVELOPMENT

**Claude Sobry**

*University Lille North of France, ER3S-IRNIST*

### Abstract

Even though sports tourism is the most dynamic field of the global economic sector and even if it has had the steadiest growth for many years, the knowledge we have about it is virtually non-existent. All surveys show that this progression will remain strong in the next few years with, as in every other branch of tourism, a change in demand linked to the ups and downs of the global economy as well as to the changes in the customers themselves. Therefore, it seems necessary to study this field on an international level to compare the experiences, increase our knowledge, and establish models of development. This is primarily so that the investors and administrators can find the information they need today to make decisions based not on their estimations of how much profit they could generate in the short-term, but taking into account the sustainable development of the region in which they wish to invest. That is the reason why it is necessary to develop a structure, for example international study programmes at master level, that could carry some fundamental research on sports tourism as well as practical researches that could bring some answers to the concrete matters.

**Key words:** *sport tourism, types of sport tourism, sustainable development*

### Introduction

Despite the economic crises, tourism remains a steady sector, and sport tourism is the branch which develops the fastest. The notion of sport tourism appeared in the 1980's in Europe and the United States, to define a series of practices belonging to both sport and tourism understood in a general way. The expression "sport tourism" first appeared in the title of an article in 1987 (De Knop, 1987). We can notice that even if some sport federations have been interested in this phenomenon for many years, the World Tourism Organization (UNWTO) has not classified it as a category on its own, like other tourism-related phenomenon such as tourism for gastronomy, culture, arts, etc. The main difficulty being probably due to the very strong links between sport and tourism: because it is so natural to travel to go to a sports event, skiing, fishing or else (whether it is to practice or organise it, or to assist to it), it does not appear at first as obvious to study the economical and sociological effects it can have, nor to analyse the long-term consequences of an event or a facility when coming to sustainable development, that is to say taking into account the social, economical and environmental aspects.

### So what do we mean by Sport Tourism?

Before even trying to give a definition of sport tourism, we have to bear in mind that what might seem to be a relatively recent activity, at least seen as a social phenomenon, has appeared a long time ago. 3 different eras can be distinguished:

- We could refer to the Olympic Games which appeared in the Antiques in 776B.C. The sports facilities allowed a large crowd to participate: in Olympia there were enough seats to welcome 40.000 people. We also know that the athletes representing their city were accompanied by "supporters" who were encouraging them during the Games. Jusserand (1986) relates a few facts telling us about links between travels and traditional games.
- From the 17<sup>th</sup> century to the beginning of the 20<sup>th</sup> c. the young aristocrats willing to become "gentlemen" (it only concerned men, not women) had to travel the "Grand Tour" all the way to Rome. We come across this kind of segregation again in the beginning of the 20<sup>th</sup> century when Baron Pierre de Coubertin was standing against the idea of women taking part in the Olympic Games: "Female Olympics would be impractical, uninteresting, unaesthetic and incorrect." It is due to this Grand Tour which lasted from 6 to 18 months that the potential of the mountains and mountain sports were discovered. The upper-class of the second-half of the 19<sup>th</sup> and the beginning of the 20<sup>th</sup> century also had a role in the development of sports tourism. Having inherited when still quite young, the privileged young man kept away from money matters had to find something to keep himself busy. He could get involved into politics and culture but also sport and tourism. That is what led T. Veblen (1899) to say that sport was a "conspicuous waste of time". Around 1840-1860, English doctors started to advise their rich patients to go get some rejuvenating air in the mountains. This new kind of tourism led to the creation of resorts such as Davos, Arosa, Montana or Saint-Moritz in Switzerland, in the Alberg in Austria and in the Vercors (Villars-de Lans) in France. "Mountains in summer: fresh air, water, sports, trips and visits". Strengthened by their facilities, some resorts tried to bring their summer customers

to come back in winter and invented the “winter sports’ holidays”. The English were the instigators. Various sports could be practised: ice-skating, sledging, curling, the main one being downhill skiing -which was the only recognised type of skiing (“Downhill only”, wrote Lunn) even though the equipment and the instructors were Norwegian. The Scandinavian sports were staying in their own countries, as well as in the massifs of the Vosges and the Jura. We have to bear in mind that even before going for frenzy downhill (on slopes that had not been prepared) the skiers had to go up the mountain by foot or with the help of sealskin. To make it easier, chair lifts started to appear after 1924. Pomagalski invented the bottom lift in 1935. When summer resorts turned to skiing one after the other, some resorts were directly issued from winter sports. The very first being Megève, which was by the Rotschild family after the first World War -with no ambitions towards tourism at all. There they also established the very first chair lift, the Mont d’Arbois. Others such as Sestrières, the Alpe d’Huez or Meribel -originated by the English- were created ex nihilo.

- With the inflation generated by the First World War and the Wall Street Crash of 1929, the bourgeoisie went bankrupt and in the 30’s the workforce was more concerned about working time and purchasing power than tourism, culture and sports. It is not until the mid 1950s that the purchasing power and the amount of free time of the middle-class had increased enough to allow sport and tourism to go beyond the circles of the privileged social groups.

It is now time to shift to an approach of what is sports tourism today. One of the difficulties about defining sports tourism is due to the meaning of words itself. In Europe the word “sport” has for a long time been a synonym for “competition”. The sports movement had taken the word on its side (as a kind of intellectual terrorism) and had attached a very particular connotation of competition to it. In North America, “sport” stands at the same time for sports as organised by the federations and the “recreational” sports, closer to the entertaining activities involving sport. A third expression, “outdoor activities” (“sports de pleine nature” in French) covers all physical activities practised in a natural environment. These activities are obviously included in sports tourism. These endless debates came to an end in 1992, when the Council of Europe established an official definition of what the word “*sport*” covers: “*all forms of physical activity which, through casual or organised participation, aim at expressing or improving physical fitness and mental well-being, forming social relationships or obtaining results in competitions at all levels*”.

As for tourism, we can use the definition given by the World Tourism Organization: “*The activities practised by people who travel to and stay in places outside their usual environment for more than twenty-four (24) hours and not more than one consecutive year for leisure, business and other purposes not related to the exercise of an activity remunerated from within the place visited*”.

Following these approaches and by voluntarily forgetting about the debates linked to these definitions (more in Pigeassou, 2004), we will bear in mind the following typology to define the boundaries of Sports Tourism:

- Sports Tourism for action;
- Sports Tourism for entertainment;
- Cultural Sports Tourism;
- Activist Sports Tourism.

*Sports Tourism for action* includes the whole range of activities from participating to a high-level competition to practising fly-fishing in Ireland.

*Sports Tourism for entertainment* covers essentially the influx of people travelling to beat a sports event. It has probably been reinforced by the media coverage of the major sports events. To make it a bit more tricky, we could ask ourselves if watching a competition on a screen (a television, a computer or a telephone) would not be a kind of virtual sports tourism, just like we can talk about virtual tourism for people who only travel through the pictures brought to them by the new audiovisual technologies -while sitting in an armchair.

*Cultural Sports Tourism* refers to visiting the sites of past major events. In Berlin, the stadium where the ill-fated 1936 Olympics were set up -of which only the original façade still remains- continues to attract visitors, just like the changing rooms of the Stade de France used by the French team who won the World Cup in 1998. The tour trips in Barcelona always go through the Montjuic where stand the main Olympic facilities, stadium, swimming-pool, etc.

*Activist Sports Tourism* is the direct result of the need for the sports movement to be ruled and administered. It is necessary for the representatives, leaders and technicians to travel, as well as for the staff going along with the teams for instance.

But following this approach brings an issue: considering that sports tourism is defined by a destination, it overlooks all the entertaining activities practised when on a tourism trip that does not have sport as a main purpose. Economically speaking, it is forgetting about all the activities generally developed by small companies (see Bouhala, 2008, 2001) that are added to a trip having other purposes, professional or for tourism. It is also disregarding trekking, that means travelling with no accommodation but requires spending money on renting or buying equipment (dinghy, skis, bikes, etc.), passes for the sites (downhill or cross-country skiing), various expenditures (food and drinks), etc. This approach also forgets that the tourism sector knows how to respond to the customers’ wish of having an access to sports facilities, even if they

don't use them, to sell traditional trips. More than 50% of offers advertise the possibility of entertaining activity courses, different activities organised or not, gyms, etc.

If it is necessary to make the difference between an approach based on demand and one based on supply, it is essential to know how to spot the potential a region or a even a mere site has for sports tourism, to evaluate the advantages and highlight the risks. We may hear a lot about the effects of major sports events, but not enough about what a middle-sized structure or event can bring.

### **Sports tourism and sustainable development**

The development of these "games" is at the origin of socio-economical evolutions that have been so far drowned in the bigger world of tourism in general. The main interest of targeting and defining what this kind of tourism involves, to study it more precisely, is the fact that it has a huge potential for sustainable development by relying on organisations, structures and facilities on a more reasonable, human-sized scale. But it is also dangerously threatening the environment and/or the locals, who might be excluded.

Let's take some examples to illustrate this idea:

Lorient, a French port with 60.000 inhabitants located in Brittany will welcome in June 2012 one leg of a famous sailing race, the Volvo Ocean Race -the former Whitbread. It is a race between teams around the world, on a monohull and with stopovers. Lorient has been looking for a few years to get some visibility by organising sailing competitions. Its decision to take part in supervising a stopover in this race was inspired from Galway, an Irish town with 70.000 inhabitants, thus absolutely comparable to Lorient. But Lorient's infrastructures, economical background and sailing heritage are far more developed. For Galway which welcomed a leg of the same race in 2009, the economical consequences generated by the visitors during the 15-day stopover are estimated to 55 million Euros. The indirect effects are quite surprising: the race is thought to have generated a 15% increase in registrations at the University of Galway and more than a year and a half after the event the local companies who had understood the importance of the impact were still enjoying the profits. This is the example of a one-off event that had a rather positive effect on the process of a long-term sustainable development.

Another example, in France this time: after having tried to bring skiing to its full potential by all means, the French mountains have the best facilities in the world, and the resorts that have been constructed everywhere without taking the environment into account just to attract as many tourists as possible, are now overwhelmed by trash and wastewater handling and evacuation problems. When some solutions start to come into light regarding the architecture and waste treatment, the matter with artificial snow is also brought up. To attract tourists the resorts promise them snow-covered slopes all winter, thus emptying the water supplies to make artificial snow. Let me also point out the works necessary to bring this water to the snow cannons, which disturb the local fauna, the use of construction vehicles and snow-plows flattening the ground and damaging the flora, the noise generated by the snow cannons working at night and disturbing the animal world -mostly nocturnal in this environment-, but also the seeding of water with a bacteria allowing it to turn to snow even a few degrees above zero. Even if nobody can guess what kind of consequences this bacteria will have on the long term, it is still used as snow is the only way to attract tourists in an economy that has planned virtually no other solution and relies on the short and long term climate changes. Another problem is the influx of people of people coming to the villages and sending the local populations away from the resorts. The locals now have to live in villages that can be far from their place of work, further down in the valley because accommodation close to the resorts has become too expensive. Moreover, a great part of the new jobs brought by the resorts being seasonal, it is most of the time non-locals who work there even if the pay is generally not great.

So we have here an example of a completely unbalanced development of a sports tourism activity that has a much negative impact sociologically and environmentally speaking. Only the economical aspect is rather positive even though it varies a lot from one year to the next.

### **An example of responsible sports tourism: the events in the Vallée de Joux**

The Vallée de Joux lies opposite the French Jura and the quality of its natural environment is remarkable. 3 villages stand around a lake and apart from the road leading out of the valley (an easy access from the French side, by going through mountain passes from Switzerland) there is just another 25km (16miles) road going around the lake. The valley has invested in a Sports Centre that combines an ice-rink, a swimming-pool, a sports hall, track and field facilities, tennis courts, etc. All these facilities are grouped in one and only place and at first their only purpose was to meet the locals' needs. We must not forget that thanks to the lake and the mountains the place had long been a destination for tourism, offering the whole range of water sports from swimming to water-skiing, sailing, windsurfing, but also hiking (with snowshoes in winter) and cycling, skiing downhill and cross-country and all ski-related sports, ice-skating, etc. The Tourism Office has long been dealing with hotels and accommodation. It rapidly became necessary to organise sports events to raise money for the Sports Centre, as it could not survive with the local events and activities only. The Sports Centre and the Tourism Office moved in a single location and were appointed the same director to combine sports and

tourism in favour of the development of the local socio-economical activity. Sports competitions, about 40 a year have been organised very locally and centred around the Sports Centre and its staff. Thus, the team organising the events is not temporary -as it is often the case- and so the process of researching and collaborating with the sponsors and partners can be carried on over the years. Facilities welcoming pupils, teams, seminars and all sorts of groups have been constructed.

To organize these sports events (summer and winter triathlons, ice-hockey tournaments, slowUp, Dragonboats, etc.), money and people are required. For the people, the organisers rely on the valley's inhabitants who will work there for free. Even if in this place like everywhere else there are less and less free workers, it is still the locals who are at the core of the events. We can observe for instance a first kind of short-term economical consequences for the local clubs and organisations that have a stall along the slowUp path (25-35,000 participants), and who then invest their benefits in equipment and infrastructures helpful to the members or inhabitants of the community. As for the financial needs the local companies, watchmakers and farmers, understand where their interest lie. The great watchmakers do not use the word "sponsoring", but "help". These companies support the sports and cultural structures as well as the sports events organised in the valley. This way they want the youth to know their name so as to recruit new staff and develop the team spirit of their employees (sometimes as many as 2,000 in big companies like Jaeger-Lecoutre), but also to promote an image of perseverance, tenacity and team spirit.

One of the treasures of this region is its natural environment. All the events strictly respect this environment and the emphasis is put on managing and recycling the waste, and a responsible behaviour from the participants. For the triathlon the organizers have signed an agreement with Recycling, and there are eco-zones where people can recycle their waste all over the site. The food that is distributed is mostly fruits, which avoids using any unnecessary packaging. Registrations are made via the internet so no paper is wasted and the contestants would be immediately disqualified if they were to drop their litter on the floor during the event. The race starts 500 metres from the train station so that people don't need to use their car. It is this idea of protecting the environment that makes the valley's events very special.

Some other aspects also have to be highlighted. The organisers develop "eco-events". On the day of the triathlon they offer a "green event" when road bikes are replaced by mountain bikes. SlowUp promotes a "human-powered" mobility for a whole day.

The individual is not forgotten in these projects. The Dragonboats race, an opportunity to support cancer research, advertises the notion of solidarity. The contestants are crews representing big companies such as Dell, UBS, Cargill, Caterpillar, Sanofi-Aventis, etc. This race is a good opportunity to do some internal team-building, develop relationships between the companies and convey a message to the customer with absolutely positive local socio-economical consequences, as the Vallée de Joux is getting famous through this kind of events which then attracts tourists, employees and companies.

This is the best example of sport-based sustainable development I could think of.

## Conclusion

Even though sports tourism is the most dynamic field of the global economic sector and even if it has had the steadiest growth for many years, the knowledge we have about it could be compared to the one we had of sports economics in Europe in the early 1980s, i.e. virtually non-existent. All surveys show that this progression will remain strong in the next few years with, as in every other branch of tourism, a change in demand linked to the ups and downs of the global economy as well as to the changes in the customers themselves. It is then necessary to study this field on an international level to compare the experiences, increase our knowledge, establish models of development so that the investors and administrators can find the information they need today to make decisions based not on their estimations of how much profit they could generate on the short-term, but taking into account the sustainable development of the region in which they wish to invest. In that way the case of the golf courses in Croatia is remarkable: going from 3 today to dozens in a few years -why not? But is it the best way to attract tourists and make sure they'll come back on the long run? How could these structures become economically viable, socially efficient and favourable to the environment? How will they fit in the existing system, etc. The best would be to find the answers to these questions before starting to invest, complementary or alternative investments might turn to be more efficient and profitable while keeping -if that is the official decision in terms of development- a strong sports and entertainment-centred identity. And we could have many more examples regarding the facilities as well as the events.

That is the reason why it is necessary to develop a structure that could carry some fundamental research on sports tourism as well as practical researches that could bring some answers to the concrete matters. That is the objective of the IMISTE (International Master In Sports Tourism Engineering), that trains students doing a Master's Degree and gives them an international experience as they visit 4 countries in 2 years, and of the IRNIST (International Research Network In Sports Tourism) that combines university research by bringing more than 20 universities from around the globe to work on sports tourism together and develops an international PhD during which the student will visit 3 different countries, all in partnership with different structures such as the UN, the International Labour Organisation, the IOC and other International Sports Federations.



## References

1. Bouahoula, M. (2008). *Management de la petite entreprise de loisirs sportifs*, De Boeck.
2. Bouahoula, M. (2001). Relations inter-entreprises dans un marché local: le cas des PE-TPE du tourisme sportif en Vercors, *Revue Espaces et Sociétés*, No. 105-106, pp. 229-251
3. De Knop, P. (1987). Some thoughts on the influence of education recreation and sport tourism. In: M. Garmise (ed.), *Proceedings of an international seminar: International seminar and workshop on outdoor education, recreation and sport tourism* (pp. 38-45), Netanya, Israel.
4. Pigeassou, C. (2004). Le tourisme sportif: une réalité sociale aux contours incertains. In C. Sobry (ed.), *Le Tourisme Sportif* (pp. 33-72). Paris: Septentrion.

## WHY EXERCISE IS A NECESSARY ADJUNCT TO DIETING WHEN THE PURPOSE IS WEIGHT LOSS

**Katarina Tomljenović Borer**

*School of Kinesiology, The University of Michigan, Ann Arbor, USA*

Increased obesity in the US (18) and worldwide is a significant concern because of its multiple social burdens (14), deleterious impact on health and longevity (34), and cultural conditions that facilitate its development (23, 27). All of these prompt pharmacological (28), surgical (33), and lifestyle (3) approaches to its treatment. These are either palliative or block overeating mechanically or chemically, but our understanding of the biological mechanism that defends an established weight setpoint, be it a healthy or obese one, is still elusive. Two conceptual obstacles have interfered with more successful analysis of this mechanism. The first is the prevailing focus exclusively on body fat mass as the key variable involved in regulation and defense of body mass. While dietary obesity in genetically predisposed individuals is characterized by proliferation and hypertrophy of adipocytes (29, 39) particularly during post-deprivation weight regain (42), changes in lean body mass (25) and bone mass always accompany changes in body fat. For each kg of body fat lost or gained, there is a 16.5 g change in bone mineral (30). After body mass plateau has increased, adipocyte number does not respond to weight reduction (21). Instead, a reduction in the three components of body mass is met with robust compensatory increases in hunger and food consumption (13, 47), a significant reduction in metabolic energy expenditure (20, 37, 56), and a significant increase in the efficiency of weight regain processes (42). This leads to the already mentioned progressive compensatory reversion to the pre-deprivation weight plateau (35, 67). The second barrier is the assumption that feeding is controlled by a leptin negative feedback that can reduce obese body fat setpoint to a healthy non-obese level by suppressing feeding (1, 5, 60). This concept stems in part from the correspondence between basal plasma leptin concentrations and adiposity (12) and, in part, from suppression of feeding and reduction of body fat mass after administration of exogenous leptin to leptin-deficient rodents (22). While administration of leptin to humans lacking the ability to produce leptin does suppress feeding and body fat mass (15, 59), administration of leptin to obese humans with intact leptin genotype as a test of this negative feedback hypothesis to reduce obesity has failed (24, 58).

A more promising approach to non-pharmacological and non-surgical solution of obesity is to use a physiological paradigm that is effective in suppressing hunger and metabolic drive for weight regain and reducing body fat and body mass setpoint. These alterations are uniquely produced by physical activity administered after dieting-induced weight loss as it lowers the setpoint at which weight is defended in rodents whether such activity is externally driven (41) or internally motivated (38). That this most likely also works in humans is seen in meta-analyses of the effectiveness of exercise in retaining weight loss achieved by dieting (19) and in records about the contribution of exercise to long-term weight-loss retention kept by National Weight Control Registry (11, 43). Of particular interest is the observation that exercise counteracts all three components contributing to relapse after weight loss: hunger (41, 47), hypometabolism (41, 48), and metabolic processes that increase the efficiency of weight regain (42, 46).

It is quite possible that exercise lowers the regulated weight setpoint during early phase of recovery from weight loss through activation of S outflow mediated by increased leptin secretion (10, 36). This early weight recovery period represents a state of relative leptin deficiency that, similar to lesions of medial basal hypothalamus, is characterized by a metabolic pattern indicative of PS overactivity and insulin oversecretion (8, 41, 52). Exercise is particularly effective in reducing rodent overeating, the rate of weight regain, and the ultimate body mass setpoint when applied at an early stage of unrestricted feeding after weight loss (41). In analogous fashion, exercise is more effective in sustaining weight loss from dietary restriction than in inducing a weight loss in humans (19). By triggering leptin-induced increase in S activation, exercise may re-set the sympatho-vagal balance in favor of S restraint over metabolism (26) and leptin restraint over hunger drive (31).

A remarkable congruence between the neural substrates implicated in regulation of body mass and fat plateau (8, 50, 52) and sites of leptin action (1, 5, 31, 45, 51) supports this hypothesis. Leptin inhibits hunger drive (17, 47) by acting on ventral striatum (6, 7, 17) and hypothalamic circuits that control feeding (5, 60). In ventral striatum, it affects the motivation to seek food through the inhibition of dopaminergic neural circuits of reward associated with the amygdala and nucleus accumbens shell (1, 5-7, 17, 44). Concurrently, leptin stimulates the activity of appetite-suppressing melanocortin neurons in arcuate (ARC) hypothalamus (5, 51, 60) and inhibits serotonergic circuits that project from pontine-medullary raphe nuclei to the ARC nucleus that stimulate feeding and fat synthesis (61) and to ventromedial hypothalamic (VMH) nucleus that stimulate bone mass accretion (31). Leptin controls S outflow from the paraventricular hypothalamic nucleus (PVN) through the ARC and VMH nuclei to peripheral targets. These ventral tegmental and hypothalamic circuits alter their activity in response to body mass loss and leptin withdrawal (6, 7, 17), and their activity is restored to pre-deprivation

pattern by leptin administration (49). Structural integrity of ARC and VMH nuclei is necessary to support S activation of energy expending behaviors and processes (50) and to oppose PS vagal activation of insulin oversecretion (8), transient hyperphagia, and increased biosynthesis of fat (52), actions that are lost after their destruction.

Discovery of leptin, leptin-deficient rodents, and cloning of its receptor (54, 62) allowed the autonomic and hyperphagic consequences of mediobasal hypothalamic lesions to be reinterpreted as conditions of leptin deficiency (45). Currently, there is evidence for activation of S outflow by direct leptin action on its receptors in VMH and ARC nuclei (5, 45, 50) and for indirect S activation of these receptors through leptin action on serotonergic ponto-medullary raphe neurons projecting to the ARC and VMH nuclei (31). Inhibition by leptin of raphe nuclei increases S outflow from the VMH nucleus to bone where it blocks bone formation and mineralization by curtailing osteocalcin bioactivity (26). A corresponding indirect leptin action on the ARC nucleus facilitates S outflow to inhibit feeding and fat synthesis. Thus stimulation by leptin of S outflow blocks bone formation and mineralization (53) as well as adiponectin release from adipocytes (16) and thereby restrains PS activity and peripheral anabolic insulin actions (2, 55).

Like exercise, leptin is ineffective in reducing body mass below its stable obese or non-obese plateau in humans (25, 58). In contrast, after body mass loss, a decline in leptin concentration and withdrawal of its S actions over appetite and metabolism increases hunger and metabolic drive for body mass resynthesis and decreases energy expenditure. Higher peripheral insulin sensitivity (2, 55) and increased PS action facilitate energy storage processes (40). Administration of leptin in such weight reduced state restores behavioral, physiological, and brain activation changes seen after weight reduction to their pre-deprivation levels. Leptin reversible changes to non-visual food cues were observed in weight reduced humans in the hypothalamus and cingulate and frontal cortices (49). Leptin administration decreased hyperphagia and increased metabolic energy expenditure in leptin-deficient humans (15, 59) and increased S tone, energy expenditure, skeletal muscle work efficiency, and plasma thyroid hormone concentrations in weight-reduced individuals to pre-deprivation levels (46, 48). Leptin's neural and peripheral S actions progressively decline as body mass is regained (51) suggesting the role for this hormone as a determinant of regulated body mass setpoint rather than as a negative feedback driving body mass below this setpoint.

While pharmacological (28) and surgical (33) approaches to treatment of obesity produce striking weight and fat mass losses, they also have serious deleterious side effects (4). In contrast, exercise acutely suppresses appetite (10, 32), provides very poor link between energy expenditure and compensatory energy intake (9), lowers regulated body mass setpoint after weight loss in rodents (38, 42) and presumably in humans (19), and has a number of additional health benefits. For all of those reasons, it would be important to explore exercise as a necessary adjunct to dieting when the purpose is weight loss.

## References

1. Ahima RS. Adipose tissue as an endocrine organ. *Obesity* (Silver Spring) 14 Suppl 5:242S-249S, 2006.
2. Assali AR, Ganor A, Beigel Y, Shafer Z, Hershovici T, Fainaru M. Insulin resistance in obesity: body-weight or energy balance? *J Endocrinol* 171:293-298, 2001.
3. Aucott L, Gray D, Rothnie H, Thapa M, Waweru C. Effects of lifestyle interventions and long-term weight loss on lipid outcomes - a systematic review. *Obes Rev* 12: e412-25. 2011.
4. Bal B, Koch TR, Finelli FC, Sarr MG; Medscape. Managing medical and surgical disorders after divided Roux-en-Y gastric bypass surgery. *Nat Rev Gastroenterol Hepatol*. 7: 320-34, 2010.
5. Benoit SC, Clegg DJ, Seeley RJ, and Woods SC. Insulin and leptin as adiposity signals. *Rec Prog Horm Res* 59: 267-285, 2004.
6. Berridge KC. Food reward: brain substrates of wanting and liking. *Neurosci Biobehav Rev* 20:1-25, 1996..
7. Berridge KC. "Liking" and "wanting" food rewards: Brain substrates and roles in eating disorders. *Physiol Behav* 97: 537-550, 2009.
8. Berthoud HR, Jeanrenaud B. Acute hyperinsulinemia and its reversal by vagotomy after lesions of the ventromedial hypothalamus in anesthetized rats. *Endocrinol* 105:146-151, 1979.
9. Blundell, J. E., and N. A. King. Effects of exercise on appetite control: loose coupling between energy expenditure and energy intake. *Int. J. Obes. Relat. Metab. Disord*. 22: S22-S29, 1998.
10. Borer KT, Wuorinen EC, Ku K, Burant C. Appetite responds to changes in meal content, whereas ghrelin, leptin, and insulin track changes in energy availability. *J Clin Endocr Metab* 94: 2290-2298, 2009a.
11. Catenacci VA, Ogden LG, Stuht J, Phelan S, Wing RR, Hill JO, Wyatt HR. Physical activity patterns in the National Weight Control Registry. *Obesity* 16, 153-161, 2008.
12. Considine RV, Sinha MK, Heiman ML, Kriauciunas A, Stephens TW, Nyce MR, Ohannesian JP, Marco CC, McKee LJ, Bauer TL, Caro JF. Serum immunoreactive -leptin concentrations in normal-weight and obese humans. *N Engl J Med* 334: 292-295, 1996.
13. Cornier M, Grunwald G, Johnson S, Bessesen D. Effects of short-term overfeeding on hunger, satiety, and energy intake in thin and reduced-obese individuals. *Appetite* 43, 253-259, 2004.
14. Dixon JB. The effect of obesity on health outcomes. *Mol Cell Endocr* 316: 104-108, 2010.

15. Farooqi IS, Jebb SA, Langmack G, Lawrence E, Cheetham CH, Prentice AM, Hughes IA, McCamish MA, O'Rahilly S. Effects of recombinant leptin therapy in a child with congenital leptin deficiency. *N Engl J Med* 1999, 341: 879-884.
16. Ferron M, Hinoi E, Karsenty G, Ducy P. Osteocalcin differentially regulates beta cell and adipocyte gene expression and affects the development of metabolic diseases in wild-type mice. *Proc Natl Acad Sci U S A*. 105: 5266-70, 2008.
17. Figlewicz DP, Benoit SC. Insulin, leptin, and food reward: Update 2008. *Am J Physiol* 296: R9-R19, 2009.
18. Flegal KM, Carroll MD, Ogden CL, Curtin LR. Prevalence and trends in obesity among US adults, 1999-2008. *JAMA* 303 : 235-241, 2010.
19. Franz MJ, VanWormer JJ, Crain AL, Boucher JL, Histon T, Caplan W, Bowman JD, Pronk NP. Weight loss outcomes: A systematic review and meta-analysis of weight loss clinical trials with a minimum of 1-year follow-up. *J Am Diet Assoc* 107: 1755-1767, 2007.
20. Goldsmith R, Joannisse DR, Gallagher D, Pavlovich K, Shamoan E, Leibel RL, Rosenbaum M. Effects of experimental weight perturbation on skeletal muscle work efficiency, fuel utilization, and biochemistry in human subjects. *Am J Physiol* 298(1):R79-88, 2010.
21. Gurr MI, Jung RT, Robinson MP, and James WP. Adipose tissue cellularity in man: the relationship between fat cell size and number, the mass and distribution of body fat and the history of weight gain and loss. *Int J Obes* 6: 419-436, 1982.
22. Halaas JL, Gajiwala KS, Maffei M, Cohen SL, Chait BT, Rabinowitz D, Lallone RL, Burley SK, Friedman JM. Weight-reducing effects of the plasma protein encoded by the obese gene. *Science* 296 (5223): 543-546, 1995.
23. Hetherington MM, and Cecil JE. Gene-environment interactions in obesity. *Forum Nutr* 63: 195-203, 2010.
24. Heymsfield SB, Greenberg AS, Fujioka K, Dixon RM, Kushner R, Hunt T, Lubina JA, Patane J, Self B, Hunt P, McCamish M. Recombinant leptin for weight loss in obese and lean adults: a randomized, controlled, dose-escalation trial. *JAMA* 282:1568-1575, 1999.
25. Heymsfield SB, Thomas D, Nguyen AM, Peng JZ, Martin C, Shen W, Strauss B, Bosty-Westphal A, Muller MJ. Voluntary weight loss: systematic review of early phase body composition changes. *Obes Rev* 12:e348-361, 2011.
26. Hinoi E, Gao N, Jung DY, Yadav V, Yoshizawa T, Myers Jr MG, Chua Jr SC, Kim JK, Kaestner KH, Karsenty G. The sympathetic tone mediates leptin's inhibition of insulin secretion by modulating osteocalcin bioactivity. *J Cell Biol* 183:1235-1242, 2008.
27. Huneault L, Mathieu MÈ, Tremblay A. Globalization and modernization: an obesogenic combination. *Obes Rev* 12:e64-72, 2011.
28. Hussain SS, Bloom SR. The pharmacological treatment and management of obesity. *Postgrad Med*. 123(1):34-44, 2011.
29. Jackman MR, Steig A, Higgins JA, Johnson GC, Fleming-Elder BK, Bessesen DH, and MacLean PS. Weight regain after sustained weight reduction is accompanied by suppressed oxidation of dietary fat and adipocyte hyperplasia. *Am J Physiol* 294: R1117-1129, 2008.
30. Jensen LB, Quaade F, Sorensen OH. Bone loss accompanying voluntary weight loss in obese humans. *J Bone Miner Res* 9: 459-463, 1994.
31. Karsenty G & Oury F. The central regulation of bone mass, the first link between bone remodeling and energy metabolism. *J Clin Endocrinol Metab* 95: 4795-4801, 2010.
32. King NA, Burley VJ, Blundell JE. Exercise-induced suppression of appetite: Effects on food intake and implications for energy balance. *Eur J Clin Nutr* 1994, 48: 715-724.
33. Kissane NA, Pratt JS. Medical and surgical treatment of obesity. *Best Pract Res Clin Anaesthesiol*. 25:11-25, 2011.
34. Klein S, Burke LE, Bray GA, Blair S, Allison DB, Pi-Sunyer X, Hong Y, Eckel RH. Clinical implications of obesity with specific focus on cardiovascular disease. *Circulation* 110: 2952-2967, 2004.
35. Kraschnewski JL, Boan J, Esposito J, Sherwood NE, Lehman EB, Kephart DK, and Sciamanna CN. Long-term weight loss maintenance in the United States. *Int J Obes (Lond)* 34: 1644-1654, 2010.
36. Kraemer RR, Durand RJ, Acevedo EO, et al. Effects of high-intensity exercise on leptin and testosterone concentrations in well-trained males. *Endocrine* 21:261-265. 2003
37. Leibel R, Hirsch J. Diminished energy requirements in reduced obese patients. *Metabolism* 33: 164-170, 1984.
38. Levin BE, and Dunn-Meynell AA. Chronic exercise lowers the defended body weight gain and adiposity in diet-induced obese rats. *Am J Physiol Regul Integr Comp Physiol* 286: R771-778, 2004.
39. Lofgren P, Andersson I, Adolfsson B, Leijonhufvud BM, Hertel K, Hoffstedt J, and Arner P. Long-term prospective and controlled studies demonstrate adipose tissue hypercellularity and relative leptin deficiency in the postobese state. *J Clin Endocrinol Metab* 90: 6207-6213, 2005a.
40. Lofgren P, Hoffstedt J, Naslund E, Wiren M, and Arner P. Prospective and controlled studies of the actions of insulin and catecholamine in fat cells of obese women following weight reduction. *Diabetologia* 48: 2334-2342, 2005b.
41. MacLean PS, Higgins JA, Wyatt HR, Melanson EL, Johnson GC, Jackman MR, Giles ED, Brown IE, Hill JO. Regular exercise attenuates the metabolic drive to regain weight after long-term weight loss. *Am J Physiol* 297: R793-R802, 2009.
42. MacLean PS, Bergouignan A, Cornier MA, Jackman MR. Biology's Response to Dieting: the Impetus for Weight Regain. *Am J Physiol* 2011. [Epub ahead of print]
43. McGuire MT, Wing RR, Klem ML, Hill JO. Behavioral strategies of individuals who have maintained long-term weight losses. *Obesity Research* 7: 334-341, 1999.
44. Myers, M., Cowley, M., Munzberg, H. Mechanisms of leptin action and leptin resistance. *Ann. Rev. Physiol.* 70, 537-556, 2008.

45. Pelleymounter MA, Cullen MJ, Baker MB, Hecht R, Winters D, Boone T, Collins F. Effects of the obese gene product on body weight regulation in ob/ob mice. *Science* 269: 540-543, 1995.
46. Rosenbaum M, Goldsmith R, Bloomfield D, Magnano A, Weimer L, Heymsfield S, Gallagher D, Mayer L, Murphy E, Leibel RL. Low-dose leptin reverses skeletal muscle, autonomic, and neuroendocrine adaptations to maintenance of reduced weight. *J Clin Invest* 115:3579-86, 2005.
47. Rosenbaum M, Kissileff HR, Mayer LE, Hirsch J, Leibel RL. Energy intake in weight-reduced humans. *Brain Res* 1350:95-102, 2010.
48. Rosenbaum M, Murphy EM, Heymsfield SB, Matthews DE, Leibel RL. Low dose leptin administration reverses effects of sustained weight-reduction on energy expenditure and circulating concentrations of thyroid hormones. *J Clin Endocrinol Metab* 87: 2391-2394, 2002.
49. Rosenbaum M, Sy M, Pavlovich K, Leibel RL, Hirsch J. Leptin reverses weight loss-induced changes in regional neural activity responses to visual food stimuli. *J Clin Invest*. 118: 2583-2591, 2008.
50. Satoh N, Ogawa Y, Katsuura G, Numata Y, Tsuji T, Hayase M, Ebihara K, Masuzaki H, Hosoda K, Yoshimasa Y, Nakao K. Sympathetic activation of leptin via the ventromedial hypothalamus: leptin-induced increase in catecholamine secretion. *Diabetes* 48: 1787-1793, 1999.
51. Schwartz MW, Niswender KD. Adiposity signaling and biological defense against weight gain: absence of protection or central hormone resistance? *J Clin Endocrinol Metab* 89: 5889-5897, 2004.
52. Sclafani A, Aravich PF, Landman M. Vagotomy blocks hypothalamic hyperphagia in rats on a chow diet and sucrose solution, but not on a palatable mixed diet. *J Comp Physiol Psychol* 95: 720-734, 1981.
53. Takeda S, Eleftheriou F, Levasseur R, Liu X, Zhao L, Parker KL, Armstrong D, Ducy P, Karsenty G. Leptin regulates bone formation via the sympathetic nervous system. *Cell* 111:305-317, 2002
54. Tartaglia LA, Dembski M, Weng X, Deng N, Culpepper J, Devos R, Richards GJ, Campfield LA, Clark FT, Deeds J, Muir C, Sanker S, Moriarty A, Moore KJ, Smutko JS, Mays GG, Wool EA, Monroe CA, Tepper RI. Identification and expression cloning of a leptin receptor, OB-R. *Cell* 83:1263-1271,1995.
55. Tschrutter O, Fritsche A, Thamer C, Haap M, Shirkavand F, Rahe S, Staiger H, Maerker E, Häring H, Stumvoll M. Plasma adiponectin concentrations predict insulin sensitivity of both glucose and lipid metabolism. *Diabetes*. 52:239-243, 2003.
56. Weigle D, Sande K, Iverius P, Monsen E, Brunzell J. Weight loss leads to a marked decrease in nonresting energy expenditure in ambulatory human subjects. *Metabolism* 37: 930-936, 1988.
57. Weiss EC, Galuska DA, Kettel Khan L, Gillespie C, and Serdula MK. Weight regain in U.S. adults who experienced substantial weight loss, 1999-2002. *Am J Prev Med* 33: 34-40, 2007.
58. Westerterp-Plantenga MS, Saris WH, Hukshorn CJ, Campfield LA. Effects of weekly administration of pegylated recombinant human OB protein on appetite profile and energy metabolism in obese men. *Am J Clin Nutr* 74: 426-434, 2001.
59. Williamson D, Ravussin E, Wong M, Wagner A, Dipaol, A, Caglayan S, Ozata M, Martin C, Walden H, Arnett C, Licinio J. Microanalysis of eating behavior of three leptin deficient adults treated with leptin therapy. *Appetite* 45, 75-80, 2005.
60. Woods SC, and D'Alessio DA. Central control of body weight and appetite. *J Clin Endocrinol Metab* 93: S37-50, 2008.
61. Yadav VK, Oury F, Suda N, Liu ZW, Gao XB, Confavreux C, Klemenhagen KC, Tanaka KF, Gingrich JA, Guo XE, Tecott LH, Mann JJ, Hen R, Horvath TL, Karsenty G. A serotonin-dependent mechanism explains the leptin regulation of bone mass, appetite, and energy expenditure. *Cell* 138:976-989, 2009.
62. Zhang Y, Proenca R, Maffei M, Barone M, Leopold L, Friedman JM. Positional cloning of the mouse obese gene and its human homologue. *Nature* 372:425-432, 1994.

## SETTING STANDARDS IN YOUTH FITNESS TESTING: PROBLEMS, SOLUTIONS, AND FUTURE DIRECTIONS

**Weimo Zhu**

*University of Illinois at Urbana-Champaign, USA*

Setting the standards, or cut-off scores, is one of the most important issues in youth fitness testing and evaluation. For a long time, interest in fitness testing and evaluation has been mainly in performance related fitness, where the focus is on “the more (e.g., number of pull-ups a student can do) or less (e.g., how fast a student can finish a one-mile run/walk), the better”, depending on the nature of a fitness measure. The norm-referenced evaluation framework, in which a test taker’s performance is compared with his/her peers, is appropriate in this case since the emphasis is on peak performance or high-level achievement.

The US Presidential Physical Fitness Award Program (PCPFS) is a good example of norm-referenced evaluation, in which students must score at or above the 85<sup>th</sup> percentile on all five test items to qualify for the award. Many similar examples can be found worldwide, e.g., Eurofit also uses the norm-referenced evaluation framework. Technically, constructing a norm-referenced test is relatively easy as long as a nationally representative sample can be obtained and regularly updated. With such a sample, norms (e.g., percentiles and percentile ranks) can be computed and derived. There are, however, three major limitations associated with the norm-referenced evaluation framework. First, it is difficult to update norms regularly due to cost, time and manpower constraints. Second, the interpretation depends on the fitness of the reference population. The designations of “average” or “above average” have limited meaning if the majority of a population is unfit or unhealthy. Finally, it tends to reward children and youth who are already fit while potentially discouraging those who are not fit. These limitations become more obvious when the interest of fitness testing is on “health-related” fitness. Fortunately, these limitations can be better overcome by employing the criterion-referenced (CR) evaluation framework.

The concept of CR evaluation and testing was introduced to physical education and fitness testing in the late 1980s. In contrast to the norm-referenced framework, in which the evaluation of a test taker’s competency is judged relative to the performance of other students, the CR evaluation compares the test taker’s performance with an absolute criterion. In educational assessment, the “absolute criterion behavior” could be if a student has mastered the information taught in a specific subject or grade; in the context of youth health-related fitness, the interest could be if a child meets a minimal needed physical fitness level based on a criterion. The fundamental interest in setting a CR standard is to determine if a test taker is “good enough” for the construct being measured, which could be the test taker’s reading comprehension, math problem solving skill, or language proficiency. For health-related fitness testing, the key interest is if a test taker is “fit enough” to be free of potential health risks.

For children’s fitness testing, the interest could be further extended to represent whether a child is “fit enough for the future,” i.e., fit enough to likely grow up to be a healthy adult. Because the key interest and outcome of the CR test/evaluation is the classification (e.g., pass vs. fail, fit vs. not fit, or at risk vs. needs improvement vs. healthy), the accuracy of the classification is key. The “Health Outcome Centered” method has been the predominant approach in setting CR standards for health-related fitness tests. The key steps of the “Health Outcome Centered” method include: (a) determine the components of health-related fitness, which often include cardiorespiratory fitness or aerobic capacity, body composition and muscular fitness; (b) select a criterion measure, as well as field tests, of the fitness component; (c) determine the relationships between the criterion measure/field tests and health outcome measures, which could be mortality, an individual factor or a group of health risk measures; (d) set the standards or cut-off scores according to the relationship determined, i.e., determine the point or level at which a fitness parameter is associated with an increased risk of a disease outcome or risk factors of a disease; and (e) validate or cross-validate using additional measures and samples. While CR evaluation is able to address the shortcomings of the norm-referenced evaluation and fits the needs of health-related fitness assessment very well, it has its own issues and challenges, including the selection of health outcome measures, equivalence of cut-off scores across field tests, consequences of misclassification, and cross-group and cultural differences.

Some new measurement and statistical methods have been developed to facilitate establishment of standards. In particular, the use of test equating procedures and approaches based on receiver operator characteristic (ROC) curves offer considerable potential for addressing some of the CR evaluation related issues and challenges noted above. After a brief review of changes in youth fitness testing evaluation and their importance, two major evaluation systems, i.e., norm- and criterion-referenced, their advantages and limitations will be described. This presentation then focuses on why a CR evaluation system should be employed.

Critical issues and challenges in developing a CR evaluation system for aerobic fitness and body composition are discussed in depth, and the latest changes in setting standards for FITNESSGRAM®, a US health-related fitness testing and education program, will be presented.

The latest statistical methods (e.g., test equating and ROC) that may help address these issues will be introduced and described. Finally, remaining issues, future research needs and directions in contemporary youth fitness testing will be outlined.



# Adapted Physical Activity and Kinesitherapy

**6<sup>th</sup> INTERNATIONAL  
SCIENTIFIC  
CONFERENCE ON  
KINESIOLOGY**

**“INTEGRATIVE POWER OF  
KINESIOLOGY”**

**Editor:  
Prof. Dubravka Ciliga, PhD**

**Peer Reviewers:  
Prof. Rajko Vute, PhD  
Prof. Valkova Hana, PhD  
Prof. Dubravka Ciliga, PhD**



**Secretary:  
Tatjana Trošt Bobić, BEd**



## DIFFERENCES IN CERTAIN MOTOR ABILITIES BETWEEN CHILDREN WITH SPEECH DISORDERS AND CHILDREN WITH HEARING IMPAIRMENT\*

Dubravka Ciliga<sup>1</sup>, Tatjana Trošt Bobić<sup>1</sup> and Angel Naumovski<sup>2</sup>

<sup>1</sup>Faculty of Kinesiology, University of Zagreb, Croatia

<sup>2</sup>Center for Education "Slava Raškaj", Zagreb, Croatia

### Abstract

The main goal of this research was to determine the differences in certain motor abilities between children with speech disorders (stutter) and children with hearing impairment. For that purpose, children with speech disorders and children with hearing impairments of the Clinic "Suvag" were included in the study. Motor abilities were evaluated with 6 motor tests: hand tapping, long jump from a steady position, obstacle course backwards, sit-ups, bend forward, enduring suspended. A series of univariate t-tests were carried out and a statistically significant difference between subjects with speech disorders and subjects with hearing impairment at the level of significance of .01 was found in all the measured variables. The canonical discriminative function significantly distinguished subjects with speech disorders and those with hearing impairment at the significance level of .01 ( $p < 0.01$ ), with relatively high canonical correlation (0.71). The largest distinction was found in the test hand tapping (0.83). The smallest but still statistically significant difference between groups was present in the bend forward test (0.33). The results of this study provide a better insight into the field of motor abilities of people with speech disorders and hearing impairments. The obtained results emphasize the need to include motor activities in the regular educational and rehabilitation processes of people with hearing impairments. The need to include fine motor movements in the work with people with speech disorders such as stutter is also evident.

**Key words:** *hearing impairment, speech disorder, motor abilities, fine motor tasks*

### Introduction

Children who have difficulties in the development of their speaking abilities, without being deaf usually have different kinds of additional problems. Primarily they have motor clumsiness (clumsiness in the performing of the movement, low coordination, changes in rhythm, impaired balance). They have difficulties in the fine and in the rough, global motor performance (Radovančić, 1987). The correlation between the ability of movement and the ability of speak is determined by the common anatomical-physiological basis: the connection of both branches of the pyramid motor root; the corticobulbar part, which governs motor control of speech, and the corticospinal part, which controls global motor activities as well as fine movements of the hands (Brestovci, 1979). The relations between speech disorders and motor skills are not studied enough, and the literature presents only data about the influence of speech disorders among the performance of certain motor tasks. Thirty years ago, the research of the relationship between rhythm of speech and basic motor skills begins. At that time, the assumption of a possible connection between speech and motor disorders was made. Further investigations were extended to other segments of the motor field, such as coordination, speed, balance, and even power (Brestovci, 1970). Brestovci in 1979 used a battery of motor tests to determine the rhythm, coordination and overall strength on a sample of 90 subjects with speech disorders (people who stutter and people with dislalya), aged 9-18 years. The investigation also included a healthy age matched control group. The conclusion of this study was that 60% of the subjects with speech disorders achieve poorer results in motor tests than subjects with normal speech capabilities. In 1985, Brestovci published a paper with clearly poorer results in the tapping hand test obtained by stuttering children, compared to age matched children who did not have such speech disorder. Furthermore, studies about the motor abilities of deaf children and adolescents are very rare, unsystematic and with inconsistent methodology (Bonetti, 2008). Children with hearing impairments have negative consequences in the motor field, in static and particularly dynamic balance, they are uncertain in the implementation of macro-and micro-rhythmic movement as well as in performing the pulling phase of the gait cycle (Fisher, Vhirter, 2001). Radovančić in 1976 conducted a research of some manifest motor skills on a sample of 102 deaf and 102 hearing males, aged 14.5 to 16.5 years. Based on the application of 43 motor tests and the application of canonical discriminative analysis he concluded that the motor abilities of the two groups were significantly

---

\* This research was supported, in part, by grant no. 034-0342610-2609 (Programming of transformational procedures for physical conditioning) from Croatian Ministry of science, education and sport.

different. In 1946 Myklebust tested the motor skills of deaf subjects with seven tests on a sample of 37 deaf girls and 51 males. The same battery of tests was applied to appropriate samples of hearing girls and boys. Deaf girls and boys achieved significantly lower scores on a balance test. The author has applied the test of walking on balance beam at the sample of deaf and hearing subjects aged 7-15 years. Subjects with deafness achieved poorer results regardless of their age. Myklebust has applied the tests to assess motor skills on 30 boys with deafness and 20 girls with deafness aged of 8-14 years. The results showed that deaf subjects were lagging behind in motor skills, compared to hearing subjects and the worst results were achieved in the tests measuring coordination and speed. Mauk and Mauk in 1998 applied a battery of test which measured balance and coordination. They studied 60 hearing subjects and 60 subjects with congenital deafness, 60 subjects with acquired deafness and 60 hearing subjects. The results showed that subjects with hearing impairments achieved poorer results in tests of balance and coordination compared to hearing subjects of the same age, but these differences were not significant. Stefanovic in 1961 conducted a research of some manifest motor dimensions on a sample of 40 subjects with deafness. Based on the obtained results the author concluded that deafness does not necessarily imply significant changes in the motor area. She applies a balancing test, a test to evaluate precision and the long jump from a steady position test on a sample of 40 subjects with deafness. She also included a control group of hearing subjects. The results showed that subjects with deafness achieved poorer results in the applied balance test, but they were better than the hearing controls in the tests that assessed precision and explosive strength. Motor skills in the children with hearing impairments and children with speech disorders have been very poorly explored and the obtained results are contradictory. The main goal of this research is to determine the differences in certain motor abilities between children with speech disorders and children with hearing impairment. For that purpose, children with speech disorders and children with hearing impairments of the Clinic "Suvag" were included in this study. Differences in motor skills between subjects with speech disorders and subjects with hearing impairment were tested with the Discriminative analysis. Since the purpose of the whole educational and rehabilitation system, in patients with speech disorders and people with hearing impairments is to achieve a complete social integration and involvement of those individuals, information about their motor abilities may be significant for assessing the likelihood of their success and further planning of different kind of activities. These findings may contribute to a better integration of persons with such disabilities in the community (Matijašević, 1965). These results will certainly provide better insight into the relationships within the dimensions of the motor field of the two groups and thus allow the setting up of specific hypotheses for further research.

## Methods

The study involved two groups of subjects aged 11-12 years (5th grade). All subjects were male children from the special primary school "Suvag" in Zagreb, Croatia. The first group was made of 44 subjects with speech disorder, while the 62 children with hearing impairment were included in the second group. The motor abilities of the subjects were tested with six motor tests previously proved to be reliable (Metikoš et al., 1989). The following tests were used to assess motor skills: hand tapping (MTR), long jump from a steady position (MSD), obstacle course backwards (MPN), sit-ups (MPT), bend forward (MPR), enduring suspended (MIV).

Basic statistical parameters such as mean, standard deviation, minimum and maximum score for a particular sample were calculated. T - tests was used to assess significant difference between subjects with speech disorders and subjects with hearing impairment in each variable separately. Multivariate differences between the groups in the measured variables were analyzed with the canonical discriminative analysis. The statistical significance of the discriminative function was tested with the Bartlett's  $\chi^2$  test. The coefficient of canonical discriminative analysis, the position of group centroids on the discriminative function and the correlation of variables with a discriminative function were estimated.

## Results

Basic statistical parameters as the arithmetic mean of each variable (x), the minimum score of each variable (minimum), maximum score of each variable (maximum) and standard deviation of each variable (Standard deviation) for subjects with speech disorder and subjects with hearing impairments were calculated.

All measures of central tendency and dispersions differ in all the motor variables among subjects with speech disorders and subjects with hearing impairment (Table 1 and 2). Arithmetic means show significant differences in favour of subjects with hearing impairments in all six motor variables.

The standard deviation for subjects with speech disorders are the lowest in the variable hand tapping. Performing this task requires a certain degree of hand motor skills and hand tapping is one of the most complex tasks for subjects with speech disorders because the two actions (speech and motor activity) are generated in the same part of the brain. In this case, one activity may reduce the ability to perform the other. In other variables, the relative standard deviation increases and reaches its maximum value in the variable long jump from a steady position (35.91). The greater differentiation among subjects with hearing impairments was obtained in the field of explosive strength (19.56), but still much lower than that between subjects with speech disorder. The smallest dispersion among subjects with hearing impairment is achieved in the variable obstacle course backward, followed by hand tapping, sit-ups, bend forward and enduring suspended variables.

The arithmetic means and standard deviations of the subjects with hearing impairments are slightly different from the average values obtained by an age matched healthy sample of Croatian students in the school year 1985/86. The poorest results and the biggest difference is in the variable enduring suspended. Subjects with hearing impairments also obtained poorer results in the variables bend forward and long jump from a steady position. The results in the variables hand tapping are similar, while subjects with hearing impairment achieved significantly better results in the variables sit-ups and obstacle course backward. If the same comparison is made between subjects with speech disorders and a control sample, we find that in all 6 motor variables, subjects with speech disorders achieves significantly lower results than the control peer.

Table 1. Descriptive statistics for the subjects with speech disorders

Variable	Arit. mean	Minimum	Maximum	Std.Dev.
MTR	19,30	12,00	29,00	4,29
MSD	118,18	40,00	190,00	35,91
MPN	23,60	10,00	66,80	10,70
MPT	24,23	5,00	41,00	8,71
MPR	37,52	20,00	62,00	9,55
MIV	14,12	2,00	40,70	11,41

Table 2. Descriptive statistics for the subjects with hearing impairment

Variable	Arit. mean	Minimum	Maximum	Std.Dev.
MTR	25,95	18,00	39,00	3,70
MSD	160,00	100,00	200,00	19,56
MPN	13,69	8,70	31,20	3,56
MPT	34,56	19,00	45,00	5,46
MPR	43,24	28,00	63,00	7,72
MIV	27,08	4,20	60,30	14,27

The results of series of univariate t-tests show that there is a statistically significant difference between subjects with speech disorders and subjects with hearing impairment at the level of significance of .01 in all six variables (Table 3)

Table 3. Differences between subjects with speech disorders and subjects with hearing impairment

Variable	Xn	*2	t-value	Df	P
MTR	19,30	25,95	-8,53	104,00	0,00
MSD	118,18	160,00	-7,71	104,00	0,00
MPN	23,60	13,69	6,79	104,00	0,00
MPT	24,23	34,56	-7,50	104,00	0,00
MPR	37,52	43,24	-3,41	104,00	0,00
MIV	14,12	27,08	-4,57	104,00	0,00

Table 4 and 5 shows the results of canonical discriminative analysis. Table 4 shows the results of the canonical discriminative analysis. The resulting canonical discriminative function significantly distinguished subjects with speech disorders from subjects with hearing impairment on the significance level of .01 ( $p < 0.01$ ), with a relatively high canonical correlation (0.71). It is therefore possible to conclude that the six motor variables distinguish subjects with speech disorders and subjects with a hearing impairment.

Table 4. The eigenvalue, the canonical correlation (RCI),  $\chi^2$  - test, degrees of freedom (df) and significance level (p) of the discriminative function

K	R	x	df	P
1,02	0,71	70,77	6,00	0,00

Table 5 shows the structure of the discriminative function and the position of the centroids of subjects with speech disorders and subjects with hearing impairment. The subjects with speech disorders are situated on the negative pole (G\_1: 1) of the discriminative function, while subjects with hearing impairments are situated on the positive pole (G\_2: 2). The structure of the discriminative function is unipolar, that is the variables are on the positive pole in all the evaluated six motor tests (in favor of subjects with hearing impairment). According to these results, the largest distinction between subjects with speech disorders and subjects with hearing impairment has been estimated in the motor test hand tapping (0.83), which is not surprising because according to previous studies it is really difficult for subjects with speech disorders to perform fine motor movements with their hands, like the ones that are acquired in the test hand tapping. Smaller differences are registered in the test long jump from a steady position (0.75), sit-ups (0.73), then obstacle course backward (0.66) and enduring suspended (0.43) which shows that subjects with speech disorder are considerably weaker in tests of strength and coordination than subjects with hearing impairment. The smallest, but still statistically significant difference is present in the bend forward test (0.33).

Table 5. Structure and location of group centroids on the discriminative function

	DF1
MTR	0,83
MSD	0,75
MPN	0,66
MPT	0,73
MPR	0,33
MIV	0,43
G_1:1	-1,18
G_2:2	0,84

## Discussion and conclusions

The main goal of this research was to determine the differences in certain motor abilities between children with speech disorders and children with hearing impairment. For that purpose, children with speech disorders and children with hearing impairments of the Clinic "Suvag" were included in this study. Analysis of differences between subjects with speech disorders and subjects with hearing impairments in six motor variables indicate the following:

- A series of univariate t-tests were obtained from the results that indicate a statistically significant difference between subjects with speech disorders and subjects with hearing impairment at the level of significance of .01 in all six variables.
- The canonical discriminative function significantly distinguished subjects with speech disorders and those with hearing impairment at the level of significance .01 ( $p < 0.01$ ), with relatively high canonical correlation (0.71).
- The largest distinction between subjects with speech disorders and subjects with hearing impairment has been estimated in the motor test hand tapping (0.83), in favour of the children with hearing impairment
- The smallest but still significant difference was present in the test bend forward (0.33).

The obtained results confirm that the ability to perform fine motor movements and speech is originated in a common anatomical-physiological base; the corticobulbar part of the brain which is responsible for speech and the corticospinal part which is responsible for human movement. These parts are components of the motor pyramid root. The variable that best discriminated subjects with speech disorders, and subjects with hearing impairment is the hand tapping test. This result can be explained by the fact that speech and motor functions have the same centre in the brain from which such activities begins (speech, movement). As the speech is a primary human activity, motor activities are usually suppressed during rehabilitative processes. The results of this study emphasize the need to include motor activities, especially fine motor movements of the hand in the regular educational and rehabilitation processes of people with speech disorders.

## References

1. Bonetti, L. (2008). Prediktori razumljivosti govora osoba s oštećenjem sluha, doktorska disertacija, Edukacijsko-rehabilitacijski fakultet Sveučilišta u Zagrebu.
2. Brestovci, B. (1979). Neke relacije između mucanja, motorike i anksioznosti. Doktorska disertacija, Fakultet za defektologiju Sveučilišta u Zagrebu.
3. Brestovci, B. (1970). Definicija mucanja, Defektologija, 6,17-23.
4. Brestovci, B. (1985). Multidimenzionalni pristup etiologiji mucanja mucanja, Defektologija, 21,1, 51-70.
5. Fisher, Whirter. (2001). The deaf identity development scale. Journal of Counseling Psychology, 48,355-358.
6. Matijašević, P. (1965). Metodika školskog rada s gluhom djecom, Beograd: Udruženje defektologa Jugoslavije.
7. Mauk, G., W., Mauk, P.P. (1998). Consideration, conceptualizations, and challenges in the study of concomitant learning disabilities among children and adolescent who are deaf and hard of hearing, Journal of Deaf Studies and Deaf Education, 3, 15-33.
8. Metikoš, D., Hofman, E., Prot. F., Pintar, Ž., Oreb. G. (1989). Mjerenje bazičnih motoričkih dimenzija sportaša. Zagreb, Fakultet za Fizičku kulturu, Sveučilišta u Zagrebu.
9. Myklebust, H.R. (1946). Significance of etiology in motor performance of deaf children with special reference to mrningitis, American Journal of Psychology, 59:2499.
10. Radovančić. B., (1987). Komparativna analiza nekih latentnih antropometrijskih i motoričkih dimenzija u gluhe omladine i omladine koja čuje, doktorska disertacija, Fakultet za defektologiju Sveučilišta u Zagrebu.
11. Radovančić, B. (1976). Razlike između gluhih učenika i učenika koji čuju na osnovi nekih manifestnih motoričkih karakteristika, Defektologija, Vol.12.1-2, 32-43.
12. Stefanović, S. (1961). Potreba i važnost fizičkog vaspitanja gluvih, Beograd SGJ.

## RESEARCH ON SPORT ACTIVITY AT PERSONS WITH DISABILITY IN CROATIA

Lidija Petrinović Zekan, Dubravka Ciliga and Drena Trkulja-Petković

*Faculty of Kinesiology, University of Zagreb, Croatia*

### Abstract

Scientific knowledge gathered in the last few decades accentuates the importance of regular physical activity. There are more and more studies concerning the importance of physical activity in population with various disabilities. This research concentrates on a persons with disability who use wheelchair in everyday life. The complete sample consisted of 230 subjects (25.22% females and 74.78% males). The mean age of subjects was 44.6 years. The subjects were included through method of random choice. The data was gathered using the questionnaire which was distributed among persons with disability. The statistical methods used were ANOVA. The level of physical activity decreases after the onset of physical disability. Persons who engaged in sports intensely before disability will more frequently resume this practice. The most common reason for withdrawal from the sports is restrictive features of disability. In female population, a decrease of physical activity after the disability was shown, and also proven to be statistically significant.

**Key words:** *persons with disability, physical activity, sport, wheelchair, kinesitherapy*

### Introduction

According to the UN Convention on people with disabilities, people with disabilities include those who have permanent physical, mental, intellectual or sensory impairments which in interaction with various barriers may hinder their full and effective participation in society on an equal basis with others. In the total population of each country is estimated that there are about 10% of people with disabilities, of which only 2% engaged in various sporting activities (data relating to countries with a high standard). Testing was conducted in the Croatian and Slovenian indicates that only 0.02% of the listed population of persons with disabilities engaged in sports activities (Ciliga, 2000). Kinesiology activities are important for physical and mental health and psychosocial development of each individual. The movement is recognized in every human spontaneous daily activity and sport and recreation are now part of the life of every man. Sport and recreation restore confidence to people with disabilities and allows them to enjoy the game and the competition that they had before the injury or damage (Ciliga, 2000). After appropriate medical treatment, medical rehabilitation, the injured persons are considered to be healthy persons with physical disabilities as a consequence. After the primary medical care, must be approached complex rehabilitation that from the outset, with mandatory rehabilitation treatment, including psychosocial and vocational rehabilitation (Drewes, 1989). People with physical disabilities, their first knowledge of the recreational and competitive sport is acquire at secondary rehabilitation, the rehabilitation activities under the name of "reha sport", which are a mandatory part of everyday activities. Through the "Reha-sport" they acquire knowledge about their disability, the remaining motor skills important in kinesiology activities, knowledge about the use of specific recreational prostheses and wheelchairs, necessary to carry out sports activities. After secondary rehabilitation, persons with disabilities can choose between recreational activity and competitive sport (Frieden, 1985; Fuhrer, 1994). Low levels of physical activity among people with disabilities can reduce their aerobic capacity, muscular strength, endurance and flexibility, and above all has the potential to limit the functional independence of persons, which increases the risk of chronic disease and secondary complications (Washburn, 2002; Williams, 1997). The positive physiological effects of physical activity in persons with disabilities are similar to those in the standard population and consist in improving the overall cardiovascular status, reduction of risk factors for coronary vascular disease (Perić, 2004). Regular physical activity for people with disabilities can have a significant sociological gains, such as making new friends, share experiences, develop support networks and reducing the sense of "handicap" (Manns&Chadd, 1999; Monnazzi, 1982; Shephard, 1991). Another positive aspect of regular physical activity for people with disabilities is an increased sense of physical self-sufficiency through improved mobility in wheelchair (Heath, 1997; Noreau, 1995). Sport for people with disabilities today is not only within the rehabilitation therapy. It is the means by which individuals can maintain a high level of physical fitness. Sport is also a motivational force that helps people with disabilities to express their maximum potential. Specific effects of sports for people in wheelchairs, which are of very great importance and is reflected in the improved performance of daily activities can be seen in increasing the power of the upper extremities, increase range of motion in the hip, prevent contractures, improve circulation, increase vital capacity, prevention of urinary bladder (taking large amounts of fluids during activity), improving kidney function, increase mobility and stability in the wheelchair to prevent pressure ulcers.

## Methods

The sample consists of people with physical disabilities who in their daily life using a wheelchair. The sample size was 230 people, 172 men and 57 women. The average age was 44.2 years (age range for women was 22-69 and men 17-67 years). Filling questionnaire executed in cooperation with the Zagreb Sports Federation of Disabled Persons, the Croatian Sports Federation of Disabled Persons and the Croatian Association of Paraplegics and quadriplegics. Data from these individuals were collected so that people who meet the criteria for inclusion in the study (that are persons with physical disabilities and is in a wheelchair) asked to complete a questionnaire. Data analysis was carried out at the program STATISTICA (data analysis software system), version 7.1., StatSoft, Inc. (2005). With the Kolgomorov Smirnovljevog-test are tested the normality of distribution in order to apply them to appropriate parametric statistical methods such as student's t-test.

## Results and discussion

The most common single cause of disability in the subjects was an accident for which the with disability remained nearly two-fifths of people (37.83%) (Table 1). The questionnaire did not specify a category of disability caused by injuries in the civil war, these respondents probably distributed between the categories of "violent events" and "other causes" thereby explaining the higher percentage of men in these categories. Differences between women and men are statistically significant ( $p(\chi^2) = 0.031$ ), and the biggest difference was observed in the proportion of people whose disability occurred as a result of disease. This group includes almost a third of women (32.76%), but only about one tenth of men (10.47%), while in other groups, the gender difference less pronounced. The reason for this difference is a higher incidence of some diseases that can lead to disability just for women. Examples include multiple sclerosis, which is more common in females 2:1 and some systemic diseases with a rack of connective tissue (eg rheumatoid arthritis 2-3:1) (Branholm, 1994).

Table 1. Causes of disability

	Women		Men		All	
	N	%	N	%	N	%
Accident	20	34,48	67	38,95	87	37,83
Fall from a height	9	15,52	33	19,19	42	18,26
Else	7	12,07	32	18,60	39	16,96
Disease	19	32,76	18	10,47	37	16,09
Violent event	3	5,17	17	9,88	20	8,70
Sports injuries	0	0,00	5	2,91	5	2,17
<b>Total</b>	<b>58</b>	<b>100,00</b>	<b>172</b>	<b>100,00</b>	<b>230</b>	<b>100,00</b>

Table 2. The mean age of subjects by the causes of disability

	Sr.	N	SD
Accident	41,1	86	10,7
Sports injuries	41,4	5	16,6
Fall from a height	42,9	42	12,4
Else	46,8	39	11,7
Disease	47,9	37	14,5
Violent event	48,9	20	8,7

Looking at middle age subjects with regard to the manner of disability, it is evident that some groups on average younger than the others (Table 2.). Thus, persons who become disabled due to an accident on average the youngest with a mean age of 41.1 years, while the oldest ones in which people become disabled due to a violent event. Analysis of differences in middle age suggests that these differences are statistically significant ( $p(\text{ANOVA}) = 0.012$ ). In order to examine exactly where the differences are caused by the statistical significance of ANOVA test, post-hoc analysis is using LSD (Least to English significant Difference). The results are shown in the table below (Table 3.). Subjects with disabilities emerged consequently accident, on average, were significantly younger than those whose disability is caused by the violent event, illness or other reasons. Among other groups there are find no statistically significant difference.

Table 3. The mean age of subjects – post hoc analysis

	Accident	Fall form a height	Sports injuries	Violet event	Disease	Else
Accident	-	0,433	0,960	0,009	0,004	0,014
Fall from a height	0,433	-	0,792	0,065	0,062	0,142
Sports injuries	0,960	0,792	-	0,210	0,252	0,341
Violent event	0,009	0,065	0,210	-	0,771	0,524
Disease	0,004	0,062	0,252	0,771	-	0,680
Else	0,014	0,142	0,341	0,524	0,680	-

The above-mentioned age of onset of disability is shown in Table 4. It is evident that the disability for a few people emerged before the 12th age (8.70%), and after 50 years of age (4.78%). Disability is the largest number of individuals occurred between 18 and 30 age (32.61%). Gender differences were not statistically significant ( $p(\text{MW}) = 0.503$ ).

Table 4. Age of onset of disability

	Women		Men		All	
	N	%	N	%	N	%
From birth	2	3,45	2	1,16	4	1,74
To 12 year	7	12,07	9	5,23	16	6,96
12-18 y	13	22,41	45	26,16	58	25,22
18-30 y	17	29,31	58	33,72	75	32,61
31-40 y	9	15,52	35	20,35	44	19,13
41-50 y	8	13,79	14	8,14	22	9,57
More then 50 years	2	3,45	9	5,23	11	4,78
<b>Total</b>	<b>58</b>	<b>100,00</b>	<b>172</b>	<b>100,00</b>	<b>230</b>	<b>100,00</b>

Before the occurrence of disability, only a minority of about one tenth subjects (10.62%) participated in sports in the form of regular training, and this proportion has not changed, nor the occurrence of disability (Table 5.). Differences between men and women in this category were statistically significant ( $p$  (MW) <0.001). Thus, two thirds of women did not engage in any regular physical activity and the activity was of low intensity, compared with just over half the men (53.54%).

Table 5. Sport and regular physical activity: Prior to disability

	Women		Men		All	
	N	%	N	%	N	%
Inactive	19	33,93	23	13,53	42	18,58
Low level of activity	23	41,07	56	32,94	79	34,96
High levels of activity	12	21,43	69	40,59	81	35,84
Regular training	2	3,57	22	12,94	24	10,62
<b>Total</b>	<b>56</b>	<b>100,00</b>	<b>170</b>	<b>100,00</b>	<b>226</b>	<b>100,00</b>

Upon occurrence of disability (Table 6.), the proportion of people who have high levels of physical activity or exercise on a regular basis remains very similar, but there is a redistribution of the two “lower” groups by level of physical activity.

Table 6. Sport and regular physical activity: After the occurrence of disability

	Women		Men		All	
	N	%	N	%	N	%
Inactive	25	43,10	47	27,98	72	31,86
Low level of activity	16	27,59	42	25,00	58	25,66
High levels of activity	9	15,52	63	37,50	72	31,86
Regular training	8	13,79	16	9,52	24	10,62
<b>Total</b>	<b>58</b>	<b>100,00</b>	<b>168</b>	<b>100,00</b>	<b>226</b>	<b>100,00</b>

Prior described the differences were statistically significant ( $p$  (WMP) = 0.020), so it can be concluded that there is a statistically significant decrease in levels of physical activity for people whose disability arises. In the rehabilitation is becoming increasingly significant correlation between the level of physical activity before and after the occurrence of disability (Reid, 1998 Sherrill, 1996). These findings provide the professional staff (physiotherapists, kinesiologists) to create individually tailored program of sports and physical activities. Through such programs, people with disabilities will still gain during the rehabilitation of basic knowledge and develop motor skills they will need in starting, driving a wheelchair later in everyday life (Kirby, 1996; Williams, 1994).



Table 7. Engaging in the same sport after the occurrence of disability

	Women		Men		All	
	N	%	N	%	N	%
Yes	5	12,20	32	20,92	37	19,07
No, because of disability	19	46,34	97	63,40	116	59,79
No, due to lack of opportunities	17	41,46	24	15,69	41	21,13
<b>Total</b>	<b>41</b>	<b>100,00</b>	<b>153</b>	<b>100,00</b>	<b>194</b>	<b>100,00</b>

Only a small proportion of subjects (19.07%) continued to do the same sport after the occurrence of disability, while the majority of giving up the sport was just prior disability (59.79%), and to a smaller number of cases (21.13%) lack opportunities to pursue sports (Table 7.). Gender differences were statistically significant ( $p(\chi^2) = 0.015$ ), with a significantly smaller proportion of women in the group that continued to engage in sports and greater share of the remaining two groups.

Table 8. The sport / regular physical activity for people with disabilities introduced by:

	Women		Men		All	
	N	%	N	%	N	%
Friend	3	9,68	42	35,00	45	29,80
Physio / doctor	18	58,06	24	20,00	42	27,81
Else	6	19,35	17	14,17	23	15,23
Accidentally	4	12,90	18	15,00	22	14,57
Teacher	0	0,00	10	8,33	10	6,62
Someone in a close family	0	0,00	9	7,50	9	5,96
<b>Total</b>	<b>31</b>	<b>100,00</b>	<b>120</b>	<b>100,00</b>	<b>151</b>	<b>100,00</b>

Part of the respondents, slightly less than 30% reported that they have been in sports for persons with disabilities introduced by a friend or doctor / physiotherapist (Table 8.). It is in these groups is the biggest difference between women and men. So women have the largest percentage accepted the advice of a doctor or physical therapist, a male from a friend. Differences between the sexes in this category were statistically significant ( $p(\chi^2) = 0.003$ ). People with disabilities are much easier to identify with people with similar problems, or accept the suggestion to follow their example, but it would have made in relation to healthy individuals (Williams, 1994). For the following two categories of "reasons and difficulties in the practice of sport" - does not consider the respondents, rather than categories. Namely, that each participant had the opportunity to give more than one answer to this question, so were summarized and analyzed all the answers, not subjects. The largest number of respondents, nearly a quarter (26.48%) are engaged in sports in order to maintain better physical condition, and a similar percentage (23.34%) are involved in sports for pleasure in the sport (Table 9.). In these categories there are substantial differences between women and men in the sense that more women in sports in order to retain better physical condition, and more men are involved in sports for the sheer enjoyment of the sport. Differences between sexes were statistically significant ( $p(\chi^2) = 0.014$ ).

Table 9. Reasons for sports

	Women		Men		All	
	N	%	N	%	N	%
Keep a better physical condition	20	38,46	56	23,83	76	26,48
Enjoyment of the sport	6	11,54	61	25,96	67	23,34
To improve physical strength	7	13,46	32	13,62	39	13,59
Go out into society and meet new people	1	1,92	25	10,64	26	9,06
I love competition	3	5,77	18	7,66	21	7,32
To improve confidence	6	11,54	14	5,96	20	6,97
Possibility to travel	2	3,85	12	5,11	14	4,88
Something else	3	5,77	2	0,85	5	1,74
The possibility of better maintenance of body weight	4	7,69	15	6,38	19	6,62
<b>Total</b>	<b>52</b>	<b>100,00</b>	<b>235</b>	<b>100,00</b>	<b>287</b>	<b>100,00</b>

A similar situation is also the category of difficulty in playing sports, and the differences between women and men were again statistically significant ( $p(\chi^2) = 0.024$ ). In doing so, significantly more men (29.57%) cited as the difficulty of the lack of appropriate facilities, a much higher proportion of women, sees the accumulated business liabilities (17.07% compared to 4.84%) (Table 10.). In people with disabilities who are in a wheelchair part of the activity was reduced due to various difficulties they encounter in everyday life, from architectural barriers in access to public facilities and recreational space, and not adapted to the specifics of transport to the sports facilities.

Table 10. The difficulty of playing sports

	Women		Men		All	
	N	%	N	%	N	%
Lack of adapted sports facilities	4	9,76	55	29,57	59	25,99
Problems with transportation to sports facilities	8	19,51	32	17,20	40	17,62
Lack of money	4	9,76	32	17,20	36	15,86
Something else	8	19,51	19	10,22	27	11,89
Lack of independence in dealing with everyday activities	5	12,20	19	10,22	24	10,57
Lack of time due to business obligation	7	17,07	9	4,84	16	7,05
Lack of opportunities to practice their major sports	3	7,32	11	5,91	14	6,17
I do not like "traditional" sports for people with disabilities	2	4,88	9	4,84	11	4,85
<b>Total</b>	<b>41</b>	<b>100,00</b>	<b>186</b>	<b>100,00</b>	<b>227</b>	<b>100,00</b>

## Conclusion

As in many prior studies cited here demonstrated that the level of physical activity decreases after the occurrence of disability. However it was found that persons who were previously involved in sports more intensively after the occurrence of disabilities are included in sporting activities. The most common reason for withdrawal from the sport are just features of disability related to limiting factors, then the unavailability or lack of sports facilities and difficulties with transportation to sporting facilities. The most common reason for women's sports to maintain better physical condition, and is accompanied by a desire to improve their physical strength. In men it is a pleasure in the sport and maintains better physical condition. People are often introduced people with disabilities in sport are a doctor or physiotherapist in women and one from a friend in men. There remains a great place to work for a kinesiologists in rehabilitation centers where persons with disabilities should receive the first information about the possibilities for sport activities after the injury. It is about information ranging from basic knowledge about different sports, the possibility that the person they deal with upon returning to their environment, to specific contact information professionals (coaches). The importance of physical activity has been proven in numerous studies as the standard population and the population of persons with disabilities. Strategy development and improvement program for the better and more effective integration of people with disabilities in various forms of physical activity to the level of regular practicing sports and recreation, professional sports requires further research. One of the most important guidelines for further work with people with disabilities to improve levels of physical activity is involved in the local community through various activities and recreational character or sports training. The level of light physical activity will be also achieved and solving with the better accessibility of public buildings for people in wheelchairs.

## References

1. Branholm, I.B., Erhardsson, M. (1994). On life satisfaction and activity preferences in subjects with multiple sclerosis: a comparative study. *Scandinavian journal of Occupational therapy*, 1, 17-23.
2. Ciliga, D. (2000). Povezanost motoričkih sposobnosti s ocjenom funkcionalne klasifikacije u košarci u invalidskim kolicima, *Hrvatsko športsko medicinski vijesnik*, 15(1-2).
3. Drewes, A.M., Olsson, A.T., Slot, O., & Andreasen, A. (1989). Rehabilitation outcome for patients with spinal cord injury. *Int Disabil Stud*, 11(4), 178-180.
4. Frieden, L., & Cole, J.A. (1985). Independence: the ultimate goal of rehabilitation for spinal cord-injured persons. *Am J Occup Ther*, 39(11), 734-739.
5. Fuhrer, M.J. (1994). Subjective well-being: implications for medical rehabilitation outcomes and models of disablement. *Am J Phys Med Rehabil*, 73(5), 358-364.
6. Heath, G.W., Fentem, P.H. (1997). Physical activity among persons with disabilities-a public health perspective. *Exerc Sport Sci Rev*, 25, 195-234.
7. Kirby, R.J., Cull, J., Foreman, P. (1996). Association of pre-lesion sport participation and involvement in wheelchair sports following spinal cord injury. *Percept. Mot skills*, 82, 481-482.

8. Manns, P.J., & Chad, K.E. (1999). Determining the relation between quality of life, handicap, fitness, and physical activity for persons with spinal cord injury. *Arch Phys Med Rehabil*, 80(12), 1566-1571.
9. Monnazzi, G. (1982). Paraplegics and sport: A psychological survey. *International Journal of Sport Psychology*, 13, 85-95.
10. Noreau, L., & Shephard, R.J. (1995). Spinal cord injury, exercise and quality of life. *Sports Med*, 20(4), 226-250.
11. Perić, P. (2004). *Rehabilitacijska medicina*. U: Božidar Ćurković, ur: *Fizikalna i rehabilitacijska medicina*. Udžbenik. Zagreb: Medicinska naklada, 157.
12. Reid, G., Prupas, A. (1998). A documentary analysis of research priorities in disability sport. *Adapted Phys. Activity Q*, 15, 168-178.
13. Shepard, R.J. (1991). Benefits of sport and physical-activity for the disabled-implications for the individual and for society. *Scandinavian Journal of Rehabilitation Medicine*, 23(2), 51-59.
14. Sherrill, C., Williams, T. (1996). Disability and sport: psychosocial perspectives on inclusion, integration, and participation. *Sport Sci Rev*, 5, 42-64.
15. Washburn, R.A., Zhu, W., McAuley, E., Frogley, M., Figoni, S.F. (2002). The physical activity scale for individuals with physical disabilities: development and evaluation. *Arch Phys Med Rehabil*, 83(2), 193-200.
16. Williams, T., England, M. (1997). Sociology, physical activity and spinal cord injury rehabilitation. *Topics in Spinal Cord Injury Rehabilitation*, 3(1), 56-66.
17. Williams, T. Taylor, D. (1994). Socialization, subculture and wheelchair sport: the influence of peers in wheelchair racing. *Adapted Physical Activity Q*, 11, 416-428.

## EXAMINING CULTURAL DIFFERENCES IN PHYSICAL ACTIVITY AMONG PEOPLE WITH SCHIZOPHRENIA

Bryan P. McCormick<sup>1</sup>, Gretchen Snethen<sup>2</sup> and Rachel L. Smith<sup>1</sup>

<sup>1</sup>Indiana University, Bloomington, IN USA

<sup>2</sup>Temple University, Philadelphia, PA USA

### Abstract

The lives of people with schizophrenia are characterized as unhealthy with physical inactivity and obesity as key contributors. It is unclear if poor physical health correlates of schizophrenia are determined by cultural factors. The purpose of this study was to identify if physical activity (PA) was culturally influenced among people with schizophrenia. Subjects with schizophrenia spectrum disorders were recruited from ambulatory psychiatric services in the USA and Serbia. PA data were collected using accelerometry for 7 days. The Serbian sample was significantly less sedentary than the US sample, but did not differ on levels of MVPA. Less than half of both groups met minimum MVPA requirements. Increasingly health researchers are distinguishing between the effects of physical activity as well as sedentary behavior on health outcomes. Future treatment recommendations should include decreasing sedentary behavior, in addition to increasing PA as outcomes for people with schizophrenia.

**Key words:** *Sedentary Activity, Accelerometry, MVPA*

### Introduction

Studies have documented the poor physical health conditions associated with severe mental (SMI) illnesses such as schizophrenia. A recent review of the impact of cardiovascular disease (CVD) among patients with SMI in the United States, claimed the life expectancy of those with SMI, including those diagnosed with schizophrenia, was reduced by 25 years as compared to adults without SMI (Newcomer & Hennekens, 2007). Among the modifiable health risk factors for people with schizophrenia, physical inactivity and obesity are noted (Wildgust & Beary, 2010). Physical activity (PA) has received significant attention as a key ingredient in combating health threats such as CVD and current recommendations are that individuals accrue at least 150 minutes of moderate to vigorous activity per week and greater benefit is achieved if MVPA occurs in a minimum of 10-minute bouts occurring on five or more days per week (O'Donovan, et al., 2010). It is believed that people with schizophrenia are not meeting this guideline and are more sedentary than those without disabilities (Faulkner & Biddle, 1999; Hamer, 2008), but there is little research to support this supposition (Department of Health and Human Services [USDHHS], 2000).

At the same time, there is increasing recognition that sedentary behavior appears to represent a health threat, independent of PA levels (Owen, Healy, Matthews, & Dunstan, 2010). Sedentary behaviors are those behaviors typically requiring the expenditure of less than 1.0-1.5 METs. Principal among sedentary behaviors is time spent sitting, whether watching television, working at a computer or sitting in automobiles. Owen et al. contended that sedentary behavior represents a unique set of behaviors, not simply the absence of MVPA, which have unique health consequences.

Although schizophrenia and its treatment may impact the health and activity of those diagnosed, there is reason to believe that social and environmental determinants may affect health behavior (CSDH, 2008). Bhugra (2006) reiterated findings of previous work, highlighting differential outcomes in severe mental illnesses, particularly schizophrenia, across cultures due to differences in both social attitudes and services. Given the findings that outcomes in mental disorders such as schizophrenia appear to have different illness trajectories across different cultures (Hopper & Wanderling, 2000), health determinants may vary as well. The purpose of this study was to determine if everyday PA, identified as levels of moderate to vigorous physical activity (MVPA) and sedentary activity, was culturally influenced among people with schizophrenia.

### Methods

Subjects with a diagnosis within the schizophrenia spectrum (schizophrenia, schizoaffective, schizotypal) were recruited from ambulatory psychiatric services in the USA (n=45) and Serbia (n=32). PA was collected using a GT1M uniaxial accelerometer (Actigraph) during waking hours for 7 consecutive days. Data were collected in 1-minute epochs and analyzed for time spent in various intensity levels using lifestyle activity cut-points established by Swartz et al. (2000). Only subjects with a minimum of 8 hours of data per day for at least 4 days were included in the analysis, resulting in a final study sample of 30 participants from the USA and 24 from Serbia (total n = 54).

Examination of the data indicated no missing values, and the range, mean, and standard deviations were reasonable. However, both minutes of MVPA and sedentary PA were non-normally distributed, so a logarithm transformation was used to normalize the data. ANOVA models were created to examine differences in both sedentary and MVPA was culturally influenced among people with schizophrenia. MVPA was examined by both total minutes and by days where 10-minute bouts of MVPA occurred. Due to difference in gender composition of the samples, gender was entered as a factor in both the sedentary and MVPA models.

## Results

Of the US sample ninety percent were male ( $n = 27$ ) and 10% were female ( $n=3$ ). The Serbian sample was 45% male ( $n=11$ ) and 54% female ( $n = 13$ ). Mean minutes of MVPA for both groups were just in excess of the recommended minimum of 150 minutes per week (Table 1). At the same time, the large standard deviations for both samples indicated that group means were affected by a positive skew. In contrast, group means for sedentary PA indicated that the US sample reported approximately twice as many minutes in sedentary behavior as the Serbian sample. In both groups, just under half of the participants met the recommended 150 minutes of MVPA per week: 14 (46.7%) of the US sample and 10 (41.7%) of the Serbian sample. Additionally, the Serbian sample averaged 3.58 days with a minimum of one 10-minute bout of MVPA, whereas the US sample averaged 1.49 days.

Table 1.

PA by Group			
	MVPA Minutes	n Meeting Recommended MVPA minutes (%)	Sedentary Minutes
Serbian	175.67 (sd=155.93)	10 (41.7%)	746.08 (sd=202.05)
USA	171.23 (sd=142.73)	14 (46.7%)	1450.80 (sd=498.24)

Multivariate analyses, controlling for differences in the sample in terms of gender, indicated that the groups were no different in terms of total minutes of MVPA ( $F = 1.44$ ;  $p = .25$ ), see Table 2.

Table 2.

MVPA ANOVA					
	SS	df	Mean Square	F	p
Corrected Model	.53	2	.27	1.44	.25
Intercept	25.59	1	25.59	138.28	<.001
Gender	.47	1	.47	2.52	.12
Country	.31	1	.31	1.68	.20
Error	9.42	51	.185		
Corrected Total	9.96	53			

While no differences were found in total minutes of MVPA, the Serbian sample had significantly more days where 10-minute bouts of MVPA occurred ( $F = 5.95$ ;  $p < .01$ ), with gender as an unrelated factor, see Table 3.

Table 3.

10-minute Bout MVPA ANOVA					
	SS	df	Mean Square	F	p
Corrected Model	67.11	2	33.56	5.95	<.01
Intercept	334.77	1	334.77	59.40	<.001
Gender	.64	1	.64	.11	.738
Country	45.28	1	45.28	8.034	<.01
Error	349.44	62	5.64		
Corrected Total	416.55	64			

In contrast, the US sample reported significantly more minutes of sedentary behavior than the Serbian sample ( $F = 29.88; p < .001$ ), see Table 4. Again, gender was unrelated to total minutes of sedentary behavior.

Table 4.

Sedentary ANOVA					
	SS	df	Mean Square	F	p
Corrected Model	1.07	2	.54	29.88	<.001
Intercept	40.13	1	40.13	2231.94	<.001
Gender	.003	1	.003	.172	.680
Country	.87	1	.87	48.56	<.001
Error	.92	51	.02		
Corrected Total	1.99	53			

## Discussion

The results of this study provide further evidence of the physically unhealthy lifestyle of people with schizophrenia spectrum disorders (SSD). The results indicate that a majority of subjects in this study, regardless of cultural group failed to meet the recommended weekly minutes and daily bout recommendations of MVPA for health benefit. At the same time, measured MVPA of general samples of adults have also found that the majority of adults do not meet guidelines for MVPA (Tucker, Welk, & Beyler, 2011). These findings reinforce the need for PA interventions to be a consideration in rehabilitation programs for people with SSD.

Although the two cultural groups were not significantly different in time spent in MVPA, there were significant differences in the number of days where 10-minute bouts of MVPA occurred and the amount of time spent in sedentary behavior. The differences between total minutes of sedentary behavior and MVPA appear to reinforce that sedentary behavior may be relatively independent of MVPA. In addition, increased levels of sedentary activity also have an impact on overall health (Healy, et al., 2008). Owen et al. (2010) contended that most of adults' PA is light PA associated with everyday activity. In the present samples, the role of light PA in avoiding sedentary behavior may be a culturally distinguishing factor. Historically, light PA has been of little interest in research on PA and health benefits. In the present study, there is reason to believe that light PA may have health benefits in its ability to replace sedentary behavior, thus reducing the health threats of such behavior. These findings indicate that at least in some populations, sedentary behavior may also be a target of overall rehabilitation efforts. Reducing sedentary behavior through increasing light PA may have greater potential for success. In fact, targeting light PA may be an important intermediary step in increasing MVPA, as an initial increase in MVPA in predominantly sedentary individuals with SSD have difficulty incorporating lifestyle MVPA (Johnstone, Nicol, Donaghy, & Lawrie, 2009).

The data in this study do not provide information about the types of activities subjects participated in; however, there appears to be culturally based lifestyle differences that contribute to differences in levels of sedentary activity as well as the concentrated duration of MVPA, but not total time spent in MVPA. The role of culture in affecting lifestyle activities and everyday PA remains an appropriate area for investigation in the course and outcomes of SSDs.

Finally, a number of limitations should be considered in understanding the findings of this study. First, although the two subject groups were comparable by diagnosis, symptomatic comparisons were not known. It is possible that level of functioning, as implicated by psychiatric symptoms, could have systematically varied between the groups. In addition, PA data were collected at different times for the two groups. There is some evidence to indicate that seasonality may affect PA and thus could have been a contributing factor in group differences.

## References

1. Bhugra, D. (2006). Severe mental illness across cultures. *Acta Psychiatrica Scandinavica. Supplementum* (429), 17-23.
2. CSDH. (2008). *Closing the gap in a generation: health equity through action on the social determinants of health. Final Report of the Commission on Social Determinants of Health*. Geneva: World Health Organization.
3. Department of Health and Human Services [USDHHS]. (2000). *Health people 2010: Understanding and improving health*. Washington, DC: U.S. Government Printing Office.
4. Faulkner, G., & Biddle, S. (1999). Exercise as an adjunct treatment for schizophrenia: A review of the literature. *J Ment Health*, 8(5), 441-457.
5. Hamer, M. (2008). Physical inactivity: a real issue in mental illness. *Sport & Exercise Scientist* (15), 12-13.
6. Healy, G.N., Wijndaele, K., Dunstan, D.W., Shaw, J.E., Salmon, J., Zimmet, P.Z., et al. (2008). Objectively Measured Sedentary Time, Physical Activity, and Metabolic Risk. *Diabetes care*, 31(2), 369-371.

7. Hopper, K., & Wanderling, J. (2000). Revisiting the developed versus developing country distinction in course and outcome in schizophrenia: results from ISoS, the WHO collaborative followup project. *International Study of Schizophrenia. Schizophrenia Bulletin*, 26(4), 835-846.
8. Johnstone, R., Nicol, K., Donaghy, M., & Lawrie, S. (2009). Barriers to uptake of physical activity in community-based patients with schizophrenia. *Journal of Mental Health*, 18(6), 523-532.
9. Newcomer, J.W., & Hennekens, C.H. (2007). Severe mental illness and risk of cardiovascular disease. *Jama-Journal of the American Medical Association*, 298(15), 1794-1796.
10. O'Donovan, G., Blazeovich, A.J., Boreham, C., Cooper, A.R., Crank, H., Ekelund, U., et al. (2010). The ABC of Physical Activity for Health: A consensus statement from the British Association of Sport and Exercise Sciences. *Journal of Sports Sciences*, 28(6), 573-591.
11. Owen, N., Healy, G.N., Matthews, C.E., & Dunstan, D.W. (2010). Too Much Sitting: The Population Health Science of Sedentary Behavior. *Exercise and Sport Sciences Reviews*, 38(3), 105-113.
12. Swartz, A.M., Strath, S.J., Bassett, D.R., Jr., O'Brien, W.L., King, G.A., & Ainsworth, B.E. (2000). Estimation of energy expenditure using CSA accelerometers at hip and wrist sites. *Med Sci Sports Exerc*, 32(Suppl.), 450-456.
13. Tucker, J.M., Welk, G.J., & Beyler, N.K. (2011). Physical Activity in US Adults Compliance with the Physical Activity Guidelines for Americans. [Article]. *American Journal of Preventive Medicine*, 40(4), 454-461.
14. Wildgust, H.J., & Beary, M. (2010). Are there modifiable risk factors which will reduce the excess mortality in schizophrenia? *Journal of Psychopharmacology*, 24(11), 37-50.

## DIFFERENCES IN THE SIZE OF UNILATERAL ISOKINETIC EFFECTS IN REGARD TO ANGULAR SPEED OF TRAINING\*

**Asim Bradić<sup>1</sup>, Erol Kovačević<sup>2</sup> and Josipa Bradić<sup>3</sup>**

<sup>1</sup>*Department for Coach Education, Faculty of Kinesiology, University of Zagreb, Croatia*

<sup>2</sup>*Faculty of Sport and Physical Education, Sarajevo, Bosnia and Herzegovina*

<sup>3</sup>*Faculty of Kinesiology, University of Zagreb, Croatia*

### Abstract

This study aims to define existence of differences in the size of effects of development of peak torque of knee extensor and flexor of a dominant leg between two groups which implemented isokinetic training with different angular speed. 45 female students were divided into three groups, two experimental and one control group. Maximum strength of dynamic knee stabilizers was tested on an isokinetic apparatus (Biodex 3) with angular speed of 60°/s and 180°/s. The first group conducted an additional isokinetic training of a dominant leg with angular speed of 60°/s, while the second group conducted the same training with angular speed of 180°/s in the period of four weeks. Obtained results lead to the conclusion that a concentric isokinetic training with angular speed of 60°/s produced greater effects (absolutely and relatively expressed) on development of maximum strength of dynamic knee stabilizers than an isokinetic training conducted with angular speed of 180°/s in testing with both angular speeds.

**Key words:** *training, strength, dominant leg, dynamic knee stabilizers*

### Introduction

In scientific literature Isokinetics is first mentioned as a diagnostic method and only later as an individual or additional training method for development of strength. Thistle et al. (1967) introduced the concept of isokinetic exercises into the scientific literature and defined that isokinetic resistance had several advantages in regard to other ways of exercising. The most significant advantage is that a muscle group can be exercised to its maximum potential along the whole scope of movement of a joint. Since speed can be adjusted on an isokinetic dynamometer from 0 to 450 degrees in a second during a training, the objective of this study is to define a size of difference of effects of such a training in regard to angular speed of exercising with 60°/s or 180°/s. An additional benefit of application of these angular speeds is a wide application of this range, which was examined in many studies (Ghena et al. (1991), Mangine and Noyes (1992). These angular speeds were also applied by many researchers in order to measure strength of dynamic knee stabilizers (Kellis et al. 2001; Dauty et al. 2003; Ergun et al. 2004; Kazazović et al. 2007, Kovačević 2010). Pursuant to these information, this study will attempt to define which one out of the most frequently applied speeds, 60°/s or 180°/s, provides better training effects. Namely, the intention is to define existence of differences in the size of effects on development of peak torque of the knee extensor and flexor of a dominant leg between two groups which performed isokinetic trainings with the mentioned angular speed.

### Methods

#### Examinees sample:

Population of physically active women, 45 female sport faculty students, was divided into three groups with a random selection method: the first – experimental group (n = 15), the second experimental (n = 15) and control group (n = 25). The population included physically active women between the age of 19 and 25. None of the selected examinees could have a history of injuries of lower limbs in the last two years.

---

\* This research was supported, in part, by grant no. 034-0342610-2609 (Programming of transformational procedures for physical conditioning) from Croatian Ministry of science, education and sport.



**Variables sample:**

*Variables for an assessment of the knee extensor and flexor strength with an isokinetic dynamometer:*

1. KE60PT - Knee – extension – 60°/s – peak torque
2. KF60PT - Knee – flexion – 60°/s – peak torque
3. KE180PT - Knee – extension – 180°/s – peak torque
4. KF180PT - Knee – flexion – 180°/s – peak torque

**Experimental procedure description**

During this training period the groups performed physical activities related to a program of regular classes at the Sport Faculty, but the experimental groups also performed an additional isokinetic training of a dominant leg.

Experimental group 1 (slow) performed knee trainings on a Biodex isokinetic dynamometer, 3 times weekly, with angular speed of 60°/s.

Experimental group 2 (fast) performed knee trainings on a Biodex isokinetic dynamometer, 3 times weekly, with angular speed of 180°/s.

Control group (3) acted according to a regular curriculum and a practical training program of a year of study attended by a full time student.

A number of series and a number of repetitions in series is set in a way that performed work is increased progressively (total work) from week to week. A pilot measuring defined that the ratio of worked performed in one repetition with 60 and 180 °/s in stretching and flexion of a knee is 1,33. Repetitions for slow and fast group are calculated in this way. This means that according to this calculation both groups would perform equal quantity of mechanical work – they would have the identical training volume.

**Data processing methods**

Basic central and dispersion parameters were calculated with descriptive statistics:

Data processing was done with statistical packages IBM SPSS 19,0 for Windows and STATISTICA 9.0. One applied univariate analysis of variance (ANOVA) to difference variables (final measuring result minus initial measuring result) for defining of effects of the implemented experimental procedure. A level of statistical significance was set to  $p < 0.05$ .

**Results**

Quantitatively expressed effects of the implemented isokinetic training for the first “slow” (60°/s) experimental group are visible in an increase of average result of peak torque of knee extensor of 25,9 Nm or ~ 18 %, between the initial and the final measuring.

*Table 1. Statistical significance of differences in realized effects among group*

Multiple Comparisons: Dependent Variable: Knee – Extension – 60°/s						
GROUP	GROUP	Mean Difference (I-J)	Std. Error	Sig.	95% Confidence Interval	
					Lower Bound	Upper Bound
1	2	35.2667(*)	5.6017	.000	21.2979	49.2354
	3	30.0867(*)	5.6017	.000	16.1179	44.0554
2	1	-35.2667(*)	5.6017	.000	-49.2354	-21.2979
	3	-5.1800	5.6017	1.000	-19.1488	8.7888
3	1	-30.0867(*)	5.6017	.000	-44.0554	-16.1179
	2	5.1800	5.6017	1.000	-8.7888	19.1488

Negative effects or a decrease of average results are visible with second experimental group for about 4% , or 9,53 Nm. Results of the final measuring for the control group is 4,2 Nm or ~ 3%, which is 5,3 Nm less in regard to the decrease of results of the second experimental group.

Table 2. Statistical significance of differences in realized effects among groups

Multiple Comparisons: Dependent Variable: Knee – Flexion – 60°/s						
GROUP	GROUP	Mean Difference (I-J)	Std. Error	Sig.	95% Confidence Interval	
					Lower Bound	Upper Bound
1	2	15.9800(*)	3.6480	.000	6.8831	25.0769
	3	17.6000(*)	3.6480	.000	8.5031	26.6969
2	1	-15.9800(*)	3.6480	.000	-25.0769	-6.8831
	3	1.6200	3.6480	1.000	-7.4769	10.7169
3	1	-17.6000(*)	3.6480	.000	-26.6969	-8.5031
	2	-1.6200	3.6480	1.000	-10.7169	7.4769

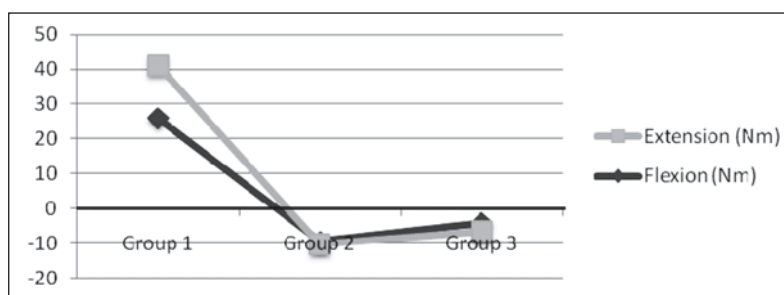

Graph 1. Graphical illustration of effects among groups measured with 60°/s

Namely, the increase of average result of the first experimental group is 15,2 Nm or ~ 20%. Analyzing effects of the second experimental group to the knee flexor strength measured at angular speed of 60°/s we see similarities with results obtained for the knee extensor at the same angular speed. Negative effects and the decrease of average results of this group is 0,8 Nm. the control group has the decrease in results of 2,4 Nm or ~ 3%.

Table 3. Statistical significance of differences in realized effects among groups

Multiple Comparisons: Dependent Variable: Knee – Extension – 180°/s						
GROUP	GROUP	Mean Difference (I-J)	Std. Error	Sig.	95% Confidence Interval	
					Lower Bound	Upper Bound
1	2	12.8933(*)	4.0540	.008	2.7840	23.0026
	3	21.6400(*)	4.0540	.000	11.5307	31.7493
2	1	-12.8933(*)	4.0540	.008	-23.0026	-2.7840
	3	8.7467	4.0540	.110	-1.3626	18.8560
3	1	-21.6400(*)	4.0540	.000	-31.7493	-11.5307
	2	-8.7467	4.0540	.110	-18.8560	1.3626

Table 4. Statistical significance of differences in realized effects among groups

Multiple Comparisons: Dependent Variable: Knee – Flexion – 180°/s						
GROUP	GROUP	Mean Difference (I-J)	Std. Error	Sig.	95% Confidence Interval	
					Lower Bound	Upper Bound
1	2	7.6533(*)	2.9222	.037	.3662	14.9404
	3	17.6667(*)	2.9222	.000	10.3796	24.9538
2	1	-7.6533(*)	2.9222	.037	-14.9404	-.3662
	3	10.0133(*)	2.9222	.004	2.7262	17.3004
3	1	-17.6667(*)	2.9222	.000	-24.9538	-10.3796
	2	-10.0133(*)	2.9222	.004	-17.3004	-2.7262

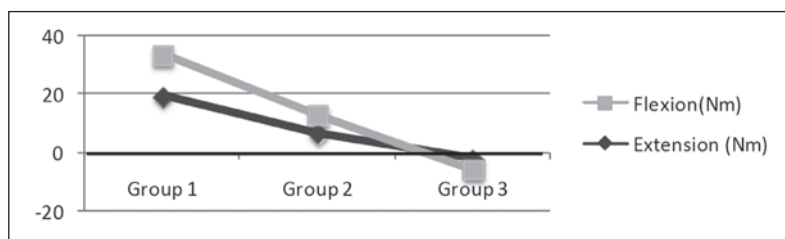

Graph 2. Graphical illustration of effects measured among groups with 180°/s

The first experimental group that performed an isokinetic training of the knee extensor at 60°/s, showed the increase of average results of 19,6 Nm or ~ 21%. The second experimental group which implemented an isokinetic knee training at angular speed of 180°/s showed an increase of results regarding peak torque of the knee extensor measured at the same angular speed of 6,6 Nm or ~ 6%. The first experimental group shows an increase of results of maximum peak torque of the knee flexor measured at angular speed of 180°/s in the final measuring of 14,1 Nm or ~ 25%. The second experimental group achieved the increase of 6,4 Nm or ~ 10%.

## Discussion and conclusions

Comparing an analysis of results obtained from the implementation of a 4-week isokinetic training with two experimental groups which performed the mentioned training with two different angular speeds with results of the control group we obtain:

### Analysis of effects of applied isokinetic programs measured at “low” angular speeds

Quantitatively expressed effects of the implemented isokinetic training for the first “slow” (60°/s) experimental group are visible in an increase of average result of peak torque of knee extensor of 25,9 Nm or ~ 18 %, between the initial and the final measuring. It was logical to expect these results due to specificities of the implemented isokinetic training. It is known that effects of a training are the best in an exercise that is also applied as a training asset and as a test for evaluation of effects of so called “specificity of training” (Sale and MacDougal, 1981). If we analyze results of the second “fast” (180°/s) experimental group at the same variable, we reach indicators that are not in accordance with presumptions preceding the implemented experimental program. Namely, the second experimental group performed an isokinetic training of the knee extensor at “higher” angular speed of 180°/s, but it was logical that they would achieve positive transformation effects measured at a lower angular speed. However, negative effects or a decrease of average results are visible with this experimental group for about 4% , or 9,53 Nm. These results are not in accordance with results of previous researches (Coyle et al. 1981) which conclude that training at higher angular speed has a tendency to increase strength to and below training speed. Precisely saying, a decrease of results of the final measuring for the control group is 4,2 Nm or ~ 3%, which is 5,3 Nm less in regard to the decrease of results of the second experimental group. Similar results regarding the size of changes are visible in measuring of peak torque of the knee flexor at angular speed of 60°/s. Namely, the increase of average result of the first experimental group is 15,2 Nm or ~ 20%. Analyzing effects of the second experimental group to the knee flexor strength measured at angular speed of 60°/s we see similarities with results obtained for the knee extensor at the same angular speed. Negative effects and the decrease of average results of this group is 0,8 Nm. Different from results of the knee extensor, the control group has a greater decline of results in regard to the second experimental group. Quantitatively expressed, the control group has the decrease in results of 2,4 Nm or ~ 3%. We see that there are statistically significant differences in training effects between the first and the second experimental group, and the first experimental group and the control group regarding the knee extensor and flexor.

### Analysis of effects of applied isokinetic programs measured at “high” angular speeds

The first experimental group that performed an isokinetic training of the knee extensor at 60°/s, showed the increase of average results of 19,6 Nm or ~ 21%. These results can be explained with the fact that concentric isokinetic training at lower angular speed, in our case 60°/s, is so unspecific that it caused a significant increase of maximum strength of the knee extensor measured at angular speed higher than 180°/s.

The second experimental group which implemented an isokinetic knee training at angular speed of 180°/s showed an increase of results regarding peak torque of the knee extensor measured at the same angular speed of 6,6 Nm or ~ 6%. Therefore, the applied isokinetic training of a concentric character at higher angular speed caused an increase of maximum strength of the knee extensor measured at angular speed of 180°/s, but those effects are significantly less in regard to the effects of the first experimental group. Quantitatively speaking, the control group shows the decrease of

the results in the applied period of time of 2,1 Nm or ~ 2%. Differences between the first and the second experimental group are not statistically significant but have a significance trend  $p=0,008$  while the second experimental group does not significantly differ from the control group statistically. These indicators only confirm our conclusion that isokinetic knee training at lower speeds is more dominant than the same at higher angular speeds.

An analysis of results of effects of increasing of maximum peak torque of the knee flexor measured at angular speed of 180°/s shows the same trend which was seen with the knee extensor at the same angular speed. The first experimental group shows an increase of results of maximum peak torque of the knee flexor in the final measuring of 14,1 Nm or ~ 25%.

The second experimental group achieved the increase of 6,4 Nm or ~ 10% in measuring of maximum flexor strength at angular speed of 180°/s. We again see that the difference between the first and the second experimental group in effects is 15% to the advantage of the first group.

The control group shows the decrease of results of 3,6 Nm or ~ 6%, which was also the case with extensors at this angular speed. Multiple comparisons among the groups on a basis of variables of knee flexion at angular speed of 180°/s show that there are statistically significant differences in training effects between the first experimental and the control group.

We can draw a conclusion from the obtained results that unilateral concentric isokinetic training of the two experimental groups, with different angular speed, produced positive transformational effects on maximum strength of the knee extensor and flexor expressed through peak torque. This conclusion is completely supported with results of the first experimental group, which performed an isokinetic training of dynamic knee stabilizers at “low” angular speed of 60°/s, which caused positive and statistically significant effects in all measurings at lower (60°/s ) and higher (180°/s) angular speeds. On the other hand, the second experimental group which performed the same type of training at “high” angular speed of 180°/s showed positive effects only in measuring of maximum peak torque of the knee extensor and flexor in testing at a training angular speed while measuring at low angular speed show negative effects and a decrease of maximum peak torque of dynamic knee stabilizers. Generally, it can be concluded that concentric isokinetic training at angular speed of 60°/s produced, both absolutely and relatively expressed, greater effects on development of maximum strength of dynamic knee stabilizers than isokinetic training implemented at angular speed of 180°/s in testing with both angular speeds.

## References

1. Coyle, E.F. et al. (1981). *Specificity of power improvements through slow and fast isokinetic training*. Journal of Applied Physiology, 51: 1437-1442.
2. Dauty, M., Potiron-Josse, M., & Rochcongar, P. (2003). *Identification of previous hamstring muscle injury by isokinetic concentric and eccentric torque measurement in elite soccer players*. Isokinetic and Exercise Science 11(3): 139-144.
3. Ergun, M., Islegen, C., & Taskiran, E. (2004). *A cross-sectional analysis of sagittal knee laxity and isokinetic muscle strength in soccer players*. International Journal of Sports Medicine 25(8): 594-598.
4. Ghena, D.R., Kuth, A.L., Thomas, M., & Mayhew, J. (1991). *Torque characteristics of the quadriceps and hamstring muscles during concentric and eccentric loading*. Journal of Orthopaedic and Sports Physical Therapy 14: 149-154.
5. Kellis, S., Gerodimos, V., Kellis, E., & Manou, V. (2001). *Bilateral isokinetic concentric and eccentric strength profiles of the knee extensors and flexors in young soccer players*. Isokinetic and Exercise Science 9(1): 31-39.
6. Kovačević, E. (2009). *Effects of concentric isokinetic training at various angular speeds on maximum and explosive strength of physically active women*. Master's thesis, Faculty of Sport and Physical Education, University of Sarajevo.
7. Mangine, R., & Noyes, F. (2001). *Functional performance testing following knee ligament injury*. Physical Therapy in Sport, Volume 2, Issue 2, Pages 91-105 N.Clark.
8. Sale, D.G., & MacDougall, J.D. (1981). *Specificity in strength training: a review for the coach and athlete*. Canadian Journal of Applied Sport Science, 6(2): 87-92
9. Thistle, H.G., Hislop, H.J., Moffroid, M., & Lowman, E.W. (1967). *Isokinetics contraction: a new concept of resistive exercise*. Archives of Physical Medicine and Rehabilitation, 48:279-282

## EFFECTS OF UNILATERAL STRENGTH TRAINING ON BALANCE PERFORMANCE\*

**Josipa Bradić<sup>1</sup>, Erol Kovačević<sup>2</sup> and Fuad Babajić<sup>3</sup>**

<sup>1</sup>*Faculty of Kinesiology University of Zagreb, Croatia*

<sup>2</sup>*Faculty of Sport and Physical Education, University of Sarajevo, Bosnia and Herzegovina*

<sup>3</sup>*Faculty of Physical Education and Sport, University of Tuzla, Bosnia and Herzegovina*

### Abstract

The purpose of this study was to determine if 4-week of unilateral isokinetic strength training (concentrically concentric contractions) program would improve trained single limb stability in young physically active women. Thirty healthy physically active women, students of kinesiology, participated in this study. Single limb postural stability of trained nondominant leg was assessed with a Biodex Stability System. The unilateral isokinetic con-con training program consisted of three training per week for four weeks. Following the completion of the training program, each subject was re-evaluated to determine change in total, Anterior-Posterior, and Medio-Lateral single limb stability. We hypothesized unilateral isokinetic strength training would result in an improvement in postural stability. T-test and ANOVA were used to determine differences between pretraining and posttraining unilateral balance. The subjects showed a significant improvement in all three measure of single-limb stability (OSI:  $F=12,22$ ;  $p=0.001$  ; APSI:  $F=20,93$ ;  $p=0.000$  MLSI:  $F=26,41$ ;  $p=0.000$ ). A 4-week of unilateral isokinetic strength training (concentrically concentric contractions) program improves statistically significant single limb stability of trained leg in all three measure of single-limb stability in young physically active women.

**Key words:** *Unilateral isokinetic strength training, balance, physically active women*

### Introduction

Injury prevention training program typically incorporates combinations of balance components, plyometrics, flexibility, and strength training program (Paterno, 2004). Strength training program, and generally leg strength muscle, plays an important role in balance performance (Orr et al. 2008). One of the most fiduciary and easiest ways to measure strength is by using the isokinetic dynamometer.

In past, balance (static balance) was usually tested by means of force platform (Arnold, and Schmitz, 1988) which measures the centre of pressure. In contrast to force plate system, the Biodex Stability System (BSS) (Biodex, Inc, Shirley, NY) uses a circular platform that is free to move about the anterior-posterior (AP) and medial-lateral (ML) axes simultaneously. In addition to moving about these axes, it is possible to vary the stability of the platform by varying the resistance force applied to the platform. Rather than measuring the deviation of the COP during static conditions, BSS measures the degree of tilt about each axis during dynamic conditions. From the degrees of tilt about the AP and ML axes, the BSS calculates the medial-lateral stability index (MLSI), the anterior-posterior stability index (APSI), and the overall stability index (OSI).

Research has shown positive dependence between the strength of lower limbs and balance in elderly persons (Horlings et al., 2008; Pijnappels et al., 2008). It has also been proved that strength training can significantly improve balance in elderly persons (Holviala i sur., 2006; Orr et al., 2008), and that muscle weakness constitutes a risk factor to postural instability and falls in elderly persons (Horlings et al. 2008). Furthermore, it has been proved that neuromuscular training positively affects balance of ankles, with no records of injuries, that is, ankles with functional instability (Sekir et al. 2007; Paterno et al. 2004). Blackburn et al. (2000) came up with the results that prove that increased proprioception and strength are equally efficient in improving ankle stability and balance. For young population it is known that complex neuromuscular training (balance, plyometric, and resistance training) significantly improves balance performance (Paterno et al. 2004). Also, it is known that insulated training program for back strength in young population does not improve balance (Kollmitzer et al. 2000). Also, it is known that strength in general was not highly correlated to Star Excursion Balance test (SEBT) (Thorpe and Ebersole, 2008).

---

\* This research was supported, in part, by grant no. 034-0342610-2609 (Programming of transformational procedures for physical conditioning) from Croatian Ministry of science, education and sport.

Given the foregoing, it can be concluded that well-developed sense of balance is definitely one of the ways to prevent injuries, not only in geriatric population, but also in physically active young women. Therefore, the main purpose of this study is to determine whether a 4-week unilateral isokinetic strength training (concentrically concentric contractions) program can improve trained single limb stability in physically active young women.

## Methods

### Sample of entities

30 young women (students of kinesiology) were randomly allocated to one of two groups: 1) control group (n=15), 2) experimental group (n=15).

### Sample of variables

All participants were subject to basic anthropometric measurements: body high, body mass, and the percentage of body fat, unilateral balance performance of non-dominant leg. Prior to initiating training, single-limb postural stability was assessed on a Biodex Stability System (Biodex, Shirley, New York, USA). BSS was used in a numerous of studies before (Arnold, 1998; Paterno et al. 2004; Rein et al. 2010a; Rein et al. 2010 b, Kim, Cha i Fell, 2011 itd.). System reliability (coefficient of variations) is 5%. The tests of balance performance on BSS are: Overall Stability Index (OSI), Anterior–Posterior Stability Index (APSI), and Medio-Lateral Stability Index (MLSI).

### Training

The training program consisted of unilateral concentric contractions of knee extensors and flexors, and ankle dorsi and plantar flexors and it was performed on isokinetic dynamometer (Biodex System 3, Biodex Corporation, Shirley, NY). The training velocity was 60°/s for knee, and 30°/s for ankle. Over the 4-week program the training volume increased progressively with the increase in sets number, starting first with two (first training), then three (from second to fifth training) and finally with four sets (from 6<sup>th</sup> to 12<sup>th</sup> training). The participants performed only concentric contractions.

### Data analysis

Mean and SD of mass and body fat were reported for all subjects, both for pre-training and post-training stage. For assessment of postural stability mean and SD of postural stability of the 3 single-limb trials for trained (non-dominant) leg of each subject was recorded at the pre-training and post-training sessions for OSI, MLSI, and APSI. The group mean and SD pre-training and post-training were calculated for descriptive purpose. A paired t-test was used to determine significant changes of all variables in both groups. Three separate ANOVAs were conducted to determine if any difference existed between groups in balance tests pre-training and post-training.

## Results and discussion

T-test proved that the 4-week unilateral isokinetic training program did not cause any statistically significant difference in body mass ( $p > 0,968$ ), nor in body fat percentage ( $p > 0,692$ ). These results are important because they prove that differences in balance, which occurred during the unilateral isokinetic con-con strength training, are primarily the results of nerve (and not muscle) adjustment. Therefore, the differences in the effects between the relevant groups occurred because of the very differences in the treatment.

Table 1. The results of initial and final testing of high, mass, body fat and mean and standard deviation of three balance variables in EXP and CON group. (t-test of initial and final testing : \*  $p < 0,05$ , \*\*  $p < 0,01$ , \*\*\*  $p < 0,001$ ).

TRAINED LEG	EXP INITIAL	EXP FINAL	CON INITIAL	CON FINAL
Height	166,46 cm	-	168,4 cm	-
Mass	59,33 kg	59,10 kg	61,26 kg	60,90 kg
Body fat	26,16 %	25,23%	26,18%	25,69%
OSI	2,07 (0,82)	1,34*** (0,57)	2,34 (0,77)	2,27 (0,86)
APSI	1,70 (0,83)	1,13** (0,35)	1,91 (0,77)	1,68 (0,31)
MLSI	1,44 (0,89)	0,93* (0,24)	1,48 (0,31)	1,50 (0,35)

The results of t-test for OSI, APSI, and MLSI indicated statistically significant differences between initial and final measurements in EXP group (Table 1). Also, we can see that there are no statistically significant differences between initial and final measurements in CON group (Table 1).

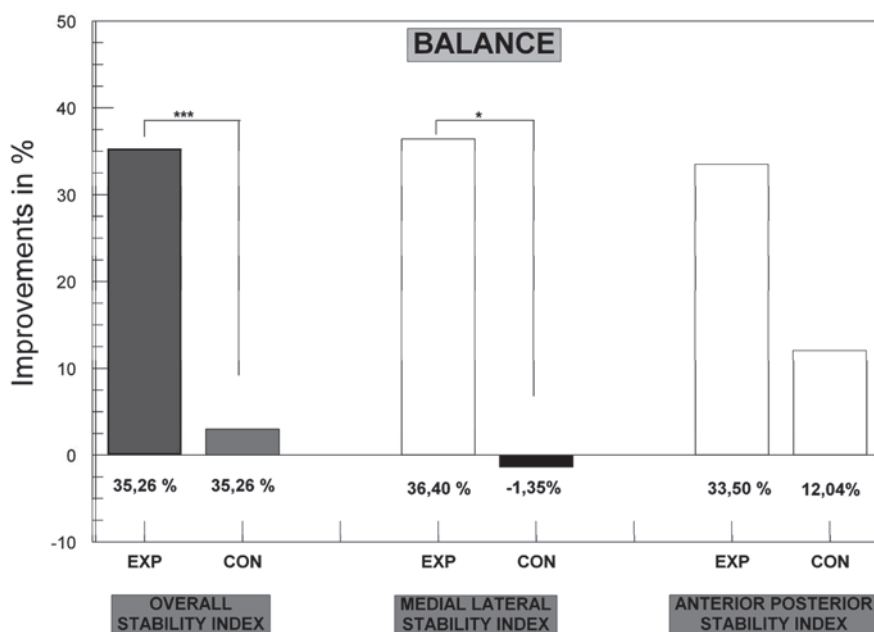

Figure 1. The improvement in percent in balance measurements. (ANOVA: \*  $p < 0,05$ , \*\*  $p < 0,01$ , \*\*\*  $p < 0,001$ ).

The results of the ANOVA for OSI, MLSI, and APSI indicated that there is no statistically significant differences between pre-training groups (OSI:  $F=0,838$ ;  $p=0.367$ ; APSI:  $F=0500$ ;  $p=0.485$  MLSI:  $F=0,018$ ;  $p=0.891$ ), and shows that there are statistically significant differences between post-training groups (OSI:  $F=12,22$ ;  $p=0.001$ ; APSI:  $F=20,93$ ;  $p=0.000$  MLSI:  $F=26,41$ ;  $p=0.000$ ).

Also, the results of series of ANOVA's showed that there is statistically significant differences in the amount of improvements between EXP and CON groups in OSI ( $F = 20,13$ ;  $p < 0.000$ ) and MLSI ( $F = 7,30$ ;  $p < 0.012$ ). Figure 1 shows that there are no statistically significant differences in the amount of improvements between EXP and CON groups in APSI ( $F = 1,86$ ;  $p < 0.183$ ).

Our results show that strength training has a positive effect on balance performance. Figure 1 shows that OSI increased for 35,26%, APSI for 33,5%, a MLSI for 36,40%. These percents show that the balance increases are almost identical. So, it seems that unilateral isokinetic concentric training almost equally affects all balance measurements. But, if we know that the progress of abilities, with in the same training volume, is inversely proportional to the physical fitness profile (Melerović, Meler, 1975) we can assume that the greatest improvements showed the balance measure which in initial testing had a greatest score (MLSI). Substantiate, the result of t-test showed that there was no statistically significant difference in the amount of improvements between EXP and CON groups in APSI.

Namely, the studies of Arnold and Schmitz (1998) showed that 95% of the variance in the OSI can be accounted for by the APSI, suggesting that OSI and APSI are nearly identical. Generally, OSI is calculated by the APSI and MLSI (Arnold and Schmitz, 1998), and MLSI and APSI have the same power on OSI. Thus, as APSI declines, MLSI has more effect on OSI. In this case, we suppose that absence of statistically significant differences between EXP and CON group in APSI is due to a relatively big increase in CON group (12%, Figure 1). Substantiate, our finding that APSI was (almost) equal with MLSI is in accordance with previous studies (Era, and Heikkinen, 1985; Goldie, Bach, and Evans, 1989).

Injury prevention training program typically incorporate some combination of strengthening, flexibility, plyometrics, and balance components (Paterno, 2004). This type of training is usually called neuromuscular training. In this paper, we are completely sure that the balance performance is improved thanks to the strength training program. A 4-week unilateral isokinetic strength training (concentrically concentric contractions) program improves statistically significant, and almost equal, single limb stability of trained leg in all three measurements of single-limb stability in physically active young women without any leg injury in past two years.

## References

1. Arnold, B.L., Schmitz R.J. (1998) Examination of balance measures produced by the Biodex Stability Sistem. *Journal of athletic training*. 33(4):323-327.
2. Blackburn, T., Guskiewicz, K.M., Petsegauer, M.A. i Prentice, W.E. (2000). Balance and joint stability: The relative contributions of proprioception and muscular strength. *Journal of sport rehabilitation*. 9(4):315-328.
3. Era, P., Heikkinen, E. Postural sway during standing and unexpected disturbance of balance in random samples of men of different age. *Journals of gerontology*. 40:287-295.
4. Goldie, P.A., Bach, T.M., Evans, O.M. (1989). Force platform measures for evaluating postural control: reliability and validity. *Archives of Physical Medicine and Rehabilitation*. 70:510-517.
5. Holviala, J.H.S., Sallinen, W.J., Kraemer, W.J., Alen, M.J. and Häkkinen, K.K.T. (2006). Effects of strength training on muscle strength characteristics, functional capabilities, and balance in middle-aged and older women. *Journal of Strength and Conditioning Research*. 20(2)336-344.
6. Horlings, C.G.C., Engelen, G.M.B., Allum J.J.H. and Bloem, R.B. (2008). A weak balance: the contribution of muscle weakness to postural instability and falls. *Nature Clinical Practice Neurology*. 4(9):504-15.
7. Kim, K., Cha, Y.L., i Fell, D.W. (2011). The effect of contralateral training: influence of unilateral isokinetic exercise on one legged standing balance of the contralateral lower extremity in adults. Apr 30. [Epub ahead of print].
8. Kollmitzer, J., Ebenbichler, G.R., Sabo, A., Kersch, K. and Bochsansky, T. (2000). Effects of back extensor strength training versus balance training on postural control. *Medicine & science in Sport & Exercise*. 32(10):1770-1776.
9. Melerović, H. i Meler (1975). Biološki i medicinski osnovi i principi treninga. Savez za fizičku kulturu Jugoslavije. Beograd.
10. Orr, R., Raymond, J. i Fiatarone Singh, M. (2008). Efficacy of Progressive Resistance Training on Balance Performance in Older Adults – A Systematic Review of Randomized Controlled Trials. *Sports Medicine*. 38(4):317-343.
11. Paterno, M.V., Myer, G.D., Ford, K.R. i Hewttt, T.E. (2004). Neuromuscular training improves single limb stability in young female athletes. *Journal of Orthopaedic & Sports Physical Therapy*. 34 (6):305-316.
12. Pijnappels, M., Reeves, N.D., Maganaris, C.N. and Dieën, J.H. (2008). Tripping without falling; lower limb strength, a limitation for balance recovery and a target for training in the elderly. *Journal of Electromyography and Kinesiology*. 18(2):188-196.
13. Rein, S., Fabian, T., Weindel, S., Schneiders, W., Zwipp, H. (2011a). The influence of playing level on functional ankle stability in soccer players. *Archives of Orthopaedic and Trauma Surgery*. Feb 18. [Epub ahead of print].
14. Rein, S., Fabian, T., Zwipp, H., Rammelt, S., Weindel, S. (2011b). Postural control and functional ankle stability in professional and amateur dancers. *Clinical Neurophysiology*. Mar 22. [Epub ahead of print].
15. Schmitz, R., Arnold, B. (1998). Intertester and intratester reliability of the Biodex Stability Sistem. *Journal of sport rehabilitation*. 9:95-101.
16. Sekir, U., Yildiz, Y., Hazneci, B., Ors, F. & Aydin, T. (2007). Effect of isokinetic training on strength, functionality and proprioception in athletes with functional ankle instability. *Knee Surgery Sports traumatology Arthroscopy*. 15(5):654-664.
17. Thorpe, J.L. and Ebersole, K. (2008). Unilateral balance performance in female collegiate soccer athletes. *Journal of Strength and Conditioning Research*, 22(5):1429-1433.

## Note:

This research is part of the scientific project “Programming transformational processes for the development of physical preparedness” no. 034 - 0342610-2609 (main investigator Prof. Dragan Milanović), under the patronage of the Croatian Ministry of Science, Education and Sports.



## KINESIOLOGICAL TRANSFORMATION WITHOUT KINESITHERAPY – EFFECTS OF INDIVIDUAL HYDROTHERAPY ON OSTEOARTHRITIS IN THE SPA PROGRAM

Senka Rendulić Slivar<sup>1</sup>, Oto Kraml<sup>1</sup> and Jelena Pecikoza<sup>2</sup>

<sup>1</sup>Special Hospital for Medical Rehabilitation Lipik, Croatia

<sup>2</sup>Faculty of pharmacy, University of Belgrade, Serbia

### Abstract

**Introduction:** Effects of Marble baths (MB) on symptoms of osteoarthritis (OA) of the lower extremities are conducted. MB is traditional way of individual hydrotherapy in thermo mineral water in the spa Lipik. **Material and methods:** The research has been conducted as ten-day experiment with one group, 11 women, average 62±5 years; BMI 30±2,9 kg/m<sup>2</sup>. The treatment included MB, 20 minutes daily. Pre- and posttest measured pain, functionality, ROM of knees, maximal isometric quadriceps strength. Results were tested with paired T-tests. **Results:** Final measurements indicated a significant reduction of pain (56%; p<0,01), improvement in functionality (50%; p<0,01) and ROM of knees (left 5%, p<0,05; right, 4%, p>0,05), increase of muscle strength (13-16%; p<0,05). **Conclusion:** Ten days-use of MB has positive effects on decrease of symptoms OA of the lower extremities mild and moderate grade.

**Key words:** Marble bath, hydrotherapy, osteoarthritis, Lipik spa

### Introduction

Conventional therapeutically spa program in health resorts traditionally include one form of the hydrotherapy (HT), kinesitherapy (KT) and education (Rendulić Slivar, 2010). Marble Bath (MB) is traditional way of individual HT in Lipik spa for more than 120 years (Kraml, 2005). With their characteristics MB are unique at the region of Croatia and Bosnia and Herzegovina (Rendulić Slivar & Pecikoza, 2010). According to historical facts the object for MB was built in 1886. The building MB looks like classicist temple with arcades and mythological figures on the pediment. At the end of XIX century inside of the MB building were 26 bathtubs made of the pink marble and porcelain. Today, in the same building, whose restoration was completed 2006<sup>th</sup> year, there are only five MB. Every bathtub is placed in separate room with floor mosaics, columns, arches, natural ventilation in the painted dome ceiling, wall antique mirror and space for clothes (Kraml, 2005). Bathtubs are noon, with two steps, size 140x70 cm, 70 cm deep and covered with marble like it is in its name. There is a supply of hot and cold mineral water so it can be prepared the desired temperature of water. The natural water of Lipik has been classified as: mineral, fluorine, sodium, hydrogen-carbonate, chloride hyperthermia, with mineralization 3115 mg/l (Balneochemical analysis of the water No. 14/2-09, 29. 10. 2009., Andabaka & Čepelak) (in Rendulić Slivar & Kraml, 2011). According to data from 1870 the temperature of the water at the first founded spring was 64°C and at the 2009 it was 62°C. Therefore the water is cooled for therapy purposes. Besides for bathing, the water from the thermal well is also used for drinking. The healing effects of MB until today were not recorded systematically or proved scientifically. Empirically, mineral water is reducing tension in the muscles, reducing vertebral problems, reducing pain in OA and other inflammatory rheumatic diseases, also it has a positive effects on pain in neurological diseases, increase of flexibility and improve of circulation (Kraml, 2005; Rendulić Slivar & Pecikoza, 2010). It particularly emphasizes reduced fatigue, improved general well-being and relaxation in persons treated with MB. Kraml, Šreter & Czukur (1990) stated that 90% of users of traditional seasonal balneobaths are women. Nearly 70% of those women were older than 51 years, and the most frequent cause for their use of this treatment was degenerative diseases of the spine and joints, also as fatigue (in Rendulić Slivar & Kraml, 2010). MB treatments last ten to twelve days. Isolated balneotherapy treatment has been used less in past 20 years. It has been integrated in balneorehabilitation programs, but still it is also an actual way of healing. During the application of MB patients can perform strength exercises in the water but in this study they were not target conducted.

OA occurs as a result of degenerative changes of joints, traumas, sports injuries, inappropriate excessive, but also insufficient physical activity whose consequences are deterioration of the joint cartilage and remodeling of the subchondral bone (Rendulić Slivar, 2010). The algorithm of treatment of persons whose suffer of OA includes pharmacological and no pharmacological interventions. As a part of the no pharmacological therapy, physical therapy is recommended as an alternative in early stages of OA and in prevention of progression of OA. The main symptoms of OA are the classic signs of inflammation – pain, swelling, warming, functionless of the joint, weakness in the walk, crepitus in the moving, decrease in the daily life activities (DLA) and quality of life (QoL).

The main focus of this study was to assessment influence of the natural health remedies, in this case, thermo mineral water in Lipik spa, on subjective symptoms and kinesiological transformation by subjects with OA of lower extremities after two weeks of application of MB without targeted KT. The aim was to verify whether the therapeutic baths without exercises in the target group of respondents have justified the creation of the rehabilitation program for OA.

## Methods

Longitudinal experiment was conducted for a period of two weeks, with one group of subjects. Group consisted of 11 women, retirees, older than 55 years with confirmed OA of large joints of the lower extremities (predominantly knee) and in range of moderate pain. The subjects traditionally goes to Lipik spa once a year and were two or more times in the Spa. The treatment included MB on the whole body 20 minutes every day, electrotherapy and ultrasound massage of some parts of the trunk, but not on the legs. It was monitored the degree of pain on VAS (0-10), functional assessment of the locomotor sistem (LMS) with evaluation of Lequesen's index 0-24 (+2), range of movement (ROM) in knees (in ° / using the flexometer) and muscle quadriceps strength (on isokinetic dynamometer KT-4 in kg/cm<sup>2</sup>). Patients evaluated variables when they came in and before they left the Spa.

The statistical application for personal computers, SPSS for Windows – version 13.0 was used for all calculations. It was tested the significance between arithmetical means (M) obtained by the initial and final measurements, using Paired-Sample T test. For precise evaluation, the final data are expressed in percentage in relation to pre-test.

## Results

The study included 11 female patients, age of 62,6 (55-70) years, over weighted in average, with body mass index (BMI) 30.23 kg/cm<sup>2</sup> (Table 1). They had clinical signs of OA of the hip, knee or ankle joint. One woman had normal weight (BMI 20-24.9 kg/m<sup>2</sup>), six of them were over weighted (BMI 25-29.9 kg/m<sup>2</sup>), while four persons were obese (BMI > 29.9 kg/m<sup>2</sup>) (Table 2).

Table 1. Physical Characteristics of Subjects – age and BMI

Characteristics	M	SD	Min	Max
Age (years)	62,64	5,12	55	70
BMI (kg/m <sup>2</sup> )	30,23	2,97	25,10	35,40

Legend: BMI – Body mass indeks, M – mean, SD – standard deviation, min – minimal valeue, max – maximal valeue. Source BMI: [http://web.mef.unizg.hr/ifa/lati/racunala/skripte/i\\_mase.htm](http://web.mef.unizg.hr/ifa/lati/racunala/skripte/i_mase.htm)

Table 2. Results assesement: pre- and post-test

Variable	Pre-test	Post-test	t-test	Sig.	Procent
VAS	4,45	1,91	8,151*	,000	56,10%
LEQUESEN INDEX	12,64	6,18	9,903*	,000	50,36%
ROM left knee (in °)	120,91	127,27	-2,971*	,014	5,52%
ROM right knee (in °)	121,36	126,36	-2,036	,059	4,36%
SmQF, left knee (kg/cm <sup>2</sup> )	95,45	107,09	-2,284*	,045	16,50%
SmQF, right knee (kg/cm <sup>2</sup> )	100,45	113,04	-2,540*	,029	13,42%

Legend: VAS visual analog scale, ROM - range of movement, SmQF – strength of muscle quadriceps femoris

\*statistically significant difference in the final measurement.

## Discussion and conclusion

Subjective assessment of patients shows an expressive progress - decreased sensation of pain (56%) and better functional index (50%). By clinically significant results it is considered reducing the pain for 2 or more on VAS and functional improvement is present in reducing Lequesen's index of 3 or more. Previously performed experimental studies indicate that the patient at a spa only needs a vacation and thermo-bath to feel well (Kraml, 2005; Rendulić Slivar & Kraml, 2007). Kinesiological transformations also were analyzed and according to theirs results the ROM in knees was increased and it was achieved greater quadriceps strength at the final measurement. This may be the result of mental and physical rest and relaxation, but the results of testing the strength can also be improved with decrease of pain. On the other hand, the results of previous studies in groups with programs of targeted therapeutic exercises indicates increase of muscle

strength (25-27%) and greater ROM of the joints (8%) in groups that practice (Rendulić Slivar, 2010). Interestingly, this does not influence significantly on subjective assessment of the status (24%) and pain component (35%) that is even lower than in the group that applied only MB (Rendulić Slivar, 2010). Use of MB, often more than recommended temperature (36°C), relaxes and leads to feeling of good general condition. It is preferred by women of mature age, and arrival at the spa, except for curative action, is also an annual holiday for retirees and housewives. The hypothesis that balneotherapy is “nonspecific stimulus therapy” has not been refuted yet. Definitive scientific interpretation is also absent. In the sixties of past century it was believed that arthritis/OA is indication for sulfur bath treatment (Dürriegl, 2009). It was known the way of skin resorption of nonstable sulfur forms. Water in Lipik spa, though it was not classified as sulfur, contains sulphates. During the bath substances in form of aerosols enter in our body through inhalation (Dürriegl, 2009). Sulfur acts anti-inflammatory, and therefore therapeutically on reduce of OA symptoms. Because of liposolubility of sulfur components and its passage through blood-brain barrier a certain psychological effects are achieved. What are the elements, in what degree they entered the body during the bath and how much they contribute to the therapeutic effect on OA, has not yet been clarified. There is a lack of scientifically based studies on the effectiveness of spa programs. Therapeutic exercise in thermal mineral water are conducted because of physical, chemical, biological and psychological impacts on human organism. Thermo mineral water have three primary effects that are useful for OA patients: mechanical, thermal and chemical. Mechanical effect is demonstrated with feeling caused by warm water and gas that leads to improvement of circulation and muscle relaxation, thermal-spasmodic effect leads to analgesia and chemical effect is demonstrated with mineral compounds of the water (the most intense effect is from sulphate water). According to results of chemical analysis of Lipik's thermo mineral water from 2009th year, it is established that besides high concentrations of sodium (807,4 mg/l) and hydrogen-carbonate (1489,8 mg/l), this water also contains a significant amounts of chloride (360,0 mg/l), fluoride (10,37 mg/l) and sulphates (247,97 mg/l). As it is already said, sulphates and hydrogen sulphide prevent cartilage degeneration and might be beneficial for de novo synthesis of matrix components and cartilage health, while thermal mineral water is traditionally used in treating injuries and post operational conditions on bones, joints and muscles. With united effects of high temperature water and mineral components the immune respond of organism is increased, the circulation through blood vessels and lymph is stimulated, the cell activity is accelerated, also as a recovery of organism. During immersion's hydrotherapy are registered less tension, anxiety, depression, anger and confusion.

MB are extremely relaxing form of HT because of its pleasant environment, but also because of the special feeling of warmth that gives marble heated by water. In twenty-minutes hypertherm bath (>36°) in thermo mineral water it comes to a weak mechanical stimulus for pain receptors in the skin, vasodilatation of peripheral blood vessels, stimulation of thermo receptors and inhibition of receptors for coldness which is one of possible mechanism of influence on the feeling of increased warmth in the extremities after the treatment (Nosaka, 2008). It has been documented that the sympathetic nervous system contributes to the sensation of pain by modifying the nociceptors. Muscle nociceptors are polymodal, responding to mechanical, thermal and chemical stimuli. The nervous system can interact with the pain pathways to palliate the perception of pain under some conditions. In this pain control process are involved brain and spinal cord. Substances involved in analgesia are enkephalins, endorphins and other opiate neuropeptides. Their secretion is associated with a sense of well-being. MB provides a unique feeling of mental relaxation, but also shows the impact on motorical transformations. This fact is confirmed by observed kinesiological parameters - increase of ROM and muscle strength that can be considered as a positive effect on psychological side and the placebo effect (Rendulić Slivar, 2010). The psychological effects should be monitored by tests that evaluate the quality of life or blood levels of stress hormones and that can be considered as a failure of this pilot-study.

With traditional program of MB it also can be apply amended programs - combination with specific exercise in MB, pearl bath, aromatherapy, chromotherapy, music therapy, sound of waterfalls etc.

Programs that advocate the traditional ways of applying HT (such as MB) deserve special attention and should be protects as a spa brand. Evidence based balneology, with health and kinesiological professionals, profiles a spa as a center for education about health and exercise, center for disease prevention and care from disability in DLA that comes from age-related diseases, in which we can include OA. General fatigue of the body leads to a drop of LMS function. Rest and relaxation in thermal mineral water through the MB program indicate progress in kinesiological parameters. The algorithm for selecting spa program for people with OA of the lower limbs must include methods such as this one and to define how to combine them with KT. Therapeutic baths lead to the release of general and local fatigue and thus indirectly reduce the symptoms of OA. It is suggested an individual approach to treatment, tailored to age, gender, and psychosocial status, and not just history of disease, clinical features and common patterns. Finally, we have to kip in mind possibility to exist also rehabilitation program without KT that produced significant kinesiological transformation in OA of the lower extremities.

## References

1. Dürriegl, Th. (2009). O balneološkom liječenju u reumatskih bolesnika u Hrvatskoj. [About balneologically therapy rheumatic patients in Croatia. In Croatian.] In G. Ivanišević (Ed.), *Proceedings book of Scientific Conference, Zagreb – Varaždinske Toplice, 2009, "300 godina balneoloških analiza u Hrvatskoj"* (pp. 46-50). Zagreb: Akademija medicinskih znanosti Hrvatske.
2. Kraml, O. (2005). Mramorne kupke u Lipiku. [Marble baths in Lipik hospital. In Croatian.] In G. Ivanišević (Ed.), *Proceedings book of Scientific Conference, Veli Lošinj, 2005, "Zdravlje i medicinski turizam – metode i programi"* (pp. 154-156). Zagreb: Akademija medicinskih znanosti Hrvatske.
3. Nosaka, K. (2008). Muscle soreness and damage and the repeated-bout effect. In P.M. Tiidus (Ed.), *Skeletal muscle damage and repair*. (pp. 59-76). Champaign, IL: Human Kinetics.
4. Rendulić Slivar, S., & Kraml, O. (2007). Utjecaj termomineralne kupelji na stres zbog boli. [Influence of thermal bath on the stress associated with pain. In Croatian.] In G. Ivanišević (Ed.), *Proceedings book of Scientific Conference, Veli Lošinj, 2007, "Lječilišta, zdravlje, stress"* (pp. 140-143). Zagreb: Akademija medicinskih znanosti Hrvatske.
5. Rendulić Slivar, S. (2010). *Utjecaj lječilišnih programa kratkoročnog vježbanja i suplementacije na kineziološke transformacije kod osteoartritisa koljena*. [The effects of spa programmes of short-term exercise and viscosupplementation on kinesiological transformation in knee osteoarthritis. In Croatian]. (Unpublished doctoral dissertation, Metropolitan University of Beograd). Novi Sad: Fakultet za sport i turizam, Metropolitan Univerziteta u Beogradu.
6. Rendulić Slivar, S., & Pecikoza, A. (2010). U potrazi za Mramornim kupkama. [Serching for the marble baths. In Croatian.] In G. Ivanišević (Ed.), *Proceedings book of Scientific Conference, Klanjec, 2010, "Zdravstveni turizam: medicina i kultura."* (pp. 42-47). Zagreb: Akademija medicinskih znanosti Hrvatske.
7. Rendulić Slivar, S., & Kraml, O. (2010). Efekti mramornih kupki na simptome osteoartritisa koljena. [Effects of marble baths on knee osteoarthritis symptoms. In Croatian.] In G. Ivanišević (Ed.), *Proceedings book of Scientific Conference, Veli Lošinj, 2010, "Lječilišna medicina i turizam"* (pp. 84-89). Zagreb: Akademija medicinskih znanosti Hrvatske.
8. Rendulić Slivar, S., & Kraml, O. (2011). Važnost hidroterapije u očuvanju kvalitete života starije životne dobi. [Importance of hydrotherapy in conserving quality of life by elderly people. In Croatian.] In M. Andrijašević & D. Jurakić (Eds.), *Proceedings book of International Scientific-Professional Conference, Osijek, 2011, "Sportska rekreacija u funkciji unapređenja zdravlja"* (pp. 280-285). Zagreb: Kineziološki fakultet, Sveučilište u Zagrebu.

## USE OF JUGGLING AS A SUITABLE PSYCHOMOTOR ACTIVITY IN PERSONS WITH SPECIAL NEEDS

Dagmar Travnikova and Jitka Koprivova

Faculty of Sports Studies, Masaryk University Brno, Czech Republic

### Abstract

The paper depicts juggling as an alternative physical activity suitable for persons with special needs. Juggling comes under physical activities from the area of psychomotricity and therefore covers physical, psychical as well as social aspect of man. As juggling includes wide range of skills, levels, props or techniques, it may be adjusted according to specific needs of any person. In the paper we introduce our work with seniors, children with ADHD and persons with auditory, visual, physical as well as mental handicaps. Masaryk university (CZ) offers juggling as an optional form of physical education and many students of Special Pedagogy attend the course yearly. Therefore, we believe that juggling will become a part of offered suitable physical activities for persons with special needs and will be practically applied in various areas.

**Key words:** *psychomotricity, juggling, persons with special needs, alternative physical activity*

### Introduction

Juggling is a physical activity from the field of *psychomotricity* which may influence several functions of man, such as eye-hand coordination, concentration, rhythmical skills, attention, spatial orientation, social interaction and balance. Many people in the Czech Republic still consider juggling an activity that should be performed only in a circus and that has nothing in common with education of development of human beings. However, we aim to stress the positive impacts of juggling in all dimensions of personality and attempt to deal with juggling from pedagogical, therapeutic as well as research point of view. For its positive characteristics juggling is even included in education curriculum of some European countries and is used in the school physical education as well as in other subjects.

Juggling is a motor activity that is not focused only on tossing and catching objects, but in general, it is defined as “*a dexterous manipulation with objects*”.

As mentioned above, juggling may be included in the area of psychomotor activities, as the emphasis is put on experience of movement, social aspects, coordination skills development etc. The aim of psychomotricity is the development of harmonious personality and it aims to gather as much information and experience about oneself as possible. Participants observe and experience their bodies, objects and props, they are using, as well as the surrounding environment. In psychomotricity tools, props and activities from various sports disciplines are used, such as movement and sports games, rhythmic and sports gymnastics, acrobatics, dance, mime, yoga, etc. Psychomotor tools are attractive, coloured and tempt the participants to play (Koprivova, 2003).

In juggling, one may focus on *different goals* - juggling as a hobby, juggling as a means of theatre presentation, juggling as a means of communication, relaxation in order to overcome daily stress or sports juggling focusing on the number of juggled objects. From the point of view of *education*, we may focus on different aspects of juggling - individual technique development, juggling in pairs, juggling in a group, juggling as a way of self-presentation, juggling as a means of communication for socially limited pupils, juggling as a means of stress reduction before another physically or psychically demanding activity etc.

### Use of juggling in persons with special needs

The experience within our pedagogical work at the Faculty of Sports Studies, Masaryk University, as well as the research results of our foreign colleagues have shown that juggling is highly usable and adjustable to a wide range of needs of various specific groups. We cooperate with the Department of Special Education where we teach juggling and its use to students who will work in leisure-time centres, special institutes for the disabled and social centres for socially disadvantaged people and ethnic minorities. However, juggling as a physical activity is very variable (according to age, motor skills level or physical handicap) and we may thus include it in the multidisciplinary science area of applied activities the goal of which is to improve the *quality of life* of persons with special needs. Application of any physical activity in persons with special needs is very individual, depending on the diagnosis, level of intellectual abilities and social experience. The aim of physical activities for pupils with special needs is to achieve the highest possible level of

physical fitness, dexterity and kinetic proficiency. Experience of pleasure of movement shall help these persons develop their personality on psychical and social level (Koprivova et al., 2003).

### Hearing impairment

By means of practical workshops we have been applying juggling and other psychomotor activities into work with hard of hearing and deaf students of the Department of Drama in Education for the Deaf, Janacek Academy. In case of the deaf students positive impact of juggling may be seen especially in the area of rhythmical skills development (emphasis on regular tossing and catching), development of attention, concentration and stage presentation. Via juggling skills the persons with hearing impairment may express their feelings, moods or they may serve as a communication means. Juggling may be also used as a means of coordination and balance development, which is a specifically problematic area of the deaf. We also cooperate with special primary schools for the deaf pupils where we present physical theatre and clown performances, followed by interactive juggling workshops. We are not able to communicate via sign language and juggling serves as a suitable communication means.

### Visual impairment

Within the university PE lessons and workshops in special schools we have applied juggling on pupils and students with visual impairment (particularly cases of diplopia and amblyopia). In these persons we have used coloured juggling scarves which are also highly suitable for children, seniors or generally, jugglers beginners as they fly slower than other juggling props and the manipulation is thus easier. In case of one female student of the Faculty of Education, juggling with scarves fully replaced juggling with balls and in juggling she found a new way of self-realization in the area of physical activities, which are otherwise uneasy to reach with her handicap.

### Physical handicap

Juggling as an applied physical activity may be used in persons with physical handicap as well. We experienced juggling with persons using wheel-chairs at the Social Care Institute Kociánka where we conducted a juggling workshop which proved that scarves and spinning plates are suitable in this case. As the levels of handicaps vary, we need to adjust the level of assistance in acquiring new juggling skills. While some persons with limited locomotion of lower limbs were capable of independent manipulation with juggling props, clients with symptoms of upper limbs spasticity needed the full assistance in spinning the plate which, however, they were able to hold for a while.

We have also applied juggling and psychomotor activities in a special institute for *seniors* (Picture 1) within a bachelor thesis research in the area of social pedagogy (Bendíková, 2011). Most of the seniors, who took part in this non-traditional psychomotor-movement program, were immobile and the seminars were thus adjusted, so that all the participants could sit on a chair. As we have already mentioned, juggling activities may be varied according to the participants' needs, the seniors could try out individual and group juggling with scarves, balloons or manipulation with newspaper balls as well. In seniors the positive impacts of juggling may be emphasized especially in the area of coordination skills development, fine motricity and psyche, especially in the area of self-concept, self-trust and experiencing.



Picture 1. Juggling in seniors

### Specific learning and behaviour disorders, ADHD

For our dissertation research experiment we have chosen a group of adolescents with syndromes of ADHD, hyperactivity and behaviour and learning disorders (Picture 2). We applied juggling and psychomotor activities in order to develop attention, reaction speed and coordination in these pupils and to point out the importance of the alternative motor activities that focus on the experience and joy of movement, in contrast to activities emphasising only the physical

condition improvement. Based on the research results (Trávníková, 2008) we shall recommend juggling activities as a suitable physical activity in persons with the above mentioned disorders. Juggling in this case represents a relaxation means, source of motivation and a desire to outdo the others. Therefore, it supports healthy competitiveness in a group. It is recommendable to combine solo juggling with the group form in order to develop the personality both individually and as a part of the group. It is necessary to switch between activities often enough and we do not recommend to focus only on the technique, i.e. on a mere drill of juggling tricks. In persons with attention disorders juggling indoors have appeared as a more effective form as in the outdoor conditions many attention disturbing elements occur (surrounding area, weather-wind). Last but not least, we recommend to motivate the group via a final juggling skills presentation for parents and teachers, which supports the teamwork of the group and positive self-evaluation of every single pupil.



Picture 2. Juggling with pupils with ADHD

### Mental handicap

Moreover, we can recommend juggling and psychomotor activities in mentally-handicapped children as results of our intervention program in one of special schools of Brno (CZ) have shown. Similarly to the above mentioned types of handicap, the extent of handicap and thus motor skills level is significant for specific adjustments of the lessons. In these persons we especially focus on the impact of juggling on coordination and socialization. We can also mention our positive experience of juggling (spinning a plate in particular) in a pupil suffering from the Down Syndrom.

### Conclusion

Based on these results and experiences we believe that juggling will be used even more in the are of leisure-time activities of persons with various handicaps and will be presented as a received part of applied physical activities system.

### References

1. Bendíková, L. *Use of psychomotricity and juggling activities in seniors*. Bachelor thesis. Brno: Faculty of Education, Masaryk university. 2011.
2. Kopřivová, J. *Psychomotorics – Textbook*. Brno: Paido. 2003. ISBN 80-7315-066-2
3. Kopřivová, J., Pipeková, J. *Physical Educational Activities in Relationship to Individual Types of Handicaps*. Brno: Paido. 2003. ISBN 80-7315-067-0
4. Trávníková, D. *Juggling*. Brno: FspS, MU. 2008. ISBN 978-80-210-4587-3
5. Trávníková, D. *The Impact of Juggling and Other Psychomotor Activities on Development of Motor Skills and Attention in Adolescents with symptoms of ADHD and behaviour and learning disorders*. Dissertation. FspS, MU, Brno. 2008.

## MIRROR BOX THERAPY FOR STROKE SURVIVORS: A NEW WAY TO VISUALIZE MOVEMENTS

Raphael Béné, Iris Zavoreo and Vida Demarin

*University Department of Neurology, Sestre milosrdnice University Hospital, Reference Center for Neurovascular Disorders of the Ministry of Health and Social Welfare of the Republic of Croatia, Zagreb, Croatia*

### Purpose

Mirror illusion means that standing in front of a mirror placed in sagittal plane, with the head tilted on one side and one arm stretched forward, one side of the body is reflected as if it were the other side by mirror visual feedback. The aim of this study was to monitor blood flow changes in middle cerebral artery (MCA) by use of transcranial Doppler (TCD) in individuals during motor tasks and tasks using mirror visual feedback.

### Methods

Eight young healthy volunteers (four male and four female) were included in the study. TCD recording in MCA was done during each task consisting of various motor and visuomotor activities using mirror illusion. Both MCA mean blood flow velocity (MBFV) was measured while the subjects were seated in a comfortable chair. The MCA MBFV recordings are presented as baseline values.

### Results and discussion

During the illusion of motor hand activation, when the subject was making right hand flexions and watching its reflection in the mirror, with the left hand immobile, an increase was observed the contralateral MCA MBFV (task 3, +4.5% baseline value;  $P=0.017$ ). Furthermore, when the subject made left hand flexions while watching the reflection of the immobile right hand in the mirror, there was an increase in the right MCA MBFV (+5.6% baseline value;  $P=0.044$ ), which was more pronounced than during the illusion of motor hand activation (task 3) and less than during direct vision of hand flexion (task 2, +6.3% baseline value;  $P=0.005$ ).

### Conclusions

Our data showed that visual illusion of action, as well as direct action observation could increase the MCA MBFV, showing that mirror illusion is a powerful tool for visualization of a movement which brings forward the possible usage of mirror illusion in motor neurorehabilitation.



## DOES CERTAIN SOCIODEMOGRAPHIC FEATURES INFLUENCE THE FREQUENCY OF EXERCISING IN PATIENTS WITH ANKYLOSING SPONDYLITIS?

Frane Grubišić<sup>1</sup>, Damjan Radulović<sup>2</sup>, Mario Bagat<sup>3</sup> and Josip Kovačević<sup>4</sup>

<sup>1</sup>Department of Rheumatology, Physical Medicine and Rehabilitation, Referral Center for the Spondyloarthropathies, Ministry of Health and Social Welfare of the Republic of Croatia, University Hospital Sestre Milosrdnice, Zagreb, Croatia

<sup>2</sup>Faculty of Kinesiology, University of Zagreb, Croatia

<sup>3</sup>Croatian Institute for Health Insurance, Zagreb, Croatia

<sup>4</sup>School of Medicine, University of Zagreb, Zagreb, Croatia

### Background

Kinesitherapy represents an important segment of the rehabilitation of patients with ankylosing spondylitis. It is directed toward the maintenance and improvement of the function of spine, thoracic cavity and prevention of joint deformities/contractures.

### Purpose

To determine the correlation between certain sociodemographic features and frequency of exercising in patients with ankylosing spondylitis.

### Study design

Observational-study.

### Methods

Fifty-seven patients diagnosed with ankylosing spondylitis, according to the modified 1984 New York criteria, are enrolled in this study. Structured questionnaire containing following socio-demographic data is used in this study: data on gender, age, age of disease onset, disease duration, level of education, working status and frequency of exercising. Statistical analysis included methods of descriptive statistics and Pearson correlation coefficient.

### Results

Fifty-seven patients (36 men, 21 women) are enrolled in the study. Mean age of patients was 52,9±9.78 years (men 52.5±10.97 years, women 53.7±7.58 years). Average age of the disease onset was 29.3±8.8 years (men 28±8.1 years, women 31.6±9.7 years). Average disease duration was 22.1±9.1 years (men 24.5±12 years, women 23.6±11 years). Level of education: 12 patients have some school education, 37 patients finished high school, 1 patient has some college, 1 patient graduated from the university. 24 patients work full time, 5 patients work partial time, 26 patient are unemployed and none of them is retired. As for the frequency of exercise programmes: 23/57 patients exercise regularly on a daily basis, 7/57 patients exercise on a weekly basis and 27/57 patients exercise temporarily. Negative correlation is found between education level, working status, age of disease onset and frequency of exercising. Positive correlation (correlation is significant at the 0.05 level) is found between disease duration and frequency of exercising.

### Conclusions

Exercising regimes represents an important segment of rehabilitation among our patients. However, future education of patients with AS should comprise more specific information of the importance of exercising in all ankylosing spondylitis patients regardless the level of education, working status or age of disease onset.

## A CASE STUDY MODEL: THE ROLE OF KINESIO TAPE IN OPTIMALIZATION OF SHOULDER GIRDLE MOVEMENT STEREOTYPE OF VOLLEYBALL PLAYERS

**Dagmar Králová**

*Faculty of Sports Studies, Masaryk University, Department of Health Support*

### Introduction

In hyperkinesia in sportsmen, functional and structural changes occur that may have various physiological and biochemical deviations manifested by a different extent of movement limitation and soreness. Kinesio taping is a new therapeutic method from the field of physiotherapy that influences functional changes and contributes to modification of structural changes after a surgical or conservative treatment.

### Problem of joint movement optimalization

Kinesio tape influences the muscle tone through skin receptors. One of the application techniques is the muscle technique that influences adhesion and dislocation ability of individual layers of soft tissues that create space for blood flow through vessels. This process is essential for nutrition of soft tissues and mainly muscles that are not used economically. Insufficient muscle nutrition causes occurrence of functional disorders of the locomotor system and further also to disturbance of the movement stereotype. The pain is present only after its long-term continuation. Upon occurrence of pain, the treating of functional disorders is much more demanding and therefore prevention has become much more emphasized.

Empiric monitoring of the problem: There are very few studies clarifying the effect of kinesio tape application. Some studies underrate its effects, some overrate it. That is why we would like to elaborate further on this issue and to specify conditions under which the kinesio tape is the most efficient associate to the physiotherapist.

### Objectives

The objective of this study is to determine and compare the effect of three therapy modes to influence functional disorders of the shoulder girdle in volleyball players: application of the kinesio tape, physiotherapeutic treatment and combination of both aforementioned techniques.

### Methodology

The case study involves 3 volleyball players (2 female, 1 male) with sever ache in their shoulder girdles; they have only undergone its conservative treatment. For the research of the possibility to influence physiological and somatic condition of the sportsmen, 3 selected empirical quantitative methods will be used apart from the case study: EMG, thermovision cameras, kinesiologic examination of the locomotor system focused on the shoulder girdle. All probands will undergo introductory and result examination. Between these examinations, 6 sessions will take place (one session per week). The first proband will undergo the kinesio tape application which will last 5 days (2 days skin regeneration), a set of special physiotherapeutic techniques and a suitable selection of exercise will wait on the second proband, the third proband will undergo the combination of the two possibilities.

### Results and conclusion

All probands have subjectively confirmed decrease in ache of the problem areas. Results of objective examination methods have not been known yet. However, we believe that therapy will be most efficient in case of the third proband, where the effect of manual intervention of a physiotherapist will be prolonged using the kinesio tape application. Kinesio tape acts continually for 5 days, which means it repeatedly stimulates and inhibits selected muscles and therefore influences their connection into the movement stereotype. The effect will last longer in case of the first proband, but in our opinion, preceding stimulation of soft tissues is insufficient in the therapy. On the other hand, the second proband has insufficient prolongation of the effect after the preceding stimulation of soft tissues.

**Key words:** *kinesio taping, functional disorder, movement stereotype, shoulder girdle, special techniques of physiotherapy*





# Biology and Medicine of Sport and Exercise

**6<sup>th</sup> INTERNATIONAL  
SCIENTIFIC  
CONFERENCE ON  
KINESIOLOGY**

**Editors:**

**Prof. Branka Matković, PhD  
Prof. Marjeta Mišigoj-Duraković, MD, PhD**

**“INTEGRATIVE POWER OF  
KINESIOLOGY”**

**Peer Reviewers:**

**Prof. Jan Borms, PhD  
Prof. Marjeta Mišigoj-Duraković, MD, PhD  
Prof. Branka Matković, PhD  
Prof. Lana Ružić, PhD  
Prof. Saša Janković, MD, PhD  
Marija Rakovac, MD, PhD  
Maroje Sorić, MD, PhD**



**Secretary:  
Maroje Sorić, MD, PhD**

## LEARNING LANDSCAPES: CONTEXTUAL RELATIONS BETWEEN ENVIRONMENTS, PHYSICAL ACTIVITY AND MOTOR LEARNING

**Ingunn Fjørtoft**

*Telemark University College, Notodden, Norway*

### Abstract

Reaching top results can no longer be imagined without recognition of psychological dispositions of athletes. The research aim is to determine relationship between extroversion and sports performance of young swimmers. The research included 135 swimmers, from 9 to 16 years old. This research used Eysenck personality test and a questionnaire for evaluation of athletes success. The results indicate that extroverted children swimmers do better than introverted children. From the total sample in relation to sports success criteria extraverts have 42.1% and they belong to a group of successful swimmers, while introverts are 27.7%. Keeping in mind many dimensions of these traits, and if we consider social character of sport involvement, it is logical to expect that the sport is dominated by people who have expressed extravert orientation. Results showed that extroverted children swimmers have better results than introverted children.

**Key words:** *correlations, personality traits, sport performance*

Motor learning is considered to be the most fundamental of all learning in children. Children learn movements and gain bodily experiences by exploring different environments. Through bodily experiments children explore details and quality of movements such as speed, agility, force, and weight (Sheet-Jonstone, 1999). Motor learning is not a process of maturation, but a process of learning through experiences and activities and several studies indicate that motor learning is of profound importance to development of other areas such as cognition, socialization, emotional and psychological competence (Hopkins & Butterworth, 1997; Sheet-Johnstone, 1999; Thelen & Smith 1994).

Most definitions of learning are based on the process of behaviour, which manifests itself by adaptive changes in behaviour as a result of experience and development of responses to aspect of the environment. Dudai (1995, pp. 6-7) has redefined the notion on learning as follows:

*“...learning is here defined as an experience-dependent generation of enduring internal representations, and/or experience-dependent lasting modifications in such representations.*

*“Ending” and “lasting” mean at least a few seconds, but in most cases much longer, and in some cases up to a lifetime. Retrieval is use of memory in neural and behavioural operations.*

*.....The neurobiology of learning investigates the neuronal substrates that are expected to subservise internal representations, and specifically experience-dependent modifications in these substrates”.*

Learning and development is synonymous concepts in the way that learning leads to development where development of behaviour and internal representations are results of learning (Dudai, 1995). Learning and development are thus processes that are dependent on experience.

Dynamic Systems Approach to the development of motor behaviour (Thelen & Smith, 1994; Vereijken & Bongaardt, 1999) put attention to the total development of motor abilities of the child. That means the biological abilities the child has to learn motor skills, the tasks to learn and the environment in which the child learns and develops (Newell, 1986, Figure 1). The road to skilled movement acquisition is a proficient balance between too many and too few degrees of freedom as explained by Bernstein (1967). The child will adapt itself to any learning situation in order to obtain control.

Through the stages of elimination, exploration and exploitation of degrees of freedom, the child will adapt to the skill being controlled and to the context in which the skill is performed. A complex learning environment may provide children a diversity of tasks, which will challenge the selection, the coupling, and the exploitation of degrees of freedom that will promote motor skills in young children. The physical environment as an important determinant for promotion of fundamental motor skills in young children will be explained in this paper.

### Which motor skills should be promoted in preschool children?

Children develop perceptual-motor skills through natural spontaneous interaction with the environment. They seek out stimulation and physically explore, discover, and evaluate the environment in relation to themselves (Jambor, 1990).

Such skills are generally named basic motor skills or basic movements and typically comprise locomotion (e.g., rolling, crawling, climbing, jumping, hurdling, hopping, running, walking, pulling, pushing, throwing). The context in which those skills are performed will imply movement qualities of co-ordination and balance, perception of body and space, rhythm and temporal awareness, rebound and airborne movements, projection and reception of movement. The perceptual and motor information the child establishes by performing such skills in complex environments enable the child to develop responses adaptable to challenging movement situations (Fjørtoft 2000a, 2004, Fjørtoft & Gundersen, 2007).

### Learning through landscapes

The didactic approach to basic skills acquisition is that of “learning through landscapes” where the terrain is the facilitator for diverse movements that challenge motor behaviour and where the tasks are conditioned to any individual qualification. Landscapes can be the outdoors as well as the indoors. The model below shows the connection between learning environments, physical activity and motor development.

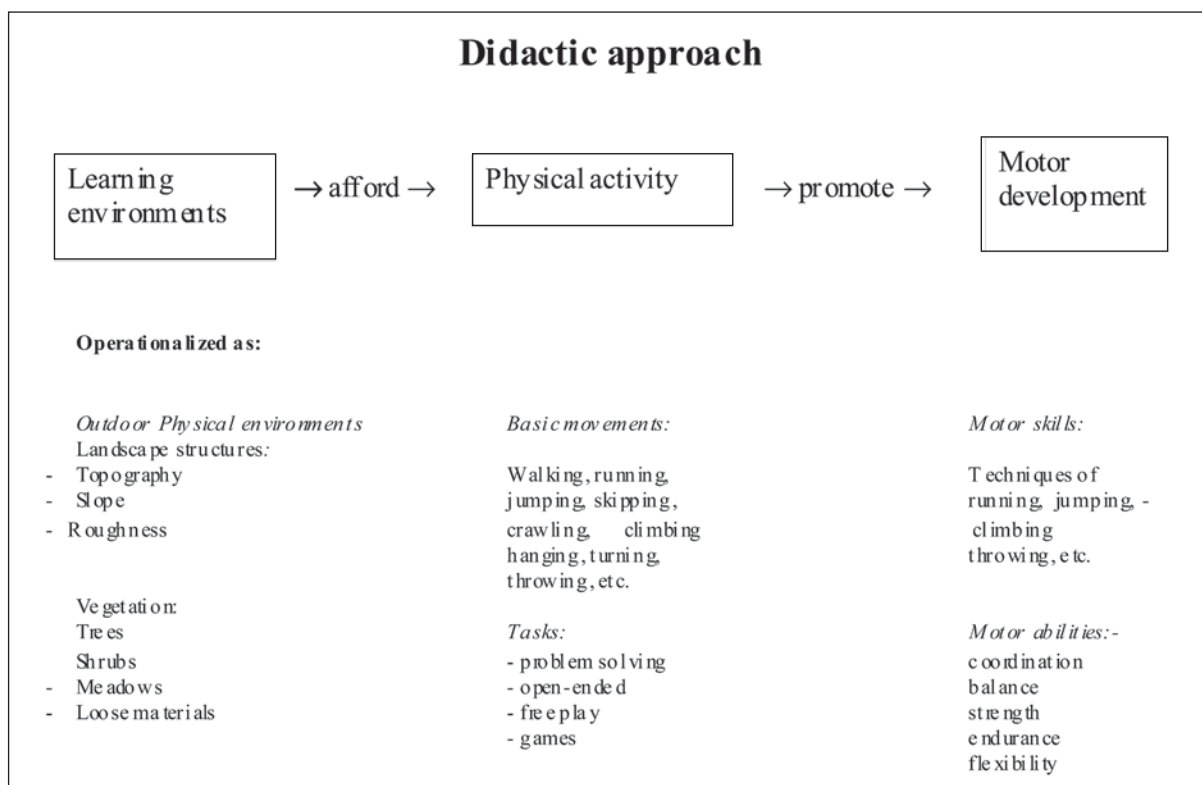

Learning environments afford physical activity, which in turn promote motor development. To promote motor development and achieve motor skills it is crucial that determinants for learning environments and physical activity are adequate for the given purposes. In outdoor environments, such determinants are described as topography and vegetation.

The topography could be flat, sloping, hilly, steep and/or rocky. The vegetation represents a variety of plant sociology that represents diversity in vegetation units. Physiognomy of the vegetation represents the structure of different plants, for example the branching of a tree and the density of shrubs. Loose materials are sticks, branches, logs, leaves, cones, stones, etc. The outdoor environment changes over time and with seasons. The winter season may afford a lot of challenging activities on snow and ice.

Frost (1992) described childrens playscapes as any landscape where children play. Children perceive environments as functions; functions to move, functions to build, functions to hide, to play etc. Physical environments afford such challenges to children in different ways, and the more diverse the more challenging. The “Theory of Affordances” (Gibson, 1979) describes the affordances of landscapes as the options and functions they provide an individual according to what the individual perceives of landscape bids. Children perceive and interpret such offers as functions to play and they operationalized the affordances into action. For example, a properly branched tree will be perceived by the child as “climbable”, it affords climbing on, and the child will intuitively climb it. A shrub vegetation may be perceived as a site for constructing a den, or suitable for role-play like play house. Fjørtoft and Sageie (2000) describe children’s play in natural playscapes whereby landscape characters and qualities correspond to children’s use of landscape features. Children’s play in complex natural environment showed significant effects on their motor development and fitness acquisition (Fjørtoft 2000a).

## The children's favourites

There were some specific spots in the forest that the children named and used more frequently. Those were “the cone war”, “the space ship” and “the steep slope”. The names indicate the activities taking place there and it is an expression of the characters that free play takes when stimulated by the functional affordances of a natural environment. Cones are fit for throwing - whatever the target is, and appeal to functional play and battling. The “space ship” is a rock underneath the cliff, and affords functional and fantasy play. These two places are located close to the kindergarten in a coniferous forest. The landscape structure and the function of the vegetation encourage the activities taking place there. The steep slope afforded sliding in the winter and nature studies in the summer as the steep slope turns into a hill of mosses.

Natural environments afford many opportunities to children for free play and physical activity. The affordances of a landscape constitute landscape characters as determinants for children's play and physical activity. Children interpret the landscape structures as functions: the function to climb, to slide, to hide, to run, and throw. For example, the affordances of climbing are the trees and the rocks, which are to be climbed according to their structural constitution of branches, slope and projections. Such structural determinants constitute functional affordances as they challenge activities that develop climbing skills in children. The structure of trees promoted the development of unique climbing techniques.

Shrubs afford hiding-places, building dens, role-play and fantasy play. Even the Juniper bush invites the whole group of children into its branches for fantasy play. The children are happily exploring the environment and the affordances of the Juniper bush. Typically, boys are more vigorous in their outdoor play than girls, and given the opportunity, they seek extreme challenges.

Outdoor unstructured environments naturally afford unlimited challenges to children's play. Learning situations should allow the learner to explore and eventually exploit relevant degrees of freedom as explained by Vereijken and Bongart (1999). The physical environment affords the children to explore degrees of freedom by climbing the swinging lianas as well as the boy to exploit the possibilities of making a backward swing. The environment affords a diversity of movement solutions, achieved both by reducing degrees of freedom by holding on to the branches to obtain control, as well as eliminating degrees of freedom in order to exploit control.

Other natural environments afford activities typically determined by their structures. For example, meadows promote vigorous activities such as running, jumping, tumbling, and other acrobatics. Logs, stumps and stones constitute obstacles that challenge motor control in many ways, while loose materials afford construction materials and things to throw.

## Learning effects

Diverse natural environments support richer play behaviour and motor development in young children. A Norwegian study on natural playgrounds (Fjortoft, 2000a,b, 2001) described natural environments as diverse and challenging play habitats for children. Natural landscapes

afforded more diverse play forms and promoted more physical play behaviour in the children. A quasi-experimental study was conducted on 5-6- and 7-year-old children in two playgrounds. The experimental group (n=46) played in a natural environment 1-2 hours every day when they attended kindergarten. The natural environment was a forest close to the kindergarten, where the landscape, the topography and vegetation constituted the arena for all-round physical play. The reference group (N=29), equal to the experimental group in age and socio-economic conditions, attended normal playground activities. Both groups were tested using the EUROFIT motor fitness test before and after the intervention period of 9 months. The experimental group showed significant improvement ( $P < .05$ ) in most of the test items compared to the reference group. The intervention effect was typically more prominent in balance and coordinative skills. The full time kindergarten experimental groups clearly achieved better results. The study indicated that the natural environment is a stimulating arena for mastering and learning of motor skills in young children. In another Norwegian study, focusing on the importance of physical activity in childhood (Mjaavatn et al., 2003), 80 Norwegian children representing 3 different schools were followed closely from grade 1 (6-year-old) to grade 4 (9-year-old). The results showed that a high level of physical activity during this phase of childhood is associated with higher score on the physical fitness test, higher score on the gross motor test, lower BMI, and less time spent on viewing television.

## Learning landscapes

Landscapes are potential playscapes and learning areas for the children, but there are some basic criteria that should be fulfilled to meet the children's needs for environments suitable for play and learning. Such criteria are first of all the children's need for versatile and free play; and very essential in the children's play is the mobility and grossmotor activities (Fjortoft & Gundersen, 2007). With reference to the dynamic system theory (Thelen & Smith, 1994; Vereijken & Bongart, 1999) new motor skills are a reorganization of previously mastered skills that lead to more effective ways of exploring and controlling the environment. Accordingly the physical environment should be challenging and stimulate the children to explore and master such environments.

The present paper is an attempt to discuss how the natural environment can be a stimulating playscape that meets the children's needs for exploring, mastering and controlling the environment. In the interpretation of the landscape ecology characters into playscapes for children, we have focused on the affordances of the landscape for versatile play. This is exemplified through the use of the activity arenas that are the places in the forest that the children used most frequently in relation to different seasons of the year. Natural environments should be more appreciated and explored as stimulating learning landscapes for children's motor development.

## References

1. Bernstein, N. (1967). *The co-ordination and regulation of movement*. London: Pergamon Press.
2. Dudai, Y. 1995. *The Neurobiology of Memory. Concepts, Findings, Trends*. Oxford: University Press.
3. Gibson, J. (1979). *The Ecological Approach to Visual Perception*. Boston: Houghton Mifflin Company.
4. Fjørtoft, I. (2000a). *Landscape as Playscape. Learning effects from playing in a natural environment on motor development in children*. Doctoral Dissertation. Oslo: Norwegian University of Sport and Physical Education.
5. Fjørtoft, I. (2000b). *Motor Fitness in Pre-Primary School Children: The EUROFIT Motor Fitness Test Explored on 5-7-Year-Old Children*. *Pediatric Exercise Science*, 12, 424-436.
6. Fjørtoft, I. (2001). *The Natural Environment as a Playground for Children: The Impact of Outdoor Play Activities in Pre-Primary School Children*. *Early Childhood Education Journal*, 29(2), 111-117.
7. Fjørtoft, I. (2004). *Landscape as Playscape. The effect of natural environments on children's play and motor development*. *Children, Youth and Environments*, 14(2). <http://www.colorado.edu/journals/cye/>
8. Fjørtoft, I., & Sageie, J. (2000). *The natural environment as a playground for children – Landscape description and analyses of a natural playscape*. *Landscape and Urban Planning*, 48, 83-97.
9. Fjørtoft, I. & Gundersen, K.A. (2007). *Promoting Motor Learning in Young Children Through Landscapes*. In: Liukkonen, J. et al. (eds.) *Psychology for Physical Educators (2<sup>nd</sup> Ed.)*. Champaign, IL: Human Kinetics.
10. Frost, J.L. (1992). *Play and Playscapes*, New York: Delmar Publishers Inc. Hopkins, B., & Butterworth, G. (1997). *Dynamical systems approaches to the development of action*. In: G. Bremner, A. Slater & G. Butterworth (Eds.). *Infant development: Recent advances* (p. 75-100). ast ussex: Psychology Press.
11. Jambor, T. (1990). *Promoting perceptual- Motor Development in Young Children's Play*. in: Wortham, S.C. and Frost, J.L.: *Playgrounds for Young Children: National Survey and Perspectives*. A Project of the Committee on Play, American Association for Leisure and Recreation. An Association of the American Alliance for Health, Physical Education, Recreation and Dance.
12. Mjaavatn, P.E., Gundersen, K.A., Segberg, U., & Bjørkelund, L.A. (2003). *Physical activity, Health and social skills in 6-9 year old Norwegian*. *Medicine & Science in Sports & Exercise*, 35(5), S63.
13. Newell, K.M. (1986). *Constraints on the development of coordination*. In: M.G. Wade and H.T.A. Whiting (eds.) *Motor development in children: Aspects of coordination and control* (pp. 341-360). Dordrecht: Martinus Nijhof.
14. Sheet-Johnstone, M. (1999). *The primacy of movement*. Amsterdam: John Benjamins Publishing Company.
15. Thelen, E., & Smith, L.B. (1994). *A dynamic systems approach to the development of condition and action*. Cambridge, Mass.: MIT Press.
16. Vereijken, B., & Bongart, R. (1999). *Complex Motor Skill Acquisition*. In: Y. Vanden Auwele, F. Bakker, S. Biddle, M. Durand, & R. Seiler (Eds.) *Psychology for Physical Educators*. Champaign, IL: Human Kinetics.



## NUTRITIONAL KNOWLEDGE AND DIETARY HABITS OF CROATIAN TENNIS COACHES

Petar Barbaros-Tudor, Ivan Radman and Gordan Janković

Faculty of Kinesiology, University of Zagreb, Croatia

### Abstract

Due to a specific bond between tennis coaches and their athletes, it often happens that coaches act as sport nutritionists as well. The purpose of this study was to determine nutritional knowledge of the Croatian tennis coaches and to investigate was there any relation between the level of nutritional knowledge and their dietary habits. The secondary purpose was to investigate the influence of coaches' supplementation and recommendations they gave to their athletes. The sample consisted of 58 test subjects, Croatian tennis coaches (50 male, 8 female; age  $33.3 \pm 10.8$  yrs). Data were collected using the method of written questionnaires. Questions were classified regarding the importance of a particular question for the profession of a sports coach in three categories: *basic knowledge*, *advisable knowledge* and *advanced knowledge*. Total percentage of correct answers was 68.9%, with the highest percentage, as expected, in the category *basic knowledge* (79.4%). However, as the level of question difficulty increased, the number of correct answers decreased by 14% in each category, indicating a linear decline of knowledge (*advisable knowledge* 65.4%, *advanced knowledge* 51.4% of correct answers). This research determined that 37.9% of coaches used dietary supplements and they had a better nutritional knowledge than those who did not use supplements (72.9% vs. 66.4%). Chi-square test showed that listed group had significantly better knowledge on the questions relating to special effect of some food on weight loss ( $p=0.03$ ), unsaturated fatty acids ( $p=0.02$ ), exercising and fasting ( $p<0.001$ ), potassium consisting food ( $p=0.01$ ), recommended daily carbohydrates intake ( $p=0.04$ ) and synthesizing of D vitamin ( $p=0.02$ ). In variables which describe whether athletes led by examined coaches use particular dietary supplement, chi square test determinates highly significant differences between the groups of coaches who use and who do not use vitamins ( $p<0.001$ ), minerals ( $p<0.001$ ) and proteins ( $p<0.001$ ). The results lead to the conclusion that the questioned coaches do well with regard to the basic nutritional knowledge; however, if they are to be more efficient, they should expand their knowledge. The results also corroborate the assumption that, due to tennis coaches' close relationship with their athletes, they relate their own and players' needs for dietary supplementation.

**Key words:** diet, tennis, nutritional knowledge

### Introduction

A current level of technology used in sports preparation of tennis female and male players has greatly improved, not only in its quality but also in its comprehensiveness. All aspects of sports preparation are carefully addressed to ensure a continued optimal performance in competitions. One of the requirements relevant not only for competition achievements but also for athletes' health is a correct, targeted, balanced diet and hydration implemented from the very beginning till the end of athletes' career. Due to the uncertainty of competition dates and schedules (greatly dependant on athlete's health and performance, i.e. his/her ranking), specifically high tempo of tennis matches as well as constant travelling through different time zones, it is significant for a player to maintain an adequate rhythm of proper nutrition. That is ensured by an appropriate intake of nutrients which enable athlete's organism to be in a state of continued preparedness for training practice and competition. Many authors (Ruka, et al., 2005; Lacey & Prichett, 2003) have accentuated importance of proper diets and point out the care about athlete's dietary habits as an indispensable element of any sports preparation program. Even though most coaches are acquainted with the basics of sports nutrition through the course of their education at various institutions, many previous studies have documented alarmingly low knowledge of fundamental issues regarding sports nutrition. For example, one study (Smith-Rockwell, et al., 2001) tested university coaches in the USA and obtained 67.0% correct answers, whereas New Zealand rugby coaches, according to the Zinn and colleagues (2006), answered correctly to only 55.6% of questions regarding sports nutrition. Another previous research (Juzwiak & Ancona-Lopez, 2004) also showed that some coaches, despite their own inadequate knowledge, had no inhibitions in giving dietary recommendations to their athletes. Therefore, even though supplying nutrition recommendations is a part of coaches' jobs, it is legitimate to doubt their competence in taking care of athletes' nutrition, especially in such complex living conditions like those in tennis. For all these reasons, the primary goal and purpose of the current study was to ascertain the nutritional knowledge of Croatian tennis coaches and, secondary, to determine whether there is any relation between the level of their knowledge and their dietary habits.

## Methods

The sample consisted of 58 subjects, Croatian tennis coaches (50 males, 8 females) attending a seminar necessary for the renewal of their coaching license, which was organized by the Croatian Tennis Coaches Assembly and the Croatian Tennis Association. The average age of the subjects was  $33.3 \pm 10.8$  years. After the subjects had completed their regular professional training at the Croatian Tennis Academy, they were acquainted with the aim of this research and received detailed instructions on how to fill in the questionnaire. All of them volunteered to participate in the study.

A questionnaire used to collect data was comprised of questions regarding nutritional knowledge and dietary habits; its construction was based on the previous research conducted at the Faculty of Kinesiology in Zagreb (Sorić, et al., 2006) as well as on several international studies (Conkle & Tischler, 1992; Parmenter & Wardle, 1999; Turconi, et al., 2003; Paugh, 2005). The questionnaire was created to assess coaches' knowledge about the following: nutrition in general, indispensable nutrients that ensure sufficient energy for an athlete during training sessions and competitions, dietary supplements, meals before training sessions and competitions, meals during recovery, the importance of liquids, and about dehydration and rehydration during training sessions and competitions. Dietary habits were determined upon the subjects' answers to the questions regarding the number of meals consumed per day, then whether they skip meals, which kinds of food from the different parts of the food pyramid do they consume, how do they take liquids, sport beverages and dietary supplements, with a special focus on the specific supplements their athletes use.

The 40-statement-part of the questionnaire that deals with sports nutrition knowledge was classified regarding the *importance of the statement for the profession of a sports coach*. Three experts in the field of nutrition and metabolism assessed independently the statements and placed them in three categories: 1. *Basic knowledge* – the knowledge of minimum basic nutrition principles every sport educator must be familiar with in order to be able to perform his/her profession (16 statements), 2. *Advisable knowledge* – regards the nutritional principles a sport educator should know in order to perform successfully in his/her profession and have an educational effect on an athlete or a person involved in recreational sport (18 statements), 3. *Advanced knowledge* – would be beneficial principles for a sport educator to know them; however, they are not essential for his/her work with an athlete or a person involved in recreational sport. The second part of the questionnaire consisted of 18 questions dealing with coaches' dietary habits.

Collected data were processed using the software package STATISTICA FOR WINDOWS VER. 9.0. To analyse 40 statements related to nutrition knowledge descriptive statistics was used (arithmetic mean, standard deviation, minimum and maximum values), frequencies and percentages of correct answers for each question. The differences between coaches who used dietary supplements and those who did not (the criterion variable) in nutritional knowledge and variables which describes their athletes' use of dietary supplements were determined by *chi-square* test for independent samples.

## Results and discussion

Questionnaire result analysis showed a total of 68.9% correct answers. That percentage statistically falls within the results obtained in other studies (Smith-Rockwell, et al., 2001; Zinn, et al., 2006) about nutritional knowledge of coaches of various profiles. When results are analysed across the three nutritional knowledge categories (*basic*, *advisable* and *advanced knowledge*), the highest percentage of correct answers was, as expected, obtained for the group of basic knowledge (79.4%). It suggests the Croatian tennis coaches are capable of providing their athletes with concrete answers regarding basic nutrition, hydration and rehydration questions. The frequency of correct answers was considerably lower for the group of questions regarding knowledge that would ensure better coaching performance. If correct answer percentages across all the three categories are viewed, a constant decline becomes noticeable (Table 1). Namely, as the level of question difficulty increased, the number of correct answers decreased by 14% in each category, indicating a linear decline of knowledge.

Table 1. Percentage (%) of coaches' correct answers grouped into importance categories

CATEGORY	% of correct answers
Basic knowledge	79.4
Advisable knowledge	65.4
Advanced knowledge	51.4

This research showed that 37.9% of subjects used dietary supplements. Coaches who used to consume supplements had higher percentage of overall correct answers than those who did not (72.9% vs. 66.4%). Furthermore, chi-square test revealed that the coaches who used nutritional supplements had significantly better nutritional knowledge on 6 questions. They observed more successfully that some foods have special effect on weight loss due to their fat burning characteristics. ( $p=0.03$ ), and also understand better desirability of unsaturated fatty acids ( $p=0.02$ ). Trainers who use supplements are

more aware of fact that exercising and fasting can lead to hypoglycemia ( $p < 0.001$ ) and that is recommended to base the sport nutrition on carbohydrates, i.e. to make 55-65% of daily energy supplies from carbohydrates intake ( $p = 0.04$ ). The same group is better informed about amount of potassium in bananas and potatoes ( $p = 0.01$ ) as well as about synthesizing of Vitamine D in the skin with the help of Sun ( $p = 0.02$ ). This suggests more than a third of the tested coaches who show a tendency to use dietary supplements also demonstrate greater commitment to enhance their sports nutritional knowledge. At the issue in which coaches declared if their athlete uses dietary supplements, of the 23 coaches who take supplements 18 of them responded positively, while 29 of 36 trainers who were not taking supplements reported negation for their athletes. According to the criterion of supplements use Chi square test confirmed a significant level of differentiation between the two groups of investigated coaches within answers whether their athlete takes nutritional supplements. ( $p < 0.001$ ) From the listed, we can conclude that there is an obvious correlation between coaches' consumption of dietary supplements and reported supplements consumption for athletes. This relation is well depicted in a virtually identical use frequency of different types of dietary supplements (Table 2). Even more, chi square test found a statistically significant distinction between the group of coaches who use and who do not use a particular type of supplement in variables (questions) which were used to describe whether their athlete uses the listed supplement. (Table 3) Founded differences between the coaches' groups suggests a congruence of particular nutritional supplements kinds used within the surveyed tennis trainers and their athletes. This leads to the conclusion that almost all subjects advised their athletes to use the same supplements they used themselves.

Table 2. Types of supplements used in coaches' diets and in their athletes' diets, depicted with frequencies and percentages (%)

	VITAMINS		MINERALS		PROTEINS		CARNITINE	
	No.	%	No.	%	No.	%	No.	%
Coaches	23	39.65	16	27.58	10	17.24	2	3.44
Athletes	23	39.65	17	29.31	10	17.24	1	1.72

Table 3.  $\chi^2$  results for the differences between groups of coaches who used particular type of dietary supplement in variables which describe athlete's use of the same (listed) supplement.

	Coaches who use listed nutritional supplement		Coaches who do not use listed nutritional supplement		p
	No.	%	No.	%	
Athlete uses vitamins	23	39.66	35	60.34	0.00
Athlete uses minerals	17	29.31	41	70.69	0.00
Athlete uses proteins	10	17.24	48	82.76	0.00
Athlete uses carnitine	1	0.02	57	99.98	0.85

Since professional tennis players lack continued nutritionist care, tennis coaches often undertake this task. This is particularly true for coaches working with younger age categories when healthy nutritional and hydration habits must be formed. It is common knowledge that coaches and their players interact for many hours on a daily basis, particularly when competing away. Consequently, players adopt their nutritional knowledge mainly from their tennis coaches. This has been established in previous studies, which show that coaches are athletes' main nutritional information source (Burns, et al., 2004; Jacobsson, et al., 2001). Given the specific omnipresence of tennis coaches in their protégées' lives, and a general fact that young athletes do not perceive their coaches solely as an authority but also as role-models, the indirect effect of coaches' life-style and dietary habits on their athletes is great.

## Conclusion

From the findings obtained in the current research the Croatian tennis coaches' basic nutritional knowledge can be evaluated as good. Despite good results in the category of *basic knowledge*, a lower percentage of correct answers in the categories of *advisable knowledge* and *advanced knowledge* must be noted. Improvement in these categories could ensure more efficient training effects and further coaching successfulness of the subjects. Results indicate more than a third of the coaches used dietary supplements and the same coaches also had a greater commitment to enhancing their sports nutritional knowledge than the rest of their colleagues. The coaches who do show interest to expand their knowledge in sports nutrition would find it beneficial to further their knowledge towards levels of *advisable* and *advanced knowledge* in more ways than one since the results show a significant correlation between the subjects' use of dietary supplements

and that of their athletes. Even though there was no significant correlation between coaches' nutritional knowledge and their dietary habits, it is common knowledge that positive habits of coaches underpin the adoption of same habits in their athletes.

## References

1. Burns, R.D., Schiller, R., Merrick, M.A., & Wolf, K.N. (2004). Intercollegiate student athlete use of nutritional supplements and the role of athletic trainers and dietitians in nutrition counseling. *Journal of the American Dietetic Association*, 104, 246-249.
2. Conkle, T.H., & Tishler, A.G. (1992). Sports nutrition knowledge assessment of physical educators and coaches. *Annual meeting of the Mid-South Educational Research Association* (pp. 11-13); Knoxville, Tennessee.
3. Jacobson, B.H., Sobonya, C., & Ransone, J. (2001). Nutrition practices and knowledge of college varsity athletes: a follow-up. *Journal of Strength and Conditioning Research*, 15(1), 63-68.
4. Juzwiak, C.R., & Ancona-Lopez, F. (2004). Evaluation of nutrition knowledge and dietary recommendations by coaches of adolescent Brazilian athletes. *International Journal of Sport Nutrition & Exercise Metabolism*, 14(2), 222-235.
5. Lacey, K., & Prichett, E. (2003). Nutrition Care Process and Model. ADA adopts road map to quality care and outcomes management. *Journal of the American Dietetic Association*, 103, 1061-1072.
6. Parmenter, K., & Wardle, J. (1999). Development of a Nutrition Knowledge Questionnaire. *European Journal of Clinical Nutrition*, 53, 98-308.
7. Paugh, S.L. (2005). *Dietary habits and nutritional knowledge of college athletes*. (Thesis). California: California University of Pennsylvania.
8. Ruka, S., Toyama, K., Amamoto, R., Liu, C.H., & Shinfuku, N. (2005). Nutritional knowledge, food habits and health attitude of Chinese university students – a cross sectional study. *Journal of Nutrition*, 4, 1475-1480.
9. Sorić, M., Mišigoj-Duraković, M., & Pedišić, Ž. (2006). Prehrambene navike i prevalencija pušenja u sportaša ekipnih sportova. *Hrvatski športskomedicinski vjesnik*, 21(2), 83-89.
10. Turconi, G., Celsa, M., Rezzani, C., Biino, G., Sartirana, M.A., & Roggi, C. (2003). Reliability of a dietary questionnaire on food habits, eating behaviour and nutritional knowledge of adolescents. *European Journal of Clinical Nutrition*, 57, 753-763.
11. Smith-Rockwell, M., Nickols-Richardson, S.M., & Thye, F.W. (2001). Nutrition knowledge, opinions, and practices of coaches and athletic trainers at a Division I university. *International Journal of Sport Nutrition & Exercise Metabolism*, 11(2), 174-185.
12. Zinn, C., Schofield, G., & Wall, C. (2006). Evaluation of sports nutrition knowledge of New Zealand premier club rugby coaches. *International Journal of Sport Nutrition & Exercise Metabolism*, 16(2), 214-225.

## NUTRITION KNOWLEDGE AND HABITS SURVEY AMONG STUDENTS OF SPORT FACULTIES OF ZAGREB AND BRATISLAVA

Vjekoslav Cigrovski, Branka Matković and Ivan Radman

*Faculty of Kinesiology, University of Zagreb, Croatia*

### Abstract

Among other, job of sport trainers and pedagogues includes giving dietary advice to young athletes. The primary aim of our research was to investigate the nutrition knowledge of students from Sport faculties in Zagreb and Bratislava. The secondary aim was to determine and compare the dietary habits of the two student groups as well as to examine the influence of nutrition knowledge on dietary habits. Data on nutrition knowledge and dietary habits was collected from 113 participants (58 from Croatia and 55 from Slovakia) through the use of 40-item questionnaire. Overall, 69 % of questions were correctly answered (69% by Croatian and 70% by Slovakian students). The highest percentage of correct answers was noticed in the questions related to carbohydrates (77%) and influence of nutrition on sport performance (75%). Students differed significantly in the knowledge on proteins (40% correct answers among students from Zagreb vs. 56% obtained from Slovakian students), where there was overall the lowest percentage of correct answers (48%). When results of  $\chi^2$  test are analyzed for the two groups of students differences were observed on 4 questions: eating breakfast ( $p=0.02$ ), skipping meals ( $p=0.03$ ), daily diet recording ( $p=0.03$ ) and consumption of minerals ( $p=0.02$ ). Students from Zagreb were more conscientious in diet recording, eating breakfast, while students from Bratislava less frequently skipped meals and consumed more minerals. In order to become better nutrition advisers sport students need to improve their own knowledge. This would best be achieved through more extensive university courses on nutrition and healthy habits.

**Key words:** *diet, healthy habits, questionnaire, young athlete*

### Introduction

Sports nutrition involves the application of eating strategies to promote health and adaptation to the training and performance during competition. The importance of nutrition in sport has widespread acceptance (Gilbert, 2009), especially during adolescence. Adolescents may have undesirable dietary practices, and often engage in unhealthy dieting, which may be related to inadequate nutrition knowledge. Previous studies suggested nutrition to be an important complement of physical fitness (Ruka et al., 2005). Nutritional needs for peak athletic performance include sufficient calorie intake, adequate hydration to timing of meals. Student athletes and their advisors are often misinformed about sports nutrition (Laurie et al., 2003; Nancy et al., 2005). Kinesiology students are a specific population due to demanding physical fitness program they are involved, and the fact they are educated to become trainers responsible for conveying nutrition knowledge and promotion of healthy habits. The nutrition knowledge of future dietary advisors is thus a very important aspect to investigate. Each sport activity imposes a great energy effort on an athlete. During a training cycle, athletes require high amount of energy to endure the physical stress. Sport success depends on the training and on factors such as nutrition (Lacey and Prichett, 2003), which if not well balanced, can have negative influence on sport results. However, in sporting circles nutrition knowledge and practices vary extremely (Gilbert, 2009). Research suggests that adolescent athlete is neither aware nor prepared for the demands of sound nutrition practices in general and those imposed by specific sport activity (Laurie et al., 2003). The dietary practices of young athlete fail to meet the energy requirements for high performance and may threaten well-being (Nancy et al., 2005). Moreover, dietary practices can be related to disease development and timely conducted education can help in preventing illnesses (Lissner, 1995). Research by Hackman et al. (1992) made evident that frequent injuries could be prevented if adequate nutrition and food supplements were used. Therefore, nutritionist would have to be a part of sporting organization in order to help athletes and coaches to develop and monitor strategies that work best for each individual, contributing to a positive outcome on performance, diagnosing nutrition pitfalls and intervening in healthy dietary habits. Unfortunately, only a small number of athletic clubs have a nutritionist. According to the many investigations, it seems that athletes depend on the nutrition information provided by the trainers (Burns et al., 2004). We wanted to investigate the level of nutrition knowledge and habits of students from Sport faculties in Zagreb and Bratislava, as they are a population of future coaches and pedagogues, who will be the primary nutrition knowledge providers for young athletes.

## Methods

Our research included sport students from Croatia and Slovakia. Overall 113 students of two Sport faculties participated; 58 were from Zagreb (39 male and 19 female), average age  $22.3 \pm 1.7$  years and 55 students from Bratislava (41 male and 14 female), average age  $22.1 \pm 1.4$  years. Average BMI of students from Zagreb was  $23.3 \text{ kg/m}^2$  while students from Bratislava had average BMI  $23.7 \text{ kg/m}^2$ . Students fulfilled an anonymous questionnaire prior to taking obligatory course Sports medicine, or facultative course Sport nutrition, thus the tested nutrition knowledge was based on the past education and information acquired through participation in different sport trainings and own interest in nutrition. For the purposes of this investigation a 3-part questionnaire was used; the first part identified demographics, and other two parts measured participant's nutrition knowledge and dietary habits. The questionnaire was constructed based on the previous international studies by Conkle and Tischler (1992), Parmenter and Wardle (1999), Turconi et al. (2003) and Paugh (2005). The questionnaire consisted of 40 nutrition knowledge questions, grouped into 7 categories testing specific knowledge on proteins, carbohydrates, fats, vitamins and minerals, hydration, diet and influence of nutrition on sport performance. Each participant could answer the question either affirmatively (true) or with a negation (false). Another part of the questionnaire consisted of 18 questions testing dietary habits. According to the qualitatively more desirable habit, answers were graduated on a scale one to four. The collected data was analyzed by "SPSS for Windows 14.0". For nutrition knowledge questions descriptive statistics was calculated. Between the groups differences on each variable were tested by  $\chi^2$  test, which was also used to analyze the differences in the dietary habits. Results were considered significant with  $p < 0.05$ .

## Results

According to the correct results obtained from the questionnaire the nutrition knowledge is fair in both groups. From possible 4520 questions students have given the correct answer to 3134 (69%). Although students from Bratislava had higher percentage of correct answers (70% vs. 69%), there was no overall statistically significant difference between the two groups. On six theses the two student groups differed significantly. When results were clustered, higher percentages of correct answers about proteins were obtained from Bratislava students. They correctly assumed that proteins are not the chief energy source (85% vs. 64%;  $p=0.007$ ), and also that athletes differ from the non-athletes in the amount of proteins needed (64% vs. 31%;  $p=0.00$ ). Although the students of the two faculties did not differ significantly when sport diet was tested in general, on a question pertaining to the weight loss during short restrictive diet the percentage of correct answers was statistically higher among students from Zagreb (81% vs. 49%;  $p=0.05$ ). The most extensive category included questions on vitamins and minerals. In 12 out of 14 questions participants of the two groups did not differ significantly. However, two questions made a significant difference. Higher proportion of students from Zagreb recognized that vitamins and minerals consumed before foods have an enhanced effect, just as that certain foods can help to restore body potassium levels (67% vs. 46%;  $p=0.02$ ; 60% vs. 22%;  $p=0,00$ ). Only one of four tested theses on fats discriminated students of the two groups. Once again, students from Zagreb recognized that only food of animal origin contains cholesterol (64% vs. 36%;  $p=0.005$ ). Theses on carbohydrates, hydration and influence of nutrition on sport performance did not reach statistically significant difference.

Table 1. Percentages and results of  $\chi^2$  test of true answers obtained for each question testing the nutrition knowledge for the two groups of students

No.	QUESTIONS	ANSWER	ZAGREB (% true answers)	BRATISLAVA (% true answers)	p
1.	Proteins are chief and most important energy source	F	63,8	85,0	0.007
4.	Athletes require three times more protein than nonathletes	T	31,0	63,6	0.00
11.	Weight loss induced by short term restrictive diets is mostly due to loss of fluid	T	81,0	49,1	0.05
28.	High potassium levels are characteristic of bananas and potatoes	T	60,3	21,8	0.00
32.	Cholesterol is characteristic only for food of animal origin	T	63,8	36,4	0.005
36.	Vitamin and mineral supplements are best taken after meals	F	67,2	45,5	0.02

Clustered results according to the specific category; knowledge on proteins, carbohydrates, fats, vitamins and minerals, hydration, diet and influence of nutrition on sport performance are presented in Table 2.

Table 2. Percentages of correct answers according to the tested clusters

No.	CATEGORY	% True Answers		
		OVERALL	ZAGREB	BRATISLAVA
1.	Proteins	48	40	56
2.	Carbohydrates	77	74	80
3.	Hydration	71	69	73
4.	Diet	67	68	66
5.	Vitamins and minerals	66	66	65
6.	Fats	48	51	45
7.	Influence of nutrition on sport performance	75	75	75

Results show the best overall knowledge on carbohydrates and influence of nutrition on sport performance (77% and 75%, respectively, Table 2). On the other hand, students seem to have less knowledge on proteins and fats (48% and 48%, respectively, Table 2). In Table 3 are presented percentages pointing to differences in frequency of particular dietary habit. Students have answered questions in four different categories, based on a 7-days period.

Table 3. Differences in frequencies of dietary habits of students from Zagreb and Bratislava tested by  $\chi^2$  test

No.	QUESTIONS	ZAGREB (%)				BRATISLAVA (%)				p
		5-7 d/w	3-4 d/w	1-2 d/w	never	5-7 d/w	3-4 d/w	1-2 d/w	never	
1.	How often do you eat breakfast in the morning?	3.5	8.8	36.8	50.9	1.8	1.8	18.2	78.2	0.02
2.	Based on three meals per day, how often do you skip at least one meal per day?	9.8	24.1	42.9	23.2	5.5	23.6	36.4	34.5	0.03
3.	How often do you take vitamin supplements?	19.3	22.8	29.8	28.1	32.7	23.6	29.1	14.5	0.2
4.	How often do you take mineral supplements?	8.8	14.0	21.1	54.4	23.6	21.8	29.1	23.6	0.02
5.	How often do you eat three base meals per day?	0.0	15.8	24.6	59.6	7.3	9.1	23.6	60.0	0.2
6.	How often do you record what you eat?	91.2	7.0		.0	92.7	.0		7.3	0.03
7.	How often do you drink water?	1.8	1.8	8.9	87.5	3.6	1.8	9.1	85.5	0.9
8.	How often do you drink carbonated beverages?	17.5	28.1	24.6	29.8	1.8	25.5	30.9	40.0	0.1
9.	How often are you on a "diet"?	1.8	.0	7.0	89.5	7.4	1.9	11.1	79.6	0.3
10.	How often do you eat breads, cereals, pasta, potatoes, or rice?	.0	1.8	36.8	59.6	1.8	5.5	27.3	63.6	0.4
11.	How often do you eat fruits, such as apples, bananas, or oranges?	.0	28.1	33.3	38.6	.0	18.2	30.9	50.9	0.3
12.	How often do you eat vegetables, such as broccoli, tomatoes, carrots, or salad?	3.5	12.3	28.1	54.4	.0	24.1	38.9	37.0	0.1
13.	How often do you eat dairy products such as milk, yogurt, or cheese?	.0	12.3	28.1	59.6	.0	14.5	32.7	52.7	0.8
14.	How often do you eat berry jams, cookies, candies, or other sweets?	24.6	42.1	58.1	1.8	30.9	30.9	34.5	3.6	0.4
15.	How often do you snack on foods like potato chips, cakes, candies, donuts, or soda?	10.5	22.8	52.6	12.3	1.8	14.5	70.9	10.9	0.2
16.	How often do you snack on foods like bagels, yogurt, popcorn, pretzels, or fruits?	66.7	46.3	57.1	50.0	33.3	57.7	42.9	50.0	0.5
17.	How often do you eat fast food?	1.8	17.5	59.6	19.3	1.8	3.6	61.8	30.9	0.2
18.	How often do you seek out nutrition information?	29.8	50.9	15.8	1.8	18.2	61.8	10.9	7.3	0.3

When results of  $\chi^2$  test are analyzed for the two groups of students differences were observed on 4 questions, mainly concerning regularity of food intake, daily diet recording and consumption of minerals. Students from Zagreb were more conscientious in eating breakfast and recording daily diet while those from Bratislava skipped meals less frequently and consumed more minerals.

## Discussion and conclusions

The basic nutrition knowledge of trainers was under the scrutiny of many investigations. It seems they often engage in activities that fall beyond their primary, legitimate domains of competence and influence. This includes activities such as giving advice about nutrition, and lifestyle (Gavin, 1996). Thus trainers' understanding and adhering to adequate nutrition rules is of utmost importance (Corley et al., 1990; Jacobson et al., 2001; Juzwiak and Ancona-Lopez, 2004; Froiland et al., 2004; Zinn et al., 2006). Although numerous investigations confirmed the importance of nutrition in sport, everyday practice unfortunately negates the adequate nutrition knowledge of persons involved in education of young athletes. Moreover, comparative study by Jacobson et al. (2001) on nutrition knowledge of high-level athletes showed that although clear recommendations were made, they resulted in diminutive changes in nutrition education. On the other hand, Little et al. (2002) found that even if a short-term nutrition education is conducted, it can significantly improve nutrition knowledge. Interviews with 55 Brazilian coaches participating in the Olympic games showed concerning results while 27% of them gave harmful advice on weight control (Juzwiak CR and Ancona-Lopez F, 2004). The results of the same study also indicated that coaches tend to over-value the proteins, excessively low-fat diets, and support food myths. Similar results were seen in the 1990 USA survey performed by Corley et al., where 70% of nutrition knowledge test was answered correctly, but 30% of tested coaches doubted their own knowledge and thus correctness of responses. In our study the overall rate of accuracy in answering nutrition knowledge questionnaire was comparable to majority of other studies (69%). When results were compared to those of Iranian student athletes we observed significantly better nutrition knowledge in students from Croatia and Slovakia (69 vs. 33% respectively). Iranian students showed inadequate nutrition knowledge on supplements, while highest scores were obtained in the nutrient category (Jessri M et al., 2010). On the other hand, our study showed greatest gaps and misconceptions in the knowledge on proteins (48%), especially among students from Zagreb (40%). Our study also confirmed the pitfalls in the nutrition knowledge on diet, vitamins and minerals. Unfortunately, trainers are not only poorly informed about nutrition but also engage in unhealthy dietary habits. As tested population in our study represents future trainers and pedagogues, the substandard level of nutrition knowledge is concerning, especially as it can lead to poor dietary behaviours and habits of future athletes. When our results are compared to those of Bedgood and Tuck (1983) it is evident that lack of nutrition knowledge of trainers must not be underestimated. Although coaches' scored below 70% on knowledge of nutrition, they were none the less assured in adequacy of their knowledge, and correctness of dispensing it to athletes. Investigation by Zinn et al. (2006) confirmed that trainers who had better nutrition knowledge felt more comfortable in giving advice to athletes. It is therefore important to provide the necessary education to trainers, i.e. sport students who will in future work with young athletes. Our study, just like others, has proven that basic nutritional knowledge (i.e. that collected through media, or other coaches/trainers based on one's own interest) of sport students is quite fair. Implementation of elementary and advanced courses on nutrition into obligatory as well as into optional programs of sport faculties imposes as a logical solution, while this is a crucial point where different strategies can help to develop nutrition knowledge and improve dietary habits, especially among sport students, future trainers and pedagogues. As studies have shown, significant improvements can be expected even from short-term nutrition education (Little JC et al. 2002), so one would expect exceptional results if education was performed systematically and in selected population such as sport students.

## References

1. Bedgood, B.L., & Tuck, M.B. (1983). Nutrition knowledge of high school athletic coaches in Texas. *Journal of the American Dietetic Association*, 83(6), 672-677.
2. Burns, R.D., Schiller, R., Merrick, M.A., & Wolf, K.N. (2004). Intercollegiate student athlete use of nutritional supplements and the role of athletic trainers and dietitians in nutrition counseling. *Journal of the American Dietetic Association*, 104, 246-9.
3. Conkle, T.H., & Tishler, A.G. (1992). Sports nutrition knowledge assessment of physical educators and coaches. *Annual meeting of the Mid-South Educational Research Association*, 11-13; Knoxville, Tennessee.
4. Corley, G., Demarest-Litchford, M., & Bazzarre, T.L. (1990). Nutrition knowledge and dietary practices of college coaches. *Journal of the American Dietetic Association*, 90(5), 705-709.
5. Froiland, K., Koszewski, W., Hingst, J., & Kopecky, L. (2004). Nutritional supplement use among college athletes and their sources of information. *International Journal of Sport Nutrition and Exercise Metabolism*, 14(1), 104-120.
6. Gavin, J. (1996). Personal trainers perceptions of role responsibilities, conflict, and boundaries. *Ethics & Behavior*, 6(1), 55-69.
7. Graves, K.L., Farthing, M.C., Smith, S.A., & Turchi, J.M. (1991). Nutrition training, attitudes, knowledge, recommendations, responsibility, and resource utilization of high school coaches and trainers. *Journal of the American Dietetic Association*, 91(3), 321-324.
8. Gilbert, N. (2009). Conference on 'Multidisciplinary approaches to nutritional problems'. Symposium on Performance, exercise and health. Practical aspects of nutrition in performance. In Klaas R. Westerterp (Ed.) *Proceedings of the Nutrition Society*, 68(1), 23-28.
9. Hacman, R.M., Katra, J.K., & Geertsens, S.M. (1992). The athletic trainer's role in modifying nutritional behaviors of adolescent athletes: putting theory into practice. *Journal of Athletic Training*, 27(3), 262-267.



10. Jacobson, B.H., Sobonya, C., & Ransone, J. (2001). Nutrition practices and knowledge of college varsity athletes: a follow-up. *Journal of Strength and Conditioning Research*, 15(1), 63-68.
11. Jessri, M., Jessri, M., Rashidkhani, B., & Zinn, C. (2010). Evaluation of Iranian college athletes' sport nutrition knowledge. *International Journal of Sport Nutrition and Exercise Metabolism*, 20 (3), 257-63.
12. Juzwiak, C.R., & Ancona-Lopez, F. (2004). Evaluation of nutrition knowledge and dietary recommendations by coaches of adolescent Brazilian athletes. *International Journal of Sport Nutrition and Exercise Metabolism*, 14(2), 222-235.
13. Lacey, K., & Prichett, E. (2003). Nutrition Care Process and Model. ADA adopts road map to quality care and outcomes management. *Journal of the American Dietetic Association*, 103, 1061-1072.
14. Laurie, G., Zawila, C., & Steibt, B. (2003). The female collegiate cross-country runner nutritional knowledge and attitudes. *Journal of Athletic Training*, 38, 67-74.
15. Lissner, L., & Heitmann, B.L. (1995). Dietary fat and obesity evidence from epidemiology. *European Journal of Clinical Nutrition*, 49, 79-90.
16. Little, J.C., Perry, D.R., & Volpe, S.L. (2002). Effect of nutrition supplement education on nutrition supplement knowledge among high school students from a low-income community. *Journal of Community Health*, 27, 433-50.
17. Nancy, C., Connie, E., Vickery, R.D., & McBee, S. (2005). Sports nutrition for young athletes. *Journal of School Nurses*, 21, 323-28.
18. Parmenter, K., & Wardle, J. (1999) Development of a Nutrition Knowledge Questionnaire. *European Journal of Clinical Nutrition*, 53, 298-308.
19. Paugh, S.L. (2005). Dietary habits and nutritional knowledge of college athletes. (Thesis). California: California University of Pennsylvania.
20. Ruka, S., Toyama, K., Amamoto, R., Liu, C.H., & Shinfuku, N. (2005). Nutritional knowledge, food habits and health attitude of Chinese university students-a cross sectional study. *Journal of Nutrition*, 4, 1475-1480.
21. Turconi, G., Celsa, M., Rezzani, C., Biino, G., Sartirana, M.A., & Roggi, C. (2003). Reliability of a dietary questionnaire on food habits, eating behaviour and nutritional knowledge of adolescents. *European Journal of Clinical Nutrition*, 57, 753-763.
22. Zinn, C., Schofield, G., & Wall, C. (2006). Evaluation of sports nutrition knowledge of New Zealand premier club rugby coaches. *International Journal of Sport Nutrition and Exercise Metabolism*, 16(2), 214-225.

## THE FREQUENCY OF ALLERGIC DISEASES AMONG WRESTLING AND KARATE TRAINEES

Jelena Macan<sup>1</sup>, Mario Baić<sup>2</sup> and Goran Romić<sup>3</sup>

<sup>1</sup>*Institute for Medical Research and Occupational Health, Zagreb, Croatia*

<sup>2</sup>*Faculty of Kinesiology, University of Zagreb, Croatia*

<sup>3</sup>*Zagreb Sport Association, Zagreb, Croatia*

### Abstract

The aim of this study was to evaluate differences in the prevalence of subjects with allergic disorders among 189 Greco-Roman wrestling and 124 karate trainees aged 10-16 years. Data about allergic nasal, asthmatic and skin symptoms, and asthmatic symptoms during exercise were recorded and analyzed with chi-square test. The prevalence of rhinitis and eczema was similar in wrestlers and karateka (rhinitis- 21.2% vs 21%; eczema- 6.3% vs 4%,  $P>0.05$ ). The prevalence of asthma was higher in karateka than in wrestlers, but without statistical significance (12.1% vs 6.8%,  $P=0.11$ ). Allergic diseases were present among analyzed trainees in similar proportion as in general male schoolchildren population of Croatia. Results also indicate that wrestling is a less suitable sport discipline for asthmatics than karate, probably due to higher energy consumption, and greater importance of strength and endurance.

**Key words:** *allergic rhinitis, asthma, exercise-induced asthma, Greco-Roman wrestling, karate*

### Introduction

It is well established that common allergic diseases pose some limits to physical activity, particularly those involving respiratory system, like allergic rhinitis and asthma. Consequently, these disorders can interfere with athlete's performance during training and particularly during competition. For allergic persons, the most common pathophysiological problems related to physical activity are exercise-induced asthma and exercise-induced rhinitis, conditions defined as worsening of asthmatic or rhinitic symptoms during, or shortly after the physical activity. Investigations were so far able to define some factors influencing the occurrence of exercise-induced airway disorders. Environmental factors such as low air temperature and humidity, heavy exposure to allergens during exercise (for example to pollens for outdoor activities or to dust mites for indoor activities), or physical performance in areas polluted with respiratory irritants like sulphur dioxide, nitric oxides, ozone, and cigarette smoke, can provoke or enhance exercise-induced airway problems in athletes. Although the pathophysiology of exercise-induced rhinitis and asthma is not fully recognized, it is known that their occurrence is related to the intensity, duration and the course of exercise, making exercise-induced airway problems more prone with more intensive and longer trainings, and trainings with rapid increase and decrease of the work load. However, investigators are still confused with great variability in occurrence and course of exercise-induced disorders among athletes in different sport disciplines, and influencing factors related to the specific functional, motorical, and technical/tactical demands of different sports are not recognised (Carlsen et al., 2008; Sacha and Quinn, 2011).

Wrestling and karate both belong to polystructural acyclic sport disciplines, with mixed aerobic/anaerobic functional demands. The competitions for both disciplines are in a form of a fight. Duration of karate fight is 1, 1.5 or 2 minutes for age categories 10-16 years. For the same age categories wrestling fight last 4 or 6 minutes (2x2 or 3x2 minutes).

Wrestling is a contact sport characterized with alterations of dynamic, explosive repeating movements and static exertions of big muscle groups, altogether with permanent need to overpower opponent's weight and resistance. It is considered that strength and endurance are the most important motorical components in senior wrestling (Marić et al. 2003; Baić 2006). Wrestling experts also consider that in younger wrestlers (younger boys, boys) coordination is the most important ability. With increase of wrestler age (cadets, juniors, and seniors), importance of coordination decreases and the importance of strength and endurance increases.

Modern karate fight represents a non-contact discipline with performance of controlled punches and kicks against the opponent. Only mild contact of hand or leg with the opponent's trunk, and only touch of leg to the opponent's head are allowed, while any contact of hand with opponent's head is prohibited (hand techniques must be stopped few centimetres from the head). Speed and coordination are considered as most important motorical components of karate training (Kuleš, 1998).

The aim of this study is to establish the prevalence of schoolchildren with allergic disorders among wrestling and karate trainees from sport clubs from Zagreb and surroundings, and to evaluate differences in the prevalence of these disorders between trainees in analyzed sport disciplines.

## Methods

The study with cross-sectional design involved a total of 313 male subjects, 189 Greco-Roman wrestling and 124 karate trainees, aged 10 to 16 years, from wrestling and karate clubs from Zagreb and surroundings. The main descriptive characteristics of the study subjects are presented in Table 1.

Data about allergic symptoms were recorded in the form of structured medical interview conducted by the author, a physician and specialist in occupational and sport medicine. All subjects were asked about the presence of allergy-related nasal symptoms (sneezing, rhinorrhea, nasal itching and obstruction not related to common cold), asthmatic symptoms (wheezing, dyspnea, dry cough), asthmatic symptoms during exercise, and skin symptoms (itching, rash, erythema, eczema) during the last 12 month. Subjects who reported at least two nasal, asthmatic or skin symptoms were considered as subjects with allergic rhinitis, asthma or eczema, respectively.

All data were handled, analyzed and presented in accordance with the ethical principles of the Helsinki Declaration, maintaining anonymity of involved subjects.

Table 1. Main characteristics of the studied male subjects

Subjects	N	Age (years) median (range)
Wrestling trainees	189	13 (10-16)
Karate trainees	124	12 (10-16)
Total	313	13 (10-16)

Statistical analysis was done by programme Statistica 5.0 for Windows with methods of descriptive statistics, and non-parametric procedure (chi-square test, Yates correction for samples less than 10) for testing differences in the prevalence of allergic symptoms related to localization of symptoms and evaluated sport discipline. A value of  $P < 0.05$  was considered statistically significant.

## Results

In this study, 90/313 (28.75%) subjects, 54/189 (28.6%) wrestlers and 36/124 (29 %) karateka, reported the presence of allergic rhinitis, asthma and/or eczema. Allergic rhinitis was reported in 66/313 (21.1%) subjects, asthma in 28/313 (8.9%) subjects and eczema in 17/313 (5.4%) subjects. The prevalence of reported allergic disorders separately in wrestlers and karateka are presented in Figure 1. The prevalence of rhinitis and eczema were similar in wrestlers and karateka (rhinitis- 21.2% vs 21%,  $P > 0.05$ ; eczema- 6.3% vs 4%,  $P > 0.05$ ). The prevalence of asthma was higher in karateka than in wrestlers, but without statistical significance (12.1% vs 6.8%,  $P = 0.11$ ). Accordingly, occasional exercise-induced asthmatic symptoms were reported in 7/124 (5.6%) karateka, and in 7/189 (3.7%) wrestlers.

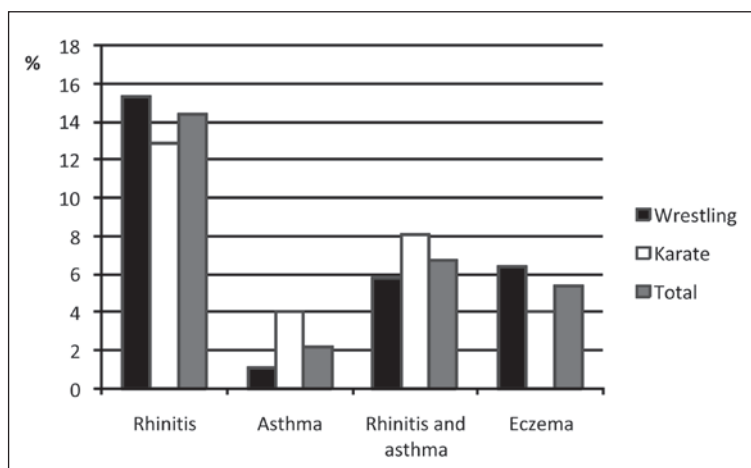

Figure 1. The prevalence of wrestling and karate trainees with reported allergic disorders.

## Discussion and conclusions

Exercise-induced breathing problems are relatively common in athletes, including those with top international performance. However, the frequency of athletes with such problems varies among different sport disciplines due to the involved environmental factors, and exercise structure. It is known that exercise in cold air and exercise with endurance demands are the most favourable conditions for the occurrence of exercise-induced rhinitis or asthma. It was shown that the prevalence of athletes with exercise-induced breathing problems during the summer Olympic Games was highest in cycling, triathlon, modern pentathlon and rowing, and during the winter Olympic Games in cross-country skiing, speed skating, nordic combined, short-track skating and biathlon. Expectedly, the prevalence of athletes taking medications to control exercise-induced airway disorders was higher in winter games 2006 than in summer games 2004 (8.3% and 4.6%, respectively) (Carlsen et al., 2008). Swimming is recommended as a most suitable sport for asthmatic athletes because the exercise is performed in warm and humid environment. That is why the proportion of asthmatics is often higher among swimmers (including elite athletes) in comparison with other sport disciplines. However, there is an increasing number of studies suggesting that swimming should also be regarded as a discipline involving some risk factors for the occurrence or progression of airway diseases, like inhalation of chlorine compounds mixed with water droplets (Haahtela et al., 2008).

In this study, we analysed the prevalence of schoolchildren with allergic diseases among Greco-Roman wrestling and non-contact karate trainees. Results show that the prevalence of allergic diseases, particularly rhinitis and eczema, among wrestling and karate trainees was similar to the prevalence of these diseases in general male schoolchildren population of Croatia (Munivrana et al., 2007). Both analyzed disciplines can be considered suitable for persons with allergic rhinitis and eczema, with no observed selection or exclusion of schoolchildren with these allergic diseases among wrestling and karate trainees. Our previous study also suggested that non-contact karate is a suitable sport discipline for physical and psychological conditioning of allergic children and adolescents, including those with asthma (Romić et al., 2008). However, in this study the proportion of asthmatic children was lower among wrestlers than among karateka (6.8% and 12.1%, respectively). This difference did not reach statistical significance, bearing in mind that the number of asthmatics was relatively small, thus influencing the power of statistical analysis. Wrestling and karate represent sport disciplines which are not considered as particular risk for the occurrence of exercise-induced airway problems. Their training sessions and competitions are performed indoors, in conditions of regular room temperature and humidity, and without exposure to indoor pollutants and allergens. In case of wrestling, air humidity in training rooms can be very high. However, disciplines have some differences in structure which could influence the involvement of asthmatics into a training process. Wrestling represents a contact sport with permanent efforts to overpower the opponent's weight and resistance. On the contrary, karate is a non-contact discipline with exchange of controlled punches and kicks. Duration of fights is significantly longer in wrestling than in karate. Therefore, wrestling fight demands higher energy consumption, strength and endurance than karate fight, making karate more suitable for training of asthmatics. It is also possible that the age of analyzed trainees influenced the results of this study. It was shown that importance of strength and endurance in wrestling increases with age of trainees, suggesting that greater difference between proportion of asthmatics in wrestlers and karateka should be expected in older trainees. Therefore, the age of analyzed subjects could pose another reason why the observed difference in proportion of asthmatics between wrestlers and karateka in this study did not reach statistical significance (Marić et al. 2003; Baić 2006).

In conclusion, the results show that the prevalence of allergic diseases, particularly rhinitis and eczema, among wrestling and karate trainees was similar to the prevalence of these diseases in general male schoolchildren population of Croatia. Study also indicates that wrestling is less suitable sport discipline for asthmatic persons than karate, probably due to its contact nature, higher energy consumption, and greater importance of strength and endurance. Study results are in line with other studies suggesting that different structure and demands of certain sport disciplines can influence the involvement of asthmatic athletes into training process. Further investigations in older age categories of wrestlers are indicated due to changes in motorical demands related to wrestler's age (greater importance of strength and endurance in older wrestlers), and specific environmental conditions for training (high air humidity).

## References

1. Baić, M. (2006). Razlike između vrhunskih poljskih i hrvatskih hrvača različitih stilova, dobi i težinskih skupina u prostoru varijabli za procjenu kondicijske pripremljenosti. (Doktorska disertacija). Zagreb: Kineziološki fakultet Sveučilišta u Zagrebu.
2. Carlsen, K.H., Anderson, S.D., Bjermer, L., Bonini, S., Brusasco, V., Canonica, W., et al. (2008). Exercise-induced asthma, respiratory and allergic disorders in elite athletes: epidemiology, mechanisms and diagnosis: Part I of the report from the Joint Task Force of the European Respiratory Society (ERS) and the European Academy of Allergy and Clinical Immunology (EAACI) in cooperation with GA<sup>2</sup>LEN. *Allergy*, 63, 387-403.
3. Haahtela, T., Malmberg, P., Moreira, A. (2008). Mechanisms of asthma in Olympic athletes- practical implications. *Allergy*, 63, 685-694.

4. Kuleš, B. (1998). *Trening karatista*. Zagreb: Grafokor d.o.o.
5. Marić, J., Baić, M., Aračić, M. (2003). Kondicijska priprema hrvača. U: Dragan Milanović i Igor Jukić (ur.), *Zbornik radova Međunarodnog znanstveno-stručnog skupa "Kondicijska priprema sportaša"*, 12. zagrebački sajam sporta i nautike, Zagreb, 21. i 22. veljače 2003. (str. 339-346). Zagreb: Kineziološki fakultet Sveučilišta u Zagrebu; Zagrebački športski savez.
6. Munivrana, H., Vorko-Jović, A., Munivrana, S., Kursar, M., Medlobi-Gluhak, M., Vlahek, P. (2007). The prevalence of allergic diseases among Croatian school children according to the ISAAC Phase One questionnaire. *Med Sci Monit*, 13(11), CR505-509.
7. Romić, G., Macan, J., Hrženjak, M. (2008). Karate training and allergic diseases. In: Dragan Milanović i Franjo Prot (ed.), *Proceedings Book, 5th International scientific conference on kinesiology, Zagreb, Croatia, September 10-14, 2008*. (p. 188-191). Zagreb: Faculty of Kinesiology, University of Zagreb.
8. Sacha, J.J., Quinn, J.M. (2011). The environment, the airway, and the athlete. *Ann Allergy Asthma Immunol*, 106(2), 81-7.

## DOPING, NUTRITION AND CHAMPIONSHIP RANKING CORELLATION IN THE CROATIAN FEMALE SOCCER

**Petra Mandić-Jelaska<sup>1</sup>, Fredi Fiorentini<sup>2</sup> and Dario Bašić<sup>3</sup>**

<sup>1</sup>*“Pink Panther” Fitness Club - Kaštel Stari, Croatia*

<sup>2</sup>*HNK “Hajduk” – Split, Croatia*

<sup>3</sup>*Faculty of Kinesiology, University of Zagreb, Croatia*

### Abstract

The purpose of this research was to study the level of knowledge about doping and nutrition among female soccer players from the first Croatian league. Another aim was to determine whether there is a statistically significant correlation between knowledge about doping and nutrition within a particular club, and the position of the same club in the championship standings at the end of the 2009/2010 competition season. To this end, a questionnaire for testing knowledge about doping and nutrition was used on 100 female soccer players from the first Croatian league who play in all of the eight female clubs in said league. The analysis of descriptive statistical parameters led to the conclusion that the knowledge of Croatian soccer players about doping and sports nutrition is poor. Additionally, the non-parametric correlation analysis discovered the disconcerting fact that there is a negative correlation between the end-of-season ranking of the club and the total doping and nutrition knowledge of the athletes from this club.

**Key words:** *doping knowledge, nutrition knowledge, Croatian female soccer players, rank correlation*

### Introduction

Sports nutrition is currently considered to be one of the key components which have a direct impact on the quality of sports performance. Also, the quality of intensive and extensive training process implementation and the suitable diet of the athletes are in close connection because such training generates increased metabolic, physical and psychological activity, and so the energy needs of athletes are significantly greater than in people who do not actively engage in sports. Therefore, present-day sports necessitates complete control over the athletes' nutrition i.e. their intake of proteins, carbohydrates, minerals, vitamins, etc. in order for the principles of a healthy diet to become part of their everyday lives and to reach the long-term goal of preserving their health and progress in sports. The aforementioned approach in modern training processes is probably of key importance because otherwise malnutrition occurs. It weakens the immune system and makes the athlete susceptible to a series of illnesses. In conclusion, nutrition knowledge is one of the crucial factors for an elite athlete. It can help long-term preservation and stability of all the functions of their organism, and also make a considerable contribution to the improvement of competition results. On the other hand, doping is one of the most dangerous threats to today's sports. According to a well-known definition of the International Olympic Committee, “Doping is any substance or method intended to artificially enhance performance, which is contrary to sports ethics as well as the physical and mental integrity of the athlete.” For that reason, the doping issue has attracted great attention of the media and the scientific community. We would like to point out that the eradication of prohibited substances in sport is the basic goal of World Anti-Doping Agency (WADA), the main body for the promotion, coordination and monitoring of the fight against doping in sport. Moreover, the preservation of health of top athletes is becoming more demanding because it is endangered, among other things, by daily intensive and extensive trainings. This requires the individuals to fully devote themselves to their health. Therefore, it is important that the coaches and physicians have a solid knowledge about supplements and doping in sport because they are supposed to draw the attention of the athletes to the harms of doping, and give them proper advice regarding the circumstances under which it is possible to administer certain supplements, as well as on their dosage, potential side-effects, and use-related risks. A very important aspect of doping prevention is primarily the evaluation of the athlete's knowledge and attitude towards doping. In addition, it is important to collect data on the reasons of use, level of knowledge, source of information and procurement of dietary supplements in order to identify the athlete's knowledge about nutrition, particularly sports nutrition (Somerville and Lewis, 2005, Mandić-Jelaska, 2010).

The objective of many recent studies is to determine the level of knowledge about nutrition and doping in sport among athletes and the frequency of use of prohibited substances in a particular sport. It can be of preferred scientific and practical significance for a particular sport considering that the analysis of these factors would point directly to the element which should be affected in order to raise knowledge to an appropriate level. For example, Sas-Nowosielski and

Światkowska (2007) evaluated the knowledge and attitude towards doping among 830 athletes. The subjects gave correct answers to 45.2% of the knowledge-related questions. The greatest proportion of questions referred to the knowledge about the athletes' rights and obligations (50.8%), while the lowest proportion was represented by questions about anti-doping rules and procedures (41.8%). Moreover, the attitudes of the subjects were assessed as moderately positive, with the attitude towards doping control being the most positive, and the attitude towards sanctions the least positive. Significant differences in attitudes were identified – the female athletes achieved better results than the male athletes. Additionally, there were also differences among age groups – the group aged 18-24 achieved better results than the remaining two groups. In conclusion, the authors propose that anti-doping education be improved. Waddington et al. (2005) used a sample of 706 professional English soccer players to examine the use of dietary supplements, advice on the use of supplements, opinion on the rate of use of prohibited substances and recreational drugs in soccer, possible knowledge about players who use the aforementioned substances, attitudes towards prohibited substances and towards drug testing. The research showed that most players use supplements and that every fifth player uses supplements without having previously consulted a professional from the club. One third of the players have not been tested in the previous year, and 60% of them felt that they were unlikely to be tested in the upcoming year. Performance-enhancing substances are rarely taken, unlike recreational drugs which are more often used by soccer players: 6% of the subjects said that they personally knew a player who used performance-enhancing substances, and 45% of the subjects knew a player who uses recreational drugs. The authors conclude that there is a need to give adequate advice to the soccer players on the use of supplements in order to minimise the risk of using contaminated supplements. Furthermore, Somerville and Lewis (2005) surveyed a sample of 74 Olympic-level athletes to test their knowledge about doping substances, the source of the last doping information and the source of help. Over 90% of the subjects were updated on the doping issue within the last six months. The question which sought to test the doping knowledge of athletes required the subjects to list as many daily products as possible which might contain prohibited substances. The average answer was two products. Moreover, the team physician was the most popular source of information (62%). The team doctor is most frequently contacted in rowing (92%) and sailing (73%), and least frequently in athletics (31%). By inspecting recent scientific papers, we may notice that there are no papers which study the problem of doping and nutrition knowledge among female soccer players, particularly Croatian ones. In addition to getting an insight into the doping and nutrition knowledge of Croatian female soccer players, another objective of this research was to test and explain whether there is a statistically significant correlation between the knowledge about doping and sports nutrition within a particular club, and the position of the same club in the championship standings at the end of the 2009/2010 competition season.

## Methods

The sample of subjects comprised 100 female soccer players in every club in the first Croatian league: women's soccer club (WSC) "Ombla", WSC "Rijeka", WSC "Dinamo", WSC "Osijek", WSC "Polet", WSC "Čađavica", WSC "Viktorija" and WSC "Agram". The variables used in the research were extracted from a questionnaire about the habits, attitudes and knowledge in the field of sports nutrition and doping (Zenić, 2011). The variables may be divided into two sets: general variables describing the subjects such as age (AGE), years in sports (YIS), level of education (EDU) and variables for self-assessment and assessment of nutrition and doping knowledge including nutrition knowledge self-assessment (NKSA) and doping knowledge self-assessment (DKSA), nutrition knowledge (NK), doping (DK) and the person who the female athlete trusts when it comes to nutrition and doping matters (TDM and TNM). The variables NK and DK are represented by the number of correctly answered questions which consist of 18 nutrition-related questions and 18 doping-related questions. Zenić (2011) confirmed the reliability of the measuring instrument by a test-retest method carried out on a sample of subjects from the Faculty of Kinesiology. The result was a correlation coefficient of up to 0.96 and the overlap of correct answers of up to 87%. Factor analysis demonstrated an appropriate factor structure with 13 extracted factors, each of which explains from 4% to 7% of the total variance. A total 67% of the common variance was explained.

The parameters of descriptive statistics were calculated for all of the variables. Additionally, the Kendall Tau and the Spearman's rank correlation coefficient were used to establish a connection between the club ranking and knowledge about doping and nutrition.

## Results

Primarily, the parameters of descriptive statistics were calculated for the basic variables of the AGE, YIS, NKSA, DKSA, DK and NK measuring instruments (Table 1). It should be pointed out that self-assessment variables were given as results on the Likert scale from 1 through 5.

Table 1. Descriptive statistical parameters (AM – arithmetic mean, SD - standard deviation, Min – minimum result, Max – maximum result, Med - Median, Mod – the most frequent value, FMod – Mod frequency,  $\alpha_3$  – skewness coefficient,  $\alpha_4$  – kurtosis coefficient, KS – empirical significance obtained from the Kolmogorov-Smirnov test)

	N	AM±SD	Min	Max	Med	Mod	FMod	$\alpha_3$	$\alpha_4$	KS
AGE	101	20.23±4.44	13	35	20	16	15	0.77	0.56	<0.20
YIS	101	7.89±4.55	1	26	7	Multiple	11	0.80	1.24	<0.20
EDU	101	2.26±0.59	1	4	2	2	68	0.73	1,00	<0.01
NKSA	101	2.84±0.95	1	5	3	3	42	-0.33	-0.53	<0.01
DKSA	101	2.62±1.09	1	5	3	3	33	-0.04	-0.97	<0.01
DK	101	2.94±2.53	0	11	3	0	25	0.64	0.01	<0.10
NK	101	5.65±3.02	0	15	5	4	21	0.78	0.60	<0.05

It should be pointed out that among athletes tested and studied according to their positions in the soccer game there were 16% of goalkeepers, 17% of forwards, 31% of midfielders and 36% of defenders. Furthermore, data show that most Croatian female soccer players do not use dietary supplements (68%), while only 4% use dietary supplements and 28% of subjects use them on occasion.

Figure 1 shows trust in the matters of nutrition and doping in the total sample, i.e. graphical representation of TDM and TNM variables.

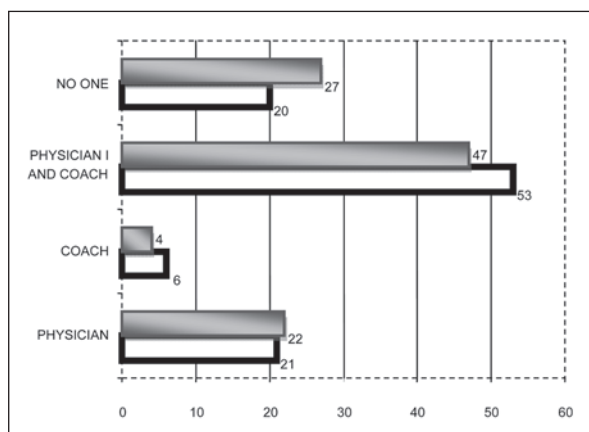

Figure 1. Overview of trust in the matters of nutrition and doping (Nutrition grey bar fill; Doping white bar fill).

It should be pointed out that the source of knowledge on doping is very wide (physician, coach, internet, education) and that neither category stands out as the dominating one in terms of source of knowledge in women's soccer. It should also be said that as much as 87% of soccer players never took a doping test.

Another area surveyed among female athletes was their opinion on the extent of doping in women's soccer. Three categories of responses (not using -18%, rarely using - 25% and frequently using - 20%) have similar results while as much as 47% subjects do not know if doping is used in soccer. Therefore, we can conclude that the answer of the female athletes to this question is much dispersed.

Table 2 shows the distribution of knowledge on nutrition and doping according to clubs as well as ranking at the end of the 2009/2010 competition season.



Table 2. Descriptive statistical parameters according to clubs of the first Croatian women's soccer league (AM1 – arithmetic mean of the DK variable, SD1 - standard deviation of the DK variable, AM2 – arithmetic mean of the NK variable, SD2 - standard deviation of the NK variable, AM3 – arithmetic mean of the EDU variable, SD3 - standard deviation of the EDU variable, Ranking – championship standings of the club at the end of the 2009/2010 competition season)

	N	AM1±SD1	AM2±SD2	AM3±SD3	Ranking
OMBLA	13	2.07±1.12	4.54±2.73	2.38±0.50	3
RIJEKA	20	2.55±1.79	5.75±3.48	2.25±0.91	5
OSIJEK	19	0.15±0.69	4.16±1.12	2.11±0.31	1
DINAMO	18	3.10±2.13	5.78±3.02	2.33±0.68	4
AGRAM	10	6.30±2.21	8.00±4.27	2.50±0.52	7
VIKTORIJA	10	4.60±1.84	6.40±1.71	2.10±0.31	2
POLET	7	4.90±3.13	5.71±3.04	2.25±0.46	6
ČAĐAVICA	3	3.67±3.21	8.67±3.05	2.00±0.00	8

Two different nonparametric correlation coefficients – Kendall's Tau correlation coefficient and Spearman's rank correlation coefficient – were used to test whether ranking on a first league table is statistically significantly correlated with the ranking of knowledge on doping and nutrition for individual clubs. Tables 3 and 4 show results of the nonparametric correlation analysis.

Table 3. Kendall's rank correlation coefficients among the Ranking, Edu, NK and DK variables

	Ranking	Edu	NK	DK
Ranking	1.00			
Edu	-0.07	1.00		
NK	-0.50	-0.14	1.00	
DK	-0.50	0.14	0.57*	1.00

\*-statistically significant coefficients at the 0.05 level

Table 4. Spearman's rank correlation coefficients among the Ranking, Edu, NK and DK variables

	Ranking	Edu	NK	DK
Ranking	1.00			
Edu	-0.10	1.00		
NK	-0.67	-0.19	1.00	
DK	-0.62	0.17	0.67	1.00

## Discussion and conclusion

Table 1 shows that the most frequent variables of doping knowledge (DK) and nutrition knowledge (NK) are 0, with frequency as high as 36, and 4, with frequency totalling 24. Additionally, median values of DK and NK are 3 and 5 respectively. These results are in line with a known fact that athletes' doping knowledge is significantly lower than nutrition knowledge. Moreover, self-assessed level of knowledge on the scale of 1 to 5 is 2.71 on average for doping, and 2.84 for nutrition. Thus, we can conclude that the subjects assess their knowledge as limited. Additionally, if we look at the maximum values of the DK and NK variables, we can see that none of the subjects gave a correct answer to all the questions from both the nutrition and the doping category. Average age of subjects is 20.23±4.44 years, which also points to the fact that the sample is a representative sample of the Croatian first league female soccer players. Furthermore, we can see that the mode of the YIS variable is given as "multiple" since there is no more than one value appearing 11 times. Overall, doping and nutrition knowledge of female soccer players is poor (2.94 and 5.65 of correctly answered questions on average) when taken overall or according to individual clubs (Table 1 and 2). In part, this can be explained with the fact that women's soccer is a sport where the issue of doping has not yet been recorded. Thus, Croatian soccer players do not have direct knowledge about the issue.

Figure 1 shows whom the Croatian soccer players trust when doping and nutrition is concerned. We can see that when it comes to the matters of doping and nutrition, most Croatian female soccer players trust their coach and physician

the most, and that, scientifically speaking, is an appropriate approach. Therefore, in the context of results obtained, we can pose the question of manner and frequency (weekly, monthly, annually, etc.) of communication of Croatian women's soccer players with their physician and coach regarding the issues of doping and nutrition.

Tables 3 and 4 show that there is no statistically significant positive correlation between the level of education and doping and nutrition knowledge, which is contrary to what we have expected. The data help us to conclude that, for the purpose of expanding the knowledge base on nutrition and doping, it is useful to insist on a focused education of women's soccer players on the issues of nutrition and doping in sports, since this most certainly generates greater, applicable knowledge. Moreover, contrary to what was expected, the results of the correlation analysis show that there is no connection between the club ranking and the knowledge about nutrition or doping. More precisely, both used correlation coefficients, Kendall and Spearman's show there is a statistically insignificant correlation between the ranking of a first league club and the knowledge on doping or nutrition, which contradicts elementary kinesiology findings of the scientific and practical approach to the analysis of this problem.

On the basis of these results, we can conclude that doping and nutrition knowledge of the Croatian women's soccer players is poor. Even though it seems that the problem of doping in Croatian women's soccer is not as present as in other sports, the fact that female athletes do not have a higher level of knowledge on the matter is surprising. Naturally, these data should not be satisfactory because these are elite competitors and their knowledge on the matter should be on a significantly higher level than recorded. The fact that there is a negative (statistically insignificant) correlation between doping and nutrition knowledge and the club's ranking in the championship standings is worrying.

## References

1. Mandić-Jelaska, P. (2010). Znanja o dopingu i prehrani u hrvatskom ženskom nogometu. (Doping and Nutrition Knowledge in Croatian Women's Soccer), Master's thesis. Faculty of Kinesiology at the University of Split.
2. Sas-Nowosielski, K. i Świątkowska, L. (2007). The knowledge of the world anti-doping code among Polish athletes and their attitudes toward doping and anti-doping policy. *Human Movement*, 8 (1), pp. 57-64.
3. Zenić, N., Stipić, M., Sekulić, D. (2011). Religiousness as a Factor of Hesitation Against Doping Behavior in College-Age Athletes. *Journal of Religion and Health*. (Epub ahead of print, PMID: 21409480).
4. Somerville, S.J. and Lewis, M. (2005). Accidental breaches of the doping regulations in sport: Is there a need to improve the education of sports people? *British Journal of Sports Medicine* 39 (8), pp. 512-516.
5. Waddington, I., Malcolm, D., Roderick, M. and Naik, R. (2005). Drug use in English professional soccer. *British Journal of Sports Medicine*, 39 (4).

## AEROBIC CAPACITY OF BASKETBALL REFEREES

Tomislav Rupčić<sup>1</sup>, Andro Matković<sup>2</sup> and Katarina Nabršnigg<sup>1</sup>

<sup>1</sup>Faculty of Kinesiology, University of Zagreb, Croatia

<sup>2</sup>School of Medicine, University of Zagreb, Croatia

### Abstract

Referees are an integral part of basketball game just like players, and their role in the final outcome of a game is very important and sometimes crucial. The aim of this study was to analyze the aerobic capacity of elite Croatian basketball referees. The study was taken on a sample of 31 referees who were on the A list of the Association of Croatian Basketball Referees in the 2008/2009 season. Their mean age was  $33.3 \pm 5.2$  years. The functional abilities of referees were determined with the spiroergometric method using a progressive load on the treadmill with a constant slope of 1.5% using the Cosmed Quark b<sup>2</sup> "breath by breath" spiroergometer.

Based on the obtained results, it can be concluded that referees have a well developed aerobic capacity, similar to top basketball players as well as referees from other team sports, like soccer or handball.

**Key words:** *basketball officials,  $VO_2$ max, physical fitness*

### Introduction

Referees are an integral part of basketball game just like players, and their role in the final outcome of a game is very important and sometimes crucial. This claim is particularly significant when we take into account the statistic data saying that 90% of basketball games at any level of competition end with one to three points in favor of either team. Moreover, the final outcome of most basketball games is decided in the final moments, when the level of physical and motor fitness of players, their mental stability, and changes in the play tactics of the team, greatly affect the final number of committed technical or tactical errors and fouls arising from violations of basketball rules (Mildenhall and Holmin, 2004). Therefore, it can be concluded that referees have great responsibility during the entire game, especially in its final moments, when their activity increases in terms of the number of decisions. That, along with the increase in their physiological strain due to changes in the play tactics of teams (playing more aggressive defense, counterattacks etc.), most often results in a greater psychological strain due to pressure from players of both teams, coaches, audience, etc.

Taking into account the duration of a basketball game and the fact that referees have to be at right time at right place it can be assumed that referees need to have well developed aerobic capacity. So, the aim of this study was to analyze the aerobic capacity of elite Croatian basketball referees.

### Methods

The study was taken on a sample of 31 referees who were on the A list of the Association of Croatian Basketball Referees in the 2008/2009 season. Their mean age was  $33.3 \pm 5.2$  years with average experience of  $7.3 \pm 5.0$  years.

The functional abilities of referees were determined with the spiroergometric method using a progressive load on the treadmill with a constant slope of 1.5%. Measuring instruments were used (the Cosmed Quark b<sup>2</sup> "breath by breath" spiroergometer, the Technogym Runrace Competition HC1200 treadmill, and the heart rate telemetry monitor, Polar Electro OY CE 0537) providing direct online monitoring and analysis of ventilation and metabolic parameters.

The obtained data were analysed by standard statistical procedures, with statistical software package STATISTICA for Windows.

### Results and discussion

The earlier studies of the aerobic capacity of basketball referees obtained different results. Leicht (2007) estimated the relative maximal oxygen intake of referees by using the classical shuttle run test, where referees reached an average value of  $50.8 \pm 3.2$  ml/kg/min. On the other hand, Holland and Cherry did research on basketball referees back in 1979 and found that the average value of their relative maximal oxygen intake was only 35 ml/kg/min, which made them conclude that referees have a poorly developed aerobic capacity, especially with regard to the physiological demands of officiating at a basketball game. The most likely reasons for such low values of relative maximal oxygen intake of referees are the low rank of referees and the year when the research was conducted. Basketball has evolved significantly over the past

thirty years, which resulted in a much more dynamic movement of players. As players became “faster”, referees had to adapt to their dynamics and became faster too, but also developed more endurance.

The comparison of results of absolute and relative maximal oxygen intake of top Croatian basketball players (Matković et al., 2010) and basketball referees leads to the conclusion that referees have lower values than the average results of basketball players.

Table 1. Basic descriptive statistics of spiroergometric parameters

$VO_2max$  – maximal oxygen intake;  $VO_2max\ rel$  - relative maximal oxygen intake;  $relVO_{2ANT}$  - relative oxygen intake at anaerobic threshold;  $\%VO_{2max\ ANT}$  – percentage of maximal oxygen intake at anaerobic threshold;  $VE_{max}$  – maximal ventilation;  $VE_{Eq}$  – ventilatory equivalent;  $O_2\ pulse$  – oxygen pulse;  $HR_{max}$  – maximal heart rate;  $HR_{ANT}$  – heart rate at anaerobic threshold;  $\%HR_{max\ ANT}$  – percentage of maximal heart rate at anaerobic threshold

	MEAN	SD	Min	Max	maxD	K-S p
$VO_2max$	4,59	0,48	3,77	5,60	0,0871	0,973
$VO_2max\ rel$	52,49	5,80	43,15	65,56	0,1217	0,748
$relVO_{2ANT}$	45,22	5,36	35,35	56,76	0,1191	0,771
$\%VO_{2max\ ANT}$	86,19	4,35	75,43	94,84	0,1405	0,573
$VE_{max}$	158,48	19,75	119,70	198,50	0,0912	0,959
$VE_{Eq}$	33,96	3,85	22,00	41,00	0,1685	0,342
$O_2\ pulse$	25,28	3,50	20,10	38,10	0,1418	0,561
$HR_{max}$	187,12	8,75	169,00	204,00	0,0853	0,978
$HR_{ANT}$	170,16	8,75	152,00	184,00	0,1205	0,759
$\%HR_{max\ ANT}$	90,97	3,07	84,10	95,78	0,1435	0,545

However, if their results are compared with the results of players according to their playing positions, it can be concluded that referees have a higher aerobic capacity than the players at the center position and lower than the players at the guard position. Their average values of maximal oxygen intake are on the level of forward players.

When referees are compared with non-athletic population in Croatia, it is apparent that the results are significantly better on average and that referees are mostly in the categories of very good or excellent aerobic capacity (Heimer et al., 2004).

The resulting values for heart rate and oxygen intake on the anaerobic threshold with ventilation/metabolic parameters correspond to the values that are characteristic of sporting activities which are dominated by aerobic energy processes, because the respondents crossed the anaerobic ventilation threshold at a very high strain intensity.

With the mean results of absolute ( $4.59 \pm 0.48$ ) and relative maximum ( $52.49 \pm 5.80$ ) oxygen intake, the fact that referees, on average, cross the anaerobic ventilation threshold at the value of  $86.19 \pm 4.35\%$  of the maximal oxygen intake and the value of  $90.97 \pm 3.07\%$  of maximal heart rate indicates their well-developed aerobic endurance.

Oxygen pulse is a physiological indicator of the amount of oxygen consumed during a heart beat. Its value is calculated by dividing the received oxygen with the corresponding heart rate at a given moment. It is a non-invasive and objective indicator of the function of the cardiovascular and respiratory systems, and is used today in forecasting the outcome of heart disease (Lavia et al., 2004). It was noted that there were differences among athletes in the values of maximal oxygen pulse and that the maximum value were recorded for athletes in endurance sports such as marathon runners (Padilla et al., 2000). Basketball referees have a relatively high average value of maximal oxygen pulse (25.28 ml/beat) with a rather large range of results (from 20.10 to 38.10 ml/beat). This figure shows a significant efficacy of the cardiorespiratory system of basketball referees, which is likely a consequence of training to maintain their fitness at a high level, which is evident from the value of maximal oxygen intake.

The ventilation equivalent is the ratio between breathing volume and oxygen intake per minute (McArdle et al., 2010) and indicates the amount of inhaled air required for the consumption of a liter of oxygen. When one is at rest, the ventilatory equivalent ranges typically between 23 and 28 liters of air per liter of oxygen (Wilmore et al., 2008). When the strain is moderate, these values do not change; they remain in the specified range. However, when the strain increases and approaches the maximum, the ventilation equivalent rises and can reach values above 30. Basketball referees had an average of 33.96, which indicates the fact that their breathing control matched the requirements of the body at maximum strain on the treadmill.

## Conclusion

Based on the obtained results, we can conclude that referees have a well developed aerobic capacity, similar to top basketball players (Castagna et al., 2009) as well as referees from other team sports (Casajus and Castagna, 2007; Krustup and Bangsbo, 2001; Weston et al., 2007; Castagna and D'Ottavio, 2001).

## References

1. Casajus, J.A., Castagna, C. (2007). Aerobic fitness and field test performance in elite Spanish soccer of referees different ages. *Journal of Science and Medicine in Sport*, 10(6), 382-389.
2. Castagna, C., S. D'Ottavio. (2001). Effect of maximal aerobic power on match performance in elite soccer referees. *Journal of Strength and Conditioning Research*, 15(4):420-425.
3. Castagna, C., Abt, G., D'Ottavio, S. (2007). Physiological Aspects of Soccer Refereeing Performance and Training. *Sports Medicine*, 37(7), 625-646.
4. Castagna, C., Abt, G., D'Ottavio, S. (2004). Activity profile of international-level soccer referees during competitive matches. *Journal of Strength and Conditioning Research*, 18(3):486-490.
5. Castagna, C., Chaouachi, A., Rampinini, E., Chamari, K., Impellizzeri, F. (2009). Aerobic and explosive power performance of elite Italian regional-level basketball players. *Journal of Strength and Conditioning Research*, 23(7):1982-1987.
6. Heimer, S., Mišigoj-Duraković, M., Ružić, L., Matković, B., Prskalo, I., Beri, S., Tonković-Lojović, M. (2004). Fitness level of adult economically active population in the republic of Croatia estimated by EUROFIT system. *Collegium Antropologicum*, 28(1):223-233.
7. Holland, J.C., Cherry, R.B. (1979). Aerobic capacity, body composition, and heart rate response curves of high school basketball officials. *Journal of Sports Medicine and Physical Fitness*, 19(1):63-72.
8. Krustup, P. and Bangsbo, J. (2001). Physiological demands of top-class soccer refereeing in relation to physical capacity: effect of intense intermittent exercise training. *Journal of Sports Sciences*, 19, 881-891.
9. Lavia, C., Milani, R., Mehra, M. (2004). Peak exercise oxygen pulse and prognosis in chronic heart failure. *The American Journal of Cardiology*, 93(5):588-593.
10. Leicht, A.S. (2004). Cardiovascular stress on an elite basketball referee during national competition. *British Journal of Sports Medicine*, 38 (4), E10.
11. Leicht, A.S. (2007). Aerobic power and anthropometric characteristics of elite basketball referees. *Journal of Sports Medicine and Physical Fitness*, 47 (1), 46-50.
12. Leicht, A.S. (2008). Physiological demands of basketball refereeing during international competition. *Journal of Science and Medicine in Sport*, 11 (3), 357-360.
13. Matković, B. (ur) Antropološka analiza košarkaške igre. Kineziološki fakultet Sveučilišta u Zagrebu, Hrvatski košarkaški savez, Zagreb.
14. McArdle, W.D., Katch, F.I., Katch, V.L. (2010). Exercise physiology. Nutrition, energy, and human performance. 7<sup>th</sup> edition. Baltimore: LWW, Walters Kluwer.
15. Mildenhall, B., Holmin, J. (2004). Do You have the right level of tension? *Fiba Assist Magazine*, 43-44.
16. Padilla, P.J., Ojeda, C.P., Fernández. Ch.Y., Licea, M.J. (2000). Pulso máximo de oxígeno en atletas mexicanos de alto rendimiento. *Rev INER*. 13 (2): 73-84.
17. Weston, M., Castagna, C., Impellizzeri, F., Rampinini, E., Abt, G. (2007). Analysis of physical match performance in English Premier League soccer referees with particular reference to first half and player work rates. *Journal of Science and Medicine in Sport*, 10(6):390-7.
18. Wilmore, J.H., Costill, D.L., Kenney, W.L. (2008). Body composition in sport. U: *Physiology of Sport and Exercise*. Wilmore, J., Costill D.L. (ur). 4<sup>th</sup> ed. Champaign, IL: Human Kinetics. Str. 318-327.

## PHYSICAL ACTIVITY IN SCHOOL – THE EFFECTS OF TWO EXTRA LESSONS OF PHYSICAL ACTIVITY 10 AND 12 YEARS OLD SCHOOLCHILDREN

Lise Kjoenniksen<sup>1</sup>, Ingunn Fjørtoft<sup>1</sup> and Nora Wium<sup>2</sup>

<sup>1</sup>Faculty of Arts, Folk Culture and Teacher Education, Telemark University College

<sup>2</sup>Research Centre for Health Promotion, Faculty of Psychology, University of Bergen

### Purpose

Based on a new White Paper the Ministry of Education the academic school year 2009-2010 introduced two extra school hours of physical activity (PA) for 5<sup>th</sup> till 7<sup>th</sup> grade pupils. The background for this White Paper is that children and youth become more and more inactive and therefore it is a great need for new initiatives in this area. The aim of the project was to make a survey of which activities that give best effect and how it should be organized. Another goal of the project is to evaluate how the project meets the national recommendation of one hour of MVPA PA per day.

### Methods

There have been used different methods in this study. First it was undertaken a systematic observation by map of the schools outdoor areas in 2009. Then an intervention-period followed that comprised 5 weeks of organized PA, and then 5 weeks of free activities. Accelerometer was used to measure PA, as this measurement gives objective measure of the intensity/effect of the different activities and organisation forms.

### Results

A goal of this project was to see which possibilities there is to arrange for PA in one school. The results showed that the facilities in general were good, but that the pupils not use much of their out door area. Objective measurements by accelerometer confirmed no significant differences between grades, but boys in 5<sup>th</sup> grade had higher odds ratio to be more active in both teacher-organized and free activity.

### Conclusions

The school has rich environment for practicing PA related to natural environments, fields and constructions. Both organizing forms seemed to meet the recommendations of 60 min. MVPA. A combination of organized and free activity meet the intentions of the amendment and both organizing forms seem to meet the recommendations of 60 min. MVPA.

## EFFECT OF CONTINUOUS MOTOR LEARNING WITH DANCE AND MUSIC ON PHYSICAL AND MENTAL FITNESS IN THE OLDER POPULATION: THE MAGDEBURG DANCE STUDY

Anita Hökelmann, Peter Blaser, Wolfgang Lehmann and Kristinn Heinrichs

*Otto von Guericke University Magdeburg, Department of Sport Science*

### Purpose

Fitness, both mental and physical, is a crucial contributing factor to the psychosocial and physical well-being of the older population. Physical activities which promote coordinated movement not only strengthen the neural network between sensory and motor systems and establish new neural connections. One such measure, choreographed dance movements require the highest cognitive and sensorimotor integration for learning (Brown, et. al. 2007). Dance movements involve synchronized and highly organized body movements in a spatial and auditory sequence; the motor sequence is integrated with interval timing such as the rhythms and beats found in music (Brown, et. al. 2005). Dance movements can be regarded as the motor output of the central music processing system operating in tandem with central pattern processing. The current two-year intervention program of dance combined with music was implemented as a means to examine the extent to which music and dance contribute to the delay of, or improvement in, age-related lags between cognitive processing and motor production. One of the principle aims of the current investigation was to determine if continuous motor learning of dance sequences integrated with music would have positive effects on motor and mental fitness

### Methods

Subjects were randomly assigned into five experimental groups (n=130) and two control groups (n=40) for the two-year program. The experimental group participated in 90 minutes' weekly intervention using music and movements from different dance styles, the control groups participated in fitness exercises. Fitness indicators of balance/equilibrium, reaction time, coordination/rhythm ability, fluid intelligence, analytic skills, and concentration memory were measured.

After the first year of the study, the following changes were realized:

Improvements in static equilibrium among the females although the males demonstrated statistically significantly better equilibrium measures than females at the outset of the investigation. Although dynamic equilibrium measures in the females improved over the 12 months, there was no significant difference between experimental and control groups. Reaction time and indicators of fluid intelligence demonstrated a statistically significant improvement for the experimental groups. The coordination/rhythm ability for the females also demonstrated a statistically significant improvement after the first year of training.

### Conclusions

Observation of the individual parameters over the first year of this multi-year investigation has resulted in significant improvements in the indicators of fluid intelligence. The experimental group has demonstrated significant cognitive and psychomotor improvements, particularly in their ability to recognize and adapt to spatial imaginative capacities as well as the ability to recognize and execute complex movement patterns.

1. Brown, S. (2007). Contagious heterophony: a new theory about the origins of music. *Musicae scientiae*, 11, 3-26.
2. Brown, S., Martinez, M. J. & Parsons, L. M. (2005). The neural basis of human dance. *Cerebral cortex*, 16, 1157-1167.

## HEMATOLOGICAL ADAPTATION IN AN ELITE HIMALAYIST CLIMBER? SINGLE CASE STUDY

Gaizka Mejuto<sup>1</sup>, Julio Calleja-González<sup>1,2</sup>, Josean Lekue<sup>2</sup>, Xabier Leibar<sup>2</sup>, Julen Erauzkin<sup>2</sup>,  
Maialen Beldarrain<sup>2</sup>, Ramón Gárate<sup>3</sup> and Nicolás Terrados<sup>4,5</sup>

<sup>1</sup>Laboratory of Analysis of Sport Performance, Sport and Physical Education Department,  
Faculty of Sport Sciences, University of the Basque Country

<sup>2</sup>Sport Performance Center, Culture Department. Basque Government

<sup>3</sup>Traumatology Department, Gipuzkoa Policlinic

<sup>4</sup>Regional Unit of Sport Medicine- Avilés City-Council Foundation

<sup>5</sup>Functional Biology Department, University of Oviedo, Spain

Extreme altitude mountaineering (himalayism) causes changes in the human body. However, longitudinal studies at sea level in elite himalayists are scarce.

### Purpose

The main aim was to analyze the changes before expedition (BEX) vs. after expedition (AEX) during 7 years (one expedition per year) divided in 2 parts. First part [(first 3.5 years (BEX1) vs. second 3.5 years (BEX2)] of hematological parameters on an elite himalayist during expeditions to the 14 highest peaks without supplementary oxygen.

### Methodology

Longitudinal and single case study. Blood samples were taken at sea level under laboratory standards. Analyzed parameters were Red Cell Mass (RCM), Packed Cell Volume (PCV), Hemoglobin concentration (Hb), and Mean Cell Volume (MCV). Values were shown as Means  $\pm$  SD. Changes in variables were analyzed with “Student T Test” for independent samples using SPSS Statistical Package (17.0).

### Results

All parameters changed after expeditions: RCM [BEX:  $4.69 \pm 0.3$  10<sup>12</sup>/L vs. AEX:  $5.27 \pm 0.5$  10<sup>12</sup>/L; ( $p < 0.01$ )], PCV [BEX:  $42.49 \pm 1.9$  % vs. AEX:  $48.35 \pm 3.7$  %; ( $p < 0.01$ )], Hb [BEX:  $14.76 \pm 0.59$  gr/dl vs. AEX:  $16.49 \pm 1.52$  gr/dl; ( $p < 0.01$ )], MCV [BEX:  $90.76 \pm 3.1$  fl vs. AEX ( $93.02 \pm 2.6$  fl); ( $p < 0.01$ )]. RCM [BEX<sub>1</sub>:  $52.01 \pm 2.5$ % vs. BEX<sub>final</sub>:  $47.22 \pm 3.3$ %; ( $p < 0.01$ )], Hb [BEX<sub>1</sub>:  $17.9 \pm 0.9$  gr/dl vs. BEX<sub>2</sub>:  $16.07 \pm 1.4$  gr/dl ; ( $p < 0.01$ )].

### Conclusion

In our study, according to existing scientific literature, the hypoxia during expeditions to extreme altitude causes changes on hematological parameters. This longitudinal study also point out the possibility of a lower hematological response to hypoxia after years of exposure to acute chronic hypoxia.



## MODELING LONGITUDINAL CHANGES IN MAXIMAL-INTENSITY EXERCISE PERFORMANCE IN YOUNG ROWING ATHLETES

Pavle Mikulić<sup>1</sup>, Allan M. Nevill<sup>2</sup> and Goran Marković<sup>1</sup>

<sup>1</sup>*School of Kinesiology, University of Zagreb, Croatia*

<sup>2</sup>*School of Sport, Performing Arts and Leisure, University of Wolverhampton, Walsall, United Kingdom*

### Purpose

The purpose of the present multiple longitudinal study was to apply the multilevel regression modeling with multiplicative allometric equations in order to examine the effect of age and body size on parameters of maximal-intensity exercise performance, as evaluated using the “all-out” 30-second rowing ergometer test, in 12-18-year-old rowing athletes.

### Methods

The participants (n=171) performed an “all-out” 30-s effort on a Concept II rowing ergometer and were reassessed after 12 months. Exercise performance was expressed as mean power output, as calculated and displayed by the Concept II computer and recorded by the investigators. A multilevel modeling program (MlwiN) was used to investigate the effects of chronological age, stature and mass on mean power output.

### Results

The relative improvements in mean power output between two assessment occasions were [mean (SD)] +34% (23%) in 12-yr-olds, +18% (13%) in 13-yr-olds, +15% (12%) in 14-yr-olds, +11% (8%) in 15-yr-olds, +5% (8%) in 16-yr-olds, +3% (5%) in 17-yr-olds and +2% (3%) in 18-yr-olds. The mean power output value increased +157% between the ages of 12 and 19. The results of the multilevel regression analyses for the log-transformed mean power output (dependent variable) indicated that body mass, stature and chronological age were all significant explanatory variables with exponents [mean (standard error of estimate)] of 0.56 (0.08), 1.84 (0.30) and 0.06 (0.01), respectively. Mean power output clearly increase with body size; however, there is an additional acceleration in the rate of power development that is initially greater than body size, but begins to peak and level-off at about 17-18 years of age (estimated using elementary differential calculus).

### Conclusion

Short-term maximal-intensity exercise performance increases in young rowing athletes during the course of adolescence by about 150% between the ages of 12 and 19. Mean power output during the modified Wingate test increases with body size, and this increase is similar to the one predicted by the theory of geometric similarity (i.e. the obtained allometric exponents for mass and stature are close to the theoretical exponents of 0.67 for body mass and 2 for stature, as predicted by the theory of geometric similarity).

## MORPHOLOGICAL CHARACTERISTICS OF FEMALE HANDBALL PLAYERS

Antonela Nedić<sup>1</sup>, Tomislav Rupčić<sup>1</sup> and Marko Meštrović<sup>2</sup>

<sup>1</sup>Faculty of Kinesiology, University of Zagreb, Croatia

<sup>2</sup>School of Medicine, University of Zagreb, Croatia

Success in sports competition has been associated with specific anthropometric characteristics, body composition and somatotype for long time. According to the requirements of particular sport discipline some morphological characteristics could be necessary or can have significant influence on sport performance.

The aim of this investigation was to determine body composition and somatotype of elite Croatian female handball players and to detect possible differences in relation to playing position.

### Methods

The sample consisted of 32 elite Croatian female handball players. The mean age (SD) of the players was  $24.27 \pm 4.45$  years. Ten anthropometric measures required for the calculation of body composition indexes and somatotype components were obtained according to the instructions of IBP. Somatotype was assessed according to the Heath-Carter method. Standard descriptive statistics methods were used and ANOVA to examine the differences between playing positions.

### Results and discussion

Table 1. Morphological characteristics of female handball players (arithmetic mean  $\pm$  standard deviation). Significant differences are bolded

	Total (32)	Goalkeeper (6)	Pivot (6)	Wing (7)	Back position (13)
Body height (cm)	176.9 $\pm$ 5.9	<b>180.2 <math>\pm</math> 5.0</b>	<b>180.5 <math>\pm</math> 6.7</b>	<b>173.7 <math>\pm</math> 3.0</b>	<b>175.4 <math>\pm</math> 5.9</b>
Body mass (kg)	72.7 $\pm$ 7.9	<b>77.9 <math>\pm</math> 10.5</b>	<b>78.0 <math>\pm</math> 6.2</b>	<b>68.0 <math>\pm</math> 3.2</b>	<b>70.4 <math>\pm</math> 7.8</b>
Endomorphy	4.3 $\pm$ 0.8	<b>5.3 <math>\pm</math> 0.4</b>	3.5 $\pm$ 0.3	3.7 $\pm$ 0.7	4.0 $\pm$ 0.5
Mesomorphy	3.6 $\pm$ 1.3	3.8 $\pm$ 2.2	3.2 $\pm$ 0.4	<b>4.3 <math>\pm</math> 1.3</b>	3.2 $\pm$ 1.4
Ectomorphy	2.2 $\pm$ 1.0	2.0 $\pm$ 0.7	2.5 $\pm$ 0.3	2.0 $\pm$ 0.5	2.6 $\pm$ 1.2
% body fat	19.2 $\pm$ 3.5	21.1 $\pm$ 4.3	20.0 $\pm$ 6.7	<b>17.9 <math>\pm</math> 3.2</b>	18.9 $\pm$ 3.4
BMI	23.3 $\pm$ 1.8	23.9 $\pm$ 2.2	23.9 $\pm$ 1.8	22.0 $\pm$ 0.4	22.8 $\pm$ 1.8

Handball players are higher than nonselected Croatian female population of the same age, but not as tall as female basketball or volleyball players. In their somatotype endomorphy dominates in all playing positions. The results of the study demonstrated that body composition and somatotype were different between players who were specialised for different playing position. The wings are the shortest, with the lowest amount of fat and the most pronounced mesomorphic component.

## CHANGES IN ANTHROPOMETRIC PARAMETERS AND OXYGEN CONSUMPTION IN SOCCER PLAYERS DURING THE CONDITIONING PERIOD

Jadranka N. Plavšić, Nebojša S. Antić, Slavica A. Đorđević-Šaranović, Tamara D. Gavrilović and Sanja Mazić

*National Institute of Sport, Belgrade, Serbia*

### Introduction

The differences in anthropomorphic and cardio-respiratory parameters among young athletes could be influenced by the biological development itself or they could appear under the impact of the training stimulus that is characteristic for a certain type of sport.

### Aim

The aim of this study was to compare some of the anthropometric parameters and oxygen consumption between the two measurements (in the period of 75 days before and after conditioning period) in a selected group of soccer players.

### Methods

This study includes 12 selected soccer players aged  $23.77 \pm 2.89$  years. All players are members of teams that compete in division one. On average they have been training for  $15.92 \pm 2.60$  years. All the players train  $21.67 \pm 4.62$  hours per week. The research was conducted in the laboratory for functional diagnostics in the National Institute of Sport in Belgrade on a Treadmill T200 Cosmed and using Quark b2 Breath by Breath Pulmonary Gas Exchange ( $VO_2$  max,  $VO_2$  max/kg). We measured body height, body weight, BMI, body fat % (on TANITA scale Body Composition Analyzer Type BC-418MA).

We performed two measurements on a selected group of soccer players. The first measurement was done in January 2011. The second took place in March 2011. In that period soccer players had organized conditioning period (with a strict diet regime chosen by a nutritionist) and in the last few days they began their matches.

For comparison of measured parameters, Student's T-test was used.

### Results

The comparison between the measured parameters between the two measurements showed a statistically significant difference in body fat % ( $11.97 \pm 3.47\%$  in the first measurement vs.  $10.27 \pm 3.81\%$  in the second measurement ( $p < 0.01$ )), while regarding all other parameters, we did not notice any significant differences.

### Conclusions

From the measured results we can conclude that the training process had no significant influence on change in the measured parameters except for body fat %. The comparison between the two measurements showed that the soccer players had a lower body fat percent in the second measurement compared to the first measurement, and that can be explained by adequately controlled diet regime and regular meals.

## THE INFLUENCE OF THE SKI HELMETS ON SOUND LOCALIZATION AND DISTANCE IDENTIFICATION ON SKI SLOPE

Lana Ružić<sup>1</sup>, Mario Kasović<sup>1</sup>, Anton Tudor<sup>2</sup>, Vjekoslav Cigrovski<sup>1</sup> and Bojan Matković<sup>1</sup>

<sup>1</sup>*Faculty of Kinesiology, University of Zagreb, Croatia*

<sup>2</sup>*Orthopaedic Clinic, Lovran, Croatia*

### Purpose

Due to the high number of injuries on the ski slopes the ski helmets have become widely used protective gear. The aim of this study was to investigate the effects of wearing a ski helmet on auditory localization and sound distance identification in the frontal plane.

### Methods

Twenty-three participants (6 female, 17 male; age  $30.7 \pm 10.2$ ) were tested on the slope with and without wearing the protective ski helmet in random order with six randomly alternating upcoming acoustic stimuli for each condition. The specific ski sound stimuli were produced by upcoming skiers from the back of respondents. In both conditions each subject had to respond as soon as possible to different spatially distributed sound stimuli and to signalize the correct side of his/her arrival.

### Results

The results of the Wilcoxon Matched Pairs test showed statistically significant difference in ability to localize the specific ski sounds without and with wearing a protective ski helmet ( $72.5\% \pm 15.6\%$  correct answers without helmet vs.  $61.3\% \pm 16.2\%$  with helmet;  $p < 0.01$ ). In identifying the distance of the sound without and with wearing a helmet the results were also in favor of not wearing the helmet (Student t- test for dependant samples: without helmet on  $73.4 \pm 5.56$  m distance vs. with helmet on  $60.29 \pm 6.34$  m distance;  $p < 0.001$ ). On average, the subjects localized sounds 11% better without helmet and the performance on this test did not relate to whether they were used to wearing the helmet before ie. wearing a helmet did not lead to a positive adaptation on the sound localization in space ( $r = -0.09$ ). The distance identification occurred 13m sooner without the ski helmets and in this case the results did depend on previous use of helmets ( $r = -0.447$ ;  $p < 0.05$ ).

### Conclusions

The ski helmets might limit the ability to localize the sound and interfere with the distance when the sound is firstly heard. Although the overall protective value of the ski helmets is not arguable, due to the significant auditory limitations caused by wearing helmets its protection abilities role might be compromised. The skiers should be aware of that fact and accordingly adjust their behavior on the slope.

## TRACKING OF CARDIORESPIRATORY FITNESS AND FATNESS FROM ADOLESCENCE TO MIDDLE ADULTHOOD

Maroje Sorić<sup>1</sup>, Mirjana Jembrek Gostović<sup>2</sup>, Mladen Gostović<sup>2</sup>,  
Marija Hoćevar<sup>2</sup> and Marjeta Mišigoj-Duraković<sup>1</sup>

<sup>1</sup>The Faculty of Kinesiology, University of Zagreb, Croatia

<sup>2</sup>Institute for Cardiovascular Diseases Prevention and Rehabilitation, Zagreb, Croatia

### Purpose

The principal aim of this investigation was to assess tracking of cardiorespiratory fitness and fatness from adolescence to adulthood.

### Methods

The sample consisted of 62 participants (36 male; 26 female), median age: 43 (range: 36-43). During adolescence measurements were taken at the age of 15. The same procedures were repeated 18 or 25 years later when the participants were around 36 or 43 years old. Fatness was evaluated through body mass index (BMI) and the sum of triceps, calf, suprailiac and subscapular skinfolds while fat distribution was assessed through the ratio of central skinfolds and the sum of skinfolds. Peak oxygen uptake was measured by a portable breath-by-breath metabolic system during a maximal treadmill exercise test. In addition, ventilatory aerobic and anaerobic thresholds were determined.

### Results

BMI and subcutaneous fat showed very moderate to good tracking from adolescence to middle adulthood in both gender, while for body fat distribution this was true only in men but not women. Interage correlations from adolescence to middle adulthood reached 0.61 ( $p < 0.001$ ), 0.54 ( $p < 0.001$ ) and 0.51 ( $p = 0.003$ ) in males and 0.17 ( $p = 0.47$ ) in females for BMI, sum of skinfolds and skinfold ratio, respectively. The observed tracking of cardiorespiratory fitness was less good. Peak oxygen uptake tracked moderately (partial  $r = 0.50$ ,  $p < 0.001$  for absolute  $VO_{2peak}$  and partial  $r = 0.30$ ,  $p = 0.03$  for relative  $VO_{2peak}$ ), whereas no tracking of aerobic (partial  $r = 0.07$ ,  $p = 0.62$ ) or anaerobic threshold (partial  $r = 0.16$ ,  $p = 0.31$ ) was noted for the same age interval.

### Conclusions

Fatness tracked reasonably well from adolescence to middle adulthood, whilst tracking of cardiorespiratory fitness for the same age interval was poor to moderate for some indicators of fitness or not significant for the others. Therefore, preventive strategies regarding fatness should focus on high-risk groups of adolescents. Conversely, strategies to increase cardiorespiratory fitness should not be focused on adolescents with low fitness, but include all adolescents irrespective of their cardiorespiratory fitness status.

## DAILY ENERGY INTAKE, PHYSICAL ACTIVITY AND PHYSICAL FITNESS LEVELS AND SOME EATING HABITS OF 11-YEARS OLD STUDENTS

Gregor Starc<sup>1</sup>, Marjeta Kovač<sup>1</sup>, Gregor Jurak<sup>1</sup>, Saša Dremelj<sup>1</sup>, Petra Kovač<sup>2</sup>,  
Marjeta Mišigoj-Duraković<sup>3</sup>, Maroje Sorić<sup>3</sup> and Janko Strel<sup>1</sup>

<sup>1</sup>Faculty of Sport, University of Ljubljana, Slovenia

<sup>2</sup>University Medical Centre, Ljubljana, Slovenia

<sup>3</sup>Faculty of Kinesiology, University of Zagreb, Croatia

### Purpose

Sedentary lifestyles are increasingly implied in the rise of metabolic syndrome in children and adolescent. Special consideration should be given to behavioural and lifestyle factors that are more readily adaptable and may have an early effect on metabolic risk factors. The purpose of this study was to assess energy intake, physical activity, physical fitness, BMI and certain eating habits (breakfast and snacks after 8p.m.) of 11-year old children in Slovenia.

### Results

The cluster sample of 72 students (35 boys and 37 girls), aged 11.8 ( $\pm 0.3$ ) years, who participated in a larger international study in May 2006, was used for this purpose. The energy expenditure was assessed by multiple-sensor body monitors (SenseWear Armband; BodyMedia Inc., Pittsburgh, PA, USA). The energy intake and frequency of breakfast and snacks after 8p.m. were assessed using a self-report questionnaire (My Pyramid Tracker Tutorial; USDA, Center for Nutrition Policy and Promotion, USA) during two weekdays and two weekend days. BMI was calculated according to IOTF standards. Physical fitness levels were evaluated by results of tests: sit-ups, hang-up, 600m dash, 20 m endurance shuttle-run and  $VO_2$  max. A Pearson correlation coefficient was used to test the connections between observed variables and multivariate analysis of variance was used to test the differences between groups according to their physical fitness, the frequency of the two observed meals and gender.

### Results

Results show that boys and girls underestimated their daily energy intakes. They reported a one-third lower intake than reported in other similar studies, especially those students with an increased BMI. Girls were less physically active than boys. In both groups the physical activity levels were higher during the week than on weekends, but the energy intakes were higher during the weekends. There were no significant connections between BMI and physical activity levels. Negative correlations between BMI and energy intake were found. BMI was significantly associated with all selected tests of physical fitness except the sit-ups test. Results also show that half of students do not eat breakfast regularly during weekdays; more than half of the girls and less than one third of the boys eat snacks after 8p.m. However, the relationship between the frequency of the two observed meals, physical fitness and gender of the students was negligible.

### Conclusions

We can conclude that the assessment of energy intake using a self-report questionnaire is problematic in this age group. The measurements of physical activity level showed that students should be more active during weekends.

## IMPACT OF WEIGHT LOSS ON HEMATOLOGICAL PARAMETERS IN MALE JUDOKAS

**Tatjana Trivić**

*Faculty of Sport and Physical Education, University of Novi Sad, Serbia*

### **Abstract**

#### **Purpose**

The purpose of this study was to evaluate the effect of weight loss on hematological parameters in male judokas.

#### **Methods**

Twenty Serbian male judokas were examined in the early morning of the first day (pre-values) and the last day (post-values) of a 10-day pre-competition training period. Of the 20 subjects, 10 needed to reduce weight (WR group), and the other 10 did not (control group). Blood samples were collected from all subjects on the first (initial measurement) and last (final measurement) days of the 10-day training program, at 07.00am. Venous blood samples were drawn from the cubital vein, and the red blood cell count (RBC), hemoglobin (Hb), hematocrit (Hct), ferritin (Ferr) level, mean corpuscular hemoglobin concentration (MCHC), corpuscular volume (MCV), potassium (K), sodium (Na) and lipid profile were measured.

#### **Results**

At the initial measurement, no significant differences were noted in measured hematological parameter. Compared with basic data and control group, decrease in Hb, Hct, RBC, Ferr and MCHC was noted in WR group. Also, Hct and MCV statistically significantly decreased in control group. The lipid profile was unchanged in both groups, except for the triglycerides which decreased in WR group, after the final measurement. Also, K significantly decreased compared with basic data in WR group.

#### **Conclusion**

The most obvious finding in the study was that red blood cell count is highly respondent to physical activity, especially in WR group. Weight loss before competition induces alteration in hematological parameters, which can lead to the decline of functional state and exercise ability of male judokas. Judokas are advised not to lose weight before a competition.



**6<sup>th</sup> INTERNATIONAL  
SCIENTIFIC  
CONFERENCE ON  
KINESIOLOGY**

**“INTEGRATIVE POWER OF  
KINESIOLOGY”**

# **Biomechanics and Motor Control**

**Editors:**

**Prof. Vladimir Medved, PhD**

**Prof. Goran Marković, PhD**

**Peer Reviewers:**

**Prof. Goran Marković, PhD**

**Prof. Vladimir Medved, PhD**

**Prof. Tomislav Pribanić, PhD**

**Prof. Goran Sporiš, PhD**



**Secretary:**

**Mario Kasović, PhD**



## COMPUTER ASSISTED FEEDBACK IN PHYSICAL EDUCATION

Arnold Baca

*Department of Biomechanics, Kinesiology and Applied Computer Science, ZSU, University of Vienna, Austria*

### Abstract

The Mobile Motion Advisor (MMA) has been developed to support high school students during their exercises in physical education lessons. Teachers may give individual feedback to the students based on performance parameters measured during their activity. Up-to-date sensor, data transmission and processing technologies have been integrated in order to provide easy to use technology to be applied. The paper gives an overview of the hard- and software architecture of the MMA and reports first experiences on the system's practical use.

**Key words:** *Ubiquitous Computing, sensors, performance analysis, client-server system*

### Introduction

In order to motivate people to more physical exercise (Chi et al., 2005; Chi, 2008; Baca et al., 2009; Baca, 2008; Preuschl et al., 2010) new ground is broken by the use of sensor, information and communication technologies. A system has been developed that enables teachers to monitor performance data of high school students and give them individual feedback during their activity. The main architecture of this system (the Mobile Motion Advisor) is presented in the sequel. Some first experiences when applying the systems in school sport are reported.

### The Mobile Motion Advisor

The Mobile Motion Advisor (MMA) helps to evaluate performance parameters and to adapt physical loads of high school students with respect to their individual performance level (Preuschl et al., 2010). It is a specific variant of the Mobile Coaching System developed by the working group of the author (Baca et al., 2010). Parameters characterizing the performances of the students from a whole class can be monitored and observed continuously. In this way, teachers are able to supervise and coach a number of students individually and in parallel. The students get feedback on the quality of their motion/activity. Their performances may be recorded. Thus, positive effects of physical exercise can be highlighted.

In order to obtain performance parameter values like heart rate, velocity or reactive forces, sensors are either attached to the students or mounted onto their sports equipment. The measured data is transmitted to a smartphone via a wireless sensor network (WSN). From there the data is sent to an application server via Internet. Feedback is either automatically generated by a server application or individually provided by the teacher (or an expert having Internet access to the server). A system overview of the MMA is presented in Figure 1.

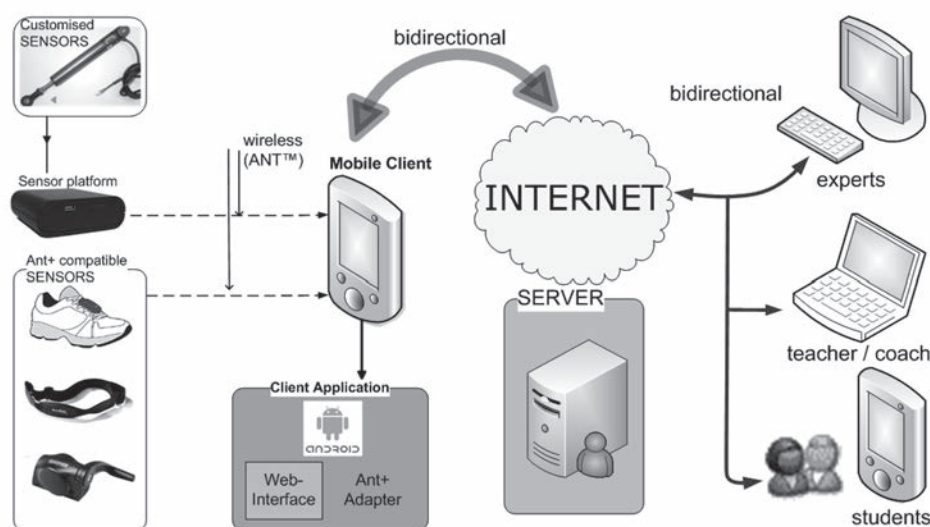

Figure 1. Overview of the MMA.

## Implementation

The current implementation of the MMA (June, 2011) integrates wireless sensors based on the ANT®+ protocol, which is well-established for practical applications in the area of sport. The A-client(s) utilized by the student(s) include(s) a smartphone (Samsung Galaxy 3, Android) and a Bluetooth to ANT+ adapter for the reception of the measured signals. The client application software is implemented in Java.

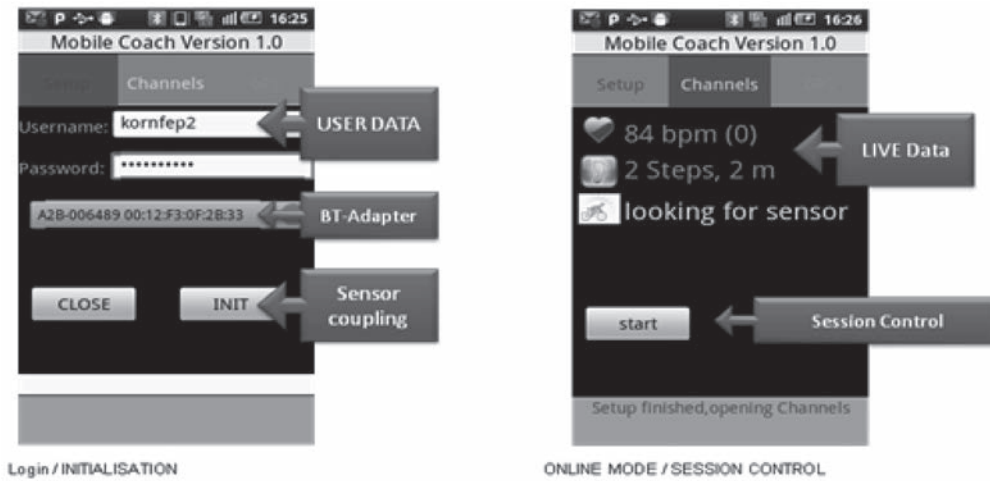

Figure 2. GUI of the mobile A-client application.

As shown in the GUI design of the A-client in Figure 2, the application is listening on different channels for incoming signals from surrounding sensors. In addition, the current GPS location of the student is identified. The measurement data is saved temporarily and – in case the mobile device is connected to the Internet – immediately sent to the host component, where it is stored in an SQL database.

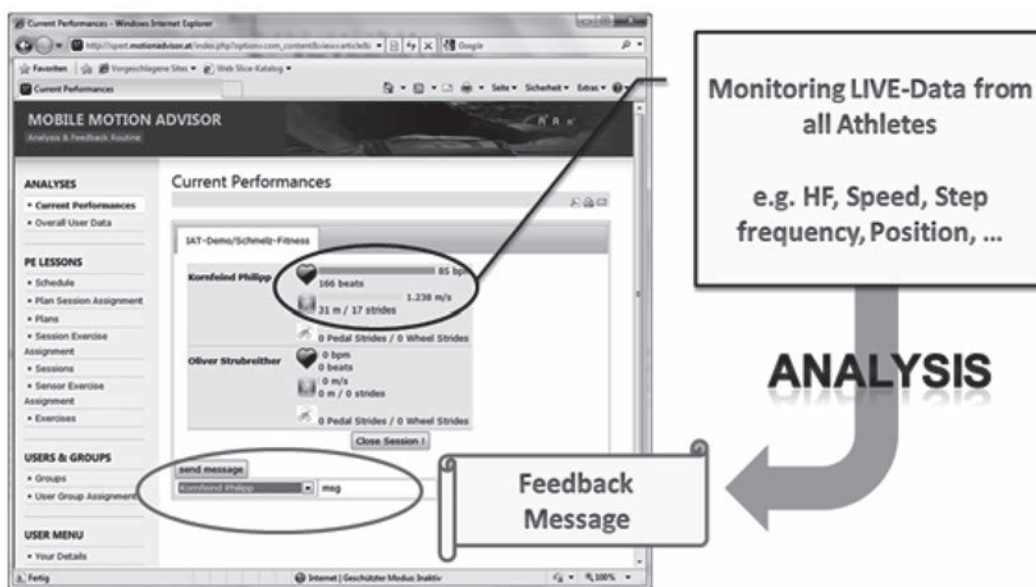

Figure 3. E-client application: Feature for returning feedback messages.

The E-client utilized by the teacher (or expert) is realized using PHP running on an Apache™ HTTP Server. MySQL® Server has been installed and configured as the database. Figure 3 illustrates a screenshot of the E-client application. The recently processed sensor data like the number of strides, distance and speed or current pulse rate are displayed. A tool for visualizing the progress of the measured parameters (for example the heart rate values) in real time is available (Figure 4). In this way, teachers (experts) are able to observe/analyze the students' performance throughout the entire training. A specific feature allows them to return individual feedback messages (Figure 3). Such notifications are sent

back to the mobile device via the server. They are displayed as a text message including an alert beep and vibration signal. In addition feedback messages are audible as a voice output over the integrated loudspeaker.

## Use cases

Three areas of application have been implemented so far: Running, mountain biking and resistance training. For the later, one specific exercising machine has been equipped with sensor technology. A survey of sensors and parameters relevant to these sports (cf. Baca et al., 2010) can be found in Table 1. Sensors already implemented are written in bold.

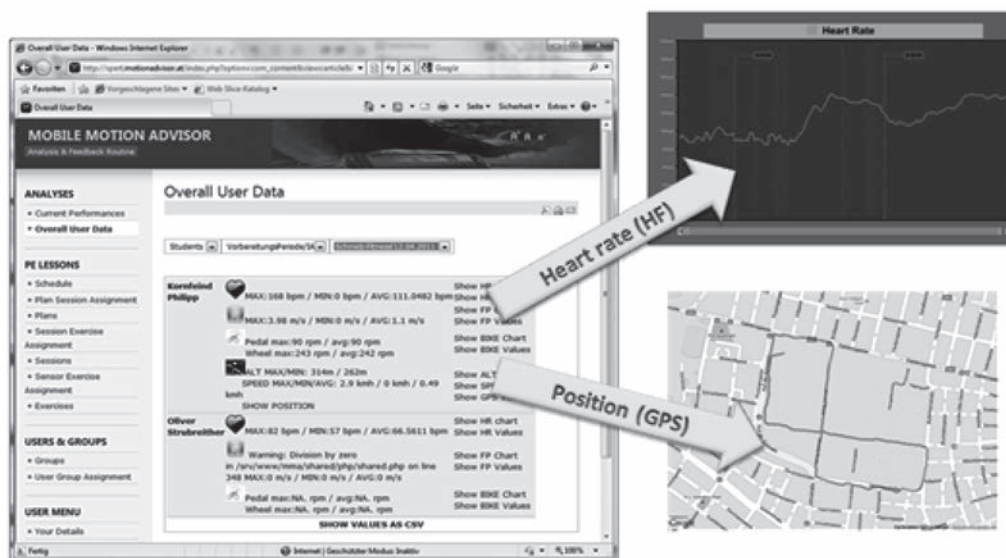

Figure 4. E-client application: Visualizing tool.

In running, commercially available heart rate monitors (HRM) are used to obtain heart rate (HR) and heart rate variability (HRV). Standard GPS and stride sensors are used for the acquisition/determination of position and speed parameter values.

Table 1. Parameter/sensor combinations in selected sports (cf. Baca et al., 2010).

	Sensor	Parameter
Running	<b>Stride Sensor</b>	Distance, cadence, velocity
Running/Cycling	<b>Heart rate monitor (HRM)</b>	HR, HRV
	<b>GPS</b>	Position, velocity
Cycling/Mountain biking	<b>Gear position indicator</b>	Used gear, distance per stride ratio
	Inclinometer	Inclination
	<b>Cadence sensor</b>	Pedaling frequency
	<b>Speedometer</b>	Speed, average speed
Resistance training	<b>Force transducer</b>	Force
	<b>Rotary encoder</b>	Motion amplitude

A heart rate monitor has also been implemented in cycling. The pedaling frequency is determined from a cadence sensor counting the number of pedaling cycles. An electronic gear position indicator helps to assist novice mountain bikers, who often lack the experience in choosing the right gear to master a climb. Speedometers provide information on instantaneous velocity. The A-Client's built in accelerometers might be used as inclination sensors providing information on the angle of gradient of the slope.

One resistance training machine has been equipped with a force sensor and a rotary encoder in order to measure pulling force and to determine handle bar position and velocity. From these parameters work and power of the exercising motion are estimated.

## Experiences

Practical experiences in the application of the MMA could already be gathered in mountain biking, in running and in indoor basketball (mainly running). Positive attitudes from the high-school students towards using the system were identified. Using technology of that or similar kind in physical education was generally supported. There was great interest in documenting performance data, which was guessed to be motivating. There were suggestions for using the MMA even beyond school sport.

Problems with the audibility of the acoustic feedback information during practical lessons (in particular during basket ball) were reported. Some technical problems in the receipt of the feedback information during mountain biking, which need to be resolved, were also noted.

In the opinion of teachers, the MMA is highly innovative and of great fun for the students. The feedback features were particularly praised. Because of the possibility to compare students to each other, the MMA was judged to be motivating. Problems in the application in schools were expressed due to the costs for the equipment. Great potential for the system is seen for sports oriented high-schools and for mass/amateur sports.

## References

1. Baca, A. (2008). Feedback systems. In P. Dabnichki, A. Baca (Eds.), *Computers in Sport* (pp. 43-67). Southampton: WIT Press.
2. Baca, A., Dabnichki, P., Heller, M. & Kornfeind, P. (2009). Ubiquitous computing in sports: A review and analysis. *Journal of Sports Sciences*, 27 (12), 1135-1346.
3. Baca, A., Kornfeind, P., Preuschl, E., Bichler, S., Tampier, M. & Novatchkov, H. (2010). A Server-Based Mobile Coaching System. *Sensors*, 10 (12), 10640-10662.
4. Chi, E.H. (2008). Sensors and Ubiquitous Computing Technologies in Sports. In P. Dabnichki, A. Baca (Eds.), *Computers in Sport* (pp. 249-268), Southampton: WIT Press.
5. Chi, E.H., Borriello, G., Hunt, G. & Davies, N. (2005'). Pervasive Computing in Sports Technologies. *IEEE Pervasive Computing*, 4 (3), 22-25.
6. Preuschl, E., Baca, A., Novatchkov, H., Kornfeind, P., Bichler, S. & Böcskőr, M. (2010). Mobile motion advisor – a feedback system for physical exercise in schools. In A. Sabo, S. Litzengerger, P. Kafka, C. Sabo (Eds.), *The Engineering of Sport 8. Procedia Engineering 2* (2). (pp. 2741-2747), Amsterdam: Elsevier.

## MUSCLE FORCE HARMONIC CANON OF TOP KARATE ATHLETES AND WRESTLERS

Jan Babiak<sup>1</sup>, Branislav Strajnić<sup>1</sup>, Nenad Sudarov<sup>1</sup>, Jugoslav Vojinović<sup>2</sup> and Žika Kalentić<sup>1</sup>

<sup>1</sup>Provincial institute for sport, Novi Sad, Serbia

<sup>2</sup>Sportska akademija Beograd, Serbia

### Abstract

The aim of this study was to determine the relationship between muscle force of top karate athletes and wrestlers. In this research 19 karate athletes and 32 wrestlers, members of national teams Serbia took part. The measurement was conducted at the Regional Institute of Sport. Muscle force was measured on the right hand grip (PDS) and left also (PLS), force of torso flexors (PTR) and extensors (ONO), and knee extensors (NLA). Muscle force canon of karate athletes and wrestlers have the following relationship: PDS: PLS: PTR: OLE: ONO = 0.98: 0.95: 0.89: 2.54: 6.94 (karate) and PDS: PLS: PTR: OLE: ONO = 1.02: 1.01: 0.90: 2.88: 5.85 (wrestlers). Based on the results we can conclude that the relationship is the result of various training and competing demands of these sports. Ratio of muscle force indicates that the wrestlers compared to karate athletes have stronger arm muscles and torso muscles but lower strength of leg muscles.

**Key words:** muscle force, karate athletes, wrestlers

### Introduction

Aspiration to use certain motor abilities to determine level of preparedness and thus the quality of a particular athlete, is not new. Striving, to overcome improvisation, avoiding the use of a wide range of often unverified or even tests with unfavorable psychometric characteristics, has led to the implementation of laboratory motoric tests in which the pre-determined in any case exact way certain skills are been tested. This attempt is especially noteworthy in the field of strength. One of the exact measurement procedures in this field is dynamometric force measurement of attempted movements. It is a measurement, where the contraction of muscles, under predefined position of basic levers, causes tension transmitted to the probe and through it these mechanical changes in the form of electric voltage can be read on a dynamometer scale. Results obtained this way, measured for each muscle group, are the starting point for the qualification of the force level for each athlete individually. In any case, this topologically oriented characteristic of this ability creates additional confusion among professionals, especially if each result is considered separately, and not based on the fact that in the human body relation between some individual muscle strength is strictly determined and mutually conditioned. For understanding the interdependence, it is necessary to understand the essence of these relations.

### Methods

The sample of respondents consisted of 29 male karate athletes and 32 male wrestlers aged from 21 to 30 years. The sample was drawn from the population of national team members in karate and wrestling from Serbia territory.

In this study the following five topologically defined tests of muscular force and power of particular muscle groups are applied:

- muscle force of right hand flexors - (PDS),
- muscle force of left hand flexors - (PLS),
- muscle force of torso flexors - (PTR),
- muscle force of torso extensors - (OLE),
- muscle force of knee extensors (both legs) - (ONO).

Testing of athletes was conducted in the Regional Institute of Sport (Novi Sad), using the apparatus for dynamometric measurements respecting known measuring procedures. Testing was done in the morning, at a temperature between 18-21 C, with relative humidity between 40-60%. Athletes are tested before the start of the preparatory period. Measurement of force was performed on the electronic reaction dynamometer, with devices for the fixation of examinees and probes of 150, 300, 600 and 1200 kp (manufacturer-Electrical Engineering Institute "Nikola Tesla" Belgrade). The measurement had three phases: period of rest, period of the load and the recovery period. Each measurement was repeated three times and as a result of further processing, maximum muscle force is obtained value for athletes. Of such individual maximal

values obtained by sex and age of examinees: for each subgroup of athletes mean muscle force is calculated and was used for further processing of results. Measuring procedures is complied with the procedure described by Štuka and Heimer (1971) and Amanović, Milošević, Mudrić (2004).

Data processing: Measuring data were statistically analyzed using computer programme Excel.

## Results

In the previous studies on a large sample of athletes, (3, 4, 5, 6, 7) the relationship of certain forces within the individual muscle groups is analyzed. This relation can be interpreted as follows:

$$\text{PDS: PLS: PTR: OLE: ONO} = 1: 1: 1: 2.75 : 5.60.$$

If the force of the left hand flexor is taken as a unit measure, then every athlete should have the same force of other hand, but also force the abdominal muscles close to these values, while the forces of the spinal muscles should be 2.5 times higher and the power of knee extensor 5,5 times bigger than that unit measure. This relationship is defined as muscle force harmonic canon of athletes.

It is logical that the next problem that arises is whether the same principles apply in the area of top of karate athletes and wrestling also. The results of indicated muscle groups in karate and wrestlers have shown the following relationship:

$$\text{PDS: PLS: PTR: OLE: ONO} = 0.98: 0.95: 0.89: 2.54: 6.94 \text{ (karate)}$$

and

$$\text{PDS: PLS: PTR: OLE: ONO} = 1.02: 1.01: 0.90: 2.88: 5.85 \text{ (wrestlers)}.$$

These relations could be approximated to whole numbers, which means that the ideal ratio of measured dynamometric forces of karate athletes should be 1: 1: 1: 2.5: 7, while with wrestlers canon is directed towards better values of force (except with leg muscles), and is: 1: 1: 1: 2.9: 5.85. The nature of these relationships can be explained starting from the basic requirements of these sports. This means that the muscle force harmonic canon of the sample of best wrestlers and karate athletes can be considered as a universal model of relations of dynamometric power of particular muscle groups, which along with favorable assumptions and other factors in the equation specification of success in this sport provides the best condition to achieve maximum value in these sports.

## Discussion

If you have checked previously mentioned rules inside the area of athletes who practice martial arts, it is immediately obvious that there will be no significant changes in relation to the overall force relations. However, considering the nature of sports differences must be expected. And some previous studies (7, 8, 9) have shown that within a representative martial arts karate athletes recorded the lowest level of force and the boxers and wrestlers the highest, which immediately shows the start of the differentiation of these sports to those with the dominant power on one side, and technical sports on the other side.

But the relationship between these forces will not be changed significantly but will be approximately close to the aforementioned muscle power canon derived from the total sample of athletes.

## Conclusion

Muscle force canon of karate athletes and wrestlers have the following relationship: PDS: PLS: PTR: OLE: ONO = 0.98: 0.95: 0.89: 2.54: 6.94 (karate) and PDS: PLS: PTR: OLE: ONO = 1.02: 1.01: 0.90: 2.88: 5.85 (wrestlers). Based on the results we can conclude that the relationship is the result of various competing and training demands of these sports. Ratio of muscle force indicates that the wrestlers compared to karate athletes have a stronger arm muscle strength and trunk muscle strength and lower leg muscle strength. Muscle harmonic canon is, therefore, be seen as generally applicable rule, regulation, model. Every other relationship is looking for additional trainers efforts to correct the problems.

## References

1. Amanović, Đ., Milošević, M. & Mudrić, R. (2004). Methods and means for assessing, monitoring and development of muscle force in special physical education. Zemun: Police College.
2. Babiak, J., Doder, D. Some tendencies of the development of dynamometer power at sportsmen. International scientific conference, "Theoretical, methodology and methodical aspects of physical education 2008"; 337-343. Beograd: University of Beogradu, Faculty of sport and physical ed education.

3. Babiak, J. & Doder, D. (2009). Gender differences in the harmonious canon of dynamometric force relative to athletes' age. *1<sup>st</sup> International Scientific Conference Exercise and quality of life 2009*; 231-236. Novi Sad: Faculty of Sport and Physical Education University of Novi Sad
4. Doder, D., Babiak, J. & Golik-Perić D. (2008). The canon of dynamometric (isometric) power of sportsmen related to age and sex determination. *5<sup>th</sup> International scientific conference on kinesiology* (449-452). Zagreb: Faculty of Kinesiology, University of Zagreb. ISBN 987-953-6378-79-1, CIP 676044.
5. Babiak, J. & Doder, D. (2009). A canon of dynamometric muscle power in male athletes in relation to their age. *Research in sport science. Written and edited by Mike Hughes, Henriette Dances and Katalin Nagyvaradi. Szombathely: University of West (Savaria Campus) Hungary and Data2win Ltd., Cardiff UK.*
6. Doder, D. & Babiak, J. (2009). A canon of muscle power in female athletes in relation to their age. *Research in sport science. Written and edited by Mike Hughes, Henriette Dances and Katalin Nagyvaradi. Szombathely: University of West (Savaria Campus) Hungary and Data2win Ltd., Cardiff UK.*
7. Babiak, J. & Doder, D. (2005): The harmonic canon power in martial arts. 1. International Symposium on "Effects and impacts of different models of training process on the anthropological status of athletes in martial arts." "Proceedings, Beograd, 2005, pp. 6-10.
8. Babiak, J. & Doder, D. (2006): The harmonic canon power and universal model of karate fighting champion. 2. International Symposium on "Models of training process in martial arts " "Proceedings, Beograd, 2006, pp. 6-11.
9. Babiak, J. & Doder, D. (2007/2008): Dynamometric muscle strength canon of top karate and wrestlers female athletes. 3. Scientific symposium in martial arts in Pančevo with international participation on the topic "Some scientific aspects of the martial arts" (2007). Proceedings, Actualities in practice, vol. 20, no. 6, pp. 7-15.
10. Štuka, K. & Heimer, S. Methodology display of measuring isometric muscle force. *Kinesiology, Zagreb, 1971: no. 1, pp. 97-100.*

## COMPARISON OF INSTEP KICKING BY PREFERRED LEG AMONG VARIOUS STATES AND INTENSITIES IN YOUNG FOOTBALL PLAYERS

Duško Bjelica<sup>1</sup>, Georgi Georgiev<sup>2</sup> and Stevo Popović<sup>1</sup>

<sup>1</sup>Faculty for Sport and Physical Education, University of Montenegro, Nikšić, Montenegro

<sup>2</sup>Faculty of Physical Education, University "Ss. Cyril and Methodius", Skopje, Macedonia

### Abstract

This research was aimed at gaining relevant knowledge about important differences with respect to comparing accuracy of instep kicking by preferred leg depending on the different intensity (optimal and maximal) in a resting state, and in a state of fatigue. The sample included 20 respondents whose characteristics were: age (yrs)  $16.7 \pm 0.47$ , height (cm)  $178.91 \pm 4.26$ , and body weight (kg)  $71.52 \pm 5.13$ . The sample of variables contained four measures that defined accuracy of instep kicking by preferred leg in various occasions: with optimal and maximal intensities and in a resting state and a state of fatigue respectively. The results of the measurement were analyzed by means of a statistical procedure labeled a significance test of difference of two arithmetic means conducted on independent samples or popularly known a t-test. Based on the results it was affirmed that significant differences occur in the case of almost all the variables as it was expected and it was concluded that various intensities affect, while various states don't affect the accuracy of instep kicking by preferred leg at a significance level of  $p < 0.05$ .

**Key words:** accuracy, soccer, resting state, state of fatigue

### Introduction

One of the reasons for football being so popular and common worldwide is that players do not necessarily need to have extraordinary level of endurance, strength, power and flexibility but need to possess some level of the abilities to be efficient during a football game (Sporis et al. 2007). One of these abilities is instep kick which is the main offensive action during the game (Kellis, & Katis, 2007). The kicking accuracy is an important component of football performance (Finnoff et al. 2002) and the improvement of football instep kick technique is one of the most important aims of training programs and scientific research. According to Scurr, and Hall (2009), the instep kick has been subject to the majority of biomechanical analysis and research (Barfield et al. 2002; Dorge et al. 2002; Nunome et al. 2002; Shan, & Westerhoff, 2005; Bjelica, 2008, Bjelica et al. 2011). Therefore, the aim of the present study was to compare accuracy of instep kicking by preferred leg depending on the different intensity (optimal and maximal) in a resting state, and in a state of fatigue.

### Methods

Twenty football players from the junior premier league volunteered to be subjects. The players' characteristics were: age (yrs)  $16.7 \pm 0.47$ , height (cm)  $178.91 \pm 4.26$ , and body mass (kg)  $71.52 \pm 5.13$ . The criteria for selecting footballers for the sample were as follows: having a good health condition, then being a member of the team in the club for seven year at least and being under the supervision of qualified coaches all the time.

For the data collecting, a valid and reliable method for measuring the accuracy of instep kicking was used (Bjelica, 2008). It was conducted outdoors on a natural football pitch and all subjects wore their own shorts, t-shirt and football shoes. Following a warm up, stretching exercises and familiarization trials subjects were asked to shoot on target from the distance of 20 meters with preferred leg within four occasions: with optimal and maximal intensities and in a resting state (the respondents had to shoot only if their heart rate is under 90 bpm) and a state of fatigue (the respondents had to shoot as soon as they do ten squats) respectively and we defined four different variables: OR (shoot with optimal intensity in a resting state), OF (shoot with optimal intensity in a state of fatigue), MR (shoot with maximal intensity in a resting state), MF (shoot with maximal intensity in a state of fatigue). Subjects kicked a total of ten shoots, using a standard size ball, at an outlined target on a steady vertical surface in standard dimensions (7.32 x 2.44 m). The centre of the target (Figure 1.) was marked with a cross lines which divided the target to four equal rectangles. From the central point it many concentric circles were drawn and the first one had the same diameter as a standard ball (22.1 cm). All other circles were outlined with their mutual space between, of a size of a standard ball diameter. The central circle brought 17 points, which was a maximal number of points for one shot, whereas peripheral circles on the left and right brought one point. It means that every shot closer to center brought the larger number of points, while every failure was identified by zero points.



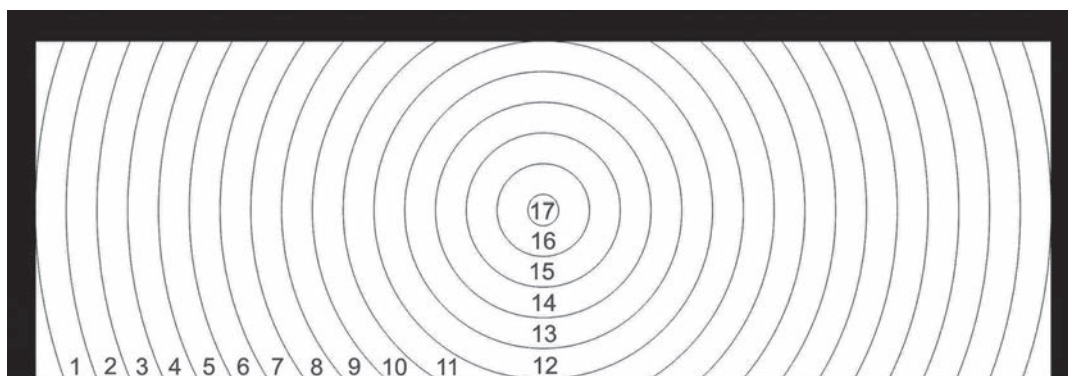

Figure 1. The target

The data obtained in the research were processed using the application statistics program SPŠ 15.0 adjusted for the use on personal computers. Descriptive statistics were calculated first, and then it was determined whether there was significant difference between the mean in every variable recreationally, which was done testing the difference between the mean of independent samples, using the popularly known, t-test which was set at  $p < 0.05$ . The analysis provided the answers to the question of whether there was and how prominent was the difference between instep kicking by preferred leg among various states and intensities in young football players.

## Results

This section offers the results of the descriptive statistics, as well as the results of discriminative analysis classified into two tables and six graphs.

The first table, in the first three columns contains the means (M), the standard deviations (SD) and the standard errors (SE), as well as minimum (Min) and maximum (Max), range (R), Skewness (Sk.) and Kurtosis (Ku.).

Table 1. Descriptive statistics

	M	SD	SE	Min	Max	R	Sk.	Ku.
Age (yrs)	16.7	0.47	0.1	16	17	1	-0.94	-1.24
Height (cm)	178.91	4.26	0.95	171.5	188.6	17.1	0.31	0.42
Weight (kg)	71.52	5.13	1.15	64	84	20	0.59	0.24
OR	9.97	3.62	0.26	0	16	16	-0.72	-0.19
OF	9.5	4.31	0.3	0	17	17	-0.93	0.16
MR	6.53	5.23	0.37	0	16	16	0.02	-1.45
MF	6.47	4.96	0.35	0	15	15	-0.05	-1.50

The second table shows the result of independent t-test and it is presented through cross tabular scheme at a significance level of  $p = .05$ .

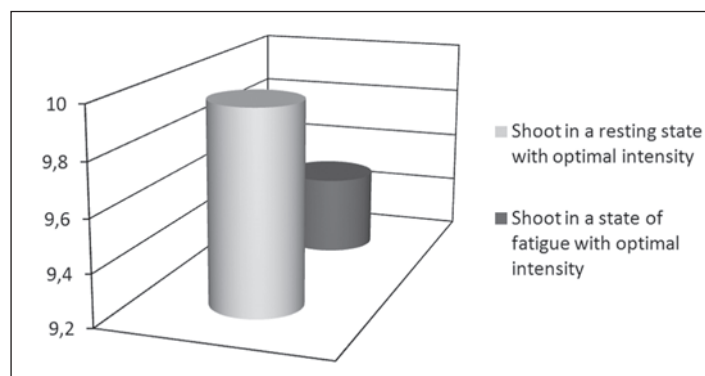

Graph 1. Comparison of instep kicking by preferred leg among a shoot in a resting state with optimal intensity and a shoot in a state of fatigue with optimal intensity

The second graph shows the differences of instep kicking by preferred leg among a shoot in a resting state with optimal intensity and a shoot in a resting state with maximal intensity. The value of this comparison is 5.62 and it means that there is significant difference between these two variables at a significance level of  $p=.05$ .

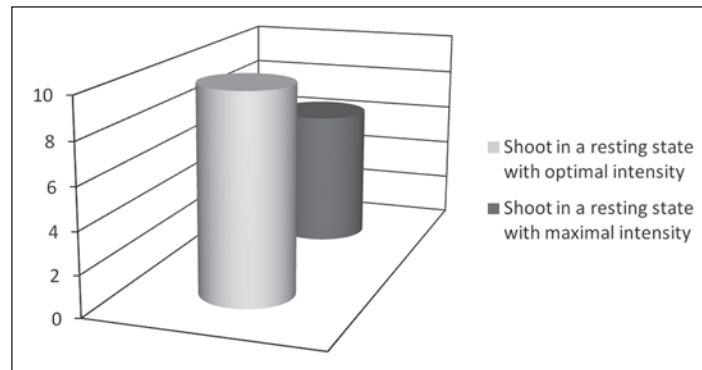

Graph 2. Comparison of instep kicking by preferred leg among a shoot in a resting state with optimal intensity and a shoot in a resting state with maximal intensity

The third graph shows the differences of instep kicking by preferred leg among a shoot in a resting state with optimal intensity and a shoot in a state of fatigue with maximal intensity. The value of this comparison is 5.66 and it means that there is significant difference between these two variables at a significance level of  $p=.05$ .

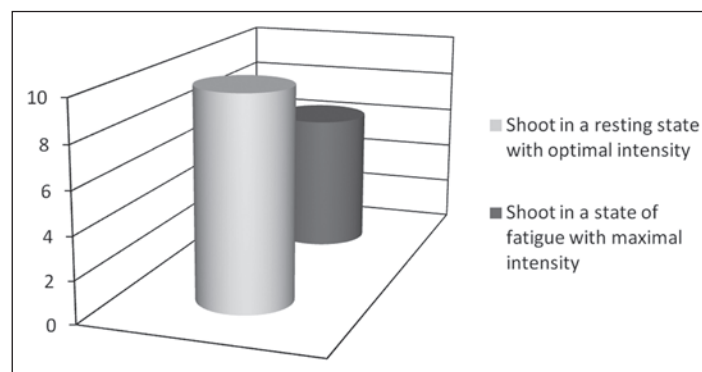

Graph 3. Comparison of instep kicking by preferred leg among a shoot in a resting state with optimal intensity and a shoot in a state of fatigue with maximal intensity

The fourth graph shows the differences of instep kicking by preferred leg among a state of fatigue with optimal intensity and a shoot in a resting state with maximal intensity. The value of this comparison is -6.51 and it means that there is significant difference between these two variables at a significance level of  $p=.05$ .

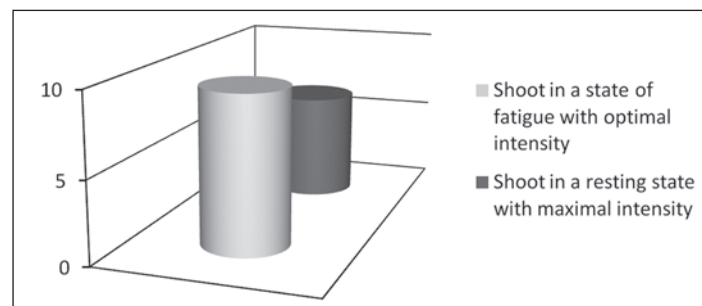

Graph 4. Comparison of instep kicking by preferred leg among a shoot in a state of fatigue with optimal intensity and a shoot in a resting state with maximal intensity

The fifth graph shows the differences of instep kicking by preferred leg among a shoot in a state of fatigue with optimal intensity and a shoot in a state of fatigue with maximal intensity. The value of this comparison is 6.22 and it means that there is no significant difference between these two variables at a significance level of  $p=.05$ .

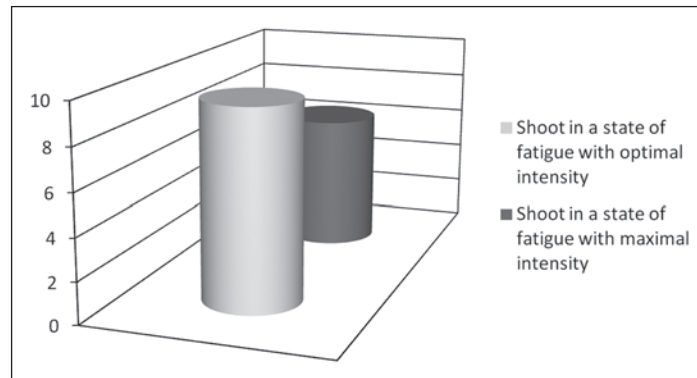

Graph 5. Comparison of instep kicking by preferred leg among a shoot in a state of fatigue with optimal intensity and a shoot in a state of fatigue with maximal intensity

The sixth graph shows the differences of instep kicking by preferred leg among a shoot in a resting state with maximal intensity and a shoot in a state of fatigue with maximal intensity. The value of this comparison is 0.13 and it means that there is no significant difference between these two variables at a significance level of  $p=0.05$ .

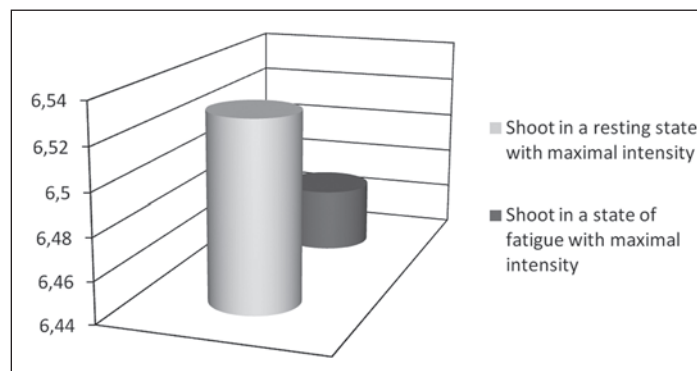

Graph 6. Comparison of instep kicking by preferred leg among a shoot in a resting state with maximal intensity and a shoot in a state of fatigue with maximal intensity

## Discussion and conclusions

Based on the results of this study which were collected by testing 20 representative young footballers who had to shoot on target with non-preferred leg within four occasions: with optimal and maximal intensities and in a resting state and a state of fatigue respectively, it was affirmed that significant differences occur in the case of almost all the variables as it was expected and it was concluded that various intensities affect, while various states don't affect the accuracy of instep kicking by preferred leg at a significance level of  $p=0.05$ . Unfortunately there weren't too many previous studies which investigate the accuracy of instep kicking depending on the different intensity (optimal and maximal) in a resting state, and in a state of fatigue, just few of them (Bjelica, 2008; Bjelica et al. 2011) and, if we compare the finding that these studies presented we can conclude that the most previous conclusions are consistent to this study as followings:

1. The respondents showed better result when they do the test for the evaluation of accuracy with optimal intensity versus maximal intensity. The differences between the means were statistically significant in the resting state as well as in the state of fatigue.
2. When we compared the accuracy of non-preferred leg with optimal intensity depending of the state, the respondents showed better result in the resting state versus the state of fatigue, and we didn't find the statistically significant difference between the means.
3. When we compared the accuracy of non-preferred leg with maximal intensity depending of the state, the respondents showed better result in the resting state versus the state of fatigue, but we didn't find the statistically significant difference between the means.

## References

1. Barfield, W.R., Kirkendall, D.T., & Yu, B. (2002). Kinematic instep kicking differences between elite female and male soccer players. *Journal of Sports Science and Medicine*, 1, 72-79.
2. Bjelica, D. (2008). Influence of coordination and psychological factor on the kick precision in football. *Acta Kinesiologica*, 2 (1), 81-84.
3. Bjelica, D., Georgiev, G., & Popović, S. (2011). Comparison of instep kicking between preferred and non-preferred leg in young football players. In *Proceedings of the 1<sup>st</sup> International Conference in Science and Football (58)*, Palermo: Scuola dello Sport CONI Sicilia.
4. Dorge, H.C., Andersen, T.B., Sorensen, H., & Simonsen, E.B. (2002). Biomechanical differences in soccer kicking with the preferred and the non-preferred leg. *Journal of Sports Sciences*, 20, 293-299.
5. Finnoff, J.T., Newcomer, K., & Laskowski, E.R. (2002). A valid and reliable method for measuring the kicking accuracy of soccer players. *Journal of Science and Medicine in Sport*, 5 (4), 348-353.
6. Kellis, E., & Katis, A. (2007). Biomechanical characteristics and determinants of instep soccer kick. *Journal of Sports Science and Medicine*, 6, 154-165.
7. Nunome, H., Asai, T., Ikegami, Y., & Sakurai, S. (2002). Three dimensional kinetic analyses of side-foot and instep soccer skills. *Medicine and Science in Sport and Exercise*, 34, 2028-2036.
8. Scurr, J., & Hall, B. (2009). The effects of approach angle on penalty kicking accuracy and kick kinematics with recreational soccer players. *Journal of Sports Science and Medicine*, 8, 230-234.
9. Shan, G., & Westerhoff, P. (2005). Full-body kinematic characteristics of the maximal instep soccer kick by male soccer players and parameters related to kick quality. *Sports Biomechanics*, 4 (1), 59-72.
10. Sporis, G., Vučetić, V., & Jukić, I. (2007). How to evaluate full instep kick in soccer? *Journal of Sports Science and Medicine*, Suppl.10, 27-28.

## CHILDREN'S 50 METRES RUNNING DYNAMICS

Iva Blažević<sup>1</sup>, Vesna Babić<sup>2</sup> and Milan Čoh<sup>3</sup>

<sup>1</sup>Primary school "Vidikovac", Pula, Croatia

<sup>2</sup>Faculty of Kinesiology, University of Zagreb, Croatia

<sup>3</sup>Faculty of Sport, University of Ljubljana, Slovenia

### Abstract

The aim of this research is to determine the 50 metres running dynamics with children of a younger school age, as well as the differences in parameters of sprinter's running dynamics between girls and boys. The research has been conducted on a sample of 150 girls and boys of the first and second form of an primary school from Pula. The time of the start reaction and the time of sprinter's running on each five metres on a section of 50 metres have been measured with a system for electronic measurement. The basic descriptive parameters have been worked out, while the differences between girls and boys have been analyzed by the univariant analysis of variance. The results for the segment speeds with boys and girls show that 50 metres running with children of a younger school age can be divided into three phases: acceleration (start acceleration), achieving and keeping the highest running speed and deceleration (crossing the finish line). The analysis of differences between girls and boys of a younger school age has shown that there are statistically significant differences according to sex.

**Key words:** *sprinter's running, running dynamics, children*

### Introduction

Sprinting represents a form of a person's quickest motion. The main aim with sprinting or sprinter's running is to achieve the highest running speed in an as short as possible time, as well as to keep it the longest possible time. According to former studies of the running speed curve (Volkov and Iapin, 1979; Muller, 1991; Ferro and partners, 2001; Hunter and partners, 2004; Babić, 2005; Letzelter, 2006; Mačkala, 2007), the 100 metre section can be divided into four phases: *acceleration or start acceleration* (from the start to the 30<sup>th</sup> metre), *achieving the highest running speed* (from the 30<sup>th</sup> to the 60<sup>th</sup> metre), *keeping the highest running speed* (from the 60<sup>th</sup> to the 80<sup>th</sup> metre) and *deceleration or crossing the finish line* (from the 80<sup>th</sup> metre to the end). Some researchers have divided the 100 metre section into three phases: the acceleration phase, the highest speed phase and deceleration (Brugemann and Susanka, 1988; Radford, 1990; Gajer, Thepaut-Mathieu and Lehenaff, 1999; Letzelter, 2006).

The running result on the section shows the running dynamics, and it depends on the time of the start reaction (latent time), on the quality of the start acceleration (acceleration phase), on the running speed on the track and on the possibility of keeping the highest speed as long as possible with a minimal gradual decline of the running speed at the finish line (deceleration time) (Babić, 2005). The sprinters running dynamics changes at different parts of the sprinting track, and the achieved running time is the result of a connection between all phases of sprinter's running.

In the former researches of sprinter's running the sample of examinees has usually consisted of athletes belonging to different sports categories and children members of athletics schools. In this research the running dynamics on a 50 metre track will be determined for school age examinees by objective measuring instruments. Thus, the main aim of this research is to determine the 50 metre running dynamics with children of a younger school age, as well as the differences in parameters of sprinter's running dynamics between girls and boys.

### Methods

#### Sample of examinees

The sample of examinees consists of 150 male and female pupils of the first and second form of an primary school from Pula (70 male and 80 female pupils). The pupils are averagely 8.12 $\pm$ 0.63 years old, 133.56  $\pm$  7.66 centimetres high, and they weigh approximately 31.42 $\pm$ 8.05 kilograms.

## Sample of variables

The sample of variables consists of 30 variables meant to determine the dynamics of sprinter's running: the time of the start reaction and the achieved time of sprinter's running on each 5 metres from the start to the finish line on a 50 metre section, as well as the running speed on each 5 metres from the start to the finish line on a 50 metre section.

## Methods of data processing

The time of the start reaction (KLRT) and the time of sprinter's running (KT\_M) on each 5 metres on a 50 metre section have been measured for the needs of this research. A system for electronic measurement has been set on the ground behind the start line. This system consists of a base and a personal computer and ten pairs of photo cells. A computer programme "BRZ" comes along with the electronic measuring instrument. It works out the data for the intervals of time for specific phases and the running speed. In the further data processing, the basic descriptive parameters and the univariate analysis of the variance have been worked out.

## Results

The average latent time of the start reaction for *boys* is 0.405 seconds, while the average running time on a 50 metre section is 10.098 seconds. The results of the 50 metres running range from 8.067 seconds to 12.096 seconds.

Table 1. Descriptive variable parameters of the boys' 50 metre running dynamics (N=70)

VARIABLES	MEAN	MIN	MAX	SD
KLRT	0,405	0,172	0,985	0,171
KT5M	1,963	1,595	2,580	0,183
KT10M	2,910	2,211	3,575	0,223
KT15M	3,786	3,018	4,388	0,246
KT20M	4,672	3,776	5,443	0,301
KT25M	5,526	4,519	6,625	0,393
KT30M	6,419	5,253	7,600	0,443
KT35M	7,316	5,759	8,789	0,532
KT40M	8,223	6,486	10,040	0,605
KT45M	9,132	7,286	10,939	0,689
KT50M	10,098	8,067	12,096	0,801

Table 2. Boys' running time and speed in five metres segments on a 50 metre running track

VARIABLES	0-5m	5-10m	10-15m	15-20m	20-25m	25-30m	30-35m	35-40m	40-45m	45-50m
TIME (s)	1,56	0,88	0,88	0,86	0,90	0,89	0,92	0,91	0,98	0,95
SPEED (m/s)	3,29	5,37	5,81	5,77	5,98	5,65	5,83	5,53	5,67	5,29

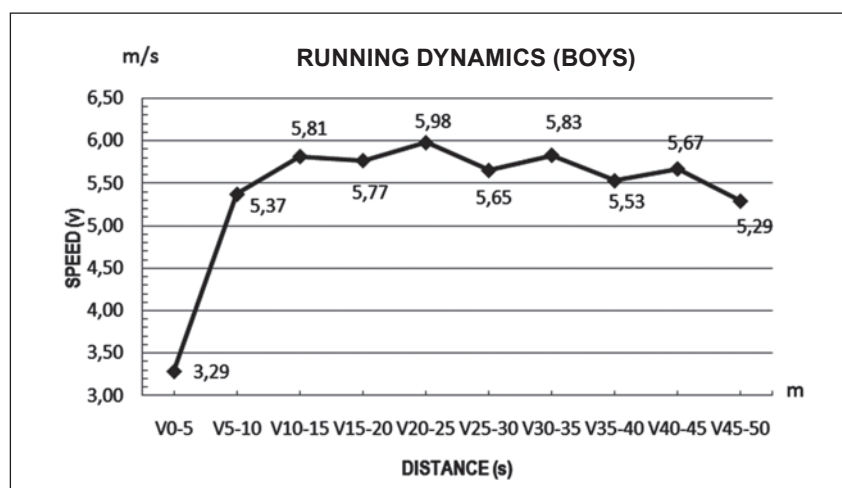

Figure 1. Graphic representation of the boys' running dynamics

In the graphic representation of the segment running speeds three phases can be noticed in the 50 metres running for boys of a younger school age:

- *Acceleration or start acceleration* (from the start line to the 15<sup>th</sup> metre)
- *Achieving and keeping the highest running speed* (from the 15<sup>th</sup> to the 35<sup>th</sup> metre)
- *Deceleration or crossing the finish line* (from the 35<sup>th</sup> to the 50<sup>th</sup> metre)

The average speed from the start line to the 5<sup>th</sup> metre is 3.29 metres per second, and the highest increase in speed has been measured in the segment from the 5<sup>th</sup> to the 10<sup>th</sup> metre. From the 5<sup>th</sup> to the 10<sup>th</sup> metre the running speed has increased for 63.2 percent. The highest speed with boys is averagely 5.98 metres per second, and it is achieved in the segment from the 20<sup>th</sup> to the 25<sup>th</sup> metre.

In the phase of achieving and keeping the highest running speed a small drop in the running speed of 5.8 percent (0.3 metres per second) can be noticed. It happens after the boys have achieved the highest running speed. Such a variation in results can be noticed in the segment from the 10<sup>th</sup> to the 45<sup>th</sup> metre (table 2), where, after the decrease of the running speed, an increase to the level of highest values follows. At the end of the acceleration phase the running speed with boys is 5.81 metres per second, after which it decreases for 0.7 percent in the 20<sup>th</sup> metre, while in the 25<sup>th</sup> metre it comes to its highest value of 5.95 metres per second. The running speed at the end of the acceleration phase is three percent lower than the highest achieved 50 metres running speed.

In crossing the finish line, the running speed is 5.29 metres per second and it is 13 percent lower compared to the highest value of the 50 metre running speed.

The average latent time of the start reaction for *girls* is 0.467 seconds, while the average running time on the 50 metres section is 10.588 seconds. The 50 metres running results span a range between 8.636 seconds and 12.379 seconds.

Table 3. Descriptive variable parametres of the girls' 50 metre running dynamics (N=80)

VARIABLES	MEAN	MIN	MAX	SD
KLRT	0,467	0,141	0,921	0,192
KT5M	1,995	1,669	2,613	0,199
KT10M	2,980	2,484	3,571	0,228
KT15M	3,900	3,258	4,755	0,279
KT20M	4,816	4,071	5,902	0,365
KT25M	5,728	4,851	6,789	0,434
KT30M	6,662	5,601	7,952	0,520
KT35M	7,614	6,391	9,092	0,610
KT40M	8,596	7,004	10,239	0,718
KT45M	9,563	7,798	11,275	0,835
KT50M	10,588	8,636	12,379	0,925

Table 4. Girls' running time and speed in five metres segments on a 50 metre running track

VARIABLES	0-5m	5-10m	10-15m	15-20m	20-25m	25-30m	30-35m	35-40m	40-45m	45-50m
TIME (s)	1,53	0,99	0,92	0,92	0,92	0,93	0,96	0,98	0,97	1,02
SPEED (m/s)	3,37	5,14	5,57	5,61	5,60	5,49	5,34	5,22	5,30	5,04

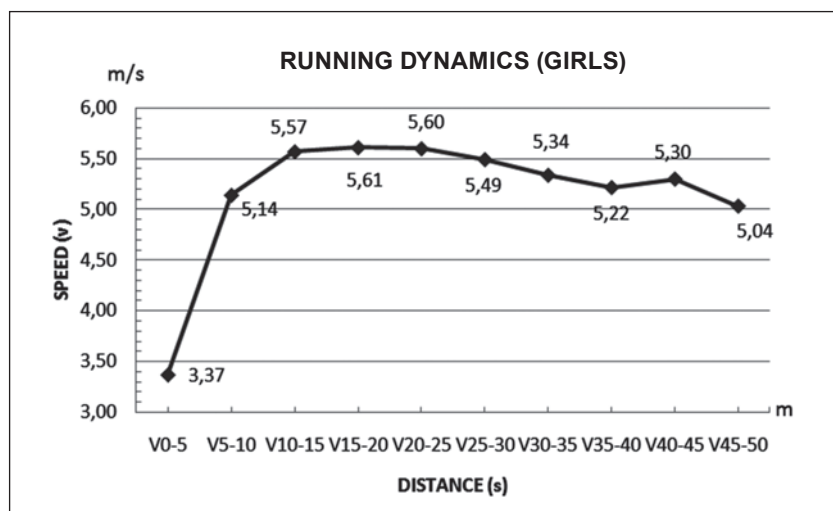

Figure 2. Graphic representation of the girls' running dynamics

In the graphic representation of the speed development curve for girls three phases in the 50 metres running can be noticed:

- *Acceleration or start acceleration* (from the start line to the 15<sup>th</sup> metre)
- *Achieving and keeping the highest running speed* (from the 15<sup>th</sup> to the 30<sup>th</sup> metre)
- *Deceleration or crossing the finish line* (from the 30<sup>th</sup> to the 50<sup>th</sup> metre)

The average speed from the start line to the 5<sup>th</sup> metre is 3.37 metres per second, and the highest increase in speed has been measured in the segment from the 5<sup>th</sup> to the 10<sup>th</sup> metre and its value is 5.14 metres per second or 52.5 percent. The average highest speed for girls is 5.61 metres per second and it is achieved in the segment from the 15<sup>th</sup> to the 20<sup>th</sup> metre.

In the phase of keeping the highest running time after the initial drop in speed of 2.3 percent (0.12 metres per second) in the segment from the 35<sup>th</sup> to the 40<sup>th</sup> metre, a small increase in speed of 1,5 percent (0.8 metres per second) follows. After the 45<sup>th</sup> metre a decrease in the running speed of 5.1 percent (0.26 metres per second) occurs, followed by crossing the finish line.

The speed after the acceleration phase is 5.57 metres per second and it is 0.7 percent lower compared to the highest 50 metres running speed with girls. At the time the finish line is crossed the running speed is 5.04 metres per second and it is 11.3 percent lower than the highest value of the 50 metre running speed.

To determine the differences between boys and girls of a younger school age the univariate analysis of variance has been used.

Table 5. Differences in kinematic parametres between boys and girls

VARIABLES	AS-B	AS-G	SD-B	SD-G	SS	MS	df	F	p
KLRT	0,41	0,47	0,17	0,19	0,14	1	0,14	4,15	0,04
KT5	1,96	2,00	0,18	0,20	0,04	1	0,04	1,01	0,32
KT10	2,91	2,98	0,22	0,23	0,18	1	0,18	3,53	0,06
KT15	3,79	3,90	0,25	0,28	0,47	1	0,47	6,82	0,01
KT20	4,67	4,82	0,30	0,36	0,74	1	0,74	6,53	0,01
KT25	5,53	5,73	0,39	0,43	1,44	1	1,44	8,36	0,00
KT30	6,42	6,66	0,44	0,52	2,12	1	2,12	9,02	0,00
KT35	7,32	7,61	0,53	0,61	3,16	1	3,16	9,55	0,00
KT40	8,22	8,60	0,61	0,72	5,04	1	5,04	11,31	0,00
KT45	9,13	9,56	0,69	0,83	6,59	1	6,59	11,13	0,00
KT50	10,10	10,59	0,80	0,93	8,76	1	8,76	11,60	0,00



This analysis has proved that boys and girls are different in the following cinematic parameters of sprinter's running: *latent time of reaction* (KLRT), *15 metre running time* (KT15), *20 metre running time* (KT20), *25 metre running time* (KT25), *30 metre running time* (KT30), *35 metre running time* (KT35), *40 metre running time* (KT40), *45 metre running time* (KT45) and *50 metre running time* (KT50). All the variables have been reversely scaled, which means that a higher value of the analyzed parameter represents a poorer result. This means that girls achieve higher values in the given parameters and consequently poorer results in the 50 metres running.

## Discussion and conclusion

The obtained results for the segment speeds with boys and girls of this research show that 50 metre running with children of a younger school age can be divided into three phases. The segment of *acceleration or start acceleration* lasts to the 15<sup>th</sup> metre for both boys and girls, but at the end of this segment boys achieve a 4.3 percent higher running speed than girls. The length of the segment *achieving and keeping the highest running speed* lasts to the 20<sup>th</sup> metre with boys and to the 15<sup>th</sup> metre with girls. The highest running time is 6.6 percent higher with boys than with girls. The segment *deceleration or crossing the finish line* is 15 metres for boys and 20 metres for girls. At crossing the finish line boys have a five percent higher running speed than girl.

The start reaction is averagely 15.3 percent quicker for boys than for girls. They also have a 4.8 percent faster 50 metres run than the girls. A small increase in the running speed can be noticed between the 40<sup>th</sup> and the 45<sup>th</sup> metre for both boys and girls, compared to the values achieved between the 35<sup>th</sup> and 40<sup>th</sup> metre. The reason for such an increase in the running speed in the last five metres can be found in the insufficient preciseness in the estimation of the length of the running segment so when the examinees notice to be approaching the finish line, they additionally accelerate their running to obtain as good a result as possible. This can be explained by the fact that children of a younger school age have not yet developed skills and experience in the in depth perception of the finish line which means that the additional acceleration in the last five metres to the finish line is a consequence of a clearer estimation of the finish line in 50 metre running.

## References

1. Babić, V. (2005). *Utjecaj motoričkih sposobnosti i morfoloških obilježja na sprintersko trčanje*. (Doktorska disertacija, Sveučilište u Zagrebu). Zagreb: Kineziološki fakultet Sveučilišta u Zagrebu.
2. Ferro, A., Rivera, A., Pagola, I., Ferreruela, M., Martin, A., Rocandio V. (2001) Biomechanical analysis of the 7<sup>th</sup> World Championships in Athletics Seville 1999. *New Studies in Athletics*, 16 (1-2), 25-60.
3. Gajer, B., Thepaut-Mathieu, C., Lehenaff, D. (1999). Evolution of stride and amplitude during course of the 100 m event in athletics. *New Studies in Athletics*, 14 (1), 43-50.
4. Hunter, J., Marshall, R.N., McNair, P. (2004). Interaction of step length and step rate during sprint running. *Medicine & Science in Sports & Exercise*, 36 (2), 261-271.
5. Hunter, J., Marshall, R.N., McNair, P. (2004). Interaction of step length and step rate during sprint running. *Medicine & Science in Sports & Exercise*, 36 (2), 261-271.
6. Letzelter, S. (2006). The development of velocity and acceleration in sprints—a comparison of elite and juvenile female sprinters. *New Studies in Athletics*, 21 (3), 15-22.
7. Müller, H. (1991). Trends in the men's and woman's sprints in the period from 1985 to 1990. *New Studies in Athletics*, 6 (1), 7-14.
8. Volkov, N.I., Lapin, V.I. (1979). Analysis of the velocity curve in sprint running. *Medicine and Science in Sport*, 11 (4), 332-337.
9. Radford, P.F. (1990). Sprinting. *Physiology of Sport*, 71-99. London: E. & F.N. Spon.
10. Brüggemann, G.P., Susanka, P. (1988). *Scientific report on the Second IAAF World Championship in Athletics-Rome 1987*. London: International Amateur Athletic Federation.
11. Mačkala, K. (2007). Optimisation of performance through kinematic analysis of the different phases of the 100 metres. *IAAF*, 22 (2); 7-16.

## A 3D ANALYSIS OF GRAND JETE': COMPARISON BETWEEN GENDERS. A PILOT STUDY

Simone Ciacci<sup>1,2</sup> and Elisa Bianchi<sup>2</sup>

<sup>1</sup>*Dept. of Histology, Embryology and Applied Biology, University of Bologna, Italy*

<sup>2</sup>*Faculty of Exercise and Sport Science, University of Bologna, Italy*

### Abstract

#### Purpose

In the literature, there are few researches on the biomechanics of ballet. The aim of this study was to compare the kinematic and dynamic data of 2 professional ballet dancers (1 male, 1 female), to analyse gender differences in the grand jetè performance.

#### Methods

The data (ground reaction forces, lower limb angles and centre of mass trajectory in 3 jumps for each dancer) were collected through a 3D analysis system (Smart-D, BTS Engineering, Milano).

#### Results

The grand jetè technique was similar and standardized in both the dancers. The only differences were due to technical errors or personal interpretation.

#### Conclusions

This study can be useful to identify the errors and to define a technical model of the grand jetè. Further studies using wider samples of dancers are needed to allow a generalization of the present results.

**Key words:** *biomechanics, ballet*

### Introduction

Ballet is an ancient communication and artistic tool, commonly being assessed through aesthetic criteria.

In the literature, there are few studies that try to define a biomechanical or physiological reference criteria, which could provide useful to improve the ballet dancer performance.

Concerning biomechanics of ballet, previous studies had the specific aim to offer technical explanations (Picon et al., 2000), and new teaching methods. Among the different movements encountered in ballet, the most studied concern the lower limbs, with the foot and the hip position being often analyzed.

Many studies analyze strength and range of movement (ROM) of the hip joint during the ballet. Gupta et al. (2004), for example, observe that female ballet dancers, in comparison with a control group, show higher strength level and higher degrees of extrarotation, but lower degrees of intrarotation, so that total hip ROM results are similar in ballet dancers and in the control group. Similar results on extra and intrarotation levels are confirmed by Bennell et al. (1999) in a study on young female ballet dancers.

Other specific ballet movements analyzed in the literature are rotations and jumps. Among those studies, only Orishimo et al. (2009) provide a gender comparison, underlying the importance of the maximal lower limb extension during the jump and the following landing. However, they have not found significant differences between male and female dancers.

One of the most beautiful movements of the ballet is the grand jetè. The study of Thomas et al. (2004) analyzes the flight phase and the landing to explain the ground reaction forces (GRF) and the Center of Mass (COM) trajectories. Specifically, it is remarkable that the maximal lower limb opening (the splits) occurs in correspondence with the maximal COM height. The same research evaluates the GRF during the landing and its duration, resulting 0.4 s. In that study, of particular interest is the analysis of the lower limb muscle intervention before the ground contact.

The present study has the aim to compare two genders during the performance of a grand jetè, to offer a standard model for technical analysis and teaching approach.

## Methods

Two professional ballet dancers were recruited: 1 male (height 170cm, body mass 52kg) and 1 female (height 168cm, body mass 49kg). Both of them gave their written informed consent to participate.

Kinematic analysis was performed using an optoelectronic stereophotogrammetric system for tridimensional motion analysis (Smart-D, BTS Engineering, Milano). The kinematic data were collected using ten infrared cameras, with a 200 Hz sampling frequency. Dynamic data were collected using a force platform (Kistler 9286 BA, Ch). A modified Helen Hayes marker set was used with the addition of a marker on the head of the fifth metatarsal. The acquisition volume had following dimensions length, width and height amounting 4.5, 1.5 and 2.0 m, respectively.

After an adequate warm-up, each of the dancers performed six trials. Among all the trials, the three among them showing best visual reconstruction were selected and used for the subsequent analysis. The examined parameters were those relative to the events of the gesture that are the most analyzed in the literature. Concerning the support leg, kinematics and dynamics at foot strike, and the maximal knee flexion at take off, were considered. Furthermore, the length and timing of the jump, the trajectories of COM, and the maximal lower limbs opening were collected.

## Results

Table 1. Displays the individual average values of the support leg at the impact with the force platform and the maximal knee flexion. The values are related to the flexion-extension (Z axis) and rotation (X axis) of the 3 joints.

Tab. 1	HIP		KNEE		Max flex knee	ANKLE	
Degrees	Z	X	Z	X	Z	Z	X
<b>M avg</b>	<b>66.0</b>	<b>-7.9</b>	<b>25.7</b>	<b>-25.5</b>	<b>53.2</b>	<b>-12.7</b>	<b>-19.3</b>
St. Dev.	7.1	10.5	6.2	8.1	2.5	7.3	5.9
<b>F avg.</b>	<b>57.6</b>	<b>15.5</b>	<b>25.9</b>	<b>-6.9</b>	<b>49.2</b>	<b>-15.3</b>	<b>-21.1</b>
St. Dev.	2.9	0.7	1.3	2.2	1.2	2.0	1.4

Both subjects landed on the force platform with the left leg.

The female dancer, at the foot strike, showed a lower hip flexion compared to the male, but a higher internal rotation. Furthermore the knee was less flexed (about 4°) than in the male.

Table 2. Shows the data concerning take off from the force platform

Tab. 2	HIP		KNEE		ANKLE	
Degrees	Z	X	Z	X	Z	X
<b>M avg</b>	<b>7.4</b>	<b>-13.8</b>	<b>-3.6</b>	<b>-26.3</b>	<b>-38.2</b>	<b>8.3</b>
St. Dev.	3.1	1.2	3.9	2.0	2.6	2.8
<b>F avg</b>	<b>-2.5</b>	<b>-5.7</b>	<b>-8.9</b>	<b>-9.5</b>	<b>-35.4</b>	<b>4.8</b>
St. Dev.	0.8	3.3	1.1	3.4	5.2	5.0

Generally, the female performer showed a higher extension of all lower limb joints, but a lower ROM of external rotation.

Table 3. Reports the average for the dynamic data during the push off phase

Tab. 3	PEV in N	Norm	PEO in N	Norm	P Vector in N	Norm
<b>M avg</b>	<b>1366.79</b>	<b>2.68</b>	<b>50.43</b>	<b>0.10</b>	<b>1374.61</b>	<b>2.69</b>
St. Dev.	105.06	0.21	8.17	0.02	109.38	0.21
<b>F avg</b>	<b>1512.41</b>	<b>3.15</b>	<b>40.37</b>	<b>0.08</b>	<b>1539.21</b>	<b>3.20</b>
St. Dev.	97.37	0.20	7.24	0.02	108.88	0.23

The female had a higher vertical extension peak (PEV) and a lower horizontal extension peak (PEO) compared to the male, both when expressed in Newton (N), and in the values normalized to body mass.

Table 4. Displays average data on the maximal leg opening and on the opening leg at maximal COM height during the flight phase (theoretically the two data have to coincide), the COM trajectories on the vertical axis and the grand jetè length.

Tab. 4	Max opening leg (deg)	Opening leg at max h COM (deg)	Delta COM on Z axis (m)	Jump length (m)	Contact time (s)	Flight time (s)	Time tot (s)
Mean	134.87	126.97	0.47	1.55	0.295	0.485	1.075
St. Dev.	1.16	3.59	0.03	0.18	0.025	0.005	0.053
Mean	116.13	96.87	0.43	1.34	0.229	0.457	0.916
St. Dev.	0.64	4.39	0.00	0.07	0.008	0.012	0.016

In the male subject, the maximal leg opening showed a difference of 8° compared to the opening leg at maximal COM height. The same value in the female subject was of about 20°.

Then, in the male dancer, the grand jetè length and height were higher of 20 and 4 cm respectively, when compared to the corresponding data of the female dancer. Concerning the temporal parameters, the male dancer showed the shortest total times, mainly due to a 20 ms shorter contact time.

## Discussion

The data comparison shows that the grand jetè technique is standardized in both the subjects.

The dynamic data, on the contrary, highlight a different interpretation of the jump by the two ballet dancers: the female dancer, in fact, shows a higher vertical push compared to the horizontal one, but her jump is shorter than that of the male dancer. This could probably be due to a lower muscle stiffness or a lower capacity to use the elastic strength. Moreover, it is possible that the arm swing movements, not analyzed in this research, can affect the obtained results.

From a technical point of view, the used system allowed to identify some individual mistakes.

At the take off, the male subject shows both the hip and the knee of the support leg more flexed than the female (+16° e +45° respectively); the female dancer, on the contrary, displays an incorrect movement of the swing leg, that is flexed and without external rotation, while a correct technique should involve at the same point a more flexed leg and a higher extrarotation.

During the flight phase, the male subject shows a maximal opening of the legs 20° to 30° wider than that of the female dancer, but shows also a technical mistake concerning the front knee, that results always flexed and not extended, contrarily to what was shown by the female dancer.

Moreover, both subjects do not achieve their maximal opening of the legs at the maximal COM height (Thomas et al, 2004), but they show that value lower of 8° (male) and 20° (female) compared to their respective individual maximal opening, that occurs 2 cm further down the maximal COM height.

## Conclusions

This biomechanical study allowed to analyze step by step the movement of the leg joints during the grand jetè. Moreover it was possible to compare kinematic and dynamic data of the most important phases of the jump. It is very important, in fact, to define a model that is based on biomechanical parameters and not only on aesthetic criteria.

A new approach of this study was that to investigate gender differences about the grand jetè and to identify a technical model and the individual mistakes. The next step of this research will be to analyze a wider sample of subjects to obtain a statistical validity, and to widen the acquisition volume to evaluate also the step before the landing on the force platform. Moreover, it can provide useful also to collect data about the movement of the arms, since their turning could affect the COM trajectory.

## References

- Bennell, K., Khan, K.M., Matthews, B., De Gruyter, M., Cook, E., Holzer, K., Wark, J.D.: *Hip and ankle range of motion and hip muscle strength in young novice female ballet dancers and controls*. Sports Med 1999; 33: p.340-346.
- Gupta, A., Fernihough, B., Bailey, G., Bombeck, P., Clarke A., Hopper, D.: *An evaluation of differences in hip external rotation strength and range of motion between female dancers and non dancers*. Sports Med 2004; 38 p.778-783.
- Orishimo, K.F., Kremenic, I.J., Pappas, E., Hagins, M., Liederbach, M.: *Comparison of Landing Biomechanics Between Male and Female Professional Dancers*. The American Journal of Sports Medicine 2009. p. 2187-2194.
- Picon, A.P., Lobo, da Costa, P.H., de Sousa, F., de Sacco, I., Amadio, A.C.: *Biomechanical approach to ballet movements: a preliminary study*. ISBS Proceedings, 2000.
- Thomas, T., Murray, J., Stanley, L., Galler, P.: *Analisis of the aerial and landing phases of the grand jetè*. ISBS Proceedings 2004. p. 161-166.

## ANTICIPATORY POSTURAL ADJUSTMENTS IN THROWING TASK

Grzegorz Juras<sup>1</sup> and Kajetan Slomka<sup>2</sup>

<sup>1</sup>*State School of Higher Vocational Education, Raciborz, Poland*

<sup>2</sup>*Academy of Physical Education, Katowice, Poland*

The main aim of this study was to investigate the duration of anticipatory postural adjustments (tAPA) associated with a ballistic task such as dart throwing. Earlier studies of stepping and hopping showed that APA characteristics scale with the target size; however, in those studies the main task engaged the same muscles that were also used in APAs. In this study, we tested a hypothesis that APA scaling with task parameters would be preserved even when the task is performed by muscles that have no direct effects on APAs.

Sixteen healthy right handed subjects participated in the study. All participants had no prior experience in darts throwing. Subject's average age was 24.1 years. We used a force platform to register the vertical component of ground reaction forces. At the same time we registered kinematics of the throwing arm and throwing accuracy using passive markers with infrared cameras (BTS Smart, Bioengineering). The target was positioned 2 m away from the subject. The width of the target was constant and equaled 1 m, while its height varied across series. The experiment consisted of six series of twenty consecutive dart throws to the specified target. Target sizes (T2-T6) were set as 25%, 50%, 75%, 125% and 150% of target 1 (T1) initially set as the spread of the last 20 throws in a 50 throw training session - six indexes of difficulty (ID's) ranging from 2,9 to 5,9. The following variables were used in further analysis: anticipatory postural adjustment time (tAPA - the time that elapses between movement initiation - when the magnitude of vertical component of ground reaction forces (Fz) deviated from subject's weight (Q) by more than 10% in either direction - and arm movement initiation), time of movement (tMOV), flight time of a dart (tFlight), overall time (tALL), distance between average dart location and the center of the target (Constant Error) and the standard deviation of the target coordinates across trials (Variable Error). A one way analysis of variance (ANOVA) for repeated measures was used.

Results of ANOVA showed a significant effect of Constant Error and Variable Error but no effect of the target size. There were also no significant differences between hit and miss throws.

## COLOURED SIGNAL CODING IN COMPUTERIZED HUMAN GAIT ANALYSIS

Mario Kasović<sup>1</sup>, Željko Heimer<sup>2</sup> and Vladimir Medved<sup>1</sup>

<sup>1</sup>*Faculty of Kinesiology, University of Zagreb, Croatia*

<sup>2</sup>*Ministry of Defence of the Republic of Croatia, Croatia*

### Abstract

Contemporary computers are used in clinical gait analysis. The measured data on locations of certain points on the subject's body during gait, as well as the data on ground reaction force are combined - assuming a body model of a rigid segment type - via inverse dynamic approach, so that, as the output data, sets of kinematic and kinetic curves are yielded that describe the amount of rotation of individual body segments as well as net forces and moments appearing in virtual joint centers during gait.

Interpretation of these results is a problem in clinical application since it is time consuming and arduous. The coloured coding of the output curves proposed by Manal and Stanhope is applied in this paper to indicate to the clinician the direction and the degree of deviation from the norm of particular regions in the measurement curves, and of curves as a whole.

**Key words:** *clinical gait analysis, signal coding*

### Introduction

Human gait is highly individualized and differs for each subject, as it is easily seen already by the fact that we are able to recognize a person by the way he walks even from afar. However, it is possible to determine a basic pattern that is common to all individuals, no matter the variations in the anthropological structure between the ethnic groups, neither the numerous individual variations. The variations are not only dependant on the differences in the body structure between individuals, but may be observed for one subject depending on the kind of footwear, on the fatigue, on his momentary mood and other conditions.

It is a known fact that mental and emotional conditions may be identified by the manner of person's gait even from afar. However, it is shown that all the individual variations are relatively small with regard to the common pattern, especially when observed in the plane of motion, while in the two planes perpendicular to it the individualities are more pronounced (Inman, Ralston, Todd, 2006). Beginning of the quantitative gait evaluation dates back into the 19<sup>th</sup> century with the development of photogrammetry and introduction of inverse dynamic approach by Braune and Fischer, however, it is only in the last decades of the 20<sup>th</sup> century that it has developed significantly, especially by the automatization of the measurement process, by the increase of the computer processing power enabling complex computations in almost real time, and by the increase of the measuring equipment reliability. The applications of the bioengineering evaluation of human gait range from scientific research, over the clinical to the applications in the computerized animation.

Maybe the most important application of the gait evaluation is for medical-diagnostic purposes with the therapeutic goal: determination of a certain pathologic state (differential diagnostics), following and monitoring of the therapy and evaluation of the treatment outcome (Gage, 2004). However, biomechanical gait evaluation has not yet become the standard clinical procedure, foremost due to the complexity of the interpretation of the gait analysis finding and the absence of a standard approach in the presentation of these results (Simon, 2004). This paper applies a solution that attempts to help to bridge that gap.

Current clinical gait analysis systems in most cases measure three groups of variables: kinematic, kinetic and myoelectric (electromyographic – EMG) (Medved, 2001). This work addresses only the kinematic and kinetic variables groups. Current commercial clinical gait analysis systems yield as the output the series of curves, so called kinematic and kinetics motion curves, representing rotation of certain human body segments in three planes, and the components of net forces and moments in certain joints.

Defining of the angles is not unambiguous and almost each author until the mid-1990's used his own variant, contributing to the disarray in the area. This was the reason why the International Society of Biomechanics produced and issued recommendations (Wu, Cavanaugh, 2001., Wu, 2002.), that are today the basis used by all the manufacturers of the biomechanical measurement systems as well as the scientific biomechanics laboratories all over the world. The kinematic motion curves comprise typically of twelve function graphs, usually each containing separate curves for left and right leg measurement records, combined with the curves representing the standards (norms), while the kinetic curves comprise of additional twelve graphs of forces, moments and powers.

A problem in clinical practice is that the physician who is supposed to interpret these results is faced with an impenetrable mesh of curves that are impractical to follow - to state the least - making it hard to identify clinically significant aberrations, i.e. such deviations from the standards that may indicate a clinical disorder.

Therefore it is necessary to devise a kind of display of gait measurement record that would allow a visual and simple method to navigate the data and direct the clinician towards those regions where he should point his attention the most during the interpretation of the results. One solution of this kind was proposed by Manal and Stanhope (Manal, Stanhope, 2004.) and in this paper an application of their principle is shown in a clinical computerized gait analysis system.

## Coloured coding

The principle proposed by Manal and Stanhope (Manal, Stanhope, 2004.) comprises in the display of output data of the gait analysis system where the difference of a value of a measured curve in a certain point of time during the gait cycle  $y_i$  and a value of the standardised curve  $\bar{y}_i$  is displayed in relation towards the amount of the standard deviation of the standardized curve in that point  $\sigma(y_i)$ :

$$d_i = \frac{y_i - \bar{y}_i}{\sigma(y_i)} \quad (1)$$

Let us name the value  $d_i$  the normalized deviation, since it actually signifies the deviation in the observed point measured by the standard deviation. The idea is to mark (“code”) the amount of this deviation with a continuous scale of different colours that would allow good insight into the nature of the deviation with a quick glance.

Manal and Stanhope proposed the “colour coding” i.e. the coloured display such that the amounts of  $d_i$  falling within the zone less than one standard deviation would be coded with the shades of green, while the deviations toward negative would be coded with ever more red shades toward the full red part of the spectre (through the shades of yellow), and the deviations toward positive would be coded with ever more blue shades toward the full blue part of the spectre (through the shades of cyan), so that the extremes would be reached at the values of three standard deviations.

The usual way of colour coding in computerised systems is used according to the amount of red, green and blue component (i.e. the additive colour blending) where the amount of each component is graded in the range between 0 (complete absence of the component) and 255 (maximal presence of the component). It is shown by Manal and Stanhope that the entire spectre of colours may be used to code the range between -3 and +3 multiples of the standard deviation as shown in the figure 1.

These authors proposed a mathematical function that may be used for the purpose of colour coding composed of two equations for the two characteristic regions of the normalised deviation – linear one for the amount within the zone of one standard deviation, and biquadratic one for the region outside the zone:

$$C = 85 \cdot (3d^2) \quad \text{for } -1 \leq d \leq 1 \text{ and} \quad (2)$$

$$C = 305.7 - 17.597 \cdot (3d^2) + 0.2324 \cdot (3d^2)^2 \quad \text{for } -d < -1 \text{ or } > 1. \quad (3)$$

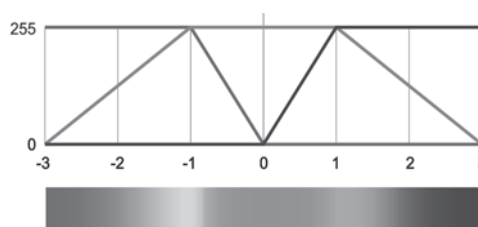

Figure 1. Zones of change of the components of colours for the region of normalized deviation between -3 and +3 of the standard deviation (Manal and Stanhope 2004).

The value  $C$  denotes the amount of that component that is variable in the region, while the other two components take the constant values characteristic for the zone. For example, for  $d = -0.5$  the value  $C$  is calculated according to the expression (2):  $C = 63.75$ ; in practice this is rounded to an integer. In this zone the red component is variable (cf. fig. 1.: for  $-0.5$  blue and green are constant), so  $R = C = 64$ , while for green and blue the values for constants are  $G = 255$ ;  $B = 0$ .

Using this kind of colour coding for each integer percentage of the gait cycle, a multicoloured stripe is obtained instead of the graph consisting, as a rule, of at least four curves: the curve of the standardized values, two curves of its standard deviations and the measured curve (Fig. 2).

Applying this method to all of the kinematic and kinetic curves a much more synoptical report could be obtained, where all the data regarding one measurement may be singled out onto one report page that the clinician may study with a simple glance. He can then analyse further the curves of the full report itself only for the possible observed significant deviations (but also using other clinical diagnostic tools), and he may ignore for the initial analysis the remaining curves where the deviations are of less significance.

The coloured coding stripes could be included together with the matching curves, like in the figure 2, but the coloured stripes could be extracted entirely and shown as a compendium on an overview sheet as shown on the figure 3. (Heimer, 2005.).

## Discussion

The coloured signal coding incorporated into the clinical gait analysis report presented in this paper significantly simplifies the readout of the output report, however the practical value of this method should still be evaluated in clinical practice. Namely, it is the matter for a clinician, an expert in orthopedics and other disciplines that are using these reports to determine whether the colour coding is performed in the way that is significant for their use. It may be assumed that the deviation larger than one standard deviation that is used as significant for this method of colour coding may in some cases (among the 45 curves of a standard report of the system) be of less significance, while in some other cases the deviation considerably less than one standard deviation from the healthy curve shape (i.e. from the standard) may have clinical implications.

On the other hand, for some variables the range between -3 and +3 of standard deviation may not be enough and the larger deviation that aren't yet considered pathological may require a larger range of the coding.

This paper presents a method and provides a tool, but its use and medical interpretation must be made by the experts using it. The clinical gait analysis systems are nowadays, as a rule, equipped with all the necessary technical prerequisites (computer, colour printer) to enable relatively simple inclusion of this algorithm. This would significantly increase the clinical usability of the measurement report and, consequently, contribute the entire purpose of the clinical gait analysis procedure.

## Conclusion

As an upgrade to the pre-existing system of reporting the results of the clinical gait analysis a method of the display of deviation from the standard using the colour coding (the Manal-Stanhope display) was proposed. The method is aimed at simplifying the process of interpretation of results of the gait measurement, by indicating to the clinical analyst the regions in the curves where the deviations from the standard are considerably larger than expected, so presumably could indicate a pathology. This should decrease the time needed for clinical analysis of the gait evaluation output reports.

## References

1. Inman, V.T., Ralston, H.J., Todd, F. (2006). Human locomotion, In: Rose J, Gamble JG, editors. Human walking, 3rd ed. Lippincott Williams & Wilkins, Baltimore.
2. Gage, J. (2004). The treatment of gait problems in cerebral palsy, Mac Keith Press.
3. Simon, R.S. (2004). Quantification of human motion: gait analysis – benefits and limitations to its application to clinical problems, *J Biomech*, 37: 1869-1880.
4. Medved, V. (2001) Measurement of human locomotion, CRC Press, Boca Raton, FL.
5. Wu, G., Cavanaugh, P.R. (2001). ISB recommendations for standardization in the reporting of data, *J Biomech* 28(10): 1257-1261. Reprinted in: Medved, V. "Measurement of human locomotion," CRC Press, Boca Raton, FL, 1995, 235-241.
6. Wu, G., Siegler, S., Allard, P., Kirtley, C., Leardini, A., Rosenbaum, D., Whittle, M., D'Lima, D.D., Cristofolini, L., Wittle, H., Schmid, O., Stokes, I. (2002) Letter to the editor - ISB recommendation on definitions of joint coordinate system of various joints for the reporting of human joint motion - part I: ankle, hip, and spine, *J Biomech*, 35: 543-548.
7. Manal, K., Stanhope, S.J. (2004) A novel method for displaying gait and clinical movement analysis data, *Gait & Posture*, 20(2): 222-226.
8. Heimer, Ž. (2005) Automated measurement of biomechanics and kinesiology of gait, MSc Thesis. University of Zagreb, Faculty of Electrical Engineering and Computing, (in Croatian)

## Acknowledgment

The results presented are the product of scientific projects „Automated motion capture and expert evaluation in the study of locomotion“ and „Real-life data measurement and characterization“, realized with the support by The Ministry of Science, Education and Sports, Republic of Croatia.



## COMPARATIVE KINEMATIC ANALYSIS OF PREPARATION PHASE OF TAKE OFF IN ACROBATIC ELEMENTS FROM “STUFF POSITION”

Tomislav Krističević, Mladen Mejovšek and Saša Baščevan

Faculty of Kinesiology, University of Zagreb, Croatia

### Abstract

In this paper, the selected kinematic parameters that describe preparation phase of three basic acrobatics elements take-off from stuff position, forward and tucked somersault backward, were analyzed and compared mutually. For purposes of this research, the demonstration of techniques was performed by 20 dance couples. The 13 variables that describes the preparation phase, were extracted and processed by descriptive statistics. To determine the difference between acrobatics elements, a nonparametric statistic method Kruskal-Wallis test for independent groups, multiple comparative method and discriminative analyzes were used. In the Conclusion it is stated that there is a statistically significant difference in values of certain variables that describe preparation phase. There is no statistically significant difference in preparation phase between two types of tucked somersault as elements, but take-off from “stuff” position as entity has statistically significantly different preparation phase from those two elements of acrobatics.

**Key words:** tucked somersaults, acrobatic rock'n'roll

### Introduction

Acrobatic rock'n'roll is relatively new sport, started to be developed in early '70 is of last century. It consists from dancing and acrobatic elements, which are performed in mixed couples. The segment of acrobatics is dominated by elements with airborne phase, such as various types of somersaults. The most common type of take-off in to elements with airborne phase is take-off from “stuff position”.

When performing acrobatics elements from “stuff position”, partners begin facing each other. Male partner is slightly bend in knees, feet's spread at hip or shoulder width, body is slightly bent forward and arms outstretched and connected to the front of the body. Female partner approached and set foot of one of the legs on his palms, her body is upright and the arms are upfront. Followed by take-off with other leg from the ground and thus raises the center of gravity of the body above the partner's hand. Male partner extends his legs, continuing the movement by raising his hands and lifting partner until his hands reach the heights above the head where it stops. During this time, the female partner extends standing leg and raises her hands. In a final point of “stuff position” female partner perform take-off from partners palms. (fig 1.) (Krističević, 2001).



Fig.1. Final point of take-off from stuff position

There are three phases in performing all acrobatics elements from stuff position: *preparation phase*, *take-off phase* and *airborne phase*, which is determined by previous two phases. Despite the fact that all the dancing couples perform the same element technique, almost every couple has in the performance small individual differences. These differences are sometimes noticeable only to experts, but no matter how small are these differences in the performance, they can

affect different values of biomechanical parameters that determine the subsequent phase of flight, in which acrobatics elements are performed

In this paper, the selected kinematic parameters that describe preparation phase of three basic acrobatics elements, were analyzed and compared mutually. As “preparation phase”, time from end of last dance figure before acrobatic element, to the first contact of female foot with palms of male partner was defined.

## Methods

For purposes of this research, the demonstration of techniques was performed by 20 dance couples who were qualified into the quarter finale, semi finale and finale of tournament in Zürich.

The following elements of technique were objects of this study:

1. Take-off from “stuff position”
2. Tucked forward somersaults from “stuff position”
3. Tucked back somersaults from “stuff position”

Collecting of videos for purposes of this research was performed with four VHS cameras with 50 frames per second. Cameras were placed at an angle of 90° in relation to one other.

For the purpose of accurate calibration of space and satisfying preconditions for the possibility of three-dimensional analysis, all the cameras recorded the reference frame (180 x 180 x 90 cm), as well as so called “fix point” that had to be visible throughout the recording (Fig. 2).

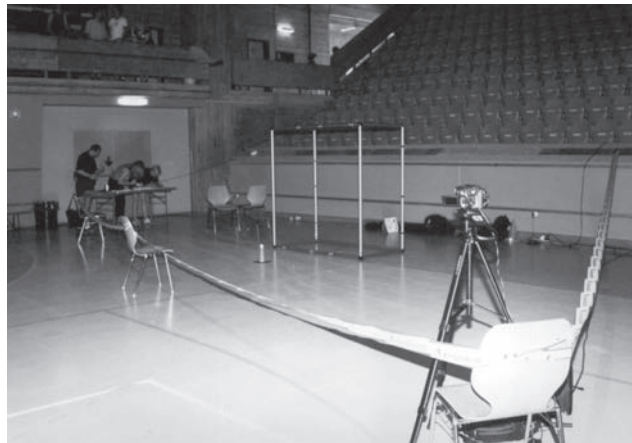

Fig. 2. Collecting a data

Data analysis for this study was performed using APAS (Ariel Performance Analysis System) procedures respecting all APAS's standards and specifics that are dictated by stereotypes that were the subject of this analysis. Video recordings were sawed in *avi*. format, then all of them where timed and then sequences for the analysis were selected.

Biomechanical model of female partner was determined by 18 anatomical points of the body, which define 14-segmental model of human body (Dempster, 1955). Beside 18 referent points of human body, that were digitalized, for each camera also a digitalization was provided of 8 points that define referent frame which is necessary for further analysis of data.

Transformation to in a real three dimensional space, was realized by *DLT* (Direct Linear Transform) algorithm. Filtering of three-dimensional coordinates was carried out by Cubic Spline algorithm. Most of analyzed variables are calculated directly by APAS, and some by appropriate trigonometric functions using data collected by APAS.

The variables that describe preparation phase and were selected for analysis are described in table 1.

Table 1. Variable of preparation phase

No.	NAME OF VARIABLE	Symbol	Unite
1	Duration of preparation phase	Tpf	S
2	Altitude of CG (center of gravity) at beginning of preparation phase	hCG 0	Cm
3	Highest altitude of CG in preparation phase	hCGmaxpf	Cm
4	Time of highest altitude of CG in preparation phase	t max h CGpf	S
5	Lowest altitude of CG in preparation phase	hCGminpf	Cm
6	Time of lowest altitude of CG in preparation phase	tmin h CGpf	S
7	Altitude of CG on the end of preparation phase	hCGkpf	Cm
8	Horizontal displacement of CG in 1 <sup>st</sup> . step	x1 CGpf	Cm
9	Horizontal displacement of CG in 2 <sup>nd</sup> . Step	x2 CGpf	Cm
10	Horizontal displacement of CG in preparation phase	xtot CGpf	Cm
11	Horizontal distance between take off leg and swing leg	xod-zam	Cm
12	Altitude of foot take off leg on the end of preparation phase	yod 0	Cm
13	Altitude of foot swinging leg on the end of preparation phase	yzam0	Cm

The values of kinematics variables collected in this survey were processed by descriptive statistics which was used to calculate following parameters, that are also used as a baseline to describe structure of movements in analyzed elements of techniques: mean, minimum value, maximum value, standard deviation, skewness, kurtosis.

To determine the difference between acrobatics elements, a nonparametric statistic method Kruskal-Wallis test for independent groups was used.

Multiple comparative method was used in the next step in order to determine between which of analyzed acrobatics elements there is a statistically significant difference in variables that were separated by previous procedure.

The last step of determination of statistically significant difference between analyzed elements was carried out by use of discriminative analyzes.

## Results and discussion

Although all three acrobatics elements look very similar in first two phases of performance (preparation phase and take-off phase) it was necessary to determine how much they have income in performance and where are the differences. Furthermore, simple take off from "stuff position" has been trained the same way for both somersaults so it was interesting to determine if there is statistically significant difference in kinematic parameters in preparation phase of these two elements.

In the first step of comparative analyzes preparation phase Kruskal-Wallis test was used as nonparametric test of variance with the aim to determine in which among variables there is a statistically significant difference. The level of statistical significance is determined as  $p < 0.05$ .

Table 2. K-W test of preparation phase

NAME OF VARIABLE	Stuff take-off	Backward somersault	Forward somersault	P
Duration of preparation phase	1,14	1,06	1,13	<b>0,027</b>
Altitude of CG (center of gravity) at beginning of preparation ph.	89,43	89,26	88,95	0,993
Highest altitude of CG in preparation phase	116,81	113,32	108,88	0,395
Time of highest altitude of CG in preparation phase	-0,15	-0,1	-0,34	0,121
Lowest altitude of CG in preparation phase	84,4	87,88	84,21	0,092
Time of lowest altitude of CG in preparation phase	-0,42	-0,41	-0,38	0,777
Altitude of CG on the end of preparation phase	104,16	106,63	108,18	0,668
Horizontal displacement of CG in 1 <sup>st</sup> . step	17,32	21	17,04	0,101
Horizontal displacement of CG in 2 <sup>nd</sup> . step	50,09	31,09	30,96	<b>0,000</b>
Horizontal displacement of CG in preparation phase	80,96	67,64	72,57	0,170
Horizontal distance between take off leg and swing leg	33,51	40,35	35,36	0,271
Altitude of foot take off leg on the end of preparation phase	66,54	60,05	61,92	0,442
Altitude of foot swinging leg on the end of preparation phase	10,66	9,5	11,89	0,876

Performed analyzes indicated two variables with significant difference (table 2.): duration of preparation phase ( $p < 0.027$ ) and horizontal displacement in 2<sup>nd</sup> step ( $p = 0.00$ )

Next step was to determine between which of analyzed elements there is a difference in previously extracted variables. That was performed by use of .multiple comparative method.

Table 3. Multiple comparative analysis of *p* values for variable duration of preparation phase

tpf Independent (grouping) variable: grup Kruskal-Wallis test: H ( 2, N= 52) =7,184410 p =,0275

	1 stuff take-off	2 backward somesault	3 forward somersault
1		<b>0,031</b>	1,000
2	<b>0,031</b>		0,118
3	1,000	0,118	

Performed analyze determine statistically significant difference in this variable between take-off from stuff position and backward somersault ( $p = 0.031$ ). Further more there was no significant difference between two types of somersaults and between forward somersault and take-off from stuff position (Table 3.)

Table 4. Multiple comparative analysis of *p* values for variable: horizontal displacement of CG in 2<sup>nd</sup> step

x 2 CG pf Independent (grouping) variable: grup Kruskal-Wallis test: H ( 2, N= 52) =14,22913 p =,0008

	1 stuff take-off	2 backward somesault	3 forward somersault
1		<b>0,005</b>	<b>0,002</b>
2	<b>0,005</b>		1,000
3	<b>0,002</b>	1,000	

Performed analyses of *horizontal displacement of CG in 2<sup>nd</sup> step* determine statistically significant difference in this variable between take-off from stuff position and both somersaults. Further more there was no statistically significant difference between two types of somersault in this variable (Table 4).

Discriminative analysis was used to determine general difference between each technical element that was object of this study and contribute of every single variable to this difference.

Table 5. Individual contributions of each variable in preparation phase to difference between elements.  $p < 0,0000$

No.	NAME OF VARIABLE	P value
1	Duration of preparation phase	<b>0,020</b>
2	Altitude of CG (center of gravity) at beginning of preparation ph.	0,299
3	Highest altitude of CG in preparation phase	0,327
4	Time of highest altitude of CG in preparation phase	<b>0,002</b>
5	Lowest altitude of CG in preparation phase	0,307
6	Time of lowest altitude of CG in preparation phase	0,083
7	Altitude of CG on the end of preparation phase	0,449
8	Horizontal displacement of CG in 1 <sup>st</sup> . step	<b>0,005</b>
9	Horizontal displacement of CG in 2 <sup>nd</sup> . step	<b>0,000</b>
10	Horizontal displacement of CG in preparation phase	0,069
11	Horizontal distance between take off leg and swing leg	0,615
12	Altitude of foot take off leg on the end of preparation phase	<b>0,031</b>
13	Altitude of foot swinging leg on the end of preparation phase	0,245

Discriminative analysis was used to determine general difference between each technical element that was object of this study and contribution of every single variable to this difference, extracted 5 variables that have statistically significant contribution to these difference (Table 5). By use of backward stepwise discriminative analysis, from 13 variables at the beginning, excluding in every next step variable with lowest *f* value on the end of optimization of model there was only one variable – horizontal displacement of CG in 2<sup>nd</sup> step (Table 6.)

Table 6. Results of backward stepwise discriminative analysis

Step 4, N of vars in model: 1; Grouping: grup (3 grps) Wilks' Lambda: ,70149 approx. F (2,49)=10,426 p&lt; ,0002

	Wilks'	Partial	F-remove	p-level	Toler.	1-Toler.
x CG 2 <sup>nd</sup>	1,000000	0,701485	10,42589	0,000169	1,000000	0,00

Differences between groups are confirmed by Mahalanobis distance (Table 7) and related  $f$  – values (Table 8.).

Table 7. Mahalanobis distance

	G_1:1	G_2:2	G_3:3
G_1:1	0,000	1,717	1,739
G_2:2	1,717	0,000	0,000
G_3:3	1,739	0,000	0,000

Table 8. F-values

	G_1:1	G_2:2	G_3:3
G_1:1		14,393	16,078
G_2:2	14,393		0,000
G_3:3	16,078	0,000	

Table 9. p-level of significant

	G_1:1	G_2:2	G_3:3
G_1:1		0,000	0,000
G_2:2	0,000		0,980
G_3:3	0,000	0,980	

From table 9 it can be concluded that discriminated variable (horizontal displacement of CG in 2nd step) differ take-off from “stuff” position from both somersault, but there is no statistically significant difference between backward somersault and forward somersault in preparation phase.

## Conclusion

These analyses lead us to conclusion that there is a statistically significant difference in values of certain variables that describe preparation phase of all three elements of technique. However, seen as an entity, there is no statistically significant difference in preparation phase between two types of somersault. On the other hand, take-off from “stuff” position as entity has statistically significant difference in preparation phase compared to the both of somersaults, forward and backward.

## References

- Hay, J.G. (1985). *The Biomechanics of Sport Techniques*. Engelwood Cliffs: Prentice-Hall, Inc.
- Krističević, T. (2001). *Analiza nekih biomehaničkih parametara u izvedbama salta naprijed u različitim sportovima*. Magistarski rad Kineziološki fakultet: Zagreb 2001.
- Krističević, T., Knjaz, D., Antekolović, L.J. (2002). *Comparison of two types of tucked forward somersault in acrobatic rock'n'roll*. In: Proceedings book Kinesiology – New perspectives. (Eds. D. Milanović, F. Prot). Opatija 25-29. 9. 2002. pp. 222-225. Zagreb. Kineziološki fakultet
- Krističević, T. (2009). *Kinematička efikasnost izvođenja zgrčenog salta u akrobatskom rock'n'rollu*. Doktorska disertacija, Kineziološki fakultet: Zagreb 2009.
- Mejovšek, M. (1989). *Konstrukcija i evaluacija biomehaničkog N-segmentalnog modela za analizu gibanja muskuloskeletnog sistema ljudskog tijela*. Doktorska disertacija. Fakultet za fizičku kulturu: Zagreb.

## FEED-FORWARD POSTURAL ADJUSTMENTS TO ACTION

Mark L. Latash<sup>1</sup>, Alexander S. Aruin<sup>2</sup>, Miriam Klous<sup>2</sup>, Vennila Krishnan<sup>2</sup> and Pavle Mikulić<sup>3</sup>

<sup>1</sup>*Pennsylvania State University, USA*

<sup>2</sup>*University of Illinois at Chicago, USA*

<sup>3</sup>*Faculty of Kinesiology, University of Zagreb, Croatia*

### Purpose

We used the framework of the uncontrolled manifold hypothesis and the idea of multi-muscle synergies to explore feed-forward adjustments of human vertical posture to a voluntary action and to an expected perturbation.

### Methods

We quantified how standing persons prepared to (1) a quick voluntary action by the arms, (2) a quick voluntary body sway, and (3) a predictable external perturbation. Multi-muscle synergies were defined as co-varied adjustments in the magnitudes of muscle modes (defined within the muscle activation space using principal component analysis with factor extraction) across repetitive trials at comparable phases of action.

### Results

Early changes in postural muscle activation levels could be seen 400-500 ms prior to the action (experiment-2) or perturbation (experiment-3). Typical anticipatory postural adjustments (APAs) were seen about 100 ms prior to the action initiation in experiment (1) and prior to the perturbation in experiment-3. We quantified multi-muscle synergies stabilizing center of pressure coordinate in the anterior-posterior direction using the framework of the uncontrolled manifold hypothesis. During steady-state standing, there were strong synergies stabilizing the center of pressure coordinate in the anterior-posterior direction. The index of these synergies dropped about 100 ms prior to any visible changes in the averaged across trials levels of muscle activation. These anticipatory synergy adjustments were clearly seen in experiment-1 prior to anticipatory postural adjustments and in experiment-3 where they showed two phases, prior to early postural adjustments and prior to anticipatory postural adjustments.

### Conclusions

We suggest that the purpose of early postural adjustments is to optimize posture for the expected action/perturbation. In contrast, the purpose of APAs is to generate forces and moments of force against those expected from the action/perturbation. Anticipatory synergy adjustments attenuate synergies stabilizing center of pressure coordinate and thus facilitate its future shifts. The findings fit naturally a hierarchical scheme with synergic few-to-many mappings at each level of the hierarchy based on ideas of control with referent body configurations. Two types of control variables are assumed, associated with changes in magnitudes of performance variables (such as center of pressure coordinate) and with changes in their stability properties.

## THE CENTRE OF PRESSURE OF DOMINANT AND NON-DOMINANT FOOT IN QUIET STANCE IN 5 YEAR OLD CHILDREN

**Miha Marinšek**

*University of Maribor, Faculty of Education, Slovenia*

### Abstract

The aim of our study was to test how lateral preference, visual deprivation and different foot placements affect postural stability of 5 year old children. We studied nineteen  $5.3 \pm 0.2$  year old children, 9 boys and 10 girls. Six were left-footed. Four foot positions (feet together, feet apart, tandem and step) and two visual conditions (eyes open, eyes closed) were tested during a 60 second quiet stance. Lateral preference was considered. We used Parotec foot insoles to measure various variables of the centre of pressure. The results showed that children at the age of five years load their non-dominant foot more and use their dominant foot for controlling the quiet stance. We also found out the visual information to be less important for children's postural stability than the foot position. Visual deprivation did not affect children's stability. The reduction of the base of support in lateral direction significantly decreased children's stability.

**Key words:** *postural sway, lateral preference, preschool age*

### Introduction

Humans are, according to the body composition and the fact that we are bipeds, quiet unstable systems. Therefore we must have a well developed control over our balance. Balance can be defined as the ability to maintain the body's centre of gravity (COG) projectin within the base of support. The ability to maintain the COG within the base of support involves the use of visual, vestibular and somatosensory information and its integration with multiple muscle contractions that are required to maintain stance (Kirby, Price & MacLeod, 1987).

During quiet stance, the COG moves within the base of support which is defined as postural sway. In consequence of the body sway the pressure under each foot changes. Under each foot there is the centre of pressure (COP) that is defined as the point location of the vertical ground reaction force vector. The COP under each foot is independant of COG (Winter, 1995) and represents moment data produced by the muscles required to maintain stance.

In studies of normal subjects which have used COP measure many different variables have been followed. Visual input and foot placement were probably the most frequently used variables (Winter, 1995). However these studies did not take into consideration lateral foot preference. The interpretation of COP referred to left and right foot and not to dominant and non-dominant foot. As it has been noted before, the lateral preference has a significant impact on the children's motor behaviour (Coren, Porac & Duncan, 1981). From this fact we can assume that we have to take into consideration the lateral foot preference when interpreting the COP in different quite stance conditions.

The aim of our study was to test how visual deprivation and different foot placements affect postural stability in 5 year old children. Furthermore, we tried to verify what effect has lateral preference on the postural stability in 5 year olds.

### Methods

#### Subjects

We studied 19 normal subjects, 9 boys and 10 girls, with parents' consent. Their mean age was  $5.3 \pm 0.2$  years (B:  $5.4 \pm 0.3$  yr; G:  $5.3 \pm 0.1$  yr), mean height was  $113.2 \pm 6.8$  cm (B:  $112.6 \pm 7.6$  cm; G:  $113.8 \pm 6.5$  cm) and mean body mass was  $20.9 \pm 4.0$  kg (B:  $20.1 \pm 4.3$  kg; G:  $21.7 \pm 3.8$  kg). Six among them were left-footed.

#### Procedure

We collected COP data for 60 s while the subject stood upright, with his/her arms resting at his/her sides, looking at a fixed point. Parotec foot insoles were used to collect the data, which we sampled at the frequency of 50 Hz. The Parotec system was found to be an effective tool in postural sway balance assessment. Its sensors have showed less than 2% measurement error in the range of 0 – 400 kPa and provided highly consistent data which was deemed acceptable for our study.

Each subject underwent a series of test variations. We used foot position and visual input variables to conduct different test conditions. Subjects were studied in four foot positions (feet together, feet apart, tandem and step) and two visual conditions (eyes open, eyes closed). To determine the width and distance of the feet in feet apart and step positions we asked subjects to adopt their preferred stance width in determined positions. According to these results and study done by McIlroy & Maki (1997) we determined the width to be 15 cm in mediolateral and 15 cm in anteroposterior direction for all subjects. The mediolateral distance was determined as the width between the midlines of the two heels. The anteroposterior distance was determined as the distance between the distal end of the great toe and midpoint of the heel. Tandem position was defined as the position where the great toe of one foot touched the heel of the second foot. All positions except of the tandem one were tested under eyes open and eyes closed conditions. The tandem with eyes closed condition was proven to be too difficult to execute without losing balance for children at this age. Randomization of the test order was conducted. Foot dominance was determined before the balance test using Coren, Porac & Duncan (1981) measure. At the tandem and step positions 8 subjects performed the positions with dominant foot in front and 11 performed the positions with non-dominant foot in front.

A series of variables were collected to analyze postural sway: geometric location of the COP under each foot, geometric range [mm] of the COP in mediolateral direction under each foot, geometric range [mm] of the COP in anteroposterior direction under each foot, total distance travelled [mm] by the COP, pressure [N/cm<sup>2</sup>] for the heel, mid foot and toes region under each foot. Each foot insole has 16 discrete pressure sensors. The sole of the foot area was divided into heel area (sensor #1 - #4), mid foot or support area (sensor #5 - #14) and toe or push off area (sensor #15 - #16) as proposed by the Parotec system.

We used matched pairs t-tests to make statistical comparison between dominant and non-dominant foot. The ANOVA design for each measure was 3 (foot positions) x 2 (visual conditions) with repeated measure on all factors. Tukey post hoc analysis was conducted to find main effects in foot placement and visual interactions.

## Results

The range of the COP was from  $5.9 \pm 3.9$  mm to  $24.2 \pm 8.9$  mm in M/L direction for dominant foot and from  $5.4 \pm 4.7$  mm to  $25.2 \pm 8.6$  mm for non-dominant foot (Table 1). In A/P direction the range of the COP was from  $45.7 \pm 29.0$  mm to  $103.0 \pm 28.5$  mm for dominant foot and from  $32.3 \pm 15.1$  mm to  $89.4 \pm 26.2$  mm for non-dominant foot. We did not find any statistically significant difference ( $P > 0.05$ ) in the range of the COP in M/L or A/P between dominant and non-dominant foot (Table 1).

Table 1. Range [mm] in mediolateral (M/L) and anteroposterior (A/P) direction of centre of pressure (COP) for dominant and non-dominant foot

	Feet together EO	Feet together EC	Feet apart EO	Feet apart EC	Tandem EO	Step EO	Step EC
non-dominant ML	11.9 ± 8.7 (4.5 - 36.4)	9.7 ± 7.5 (2.3 - 31.8)	5.4 ± 4.7 (1.8 - 23.7)	7.3 ± 6.8 (1.2 - 28.7)	25.2 ± 8.6* (5.4 - 38.4)	9.9 ± 6.8 (4.7 - 33.9)	11.1 ± 8.0 (3.5 - 34.1)
dominant ML	11.5 ± 8.9 (1.8 - 35.8)	9.4 ± 6.5 (2.0 - 26.2)	5.9 ± 3.9 (1.8 - 17.6)	7.4 ± 5.5 (1.8 - 21.0)	24.2 ± 8.9† (12.7 - 42.0)	12.8 ± 9.2 (2.2 - 43.0)	15.9 ± 9.1 (2.5 - 33.0)
non-dominant A/P	60.0 ± 31.3 (19.9 - 129.1)	54.6 ± 28.6 (16.5 - 122.4)	32.3 ± 15.1‡ (14.2 - 69.9)	48.3 ± 26.7‡ (11.1 - 134.9)	89.4 ± 26.2‡‡ (36.0 - 128.1)	63.4 ± 34.0 (8.5 - 134.3)	81.9 ± 32.4 (18.3 - 137.9)
dominant A/P	56.8 ± 28.3 (24.5 - 118.9)	50.9 ± 21.5 (21.2 - 85.4)	45.7 ± 29.0 † (10.0 - 132.9)	51.3 ± 27.0 † (10.5 - 139.2)	103.0 ± 28.5 †‡ (19.2 - 131.1)	79.6 ± 37.1 (22.5 - 157.0)	96.8 ± 30.9 (21.8 - 147.7)

Data are means ± SD (minimum - maximum)

\* Significantly greater in Tandem versus all other positions ( $P < 0.05$ ,  $n = 19$ )

† Significantly greater in Tandem versus all other positions ( $P < 0.05$ ,  $n = 19$ )

‡ Significantly smaller in Feet apart EO, EC versus all other positions ( $P < 0.05$ ,  $n = 19$ )

‡‡ Significantly greater in Tandem versus all other positions ( $P < 0.05$ ,  $n = 19$ )

† Significantly smaller in Feet apart EO, EC versus all other positions ( $P < 0.05$ ,  $n = 19$ )

‡ Significantly greater in Tandem versus all other positions ( $P < 0.05$ ,  $n = 19$ )

The range of the COP was from  $5.4 \pm 4.7$  mm to  $25.2 \pm 8.6$  mm in M/L and from  $32.3 \pm 15.1$  mm to  $103.0 \pm 28.5$  mm in A/P direction for the stances with visual informations and from  $7.3 \pm 6.8$  mm to  $15.9 \pm 9.1$  mm in M/L direction and from  $48.3 \pm 26.7$  mm to  $96.8 \pm 30.9$  mm in A/P direction for the stances without visual informations (Table 1). We did not find any statistically significant difference ( $P > 0.05$ ) in the range of the COP between visual conditions (Table 1).

The results show great importance of foot position on the range of the COP in M/L and A/P directions (Table 1). The range of the COP in the tandem position is greater compared to all other positions in M/L and A/P direction for dominant and non-dominant foot ( $P < 0.05$ ). The range of the COP in the feet apart position is smaller compared to all other positions in M/L and A/P direction for dominant and non-dominant foot ( $P < 0.05$ ).



Table 2. Total distance [mm] of centre of pressure (COP) for dominant and non-dominant foot

	Feet together EO	Feet together EC	Feet apart EO	Feet apart EC	Tandem EO	Step EO	Step EC
non-dominant	526.4 ± 214.3 (229.0 - 1002.8)	528.8 ± 273.8 (238.9 - 1431.7)	351.9 ± 162.7 (136.7 - 689.7)	394.8 ± 135.3 (170.7 - 762.6)	906.3 ± 257.8† (590.8 - 1416.3)	501.5 ± 215.2 (280.2 - 1085.1)	640.8 ± 294.3†† (148.5 - 1479.7)
dominant	510.1 ± 204.3 (191.3 - 944.7)	482.3 ± 179.1 (255.6 - 885.6)	405.2 ± 149.6 (213.9 - 699.8)	492.2 ± 266.5 (160.7 - 1372.9)	963.3 ± 363.2‡ (334.3 - 1735.7)	598.9 ± 235.6 (179.1 - 1063.3)	814.2 ± 316.0‡‡ (236.5 - 1412.2)

Data are means ± SD (minimum - maximum)

† Significantly greater in Tandem versus all other positions ( $P < 0.05$ ,  $n = 19$ )

†† Significantly greater in Step EC versus Feet apart EO, EC ( $P < 0.05$ ,  $n = 19$ )

‡ Significantly greater in Tandem versus all other positions except of Step EC ( $P < 0.05$ ,  $n = 19$ )

‡‡ Significantly greater in Step EC versus Feet together EO, EC and Feet apart EO, EC ( $P < 0.05$ ,  $n = 19$ )

The total distance of the COP ranged from 405.2 ± 149.6 mm to 963.3 ± 363.2 mm for dominant foot and from 351.9 ± 162.7 to 906.3 ± 257.8 mm for non-dominant, respectively (Table 2). We did not find any statistically significant difference in the total distance of the COP between dominant and non-dominant foot ( $P > 0.05$ ).

We found statistically significant difference ( $P < 0.05$ ) in the total distance of the COP between step EO and step EC conditions. Step EC showed further total distance of the COP than step EO for dominant (814.2 ± 316.0 mm; 598.9 ± 235.6 mm) and non-dominant foot (640.8 ± 294.3 mm; 501.5 ± 215.2 mm) (Table 2).

The COP of dominant and non-dominant foot delineates the farthest distance in tandem (dominant: 963.3 ± 363.2 mm, non-dominant: 906.3 ± 257.8 mm) and step EC (dominant: 814.2 ± 316.0 mm, non-dominant: 640.8 ± 294.3 mm) positions compared to other positions ( $P < 0.05$ ) (Table 2). The COP of both feet delineates the shortest distance in feet apart positions (EO-dominant: 405.2 ± 149.6 mm; EO-non-dominant: 351.9 ± 162.7 mm; EC-dominant: 492.2 ± 266.5 mm; EC-non-dominant: 394.8 ± 135.3 mm) even though the base of support is bigger in step positions.

Table 3. Pressure values [N/cm<sup>2</sup>] for dominant and non-dominant foot according to sole area

	Feet together EO		Feet together EC		Feet apart EO		Feet apart EC		Tandem EO		Step EO		Step EC	
	non-dominant	dominant	non-dominant	dominant	non-dominant	dominant	non-dominant	dominant	non-dominant	dominant	non-dominant	dominant	non-dominant	dominant
heel	7.5 ± 7.9 (1.3 - 16.2)	7.8 ± 7.5 (1.0 - 16.2)	7.1 ± 7.8 (1.4 - 13.8)	7.8 ± 8.0 (1.5 - 18.9)	9.2 ± 8.8* (1.3 - 16.3)	7.7 ± 8.6 (1.7 - 16.8)	8.2 ± 8.6 (1.4 - 17.0)	7.0 ± 7.4 (0.9 - 13.7)	5.3 ± 6.3 (0.4 - 10.0)	5.4 ± 6.7 (0.4 - 14.2)	5.5 ± 6.1 (0.0 - 12.6)	5.6 ± 6.1 (0.2 - 11.4)	6.3 ± 7.0 (0.4 - 12.7)	5.9 ± 7.2 (1.4 - 10.9)
support	1.4 ± 2.1 (0.3 - 2.7)	1.8 ± 2.5 (0.5 - 3.4)	1.5 ± 2.3 (0.4 - 3.7)	1.8 ± 2.6 (0.3 - 4.0)	1.2 ± 1.8 (0.0 - 2.6)	1.1 ± 1.8 (0.3 - 2.2)	1.3 ± 2.2 (0.4 - 2.4)	1.1 ± 1.9 (0.4 - 2.6)	2.8 ± 4.3† (0.0 - 6.4)	1.7 ± 3.1 (0.1 - 4.3)	2.4 ± 2.8 (0.0 - 5.7)	1.5 ± 2.6 (0.1 - 6.7)	2.5 ± 3.0 (0.1 - 6.7)	1.2 ± 2.0 (0.0 - 5.4)
push off	0.4 ± 1.1 (0.0 - 3.8)	0.3 ± 0.9 (0.0 - 2.3)	0.6 ± 1.0 (0.0 - 3.0)	0.2 ± 0.6 (0.0 - 1.3)	0.5 ± 0.7 (0.0 - 5.1)	0.4 ± 0.8 (0.0 - 2.9)	0.5 ± 0.9 (0.0 - 5.1)	0.5 ± 1.0 (0.0 - 4.4)	1.6 ± 2.8 (0.0 - 5.2)	1.4 ± 2.3 (0.0 - 11.3)	3.8 ± 3.6† (0.0 - 20.5)	1.4 ± 1.8 (0.0 - 7.6)	3.4 ± 3.3 (0.0 - 23.9)	1.3 ± 2.9 (0.0 - 8.6)
SUM	45.1 ± 9.3 (18.2 - 76.4)	49.2 ± 10.0 (15.9 - 82.1)	45.0 ± 10.7 (16.6 - 77.8)	49.3 ± 11.4 (17.7 - 85.0)	49.5 ± 3.1 (8.1 - 76.8)	42.3 ± 3.5 (13.3 - 85.3)	46.3 ± 3.8 (14.6 - 80.2)	40.3 ± 3.6 (10.3 - 69.8)	52.2 ± 12.0 (1.7 - 102.7)	41.8 ± 11.6 (7.0 - 94.0)	53.8 ± 6.5 (16.1 - 102.3)	39.6 ± 5.2 (6.0 - 104.6)	56.7 ± 7.5 (19.9 - 90.3)	38.2 ± 6.6 (15.9 - 73.8)

Data are means ± SD (minimum - maximum)

\* Significantly greater in Feet apart EO versus Tandem, Step EO ( $P < 0.05$ ,  $n = 19$ )

† Significantly greater in Tandem versus Feet together EO, EC, Feet apart EO, EC ( $P < 0.05$ ,  $n = 19$ )

‡ Significantly greater in Step EO versus Feet together EO, EC, Feet apart EO, EC ( $P < 0.05$ ,  $n = 19$ )

†† numbers indicate significant difference between non-dominant and dominant foot

In all but feet together position the non-dominant foot was more loaded than dominant foot. The difference ranged from 4% to 20%. In step EC position we found the whole pressure on the non-dominant foot (56.7 ± 7.5 N/cm<sup>2</sup>) to be statistically significant ( $P < 0.05$ ) higher than on the dominant foot (38.2 ± 6.6 N/cm<sup>2</sup>) (Table 3). The non-dominant foot is for 20 % more loaded than the dominant.

We did not find differences in any of the dynamic variables between visual conditions ( $P < 0.05$ ). The distribution and the amount of the pressure do not differ between visual conditions. The pressure on the dominant foot ranges from 38.2 ± 6.6 N/cm<sup>2</sup> to 49.3 ± 11.4 N/cm<sup>2</sup> for eyes closed condition and from 39.6 ± 5.2 N/cm<sup>2</sup> to 49.2 ± 10.0 N/cm<sup>2</sup> for eyes open condition (Table 3). The pressure on the non-dominant foot ranges from 45.0 ± 10.7 N/cm<sup>2</sup> to 56.7 ± 7.5 N/cm<sup>2</sup> for eyes closed condition and from 45.1 ± 9.3 N/cm<sup>2</sup> to 53.8 ± 6.5 N/cm<sup>2</sup> for eyes open condition (Table 3). The pressure on the heel amounts to 6.9 ± 4.2 N/cm<sup>2</sup> for eyes open condition and 7.2 ± 3.8 N/cm<sup>2</sup> for eyes closed condition, on the support area 2.0 ± 1.6 N/cm<sup>2</sup> and 1.7 ± 1.3 N/cm<sup>2</sup>, push off area 1.6 ± 3.2 N/cm<sup>2</sup> and 1.5 ± 4.0 N/cm<sup>2</sup>, respectively (Table 3).

Foot position has a significant effect on the pressure distribution over the sole (Table 3). The pressure in feet together (heel: 7.29 ± 3.90 N/cm<sup>2</sup>, supp: 1.49 ± 0.78 N/cm<sup>2</sup>, push off: 0.50 ± 0.99 N/cm<sup>2</sup>) and feet apart (8.70 ± 4.37 N/cm<sup>2</sup>, supp: 1.20 ± 0.65 N/cm<sup>2</sup>, push off: 0.53 ± 1.23 N/cm<sup>2</sup>) is distributed more to the heel where as in tandem (5.31 ± 3.05 N/cm<sup>2</sup>, supp: 2.78 ± 1.87 N/cm<sup>2</sup>, push off: 1.56 ± 1.82 N/cm<sup>2</sup>) and step positions (5.89 ± 3.50 N/cm<sup>2</sup>, supp: 2.45 ± 1.85 N/cm<sup>2</sup>, push off: 3.58 ± 5.90 N/cm<sup>2</sup>) more to the support and push off area of the sole ( $P < 0.05$ , Table 3).

## Discussion

In our study we tested whether lateral preference influences postural stability performance. The postural stability performance was assessed with help of the centre of pressure (COP). We calculated the range of the COP in M/L and A/P direction, the total distance of the COP travelled and pressure distribution over the sole of the feet during a 60 second quiet stance. The subjects performed quiet stance in various conditions. Foot position and gain of visual information were criterions for conducting various quiet stance conditions. Only one variable in the step EC position showed statistically significant difference between dominant and non-dominant foot. In step EC position the non-dominant foot was more loaded compared to the dominant foot. We can see the same trend in all but feet together position, although not with statistically significant differences. The difference in pressure ranged from 4% to 20% in favour of non-dominant foot. These results were a surprise for us as we hypothesized that the pressure would be greater on the dominant foot. It seems that children at this age load their non-dominant foot more and use their dominant foot for controlling the stance. To support this idea we can use the total distance of the COP data. The total distance of the COP was greater for the foot that was less loaded. In case of feet together position the total distance of the COP was greater for the non-dominant foot and for all other positions for dominant foot. The range of the COP of the less loaded foot was greater in both, M/L and A/P, directions than the range of the COP of the more loaded foot.

Our result showed that there is no difference in postural stability between the quiet stances in the visual and non-visual conditions. The children showed the same postural stability in eyes open and eyes closed conditions. It seems the visual deprivation is less important for children's postural stability at the age of five years than the foot position. Hytönen, Pyykkö, Aalto & Starck (1993) found out that visual system was more important for balance control in the old rather than children. To their opinion the pressoreceptor and proprioceptive information are more important for children's postural control. Our results confirm this statement showing that the distribution and the amount of the pressure as well as the range and the distance of the COP do not differ between visual conditions.

On the other side we found difference in postural stability between different foot positions. The children were the most stable in feet apart position. They were less stable in feet together and step position and the least stable in tandem position. The reduction of the base of support in lateral direction seems to be of great importance for young children's postural stability.

## References

1. Coren, S., Porac, C & Duncan, P. (1981). Lateral preference behaviors in preschool children and young adults. *Child Development*, 52, 443-450.
2. Hytönen, M., Pyykkö, I., Aalto, H. & Starck, J. (1993). Postural Control and Age. *Acta Oto-laryngologica Advanced Search*, 113(1-2), 119-122.
3. Kirby, R.I., Price, N.A. & MacLeod, D.A. (1987). The influence of foot position on standing balance. *Journal of Biomechanics*, 20, 423-427.
4. McIlroy, W.E. & Maki, B.E. (1997). Preferred placement of the feet during quiet stance: development of a standardized foot placement for balance testing. *Clinical Biomechanics*, 12(1), 66-70.
5. Winter, D.A. (1995). Human balance and posture control during standing and walking. *Gait & Posture*, 3, 193-214.

## TAKE-OFF KINEMATICS OF THE TRIPLE LUTZ IN ARTISTIC ROLLER SKATING

Franco Merni, Silvia Fantozzi, Simone Ciacci, Laura Querin and Rocco Di Michele

*Faculty of Exercise and Sport Science, University of Bologna, Italy*

### Abstract

A biomechanical analysis of the Triple Lutz was performed using a stereophotogrammetric system in five world-class roller skaters. On average, the pelvis centre showed a horizontal velocity at the toe-assist lower than in the previous phases. The horizontal velocity decreased after the toe-assist, then remained constant up to the take-off. The vertical velocity was already elevated at the left skate end-gliding, and reached higher values at the take-off. In the toe-assisting leg, the hip and the knee showed a limited eccentric work phase, whereas the ankle showed a marked loading. Regarding the gliding leg, at the toe-assist the hip was in the neutral position on the frontal plane, whereas it was markedly flexed, as the knee and the ankle. Taken together, the results showed rather different executive strategies in various phases of the movement, highlighting individual interpretive patterns.

**Key words:** *biomechanics, jumping performance, motion analysis*

### Introduction

The biomechanical analysis of a sport skill is an important tool for coaches, providing a reference model to improve and correct an athlete's technique. The Triple Lutz is a typical jump in artistic roller skating, performed only by top-level athletes and considered to be very difficult to execute and improve. Previous studies have performed a biomechanical analysis of jumps in ice-skating (King et al., 1994; King, 2001; King et al., 2004). Regarding the Triple Lutz, King examined the segmental contribution of the arms and the free leg to generate the vertical velocity, together with the use of the toe assist for the same purpose (King, 2001). However, no quantitative biomechanical studies have been performed on the Lutz in artistic roller skating. Therefore, the aim of this research was to analyse the kinematics of the Triple Lutz in world-class roller skaters.

### Methods

Five male athletes were recruited, including two senior world champions, a junior world champion, a bronze medallist at the junior world championship and an European champion. The mean (range) age, body mass and height were, respectively, 23 (18-26) years, 73 (71-81) kg, and 176 (160-184) cm. On average, the athletes practised artistic roller skating for 17 years (range: 14 - 20 years). Their mean experience with the Triple Lutz was of 6 years, ranging between 3 and 9 years. The athletes trained 14 hours per week with 8 to 20 additional hours dedicated to the physical conditioning.

Vertical jumping tests (squat jump and countermovement jump) were performed, using a contact mat, to assess the explosive strength of lower limbs.

In order to track the segment poses during motion, a stereo-photogrammetric system (Smart-D, BTS, 10 cameras, 250Hz) was used. Markers were placed on anatomical landmarks of the pelvis (anterior and posterior iliac spines), and skates (heel, first, and fifth metatarsal heads). For the shanks and thighs, 4 markers were attached for each segment to form technical clusters in order to reconstruct the poses during all the phases of motion and relevant anatomical calibrations were then performed as described by Cappozzo (1995)

For each of the athletes, and for both the left and right limbs, the following typical points were identified throughout the execution of the Triple Lutz: toe-assist point, end of gliding point, and take-off point. Then, the duration of the gliding phase duration was computed as the time between the left-toe assist point and the left skate take-off.

In order to analyse the motion of the whole body of the athlete, a point corresponding to the pelvis centre of mass, namely the centroid among the four iliac spines, was considered. Then, the following variables were identified: the minimum height value of the pelvis centre after the toe assist, the height at the take-off of the right skate, and the maximum height of the pelvis centre during the flight phase.

The analysis of lower limbs was carried out considering the hip, knee, and ankle angles during the different phases of the movements, from the toe-assist to the flight. Concerning the right hip, adduction and flexion values at the toe-assist were considered, as well as the respective maximum values reached in the instants after the toe-assist. Furthermore, the flexion and abduction values at the take-off were recorded. For the right knee and ankle, the flexion angle at toe-assist

was assessed, together with the respective maximum values reached in the instants after the toe-assist, and the flexion angle at the take-off.

The knee loading time, i.e. the time between the toe-assist and the maximum knee flexion, and ankle loading time were also assessed.

For the left hip, the following angles were recorded: adduction and flexion values at the toe-assist, the maximum adduction and abduction values in the instants following the toe assist, the maximum extension values at the end of the gliding, and the abduction and flexion values at the take-off. Finally, concerning the left knee and ankle angles, the flexion values at the toe-assist, the maximum flexion values at the end of the gliding, and the flexion values at the take-off, were assessed.

The linear velocities of the pelvis centre in the toe assist, end of the gliding and take-off phases points were also analysed. Furthermore, the maximum horizontal velocity before the contact of the foot with the ground was considered.

All the data are reported as mean values of the five subjects, and/or minimum and maximum individual values.

## Results

The mean (range) height in the squat jump and the countermovement jump were, respectively, 45.4 (42.2-51.2) cm and 51.1 (47.3-54.1) cm. Therefore, there was a 5.6 cm mean difference between the two jumps. In the countermovement jump with free arms, a test resembling more than others the gesture of the Lutz, the height was 6.6 cm greater than in the countermovement jump with no arm swing, with a mean value of 57.7 cm (range: 51.8 - 65.2 cm).

Regarding the phases preceding the take-off in the Triple Lutz, the duration of the gliding phase was about 2/3 of the entire contact phase (0.12 s vs. 0.18 s). Therefore, the duration of the pushing phase on one limb, i.e. the difference between the aforementioned phases, was only 0.06 s.

The mean loading of the pelvis just after the toe assist was of 14 mm (range 2-38 mm). Then, the pelvis centre raised on average of 25.4 cm at the take-off (range: 19.5 – 34.8 cm). The mean height of the flight trajectory was of 50.5 cm (range: 42.2 – 57.8 cm).

Regarding the right hip, the neutral position (i.e. with 0° of flexo-extension and abdo-adduction) occurred when the thigh was perpendicular to the pelvis. At the toe assist, the hip was almost in a neutral position on the frontal plane (2°). After the end of the gliding an abduction of 15° was observed, whereas at the take-off the abduction is slightly reduced (13°). Figure 1 displays the angular values on the sagittal plane for the right limb. The hip was definitely flexed at the toe-assist (36°) and the maximum flexion after the toe-assist was similar (37°), whereas the flexion was clearly decreased at the take-off, assuming values close to the neutral point (5°). At the toe-assist, in all the subjects the knee showed a marked flexion (60°), with values oscillating from a minimum of 50° to a maximum of 67°. In the following phase, all the subjects tended to load the knee, i.e. the flexion increased (66°). Then, there was a pronounced extending action, leading the knee at 16° (range: 11°-19°) at the take-off point (Fig. 1). Therefore, there was a 50° angular displacement between the maximum flexion and the maximum extension. Concerning the ankle, the neutral position (i.e. that with 0° of flexo-extension) occurred when the shank was perpendicular to the foot.

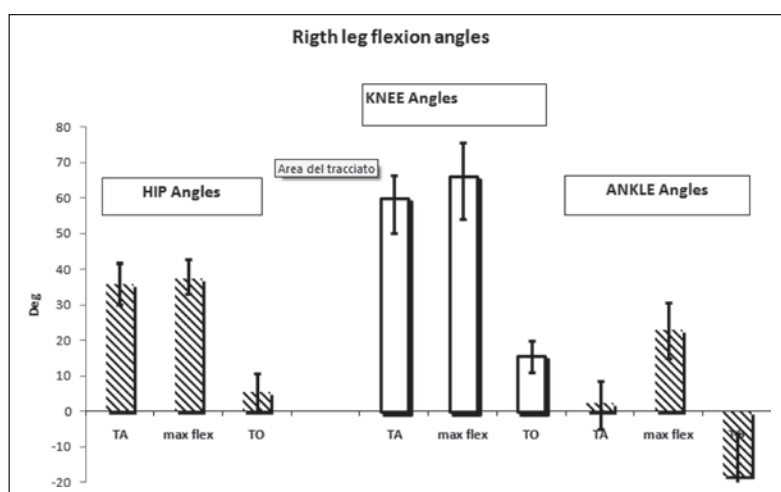

Figure 1. Flexion-extension angles of the right limb. TO= take-off; TA= toe-assist. The mean values and ranges are displayed

At the toe assist, the ankle was in the neutral position (2°). Then, a loading occurred (23° of dorsiflexion) more markedly than in the knee. At the take-off, the ankle showed a plantar extension of 18° (Fig.1). Therefore, there was a 41° angular excursion between the maximum loading and the take-off.

Concerning the loading time, mean values 0.027 s and 0.09 s were observed for the knee and the ankle, respectively.

The left hip movements in the latero-lateral direction (abuction – adduction) were very limited. At the toe assist, the hip was in the neutral position. Then, there was a slight adduction followed by a moderate abduction before the take-off of the right skate. After the right leg take-off, the hip was slightly adducted. Concerning the flexion, at the toe-assist, the left hip was more flexed than the right one (72°). Then, it was only moderately flexed (up to 22°, Fig 2).

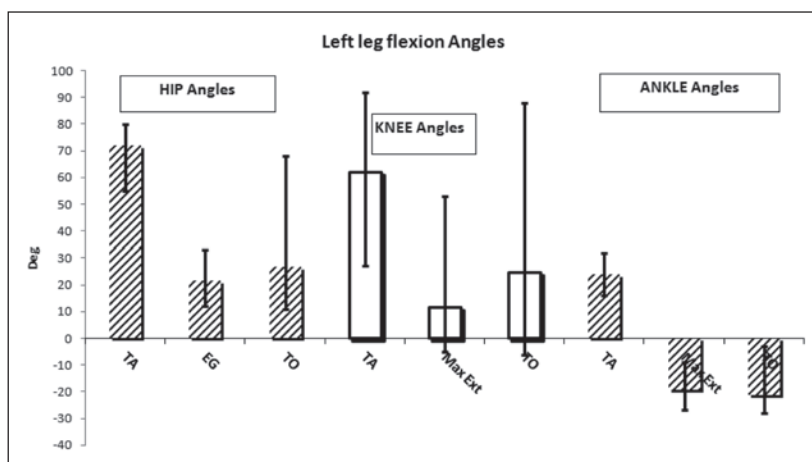

Figure 2. Flexion-extension angles of the left limb. TO= take-off; TA= toe-assist; EG= end of gliding. The mean values and ranges are displayed

Thereafter, the hip did not show clear extension movements in four out of the five subjects. Only one subject showed an evident flexion movement, leading the hip at 68° at the take-off point, whereas for the other athletes the value was of 26°.

The left knee and the ankle, at the toe assist, were clearly flexed (knee: 62°; ankle: 24° of dorsiflexion). Then, the knee showed the maximum extension in correspondence with the take-off of the left skate (12°). In the same instant, the left ankle showed a moderate plantarflexion of 19°. At the take-off of the right foot, the left knee showed a slight flexion (24°), whereas the ankle showed a little flexion (21°, Fig. 2).

Regarding the horizontal velocity of the pelvis, a little reduction of it can already be observed at the toe assist point (Fig. 3). The peak velocity varied from 4.72 m/s (recorded before the toe assist) to 4.18 m/s. Then, the velocity further reduced at end-gliding (2.71 m/s), and at the take-off of the jump it was 2.69 m/s. Therefore, the horizontal speed at the end of the gliding was almost equal to that at the take-off. The vertical velocities were negative at the toe assist (-0.54 m/s). This confirms that the pelvis at the toe assist was falling down. Then, the vertical velocities tended to increase from 2.2 m/s at the end of the gliding, to 2.9 m/s at the take-off. In the biomechanics of jumps, to analyse the relationships between horizontal and vertical velocity, the resultant velocity angle was also considered, given that if the horizontal velocity equals the vertical velocity at the take-off, the angle will be 45°.

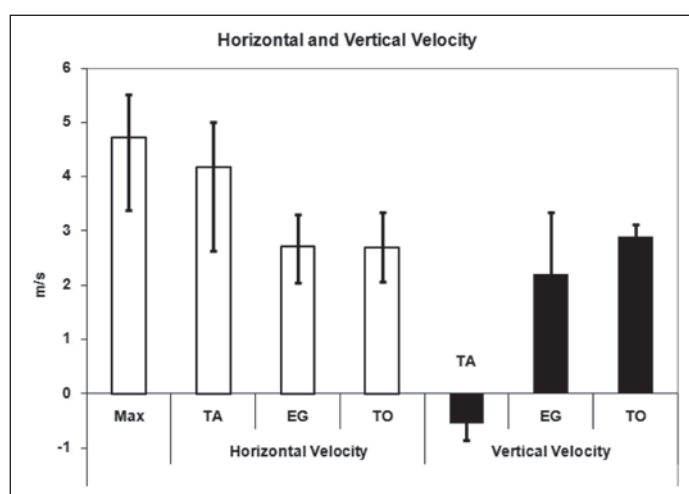

Figure 3. Horizontal and Vertical velocity values of the pelvis centroid. TO= take-off; TA= toe-assist; EG= end of gliding. The mean values and ranges are displayed

Angles higher than  $45^\circ$  indicate that the athletes use a vertical velocity that is higher than the horizontal one. The mean resultant velocity angle in the five athletes was  $37^\circ$  at the end of the gliding, and  $47^\circ$  at the take-off. This means that at the end of the gliding, the horizontal velocity was higher than the vertical velocity. Conversely, at the take-off, the two velocities were equivalent. It is important to note that, concerning the resulting velocity angle, the individual behaviour of the subjects was different: two subjects tended to make a more vertical jump with angles higher than  $50^\circ$ , whereas one subject showed an angle lower than  $45^\circ$ , thus exploiting more the horizontal than the vertical velocity.

## Discussion and conclusions

In this study, selected variables describing the take-off kinematics of the Triple Lutz in artistic roller skating were analysed. At the toe assist, the pelvis centre showed a horizontal velocity that was slightly lower than that observable in the immediately previous phases. At the toe assist, the pelvis decelerated in the horizontal direction and fell in the vertical direction of 1.4 cm for 0.04 s. The horizontal velocity decreased of almost one-half up to the take-off of the gliding skate, then it remained constant up to the jump take-off. The vertical velocity was already elevated at the left skate take-off (2.2 m/s), and reached higher values at the take-off of the jump (2.9 m/s). The five athletes adopted different strategies at the take-off: some of them used vertical velocities higher than the horizontal velocities, whereas others showed an opposite behaviour. Anyway, the vertical velocity oscillated from a minimum of 2.62 m/s to a maximum of 3.13 m/s, warranting a big elevation, oscillating from 42.2 to 57.8 cm.

It is possible to explain what is described about the pelvis motion by analysing the lower limbs kinematics. The toe assisting leg joints showed a loading action just after the toe assist, that was very little for the hip, moderate for the knee ( $6^\circ$ ), more pronounced for the ankle ( $21^\circ$ ). The loading time was the shortest for the knee (0.027 s) and the longest for the ankle (0.09 s). Considering the falling time of the pelvis (0.04 s), it can be concluded that the fall is related to the loading of all the three joints of the toe assisting leg. The action of vertical velocity reduction seems to depend mainly by the ankle. The pushing action of the right limb concerned all the joints. From the gliding skate take-off, the hip extended of  $32^\circ$ , the knee of  $50^\circ$ , and the ankle of  $41^\circ$ .

The hip and the knee showed an eccentric work phase that was very limited concerning both the amplitude and the duration. Conversely, the ankle showed a very pronounced loading phase, probably at the limits of the individual physiological capacities of dorsiflexion. In the final pushing phase, the ankle showed a plantar extension of  $18^\circ$ , far from the articular physiological limits.

The gliding leg, at the toe assist, was in the neutral position on the frontal plane, whereas it was markedly flexed such as the knee and the ankle. Then, the three joints made an extension movement, continuing up to the end of the gliding phase. The latero-lateral movements (adduction – abduction) of the hips were less evident in the initial phase for the gliding. The behaviour of the taking-off leg was very similar in the six athletes, whereas the other leg showed heterogeneous patterns.

Comparing the heights of the jumps performed with the skates and those performed without the skates, the elevation values of the Lutz were closer to those recorded in the countermovement jump with no free arms. In fact, the mean height value was of 50.5 cm vs. 51.1 cm of the countermovement jump (range: 42.2-57.8 in the Lutz vs. 47.3 – 54.1 in the CMJ). This means that the athletes, that in the Lutz normally use the arms, reach lower heights compared to the tests performed without the skates. This leads to think that the contribution of the arms to the jump take-off is more useful in the rotation than in the elevation.

## References

1. Cappozzo, A., Catani, F., Croce, U.D., Leardini A. (1995). Position and orientation in space of bones during movement: anatomical frame definition and determination. *Clinical Biomechanics*. 10:171-178.
2. King, D. (2001). Generation of vertical velocity in toe-pick figure skating jumps. XIX International Symposium on Biomechanics in Sport (ISBS). San Francisco, June, 20-26. pp 66-69.
3. King, D., Arnold, A., Smith, S. (1994). A kinematic comparison of single, double, and triple axel. *Journal of Applied Biomechanics*. 10:51-56.
4. King, D., Smith, S., Higginson, B., Muncasy, B., Scheirman, G. (2004). Characteristics of triple and quadruple toe-loops performed during the Salt Lake City 2002 Winter Olympics. *Sports Biomechanics*. 3:109-123.

## COMPARISON OF SOME BIOMECHANICAL SPATIAL, TEMPORAL AND VELOCITY PARAMETERS IN THE JUDO THROWING TECHNIQUES OSOTO GARI AND UCHI-MATA

Fadil Rexhepi<sup>1</sup> and Željko Hraski<sup>2</sup>

<sup>1</sup>University of Prishtina, Kosovo

<sup>2</sup>Faculty of Kinesiology University of Zagreb, Croatia

### Abstract

The purpose of this study is to compare differences of some biomechanical parameters between *Osoto gari* and *Uchi mata*, which are very efficient throwing techniques and therefore frequently used in judo competitions. Both throwing techniques are demonstrated by a judo master and executed on 10 opponents. The results of the biomechanical analysis are showing significant differences between the two techniques in some of the analyzed parameters: the duration of the phases of throwing, the distance between the centers of gravity (CG) of *Tori* (thrower) and *Uke* (the thrown) and linear velocity of the ankle of the reaping leg. According to these results it appears that during the execution of *Osoto gari* technique the power produced by the reaping leg is larger in comparison to *Uchi mata* technique.

**Key words:** *Osoto gari*, *Uchi mata*, biomechanics, linear velocity, angular velocity

### Introduction

Biomechanical analysis enables measurement of many kinematic, kinetic and electromyography parameters that determine the essential parts of throwing techniques, as well as their use in adequate conditions (Pucsook et al., 2001; Imamura & Jonson, 2003; Harter, 2003; Gordon et al. 2004).

The goal of each judoist is to throw the opponent as fast as possible and eliminate the risk of his counteraction. The studies of the throwing techniques from biomechanical aspect are not numerous, but recently their importance is more and more emphasized (Kim et al., 2005, Imamura et al., 2007; etc.) Fortunately, many analogies from studies of other combat sports, and also from other sports, can be taken as a good experience for biomechanical analysis in judo sport (Tsai et al., 2005, Inoue et al., 2008, etc.)

The purpose of this study is to establish and compare differences of some biomechanical parameters between the two judo throwing techniques, *Osoto gari* and *Uchi mata*.

*Osoto gari* and *Uchi mata* are techniques that are considered as the most frequented throwing techniques in judo competitions. This fact indicates for the high efficiency achieved with these throws. As in almost all throwing techniques in these two techniques we can distinguish three phases of throwing: *kuzushi* (preparatory movements aimed at throwing out of balance Uke's body), *tsukuri* (the final unbalancing action); and *kake* (execution of movements aimed at throwing). The execution of *Osoto gari* and *Uchi mata* is based on the same biomechanical principle which assumes the action of couple of forces (Sacripanti, 1989), where one force vector, which acts on the one side, is created by the hands of *Tori*, while the second vector of the force, acting on the other side, is the force created by the reaping action, or sweeping action of the attacking leg. On the other hand, these two techniques differ in the way of turning back of *Tori's* body during the realization of the throwing. When implemented the *Uchi-mata* technique *Tori's* body in the crucial moment (during the second phase) returns with his back towards *Uke*, while during the execution of the *Osoto gari* technique *Tori's* body will not turn and attack will be performed in front direction.

### Methods

This study involved 11 athletes, one *Tori* (judo master), and ten *Ukes*. Throwing conditions are defined precisely. The same judoist (*Tori*) executes the *Osoto-Gari* and then the *Uchi-mata* technique on ten others (*Uke*). Both techniques are executed in the form of demonstration (fig. 1, fig. 2). The video recording is made with three cameras, with speed of 60 frames per second. Video cameras were positioned at approximately 120° in relation to each other. The data processing is developed according to the standard procedures by APAS (Ariel Performance Analysis System) taking into account the specifics of the analyzed movement structure. The model for simultaneous analysis of the two athletes is designed. 18 referent points of the body of each judoist (total 36) are digitized for each frame of the recorded material. Transformation of 2D data to 3D space is calculated by DLT algorithm. The resultant three-dimensional point coordinates are filtered with *Cubic Spline* filter. On the base of such a prepared data selected kinematic parameters are calculated: linear displacement

of the *Tori's* and *Uke's* CG (center of gravity), the duration of the phases ( $t_1$ ,  $t_2$ ,  $t_3$ ), the duration of the entire throw ( $t$ ), linear velocity of *Tori's* ankle joint of the reaping leg in the sagittal plane ( $v$ ), the angular velocity of *Tori's* thigh during the reaping ( $\omega$ ) and angle in the knee joint of the reaping leg ( $\phi$ ).

## Results and discussion

### Spatial and temporal parameters of *Tori's* and *Uke's* center of gravity during the first phase (*kuzushi*) and second phase (*tsukuri*)

The distance between *Tori's* center of gravity and *Uke's* center of gravity in the beginning of the first phase of the *Osoto gari* technique is  $D = 66.5$  cm. The distance between the *Tori's* center of gravity and *Uke's* center of gravity at the end of the first phase of the throwing *Osoto gari* technique is:  $D = 39.9$  cm (tab. 1.)

It is understood that when *Tori* makes a step forward with left foot, he approaches *Uke* by unbalancing him and thus he is getting prepared for the second phase of throwing. Meanwhile, the distance between the *Tori's* center of gravity and *Uke's* center of gravity at the beginning of the first phase of the throwing at the *Uchi mata* technique is:  $D = 77.9$  cm. The distance between the *Tori's* center of gravity and *Uke's* center of gravity at the end of the first phase of the *Uchi mata* throwing technique is:  $D = 58.1$  cm (tab.1.)

Table 1. Differences of the CG positions of the *Tori* and *Uke* during the first and second phase of the *Osoto Gari* and *Uchi mata* technique

TECHNIQUE	PHASE 1 (distance between the CG)				PHASE 2 (The distance between the CG)			
	Start(Cm)	T - test	Finish(cm)	T - test	Start(cm)	T - test	Finish(cm)	T-test
O. GARI	66.5	T=7.12	39.9	T=11.23	39.2	T=11.13	39.9	T =1.56
U. MATA	77.9	p=.00	58.1	p = .00	56.9	p=.00	37.6	p= .13

Unbalancing of *Uke's* body depends on *Tori's* pull and of *Uke's* resistance. During the execution of the two techniques that have been analyzed in this study, *Uke* does not give active resistance. If we compare the distances of CG between the *Osoto gari* and the *Uchi mata* techniques at the end of the first phase (tab.1), we see that *Tori's* body at the *Osoto gari* technique is closer to *Uke's* body for 18.2 cm. The value of T - test is:  $T = 11.23$  ( $p = .000$ ), which means that the difference is high and with statistical significance. The duration of the first phase of throwing (*kuzushi*) at the *Osoto gari* technique is  $t = .42$  s, while at the *Uchi mata* technique is  $t = .34$  s (tab.2). One of the factors that enable shorter time in the first phase of the *Uchi mata* technique is the smaller step compared to the *Osoto gari* technique. The difference of this parameter between the two techniques is significant and the value of T - test is  $T = 6.64$  ( $p = .00$ ).

Table 2. Differences of the duration of the first, second and third phase of throwing, at the *Osoto gari* and the *Uchi mata* techniques

TECHNIQUE	PHASE 1 (duration)		PHASE 2 (duration)		PHASE 3 (duration)	
	t (s)	T - test	t (s)	T - test	t	T - test
O. GARI	.42	T = 6.64	.37	T = -15.67	.38 s	T = -.89
U. MATA	.34	p = .00	.64	p = .00	.40 s	p = .38

The distance between the *Tori's* and *Uke's* center of gravity at the beginning of the second phase of the *Osoto gari* throwing technique is:  $D = 39.2$  cm, while the distance between the *Tori's* and *Uke's* center of gravity at the end of the second phase of the *Osoto gari* throwing technique is:  $D = 39.9$  cm (tab.1). As shown in table 1, the distance between two CG of *Tori* and *Uke* as in the beginning as well as in the end of the second phase is almost the same. During this phase, the crucial action of execution of the technique remains on the reaping leg. Meanwhile, the distance between the CG of *Tori* and *Uke* at the beginning of the second phase of the *Uchi mata* throwing technique is:  $D = 56.9$  cm. The distance between the *Tori's* and *Uke's* center of gravity at the end of the second phase of the *Uchi mata* throwing technique is:  $D = 37.6$  cm (tab. 1). As shown in this technique, the distance between the *Tori's* and *Uke's* center of gravity at the end of the second phase is much lower, so, *Tori's* body with *Uke's* body is too close (tab.1). During the second phase at the *Uchi mata* technique, *Tori's* main actions are: the turn of his body, the hop of the reaping leg and the start of the reaping. If we compare the distances of CG between *Osoto gari* and *Uchi mata* techniques at the beginning of the second phase (tab.1), we see that differences are significant, and the value of T - test is:  $T = 11.13$  ( $p = .00$ ). At the end of the second phase the distances of CG between *Osoto gari* and *Uchi mata* techniques (tab. 1) are not significant, and the value of T - test is:  $T = 1.56$  ( $p = .13$ ). According to these results is concluded that the distance between the *Tori's* and *Uke's* center of gravity



in the early second phase of the Uchi mata technique is much higher compared to *Osoto gari* technique, but at the end of this phase the distance is approximately the same. The distance between the *Tori's* and *Uke's* center of gravity in the third phase (*kake*), considered as the phase of throwing itself is not very important, because during this phase *Uke's* feet are detached from the ground and with this the main parts of the throwing are finished. For this reason it is not necessary the analysis of the position of CG of the two athletes. The duration of the second phase at the *Osoto gari* technique is  $t = .37$  s, while at the *Uchi mata* technique is  $t = .64$  s (tab. 2). The difference of this parameter between the two techniques is significant and the value of T - test is  $T = -15.67$  ( $p = .00$ ). As shown in the table, the time for realization of this phase at the *Uchi mata* technique is much longer and this is due to the turn of *Tori's* body back in relation to *Uke* for  $180^\circ$ , while at the *Osoto gari* technique *Tori's* body will not turn back but he moves as more as possible towards *Uke*. So, many authors for all techniques that are executed without turning back *Tori's* body call them direct techniques, while those with the turn of the body call them indirect techniques (Otaki, 1996, Kano, 1994). The duration of the third phase at the *Osoto gari* technique is  $t = .38$  s, while in the *Uchi mata* technique is  $t = .40$  s. The difference of this parameter between the two techniques is not significant and the value of T - test is  $T = -.89$  ( $p = .38$ ). Thus, when *Uke's* feet are detached from the ground, the time of his decline does not differ much between different techniques hence the fall is inevitable. The duration of throwing at the *Osoto gari* technique is  $t = 1.18$  s, while the duration of throwing at the *Uchi mata* technique is  $t = 1.38$  s.

### Velocity parameters of the *Tori's* reaping leg during the second phase (*tsukuri*)

Linear velocity of *Tori's* ankle joint of the reaping leg in the sagittal plane  $v$  (m/s), during *Uke's* reaping leg is calculated as the average value for the last five frames just before the reaping, respectively detaching *Uke's* foot from the ground. Also, angular velocity and the angle of the knee of the reaping leg are analyzed for the last five frames. These are the five last frames of the second phase (tab. 3.)

Table 3. Linear velocity of the ankle ( $v$ ), angular velocity of the reaping thigh ( $\omega$ ) and the angle of the knee joint ( $\phi$ ) of *Tori's* reaping leg

	Linear speed ( $v$ ), Angular velocity ( $\omega$ ), Angle between thigh and shank ( $\phi$ )					
	$v$ (m/s)	T - test	$\omega$ (deg/s)	T - test	$\phi$ (deg.)	T - test
O. GARI	5.1	$T = 9.73$ $p = .00$	198.2	$T = .05$ $p = .96$	146.8°	$T = 1.62$ $p = .12$
U. MATA	2.9		194.9		137.0°	

The linear velocity of *Tori's* ankle joint of the reaping leg in the sagittal plane at the *Osoto gari* technique is  $v = 5.1$  m/s, while at the *Uchi mata* technique is much lower:  $v = 2.9$  m/s. So, the difference between these values is statistically significant ( $T = 9.73$ ;  $p = .00$ ). Thus, the hop and the effect of the reaping leg are convincingly higher at the *Osoto gari* technique compared to the *Uchi mata* technique. Angular velocity ( $\omega$ ) of *Tori's* thigh of the reaping leg during the execution of *Osoto gari* technique is  $\omega = 198.2$  degree/s, while at the *Uchi mata* technique is  $\omega = 194.9$  degree/s, so the difference between techniques is not significant ( $T = .05$  ( $p = .95$ )). The angle of the knee joint of the reaping leg during the execution at the *Osoto gari* technique is  $\phi = 146.8^\circ$ , while at the *Uchi mata* is  $\phi = 137.0^\circ$ , so, the difference is not significant ( $T = 1.62$  ( $p = .12$ )).

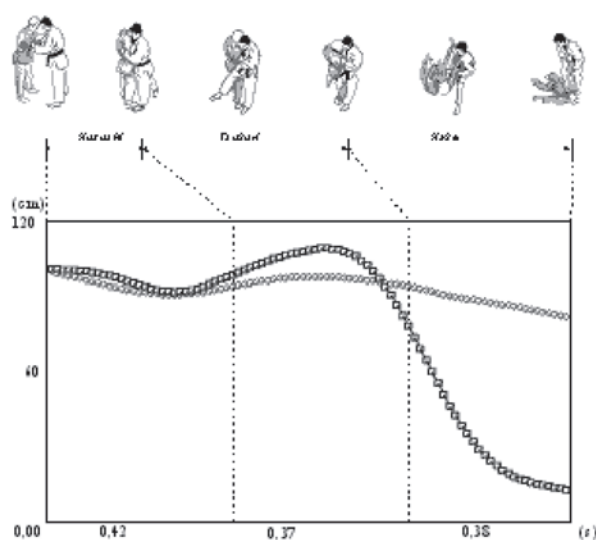

Figure 1. Time (duration) of the first phase (*kuzushi*), the second phase (*tsukuri*), third phase (*kake*) and the trajectory of *Tori's* CG ( $\diamond\diamond\diamond\diamond$ ) and *Uke's* CG ( $\square\square\square\square$ ) in the anterior-posterior direction – *Osoto gari*

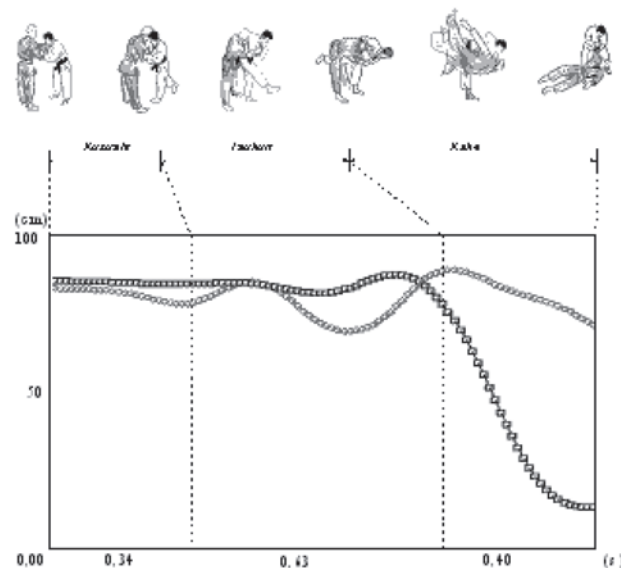

Figure 2. Time (duration) of the first phase (*kuzushi*), the second phase (*tsukuri*), third phase (*kake*) and the trajectory of Tori's CG (◇◇◇◇◇◇) and Uke's CG (□□□□□) in the anterior-posterior direction – *Uchi mata*

## Conclusion

Differences between the treated techniques in this study (*Osoto gari* and *Uchi mata*), are significant at the spatial parameter (distance) of CG of *Tori's* and *Uke's* body in the first phase (*kuzushi*) respectively in the beginning of the second phase (*tsukuri*). However, at the end of the second phase (*tsukuri*) the difference of the distance of the CG is not significant. Thus, *Tori's* body in each of the two techniques at the end of the second phase (the moment of the detachment of *Uke's* feet from the ground), is close as much as possible with *Uke's* body. Differences in duration of the throwing between the two techniques are significant during the first and the second phase, while during the third phase there are no significant differences. Linear velocity of the ankle of *Tori's* reaping leg is convincingly higher at the *Osoto gari* technique, while the angular velocity of the thigh and the knee angle of the reaping leg has no significant differences between the two techniques.

## References

- Gordon, D., Robertson, E., Caldwell, E.G., Hamill, J., Kamen, G. and Whittlesey, N.S. (2004). *Research Methods in Biomechanics*. Human Kinetics, Champaign, IL.
- Harter, A. (2003). Kinetic and temporal characteristics of selected judo hip throws. *Kinesiology publications*. University of Oregon.
- Imamura, R.T. and Johnson, B.F. (2003). A kinematic analysis of a judo leg sweep: major outer leg reap - *osoto-gari*. *Sports Biomechanics*, 2, 191-201.
- Imamura, R.T., Hreljac, A., and Escamilla, R.F., and Kawada, J.J. (2007). Knee moments and joint reaction forces of the judo throw *Uchi-mata*. *Med Sci Sports Exerc*: 39 (5): S476.
- Inoue, K., Kobayashi, H., Uematsu, A. and Suzuki, Sh. (2008). Lower extremity joint torque of tai chi gait – A pilot study. In: *Proceedings of the 26 International Symposium of Biomechanics in Sports, 2008, ISBS Conference, Seoul, Korea*, pp. 306.
- Kano, J. (1994). *Kodokan Judo*. Edited under the supervision of the Kodokan Editorial Committee. Kodansha International, Tokyo - New York - London.
- Kim, Eui-hwan, Yoon, H., Kim, Sung-sup. and Chung, Chae-wook. (2005) Biomechanical traits analysis when performing of judo *Uchimata* by posture and voluntary resistance levels of uke. In: *Proceedings of the 23 International Symposium of Biomechanics in Sports, 2005, ISBS Conference, Beijing, China*.
- Otaki, T. and Draeger, D. (1996). *Judo-Formal techniques*. Tokyo Charles E. Tuttle Company.
- Pucsok, J.M., Nelson, K. and Ng, E.D. (2001). A kinetic and kinematic analysis of the *harai-goshi* judo technique. *Acta Physiologica Hungarica*, 88, 271 to 280.
- Sacripanti, A. (1989) Biomechanical Classification of judo throwing techniques. In: *Biomechanics in Sports* Eds: Tsarouches, V.L. Terauds, J., Gowitzke, B.A., and Holt, E.L. Proceedings of the Fifth International Symposium of Biomechanics in Sports, held in Athens, Greece, Athens Hellenic Sports Research Institute of Olympic Sports Center Athens. 181-194.
- Tsai, Y.J., Gu, G.H., Lee, C.J., Huang, C.F. and Tsai, C.L. (2005). The biomechanical analysis of the taekwondo front-leg axe-kick. In: *Proceedings of the 23 International Symposium of Biomechanics in Sports, 2005, ISBS Conference, Beijing, China*. pp. 437-440.

## WAYS OF IMPROVING VOLLEYBALL PLAYERS' TECHNIQUE BY MEANS OF INTEGRATING DIRPAS-NS2006 SYSTEM WITHIN THEIR TRAINING

Mirela Shaao

*University of Craiova, Romania*

### Abstract

Independent of the stage of training, especially when dealing with players going through skill consolidation stage, which precedes the excellence stage, the integration of several new methods in their technical training should firstly comply with the basic rules of technical training, and the proper process of floating specific objectives into real actions, the selection of effective ways of acting, the opportunity of applying them, the progression elements applied, the degree of correlating them to other methods or working techniques (Dragnea et al, 2002) should be constantly reported to subjects' evolution, stage by stage. This situation implies a constant knowledge of the level reached by the subjects, respectively, the real exploitation of constant evaluation functions: diagnosis, prognosis, adjustment (Colibaba-Evuleț et al, 1998). In practice, we have observed that the entire process may be facilitated if the trainer is provided with a database related to specialized software. Moreover, the DIRPAS-NS2006 system, implemented in volleyball players' training and evaluation (Shaao et al., 2007, 2008, 2009), confers the opportunity of automatically collecting and processing data resulting from testing (by means of a matrix network in infrared connected to a PC), particularly, for raising the ball to perform an attack (pass), for serve and attack receiving, techniques requiring high coefficients of accuracy and constancy. In addition, the system may be integrated in training exercises meant to improve the accuracy and constancy coefficients for the elements mentioned before. As compared to previous researches where we have approached a single segment of technical training, in an isolated manner, for the current approach, we have integrated within technical drills new means for all the three elements: raising the ball (pass), serve receiving and attack receiving, for the same group, trying to achieve a more effective exploitation of resources provided by DIRPAS-NS2006 system.

**Key words:** *computer, matrix network in infrared, evaluation, accuracy*

### Introduction

During the stage of consolidating technical elements which represents the stage marked by motor evolution of volleyball players, aged between 13 and 15 years, basic educational methods relying on the use of words (pedagogical record, intercourse, explanation, oral appreciation etc.) provide understanding, self-esteem and action self-adjustment (Cerghit, 2006), their efficiency being completed by intuitive methods (method-organized evidence of training exercises, exemplification by means of intuitive materials, selective-sensorial evidence etc.), but in order to achieve the right effect, all methods mentioned before are constantly accompanied by the active differentiated-practice method - it supports the improvement and consolidation of the specific technique by constant and active practice of the basic technique and of its components (Păcuraru, 1999), either on standardized conditions, or on certain conditions modified in order to facilitate them or to make them more difficult. Thus, the general orientation in selecting means (exercises) applied during this stage, for achieving the objectives concerning technical-tactical training, requires the fact that they should fulfill certain demands pointing out: action introduction in action structures and systems meant to facilitate continuity in practice, integration within the playing stage, specific biomechanical and motor aspects and, simultaneously, to prevent the presence of individual technique and tactic errors, as well as regulation errors (Niculescu, 2002). Therefore, regardless of the way chosen for optimizing technical training strategy, its rules must be respected.

The implementation of modern technologies within technical training of volleyball players does no longer represent an unusual aspect, trainers being constantly in search of means for improving the abilities of their sportsmen. For example, the use of ball delivering system "AirCat" (Airborne Athletics, 2010) allows, within the analytical training of a technique which depends on another one (serve receiving, attack receiving, attack, raising the ball to perform an attack, block), besides the increase of training efficiency based on the elimination of the time allotted to the secondary practiced aspect, the primary contact with the ball considering constant conditions, namely, the ball release registering "the same trajectory, the same speed, the same location" (Hebert, 2010). The quality of player's actions directly depends on the way of receiving the ball, on the primary contact service (on the individual technique of execution) and, finally, it resumes to the accuracy and constancy of performing each technique, which influence the motor task required from the teammate involved in the next action, the player's potential and that of his team. It confirms the need for recording and monitoring the evolution, accuracy and constancy coefficients specific to receiving actions (from serve and attack) and to ball raising

actions to perform an attack and for achieving the diagnosis, the prognosis, the adjustment, as well as the motivation. For this reason, considering other previous researches (Shao et al., 2008, 2009), as well as the current experimental approach, we have searched for more efficient ways meant to determine accuracy and constancy coefficients specific to all the elements mentioned before. Generally, the execution accuracy of these technical elements is achieved by means of metallic frames secured on supports or on the net (for example, for raising actions, “PrecisionPasser”). A similar approach is used, and it is achieved by delimiting a “target area” (under circumstances similar to those required during the real game), but the frame applied, vertically positioned, by means of an infrared barrier connected to an electronic calculation system, also allows automatic data collection (included in the database), simultaneously with their statistical processing, which may facilitate the trainer’s work consisting in data recording, accessing and storing, as an informational database constructive in expressing objective assessments meant to adjust working programs.

The presence of the computer, of hardware and software components, in volleyball, does no longer represent an unknown aspect, currently, being often applied in studies of movement biomechanics, in the analysis of players’ efficiency, in the achievement of prognoses and of classifications etc., but, DIRPAS-NS2006 system (figure 1) offers the opportunity for a direct integration in the activity means structure (exercises) specific to the technical-tactical training and evaluation applied for a volleyball player.

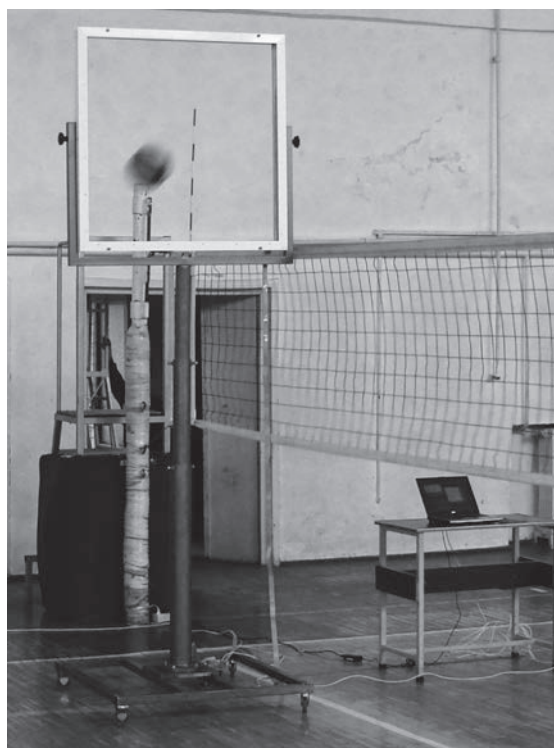

*Figure 1. The DIRPAS-NS2006 system - the mechanical support, the testing framework, the local electronic block, PC and the interface with the user*

Considering these aspects as points of reference for the present approach, our attempt of improving the accuracy and constancy coefficients of serve receiving, of raising the ball to perform an attack (pass) and of attack receiving actions, for a group of children aged between 13 and 15 years, by applying training activity means meant to provide the integration of DIRPAS-NS2006 system, becomes obvious.

## Methods

The proper research primarily based on direct observation of subjects’ behavior and evolution following their constant correlation to the training tasks, was developed during the period September 2010 – March 2011, with the participation of the feminine volleyball team of National College “Nicolae Titulescu” of Craiova, “Hopes” category (13 - 15 years).

The action systems (exercises) applied within the experimental approach provide, besides the material component specific to each technique exercise, an assembly consisting of a matrix network in infrared (IR), a local electronic block (used for the network control in IR and for data transmission) and a computer equipped with a software application enabling the network control, the communication and the interface with the user, which forms the DIRPAS-NS2006 system.

Pointedly, its role in real time, namely that allotted to the development of the exercise, consists in detecting and recording the presence of the ball within the area limited by the testing frame (1x1m) enclosing the infrared network (made of 20 transmitters in IR and 20 receivers in IR), and at the end of the session of executions (after a predetermined number of executions or till the moment of its deactivation), it determines the number of successful trails, the success rate calculation for each player and it saves the test in a database organized for each tested player. The post-processing function allows the access to this database meant to support players' selection, the generation of data of the same type and graphical representation of one player's performances or, in a comparative manner, those of several players. Therefore, the database constituted a real support in adjusting intermediate objectives and working programs, as well as in applying the statistical-mathematical method which allowed the observation and the description of the studied phenomenon and of its tendency. The mobile support fitted with a telescopic control sustaining the testing frame provides the positioning of the IR barrier within the desired area and at a given height, according to the technique employed (receiving or raising the ball to perform the attack). Exercises were applied according to the topics and the objectives established by the team's trainer, mainly, replacing the means for a subjective assessment of accuracy and the basic metallic frame.

## Results

Comparing the results to tests performed for the evaluation of serve receiving accuracy (figure 2), we may notice that between the final and the initial testing there is a progress of 36.02% for area "1", 40.69% for area "6" and of 43.53% for area "5". Applying the Student Test for the means resulting from the two testing developed for each trial, we have determined:  $t_{\text{calculated}} = 10.17 > 2.947$  ( $t_{\text{table}}$ ),  $p < 0.001$  (for area "1"),  $t_{\text{calculated}} = 10.09 > 2.947$  ( $t_{\text{table}}$ ),  $p < 0.001$  (for area "6") and  $t_{\text{calculated}} = 12.57 > 2.947$  ( $t_{\text{table}}$ ),  $p < 0.001$  (for area "5"), which indicates significant differences between the means of the two testing for this parameter, for each trial.

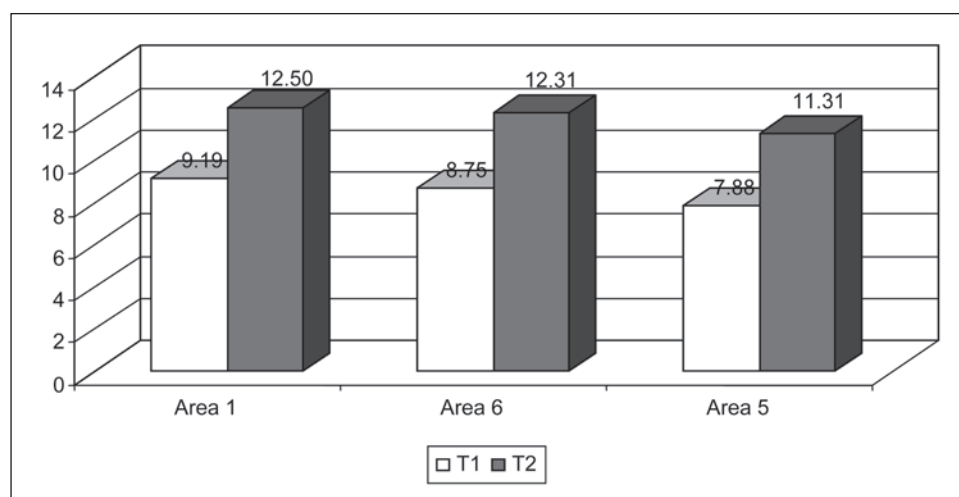

Figure 2. Progress registered by the experiment group for the serve receiving trial

When dealing with the second studied element, that of receiving from attack (figure 3), there is a progress between the two testing of 30.27% for receiving from area "1", of 36.89% when receiving from area "6" and of 41.40% for receiving from area "5". Applying the Student Test for the means determined by the two testing, it results:  $t_{\text{calculated}} = 7.72 > 2.947$  ( $t_{\text{table}}$ ),  $p < 0.001$ , (for the attack receiving action from area "1"),  $t_{\text{calculated}} = 7.51 > 2.947$  ( $t_{\text{table}}$ ),  $p < 0.001$ , (for the attack receiving action from area "6") and  $t_{\text{calculated}} = 13.06 > 2.921$  ( $t_{\text{table}}$ ),  $p < 0.001$ , (for the attack receiving action from area "5"), which indicates significant differences between the means of the two testing for this parameter, for each trial.

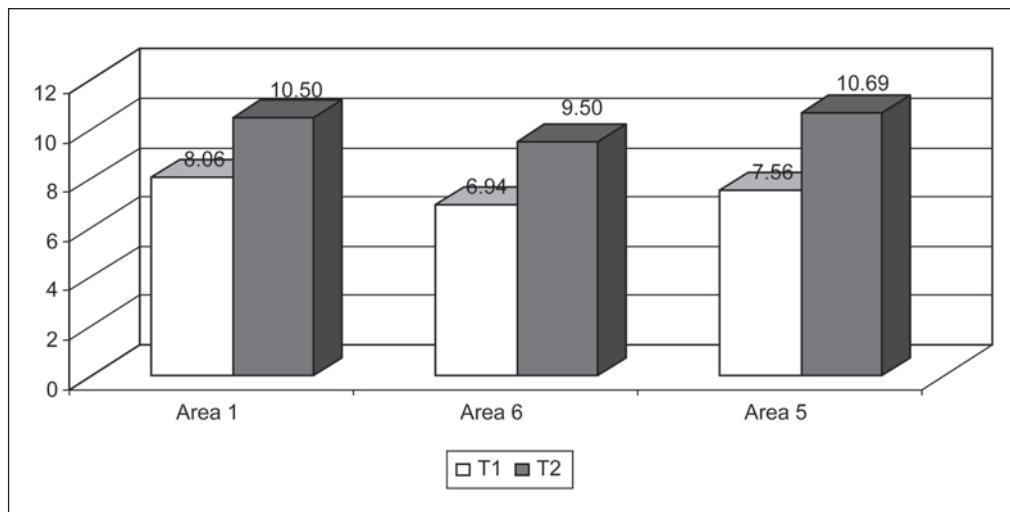

Figure 3. Progress registered by the experiment group for the attack receiving trial

The progress recorded for raising the ball to perform an attack (figure 4) was of 47.22% (from area “2”), of 56.25% (from area “3”), and of 42.86% (from area “4”).

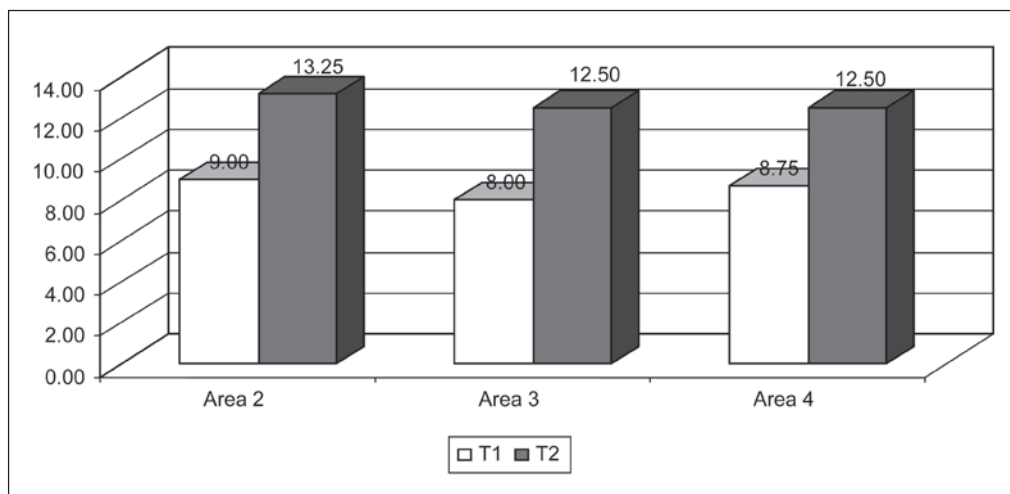

Figure 4. Progress registered by the subjects for raising the ball to perform an attack

## Discussions and conclusions

As a conclusion, the progress recorded by the experiment group confirms the fact that the working method applied for improving the accuracy and constancy coefficients specific to the main elements for the volleyball play which requires these characteristics, proves to be efficient and may be successfully employed during the training process. In addition, the use of the electronic computer connected to the IR barrier of the DIRPAS-NS2006 system enables the determination of the pass (ball raising), serve and attack receiving (under circumstances disposed by the user) accuracy and the assessment of its constancy considering the results achieved by each subject to specific control tests (stored in the database), as well as the player's evolution during different stages. Generally, the training materials, which allow the precise assessment of the player's evolution during different training stages, or even, during the same drill stage, facilitate the right control over the individual training. Apart from its use during the individualized technical-tactical training, the DIRPAS-NS2006 system opens the perspective of a new direction of optimizing the normative evaluation, due to the fact that the system allows the collection and the comparison of data (performances) resulting from the same testing applied on an unlimited number of players.

## References

1. Cerghit, I., 2006. *Education Methods*. Bucharest: Polirom Publishing House.
2. Colibaba-Evuleț, D., Bota, I., 1998. *Sports Games. Theory and Methods*. Bucharest: Aldin Publishing House.
3. Dragnea, A., Mate-Teodorescu, S., 2002. *Sports Theory*. Bucharest: FEST Publishing House.
4. Frohner, B., 1995. Today Video and Computer-Assisted Technology Applied for Systematic Research of Technical-Tactical Actions in Volleyball from Individual and Team Point of View. SDP 378-379/1996, *Multimedia Systematic Analysis of Technical-Tactical Characteristics of Sports Games*. Bucharest: MTS, CCPS.
5. Kus, S. 2004. *Coaching volleyball successfully*. Champaign: Human Kinetics.
6. Niculescu, M., 2002. *Volleyball: from Theory to Practice*, Pitești: University of Pitești Publishing House.
7. Păcuraru, A., 1999. *Volleyball. Technique and Tactics*. Galați: “Dunărea de Jos” Publishing House.
8. Shao, M., Niculescu, M., 2008. Strategies to Improve Precision and Constancy in Receiving Serves by Means of DIRPAS-NS2006 System, ICPEHS 2008 Proceedings International Conference: *Physical Education, Sport and Health* 21-23 November 2008. University of Pitești.
9. Shao, M., Niculescu, M., Ilinca, I., 2009. Enforcement of New Technology in Volleyball – Orientation for the Improvement of Selection and Training. Journal: *Citius Altius Fortius*, 22, 3 March, University of Pitești.
10. Shondell, D, Reynaud, C., 2002. *The volleyball coaching*. Champaign: Human Kinetics.
11. <<http://airborneathletics.com/volleyball-news.php?two>> [Accessed 10 January 2011].
12. <<http://www.precisionpasser.com>> [Accessed 8 June 2010].

## POSTURAL CONTROL OF ADVANCED YOGA PRACTITIONERS

**Kajetan Slomka**

*Academy of Physical Education in Katowice, Poland*

### **Purpose**

Yoga exercises are claimed to have positive effect on balance, posture, flexibility and life quality. The aim of this study was to investigate advanced yoga practitioners and the effect of their training on postural control. We hypothesized that long and intensive yoga training should significantly influence balance characteristics.

### **Methods**

Thirteen yoga practitioners (age  $35.3 \pm 11.8$  years) and control group consisting of 10 healthy adults (mean age  $22 \pm 5.8$  years) with no yoga experience, took part in the experiment. They had no documented history of postural or skeletal disorders. The average experience of yoga practitioners was six years of training at least 3 times a week for 1.5 hour. Subjects balance was measured while quietly standing on a force platform. Additionally, on yoga experts, we conducted measurement in two different positions: “mountain” asana and “power” asana. Centre of foot pressure (COP) displacement were calculated as average from five 30 seconds trials. Apart from standard measures of standing balance derived from COP data, we conducted rambling-trembling decomposition of the stabilogram (Zatsiorsky and Duarte 1999, 2000).

### **Results**

Our results indicate that yoga training significantly influence most of the analyzed characteristics of balance in quiet standing ( $p < 0.05$ ). Interestingly the control group did not differ from yoga experts in length and velocity of rambling and trembling in ML and in AP only in velocity of rambling and length and velocity of trembling. Additionally most of the yoga experts performed worse in asana positions.

### **Conclusions**

The data analysis distinguished significantly the level of difficulty of each position and can be used for such assessments in the future. Additionally it can be concluded that higher balance performance demands depend on the assumed position.



## UNILATERAL BALLISTIC ANKLE STRENGTH TRAINING IMPROVES CONTRALLATERAL MAXIMAL STRENGTH AND BALANCE\*

Tatjana Trošt Bobić

*Faculty of Kinesiology, University of Zagreb, Croatia*

### Abstract

The aim of this study was to investigate the effect of unilateral ballistic ankle strength training on maximal strength and one-legged standing balance of the contralateral untrained lower limb. Twenty-four healthy Physical education students (mean  $\pm$  SD age 23.1  $\pm$  1.7 years), with no history of neurological diseases or major orthopaedic lesions were included in the study. The subjects were randomly assigned to a training (TRN, n=13) or control (CTL, n=11) group. All participants underwent testing of plantar and dorsal foot flexors torque as well as one-legged static balance testing, a week before, and a week after five weeks of unilateral ballistic ankle strength training. The differences between the initial and final testing in the measured variables for the TRN and CTL group separately, was calculated by means of a paired sample t-test. Significance was set at the .05 level. Ballistic ankle strength training improved plantar flexors strength and single leg balance stance of both, the trained (T) and the untrained (NT) leg of the TRN group. There was no significant enhancement in any of the evaluated parameters for the CTL group. Such results show that ballistic training is likely to cause adaptations to many neural elements that are involved in the control of movement, and therefore likely to affect movement execution during a single leg balance task.

**Key words:** *unilateral training, ballistic training, ankle joint, maximal voluntary contraction, one-legged standing balance*

### Introduction

It is well known that unilateral strength training enhances strength performance in the contralateral limb (Lee and Carroll, 2007; Munn et al., 2004). This “cross-education” (Fimland et al., 2009), “cross-transfer” (Munn et al., 2005) or “contralateral effect” (Evetovich et al., 2001) has been extensively documented in previous studies using isometric (Kannus et al., 1992), concentric (Weir et al., 1997) and eccentric (Hortobagay, Lambert & Hill, 1997) contractions of different velocities (Farthing & Chilibeck, 2003) on upper (Hubal et al., 2005) and lower (Evetovich et al., 2001) extremity muscles. Unilateral surface electrical stimulation has also been proved to induce contralateral strength enhancement (Bezerra et al., 2009; Toca-Herrera et al., 2008; Cabric & Appell, 1987). Strength crosseducation is not accompanied by muscle hypertrophy, and the contralateral strength gain seems to drastically remain behind ipsilateral strength gain after ten weeks of training, that is when hypertrophy occurs in the trained limb (Houston et al., 1983). This suggests that there are neural rather than morphological adaptations underlying this phenomenon. Neural mechanisms of crosseducation have been proposed both for spinal and cortical level (Zhou, 2000; Lee & Carroll, 2007). On those basis unilateral movements has been studied to better understand the mechanisms of neural adaptations to strength training in general (Howard & Enoka, 1991). Most investigations have focused on studying the contralateral strength gain as a result of ipsilateral strength training (Lee & Carroll, 2007), or contralateral motor learning effects after an ipsilateral motor learning process (Latash, 1999). The phenomenon of crosseducation has therefore been studied as a specific contralateral response to a specific ipsilateral intervention (i.e. strength gain after strength training, and skill enhancement after motor learning). In order to better understand the underlying mechanisms of cross-education there is a need to extend its investigation to other human performances. This new approach may help to better understand the mechanisms of neural adaptations to different types of strength training. Kim, Cha and Fell (2011), recently investigated the effects of unilateral concentric isokinetic training on one-legged standing balance of the contralateral lower extremity. They used four training exercises: flexion, extension, abduction and adduction of the hip. After eight training sessions (two weeks/4 training per week), they registered significant contralateral improvements in anterior-posterior, medio-lateral and overall stability indexes ( $p < 0.05$ ), measured by means of a one-legged balance standing test. They concluded that unilateral concentric isokinetic training of the hip muscles increases the one-legged standing balance of the contralateral limb even after a short training duration. Contralateral effects of unilateral strength training of the muscle surrounding the ankle joint on one-legged

\* This research was supported, in part, by grant no. 034-0342610-2609 (Programming of transformational procedures for physical conditioning) from Croatian Ministry of science, education and sport.

standing balance has not been studied yet. Furthermore, ballistic strength training of plantar and dorsal foot flexors has been demonstrated to enhance balance performances in older adults (Raymond & Singh, 2008). On that basis it has been hypothesized that unilateral ballistic strength training may produce contralateral effects on one-legged standing balance. The main purpose of this study was to investigate the effect of unilateral ballistic ankle strength training on maximal strength and one-legged standing balance of the contralateral untrained lower limb.

## Methods

### Participants

Twenty-four healthy Physical education students (mean  $\pm$  SD age 23.1  $\pm$ 1.7 years), with no history of neurological diseases or major orthopaedic lesions were included in the study. The subjects were randomly assigned to a training (TRN, n=13) or control (CTL, n=11) group. The demographics of the participants are presented in table 1. After explaining the purpose and potential risks of the study, a written informed consent was obtained. The subjects were asked to refrain from vigorous physical activity other than the ballistic strength training used in the investigation for the duration of the study. The study was approved by the Ethical Committee of the School of Kinesiology, University of Zagreb.

Table 1. Mean (SD) age, body mass, body high and body mass index (BMI) of the subjects of the TRN and CTL groups.

Group	Age (years)	Body mass (kg)	Body height (cm)	BMI (kg/m <sup>2</sup> )
TRN group - men (n=3)	23,3 (1,2)	76,0 (7,2)	180,3 (6,5)	23,0 (0,8)
TRN group - women (n=10)	23,0 (1,9)	64,3 (9,3)	169,7 (5,0)	22,0 (2,6)
TRN group - total (n=13)	23,1 (1,8)	67,0 (10,0)	172,2 (6,9)	22,0 (2,4)
CTL group - men (n=4)	22,5 (1,3)	81,5 (11,5)	180 (6,7)	25,0 (2,3)
CTL group - women (n=7)	22,8 (0,8)	58,8 (5,7)	167,3 (6,6)	21,0 (1,8)
CTL group - total (n=11)	22,7 (0,9)	67,9 (14,1)	172,4 (9)	23,0 (2,8)

### Instrumentation

A custom made dynamometer (S2P Ltd., Bled, Slovenia) was used to measure plantar and dorsal foot flexors torque. The dynamometer consisted of an adjustable chair on which a subject was seated with upright trunk position and hips, knees and ankles at 90°. The feet were fixed on the measuring pedal. A load cell (HBM Inc., Z6C3, Darmstadt, Germany) was placed at the bottom of the pedal allowing the measurement of the plantar and dorsal foot flexors torque. To limit any unwanted proximal movement during testing, the knee was secured by a mechanical rigid brake, while the foot was tightly strapped. Participants were asked to perform a maximal isometric voluntary plantar and dorsal flexion of the foot (MVC) stressing explosive force production. A force plate (AMTI, Watertown, USA) was used for static balance assessment tested by the centre-of-pressure (COP) parameters.

### Testing procedure

All participants underwent testing of plantar and dorsal foot flexors torque as well as static balance testing, a week before, and after the five weeks training period. After a standardized 10 min warm-up (6 min running exercises, static stretching and callisthenics) participants performed a single limb stance (SLS) test. Participants were asked to stand barefoot on a force plate with arms placed on their hips. A visual target was placed on the wall on the 2 m distance at the eye level. Participants were instructed to lift one foot at the level of 45° knee flexion while looking at the target. The acquisition started after a subject reached the desired position. The task lasted for 60 s. Participants performed the test three times, alternately with one, than with the other leg, with a pause of 60 s between trials. The first leg was determined randomly. Participants were not allowed to lower the free foot, hook the free leg behind the supporting leg, remove arms from hips or look away from the visual target. If anything of this took place, the trial was interrupted. Prior to the measurement two introductory trials (20 s with each foot) were carried out to familiarise with the task. After a five minutes rest participants performed three *explosive maximal isometric voluntary contractions* (MVC) with each foot. They were asked to perform a maximal plantar flexion “as explosive and strongly as possible”, followed by an equally made dorsal flexion of the foot. Each MVC lasted 3 s with a pause of 3 s between the two tasks. The same trial was repeated three times with a rest interval of 60 s in between. As suggested by Gandevia (2001), verbal encouragement was given during strength testing. Prior to the measurement two introductory trials were carried out to familiarise with the task. The parameters used to assess maximal strength and static balance are presented in Table 2.

## Signal processing

The force signal from the load cell was amplified at 4000 Hz, analogue-to-digital converted (NI-USB 6212 and SCC68, National Instruments, Austin, Texas, USA) and raw signals stored on a PC using custom made software (LabView 2010, National Instruments, Austin, Texas, USA).

The sway of the COP during the SLS test was acquired (sampling frequency 1000 Hz) using a force plate (AMTI, Watertown, USA) and signals were stored on a personal computer for further analysis. The COP curve was quantified with custom-written software (Lab-View, 8.1; NI, Texas, USA). The parameters of velocity, amplitude and frequency, presented in table 2 were calculated after removing potential noise from the signal (2nd order Butterworth, 0.1-20 Hz band-pass filter).

Table 2. Parameters used for maximal strength and one-legged standing static balance evaluation

Abbreviation	Unit	Description
$F_{MVC}$	Nm	Maximal average force on 1 s interval during MVC.
${}_B V_{ML}, {}_B V_{AP}$	mm/s	Average velocity of the COP in the medio-lateral and anterior-posterior direction respectively – the direction specific distances divided by 60 s.
${}_B A_{ML}, {}_B A_{AP}$	mm	The COP average amplitude of oscillations covered in the medio-lateral and anterior-posterior direction respectively – the mean direction specific amplitude of oscillation.
${}_B FRN_{ML}, {}_B FRN_{AP}$	Hz	Average frequency of oscillation in medio-lateral and anterior-posterior directions calculated from the number of changes in directions (piks) in the medio-lateral and anterior-posterior direction respectively (the mean frequency of the power spectrum using Henning window).

## Data analyses

Descriptive statistics were calculated for all variables in two sessions (Pre- and Post- training). Since strength testing included three trials of each task (unilaterally performed plantar and dorsal foot flexion), their average values were used for further analyses. On the other hand, the best of the three performed trials of SLS test was taken in consideration for further analysis. The differences between the initial and final testing in the measured variables for the TRN and CTL group separately, was calculated by means of a paired sample t-test. Significance was set at the .05 level.

## Training intervention

TRN group subjects performed 20 sessions (five weeks / 4 times weekly) of unilateral plantar and dorsal maximal ballistic strength training of the non-preferred leg on the same apparatus as used for the testing sessions. The limb preference was denoted by the subjects' preference in kicking a ball (Beynon et al., 2000). During training subjects were encouraged to alternatively perform maximal plantar and dorsal foot flexion "as explosive and strongly as possible". The warm up of each training session was the same used during the testing. The training load progression is presented in table 3.

Table 3. Training load progression and figure of the training situation

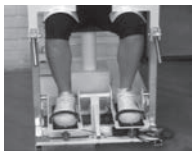
Week	Task	N. of contractions	Duration of the contraction	N. of sets
Week 1		5	3 sec	3
Week 2		6	3 sec	3
Week 3		5	3 sec	4
Week 4		6	3 sec	4
Week 5		6	3 sec	5

## Results

Paired sample t-test demonstrated significant differences between pre- and post- training measurements of maximal average plantar foot flexor's strength and the screened balance (body sway) parameters in the TRN group, but not in the CTL group. Differences between means from pre- to post- training measurements of plantar and dorsal foot flexors MVC are shown in table 4. Ballistic ankle strength training improved plantar flexors strength of the trained (T) and the untrained (NT) leg, while there was no strength improvement for the dorsal foot flexors.

Table 4. Mean±SD for MVC during plantar and dorsal foot flexion of the trained and untrained leg, with paired t-test results.

CTL group				
	$F_{MVC\_PF\_T}$	$F_{MVC\_DF\_T}$	$F_{MVC\_PF\_NT}$	$F_{MVC\_DF\_NT}$
Pre-test	200,85±62,71	39,95±9,08	178,82±44,37	37,83±10,60
Post-test	196,40±80,09	37,98±14,15	185,03±66,55	38,11±9,32
t-test pre-post	0,33	0,25	0,30	0,45
TRN group				
	$F_{MVC\_PF\_T}$	$F_{MVC\_DF\_T}$	$F_{MVC\_PF\_NT}$	$F_{MVC\_DF\_NT}$
Pre-test	160,26±60,72	32,74±8,74	165,09±44,94	36,24±8,43
Post-test	194,48±47,34	35,10±9,61	182,05±42,04	36,42±11,69
t-test pre-post	<b>0,0001</b>	0,08	<b>0,02</b>	0,46

PF: plantar foot flexion; DF: dorsal foot flexion; T: trained leg; NT: untrained leg; F: force

The implemented ballistic ankle strength training improved single leg balance stance of both, T and NT leg, measured by means of *velocity* and *amplitude* parameters. For what concerns *frequency* parameters, the only significant pre- to post- training improvement was found for the average frequency of oscillation in anterior-posterior directions of the NT leg in the TRN group (Table 5).

Table 5. Mean±DS for the derived static balance parameters of the T and NT leg, with paired t-test results

CTL group (T)						
	$B_{V_{ML\_T}}$	$B_{V_{AP\_T}}$	$B_{A_{ML\_T}}$	$B_{A_{AP\_T}}$	$B_{FRN_{ML\_T}}$	$B_{FRN_{AP\_T}}$
Pre-test	0,02909±0,00525	0,02739±0,00533	0,00339±0,00104	0,00302±0,00093	0,82382±0,14930	0,62415±0,12160
Post-test	0,02895±0,00441	0,02849±0,00478	0,00315±0,00061	0,00305±0,00072	0,82264±0,17299	0,55985±0,06419
t-test pre-post	0,45	0,12	0,13	0,43	0,49	0,06
TRN group (T)						
	$B_{V_{ML\_T}}$	$B_{V_{AP\_T}}$	$B_{A_{ML\_T}}$	$B_{A_{AP\_T}}$	$B_{FRN_{ML\_T}}$	$B_{FRN_{AP\_T}}$
Pre-test	0,02779±0,00293	0,02664±0,00334	0,00298±0,00066	0,00289±0,00086	0,71468±0,12800	0,62048±0,10112
Post-test	0,02643±0,00415	0,02527±0,00364	0,00278±0,00076	0,00264±0,00076	0,69800±0,19955	0,59862±0,10873
t-test pre-post	<b>0,01</b>	<b>0,01</b>	<b>0,02</b>	<b>0,003</b>	0,34	0,08
CTL group (NT)						
	$B_{V_{ML\_NT}}$	$B_{V_{AP\_NT}}$	$B_{A_{ML\_NT}}$	$B_{A_{AP\_NT}}$	$B_{FRN_{ML\_NT}}$	$B_{FRN_{AP\_NT}}$
Pre-test	0,02828±0,00404	0,02736±0,00491	0,00321±0,00070	0,00302±0,00079	0,93397±0,14629	0,63909±0,14393
Post-test	0,02832±0,00422	0,02773±0,00423	0,00307±0,00063	0,00292±0,00053	0,97655±0,14594	0,57218±0,07775
t-test pre-post	0,49	0,36	0,25	0,30	0,16	0,07
TRN group (NT)						
	$B_{V_{ML\_NT}}$	$B_{V_{AP\_NT}}$	$B_{A_{ML\_NT}}$	$B_{A_{AP\_NT}}$	$B_{FRN_{ML\_NT}}$	$B_{FRN_{AP\_NT}}$
Pre-test	0,02663±0,00260	0,02587±0,00191	0,00281±0,00054	0,00271±0,00055	0,81917±0,19638	0,62540±0,10911
Post-test	0,02520±0,00359	0,02481±0,00291	0,00262±0,00062	0,00251±0,00057	0,84943±0,15522	0,57993±0,10866
t-test pre-post	<b>0,02</b>	<b>0,03</b>	<b>0,02</b>	<b>0,03</b>	0,40	<b>0,03</b>

V: velocity; A: amplitude; FRN: frequency; ML: medio-lateral; AP: anterior-posterior; T: trained leg; NT: untrained leg; B: balance

## Discussion and conclusions

Unilateral ballistic ankle strength training improved ipsilateral and contralateral maximal strength and one legged balance stance. However, only *plantar flexors MVC* improved while dorsal flexors MVC remained unchanged in both, the T and NT leg. There is a possibility that changes in MVC for dorsal foot flexors have not been detected due to measurement and methodological specificities. Dorsal flexors' MVC is rarely studied. One may guess that the reason lies in the task specificity and its low reliability. In this study, the intraclass correlation coefficient (ICC) for dorsal foot flexors MVC was 0,676 with confidence intervals (CI, 95%) ranging from 0,207 to 0,890, indicating low inter-session repeatability. The same values for plantar flexors MVC were 0,903 (ICC) and 0,712-0,969 (CI, 95%). The obtained ipsilateral and contralateral

strength gain for T and NT foot flexors is in line with previous studies, and confirms the well known phenomenon of strength crosseducation in lower limbs (Munn et al., 2004). Several muscular, neural, spinal cord, cortical and sub cortical mechanisms may be responsible for that with the spinal and cortical ones being the most cited (Caroll et al., 2006). One possible cortical mechanism is the existence of interhemispheric connections via the corpus callosum between most cortical motor areas, as well as bilateral and ipsilateral corticospinal projections to many proximal muscles (Carson, 2005) indicating a wide range of possible sites of cross-limb cortical interaction that could contribute to the contralateral strength training effect (Caroll et al., 2006). A possible spinal mechanism may be the existence of interneurons that receives afferent and descending inputs and crosses the midline to excite or inhibit contralateral motoneurons (commissural interneurons) (Jankowska, Krutki & Matsuyama, 2005), but this needs to be further investigated.

On the other hand the ipsilateral and contralateral improvement in *balance performance* found after ballistic ankle strength training represent a relatively new knowledge. Previous data about balance performance improvement as a consequence of strength training has been contradictory (Raymond & Singh, 2008). One possible reason for contradictory result is the wide range of different types of training used in previous investigations (i.e. isometric strength training, eccentric isokinetic training or ballistic strength training) (Orr et al. 2008; Raymond & Singh, 2008). Ballistic actions are present in everyday tasks and they cause numerous specific neuromuscular adaptations that may be linked with postural sway (Caroll, Riek & Carson, 2001). For example, antagonist co-contraction increase with movement speed and this seems to be a function of movement strategy. In line with that, increase in joint angular velocity, as in ballistic movements, causes a marked increase in the electromyographic (EMG) activity of antagonist muscles acting at the joint (Zehr and Sale, 1994). The functional significance of this observed antagonist co activation during ballistic movements may be to prevent injury and maintain joint integrity, thus balance. Those may be the reasons why the implemented ballistic ankle strength training improved single leg balance performance of the T and NT leg, determined by COP average velocity and amplitude of oscillations in the medio-lateral and anterior-posterior directions.

In conclusion, even though training adaptation have previously been proved to be task specific, this investigation also shows the possibility to enhance a human performance by different movements and training regimen. The found ipsilateral and contralateral balance enhancement after ballistic strength training is probably due to the similarity of the neurophysiologic mechanisms that sub serve ballistic movement and balance performance. Such results shows that ballistic training is likely to cause adaptations to many neural elements that are involved in the control of movement, and therefore likely to affect movement execution during a single leg balance task. Although further investigations are needed to better explain the influence of ballistic training on balance performance, the results of this investigation may assist clinicians and trainers in developing exercise programs aimed to improve balance ability and muscle strength.

## References

1. Beynon, B.D., Helie, B.V., Alosa, D.M., Renstrom, P.A. (2000). The benefit of a single-leg strength training program for the muscles around the untrained ankle. *American Journal of Sports Medicine*, 28(4), 568-573.
2. Bezerra, P., Zhou, S., Crowley, Z., Brooks, L., Hooper, A. (2009). Effects of unilateral electromyostimulation superimposed on voluntary training on strength and cross-sectional area. *Muscle Nerve*, 40, 430-437.
3. Cabric, M., Appel, H.J. (1987). Effect of electrical stimulation on high and low frequency on maximal isometric force and some morphological characteristics in man. *International Journal of Sports Medicine*, 8, 256-260.
4. Caroll, T.J., Riek, S. & Carson, R.G. (2001). Neural adaptations to resistance training. Implications for movement control. *Sports Medicine*, 31(12), 829-840.
5. Carson, R.G. (2005). Neural pathways mediating bilateral interactions between the upper limbs. *Brain Research Review*, 49, 641-662.
6. Evetovich, T.K., Housh, T.J., Housh, D.J., Johnson, G.O., Smith, D.B., Ebersole, K.T. (2001). The effect of concentric isokinetic strength training of the quadriceps femoris on electromyography and muscle strength in the trained and untrained limb. *Journal of Strength and Conditioning Research*, 15(4), 439-445.
7. Farthing, J.P. & Chilibeck, P.D. (2003). The effect of eccentric training at different velocities on cross-education. *European Journal of Applied Physiology*, 89, 570-577.
8. Fimland, M.S., Helgerud, J., Solstad, G.M., Iversen, V.M., Leivseth, G., Hoff, J. (2009). Neural adaptations underlying cross-education after unilateral strength training. *European Journal of Applied Physiology*, 107, 723-730.
9. Gandevia, S.C. (2001). Spinal and supraspinal factors in human muscle fatigue. *Physiological Reviews*, 81(4), 1725-1789.
10. Hortobágyi, T., Lambert, N.J., Hill, J.P. (1997). Greater cross education following training with muscle lengthening than shortening. *Medicine & Science in Sports & Exercise*, 29(1), 107-112.
11. Houston, M.E., Froese, E.A., Valeriote, S.P., Green, H.J., Ranney, D.A. (1983). Muscle performance, morphology and metabolic capacity during strength training and detraining: a one leg model. *European Journal of Applied Physiology*, 51, 25-35.
12. Howard, J.D. & Enoka, R.M. (1991). Maximum bilateral contractions are modified by neurally mediated interlimb effects. *Journal of Applied Physiology*, 70(1), 306-316.
13. Hubal, J.M., Gordish-Dressman, H., Thompson, P.D., Price, T.B., Hoffman, E.P., Angelopoulos, T.J., Gordon, P.M., Moyna, N.M., Pescatello, L.S., Visich, P.S., Zoeller, R.F., Seip, R.L. & Clarkson, P.M. (2005). Variability in muscle size and strength gain after unilateral resistance training. *Medicine and Science in Sports and Exercise*, 37(6), 964-972.

14. Jankowska, E., Krutki, P. & Matsuyama, K. (2005). Relative contribution of Ia inhibitory interneurons to inhibition of feline contralateral motoneurons evoked via commissural interneurons. *The Journal of Physiology*, 568, 617-628.
15. Kannus, P., Alosa, D., Cook, L., Johnson, R.J., Renstrom, P., Pope, M., Beynnon, B., Yasuda, K., Nichols, C., Kaplan, M. (1992). Effect of one-legged exercise on the strength, power and endurance of the contralateral leg. A randomized controlled study using isometric and concentric isokinetic training. *European Journal of Applied Physiology*, 64,117-126.
16. Kim, K., Cha, Y.J., Fell, D.W. (2011). The effect of contralateral training: influence of unilateral isokinetic exercise on one-legged standing balance of the contralateral lower extremity in adults. *Gait & Posture*, 34, 103-106.
17. Latash, M.L. (1999). Mirror writing: learning, transfer, and implications for internal inverse models. *Journal of Motor Behaviour*, 31, 107-111.
18. Lee, M. i Carroll, T.J. (2007). Cross education. Possible mechanisms for the contralateral effects of unilateral resistance training. *Sports medicine*, 37(1), 1-14.
19. Munn, J., Herbert, R.D., Gandevia, S.C. (2004). Contralateral effects of unilateral resistance training: a meta-analysis. *Journal of Applied Physiology*, 96, 1861-1866.
20. Munn, J., Herbert, R.D., Hancock, M.J., Gandevia, S.C. (2005). Training with unilateral resistance exercise increases contralateral strength. *Journal of Applied Physiology*, 99, 1880-1884
21. Raymond, O.R. & Singh, F.M. (2008). Efficacy of progressive resistance training on balance performance in older adults: a systematic review of randomized controlled trials. *Sports Medicine*, 38(4), 317-343.
22. Toca-Herrera, J.L., Gallach, J.E., Gómis, M., González, L.M. (2008). Cross-education after one session of unilateral surface electrical stimulation of the rectus femoris. *Journal of Strength and Conditioning Research*, 22, 614-618.
23. Weir, J.P., Housh, D.J., Housh, T.J., Weir, L.L. (1997). The effect of unilateral concentric weight training and detraining on joint angle specificity, cross-training, and the bilateral deficit. *J Orthop Sports Phys Ther*, 25:264-270.
24. Zhou, S. (2000). Chronic neural adaptations to unilateral exercise: mechanisms of cross education. *Exercise and Sport Sciences Reviews*, 28(4), 177-184.

## VALIDITY OF MEASURING MUSCLE ACTIVATION LEVEL WITH HYDRAULIC SYSTEMS

Romina Umer<sup>1</sup>, Mitja Gerževič<sup>2</sup> and Vojko Strojnik<sup>1</sup>

<sup>1</sup>University of Ljubljana, Faculty of Sport, Ljubljana, Slovenia

<sup>2</sup>University od Primorska, Science and Research Centre of Koper, Institute of Kinesiology Research, Koper, Slovenia

### Abstract

Hydraulic system to measure muscle activation level (AL) by comparing the maximum torques during isometric (ISO) and eccentric (ECC) contraction (AL\_H) was compared with the AL obtained with double interpolated twitch method (AL\_TW). Twenty-two male subjects participated in the study. They performed two sets of maximal voluntary ISO leg extensions (knee 55°, hip 110°) immediately followed by an ECC contraction imposed by the hydraulic system. After that the AL with the interpolated twitch method was measured. AL\_TW was significantly higher than AL\_H ( $P < 0.001$ ). The intraclass correlation coefficient showed excellent repeatability and consistency (ICC 0.98, 0.96 and 0.86) of hydraulic measurements (T\_ISO, T\_ECC and AL\_H, respectively), yet the Spearman correlation coefficients were not significant neither between AL\_TW and all AL\_H. Analysed hydraulic system seemed not suitable for AL measurements.

**Key words:** strength deficit, hydraulic device, repeatability, ICC

### Introduction

The difference between maximum isometric (ISO) and maximum eccentric (ECC) force is used to establish the so-called strength deficit (Buehrle & Schmidtbleicher, 1981). The latter shows to what extent the subject is capable of activating a muscle during a maximum voluntary muscle contraction. Another method for measuring the ability of voluntary muscle activation is the interpolated twitch method (Merton, 1954) or to use two consecutive electrical impulses (Suter & Herzog, 2001). When comparing maximum ISO and ECC forces the difference includes the type of muscle contraction. An increase in force during an ECC contraction is linked to an increase in muscle activation due to stretch reflex. However, other mechanisms as short range muscle stiffness, muscle viscosity and a change in the force-length and/or torque-joint angle relationship (Rack & Westbury, 1974; Westing et al., 1990) are involved as well. With the interpolated twitch method force increases due to additional muscle activation by electrical stimulation and does not involve any substantial changes in muscle mechanics. For this reason the method is applied as a standard for measuring muscle activation (Behm et al., 1996).

In the present study we tested validity and repeatability of AL measurements using a hydraulic system to induce eccentric contraction that could be applied to standard strength training machines. In comparison to interpolated twitch technique, such measurements are rather easy to perform applicable for numerous muscles groups.

### Methods

#### Subjects

Twenty-two male subjects with different levels of training participated in the study ( $28.5 \pm 11.8$  years). All of them volunteered for participating and signed a consent form agreeing to take part in it. The study was conducted in compliance with the Helsinki-Tokyo Declaration.

#### Measurement procedure

The measurement of AL by comparing ISO and ECC maximum torques was conducted using a custom-made hydraulic system adapted for Technogym leg extension machine (TECHNOGYM Spa, Gambettola, Italy; Figure 1a). After the standardized warming up protocol, the subjects sat into the leg extension machine (knee angle 55°, hip angle 110°, fixed hips). As part of the warm-up protocol, they performed also three sub-maximal ISO contractions (lasted 5 s, intensities 50%, 75% and 90% MVC). Two measurements, each consisted of a maximum ISO contraction (TMAX\_ISO) (2 s force development) and was immediately followed by ECC maximum contraction (TMAX\_ECC) (down to 70°) once subjects obtained stable MVC ISO level. The hydraulic system pushed the limb downwards with constant angular velocity  $55.8^\circ/s \pm$

5.3%/s. The activation level (AL\_H) was calculated post-hoc according to the Equation 1, using the concept of “Kraftdefizit” (Buehrle & Schmidtbleicher, 1981):

$$AL\_H(\%) = \frac{TMAX\_ISO}{TMAX\_ECC} \cdot 100 \quad \text{Equation 1}$$

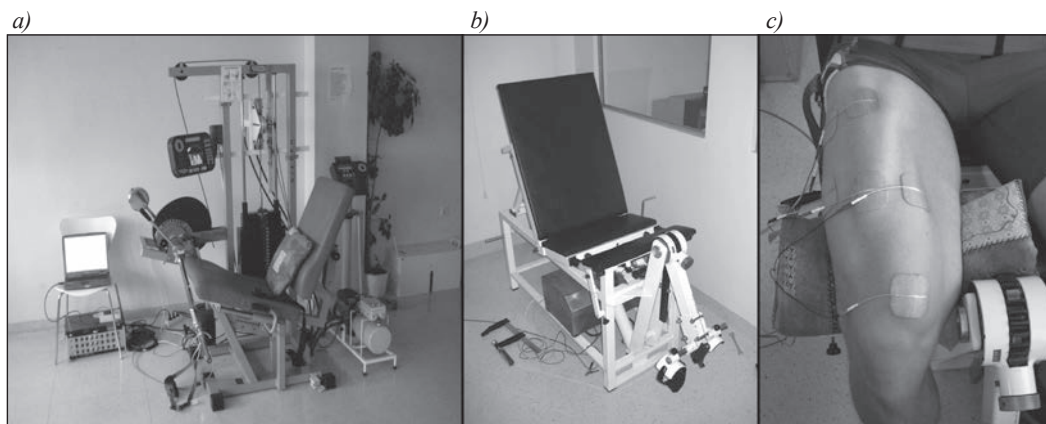

Figure 1. a) Knee extension machine and hydraulic system, b) isometric knee extension measuring device system; c) placement of electrodes.

The measurement of the AL using the double interpolated twitch followed 10-min after the measurements with hydraulic system. The subjects were seated in an isometric knee extension measurement device (knee angle 60°, hip angle 110°, fixed hips) (Figure 1b). A constant-current electrical stimulator (EMF Furlan and Co., Ljubljana, Slovenia) was used for direct stimulation of the quadriceps femoris muscle (Figure 1c). A double supramaximal electrical impulse (rectangular bi-phased impulse, duration 0.3 ms, interval 10 ms) was used. The subjects' task was to gradually generate the maximum ISO torque (2 s) and maintain it at this level for 3 s. During the stable part of MVC the electrical impulse was applied. Immediately after the end of MVC, the subjects were instructed to relax as much as possible so that the maximal twitch of the relaxed muscle was measured. The maximum twitch torque during maximum ISO contraction (TW\_ISO) and during the rest (TW\_REST) was obtained. The activation level (AL\_TW) was calculated post-hoc using Equation 2 (Merton, 1954):

$$AL\_TW(\%) = \left( 1 - \frac{TW\_ISO}{TW\_REST} \right) \cdot 100 \quad \text{Equation 2}$$

## Data analysis

The data were processed by the SPSS statistical package for Windows 13.0 (SPSS Inc., Chicago, USA). The statistical methods were used as follows: (a) calculation of basic statistical parameters for all variables, (b) Shapiro-Wilk's test for testing the normality of the distribution of all variables, (c) Paired samples t-test to compare the differences of the two sets (for not normally distributed parameters Friedman's and Wilcoxon's non-parametric tests were used), (d) Intraclass correlation coefficient (ICC) to test the repeatability and consistency of the measurements and (e) Spearman's correlation coefficient to calculate the correlation between ALs of the two methods. Statistical significance was established with an accepted alpha error of 5% (two-tailed).

## Results

AL\_H1 (P = 0.005), AL\_H2 (P = 0.044) and AL\_Hmax (P = 0.002) were not normally distributed, therefore Spearman's correlation coefficient was used for calculation of relationships.

In both measurements the subjects achieved significantly (P < 0.001) higher ECC torques as compared to isometric ones as shown in Figure 3a. Paired samples t-test did not show significant differences (P > 0.05) between T\_ISO1 and T\_ISO2 and between T\_ECC1 and T\_ECC2.

AL measured with the double interpolated twitch method was significantly higher than and the ALs measured with the hydraulic system (P < 0.001) (Figure 3b).



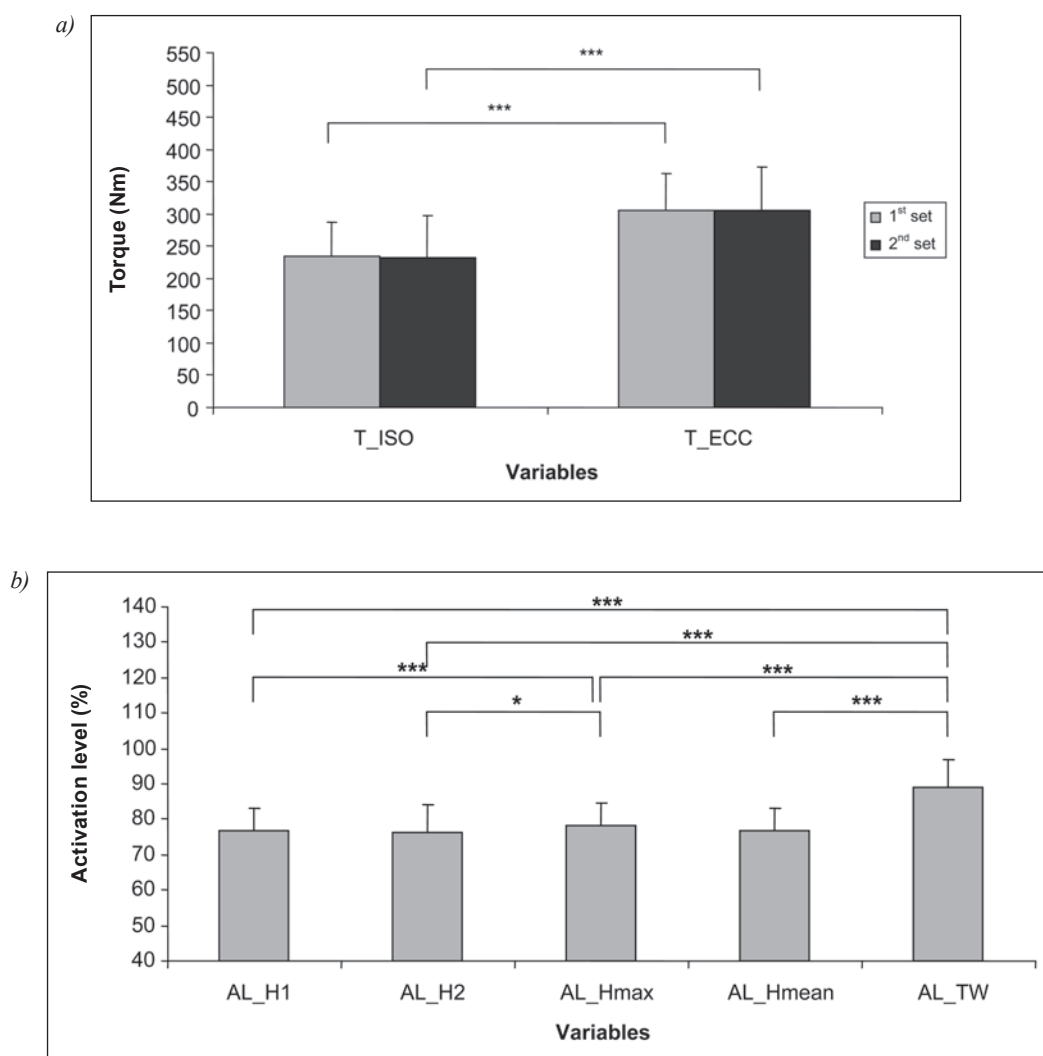

Figure 3. a) Average values and standard deviations of isometric and eccentric torques for two sets. b) A comparison of average AL values measured using both methods. (\* -  $P < 0.05$ , \*\*\* -  $P < 0.001$ ).

Intraclass correlation coefficients between the two sets in T\_ISO, T\_ECC and AL\_H parameters showed excellent repeatability and consistency (0.98, 0.97 and 0.86, respectively).

Non-parametric Spearman's correlation was used, because all AL parameters significantly differed from normal distribution. The correlations between AL\_TW and all AL\_H parameters were non-significant ( $P > 0.05$ ), as well as the correlations between AL\_TW and ISO and ECC torques.

## Discussion and conclusions

The results of the present study showed two distinctive characteristics of the activation level as measured using the hydraulic system. The first one is a high repeatability of the measurements meaning that the results are trustworthy. However, the second characteristic – validity as tested by comparison to AL obtained with the interpolated twitch technique showed no relationship between both methods. This was observed through differences in mean AL values between the methods and non-significant correlation coefficients between AL values obtained in each method.

The AL obtained with interpolated twitch method well corresponds to other studies (Babault et al., 2002; Geržević, 2004) showing that it has some external validity and could be compared to AL obtained with hydraulic system. According to this, it is possible to assume that both methods have distinctive subjects of measurement which are not comparable. Possible reasons may be in the differences in the mechanisms involved in muscle force production during eccentric contraction and interpolated twitch. During interpolated twitch, muscle force is increased mainly due to increased number of cross-bridges while force-length relationship is not significantly changed. Contrary to that, during eccentric contraction the initial muscle force increase is due to the short range stiffness (Rack & Westbury, 1974), change of torque-angle relationship and later due to additional activation by stretch reflex (Westing et al., 1990).

It seems that these methods of measuring ALs are not comparable. Consequently, AL obtained with hydraulic system may not be used for activation level measurement.

## References

1. Babault, N., Pousson, M., Michaut, A., Ballay, Y., & Van Hoecke, J. (2002). *EMG activity and voluntary activation during knee-extensor concentric torque generation*. *European Journal of Applied Physiology*, 86 (6), pp. 541-547.
2. Behm, D., G., St-Piere, D., M., & Perez, D. (1996). *Muscle inactivation: assessment of interpolated twitch technique*, *Journal of Applied Physiology*, 81 (5), pp. 2267-2273.
3. Buehrle, M., & Schmidbleicher, D. (1981). *Komponenten der maximal und schnellkraft – versuch einer neustrukturierung auf basis empirischer ergebnisse*. *Sportwissenschaft*, 11, pp. 11-27.
4. Geržević, M. (2004). *Primerjava metod merjenja nivoja aktivacije [Comparison of methods for measuring the activation level]*. Bachelor's thesis, Ljubljana: University of Ljubljana, Faculty of Sport.
5. Gandevia, S., C., Herbert, R., D., & Leeper, J., B. (1998). *Voluntary activation of human elbow flexor muscles during maximal concentric contraction*. *Journal of Physiology*, 512 (2), pp. 595-602.
6. Hales, J., P., & Gandevia, S., C. (1988). *Assessment of maximal voluntary contraction with twitch interpolation: an instrument to measure twitch responses*. *Neuroscientific Methods*, 25 (2), pp. 97-102.
7. McCully, K., K., & Faulkner, J., A. (1985). *Injury to skeletal muscle fibers of mice following lengthening contractions*. *Journal of Applied Physiology*, 59, pp. 119-126.
8. Merton, P., A. (1954). *Voluntary strength and fatigue*. *The Journal of Physiology*, 123, pp. 553-564.
9. Rack, P.M.H., & Westbury, D.R. (1974). *The short range stiffness of active mammalian muscle and its effect on mechanical properties*. *Journal of Physiology (London)*, 240, pp. 331-350.
10. Suter, E., & Herzog, W. (2001). *Effect of number of stimuli and timing of twitch application on variability in interpolated twitch torque*. *Journal of Applied Physiology*, 90 (3), pp. 1036-1040.
11. Westing, S., H., Seger, J., Y., & Thorstensson, A. (1990). *Effects of electrical stimulation on eccentric and concentric torque-velocity relationship during knee extension in man*. *Acta Physiologica Scandinavica*, 140, pp. 17-22.

## Acknowledgement

This study was supported by the Slovenian Research Agency and the Foundation for financing sport organisations in Slovenia. The authors would like to thank Mrs. Sandra Vodlan from the Wellness Center Justinopolis for enabling the measurements to be conducted in the fitness-gym.





# Kinesiological Education

**6<sup>th</sup> INTERNATIONAL  
SCIENTIFIC  
CONFERENCE ON  
KINESIOLOGY**

**“INTEGRATIVE POWER OF  
KINESIOLOGY”**

**Editors:  
Prof. Ivan Prskalo, PhD**

**Peer Reviewers:  
Prof. Branislav Antala, PhD  
Prof. Josip Babin, PhD  
Marko Badrić, PhD  
Prof. Gregor Jurak, PhD  
Prof. Marjeta Kovač, PhD  
Ivana Milanović, MSc  
Dario Novak, PhD  
Vilko Petrić, PhD  
Prof. Ivan Prskalo, PhD  
Prof. Snežana Radisavljević, PhD  
Prof. Jaromir Sedlaček, PhD  
Prof. Janko Strel, PhD**

**Secretary:  
Dario Novak, PhD**



## CAN THE USE OF HANDHELD EXTRA WEIGHTS IMPROVE STANDING LONG JUMP PERFORMANCE?

Ljubomir Antekolović, Marijo Baković and Hrvoje Ajman

*Faculty of Kinesiology, University of Zagreb, Croatia*

### Abstract

The study of the role of extra load in long jump has been suggested by a piece of historic information according to which long jumpers in ancient Greece used weights – *halteres*.

The subject sample included 52 first year full time students of the Faculty of Kinesiology of the University of Zagreb. The study focused on determining whether the result of standing long jumps can be improved by the use of weights in arm swing. Kinesiological treatment was applied between the initial and the final measurement, with two training sessions a week consisting of ten standing long jumps with swinging arms and a 1 to 2 kg additional load for the purpose of adaptation to the swing with an extra load. Initial measurement did not show any statistically significant difference between jumps with and without loads, whereas during final measurement the jumps were significantly longer with the use of extra weights (251.10 vs. 256.53 cm).

**Key words:** 2 kg *halteres*, ancient Greece

### Introduction

*Halteres* are handmade weights (dumbbells) used originally for standing long jumps since the 18th ancient Olympic Games (708 B.C.), probably in order to increase jump length.

Long jumpers held stone or metal *halteres* of different forms in their hands. In most cases 1.5 to 2.5 kg, 12 to 19 cm long weights were used (Fig. 1).



Figure 1. *Halteres*, special weights used for long jump in ancient Greece

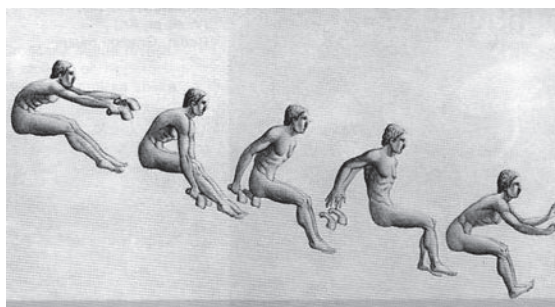

Figure 2. Representation of long jump technique in ancient Greece

The standing long jump has also been present in latter-day track and field, and was included (men only) in the Games programme five times (from the Second to the Fifth Games). The first Olympic Games that included this event were the ones in Paris in 1900, and the last in Stockholm in 1912. The most successful competitor was Ray Ewry (USA) who won three Olympic gold medals. At the 1904 Games in St. Louis he won by jumping 3.47 m, and his world record stood for decades afterwards (Anteleković&Baković, 2008).

In recent times the standing long jump is no longer an official event, but it is used in various forms as a measure for the evaluation of explosive leg strength. Two-legged and single leg standing long jumps are also used in training for explosive strength development.

Successful performance of a standing long jump calls for the coordination of arm and leg movement. It also requires a satisfactory level of technique, and athletes can only be expected to achieve full explosive strength after stabilizing their technique. The seemingly simple structure of activities in standing long jump is still studied by using computer simulations, biomechanical analyses and mathematical modelling. A standing long jump (Ashby&Delp, 2008) is 40 cm longer with a free arm swing (2.00) as compared with no swing (1.60 m). Most of the performance improvement achieved by free arm swing is accounted for by the 15% higher velocity of the centre of body mass in the moment of takeoff. A higher initial position has a positive impact on the result because it allows for a broader scope of preparation (countermovement) and, eventually, achievement of higher velocity at the end of takeoff (Cheng&Chen, 2005). In addition to the role of arm swing in standing long jump, some researchers (Lenoir et al., 2005) carried out an experiment in which subjects performed a standing long jump holding weights in their hands. In that study the subjects ( $n=4$ ) performed 5 consecutive standing long jumps and succeeded, by using weights, in jumping longer (14.64 m) than without weights (13.88 m).

In preparing this study the authors first checked the possibility of achieving greater distance in standing long jumps with weights. As observed during the experiment, the subjects could not utilize the extra load to perform longer jumps. The extra load (2-4 kg) was assumed to change significantly the mechanics of the swing and balance at takeoff.

Because of that additional kinesiological treatment was foreseen for the purpose of adaptation to the swing with an extra load if initial measurement determined no statistically significant differences between the length of standing long jumps with and without weights.

The study was supposed to determine differences achieved in standing long jump with arm swing and an extra 2 kg load.

## Methods

The subject sample consisted of 52 students  $19.25\pm 0.62$  years old, with a body mass of  $76.38\pm 8.56$  kg and height of  $179.92\pm 5.71$  cm. The subjects are students of the Faculty of Kinesiology of the University of Zagreb, of a regular health status, informed about the measurement protocol, who volunteered for the study.

The research variable was the result achieved in standing long jump performed in two ways at two points in time (Figures 3 and 4).



Figure 3. Standing long jump with arm swing ( $SLJ_{AS}$ )



Figure 4. Standing long jump with extra weights ( $SLJ_{EW2kg}$ )

The kinesiological treatment between the initial and final measurements lasted 4 weeks. The subjects performed 5 standing long jumps twice a week, with arm swing and 1 and 2 kg extra load.

The data were processed with the *Statistica ver. 7.1* statistical program (StatSoft, Inc., 2006), and descriptive analysis and t-test for dependent samples modules.

## Results

The average values of the initial measurement results for long standing jumps with arm swing (SLJ<sub>AS</sub>) and long standing jumps with 2 kg weights (SLJ<sub>EW2kg</sub>) are almost identical (Table 1).

Table 1. Descriptive parameters of initial measurement for standing long jump (N=52)

VAR	MEAN	MIN	MAX	SD
SLJ <sub>AS</sub>	250.14	220.00	288.00	15.46
SLJ <sub>EW2kg</sub>	250.94	221.00	286.00	15.73

Standing long jump with arm swing (SLJ<sub>AS</sub>); Standing long jump with extra weights (SLJ<sub>EW2kg</sub>)

In Table 2 the final measurement values indicate a difference to the advantage of the average length of standing long jumps with arm swing and a 2 kg extra weight. As compared to initial measurement, an increase of results is visible in both variables. According to final measurement, the maximum results are also higher in both variables.

Table 2. Descriptive parameters of final measurement for standing long jump (N=52)

VAR	MEAN	MIN	MAX	SD
SLJ <sub>AS</sub>	251.10	218.00	297.00	15.85
SLJ <sub>EW2kg</sub>	256.53	222.00	292.00	15.47

Standing long jump with arm swing (SLJ<sub>AS</sub>); Standing long jump with extra weights (SLJ<sub>EW2kg</sub>)

Similar results for standing long jump, or somewhat higher if the sample was representative, were also obtained by other researchers (Huang et al., 2005).

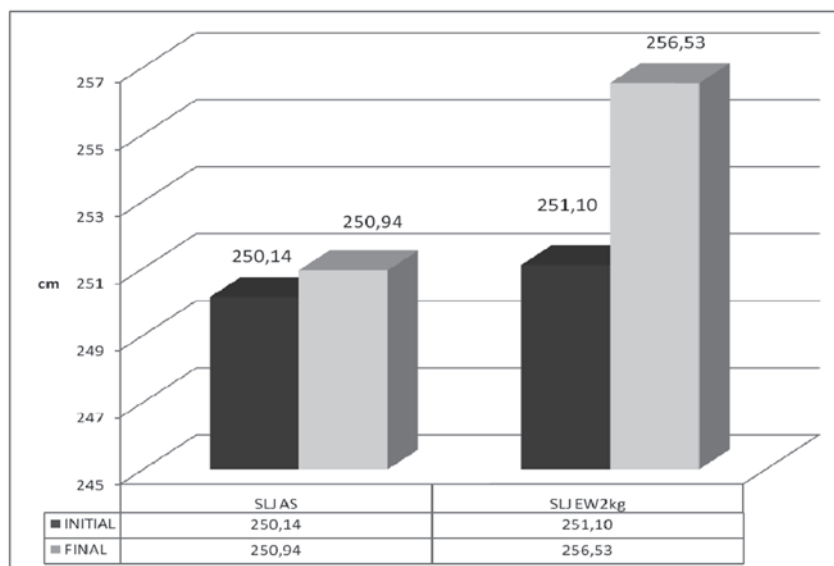

Standing long jump with arm swing (SLJ<sub>AS</sub>); Standing long jump with extra weights (SLJ<sub>EW2kg</sub>)

Graph 1. Average value of standing long jump at initial and final measurement

The differences between the initial and final measurement were determined by t-test analysis for dependent samples, and the results are shown in Tables 3 and 4 at error level  $p=0.05$ .

Table 3. Results of t-test analysis for initial measurement

VAR.	MEAN	STD.DEV.	N	DIFF.	STD.DEV.DIFF.	t	df	p
SLJ <sub>AS</sub>	250.14	15.46						
SLJ <sub>EW2kg</sub>	250.94	15.73	52	-0.80	7.23	-0.80	51	0.43

Standing long jump with arm swing (SLJ<sub>AS</sub>); Standing long jump with extra weights (SLJ<sub>EW2kg</sub>)

Mean = arithmetic mean; std. dev. = standard deviation; N = number of subjects; diff. = difference; std. dev. diff. = standard deviation difference; t = t-value; df = degree of freedom; p = error (p=0.05)

T-test analysis at initial measurement determined no difference, whereas at final measurement the difference between the arithmetic means of the observed variable was statistically significant.

Table 4. Results of t-test analysis for final measurement

VAR.	MEAN	STD.DEV.	N	DIFF.	STD.DEV.DIFF.	t	df	p
SLJ <sub>AS</sub>	251.10	15.85						
SLJ <sub>EW2kg</sub>	256.53	15.47	52	-5.44	6.74	-5.82	51	0.00

Standing long jump with arm swing (SLJ<sub>AS</sub>); Standing long jump with extra weights (SLJ<sub>EW2kg</sub>)

Mean = arithmetic mean; std. dev. = standard deviation; N = number of subjects; diff. = difference; std. dev. diff. = standard deviation difference; t = t-value; df = degree of freedom; p = error (p=0.05)

## Discussion and conclusion

Initial measurement results confirmed the assumption that significantly longer standing long jumps with an extra load cannot be expected in the kinesiology student population. Although it is historically known that in ancient Greece jumpers used *halteres* in order to improve jump efficiency, it is obvious that this calls for perfect time and space coordination of the swing if jump length is to be improved. The subjects had some previous experience with standing long jump, but jumps with extra weights were for them a new motor stereotype the performance of which did not produce a really longer jump. This can be explained by the fact that the subjects were not top level track-and-field athletes and that the obvious extra load significantly affected the coordination of swing and takeoff, balance and the landing technique. Because of this 4-week kinesiological treatment was applied for the purpose of adaptation to swing with an extra load, which finally resulted in significantly longer jumps. During the mentioned period the subjects did not achieve a transformation shift in the field of explosive strength, as shown by the results of the standing long jump with arm swing variable (initial measurement 250.14 cm; final measurement 251.10 cm). However, adaptation to swing with an extra load was achieved in the mentioned period, and at final measurement the jumps of the subjects were significantly longer with the use of extra load (256.53 cm) as compared with jumps with no load (251.19 cm). This confirmed somewhat the theory about the use of extra load in order to improve jump length. Obviously, the extra load has a positive impact on increasing jump length, but that calls for a specific level of skill. In ancient Greece the long jump was an important discipline and jumpers, in addition to long-standing training, also used *halteres* to score longer jumps. Today extra weights can be used for long jump training and generally for explosive force development – best applied in the preparatory and pre-competition period. The mass of the extra load can be 1 or 2 kg for young and less well-trained athletes, or maximum 8% of the body mass for adult athletes (Huang et al., 2005).

## References

1. Antekolović, Lj., Baković, M. (2008). Skok u dalj. Zagreb: Miš.
2. Ashby, M., B., Delp, L., S. (2008). Optimal control simulations reveal mechanisms by which arm movement improves standing long jump performance. *Journal of Biomechanics*, 39, 1726-1734.
3. Cheng, K. B., Chen, W. C. (2005). Optimal standing long jump simulation from different starting postures. *Journal of Mechanics in Medicine and Biology*, 5( 2), 203-215.
4. Huang, C., Chen, H., Peng, H. (2005). The effect of hand-held weight on standing long jump performance. ISBS22th. Beijing, China.
5. Lenoir, M., de Clercq, D., Laporte, W. (2005). The “how” and “why” of the ancient Greek long jump with weights: A five-fold symmetric jump in a row? *Journal of Sports Sciences*; 23(10), 1033-1043.



## RELATIONS OF BASIC MOTOR SKILLS AND STYLIZED MOVE STRUCTURES OF FIGURE SKATING

Marijana Arapović and Lejla Šebić

*Faculty of Sport and Physical Education, the University of Sarajevo, BiH*

### Abstract

The goal of the research was to define relations between basic motor capabilities and stylized structures of moves in figure skating. Sample of examinees for the research consists of 100 girls, from 9 to 11 years of age, attendees of the „Fit & Fun“ School of Figure Skating from Sarajevo. All the girls participated in three-months School program of figure skating after which their success in performing stylized moves on ice was assessed through 12 different variables by three figure skating judges on Linkert scale ranging from 1 to 5. Variables for assessment of basic motor capabilities were selected in order to cover all hypothetic areas: explosive strength, agility, coordination, balance and flexibility (15 variables in total). In order to define relations between two different data bases of motor capabilities and stylized move structures of figure skating we applied Hotelling's method of canonic correlative analysis by which we isolated three statistically important pairs of canonic factors. In the area of motor moves they were defined as: 1. factor of explosive strength of lower limbs, 2. factor of balance and coordination and 3. mixed factor of all sub-areas of motor moves, but mostly related to flexibility. In the area of stylized move structures these factors were defined as: 1. factor of back skating, 2. factor of forward skating on one leg and stopping and 3. general factor of stylized skating on ice, while mostly winding and moving in shape of number eight. Relations between motored dimensions and stylized move structures on ice can be described as very important ones. In order to successfully adopt elements for backwards ice skating it is important to use explosive strength to commence with this move in the first place, which is confirmed by the first canonic factor. The second canonic factor is directing us towards the fact that ice skating on one leg and stopping has been adopted more successfully by the girls who developed coordination and balance. The highest values in the third canonic factor were variables of meandered ice skating on two legs like winding or moving in the shape of number eight, the moves for which flexibility has the highest importance.

**Key words:** *girls, skating school, expert analysis*

### Introduction

It is considered that the high level of motor capabilities is a basic precondition for efficient carrying out of stylized move structures, their improvement and successful utilization. Figure skating is a complex coordinative type of sport and includes elements of speed skating, gymnastics, dance, ballet, and acrobatics – all merged into one specific art choreography accompanied with music of a special rhythm. The wealth of very specific and complex moves in this sport is enormous, starting from different spins and turns to multiplied turning jumps. Modern figure skating is characterized by long influence of acyclic work rhythms (free program lasts up to 4,5 minutes) and requires the skater to have great speed, expression, artistic suggestiveness, spontaneous appearance and stability in the conditions that are not usual for body balance (blade of the skate and ice). Development and advancement of a group of analyzers, especially the ones related to moves, visual appearance, vestibular and sound effects, has an enormous effect for regulation of skater's moves and defines specific feelings on which filigree (subtle) techniques of figure skating is being built upon (Foeste, Curtis, 2000). The process of permanent development of motor abilities is expressed through forming of more precise and more rational but also more complex and sophisticated “algorithms of orders” (Metikoš and associates, 2003) which are responsible for activating and deactivating of different muscles taking into consideration order, intensity and length of their work which results in performance of a certain motor operation (Findak and associates, 1998). In accordance with this model all useful motor moves can be considered as motor information which are being as successful as “algorithms of orders” were formed. Motor programs is being formed in central system of nerves and contains ready muscular efferent orders with all the details needed for a certain move (Horga, 1993). As we were speaking about “skills” it is important to remind that skills are being gained by motor learning and the motor learning is related to changes of the internal process which are defining capabilities of an individual to perform a certain motor task, as stipulated by Schmidt and Wrisberg (2000). Motor learning or forming of a motor skills capability to reach set goals with efficiency higher than a person with no experience can demonstrate. In this sense the motor capability or knowledge is ability to perform a motor task “smoothly and harmoniously”. “Smooth and harmonious” moves are defined as moves with strong rhythmic and

dynamic accent by which we develop a sense for technical performance of figure skating elements, sense for rhythm and subtle and flexible moves. During the so far researches of relations and influence of basic motor capabilities to failures in sports which dominantly require stylized move structures we came to the conclusion that predominating opinion was that the most important motor capabilities were: strength (Wolf-Cvitak 1984, Srholj 1989, Hume and associates, 1993); coordination (Kioumourtzoglou and associates, 1997, Rutowska-Kucliarska and Bober 1998, Šebić-Zuhrić 2003); coordination in rhythm (Wolf-Cvitak 1984, Srholj 1989, Persicshini and associates, 1998) and flexibility (Srholj, 1989, Hume and associates, 1993). Unfortunately in the figure skating area there are still not enough relevant scientifically based information which would enable higher effects on system of schooling and education as well as on reaching top sports results; this research is meant to be a contribution in this regard. As motor capabilities are a very complex latent system and they cannot linearly participate in the process of earning move structures; their influence is determined by hierarchy structure. To make it more simple to understand, as we have different move structures the level of engagement of certain motor structures is higher in comparison to other motor capabilities.

## Methods

Sample of examinees for the research consists of 100 girls, from 9 to 11 years of age, attendees of the „Fit & Fun“ School of Figure Skating from Sarajevo. Variables used for evaluation of basic motor capabilities in this research were consisting of 15 different tests for which it is assumed that they cover a number of hypothetic factors responsible for success when performing stylized move structures of figure skating.

Following test were used for *evaluation of coordination* factors: MKOKOP- coordination with stick; MKLULK- throwing of balls into boxes while sitting, MKOS3M - slalom with three medical balls. Following test were used for *evaluation of agility* factor: MAGTUP - running in rectangular shape, MAGKUS - steps into one side, MAGOSS - moving in shape of number eight while bending. Following test were used for *evaluation of balance* factor: MBAU2Z- standing on both feet on balance bench with closed eyes, MBAU2O - standing on both feet on the balance bench with open eyes, MBAPIO- standing on one foot on a side of a balance bench with open eyes. Following test were used for *evaluation of flexibility* factors: MFLISK - turning into one side with a stick, MFLPRK- bending on the bench, MFLZLP - banding back while laying on the chests with feet next to each other. Following test were used for *evaluation of factors of explosive strength*: MFE20V - 20 meters running, MFESDM - standing jump, MFESVM - standing jump up. Stylized move structures of figure skating were evaluated through 12 elements on ice: KNAP- skating forward (pushing against the surface and skating), KNAC - skating forward while crouching, KNA8 - skating forward in shape of number eight, KNAS - skating slalom, KNAV- forward skating in chaplet, KNA1 - forward skating on one leg, KNZ8 - back skating in shape of number eight, KNAV - skating forward in chaplet, KNZS - skating back in slalom, KNZV - skating back in chaplet, KNZ1 - back skating on one leg, KOKR - turning on both skates, KZAU - stopping with plough.

All the girls were regularly attending three months school program after which we organized expert assessment of their success in performing stylized move structures on ice by an independent three-members commission on a Linekrt scale ranging from 1 to 5 (Table 1).

Table 1. Criteria for evaluation of figure skating elements

MARK	TECHNIQUE – GENERAL IMPRESSION	COORDINATION OF MOVES	MISTAKES IN PERFORMANCE
5 (five)	Technique completely correct.	Optimum amplitude of move, appropriate speed and rhythm. Extremely good coordination of the entire body. Element is properly esthetic.	No mistakes in initial position, of body, legs, arms and final position.
4 (four)	Minor insecurity and lack of preciseness.	Optimum amplitude of move, slower execution.	Maximum number of minor mistakes 1-3.
3 (three)	Well done element but with lack of security and preciseness	Lack of amplitude in move, minor lack of balance, incorrect body posture but structure of the move is not damaged.	Maximum number of minor mistakes 2-4.
2 (two)	Damaged technique, lack of balance. Structure of move spoiled.	Weak muscles, damaged balance, incomplete move. Obvious poor coordination of the body.	Major damages in almost all above listed technical requirements.
1 (one)	Technique completely poor, major lack of balance or fall.	Poor amplitude, major mistakes, structure of the move seriously damaged, lack of balance or fall.	Poor element large number of mistakes, structure of the move cannot be defined.

## Results

In order to define relations between two data bases on basic motor capabilities and stylized move structures in figure skating we used Hotelling's method of canonic correlative analysis (table 1), where we isolated three significant, positive canonic functions (Canonic R), for whom we identified connection with motor capabilities and success on performing figure skating elements at the value  $p = .05$ . All three canonic functions are extremely high. *The first canonic function* of these three groups of variables is (Canonic R) = .92 and explains (Canonic R-sqr.) = 85 % of the common variability of group of motor variables and group of variables for evaluation of success in performing stylized moves of figure skating. The importance of connection between these researched fields is (Chi-sqr.) = 492.1. *The second canonic function* also has a high value of coefficient of canonic correlation (Canonic R) = .83 and is responsible for (Canonic R-sqr.) = 69 % of common variability of these two groups of variables. The importance of researched field is (Chi-sqr.) = 332.4. *The third canonic function* is a bit smaller in comparison to first two, but still has quite a high value (Canonic R) = .78 and explains (Canonic R-sqr.) = 61 % of the common variability and the importance of researched field is (Chi-sqr.) = 235.1.

Table 2. (Canonic R) coefficients of canonic correlation (function); (Canonic R-sqr.) % of the common variability of researched field; (Chi-sqr.) importance of connections between researched fields; (df) open percentage.; (p) level of importance of pairs of canonic factors

	Canonic R	Canonic R-sqr.	Chi-sqr.	df	p	Lambda Prime
0	R	R-sqr.	Chi-sqr.	df	p	Prime
1	,925	,857	492,1	21	,000	,002
2	,833	,694	332,4	18	,000	,017
3	,781	,610	235,1	15	,000	,056
4	,618	,382	157,8	13	,062	,145
5	,575	,331	118,2	11	,277	,236
6	,510	,261	85,31	90	,619	,353
7	,481	,231	60,50	72	,830	,478
8	,423	,179	38,88	56	,960	,622
9	,348	,121	22,66	42	,993	,758
10	,274	,075	12,06	30	,998	,863
11	,215	,046	5,640	20	,999	,933
12	,130	,017	1,755	12	,999	,978
13	,062	,003	,3377	6	,999	,995
14	,012	,000	,0135	2	,993	,999

*The first canonic factor* in the area for evaluation of motor capabilities was dominantly defined by tests for evaluation of explosive strength (MESSDM – broad jump and MESSVM - high jump) but also, in a smaller scale by agility tests (MAGKUS – steps into one side, and MAGOSS - moving in shape of number eight while bending). Taking into consideration that the highest value of the first canonic factor is defined by the measure for evaluation of explosive strength this factor may be identified as *explosive strength factor*. Therefore, in order to perform stylized structural moves of figure skating it takes explosive strength of lower limbs which enables improved muscular control and better skating performance. *The second canonic factor* for evaluation of motor capabilities was defined by tests for evaluation of *balance* and *coordination*. The highest value in defining of this factor had a test for evaluating balance while standing on both feet along the bench with open eyes (MBAU20) which is understandable as during the figure skating there is a permanent danger of loss of balance which is preconditioned by friction between blades of the skates and ice. Skating may be considered as a sport with specific dynamical balance, i.e. proprioception (lat. Proprius – of your own, perception – consciousness). It comprehends the feeling for one's own body posture in the space (Michael and Graziano 1999). The figure skating may be included in those motor activities which are being performed in special and very complex conditions. The skater, the skates and the ice are an unique system which functions in the optimum manner when there is a mutual harmonization between individual elements of the system, and that takes a high quality balance. The coordination factor is also a very important one, as well as the ability to orientate in space and time and manage sophisticated moves, including estimation of needed strength and speed in a certain situation. In the initial phase of performing some motor program, cognitive functions are being turned on (Adams, 1971, Gentile 1972) as well as motor factors of the higher level (Metikoš and associates 2003), and especially a general factor of coordination. The second canonic factor in the space is *factor of balance and coordination*. *The third canonic factor* is partially described by at least one test from all hypothetical fields and it is therefore defined as a *motor factor of mixed type with domination of flexibility*.

Table 3. Canonic factors in the area of motor capabilities

	Root 1	Root 2	Root 3
MKOKOP	,089	,367	,293
MKOULK	,020	,208	,385
MKOS3M	,099	,237	,008
MAGTUP	,068	,015	,110
MAGKUS	,243	,137	,093
MAGOSS	,206	,171	,364
MBAU2Z	,147	,142	,101
MBAU2O	,051	,634	,249
MBAP10	,147	,533	,338
MFLISK	,083	,028	,121
MFLPRK	,023	,129	,057
MFLZLP	,081	,002	,658
MES20V	,033	,075	,107
MESSDM	,511	,087	,367
MESSVM	,330	,069	,224

Table 4. Canonic factors in the area of stylized moves

	Root 1	Root 2	Root 3
KNAP	,532	,519	,577
KNAC	,088	,300	,667
KNA8	,413	,085	,763
KNAS	,265	,006	,005
KNAV	,279	,013	,798
KNA1	,101	,479	,022
KNZ8	,624	,597	,575
KNZS	,602	,173	,456
KNAV	,279	,013	,798
KNZ1	,398	,593	,280
KOKR	,130	,023	,040
KZAU	,032	,610	,559

In the area of stylized move structures (table 4.), the first canonic factor with the largest values was described by variables of back skating in all shapes and it can be described as the *back skating factor*. In this type of skating, its motor part, explosive strength of lower limbs is responsible for initiating the move in the opposite direction. Agility is also important for the back skating elements as it helps the skater to change direction of moves. *The second canonic factor* in the skating area includes variables KNAP (straight forward skating), KNAC (skating forward while crouching), KZAU (stopping with plough), KNA1 (forward skating on one leg) and KNZ1 (back skating one leg). Taking into consideration variables we isolated, this factor may be described as *factor of straight forward skating on one leg and stopping*. In the second canonic dimension we isolated more complex elements of skating and these elements require extraordinary coordination which enables the skater to learn new more complex activities but also to correctly, economically and ingeniously resolve given tasks. When defining second canonic factor we included variables of skating on one leg in which dominating factors are balance and coordination. In elements of skating on one leg, combination of speed and arms position will assist the skater to reach balance. The third canonic factor is defined as *general factor of stylized moves on ice* and for this factor, in the area of motor capabilities, factor of the mixed type, with domination of flexibility is responsible. Skaters (women) are facing balance transfer to the inner and outer edge of the blade in elements as winding and moving in the shape of number eight, while controlling inertia factor and ability to re-adapt body balance which require flexibility in all joints of the lower limbs.

## Discussion and conclusion

Results of the research indicate that for the preparation and realization of stylized move structures of figure skating it is indeed necessary to have significant level of motor stimulant as its complexity is reflected in interaction of a number of important and inevitable factors i.e. reduced surface of the base and necessity to center body balance right above the blade of the skate on an instable ice surface. Therefore it is not surprising that a very important segment of the variability taken out of that specific moves is quite similar to variability in flexible moves which were, for the needs of this test, defined as general motor tests. The interpretation was done on basis of correlations between systematic variables and appropriate canonic factors. Within the anthropological area basic motor skills are a basic element out of which other stylized move structures on ice are being learned; the most important three canonic factors ensuing by the results of this research in the area of motor capabilities can be defined as: 1. factor of the explosive strength of the lower limbs; 2. balance and coordination factor and 3. mixed type factor which include all four sub-areas of motor capabilities but is mostly regarding flexibility. In the area of stylized move structures these factors were defined as 1. factor of back skating, 2. factor of straight forward skating on one leg and stopping, 3. general factor of stylized moving on ice while side meandering moves like winding and moving in the shape of number eight are dominating. We can conclude that this research has proven that there is statistically significant correlation between basic motor capabilities and stylized moves in figure skating. The results of the research indicate that skating sports clubs, when practicing with younger categories, should apply a model of multiple development (Bompa 2000). It is certain that in the multisided phase of development in the area of motor capabilities the priority should be given to development of coordination, balance, agility explosive strength and flexibility not forgetting

the skating skills. All the aforementioned conditions have to reach optimal level in order to realize as good as possible stylized moves on ice which are very complex from information and energetic point of view.

## References

1. Bompá, O. Tudor. (2000). Total Training for Young Champions, Human Kinetics.
2. Findak V., D. Metikoš, M. Mraković, B. Neljak, F. Prot (1998). Motor knowledge. Kinesiology faculty, University in Zagreb.
3. Foeste, A., Curtis. B. (2000). Ice Skating Basics Sterling Publications.
4. Gentile, A.M. (1972). A working model of skill acquisition with application to teaching. Quest Monograph XVII, 3-23.
5. Horga, S. (1993). Sports psychology. Kinesiology faculty, University in Zagreb.
6. Hume, P.A., W. G. Hopkins, D.M. Robinson, S.M. Robinson, S.C. Hollings (1993). Predictors of attainment in rhythmic sportive gymnastics. The Journal of Sports Medicine and Physical Fitness, 33(4): 367-377.
7. Kioumourtzoglou E, V. Derri, O. Mertzanidou, G. Tzetzis (1997). Experience with perceptual and motor skills in rhythmic gymnastics. Percept Mot Skill, 84: 1363-1372.
8. Metikoš D., I. Jukić, G. Marković, D. Sekulić (2003). Motor knowledge in function of getting sports persons into shape: Milanović, D., I. Jukić (ur), Collection of papers of international scientific convention "Getting sports persons into shape", Kinesiology faculty in Zagreb, Zagreb Sports Union.
9. Michael, S. i Graziano, A. (1999). Where is my arm? The relative role of vision and proprioception in the neuronal representation of limb position, Proceedings of the National Academy of Sciences 99 (10418-10421)
10. Persichini, C., C. Baldari, L. Guidetti, M. Trombetta, L. Capranica and F. Figura (1998). Assessment of rhythmic ability: differences between sedentary and rhythmic gymnastics athletes. Journal of sport sciences, 16 (5): 397-398.
11. Rutowska – Kucharska A., T. Bober (1998). Coordination of arms swing and take – off in rhythmic sportive gymnastics jumps. In Sargeant A. J., H. Siddons (Eds.); Third ECSS Proceedings Book (p.p. 30.), Manchester, UK.
12. Srholj, Lj. (1989). Relations between anthropological, motor and functional and latent dimensions of school girls successes on rhythmic-sports gymnastics. (Ph D Essey), Skopje: Faculty of Sports , Skopje University.
13. Schmidt R.A., C.A. Wisberg (2000). Motor Learning and Performance. Human Kinetics.
14. Šebić-Zuhrić, L. (2003). Canonic relations between basic motor capabilities and complex motor structures in rhythmic gymnastics (Masters Esseyd) Sarajevo: Faculty of Sports. University of Sarajevo.
15. Wolf-Cvitak, J. (1984). Relations between morphological and primary motor dimensions with successes in rhythmical-sports gymnastics at the selected sample of examinees. (Masters Essey) Zagreb: Kinesiology faculty, University in Zagreb.

## PREDICTION OF HIGH JUMP RESULTS FOR KINESIOLOGY STUDENTS

Marijo Baković<sup>1</sup>, Saša Bašćevan<sup>2</sup> and Ljubomir Antekolović<sup>1</sup>

<sup>1</sup>Faculty of Kinesiology, University of Zagreb, Croatia

<sup>2</sup>Petand Orthopaedic, Physical Medicine and Rehabilitation Clinic, Zagreb, Croatia

### Abstract

The salient feature of jumping disciplines is the successful transformation of horizontal velocity into a good long jump or high jump. In long jump that horizontal velocity is transformed into a horizontal – vertical component, while in high jump the same velocity is transformed into a vertical component aided by centrifugal force generated through motion in the curve-like phase of approach to the bar. In high jump, as in other similar track and field disciplines, there is constant need to create new specific tests for jumping ability that can be better result predictors. The purpose of this study is to create a test for specific jumping ability and explosive strength jumping ability for high jump athletes. The goal was also to establish the general and individual influence of basic and specific tests on the prediction of high jump results.

**Key words:** *fosbury flop, jumping ability, specific test*

### Introduction

The progress of knowledge in all sports disciplines has given rise to the need to create new and more specific tests for assessing success in the performance of a specific activity. These tests offer manifest scope because they provide the possibility for direct measurement and are supposed to facilitate the prediction of latent structures that are not directly measurable in a specific sports discipline.

Take-off ability is part of the latent space of the explosive strength of vertical jump capability characterized by fast and flexible reaction from the surface and the display of maximum force in the shortest possible time.

The salient feature of jumping track and field disciplines is the successful transformation of horizontal velocity into the best possible long/high jump. In long jump this horizontal velocity is transformed into a horizontal-vertical component, while in high jump this horizontal velocity needs to be transformed into a vertical component supported by the centrifugal force produced by motion along the curve in the run-up phase.

In track and field in general, and in the jump and the high jump disciplines in particular, there arises the need for the development of new measurement methods which will also enable, with certain deviations, the prediction of results, and help to determine the take-off ability of individual athletes by measurement.

High jump has been the subject of many studies focused on the prediction of variables and factors contributing to success in that discipline. Thus, a success specification equation for high jump has been approximated by inserting specific factors and coefficients of their influence into an equation for functional multiple regression analysis. Obviously, the takeoff ability factor is crucial for the achievement of maximum results in high jump, provided, of course, an optimum technical performance.

A fewer number of studies endeavoured to determine the differences or the influences of different takeoff ability tests and their relation with the final high jump result.

In his research Korica (1985) attempted to develop a success specification equation in high jump for beginners by processing data obtained on 56 students aged 15 to 17 tested in 26 tests (23 motor tests, 2 anthropometric tests and the chronological age test). He extracted 5 major components and described them as a) specific features of high jump by the fosbury flop technique; b) relative flight timing and coordination; c) factor of run-up and takeoff test differentiation; d) factor of chronological age projection and anthropometric weight measurement differentiation; and e) factor of body weight and vertical jump capability differentiation.

Differences between basic and specific takeoff ability were studied, among others, by Young, MacDonald and Fitzpatrick (1997), who presented results for 17 subjects tested for a standing two-legged jump (SARGENT) and single leg takeoff with a 1, 3, 5 and 7 stride run-up. They attempted to achieve three goals: A) determine the influence of run-up on reach height; B) determine the more natural jump form; C) test the reliability and internal consistency of the “brush” test and tensiometric platform test. The results indicated a significant difference between the two-legged jump and the jump with single leg takeoff with 3 and more run-up strides, and showed that the “brush” test was a more reliable measuring instrument.

Strojnik (1998) progressed the most in the study of latent dimensions. He applied a taxonomic analysis to describe takeoff ability and used 13 tests for assessing takeoff ability and 14 anthropometric variables. Two latent dimensions were extracted for takeoff ability: vertical jump capability and repeated jump ability where the dominant factor was the single leg horizontal jump.

The present study focused on the development of a test for the evaluation of specific takeoff ability and the explosive strength of vertical jump capability. Moreover, basic sample tests for the evaluation of the same abilities were used in order to determine the total and individual influence of basic and specific tests on the high jump result.

## Methods

The subjects included 54 female and 104 male first year students of the Faculty of Kinesiology of the University of Zagreb in the academic year 2006/2007. At the end of the high jump course they were rated by 3 professional referees for the displayed fosbury flop technique; their competitive score, one anthropometric feature, one basic and one specific test for the evaluation of vertical jumping capability were also recorded. The subjects to be included in the research had to be graded at least good (3), very good (4), and excellent (5), which means that they used the semi-circular run-up potential correctly, oriented their takeoff well, and displayed minimum twist above the bar.

The subjects were divided by the *GENDER* variable and evaluated by the anthropometric *HREACH* variable, the basic motor test for the evaluation of explosive jump strength *SARGENT* in three repeated measurements, the specific motor test for the evaluation of explosive single leg jump strength from a semi-circular 5 stride run-up *SAR5S*, also in three repeated measurements, the *GRADE* jump variable and the *RESULT* variable. The difference (*SARDIFF*) between the best *SAR5S* and *SARGENT* tests was also computed.

The data obtained were inserted in the STATISTICA 5.0 computer program by means of which central tendency measures and dispersion parameters were calculated for female and male students. The overall influence of predictor (independent) variables on the *RESULT* criterion (dependent) variable was evaluated by multivariate regression analysis. The reliability of the measuring instrument was evaluated by the Reliability Item Analysis from the Statistica 5.0 program.

## Results

The obtained results were divided by sex and processed by the Statistica 5.0 program. Tables 1a and 1b present the arithmetic mean and the dispersion measures (minimum, maximum and standard deviation) of the variables *HREACH*, *GRADE*, *RESULT*, *SARMAX* (best result for each subject in the *SARGENT* test) and *SAR5MAX* (best result for each subject in the *SAR5S* test) for men and women. The range of the results indicates a sufficient sensibility of the measuring instrument, and the position of the arithmetic mean visibly approximates the central values which is also an indication of regular result distribution.

Table 1a. Arithmetic mean and dispersion measures (M) N=104

	Mean	Minimum	Maximum	Std. Dev.
HREACH	234.06	212	263	9.56
GRADE	3.89	3	5.00	0.74
RESULT	158.62	145	185	8.81
SARMAX	290.74	268	323	11.59
SAR5SMAX	306.48	279	332	11.85
SARDIFF	9.50	-12	24	7.77

Table 1b. Arithmetic mean and dispersion measures (W) N= 54

	Mean	Minimum	Maximum	Std. Dev.
HREACH	215	197	236	8.75
GRADE	3.79	3	5	0.79
RESULT	131.31	115	153	9.15
SARMAX	259.09	235	297	11.66
SAR5SMAX	268.59	239	295	13.63
SARDIFF	15.89	0	36	6.83

The influence of the independent predictor variables on the criterion dependent variable was evaluated by multiple regression analysis. Independent variables included HREACH, GRADE, and SARDIFF which represents the difference between variables SAR5MAX and SARMAX. The two variables were combined into one in order to eliminate the high correlation between the two mentioned variables. It is known that predictive variables need to be in the lowest possible reciprocal correlation, and in the highest possible correlation with the criterion variable, in this case RESULT.

Table 2a. Multiple regression analysis  $p < 0.05$  (M)

Multiple R	0.73
R <sup>2</sup>	0.52
F	37.11
N	104
df	3.1
Standard error of estimate	6.11
p<	0.02
HREACH beta	0.42
GRADE beta	0.58
SARDIFF beta	0.15

Table 2b. Multiple regression analysis  $p < (W)$

Multiple R	0.68
R <sup>2</sup>	0.46
F	14.35
N	54
df	3.5
Standard error of estimate	6.9
p<	0.03
HREACH beta	0.24
GRADE beta	0.52
SARDIFF beta	0.21

As shown, there is a small difference between multiple correlations for the male (0.73) and female (0.68) sample, and between the coefficients of determination (men 0.52, women 0.46), i.e., that the coefficient of determination of the RESULT variable by three independent variables, HREACH, GRADE and SARDIFF, amounts to 0.52 for men and  $R^2=0.46$  for girls. This means that the three variables determine 52% and 46%, respectively, of the dependent variable. The partial influences of the individual (beta) variable on the RESULT variable in male students are also statistically significant for each variable; the influence is the highest for variable GRADE (0.581), somewhat lower for variable HREACH (0.418), and the lowest, but still statistically significant, for variable SARDIFF (0.154). A different relation was established for the women: the partial influences of the individual variable (beta) on variable RESULT are statistically significant for variable GRADE (0.52), variable HREACH (0.24), but not for variable SARDIFF the beta of which is not statistically significant. When comparing male and female students, the only difference is the absence (in the latter group) of a statistically significant influence of variable SARDIFF, which is certainly unexpected since this is the only motor ability variable. Surprisingly, the only variable in the field of motor abilities does not influence high jump results in female students.

## Discussion and conclusion

The evaluation of technique, i.e., of the clearance of the bar, for this subject sample was indispensable because only the correctly twisted position above the bar takes advantage of the run-up and takeoff potential. In biomechanical terms only such a position minimizes the difference between the maximum height of the centre of mass and the height of the bar which can be cleared successfully. The influence of motor tests on high jump results can be studied in a better way by inserting the grade for the subject, or by excluding subject incapable of applying the correct position above the bar.

The prediction of independent variable (HREACH, GRADE and SARDIFF) on the RESULT variable has been determined by multiple regression analysis. The obtained multiple correlations and coefficients of predictor variable influence on the criterion variable indicate an approximately half-way prediction of results by means of the three mentioned



variables, and the individual influence of variables on the criterion indicates a higher predictability of the GRADE variable as opposed to the HREACH anthropometric variable, and an even higher predictability as opposed to the product of subtraction of two variables from the motor space, meaning that it had the highest single influence on the results achieved by male and female students. Another difference that can be read from the data obtained by multiple regression analysis is the absence, in women, of a statistically significant partial influence of the SARDIFF variable on RESULT. The results suggest that better high jump results are achieved with a higher grade of adoption of technical elements (GRADE). The standing reach measure (HREACH) and the motor measure of the quality of takeoff ability (SARDIFF) explain the variance of results to a lesser extent. The teaching process in which the fosbury flop technique is taught for 4 weeks leads to a satisfactory influence of the high jump technique on the competitive score (average value of the best result 158.62 cm for male and 131.31 cm for female students), but is certainly not enough for the realization of motor potentials measured by the specific test of vertical jumping capability. Such a transfer obviously requires a significantly longer coaching and competitive experience.

Although with a smaller number of variables, this way can explain the 73% and 68% variance, respectively, in high jump results. A more detailed high jump study requires the integration of additional variables which would complete the field of coordination and explosive strength (e.g., biomechanical indicators of takeoff abilities).

The aim of this study on the selected sample was to present certain relations specific only for the tested sample. The measurement of a representative sample, i.e., high jumpers proper, could be expected to yield entirely different relations with results tending to a higher relation between results and specific tests for the evaluation of takeoff abilities and the explosive strength of vertical jump capability.

The results can only be linked with the population of kinesiology students attending the high jump course in their curriculum, and they will achieve their best results mainly by a good realization of technical high jump elements and only then by a high level of vertical jumping capability.

## References

1. Korica, P. (1985). *Relacije između bazičnih kretnih struktura skoka u vis i efikasnosti skoka u vis leđnom tehnikom – master thesis*, Fakultet za fizičku kulturu, Sveučilište u Zagrebu, Zagreb.
2. Strojnik, V. (1998). *Taksonomic structure of entities in take-off power space*, Kinesiologica Slovenica, Ljubljana, vol 4, str. 46-51.
3. Young, W., MacDonald, C., Heggen, T., Fitzpatrick, J. (1997). *An evaluation of the specificity, validity and reliability of jumping tests*, The Journal Of Sports Medicine and Physical Fitness, Italy, vol 37. (4), str. 240-245.
4. Young, W., Wilson, G., Byrne, C. (1999). *Relationship between strength qualities and performance in standing and run-ap vertical jumps*. The Journal Of Sports Medicine and Physical Fitness, vol 39. (4), str. 285-293.

## OVERWEIGHT AND OBESITY AS LIMITATION FACTORS OF AGILITY AND STRENGTH DEVELOPMENT

Ana Božanić, Jure Benić and Damir Mumanović

*Faculty of Kinesiology, University of Split, Croatia*

The increase of prevalence levels of overweight and obesity among children worldwide is alarming since obesity related health risks are no longer only seen in adults. The aim of the current research was to investigate the effect of the overweight and obesity as limitation factors of agility and strength development among 125 seven-year-olds. By the international cut off points for BMI for overweight and obesity three groups of subjects were extracted: normal weight (78.4%), overweight (16%) and obese (5.6%). A total of 6 tests from the “Bruininks-Oseretsky Test of Motor Proficiency 2” was extracted for the agility and strength assessment. Three independent samples t tests were calculated to investigate significant differences in agility and strength between the groups. In the motor area of speed and agility, as well as in the strength area, significant differences were found between the *overweight* and *obese* ( $p=0.04$ ,  $p=0.05$ ), as well as between the *normal weight* and *obese* group of subjects ( $p=0.01$ ,  $p=0.02$ ). These results point out to a fact that slightly increased BMI in children does not necessary impair their motor abilities performance. However, a serious BMI increase could affect children’s agility, speed and strength and prevent their further motor development.

**Key words:** *body mass index, BOTMP, cut off points, motor abilities, seven-year-olds*

### Introduction

Childhood overweight and obesity is a growing epidemic. Prevalence levels of overweight and obesity are dramatically increasing among children worldwide. This increase is alarming because obesity related health risks and psychosocial consequences are no longer only seen in adults. The measurements that are most common used for calculating body fat are body mass index (BMI), and body fat percentage (BF %). BMI is defined as the individual’s body weight divided by the square of his or her height. Concerning the increase in excessive body weight cases among children and young adults, many studies have been developed with the purpose to investigate the interference of the overweight and obesity indices over physiopathological aspects concerned with the manifestation of chronic-degenerative diseases in adulthood. Within this context, Pinho and Petroski (1999), point out that overweighted or obese children present lack of physical activity as remarkable characteristic of their usual behavior and that this lack, besides being linked with cardio respiratory problems and chronic conditions, may also reflect in an insufficient motor experience which reflects over the development of gross motor skills. Test that is commonly used for measuring gross motor skills is the “*Bruininks-Oseretsky Test of Motor Proficiency – Second Edition*” (BOT-2). It is an individually administered test that uses engaging, goal-directed activities to measure a wide array of motor skills in individuals aged 4 through 21. It is designed to provide practitioners such as occupational therapists, physical therapists, developmental adaptive physical education teachers, and researchers, among others, with a reliable and efficient measure of fine and gross motor control skills. (Bruininks & Bruininks, 2005.)

Gross motor skill is classically defined as the skill which involves the mobilization of large muscular groups that produce chest, arms and legs strength. This kind of skill is closely connected with several actions used in daily life, such as running, jumping, trotting, and kicking, among others. Wrotniak et al. (2006) found that the faster that children completed the running speed and agility task and the further they jumped, the more physically active and less sedentary they were. This suggests that running speed and agility may be important to consider when examining the motor proficiency - physical activity relationship or when attempting to improve motor proficiency in youth.

Motor competence in over-weight and obese children has only been investigated in a limited number of studies. Most of the previous studies elaborate the effect of BMI on gross motor skills in general (Catenassi et al., 2007). Due to the lack of those studies, the aim of the present research was to investigate the effect of the overweight and obesity as limitation factors of agility and strength development.

### Methods

A total of 125 children participated (mean age  $7.2\pm 0.9$  years; stature  $1.39\pm 0.09$  m; body mass  $33.8\pm 8.2$  kg; BMI  $17.2\pm 2.7$ ). All of them were chosen randomly and they all gave their informed consent. All participants were students at Kastela elementary schools. The Ethical Committee of the *Faculty of Kinesiology – University of Split* verified that this investigation complied with all ethical standards for scientific investigations involving human participants. According

to Cole et al. (2000) all children were assigned to a certain group by their BMI value. By the international cut off points for BMI for overweight and obesity three groups of subjects were extracted: normal weight (n=98), overweight (n=20) and obese (n=7).

“Bruininks-Oseretsky Test of Motor Proficiency 2” (BOT-2) was administered. BOT-2 is a screening tool for motor proficiency assessment (Bruininks & Bruininks 2005). Opposed to a complete battery of 53 tests, we chose 6 tests that best represent the motor area of agility and strength (3 tests per area). Agility was measured with the use of the following tests: *shuttle run*, *one-legged side hop* and *two-legged side hop*. In the first test the examinee has to run to the 50 ft line, pick up a block and run with the block back across the start/finish line. In the second test the examinee has to perform one-legged hops back and forth over a line, maintaining proper form with each hop (knee bent 90 degrees and shin parallel to the floor, with hands on the hips). The third test is the same as the second but with the feet placed together. The motor area of strength was represented by: *standing long jump*, *sit-ups* and *V-up*. In the *standing long jump* test the examinee has to jump forward as far as he/she can landing on both feet. In the *sit-ups* test the examinee lies on his/her back on the floor with arms at sides (palms down) and bent knees to a 90-degree angle, placing feet flat on the floor. The mission is to perform a sit-up with the raise of the head, shoulders and shoulder blades off the floor, reaching for knees and then lowering body back to the floor. In the third test *V-up* the examinee lies face down on the floor with arms extended forward, legs extended behind and feet touching floor. He/her raises head, chest, arms and legs off the floor and holds the position as long as he/she can. The results of the test were either length of time or a number of events which were later transformed to the point scores according to a graded scale. A total score for each motor area was gained summing the test's point scores.

Data were analyzed using the Statistica for Windows 7.0 package. Statistical significance was set at  $p < 0.05$ . Graphic presentation was used to demonstrate the prevalence of certain cut off points in the total sample. Basic descriptive statistics were calculated for all groups and variables: mean values (Mean), standard deviations (SD), minimum (Min) and maximum (Max) results. Finally, three independent samples t tests were calculated to investigate significant differences in agility and strength between the groups.

## Results

Table 1. Basic descriptive statistics for all variables by groups (N – number of participants; Mean – mean value; SD – standard deviation; Min – minimum result; Max – maximum result)

	N	Mean	SD	Min	Max
<b>1 NORMAL WEIGHT</b>					
BMI	98	16.04	1.52	12.95	18.78
SPEED AND AGILITY	98	22.30	2.48	14.00	28.00
STRENGTH	98	16.30	2.17	10.00	22.00
<b>2 OVERWEIGHT</b>					
BMI	20	20.67	0.96	18.69	22.52
SPEED AND AGILITY	20	21.85	2.85	17.00	27.00
STRENGTH	20	16.30	2.34	12.00	21.00
<b>3 OBESE</b>					
BMI	7	23.79	0.76	22.76	24.97
SPEED AND AGILITY	7	19.43	1.90	17.00	22.00
STRENGTH	7	14.29	2.29	10.00	17.00

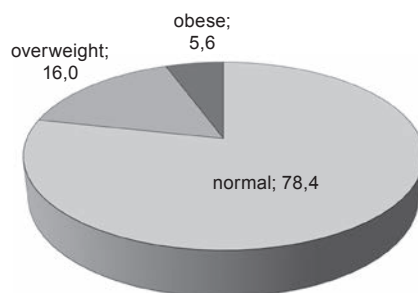

Graph 1. The prevalence of BMI groups in selected sample of 7-year-olds

Table 2. Results of the independent samples *t* test between different BMI groups (*p* – level of significance)

	p 1-2	p 2-3	p 1-3
SPEED AND AGILITY	0.75	<b>0.04*</b>	<b>0.01*</b>
STRENGTH	0.99	<b>0.05*</b>	<b>0.02*</b>

Legend: 1 – normal weight, 2 – overweight, 3 - obese

By the independent samples *t* test's results some differences were found between the groups of subjects (Table 2). In the motor area of speed and agility, as well as in the strength area, significant differences were found between the *overweight* and *obese* ( $p=0.04$ ,  $p=0.05$ ), as well as between the *normal weight* and *obese* group of subjects ( $p=0.01$ ,  $p=0.02$ ).

## Discussion and conclusions

A considerable increase of typically sedentary behavior has been observed in the last decade. This phenomenon has not only been registered among adults, but in children as well. It is well known that such behavior is likely to be connected to a lack of motor functions and insufficient engagement in physical exercise programs. The consequences to such behavior have multiple outcomes: lower level of motor coordination, lower energy expenditure as well as the increase of overweight and obesity. Factors of overweight and obesity in contemporary way of life represent a great health risk, particularly in young age.

Under the classification suggested by Cole et al. (2000), in the current study seven children were considered obese (5.6%) and twenty overweight (16%). When comparing those results with the results obtained by Catenassi et al. (2007) it is possible to conclude that Croatian children have lower obesity prevalence than Brazilian children (18% obese, 15% overweight). However, the authors stay open-minded to suggest that culture may influence findings in this population. Different school systems, living environments and nutrition may be factors affecting body composition. Regardless, 21.6% overweight/obesity can be a cause for concern since the desired rate for youth is 5%. In addition, it is possible to conclude that obesity level in the selected sample is high since Cole et al. (2000) reported an obesity prevalence of 1 to 4% for ages 2-18.

Agility, as the ability to change directions and gain speed without losing motor control, is directly related to speed, balance and coordination skills. Children develop speed and agility at an early age but little is known of how the body composition affects its development. The results showed that the *normal weight* group of subjects obtained the best results in speed and agility. However, *normal weight* children do not significantly differ from the *overweight* children but differences were found between the *overweight* and *obese*, as well as between the *normal weight* and the *obese* group of subjects. Similar results were found in the motor area of strength as well. Significant differences were found between the *normal weight/overweight* and the *obese* group of subjects. These results point out to a fact that slightly increased BMI in children does not necessary impair their motor abilities performance. However, a serious BMI increase could affect children's agility, speed and strength and prevent their further motor development. A study of Wrotniak et al. (2006) clarifies these results. The authors found the faster that children completed the running speed and agility task and the farther they jumped (explosive strength), the more physically active and less sedentary they were. Since physical activity and sedentary behavior are one of the main factors of the level of body fat it is obvious that similar results were gained. In addition, it is possible that no differences between the *normal weight* and *overweight* group are the result of *normal weight* children's decreased muscle mass, or the *overweight* children's increased muscle tissue. Those reasons can be enlightened with the use of the skinfold thickness and muscle circumference measurements in the following researches.

Review of the literature revealed no significant relationship between the BMI and the fundamental motor skills (Catenassi et al., 2007). This and similar investigations reinforce the independence of performance in a task of fundamental

motor skill concerning body composition indicators. As opposed to fundamental motor skills, showing an equal potential of motor development for all children, not being restricted by body adiposity, it is clear that body composition characteristics effect motor abilities of speed and agility and strength. It is important to emphasize that most tests of fundamental motor skills are criterion-referenced instruments based on observational assessment and that they tend to focus on the qualitative aspects of each skill (what the skill looks like - technique) rather than on the outcome of the skill. On the other hand, tests for motor abilities assessment focus on the quantitative aspect of a skill (outcome of the performance). It is possible to conclude that children's severe body adiposity doesn't affect their motor skills technique but it certainly decreases their motor achievements.

Finally, although considered a good indicator for overweight and obesity, has wide application in educational system and is easily administered by physical education teachers, BMI has its limitations in the obesity identification. Therefore, it is suggested for future studies that skinfold thickness and muscle circumference measurements are added to provide more accurate data on the precise amount of body fat.

## References

1. Bruininks, R.H. and Bruininks, B.D. (2005). *Bruininks-Osretsky Test of Motor Proficiency – Second Edition*. Pearson, Minneapolis, MN.
2. Catenassi, F.Z., Marques, I., Bastos, C.B., Basso, L., Ronque, E.R.V. and Gerage, A.M. (2007) Relationship between body mass index and gross motor skill in four to six year-old children. *Revista Brasileira de Medicina do Esporte*, 13(4), 227-230.
3. Cole, T.J., Bellizzi, M.C., Flegal, K.M. and Dietz, W.H. (2000). Establishing a standard definition for child overweight and obesity worldwide: international survey. *British Medical Journal*, 320, 1240.
4. Pinho, R.A. and Petroski, E.L. (1999). Body adiposity and level of physical activity in adolescents. *Brazilian Journal of Kinanthropometry and Human Performance*, 1(1), 60-68.
5. Wrotniak, B.H., Epstein, L.H., Dorn, J.M., Jones, K.E. and Kondilis, V.A. (2006). The relationship between motor proficiency and physical activity in children. *Pediatrics*, 118(6), 1758-1765.

## CHANGES IN MOTOR ABILITIES OF THE FIFTH GRADE PUPILS DUE TO A ONE-YEAR MODIFIED PHYSICAL EDUCATION PROGRAMME

Nevenka Breslauer<sup>1</sup> and Kamenka Živčić Marković<sup>2</sup>

<sup>1</sup>*Međimurje University of Applied Sciences in Čakovec, Croatia*

<sup>2</sup>*Faculty of Kinesiology, University of Zagreb, Croatia*

### Abstract

Main aim of the research was the analysis of the effects of a one-year modified physical education program, intensified with contents from athletics, on the development of motor abilities of the fifth-grade primary school pupils. The research was conducted on a sample of 100 fifth-grade pupils of primary schools in the Međimurje county who attended regular physical education classes (2 hours a week) (MZOS, 2006). Apart from the athletic contents prescribed by HNOS (*Croatian National Educational Standard*) the topics from levels 1 and 2 of athletic school were also used: basic running techniques (crouch start, sprint), middle distance running, cross country running, hurdles, relay racing, basic techniques of high and long jump, triple long jump, pole vault, basic throwing techniques, obstacle courses and relay games. At the beginning and end of the one-year programme the examinees were measured by 21 motor ability tests and 1 test for functional ability assessment. The obtained results indicate that the programmes modified with two hours of physical education classes, intensified by athletic contents, had a significant effect, and therefore also showed better results in almost all motor ability tests and the functional ability test in the final measuring.

**Key words:** *physical education, fifth grade, motor ability, track and field*

### Introduction

The field of physical education plays a unique role in harmonious development of pupils' anthropological features, due to its abilities and specific features. Very few children's activities have that form of biotic conditionality as physical exercise does, in the field of education outlined in physical education classes. During its growth and development an organism is most sensitive to the impact of various physical activities, which cause multiple changes in morphological features and improved functional-motor abilities (Neljak, 2002). This is the reason why one of the major PE components refers to permanent and systematic changes in the pupils' anthropological, i.e. morphological, motor and functional features (Breslauer, Delija & Bokor, 2005). Physical education classes, through their professional and planned implementation of the process of physical exercise, influence the development of motor abilities, which increases the pupils' motor abilities in all activities. Therefore, the major aim of physical education classes is based on creating positive relationship of a pupil towards physical exercise and sport, as well as creation of a habit and need for regular body exercise and active life style (Kovač, Strel & Jurak, 2007, Živčić Marković & Breslauer, 2011).

Study of the influences of various physical education programmes on motor and functional abilities of pupils is one of most important lines of research in kinesiological science. The main aim of that research is based on improving the teaching and pupils' attitude toward physical exercise (Breslauer, 2007; Breslauer, Živčić & Nikolić, 2009, Morbitzer, 2005). The fact is that various physical education contents have various impacts on motor and functional abilities of every individual (Babin, et al., 2002; Morbitzer, 2005). This is the reason why it is important to establish the transformation power, or better to say, the contents that can influence the improvement of pupils' anthropological abilities.

The main aim of this research was the analysis of the effects of a one-year modified physical education programme, with intensified athletic contents, on the development of motor abilities of the fifth-year primary school pupils.

### Methods

The research was conducted on the sample of 100 fifth-year primary school pupils (boys), aged 11 years ( $\pm 6$  months), from the Međimurska County, who attended modified physical education classes intensified with athletic contents for 45 minutes twice a week. The modified program included at least two topics from the field of athletic movements, which also contained, apart from the athletic contents prescribed by HNOS (*Croatian National Educational Standard*) (MZOS, 2006), the topics from 1 and 2 level of athletic school: basic running techniques (crouch start, sprint), middle distance running, cross country running, hurdles, relay racing, basic techniques of high and long jump, triple long jump, pole vault, basic throwing techniques, obstacle courses and relay games. Apart from the differences in teaching contents, the differences in programmes were manifested only in the total number of teaching topics (41 instead of 31), whereas

the weekly (2) and yearly number of periods (70) and the number of teaching topics per a period (3) were the same as in regular physical education classes.

For the purpose of efficient testing of the conducted programme, motor abilities of the fifth-grade primary school pupils were assessed by means of 22 measuring instruments, which were selected based on the research of the motor space structure (Findak et al., 1996.): standing long jump (cm) – FESDM; throwing a medicine ball from a supine position (dm) – FEBML; standing start sprint 20 metres (s) – FE20V; sit ups in 60 seconds (no.) – RSDTL; bench sit ups in 60 s (br.) – RSDTK; push ups from the kneeling position (no.) – RSSUK; hang time with flex (s) – SCVIS; beck legs hanging position (s) – SCINS; forward right leg hanging position (s) – SCPND; obstacle course backwards (s) – REPOL; crawling through and jumping over (s) – BKPOP; climbing up and down the bench and wall bars (s) – BKPIS; hand tapping in 15 s (no.) – BFTAP; foot tapping in 15 s (no.) – BFTAN; foot tapping against the wall in 15 s (br.) – BFTAZ; touch-toe with feet spread (cm) – FLPRR; circumduction backwards with a bar (cm) – FLISK; sit and reach (cm) – FLPRK; rectangular run (s) – AGTUP; figure of eight with a bend (s) – AGOSS; side steps (s) – AGKUS; 6-minute run (m) – F 6. For the needs of this research, and in accordance with the set aim, the basic descriptive statistic parameters were calculated, and the normal distribution of variables tested by means of K-S test. To establish the quantitative changes between the initial and final state, which should happen due to the influence of experimental programmes, canonical discriminant analysis for quantitative changes under the difference model was applied. All obtained results are calculated by means of the *Statistic 5.0.* statistic package.

## Results

The results in Table 1 show that the arithmetic mean values in final measuring were higher in all motor tests. So, physical education classes with intensified athletic contents, two periods twice a week, resulted in an increase in average results for all selected motor tests. Minimum and maximum results of the initial and final measuring for most tests show improvement, which confirms that the modified physical education programme intensified by athletic contents brought positive changes in most motor abilities, assessed by motor - functional tests. The only exception was the results obtained in *RSSUK* test, which showed lower maximum result in the final measurement. The results of the K-S test show that the obtained variable distributions statistically equal normal distributions. Only a few tests, i.e. *FE20V* and *RSDTK* show deviation from the normal distribution in initial and final measurements. The obtained symmetric distribution coefficients (*skewnis* –  $a_3$ ) point to the fact that all distributions are symmetric ( $a_3=0$ ). Curve coefficients (*kurtosis*) are also normally distributed for the majority of variables, at which distributions mostly tend to kurtosis ( $a_3<3$ ), i.e. heterogeneity of results.

Group centroids before and after the experiment were statistically significantly distant (Table 3), which confirms the hypothesis of the existence of real quantitative changes in multi-variant motor space under the influence of modified physical education classes with intensified athletic contents.

Looking at the size of changes for each of the variables individually (Table 2), a significant improvement in all motor variables can be noted, except in *FLISK* test ( $p=0.38$ ). It also indicates that the intensified athletic contents on all PE classes can influence the development of a number of motor abilities. The most significant changes are noted at the *BKPIS* test, i.e. the test for coordination assessment, as well as at *BFTAN* test, for assessing speed of alternating movements.

Out of 17 tests the analysis of which show changes *FESDM*, *FEBML*, *FE20V*, *RSDTL*, *RSDTK*, *SCVIS*, *SCINS*, *REPOL*, *BKPOP*, *BKPIS*, *BFTAP*, *BFTAN*, *BFTAZ*, *AGTUP*, *AGKUS*, *AGKUS* and F6, 10 of them indicate the positive direction of the discriminant function structure, and 7 tests have significant negative connection. What should be mentioned is that it is the tests with negatively scaled results, which give positive contribution. Significant orthogonal projections to discriminant function are noted at all indicators of explosive strength, with the largest influence of *FESDM* (.39) and *FEBML* (.37) tests.

In the space of repetitive strength, the variables on the positive direction of discriminant function structure show high correlation with the discriminant function – significant good orthogonal projections for *RSDTL* (.36) and *RSDTK* (.27) tests are noted. In the area of static strength, significant orthogonal projections to discriminant function have *SCVIS* (.29) and *SCINS* (.28) tests. Endurance test F6 has positive projection to discriminant function (.32). High correlation with the discriminant function have the tests for movement frequency assessment - *BFTAN* (.53), *BFTAZ* (.44) and *BFTAP* (.38). Negative correlations with the discriminant function have the tests that cover the coordination space, mostly *BKPIS* (-.50), *REPOL* (-.28) tests, as well as the agility assessment tests *AGTUP* (-.44), *AGOSS* (-.33) and *AGKUS* (-.28).

Table 1. Basic central and dispersion motor variables parameters

Var	INITIAL							FINAL						
	AS	MIN	MAX	SD	Skew	Kurt	Max D	AS	MIN	MAX	SD	Skew	Kurt	Max D
FESDM	150,44	103,75	193,75	21,51	-0,284	-0,418	,053	168,54	121,25	213,75	20,53	-0,037	-0,463	,067
FEBML	525,27	327,50	720,00	80,42	0,242	-0,292	,066	577,07	380,00	872,50	90,63	1,028	1,425	,128
FE20V	4,33	3,53	6,16	0,46	1,528	3,303	<b>,152</b>	4,05	3,36	5,16	0,32	1,173	2,624	,102
RSDDL	32,12	20,00	45,00	5,91	-0,172	-0,604	,088	37,09	25,50	47,00	5,22	-0,158	-0,702	,065
RSDDK	6,59	1,00	21,50	4,68	1,172	1,034	<b>,162</b>	10,40	1,50	26,00	6,17	0,666	-0,637	<b>,162</b>
RSSUK	25,29	2,50	55,00	11,27	0,349	-0,336	,085	28,07	6,50	49,00	8,48	-0,099	-0,013	,046
SCVIS	17,98	1,43	65,23	13,19	1,044	1,001	,106	25,91	2,36	89,82	15,85	1,490	3,162	,103
SCINS	21,86	3,22	48,05	11,72	0,374	-0,901	,116	31,89	9,79	51,02	10,44	-0,158	-1,145	,095
SCPND	21,07	4,20	48,01	11,27	0,546	-0,690	,088	24,59	6,69	48,53	9,44	0,539	-0,294	,096
REPOL	15,79	8,97	28,72	3,58	1,002	1,610	,087	13,95	9,03	21,10	2,49	0,550	0,021	,112
BFKOPF	16,95	11,56	26,04	3,25	0,902	0,510	,108	15,64	10,34	24,34	2,87	0,952	0,563	,123
BKPIS	31,97	24,03	54,69	4,52	1,491	5,514	,080	24,27	18,23	35,73	4,13	0,835	-0,034	<b>,135</b>
BFTAP	26,10	18,00	36,66	3,45	0,255	0,842	,080	28,84	22,33	38,66	2,61	0,437	1,286	,071
BFTAN	17,18	13,75	20,75	1,47	-0,084	-0,382	,065	19,04	16,00	22,75	1,53	0,040	-0,663	,080
BFTAZ	17,61	13,25	22,50	1,79	-0,081	0,065	,075	19,54	15,00	23,50	1,68	-0,077	0,458	,120
FLPRR	50,34	29,00	73,00	10,31	-0,150	-0,613	,068	52,00	34,66	83,66	9,21	0,500	0,405	,058
FLISK	73,21	42,66	110,00	13,62	0,365	1,028	,109	72,33	34,33	102,33	12,35	-0,109	0,346	,079
FLPRK	37,22	20,66	48,33	5,67	-0,662	0,629	,079	38,98	21,33	53,00	6,71	-0,433	-0,070	,073
AGTUP	14,70	11,99	18,96	1,48	0,682	0,440	,114	12,85	10,17	17,21	1,45	0,107	-0,240	,087
AGKUS	12,63	9,20	17,45	1,87	0,319	-0,552	,086	11,53	9,29	15,00	1,15	0,479	-0,081	,082
AGOSS	11,08	8,71	17,19	1,43	1,554	3,823	,126	10,15	8,19	13,55	1,03	0,756	0,651	,080
F6 I	1038,1	600,00	1350,0	165,57	-0,210	-0,602	,074	1163,30	800,00	1400,00	136,55	-0,60	-0,266	,111

Legenda: AS – arithmetic mean value, MIN – minimum result, MAX – maximum result, SD – standard deviation, Skew – distribution asymmetry, Kurt – kurtosis, Max D- K-S test for significance of normal result distribution. **KS test value =0,134**

Table 2. Results of canonic discriminant analysis under the difference model

VAR	AS1	AS2	AS2-AS1	F	p	bDF	rDF
FESDM	150,45	168,55	18,10	108,55	0,00	0,02	0,39
FEBML	525,28	577,08	51,80	93,15	0,00	0,01	0,37
FE20V	4,34	4,05	-0,28	58,62	0,00	-0,71	-0,29
RSDDL	32,13	37,09	4,97	87,88	0,00	0,12	0,36
RSDDK	6,60	10,41	3,81	52,10	0,00	0,10	0,27
RSSUK	25,30	28,07	2,78	6,05	0,02	0,00	0,09
SCVIS	17,98	25,91	7,93	56,97	0,00	0,04	0,29
SCINS	21,87	31,90	10,03	55,25	0,00	0,05	0,28
SCPND	21,08	24,60	3,52	9,32	0,00	0,00	0,12
REPOL	15,80	13,95	-1,84	53,28	0,00	0,19	-0,28
BFKOPF	16,96	15,64	-1,31	32,72	0,00	-0,01	-0,22
BKPIS	31,97	24,27	-7,70	176,24	0,00	-0,16	<b>-0,50</b>
BFTAP	26,10	28,85	2,74	99,43	0,00	0,26	0,38
BFTAN	17,18	19,04	1,86	192,51	0,00	0,57	<b>0,53</b>
BFTAZ	17,61	19,55	1,93	134,64	0,00	0,69	0,44
FLPRR	50,34	52,00	1,66	4,38	0,04	0,03	0,08
FLISK	73,21	72,33	-0,88	0,79	0,38	0,01	-0,03
FLPRK	37,23	38,98	1,76	10,46	0,00	0,08	0,12
AGTUP	14,71	12,85	-1,85	132,12	0,00	0,20	-0,44
AGKUS	12,63	11,53	-1,10	56,02	0,00	-0,14	-0,28
AGOSS	11,08	10,16	-0,93	74,03	0,00	0,09	-0,33
F6_I	1038,11	1163,30	125,19	73,59	0,00	0,00	0,32

Legenda: AS1 and AS2- arithmetic mean values of first and second measurement; AS2-AS1- difference of arithmetic mean values of first and second measurement; F – univariate F- test; p – F-test significance level (bold values are statistically significant); bDF – set of parallel projection discriminant function - ponderers); r DF- discriminant function structure (orthogonal projections- correlations)



Table 3. Results of the test for significance of discriminant function

	D2	df1	df2	F	p
DF	6,96	22	78	24,95	0,00

Legenda: D2- distance ,df1- degrees of freedom, df2-degrees of freedom, F- value, P-statistic significance

## Discussion and conclusion

Compared to the research conducted on the identical population of Austrian, Greek, German and Finnish schoolboys (Morbitzer, 2005) and comparing the mean values of identical motor tests the following can be established: in the *functional ability* test F6 there is no significant difference in results among the examinees from this research and German examinees (1163/ 1160 m), Greek and Austrian examinees obtained lower results (1112, 1129 m). The results of *standing long jump* test show that the examinees from this research and German examinees have almost identical results (168/167 cm), the results of Greek examinees are slightly lower (160 cm), whereas Austrian examinees obtained higher values (173 cm). The mean results of *20 m run from the standing start* test show identical relation between the examinees from this research and German examinees (4,05/4,04 sec.), whereas Greek and Austrian examinees obtained better results (3,95/3,94 sec). The results of touch-toe with feet spread test, compared to the Finnish and German examinees show hardly any difference (FIN- 54,7 cm; D- 52,2 cm, CRO 52 cm), although the Finnish examinees show a little better results. Generally, the discriminant function for the measured group of pupils is formed by the abilities for which on the one hand mechanisms for excitation duration, as well as the mechanisms for so called synergic regulation and tonus regulation are responsible, and on the other hand, partially, the mechanisms responsible for movement structuring and excitation intensity, i.e. motor abilities: explosive strength, static strength, repetitive strength, movement frequency, coordination, agility and functional endurance.

Regarding the fact that natural forms of movement are less and less represented in everyday life, children should be first of all, taught to walk, run, jump and throw in the correct way, i.e. they should be taught about natural forms of movement, which is possible by means of the contents from athletics. This statement has been confirmed by this research. Modified PE classes intensified with athletic contents contributed to significant improvement of the selected motor abilities among the fifth-grade primary school pupils, observed in this research. Bearing in mind the significant impact of doing exercise on pupils' motor and functional abilities, we are becoming aware of the importance of primarily physical education classes at school, physical activity at school and out of school, as well as its influence on the development of functional and motor abilities. Therefore, it can be stated that the modified programme with two periods of physical education classes intensified with athletic contents has a significant impact and resulted in better results in almost all motor ability tests and the test of functional ability in the final measuring.

## References

- Babin, J., Katić, R., Ropac, D. & Bonacin, D. (2001). Effect of specially programmed physical and health education on motor fitness of seven-year old school children. *Collegium Antropologicum*, 25 (1), 153-165.
- Breslauer, N. (2007). Utjecaj monostrukturne aktivnosti u nastavi tjelesne i zdravstvene kulture na kvantitativne i kvalitativne promjene motoričkih sposobnosti. (Unpublished doctoral dissertation, University of Zagreb). Zagreb: Faculty of Kinesiology, University of Zagreb.
- Breslauer, N., Živčić, K. & Nikolić, I. (2009). Utjecaj različitih programa tjelesne i zdravstvene kulture na motoričke sposobnosti učenika 5. razreda. Proceedings Book of 3<sup>rd</sup> International Scientific Conference, Opatija, 2002, "Kinesiology – New Perspectives" (pp. 49-56). Zagreb: Faculty of Kinesiology, University of Zagreb.
- Breslauer, N., Delija, K. & Bokor, I. (2005). Relations between anthropological characteristics and performance in school athletics of girls involved in extracurricular sporting activities. Proceedings Book of 4<sup>th</sup> International scientific conference on kinesiology, Opatija, 2005, „Science and Profession - Challenge for the Future“ (pp. 94-97). Zagreb: Faculty of Kinesiology, University of Zagreb.
- Findak, V., Metikoš, D., Mraković, M. & Neljak, B. (1996). Primjenjena kineziologija u školstvu – NORME. Zagreb: Faculty for physical education, University of Zagreb.
- Kovač, M., Strel, J. & Jurak, G. (2007). Telesni in gibalni razvoj, življenjski stil in športna dejavnost slovenskih otrok in mladine – vzhodna Slovenija. Ljubljana : University of Ljubljana Faculty of sport.
- MZOŠ (2006). Nastavni plan i program za osnovnu školu. Zagreb : Ministarstvo znanosti, obrazovanja i športa. Retrieved march 5, 2011 from: /http://www.mzos.hr.
- Morbitzer, T. (2005). Die motorische Leistungsfähigkeit österreichischer Kinder im internationalen Vergleich - Eine Betrachtung von institutionellen und schulsportlichen Rahmenbedingungen, Testinstrumentarien und Testdaten. (Unpublished doctoral dissertation, Universität Stuttgart). Stuttgart: Institut für Sportwissenschaft, Universität Stuttgart.
- Neljak, B. (2002). Validacija planova i programa nastave tjelesne i zdravstvene kulture. (Unpublished doctoral dissertation, University of Zagreb). Zagreb: Faculty of Kinesiology, University of Zagreb.
- Živčić Marković, K. & Breslauer, N. (2011). Opis nastavnih tema i kriteriji ocjenjivanja – tjelesna i zdravstvena kultura u razrednoj nastavi. Zagreb: LIP PRINT.

## SPEED OF CRAWLING IN 4- TO 5 – YEAR OLD CHILDREN

Urška Čeklič<sup>1,2</sup>, Matej Plevnik<sup>2</sup> and Rado Pišot<sup>1,2</sup>

<sup>1</sup>University of Primorska, Science and Research Centre of Koper, Institute for Kinesiology Research, Slovenia

<sup>2</sup>University of Primorska, Faculty of Education Koper, Department of Primary School Teaching, Slovenia

### Abstract

Crawling is a fundamental motor pattern that assures: first child movement, first experience in balance, stimulation of tactile sensors development and exercise hamstring muscles. This study presents the results of a longitudinal study in which we observed 107 four and five year old children's speed of crawling in relation to morphological, vertical jump, and climbing changes. Furthermore, a qualitative analysis was performed to explain crawling technique they use. We hypothesized that in one year children will improve climbing performance, vertical jump with higher magnitude than in speed of crawling. We found significant improvements in all parameters: time of crawling ( $P < 0.05$ ), time of climbing, vertical jump and muscle mass ( $P < 0.001$ ). We obtained the biggest improvement in vertical jump (46%;  $P < 0.001$ ), time of climbing (30%;  $P < 0.001$ ), muscle mass (16%;  $P < 0.001$ ) and time of crawling (1%;  $P < 0.05$ ). As we expected, children improved less in the time of crawling, but the date were also significant. The reasons can be traced to the movement patterns of children who are increasingly focused on movements in the upright position. As well, the problem is in growing sedentarizem amongst children.

**Key words:** *climbing, vertical jump, development changes, muscle mass*

### Introduction

In order to understand child development, it must be observed and monitored from early age. Development is conducted in several areas, which are linked with each other. Therefore, a child is always observed holistically, in terms of physical, cognitive, emotional and social development (Videmšek and Pišot, 2007). Elementary motor patterns (EMP) have an important role in child development because they enable the child to interact with the environment. EMP belongs to an organized series of related developments in a specific temporal-spatial sequence. When a child acquires a motor pattern, it makes it easier to learn another advanced pattern and upgrade it. However, the development is not always consistent. There are periods of discontinuity in child development (Adolph, Vereijken, and Denny, 1998; Adolph, Berger and Leo, 2010; Pišot and Planinšec, 2005). The following are some EMP: crawling, creeping, jumping, throwing, climbing, walking, running, lugging, pushing, etc. The EMP are the basis of each motor learning. If we use EMP in early childhood, that improves their movements in later phases of development. Therefore, EMP are perceived as phylogenetically conditioned and inborn (Gallahue & Ozmun, 2005).

Crawling is one of the EMP, which allows the child to move independently before they start walking. Crawling plays an important role in the development of limb strength, balance and posture (Adolph et al. 1998; Adolph, 2003). During the crawling a pattern of diagonal reciprocal synergies (opposite leg and arm), which allows to the child to move around the surface more effectively appears. In addition to the above mentioned advantages of crawling it also, guarantees to the child a body development and development of the proximal muscles of the torso. The acquired sample of crawling, later creeping, plays an important role in the upgrading of children's motor skills, such as spatial orientation, fear of heights, and postural stability (Freedland and Bertenthal, 1994). The experience with the crawling is not ranked among the outstanding physical only milestones, but also between the cognitive and performance milestones (Clearfield, 2010).

After the development of crawling and creeping, a child becomes intrigued with more complex movements, such as walking, running, jumping, climbing etc. Pistotnik (2002) has determined that climbing appears soon after the child has experienced crawling on hands and knees. For the child, climbing represents something mysterious and another way to research space around him. Other researchers (Herrewegen and Molenbroek, 2005) describe climbing as an activity where child use support points and equilibrant positions that helps him to move in different directions. They define many factors that affect the start of climbing in a child: age, child posture, weight, strength, character, length of arms and legs, traction and physical flexibility.

The aim of our research is to monitor longitudinally the child's progress in speed of crawling. In doing so, we took into account the progress of other variables (speed of climbing, morphological characteristics of children and counter movement vertical jump), and compared them with the speed of crawling. We hypothesized that children will improve climbing performance and vertical jump with higher magnitude than in speed of crawling.

## Applied method

The data we present has been collected in the on-going basic research project J5 - 2397 "Analysis of fundamental motor pattern skeletal muscle adaptation and sedentary lifestyle on Specific factors amongst 4 to 7 years old child", funded by the Research Agency of the Republic of Slovenia. Project sponsor, the University of Primorska, Institute of Kinesiology Research and responsible researcher of the project is prof. dr. Rado Pišot.

## Participants

The total sample includes 107 children (55 girls) from the kindergartens of the municipality of Koper (Slovenia). Children were collected according to the criteria of chronological age. They had to be born in 2005. Before starting the measurements we have obtained the consent of the National Medical Ethics Committee of the Republic of Slovenia and parental written consent. Children were measured for the first time in 2009 and secondly in 2010.

## Instruments

The measurement contained the morphological characteristics, such as body height, weight, and the muscle and fat mass, which were measured by bioimpedance (Bioscan 916S, Maltron UK). Also, we included measurements of the following parameters: height of counter movement vertical jump (CMVJ in cm) on the tensiometric force-ground plate (AMTI), time of climbing on 2.8m wall bars, and time of crawling reaching the distance of 8m. In addition to these above mentioned variables, also several qualitative criteria will be used in order to explain the compliance of crawling techniques, which appears in the sample. Height of CMVJ is measured three times, the time of crawling two times and time of climbing five times (at various intervals between the bars and angles wall bars). We always took into process the best result of climbing on wall bars with 15 cm spacing between boards.



Picture 1. Counter movement vertical jump (left), crawling (middle) and vertical climbing (right) of children.

## Data analysis

The data were analyzed by the statistic package SPSS 17.0 for Windows. We used the standard method of descriptive statistics, ANOVA for dependent variables, where we observed the progress of children under one year (age 5 years), and t-test for independent variables, where we found gender differences in various parameters. We normalized values for the time of crawling from the first and second measurements which was done in 2009 and in 2010 and the time of climbing from both measurements (2009, 2010). Values were normalized by natural logarithm. Risk level was defined at  $P < 0.05$ .

## Results

In Table 1 we present the descriptive results of measurements of children at the age of 5 years. In physical tests we could not confirm any statistical significant gender differences. We found higher muscle mass in boys ( $P < 0.001$ ). Furthermore, girls have higher time of crawling and jumping height, but just above the border of statistical significance.

Table 1. Differences between genders in 5 years old children

	All	Boys	Girls	P <sub>gender</sub>
Crawling time (s)	15.2 ± 5.0	14.4 ± 4.6	16.1 ± 5.2	0.687
Climbing time (s)	12.8 ± 7.8	12.2 ± 6.7	13.3 ± 8.7	0.498
Muscle mass (kg)	6.3 ± 1.1	6.8 ± 1.2	5.9 ± 0.9	< 0.001**
CMVJ height (cm)	13.2 ± 3.4	12.6 ± 3.1	13.9 ± 3.6	0.058

CMVJ, countermovement vertical jump; \*\* p<0.001

Table 2 shows the differences that have emerged in our sample of children after a period of one year. Children has statistically significant improved (p<0.001; p<0.05) in all parameters, but most in the vertical jump. Furthermore, children have progressed the least in the time of crawling (1%).

Table 2. Longitudinal progress in the period of one year

	4 years	5 years	Δ%	Effect size	P
Crawling time (s)	17.7 ± 9.8	15.2 ± 5.0	-1.1 ± 37.1	0.16	0.048*
Climbing time (s)	20.1 ± 11.2	12.8 ± 7.8	-30.3 ± 39.3	0.35	< 0.001**
Muscle mass (kg)	5.4 ± 0.9	6.3 ± 1.1	16.3 ± 7.3	-0.40	< 0.001**
CMVJ height (cm)	10.0 ± 3.1	13.2 ± 3.4	46.3 ± 62.2	-0.44	< 0.001**

CMVJ, countermovement vertical jump; \*\* p<0.001, \* p<0.05

## Discussion

In conclusion, our results show that children in a period of one year have significantly increased in all of the variables which we have discussed. Particularly they have progressed in the vertical jump measurement (46%; P < 0.001), time of climbing (30%; P < 0.001), muscle mass (16%; P < 0.001) and the least in their achieved time of crawling (1%; P < 0.05). Boys have progressed, more than girls, in the following variables: time of crawling (14.4 ± 4.6), time of climbing (12.2 ± 6.7) and in muscle mass (6.8 ± 1.2). On the other hand, girls had better results in the achieved high in the vertical jump measurements (13.9 ± 3.6), which was also statistically significant (P < 0.001).

If we elaborate the above mentioned results even further, than differences in the time of crawling when children are five, are still apparent, but no longer statistically significant. At the age of four, the differences between the gender during the crawling were statistically significant (Čeklić, Plevnik and Pišot, 2010). One reason is the fact that boys have a significantly higher values of muscle mass than girls. It is known that the muscle mass has a great importance in climbing (Herrewegen and Molenbroek, 2005) and in every child's first attempt of crawling. (Adolph et al., 1998; Adolph, 2003). Also in the later period of children's growing phase (preschool), crawling and other EMP are important part of every child game. Children while crawling develop individual muscle groups, which otherwise cannot be developed (eg biceps femoris). Furthermore, crawling represents an endurance exercise. The child is able to play for long time (for several hours), which in turn affects the child's aerobic exercise. The system of "child" works on the principle of homeostasis - the development of an appropriate load. This is crucial for child development (Rajtmajer, 1993a, b)

Furthermore, if we looked at improvements in the parameters separately, we can say that crawling improvements in a period of one year is minimal (1%). To the fact that children have made the least progress in time of crawling, can be attributed to the fact that children, when beginning to walk became more interested in higher areas, and trends in the prone position are no longer interesting. Children progress in the time of climbing in period of one year amounted to 30% which is statistically significant (p < 0.001). One reason behind such progress can be attributed to the development of motor ability, which appears in children that have enough movement in their normal life styles. The most important motor ability for the child normal motor development is its stability and coordination. With EMP, as crawling and climbing, we can develop stability and coordination in the best way. In both EMP, appears diagonal reciprocal innervations that allow to the child consistent movement in the environment. The last parameter which we used in the paper is the CMVJ. A CMVJ represents to a child more difficulties in coordinated movement, as a long jump. The reason is that children do not know how to coordinate the time and distance from the obstacle that he or she needs to overcome. The second problem is the movement of the extremities. The child that dose not use arms while jumping is not able to jump as high as the ones which use them and the jump movement is not as coordinated as the one in which the child uses his/her arms. Moreover, in all EMP the power of the limb has an important rule. As we used for example in crawling, there it was important to have more muscle tone in hamstrings and shoulders. The same applies for climbing performance and jumping. As we

know, the motor ability in the different movements is connected and always appears together. So, we cannot consider individually only one motor ability in the child movement.

At the end, we could summarize the results and conclude that children improve in the period of one year, their selected. Boys have better results in the time of crawling and climbing and have reached a larger progress in muscle mass. Where, girls improved more than boys in only one parameter – vertical jump. The fact that children have progress the least in time of crawling is a concern, because crawling is one of the first attempts that allowed to the child to move independently on the surface. It is therefore necessary to provide children with an adequate daily amount of physical activity, which should, in early childhood include as many natural forms of exercise. Therefore, we (parents, teachers) need to make sure that the children will have enough daily physical activities. Especially, if we want to improve their crawling ability, we have to stimulate them in more activities which are taken place on the floor/ground. It is of great importance to allow them surfaces where longer distances of crawling can be achieved. Long distance can improve their endurance capacity, which has an important role in daily activities, such as different children games.

## References

1. Adolph, K.E. (2003). Learning to keep balance. V Kail, V. R. (ur.), *Advances in child development and behavior, volume 30*, 1-40. Amsterdam: Elsevier.
2. Adolph, K.E., Berger, S.E., & Leo, A.J. (2010). *Developmental continuity? Crawling, cruising, and walking*, 1-13.
3. Adolph, K.E., Vereijken, B., & Denny, M.A. (1998). Learning to crawl. *Child Development*, 69 (5), 1299-1312.
4. Clearfield, M.W. (2010). Learning to walk changes infants' social interaction. *Infants Behavior and Development*, (2010), no. of Pages 11.
5. Čeklić, U., Plevnik, M., & Pišot, R. (2010). Analiza elementarnih gibalnih vzorcev – plazenja, 4-letnih otrok [Analysis of elementary movement patterns observed in 4-year-olds while crawling]. V R. Pišot, V. Štemberger, B. Šimunič, P. Dolenc in R. Malej (ur.), prispevki 6. Mednarodni znanstveni in strokovni simpozij *Sodobni pogledi na gibalni razvoj otroka [Contemporary views on the motor development of a child]* (str. 65-67). Portorož: Univerza na Primorskem: Znanstveno-raziskovalno središče Koper.
6. Freedland, R.L., & Bertenthal, B.I. (1994). Developmental changes in interlimb coordination: Transition to Hands-and-Knees Crawling. *Psychological Science*, 5(1), 26-32.
7. Gallahue, D.L., & Ozmun, J.C. (2005). Understanding motor development : infants, children, adolescents, adults. New York : McGraw-Hill Higher Education, London : McGraw-Hill.
8. Herrewegen, J., & Molenbroek, J. (2005). Children's climbing skills (Raziskovalno poročilo). Amsterdam: Jep Design.
9. Pistotnik, B., Pintar, S., & Pori M. (2002). Gibalna abeceda: naravne oblike gibanja v športni praksi. Ljubljana: Fakulteta za šport, Inštitut za šport.
10. Pišot, R., & Planinšec, J. (2005). Struktura motorike v zgodnjem otroštvu: motorične sposobnosti v zgodnjem otroštvu v interakciji z ostalimi dimenzijami psihosomatičnega statusa otroka. Koper: Univerza na Primorskem, Znanstveno-raziskovalno središče Koper, Inštitut za kineziološke raziskave, Založba Annales.
11. Rajtmajer, D. (1993a). Komperativna analiza rezultatov v teku na 400 m med dečki in deklicami starimi od 3,5 do 6,5 let. *Educa*, (6), 410-418.
12. Rajtmajer, D. (1993b). Razvijanje splošne aerobne vzdržljivosti pri mlajših otrocih. *Pedagoška obzorja*, (24), 28-34.
13. Videmšek, M., & Pišot, R. (2007). *Šport za najmlajše*. Ljubljana: Fakulteta za šport, Inštitut za šport.

## Acknowledgements

The authors want to express gratitude to the Public Research Agency of the Republic of Slovenia for funding the research project "Analysis of natural movement patterns and adaptation of skeletal muscles in some of the factors of modern life style of children between 4 and 7 ages". We are grateful to all children and their parents, who allowed us to carry out such an important project. At the end, we would like also to express our gratitude to other researchers and students who helped on the project.

## INFLUENCE OF SOME MOTOR ABILITIES ON THE BASIC GYMNASTICS SKILLS PERFORMANCE THROUGH THE LEARNING PROCESS

Sunčica Delaš Kalinski<sup>1</sup>, Petra Mandić Jelaska<sup>2</sup> and Almir Atiković<sup>3</sup>

<sup>1</sup>Faculty of Kinesiology, University of Split, Croatia

<sup>2</sup>Fitness club "Pink Panther", Kaštel Lukšić, Croatia

<sup>3</sup>Faculty of physical education and sport, University of Tuzla, Bosnia and Herzegovina

### Abstract

In order to determine the influence of some motor abilities on the performance of basic acrobatic elements of artistic gymnastics, in various stages of their acquisition, this study evaluated a sample of 44 first graders. ANOVA, with Fisher post hoc test, revealed significant differences in measured variables, at various stages of the learning process. Multiple regression analysis was used to assess the influence of some motor abilities on the gymnastics skills in all phases of the learning process. Results confirmed a statistically significant effect of predictor variables on all analyzed skills in the initial point of the learning process, on four skills in the transitive point of the learning process and statistically significant influence on two skills in the final point of the learning process. The percentage of explained criteria variability ranged from 43% to 64%. It can be concluded that the application of the proper kinesiological treatment, which results with higher level of learned skills, reduces statistical reliability of the influence of motor abilities on the performance of some skills.

**Key words:** motor skills, artistic gymnastics, first graders, ANOVA, acrobatics

### Introduction

According to the basic definition artistic gymnastics is a sport of aesthetically designed, acyclic movement structures, which are evaluated according to the previously prescribed convention of momentum, defined by the Code of Points. In order to learn hundreds, and possibly thousands of elements and their combinations (at six apparatus in men's gymnastics and on the four apparatus in women's gymnastics) it is indispensable to implement a process of motor learning. Numerous theories and studies about the motor learning process have been generated since the end of the 18th century. As a synthesis of many theories and analyzed aspects of the motor learning process Schmidt and Lee (2005) have defined it as a set of internal processes associated with practice and experience that lead to relatively permanent changes in an individual's ability in performing the motor task. According to the same authors, the ultimate goal of every motor learning process, particularly in sport, is to achieve the highest level of the skill - *automatization level*. With the aim of reaching *automatization level* of the skill, except proper application of "learning process" and accepting several factors (such as cognitive and conative characteristics, motivation, prior knowledge and difficulty of the task that is taught), the authors point out that achieving a certain level of knowledge demands a certain (as higher) level of motor abilities which stands out in the equation of sports specification. According to researches, it was found that best ranked gymnasts, for who is presumed that have the highest quality and highest level of gymnastic skills, have very high levels of almost all motor abilities (Faria and Faria, 1989). The importance of the high level of motor abilities is even more emphasized if perceived through the theories and reviews of the previous studies. According to these, *those who learn* and have a higher level of motor abilities are more capable to quickly reach the highest (*automatization*) level of the skill (Neljak, 2009).

Considering the presented facts it is obvious that the effect of motor abilities on the performance of motor skills in different stages of the learning process is not specified and explained. Such information would be very valuable for the process of motor learning.

The aim of this study was to determine the influence of motor abilities on the basic gymnastics skills performance at different stages of the learning process.

### Methods

The sample consisted of 44 first graders (schoolgirls) from Bijaći elementary school in Kaštel Novi, chronological age 7 years ( $\pm 0.5$  years). They attended an experimental kinesiological treatment 3 times a week for 45 minutes during 6 months. The program included a number of skills from the current curriculum and some gymnastics skills. Gymnastics skills were selected due to the material conditions of the school and according to schoolgirl's abilities and prior knowledge.

The sample of variables consisted of the variables that estimate motor abilities and from the variables of gymnastics skills. Motor abilities have been estimated with 10 motor variables: 6 that are usually applied in the school system and additional 4 which also estimate motor abilities and have a significant impact on the performance of gymnastic skills (Delaš, 2005). In accordance with the foregoing, selected motor abilities variables are: *hand tapping* (MTR) and *foot tapping on the wall* (MTAZ) for frequency of movement assessment; *sit-ups* (MPT) for repetitive power assessment; *standing long jump* (MSD) and *20 meters running from standing start* (M20M) for explosive power assessment; *pull-up hang hold* (MIV) for static power assessment; *straddle forward bent* (MPR) and *bent forward on a bench* (MPRK) for flexibility assessment and *polygon backwards* (MPN) and *step aside* (MKUS) for coordination assessment. Gymnastics skills have been represented with five basic acrobatic elements: *candle stick* (CS), “*bridge*” (BR), *forward roll* (FR), *backward roll* (BR) and *cartwheel* (CW). The levels of performance of these skills have been evaluated by five judges through the video, according to the prescribed criterias (Delaš Kalinski, 2009).

Descriptive statistic parameters (mean (AM) and standard deviation (SD)), the average correlation between test items (IIR) and the Cronbach alpha coefficient (C $\alpha$ ) have been calculated for all variables. Burt method of simple summation was used to calculate the total score for each skill in each measurement point. The analysis of variance (ANOVA) with Fisher post-hoc test has been used to determine the differences in measured variables at various points of the learning process. Regression analyses have been used to determine the influence of motor abilities on gymnastics skills in the initial, transitive and final point of the learning process.

## Results

Table 1. Descriptive statistic parameters (AM  $\pm$  SD) of gymnastics skills and motor abilities and their metric characteristics (IIR, C $\alpha$ ) determined in different stages of the learning process

	INITIAL POINT			TRANSITIVE POINT			FINAL POINT		
	AM $\pm$ SD	IIR	C $\alpha$	AM $\pm$ SD	IIR	C $\alpha$	AM $\pm$ SD	IIR	C $\alpha$
CS	2,93 $\pm$ 1,02***	0,85	0,96	3,63 $\pm$ 0,94	0,85	0,96	3,97 $\pm$ 0,73 <sup>3</sup>	0,76	0,93
BR	2,82 $\pm$ 1,24***	0,92	0,98	3,60 $\pm$ 1,11††	0,89	0,97	4,19 $\pm$ 0,73 <sup>3</sup>	0,68	0,89
FR	2,73 $\pm$ 0,84***	0,83	0,96	3,37 $\pm$ 0,70†††	0,76	0,93	4,03 $\pm$ 0,69 <sup>3</sup>	0,72	0,92
BR	2,48 $\pm$ 0,91**	0,81	0,95	3,01 $\pm$ 0,83†††	0,86	0,96	3,85 $\pm$ 0,74 <sup>3</sup>	0,79	0,94
CW	2,31 $\pm$ 1,15*	0,93	0,98	2,82 $\pm$ 1,15†	0,90	0,98	3,36 $\pm$ 1,02 <sup>3</sup>	0,91	0,98
MTR	15,20 $\pm$ 2,10***			20,47 $\pm$ 3,05††			21,94 $\pm$ 2,65 <sup>3</sup>		
MTAZ	12,39 $\pm$ 1,83*			13,27 $\pm$ 1,74††			14,39 $\pm$ 2,01 <sup>3</sup>		
MPT	19,77 $\pm$ 7,97***			25,95 $\pm$ 8,81			27,09 $\pm$ 9,01 <sup>3</sup>		
MSD	104,73 $\pm$ 16,63	0,82	0,93	107,67 $\pm$ 15,36	0,81	0,92	107,88 $\pm$ 13,64	0,70	0,87
M20M	5,53 $\pm$ 0,39***	0,74	0,88	5,20 $\pm$ 0,29†††	0,81	0,93	4,52 $\pm$ 0,33 <sup>3</sup>	0,81	0,93
MIV	13,92 $\pm$ 11,10			15,47 $\pm$ 11,21			12,46 $\pm$ 7,81		
MPR	53,06 $\pm$ 7,78	0,90	0,96	53,27 $\pm$ 6,97††	0,88	0,95	58,41 $\pm$ 10,40 <sup>2</sup>	0,97	0,99
MPRK	0,16 $\pm$ 5,18***	0,93	0,97	4,63 $\pm$ 4,76	0,92	0,97	5,35 $\pm$ 5,25 <sup>3</sup>	0,94	0,98
MPN	23,30 $\pm$ 4,57***	0,79	0,91	18,96 $\pm$ 3,83	0,87	0,94	19,35 $\pm$ 3,64 <sup>3</sup>	0,86	0,94
MKUS	15,34 $\pm$ 2,03***	0,90	0,96	14,17 $\pm$ 1,20	0,77	0,90	13,81 $\pm$ 1,01 <sup>3</sup>	0,63	0,83

Legend: One Way ANOVA with Fischer LMSD post-hoc test: \*p<0,05; \*\*p<0,01; \*\*\*p<0,001 – significant difference between initial and transitive measurement point; †p<0,05; ††p<0,01; †††p<0,001 – significant difference between transitive and final measurement point; <sup>1</sup>p<0,05; <sup>2</sup>p<0,01; <sup>3</sup>p<0,001 – significant difference between initial and final measurement point;

Variables legend: MTR - *hand tapping*, MTAZ - *foot tapping on the wall*, MPT - *sit-ups*, MSD - *standing long jump*, M20M - *20 meters running from standing start*, MIV - *pull-up hang hold*, MPR - *straddle forward bent*, MPRK - *bent forward on a bench*, MPN - *polygon backwards*, MKUS - *step aside*, CS - *candle stick*, BR - “*bridge*”, FR - *forward roll*, BR - *backward roll*, CW - *cartwheel*.

According to the results of ANOVA post-hoc Fisher test numerical increase in the average values of all skills (AS) can be determined between initial and transitive, and transitive and final point of the learning process. Differences between the average values of all skills between the initial and transitive measurement point have been determined. For four skills (BR, FR, BR and CW) statistical difference in average value was determined between transitive and final point of the learning process. Statistically significant differentiation between their initial and final point of the learning process, have been determined for all skills.

For all skills, from the initial to the final point, Cronbach Alpha coefficient ranged from 0.87 to 0.98 and IIR ranged from 0.68 to 0.93. In the area of motor abilities, increase of numerical value have been determined from initial to transitive and to final point of measurement for all variables except for the MIV (which hypothetically estimated static strength of

arms and shoulders). According to ANOVA results, increase of average results, through the learning process, have been determined as significant.

Table 2. Results of regression analysis between the set of predictor variables and criterion variables in initial, transitive and final point of learning process

	INITIAL POINT					TRANSITIVE POINT					FINAL POINT				
	CS	BR	FR	BR	CW	CS	BR	FR	BR	CW	CS	BR	FR	BR	CW
MTRR	0.17	0.01	0.07	-0.11	-0.01	-0.06	0.11	0.06	0.04	0.04	0.36	0.33	0.20	<b>0.47*</b>	-0.23
MTAZ	-0.12	-0.03	-0.01	0.13	0.07	-0.09	-0.05	-0.26	-0.20	-0.16	-0.05	0.05	-0.23	-0.31	0.14
MPT	<b>0.34*</b>	0.06	0.28	<b>0.39*</b>	0.25	0.30	0.10	0.19	0.14	0.11	0.17	-0.10	0.18	0.19	0.21
MSD	0.18	-0.13	0.05	0.24	0.17	0.01	-0.13	0.08	0.13	0.06	0.35	0.21	0.26	<b>0.43*</b>	0.09
M20M	-0.32	-0.10	-0.27	-0.27	-0.26	-0.28	-0.01	-0.29	-0.13	-0.30	0.20	0.21	0.36	<b>0.44*</b>	-0.22
MIV	0.28	0.24	0.21	0.08	0.00	0.10	0.14	0.26	0.19	0.14	0.16	0.09	0.13	0.28	0.10
MPRK	-0.14	0.16	0.25	0.20	0.32	-0.06	0.26	-0.09	0.04	<b>0.44*</b>	-0.39	0.11	-0.14	-0.21	0.10
MPR	0.03	0.12	-0.21	-0.06	0.01	-0.09	-0.03	0.13	0.00	-0.04	0.18	0.21	0.06	0.10	0.06
MPN	-0.03	-0.29	-0.05	-0.01	0.03	<b>-0.40*</b>	-0.30	-0.09	<b>-0.40*</b>	-0.04	-0.16	-0.25	-0.15	-0.23	-0.29
MKUS	-0.08	-0.33	-0.01	-0.13	-0.05	-0.02	-0.36	0.08	-0.02	-0.18	0.22	0.31	0.10	0.25	-0.10
R	0.73	0.71	0.67	0.76	0.67	0.72	0.67	0.58	0.71	0.80	0.55	0.56	0.40	0.66	0.72
R <sup>2</sup>	0.53	0.51	0.45	0.58	0.44	0.52	0.45	0.33	0.51	0.64	0.30	0.31	0.16	0.43	0.51
p	0.00	0.00	0.01	0.00	0.02	0.00	0.02	0.14	0.00	0.00	0.22	0.18	0.78	0.02	0.00

\*statistically significant coefficients  $p < 0, 05$

Variables legend: CS - candle stick, BR - "bridge", FR - forward roll, BR - backward roll, CW - cartwheel, MTR - hand tapping, MTAZ - foot tapping on the wall, MPT - sit-ups, MSD - standing long jump, M20M - 20 meters running from standing start, MIV - pull-up hang hold, MPR - straddle forward bent, MPRK - bent forward on a bench, MPN - polygon backwards, MKUS - step aside

The results of multiple regression analysis between the set of motor variables and criterion variables *candle stick* (CS), *bridge* (BR), *forward roll* (FR), *backward roll* (BR) and *cartwheel* (CW), in initial, transitive and final point of the learning process, are presented in Table 2. The results obtained revealed that the applied set of motor variables has an impact on all criterion variables in the initial point of the learning process. It was found that values of correlation between the predictor variables, described by multiple correlation coefficient, with all criteria variables range from 0.67 to 0.73, that is that a set of motor variables, as predictors, explain between 44% and 58% variance of criterion variables (R<sup>2</sup>). It can be determined that MPT has a statistically significant effect on the criterion variables *candle stick* (CS) and *backward roll* (BR).

In the transitive point of the learning process statistically significant influence of all predictor variables have been determined on the *candle stick* (CS), *bridge* (BR), *backward roll* (BR) and *cartwheel* (CW). The values of coefficients of multiple correlations between the set of predictor and criterion variables (R) ranged between 0.67 and 0.80, while the percentage of variance ranged from 45% to 64%. MPN had a significant influence on the criterion variables *candle stick* (CS) and *backward roll* (BR) while MPRK was a significant predictor for *s cartwheel* (CW). Statistically significant influence of applied set of motor variables has not been determined for the *forward roll* (FR).

In the final point of the learning process the applied set of motor variables had a statistically significant effect on the *backward roll* (BR) and *cartwheel* (CW). MTR, MSD and M20M had statistically significant influence on the variable *backward roll* (BR). The influence of the set of predictor variables on all other criterion variables (CS, BR and FR) was not determined.

## Discussion and conclusions

Summarizing the results of the ANOVA, for variables that assess motor abilities and basic acrobatic elements from the field of artistic gymnastics, it is possible to conclude that statistically significant differences were found in the results of majority of analyzed variables from the initial to the final point of the learning process. Such results suggest that the applied treatment had a positive impact on the increase of the motor abilities level, but also on the increase of the level of performance of the basic acrobatic elements. Statistically significant influence of the MPT on the *candle stick* (CS) and *forward roll* (FR), in the initial point of the learning process, is considered logical and expected if the structure of the performance of these criterion variables is perceived. The strength of the abdominal muscles is important in retaining the position of *candle stick* but also in lifting and holding legs in a pike position during the rolling - the key stage in performing *backward roll*. Results from the transitive point of the learning process can be explained through the characteristics of



artistic gymnastics as a sport. In artistic gymnastics the goal, and one of the criteria for evaluation of gymnast's skills, is to perform many parts of one skill and/or many skills as one routine with a wide range of movement. In the final point of the learning process, the entire set of predictor variables was identified as important for the performance of *cartwheel* and confirmed the complexity of this skill. For the performance of *backward roll* the importance of dynamic performance (which can be observed through the synergy of the variables that hypothetically estimate the frequency of movement and explosive leg strength) was determined as statistically significant.

Summarizing all results of the regression analysis at various points of the learning process, it is possible to conclude that the influence of motor variables on skill performance was reduced through the process of motor learning. At the end of the learning process the impact of predictors remained statistically significant only for those skills that were determined as "difficult" to learn and probably more complex than others (Delaš, 2009). Skills that are determined as structurally easier to learn, and which have been learned at a higher level in the earlier stages of the learning process, have become independent from motor abilities as opposed to the more complex motor skills.

The obtained results confirm the results of previous studies (Faria and Faria, 1989) which determined that better performance of gymnastic skills requires higher level of motor abilities. At the same time results of the study's lead to the conclusion that the application of adequate kinesiological treatment and high frequency of repetition of certain skill makes the impact of motor abilities on skills statistically insignificant.

## References

1. Delaš, S. (2005). *Relacije između nekih morfoloških karakteristika, motoričkih sposobnosti i stupnja usvojenosti motoričkih struktura iz sportske gimnastike u 6. razredu osnovne škole*. Magistarski rad). Zagreb: Kineziološki fakultet Sveučilišta u Zagrebu
2. Delaš Kalinski, S. (2009). *Dinamika procesa učenja motoričkih znanja iz sportske gimnastike*. (Doktorska disertacija). Zagreb: Kineziološki fakultet Sveučilišta u Zagrebu.
3. Faria, I. & Faria, E. (1989). Relationship of the anthropometric and physical characteristics of male junior gymnasts to performance. *J Sports Med Phys Fitness*, 29(4), 369-378.
4. Neljak, B. (2009). *Kineziološka metodika - Skripta za studente 6. Semestra*. Kineziološki fakultet Sveučilišta u Zagrebu. Zagreb.
5. Schmidt, R.A. & Lee, T.D. (2005). *Motor control and learning: a behavioral emphasis*. Human Kinetics.

## KINESIOLOGICAL PREVENTION - AN IMPORTANT FACTOR IN THE INTEGRATIVE POWER OF KINESIOLOGY

Vladimir Findak<sup>1</sup> and Ivan Prskalo<sup>2</sup>

<sup>1</sup>Faculty of Kinesiology, University of Zagreb, Croatia

<sup>2</sup>Faculty of Teacher, University of Zagreb, Croatia

### Abstract

Kinesiological prevention is one of the fundamental factors of the integrative power of kinesiology. Issues related to health, education, leisure, decline in motor and functional ability, etc., are universal and important issues dealt with by many scientific branches, including Kinesiology. The reasons for this are: 1) Global issues not covered by other sciences are the focus of interest of kinesiology. 2) In kinesiology it is necessary to constantly question the relationship between theory and practice, between the set and achieved goals, in other words, relationships between contemporary day and age and future. 3) The expected development of awareness of the need to exercise in the 21 century.

Kinesiology has the role of a scientific entity in the scientific community and professional entity in the professional community. Accordingly, constantly informing the public about scientific achievements in kinesiology and its applied fields is one of the fundamental conditions for improving the practice. Secondly, such an attitude toward the role of kinesiology in modern living and working conditions is not the result of kinesiological abstraction or kinesiological construction, but first-rate issue for the further development of kinesiological science and profession. Accordingly, in order for the integrative power of kinesiology to become more prominent in all of its applied fields, especially when it comes to the application of theoretical achievements in practice, in the mediation of new theoretical information and the extensive amount of practical knowledge, in addition to modern educational technology, an increased active participation of all those involved in any form of exercising process is essential. Specifically, this means that instead of the traditional teaching, training or recreational exercise, preference should be given to the methodological strategies that place the subjects of the teaching process, training process and the process of physical exercise in different methodological situations.

Problems associated with kinesiological prevention are extremely dynamic, i.e. there will be a need for continued efforts not only to modernize it, but also for more effective application in everyday life and work of our experts.

**Key words:** *Kinesiology, integrative power of Kinesiology, kinesiological prevention*

### Introduction

Speaking today at the start of the 21<sup>st</sup> century about the integrative power of kinesiology and kinesiological prevention as one of its fundamental factors is actually indicating the possible and necessary aggregates of the integrative power of our substrate science in contemporary living and working conditions.

Naturally, the question is why is it necessary just now, today, to raise the issues related to kinesiological prevention? Surely, there are a number of reasons; however, only three will be stated at this point.

First, we all live in a world and time in which the issues related to health, education, leisure, and decline in motor and functional ability, environmental protection, etc., are considered universal issues, and consequently important issues dealt with by many scientific branches, including Kinesiology. Accordingly, the logical question is, where in all this is the “place under the sun” for Kinesiology? Namely, in order for Kinesiology to hold (as it did during its formation) and maintain its integrative function in this age of growing globalization, it should focus on those key issues - problems that are not primarily dealt with by any other scientific discipline (although they may deal with some aspects of these issues). Therefore, the so called global issues that are not covered or dealt with by any other science should in the upcoming period be crucial empirical issues within the scope of Kinesiology, or better yet, the motto of all its future research.

Second, the activity of Kinesiology is the planned activity, therefore, it is necessary to constantly question the relationship between theory and practice, between the set and achieved goals, in other words, relations between today and tomorrow, and between present and future. It is rightly expected and demanded of all kinesiologists, because they have a great power to influence the anthropological status of those with whom they work. Moreover, the influence is so powerful that it can be confidently asserted that there exist no, or only few human activities in which such large number of characteristics, qualities and abilities can be simultaneously affected as by professionally conducted teaching, training, recreation or corrective exercise (Findak and Neljak, 2010).

And third, it should be expected that in the 21st century an awareness of the necessity of dealing with physical activity during one's entire life will finally prevail, of course, physical activity needs to be appropriate to the age, conditions and general social situation. We believe that everyone will understand that physical activity is a *conditio sine qua non* of human existence.

### What is kinesiological prevention

The fact is that kinesiological science has at its disposal increasing quantity of information, not only regarding the importance of kinesiological activity, but also ways in which certain kinesiological activities can effectively be conducted. Moreover, we believe that today the achievements in the field of kinesiology are at such a level which enables creating accurate models of organization and realization of exercise in all fields of applied kinesiology. Accordingly, it should be stated that kinesiological "products" are not only verified but also recognizable, and kinesiologists are rightfully expected and required to use, perfect and further research these "products".

In order to use, as efficiently as possible, and further improve what has been achieved, not only in kinesiology but in all areas of applied kinesiology, it is necessary, among other, to consider kinesiological prevention. To authors' knowledge, the syntagm has not yet been noted in kinesiological theory or practice, hence the question arises, what is kinesiological prevention?

**Kinesiological prevention** is a process which needs to be understood and accepted as an incentive link between possible and necessary procedures to be undertaken in order to efficiently apply kinesiological achievements in the areas of education, sports, kinesiological recreation and kinesitherapy.

When it comes to substrate science, among other, it means that kinesiology has the role of a scientific entity in the scientific community and professional entity in the professional community which, at the same time, enables it to be a corrective to the general public in a society. Accordingly, we should agree that constantly informing the public about scientific achievements in kinesiology and its applied fields is one of the fundamental conditions for improvements in practice. And secondly, such an attitude toward the role of kinesiology in modern living and working conditions is not the result of kinesiological abstraction or kinesiological construction, but first-rate issue for the further development of kinesiological science and profession.

Within the scope of education, it should be stated that, as long as physical exercise can be used to affect the transformation of the anthropological status of children, students and youth, it must be not only the basic orientation of physical education, but also the motto of all its objectives (Findak, 2009).

When it comes to sport (in the wider sense) the "door to the sport" should be wide open to all who are interested in sports, in other words, sport should not become or remain exclusive only to those "who can ..." (Beiner, 1996).

Although in the field of kinesiological recreation the trend of the so-called attractive exercise programmes is on the increase, a range of diverse and proven programmes that are adequate for a variety of human needs should be expanded and developed (Findak, Mraković, 1998).

According to everything mentioned above, it needs to be stated that the problems pertaining to kinesiological prevention are so important that all of us are not only expected but rightfully required to provide the right answers to all questions, including possible and necessary contribution of kinesiological prevention to the integrative power of kinesiology.

### Kinesiological prevention functioning as the integrative power of kinesiology

When it comes to kinesiological prevention functioning as the integrative power of kinesiology from a scientific point of view, it should be argued that it results primarily from the special role of the science and scientists in the contemporary society. In fact, in addition to pursuing new scientific knowledge, scientists must, today more than ever, use the existing and new fund of knowledge to shape and communicate to the society all the knowledge that is considered important for the progress of mankind.

Accordingly, in order for the integrating power of kinesiology to become more prominent than ever in all of its applied fields, especially when it comes to the application of theoretical achievements in practice, in the mediation of new theoretical information and the extensive use of practical knowledge with modern educational technology, increasing activation of participants involved in some form of the training process is essential. Specifically, among other things, this means that instead of the traditional teaching, training or recreational exercise, preference should be given to the methodological strategies that place the subjects of the teaching process, training process and the process of physical exercise in different methodological situations in which they can, for instance, exercise in the conditions that are identical or similar to real situation, thus they are learning by practicing. It is, therefore, the so-called active experiential learning that only happens in a situation or situations in which all participants are actively involved in all stages of learning a specific motor movement (Findak, 2003).

When it comes to kinesiological prevention function as integrative forces in the field of education, it is among other things manifested in two ways. First, physical and health education has increasingly significant developmental and compensational role in the lives of children, students and youth. On one hand, it stems from the contemporary living and working conditions of the youngest and young people which are, among other things, characterized by increasing physical inactivity, and on the other hand, it is important because of various effects of physical exercise on the growth and development of children, students and youth. And secondly, persuading children, students and young people that physical exercise is useful, while teaching physical education represents the highest degree of their competence and enables them to experience and accept physical exercise as a permanent value. Therefore, one of the strategic preventive goals of this school subject, in addition to affecting the anthropological status of students, is to contribute to students' adapting to physical exercise and forming a positive attitude about the value of physical exercise (Bretschneider et al., 2007; Findak, 2009, Kovač et al., 2007).

Function of kinesiological prevention in sport should also, among other things, be seen in two ways. First, we hold that in the upcoming period there will be even greater differentiation of participants in sport between those who are willing, at a high cost, even at the cost of health, to pursue good results (their number will decrease), and those (their number will increase) whose primary or sole objective is the preservation and promotion of health at the cost of sacrificing sports results and success. And secondly, in top sports, the competitive spirit remains the fundamental driving force and motivator for sports activities, which is positive as long as it does not exceed the boundaries. Therefore, kinesiological prevention should be further directed to ensure that everything happens while respecting moral norms and ethical principles, protecting the health of athletes and their human dignity, implementing fair play, and protecting the environment.

When it comes to the function of kinesiological prevention in the field of kinesiological recreation, it is manifested in the message that sport is for all and everyone, of course, according to personal preferences, interests, capabilities and individually set goals (Kovač et al., 2007). And secondly, the so-called new models of exercise should not be accepted unconditionally. On the contrary, the best way to confront the inappropriate, possibly dangerous so-called new models of exercise is to provide models of exercise that are based on the achievements of kinesiological science (Findak, Mraković, 1998).

Therefore, everything points to the conclusion that there is an objective need, not only for intensifying kinesiological prevention in all fields of applied kinesiology, but also for further research of the phenomena associated with kinesiological prevention, particularly in terms of its role in the integrative power of kinesiology. Accordingly, what remains is a permanent task for all of our professionals, regardless of their field of applied kinesiology, to become more involved in the direct application and implementation of the kinesiological prevention in their daily work with children, students, athletes and amateurs.

## Conclusion

Problems associated with kinesiological prevention are extremely dynamic, which means that there will be a need for continued and further efforts not only to modernize it, but also for more effective application in everyday life and work of our experts.

However, we find pleasure in the fact that the potential of kinesiological prevention in understanding the integrative power of kinesiology has finally been detected, and that we have become aware of what it is that we want and how kinesiological prevention should be implemented considering contemporary stage of development.

We believe this is a sufficient guarantee not only for a better future of kinesiological prevention, but also its possible and necessary contribution to the integrative power of kinesiology.

## References

1. Bretschneider, W., D., Naul, R. (2007). *Obesity in Europe: Young people's physical activity and sedentary lifestyles*. Sport sciences international (4). Frankfurt am Main: Peter Lang.
2. Beiner, K. (1996). *Freizeit und Sport*. Derendingen-Solothurn: Habegger.
3. Findak, V., Mraković, M. (1998). *Primijenjena kineziologija u sportskoj rekreaciji*. Zagreb: Fakulteg za fizičku kulturu Sveučilišta u Zagrebu, Hrvatski savez za sportsku rekreaciju „Sport za sve“.
4. Findak, V. (2003). *Metodika tjelesne i zdravstvene kulture*. Zagreb: Školska knjiga.
5. Findak, V. (2009). Kineziološka paradigma kurikula tjelesnog i zdravstvenog odgojno-obrtazovnog područja za 21. Stoljeće. *Metodika*. 10 (2) 371-382.
6. Findak, V., Neljak, B. (2010). Individualizacija rada u područjima edukacije, sporta, sportske rekreacije i kineziterapije. U: *Zbornik radova 19. ljetne škjole kineziologa Hrvatske* (V. Findak, ur). (str. 5-11). Zagreb: Ministarstvo znanosti, obrazovanja i športa, Hrvatski olimpijski odbor, Kineziološki fakultet Sveučilišta u Zagrebu.
7. Kovač, M., Jurak, G., Starc, G., Strel, J. (2007). *Šport ni življenski slogi slovenskih otrok ni mladine*. Ljubljana: Fakulteta za šport i Zbora društev športnih pedagogov Slovenije.

## VALIDATION OF THE SCALES FOR ASSESSING SWIMMING ABILITIES OF STUDENTS AT FACULTY OF HUMANITIES AND SOCIAL SCIENCES IN ZAGREB

Jelka Gošnik<sup>1</sup>, Natalija Špehar<sup>2</sup> and Ksenija Fučkar Reichel<sup>3</sup>

<sup>1</sup>Faculty of Humanities and Social Sciences, University of Zagreb, Croatia

<sup>2</sup>The Polytechnic of Zagreb, Croatia

<sup>3</sup>Faculty of Science, University of Zagreb, Croatia

### Abstract

The aim of this study is to validate two scales for assessing swimming abilities of undergraduate students. The scale 1 is divided in five categories according to Grčić-Zubčević (1996), while the new scale 2, based on Špehar, Gošnik and Fučkar Reichel (2010), consists of twelve questions, with the range of answers from 1 to 5 (don't know, weak, medium, good and very good), that students use to self-assess their swimming abilities. This research was conducted on a sample of 949 freshmen at Faculty of Humanities and Social Sciences in academic year 2010/11.

Multiple regression analysis shows high, statistically significant ( $p < 0,05$ ), level of correlation ( $R = 0,72$ ;  $p = 0,0000$ ) between two methods or scales for evaluation of swimming abilities of students. The beta coefficient demonstrates that statistically significant contribution to correlation provide variables 5, 6, 8, 9, 10, 11 and 12 (elaborated in section 4). This confirms the hypothesis that self-assessment of swimming abilities according to the scale 2 is a good predictor of results based on self-assessment based on the scale 1. In other words, the both scales are valid for evaluation of specific parameters.

**Key words:** *physical and health culture, metric characteristics and institution of higher education*

### Introduction

Course in Physical and Health Culture is a regular part of curriculum at Faculty of Humanities and Social Sciences at University of Zagreb. Educational Plan and Program that represents extension of preceding programs in elementary and high school guide this undergraduate course. Swimming as a crucial motor skill is a part of the basic program. It proposes mandatory examination of swimming skill for all 1<sup>st</sup> year students (freshmen) and sending non-swimmers to a swimming school appropriate for their age.

Systematic diagnosis of initial anthropological status of 1<sup>st</sup> year students at Faculty of Humanities and Social Sciences conducted via non-anonymous survey ten years in a row shows that self-assessment of swimming skills is not at an appropriately high level. "Can you jump on legs in a deep water and swim 50 meters using any technique? Circle YES or NO" was the selected question to evaluate swimming skill in adults. This question was specifically presented to freshmen during eight consecutive years. Surveys from 2002 to 2009 show that female students negatively assessed their swimming skill in the range from minimum of 15,9% in academic year 2008/09 to maximum of 31,9% in academic year 2007/08. Negative self-assessment for male students ranged from minimum of 10,5% in academic year 2008/09 to maximum of 22,7% in academic year 2007/08. According to Gošnik et al, (2010) this analysis shows rather negative self-evaluation of swimming skills in surveyed freshmen.

Study of Špehar et al., 2010, conducted on a sample of 1391 students from three different institutions of higher education shows a substantial numbers of non-swimmers and semi-swimmers among student population (36%). There is no statistically significant difference among students from different higher-education institutions, but there is relevant difference among different counties from where students originate and different genders.

Due to rather abstruse results from the survey of self-assessed swimming skills during academic years 2009/10 and 2010/11, we incorporated additional question based on criterion for assessing swimming abilities according to Grčić-Zubčević (1996). Based on results of 2009/10 survey, as well as feedback inputs from students and long-term experience of the authors, we can discern that used criteria for estimating swimming abilities were not the most fitting for students, but more appropriate for professional assessment and training of non-swimmers. Inside one category there are several parameters that need to be fulfilled, hence to students it is not obvious and sometimes hard to assess level of their swimming ability. Therefore, the authors propose another scale for assessing swimming abilities that was used along with the previous one during survey of freshmen in academic year 2010/11.

## The goal of research

The aim of this study is to validate and compare scale 1 for criteria of swimming ability that is divided in five categories according to Grčić-Zubčević (1996) and new proposed scale 2 (Špehar, Gošnik and Fučkar Reichel, 2010). Scale 2 consists of twelve points with spectrum of answers ranging from 1 to 5 (do not know, weak, medium, good, and very good) that students use while making self-assessment of their swimming abilities.

## Methods

### Sample of examinee

Undergraduate students at Faculty of Humanities and Social Sciences are selected as sample for this study. Survey conducted in July 2010 (during enrolment in the first year) encompassed 949 examinees.

### Method of data gathering

Freshmen completed non-anonymous survey containing 32 questions that included two analyzed in this study, along with other forms during enrolment period.

### Variables and data processing

#### *Predicative variables*

Predicative set of variables is defined via twelve statements specifying different levels of swimming abilities used for self-assessment. Statements are associated with five-grade scale, from 1 – don't know, to 5 – very good. The following 12 statements were included in this survey: floating, open eyes under water, swim in deep water, jump on legs and head, transition from horizontal to vertical position and back, dive, recover of items from the bottom, breaststrokes, freestyle, backstroke and dolphin.

#### *Diagnostic variables*

Diagnostic or criteria variables are represented in table containing grades for established level of swimming ability from 1 to 5. Described criteria on five-grade scale are: unadjusted, floater, semi swimmer, junior swimmer, and swimmer. Every category is detailed through several tasks described in Table 1. Regression analysis was applied to examine relation between two scales.

## Results and discussion

Table 1. Distribution (N) and percent of freshmen at Faculty of Humanities and Social Sciences during academic year 2010/11 grouped according to the scale 1 – level of swimming ability

SCALE 1 – levels of swimming ability	Grade	N	%
1. Enters water and floats – with assistance; can open eyes in water1.	1	24	2.52
2. Enters water independently; floats horizontally; glides through water, can use legs and hands; swim up to 10m in any manner; can make 3 consecutive inhales and exhales in water	2	190	19.94
3. Can jump in water; swim 10 to 25m in any manner with breathing; can make 10 consecutive inhales and exhales in water; can retrieve objects from bottom in shallow water	3	232	24.34
4. Can jump on legs into water; can swim 25m or more; can stay vertically in water for more than 10s; 10 consecutive inhales and exhales in water; can retrieve objects from bottom via diving on head	4	142	14.90
5. Can jump on head into water; can jump on head into deep water; swimming for 50m (25m breaststrokes and 25m backstrokes); maintaining vertical position in water by hand more than 10se; retrieve objects from deep bottom by diving with head down	5	361	37.88

Table 1. shows percent of answers in each category, 1 thorough 5, used in self-assessment of swimming abilities of students. A point for concern is that out of 949 freshmen 446 (47%) gave positive respond to first three catagories of answers that in general sense corresponds to categories of non-swimmers and semi-swimmers.

Table 2. Number of answers in each category (N) and the corresponding percentages grouped according to the scale 1 for self-assessment of swimming abilities from point 1 to point 12

SCALE 2 - claim	1 can not		2 weak		3 medium		4 good		5 very good	
	N	%	N	%	N	%	N	%	N	%
1. Can float (lay steady)	7	0.73	16	1.68	38	3.99	173	18.15	708	74.30
2. Can open eyes under water.	59	6.20	80	8.39	124	13.01	186	19.52	492	51.63
3. Can swim in deep water.	21	2.20	15	1.57	62	6.51	177	18.57	668	70.09
4. Can jump on legs.	20	2.10	18	1.89	64	6.72	134	14.06	710	74.50
5. Can jump on head.	130	13.64	131	13.75	176	18.47	152	15.95	353	37.04
6. Can switch between horizontal and vertical positions.	29	3.04	35	3.67	102	10.70	236	24.76	542	56.87
7. Knows to dive.	36	3.78	68	7.13	128	13.43	202	21.20	508	53.30
8. Able to retrieve objects from bottom.	65	6.82	67	7.03	138	14.48	213	22.35	457	47.95
9. Knows breaststrokes.	32	3.36	36	3.78	139	14.58	278	29.17	459	48.16
10. Knows freestyle.	85	8.92	116	12.17	244	25.60	197	20.67	299	31.37
11. Knows backstrokes.	62	6.51	95	9.97	223	23.40	259	27.18	302	31.69
12. Knows dolphin.	222	23.29	234	24.55	225	23.61	116	12.17	147	15.43

Table 3: Arithmetic mean ( $\bar{X}$ ), standard deviation (SD), frequency (N) of the results from the two analyzed scales of swimming abilities

Variable	N	$\bar{X}$	SD
Level of swimming ability	949	3.66	1.24
1	942	4.65	0.71
2	941	4.03	1.25
3	943	4.54	0.86
4	946	4.58	0.86
5	942	3.50	1.45
6	944	4.30	1.00
7	942	4.14	1.13
8	940	3.99	1.24
9	944	4.13	1.03
10	941	3.54	1.29
11	941	3.68	1.21
12	944	2.72	1.36

According to the scale 1 average self-assessed grade of swimming ability is 3.66 (Table 3.). The strongest correlation on this scale is found with statements 5, 6, 8 and 10 from the scale 2 that should comparable average grade of swimming ability (between 3,5 and 4,3).

Table 4. Beta coefficients and their significant inter-dependence for the two tested scales of self-assessment of swimming abilities.

Variable	Statistical parameters		
	b	t(848)	p
1. Can float (lay steady)	-0.02	-0.80	0.4226
2. Can open eyes under water.	0.03	1.04	0.2995
3. Can swim in deep water.	-0.01	-0.33	0.7448
4. Can jump on legs.	0.05	1.45	0.1476
5. Can jump on head.	<b>0.25</b>	7.95	0.0000*
6. Can switch between horizontal and vertical positions.	<b>0.16</b>	4.79	0.0000*
7. Knows to dive.	0.02	0.35	0.7233
8. Able to retrieve objects from bottom.	<b>0.16</b>	3.71	0.0002*
9. Knows breaststrokes.	<b>0.10</b>	3.23	0.0013*
10. Knows freestyle.	<b>0.16</b>	4.38	0.0000*
11. Knows backstrokes.	<b>0.09</b>	2.47	0.0135*
12. Knows dolphin.	<b>-0.06</b>	-2.15	0.0317*
<b>R= 0.72; R<sup>2</sup>= 0.52; F(12,897)=81.6; p=0,0000?</b>			

Multiple regression analysis (Table 4) shows a high, statistically significant ( $p < 0,05$ ) degree of correlation ( $R=0,72$ ;  $p=0,0000?$ ) between two analyzed methods for assessing swimming abilities of freshmen at Faculty of Humanities and Social Sciences during academic year 2010/11. The values of beta coefficient attest that statistically significant contribution to the correlation make variables 5, 6, 8, 9, 10, 11 and 12. This confirms thesis that self-assessed swimming ability according to the scale 1 is a good predictor of the results according to the scale 1. Thus, we can conclude that both scales provide us with appropriate methods for evaluation of considered parameters.

## Conclusions

Results of this study show that for self-assessment of swimming abilities among undergraduate students scale 1 is a useful measure overall comparable to new proposed scale 2. This is indicated by validation of results of these scales via multiple regression analysis.

Based on our professional experience we consider scale 1 to be more appropriate for an objective estimate. A grade on the scale 1 requires fulfillment of several criteria, while estimate based on scale 2 is simpler and more straightforward due to evaluation of every statement only by one criterion.

The fact that a significant number of students that can be categorized as non-swimmers or semi-swimmers is something that should certainly concern us. We could acquire more complete results during a test at swimming pool, however due to a sizable number of students, and obvious material and financial limitations that is not a feasible approach.

Swimming is a motor activity of high utility; hence we suggest that further effort should be placed to reduce percent of non-swimmers. In the present day modern society swimming ability should be considered something essential to every adult (especially to a student at institution of higher education if he or she did not master swimming at earlier age).

## References

- Gošnik, J., Sedar, M. (2010.). Procjena plivačke sigurnosti studenata/ica od 2002. do 2009. godine uzastopno i provjera znanja plivanja na Filozofskom fakultetu u Zagrebu u 2010. godini. U: V. Findak (ur.), Zbornik radova 11. hrvatskog savjetovanja o obuci neplivača, Orahovica, 2010. (37-38). Zagreb: Hrvatski savez sportske rekreacije.
- Grčić-Zubčević, N. (1994). Prijedlog eksperimentalnog učenja plivanja neplivača. U: V. Kapus (ur.), Zbornik radova 1. Slovenski posvet o učenju plivanja in varnosti pred utapljanjem, Murska Sobota.
- Grčić-Zubčević, N. (1997.). Praćenje i vrednovanje rezultata rada u obuci plivanja. U: Zbornik radova Ljetne škole pedagoga fizičke kulture Republike Hrvatske, Rovinj, 1997. (45-47). Zagreb: Savez pedagoga fizičke kulture.
- Grčić-Zubčević, N. (1998.). Prilog unapređenju nastave učenja plivanja. U: V. Findak (ur.), Zbornik radova 7. ljetne škole pedagoga fizičke kulture Republike Hrvatske, Rovinj, 1998. (64-66). Zagreb: Savez pedagoga fizičke kulture.
- Špehar, N., Gošnik, J., Fučkar Reichel, K. (2010.). Subjektivna procjena znanja plivanja studentske populacije. U: V. Findak (ur.), Zbornik radova 11. hrvatskog savjetovanja o obuci neplivača, Orahovica, 2010. (65-68). Zagreb: Hrvatski savez sportske rekreacije.
- Grčić-Zubčević, N. (1996.). Efikasnost različitih programa te mogući čimbenici uspješnosti učenja plivanja. (Doktorska disertacija). Zagreb: Fakultet za fizičku kulturu.



## DETERMINANTS OF ENJOYMENT AND PRESSURE AT PE LESSONS AMONG ELEMENTARY AND HIGH SCHOOL STUDENTS

**Zrinka Greblo and Renata Barić**

*Faculty of Kinesiology, University of Zagreb, Croatia*

### Abstract

The aim of the study was to explore the relation between goal orientations and experiences of enjoyment and pressure in PE setting. The findings indicated different correlation patterns among elementary and high school students. Comparing to their high school counterparts, elementary students reported significantly higher levels of task and ego goal orientations and higher levels of enjoyment during PE. Goal orientations explained 9% of variance of high school student's PE enjoyment and even 30% of variance of PE enjoyment in elementary school sample. The same predictors explained 5% of variance of pressure among elementary school students, but were insignificant predictors of PE pressure among older students. The findings illustrate necessity for further research of factors related to experience of pressure and enjoyment at PE lessons. Key words: Physical Education, goal orientations, children

*Key words: relation, goal orientations and experiences of enjoyment, pressure in PE setting*

### Introduction

Interindividual differences in behaviors, cognitions and affective states during PE lessons should not be seen only as a consequence of either high or low motivation for physical activity in general. Two very important factors which may direct PE outcomes in a (un)desired way are student's experience of pressure and enjoyment during PE class. Differences in enjoyment levels may arise as a product of individual experience with regard to teacher behaviors, demands or expectations (Hassandra, et al., 2003, Papaioannou, 1998) or as a reflection of different relations between peers who typically provide a significant framework for personal evaluation of failure or success during PE tasks (Hassandra, et al., 2003). Finally, those differences may occur as a result of specific achievement goals and tendencies (Weinberg, 2001).

According to Achievement Goal Theory (Nicholls, 1989; Roberts, 1992, 2001), variations in goal perspectives, i.e. different ways in which individuals evaluate their competence regarding success or failure in certain activity, influence individuals' motivation, achievement behaviors as well as their cognitive and emotional response to achievement settings (Biddle et al., 1996; Duda, 1993). There are two main reasons which indicate the need to further explore the relation between goal orientations and children's perception of enjoyment and pressure in PE setting. First, PE is a course which is directly related to promotion of active lifestyle. Even though there is a growing body of empirical evidence showing that sedentary lifestyle is a risk factor for development of metabolic disorders and obesity in children (Froberg and Andersen, 2005), the rate of physically inactive children in Croatia is rapidly growing (Jurakić and Pedišić, in press). In the context of healthy lifestyle promotion, identification of factors which are positively related to experience of enjoyment during PE classes may contribute to the easier development of healthy habits and to the improvement of student's lifelong physical and psychological wellbeing (Boreham and Riddoch, 2001). Second, due to its nature, many children love PE, but it is not the rule. According to Biddle (2001), for some students PE class represents best part of the entire school week, while for others it is a significant source of distress. Since PE is a mandatory course which can not be escaped, it is very important to determine factors correlated with perception of pressure which in turn is associated with higher levels of PE related anxiety (Barkoukis, 2007). In the context of PE related stress, identification of those factors represents a first step toward the reduction of negative psychological consequences which may arise because of specific comparative, competitive and evaluative PE features (Tremayne, 1995).

Empirical studies in PE and sport setting have shown that perceptions of enjoyment and pressure in those activities were associated with different achievement goal orientations (Barić, 2007; Boyd, Weinmann and Yin, 2000; Smith, Balaguer and Duda, 2001). Achievement goal orientations refer to a generalized tendency in defining success in sport, physical education or any exercise context (Biddle et al., 1996; Duda, 1993). Many contemporary studies consider it as an important predictor of different cognitive and affective patterns and behaviors related to exercise and sport. There are two different goal orientations. Task goal orientation is typical for a student who believes that the success depends on effort, interest and work. His/her sense of competence derives from performing at personal peak or from mastering skill. On the contrary, ego goal orientation is typical for students who are predominately oriented toward results achievement

and demonstration of their superior performance, who believe that the success depends on talent, luck or the nature of task and are primarily motivated to outperform others. According to previous studies in this field, task goal orientation is generally related to enjoyment while ego goal orientation is dominantly associated with perceived pressure (Barić, 2007; Boyd, Weinmann and Yin, 2000; Smith, Balaguer and Duda, 2001). However, results of recent studies call attention regarding generalization of those conclusions to other samples. Based on Urdan's (2004) finding about cultural differences in the effects of performance goals on achievement, the aim of our study was to verify the hypothesized relationship between different goal orientation pattern with enjoyment and pressure in PE setting among Croatian students.

## Methods

### Participants

The study was conducted on the sample of 261 elementary ( $N_{\text{boys}} = 122$ ,  $N_{\text{girls}} = 139$ ) and 333 high school students ( $N_{\text{boys}} = 189$ ,  $N_{\text{girls}} = 144$ ) from Zagreb, Croatia.

### Instruments and variables

In order to assess individual differences in goal orientations the Croatian version of *Task and Ego in Sport Orientation Questionnaire* (CTEOSQ, Barić and Horga, 2007; Duda et. al., 1995) was applied. CTEOSQ is consisted of two orthogonal dimensions, represented by task and ego goal orientation. Six items represent task orientation (i.e. 'I learn a new skill by trying hard') and seven items represent ego orientation (i.e. 'I can do better than my friends'). Two dimensions showed adequate reliability and validity in past researches in sport context (Barić and Horga, 2006). Cronbach's alphas in the current sample were 0.88 and 0.86 for task and ego subscales, respectively.

*Intrinsic Motivation Inventory* (IMI; McAuley et. al., 1989) was used to assess students' enjoyment and interest for PE (i.e. 'I enjoyed this sport activity very much'). Two items from original pressure/tension subscale were used to measure a feeling of pressure experienced at PE lessons (i.e. 'I feel pressured while practicing PE'). McAuley, Wraith, and Duncan (1991) recommended that redundant items could be eliminated from the IMI subscales, quoting that this should not influence reliability of the subscale. The Cronbach's alpha coefficients of such composed subscales in this study were 0.83 and 0.67 for enjoyment and pressure subscales, respectively.

The participants were asked to respond on a 5-point Likert-type scale, ranging from strongly disagree (1) to strongly agree (5). Students' goal orientations, levels of enjoyment and feelings of pressure were defined as mean values of the corresponding items.

### Procedure

All the participants filled out the questionnaires voluntarily. Before the measuring, teachers informed parents about the aims of the study and explained the measurement procedure. The informed consent from school principal and PE teacher were received. The data were collected in a group setting, prior or after a PE lesson. Anonymity and confidentiality of responses was guaranteed. Each student had a right to terminate participation in the study at any time, without consequences. The measurement took approximately 20 minutes on average and it was conducted by a psychologist.

## Results and discussion

The results obtained by ANOVA showed that boys and girls do not differ with regard to goal orientation patterns ( $F_{\text{task}} = 1.27$ ,  $df = 1$ ,  $p = 0.26$ ;  $F_{\text{ego}} = 2.45$ ,  $df = 1$ ,  $p = 0.19$ ). Further analyses revealed that that younger enjoy PE much better than older students. All students experienced similar level of pressure on PE lessons. Descriptive parameters of all variables are presented in Table 1.

Table 1. Descriptive parameters

	elementary school students (n=333)	high school students (n=261)	p
	M sd	M sd	
Task	4.05 0.84	3.41 0.89	.000
Ego	3.16 1.01	2.86 1.03	.000
Enjoyment	4.22 0.71	3.60 0.89	.000
Pressure	3.02 0.49	2.99 0.35	.568

At the average level, comparing to their high school counterparts, elementary students reported significantly higher levels of both goal orientations ( $F_{task}=78.27, df=1, p<0.00$ ;  $F_{ego}=12.53, df=1, p<0.00$ ) and enjoyment during PE lessons ( $F_{enjoy.}=56.19, df=1, p<0.00$ ). In view of the fact that motivation for physical activity in general decrease with age (Van Wersch, 1992; Jurakic and Pedisic, 2011) this finding is in line with our expectations. Lower levels of motivation and enjoyment in high school PE courses request additional strategies for improvement of student's motivation during PE lessons as well as teachers more active promotion of lifelong benefits from adopting physically active lifestyle. Competitive classes, negative experiences at PE lessons and lack of teacher support were identified as main barriers for regular physical activity among teenage population (Allender et al., 2006). Accordingly, in order to evoke positive student's experiences during PE lessons, high school teachers should especially pay attention to reduce potentially negative features of PE settings. Since play and fun are usually highlighted as primary motives for children's exercise and sport participation (Martins, 1979), we expected lower levels of perceived pressure among elementary school students. Contrary to our expectations, younger and older students did not differ according to the level of pressure experienced during PE lessons. One of the possible reasons underlying this finding might be that negative consequences of competitive setting and concerns about final PE grade are present even at the elementary school level, but before drawing final conclusions those hypothesis need empirical verifications.

Because of the obtained differences, further analyses were conducted for each age group separately. In order to determine the contribution of different goal orientation patterns to students' affective response to PE lessons, i.e. to their experience of enjoyment and interest as positive, and feeling of pressure and tension as negative emotional states, a serial of linear regression analyses was performed. According to Cognitive Evaluation theory (Ryan and Deci, 2000) enjoyment and interest can be considered as positive and feeling of pressure and tension as negative indicators of intrinsic motivation. The results showed that dispositional goal orientations can explain 9% of variance of high school student's enjoyment in PE lessons ( $R=0.31, F=13.94, df=2, p<0.00$ ) and even 30% of variance of enjoyment and interest for PE in elementary school students ( $R=.56, F=73.66, df=2, p<0.00$ ). Task goal orientation was a positive predictor of all students' enjoyment in PE, but its contribution was stronger in younger ( $\beta=.56, t=12.13, p<0.00$ ) than in older students ( $\beta=.31, t=5.21, p<0.00$ ). Our results are in the line with conclusions based on a large number of qualitative studies (Allender et al., 2006). The same authors stated that exercise and sport participation for young children are more enjoyable when children are not being forced to compete and win, but encouraged to experiment with different activities and develop their competences. When considering students' feeling of pressure and tension experienced during PE lessons, the result showed that only 5% of criterion variable variance could be explained by goal orientations in elementary school children. On the other hand, on the sample of high school students, goal orientations were not significant predictors of students' feeling of PE related pressure and tension. According to our results, in order to obtain enjoyment and interest regarding PE lessons and to reduce students' feelings of pressure, teachers should encourage development of task goal orientation and discourage the development of ego goal orientation, especially among elementary school children. Task goal orientation was identified as negative predictor of younger students' pressure ( $\beta=-0.21, t=3.84, p<0.00$ ), while ego goal orientation was a positive predictor of perceived PE related pressure ( $\beta=0.15, t=2.75, p<0.01$ ). The results are congruent to previous findings (Barić, Cecić Erpić, Babić, 2002; Biddle et. al., 2003) and indicate that, comparing to students' goal orientations, some other variables (e.g. class motivational climate, relationship with peers, perception of teacher behavior...) may have stronger impact on students' feelings of pressure on PE lessons.

## Conclusions

Positive PE experiences have an important role in developing lifelong physical activity habits. In order to positively influence physical activity behaviors it is important to identify factors in PE that are related to students' feelings of enjoyment and pressure which may influence the decision to continue or withdraw from physical activity beyond school setting. Our findings illustrate the necessity for continued research on factors related to experience of pressure and enjoyment on PE lessons. In so doing, researchers must bear in mind that difference in psychosocial development of elementary and high school students may lead to different conclusions about factors related to positive and negative PE experiences.

## References

1. Allender, S., Cowburn, G., & Foster, C. (2006). Understanding participation in sport and physical activity among children and adults: A review of qualitative studies. *Health Education Research*, 21(6), 826-835.
2. Barić, R. (2007). The relationship of coach's leadership behaviour and his motivational structure with athletes' motivational tendencies. *Doktorska disertacija. Ljubljana, Univerza v Ljubljani, Oddelek za psihologijo*.
3. Barić, R., Cecić Erpić, S., & Babić, V. (2002). Intrinsic motivation and goal orientation in track-and-field children. *Kinesiology*, 34(1), 50-60.
4. Barić, R., & Horga, S. (2007). Psychometric Properties of the Croatian Version of Task and Ego Orientation in Sport Questionnaire (TEOSQ). *Kinesiology*, 38(2), 135-142.

5. Barkoukis, V. (2007). Experience of state anxiety in physical education. In: Psychology for physical educators: Student in focus. Eds: Liukkonen, J., Auweele, Y.V., Vereijken, B., Alfermann, D. and Theodorakis, Y. 2<sup>nd</sup> edition. Champaign, IL: Human Kinetics. 57-72.
6. Biddle, S.J.H. (2001). Enhancing motivation in physical education. In G.C. Roberts (Ed.), *Advances in motivation in sport and exercise* (pp. 101-127). Champaign, IL: Human Kinetics.
7. Biddle, S., Akandeb A., Vlachopoulou, S., & Foxa, K. (1996). Towards an understanding of children's motivation for physical activity: Achievement goal orientations, beliefs about sport success, and sport emotion in zimbabwean children. *Psychology & Health*, 12 (1), 49-55
8. Biddle, S.J.H., Wang, J.C.K., Kavussanu, M., & Spray, C.M. (2003). Correlates of achievement goal orientations in physical activity: A systematic review of research. *European Journal of Sport Science*, 3(5), 1-18.
9. Boreham, C. & Riddoch, C. (2001). The physical activity, fitness and health of children. *Journal of Sports Sciences*, 19 (12), 915-929.
10. Boyd, M.P., Weinmann, C., & Yin, Z. (2002). The relationship of physical self-perceptions and goal orientations to intrinsic motivation for exercise. *Journal of Sport Behaviour*, 25(1), 1-18.
11. Duda, J.L. (1993). Goals: a social-cognitive approach. In R.M. Singer, M. Murphy, & L.K. Tennant (Eds.), *Handbook of Research in Sport Psychology* (pp. 421-435). New York: Macmillian.
12. Duda, J.L., Chi, L., Newton, M., Walling, M.D., & Cately, D. (1995). Task and ego orientation and intrinsic motivation in sport. *International Journal of Sport Psychology*, 26, 40-63.
13. Froberg K. & Andersen L.B. (2005). Mini Review: Physical activity and fitness and its relations to cardiovascular disease risk factors in children. *International Journal of Obesity*, 29, S34-S39
14. Hassandra, M., Goudas, M., & Chroni, S. (2003). Examining factors associated with intrinsic motivation in physical education: a qualitative approach. *Psychology of Sport and Exercise*, 4(3), 211-223.
15. Jurakić, D. & Pedišić, Ž. Prevalencija nedovoljne tjelesne aktivnosti kod djece i adolescenata – pregledni rad. *Paediatrica Croatica /in press/*
16. Martins, R. (1979). *Joy and sadness in children's sport*, Champaign, IL: Human Kinetics Publishers.
17. McAuley, E., Duncan, T., & Tammen, V.V. (1989). Psychometric properties of the intrinsic motivation inventory in a competitive sport setting: a confirmatory factor analysis. *Research Quarterly for exercise and Sport*, 60(1), 48-58.
18. McAuley, E., Wraith, S. & Duncan, T.E. (1991). Self-efficacy, perceptions of success, and intrinsic motivation for exercise. *Journal of Applied Social Psychology*, 21, 139-155.
19. Nicholls, J.G. (1989). *The competitive ethos and democratic education*. Cambridge, MA: Harvard University Press.
20. Papaioannou A. (1998). Students' perceptions of the physical education class environment for boys and girls and the perceived motivational climate. *Res Q Exerc Sport*. 1998 Sep;69(3):267-75.
21. Roberts, G.C. (2001). Understanding the dynamics of motivation in physical activity: The influence of achievement goals on motivational processes. In G.C. Roberts (Ed.), *Advances in motivation in sport and exercise* (pp. 1-51). Champaign, IL: Human Kinetics.
22. Roberts, G.C. & Treasure, D. C. (1992). Children in sport. *Sport Science Review*, 1(2), 46-64.
23. Ryan, R.M., & Deci, E. L. (2000). Self-determination theory and the facilitation of intrinsic motivation, social development, and well-being. *American Psychologist*, 55, 68-78.
24. Smith, A.L., Balaguer, I., & Duda, J.L. (2001). Dispositional and situational predictors of satisfaction and enjoyment in youth football players. In A. Papaioannou, M. Goudas, & Y. Theodorakis (Eds.), *Proceedings of the 10<sup>th</sup> World Congress on Sport Psychology*: Vol. 5 (pp. 59-61).Thessaloniki: Christodouli.
25. Tremayne, P. (1995). 'Children and Sport Psychology', in T. Morris and J. Summers (Eds.) *Sport Psychology, Theory, Applications and Issues*, pp. 516-537.
26. Urdar, T. (2004). Predictors of Academic Self-Handicapping and Achievement: Examining Achievement Goals, Classroom Goal Structures, and Culture, *Journal of Educational Psychology*, 251-264.
27. Van Wersch, A., Trew, K., & Turner, I. (1992). Post-primary school pupils' interest in physical education: Age and gender differences. *The British Journal of Educational Psychology*, 77(2), 339-349.
28. Weinberg, R. (2001). Motivation in sport and exercise: The special case of goal setting. In A. Papaioannou, M. Goudas & Y. Theodorakis (Eds.), *Proceedings of the 10<sup>th</sup> World Congress on Sport Psychology*: Vol. 3 (pp. 247-260). Thessaloniki: Christodouli

## STUDENTS' STANDPOINTS ON THE NECESSITY OF PHYSICAL EXERCISE

Vatroslav Horvat<sup>1</sup>, Nevenka Breslauer<sup>2</sup> and Ksenija Pletenac<sup>3</sup>

<sup>1</sup>*Teacher Academy, University of Zagreb, Croatia*

<sup>2</sup>*University of Međimurje, Čakovec, Croatia*

<sup>3</sup>*Dječji vrtić "Varaždin", Croatia*

### Summary

Physical exercise is a legitimate youth necessity in the modern world of today, especially since there is little or no intentional and/or systematic, institutionalized physical activity in the educational process. Various influences can, however, effect the level of physical activity within the student population. These can vary from their immediate surroundings, childhood habits, to their upbringing or a continuous sports activity.

This paper explains the thoughts of the students on the matter, as well as their motivation for taking up different physical activities.

It is crucial to raise awareness in the student population on the importance of having theoretical and practical kinesiological competences for conducting individual exercise and maintaining good health. This is even more important since the student population in question consists of future sports and tourism managers!

A survey has been conducted among the students, to find out what are their thoughts on positive behaviour regulation, managing their own reactions in specific frustrating scenarios, and a bigger motivation for learning about and taking part in kinesiological activities. The survey reveals only the needs and habits of the students, and its results cannot be perceived as a rule. Nevertheless, it can be used as a model in looking for solutions towards extra motivation for physical activity within the student population.

**Key words:** *physical exercise, standpoints, motivation, kinesiological activities*

## RELIABILITY OF INSTRUMENT FOR ASSESSING STANDING LONG JUMP PERFORMANCE IN PRESCHOOL CHILDREN

Marijana Hraski, Vatroslav Horvat and Iva Horvat

*Faculty of Teacher Education, University of Zagreb, Croatia*

### Abstract

Defining the space of motor skills is one of the priority tasks of scientists who study the anthropological status of preschool children. In order to define it on the scientifically appropriate manner, it is necessary to find adequate measuring instruments. This primarily involves defining the tests that will have satisfactory metric characteristics and at the same time be appropriate for children of preschool age. Currently their number is relatively limited and they are not tested on population of Croatian children. For the purpose of this study on a sample of 30 children, aged  $6 \pm 0.5$  years, who attended one of the kindergartens in the city of Zagreb, the metric characteristics of test for assessing fundamental movement skill -standing long jump are tested. The obtained results show a good objectivity, homogeneity and reliability of selected test and can be recommended for work with children of preschool age.

**Key words:** *movement skills, metric characteristics, motor performance, early childhood*

### Introduction

Considering previous studies of authors who have dealt with the definition of motor skills (Burton & Miller, 1998; Findak, Metikoš, Mraković, Neljak & Prot, 1998; Gallahue & Ozmun, 2005, Horvat 1998; Ulrich, 2000) standing long jump was classified as fundamental movement skill and according to his utility follows into locomotors skills. Fundamental movement skills are an essential factor in the human development during ontogenesis. Also, they enable children to move in space and show them how to appropriately respond to various stimuli (Hands, & Martin 2003, Zuvela, Bozanic, & Miletic, 2011). Some authors believe that inadequate knowledge of motor skills in childhood can adversely affect the level of motor activity at an older age (Gallahue & Ozmun, 2005). Development of appropriate motor skills provides a foundation for later successful adoption and implementation of specific motor skills (Burton & Miller, 1998; Sanders, 2002). A child will develop biotic motor skills during his childhood on a satisfactory level with appropriate kinesiology activities. For the successful realization of this goal the applying of appropriate measurement instrument for assessing motor skills is very important (Kroes, et al., 2004). The assessment of movement skill is a critical component of kinesiology science. In order to plan efficient and effective movement programs or to support the involvement of a child with special needs in the wider community, it is important to gather information about the motor skill level of the child and what best motivates them, their strengths and needs (Hands, & Martin, 2003). For this reason evaluation of the level of development of fundamental movement skills during preschool period is certainly necessarily for implement. Based on obtained information it could be carried out the effects of kinesiology treatment and enter the appropriate changes in exercise programs. Accordingly, the aim of this pilot study is to examine the metric characteristics of test for assessing standing long jump performance.

### Methods

The study was conducted on a sample of 30 preschool children (6 year olds,  $\pm 6$  months), 18 boys and 12 girls. The measurement was carried in academic year 2010. in kindergarten Iskrice in Zagreb. Prior testing for all children were gathered the consent of their parents. The children were videotaped, to avoid any subjective evaluation, with one digital video camera positioned 5 m apart and at  $90^\circ$  to direction of jump. The subjects performed standing long jump three times in a roll and for further analyses the best performance of jump (according to experts) was used. The evaluation was conducted by three independent judges (kinesiology's who work with children of preschool age) on the basis of a check list for standing long jump performance using the videos. The judges were previously instructed to evaluate the specific motor assessment levels. The collected data were analyzed by statistical software Statistica 9.0. The reliability of test were determined by calculating intercorrelation matrix, inter item correlation ( $r_{II}$ ), and Cronbach alpha ( $\alpha$ ). The basic descriptive parameters were calculated: arithmetic mean (AS), standard deviation (SD), minimum (MIN) and maximum (MAX) value, the asymmetry (SKE) and degree of peakedness (KURT) of distribution for determine the sensitivity and the normality was tested by K-S test. The homogeneity was estimate by univariate analysis of variance (F test and the level of significance –  $p < 0,05$ ).

## Standardization of the measurement procedure (check list)

EQUIPMENT	DESCRIPTION OF WORK SPACE	DESCRIPTION OF TEST	CRITERIA FOR EXCELLENT PERFORMANCE	SMALL ERRORS	BIG ERRORS
<ul style="list-style-type: none"> <li>two connected mat</li> <li>duck tape width 3 cm and length 30 cm</li> <li>free space of 5 m</li> <li>One DV camera</li> </ul>	Place the mat on the floor next to each other in length. At 20 cm from the beginning of mat paste duck tape	The child stands on mat with toes behind duct tape. Then follows double arm swing, crouch, two feet takeoff, flight and landing "softly" by flexing at the hip, knee and ankle joints	<ul style="list-style-type: none"> <li>1/4 squat, arms extended behind the body, lean forward</li> <li>rapidly arm swing forward before takeoff,</li> <li>takeoff with both feet,</li> <li>at the time of takeoff the body is maximal extend</li> <li>"stop" arms horizontally in front (at head height) just at the moment of takeoff</li> <li>two feet landing with the amortization in the hip, knee and ankle joints</li> <li>use arms for counterbalance</li> </ul>	<ul style="list-style-type: none"> <li>too small squat before takeoff</li> <li>work arms circularly in flight phase (no "stop" arms in front of the body)</li> <li>landing with a small step back or forward,</li> <li>falling on knees and hands forward after landing,</li> <li>landing with no amortization</li> <li>visual too short jump</li> </ul>	<ul style="list-style-type: none"> <li>no arms swing before takeoff,</li> <li>at the time of takeoff body is bend (torso, knees, hands)</li> <li>takeoff with one leg</li> <li>landing on one leg</li> <li>landing on knees</li> <li>landing on gluteus</li> </ul>

The evaluation scale for the assessment of standing long jump performance ranged from 1-5. For score excellent (5) it must be satisfied all the criteria for performing a particular task. Mark very good (4) implies the task with one small error. Good score (3) is awarded if the performance contains two small errors or one big error. In the case of motor performance with more than three small mistakes or one big and one small mistake it is awarded as "satisfactory" (2). Ranking inadequate (1) is given if a child has a greater number of errors, if subject is unable to perform the task, and if the whole stereotype of motion is disturbed.

## Results and discussion

On the base of obtained results for objectivity of tests for assessing standing long jump performance (Table 1) it can be concluded that the present intercorrelations of three judge scores are satisfactory. The F-test and p-level show no statistically significant difference between items, so the designed test has good homogeneity. In accordance with the obtained coefficients of reliability "inter-item correlation" (IIR) and the Cronbach alpha coefficient ( $\alpha$ ), a standing long jump can be considered as a reliable test to assess knowledge of this basic locomotors skill.

Table 1. Reliability, objectivity and homogeneity of variables for assessing standing long jump performance

Variable	Judge1	Judge2	Judge3	IIR	$\alpha$	Mean $\pm$ SD	F test	p-level
	1,00	0,77	0,83			3,13 $\pm$ 1,33		
Standing long jump (SLJ)	0,77	1,00	0,76	0,79	0,92	3,27 $\pm$ 1,20	2,26	0,11
	0,83	0,76	1,00			3,47 $\pm$ 1,41		

Legend: Judge1, Judge2, Judge3 – intercorrelations between items; IIR - inter-item correlation;  $\alpha$  - Cronbach alpha coefficient; SD – standard deviation; F test -ANOVA; p-level – level of significance

Table 2 shows the basic descriptive parameters of standing long jump performance. The results of the coefficient of skewness and kurtosis indicate a slightly positive asymmetry and little flattened distribution. The results of normality of distribution (KS test) show that some items do not have a normal distribution (Judge1, Judge2). In these items are significant differences between normal and empirical distributions. In the third variable (Judge3) the difference between the normal and empirical distributions are not significant. It can be assumed that because of a relatively small number of respondents, degrees of freedom are set on a high level of Dmax. So, the sensitivity indicates successful differentiation of examinees in the test.

Table 2. The sensitivity of the variables for the assessment of standing long jump performance

Variable	Mean	Min	Max	SD	Skewness	Kurtosis	KS test
Judge1	3,13	1,00	5,00	1,33	-0,44	-0,88	0,20 p<,15
Judge2	3,27	1,00	5,00	1,20	-0,17	-0,43	0,22 p<,10
Judge3	3,47	1,00	5,00	1,41	-0,44	-0,98	0,19 p<,20

Legend: SD – standard deviation; Min – minimal result; Max – maximal result; KS test - Kolmogorov-Smirnov test (D max)

## Conclusion

The fundamental movement skills is a relatively poorly researched among children of preschool age. Most authors who have dealt with this issue are in agreement that an insufficient level of biotic motor skills in children has negative consequences for their involvement in motor activity in later life. To prevent this problem it would be necessary to construct a proper assessment for certain biotic movement skills. The prerequisite for this is primarily a design appropriate measurement instrument. For that purpose it was provided a pilot study. On a sample of 30 children aged  $6 \pm 0.6$  years (18 boys and 12 girls) the reliability of test for assessing biotic locomotors skill - standing long jump performance - was tested. The basic descriptive parameters showed that this test is appropriate for preschool children. Also the value of Cronbach alpha coefficient (0.92) shows its significant reliability. On the base of all collected results in this pilot study authors believe that this test can be applied as the assessment of basic locomotors skills and be used in research and practical work with children of preschool age.

## References

1. Burton, A. W., & Miller, D. E. (1998). Movement skill assessment. Human Kinetics. Champaign, IL.
2. Findak, V., Metikoš, D., Mrakovid, M., Neljak, B., & Prot, F. (1998). *Primijenjena kineziologija u školstvu - motorička znanja*. Zagreb: Fakultet za fizičku kulturu Sveučilišta u Zagrebu.
3. Gallahue, D.L., & Ozmun, J.C. (2005). *Understanding motor development: infants, children, adolescents, adults (6<sup>th</sup> ed.)*. Dubuque, Iowa: McGraw-Hill.
4. Hands, B., Martin, M. (2003). Fundamental movement skills: children's perspectives. *Australian Journal of Early Childhood*, 28 (4), 40-46
5. Horvat, V. (1998). Motorička znanja djece predškolske dobi. Magistarski rad. Fakultet za fizičku kulturu Sveučilišta u Zagrebu
6. Kroes, M., Vissers, Y. L. J., Sleijpen, F., A., M., Feron, F., J., M., Kessels, A., G., H., Bakker, E., Kalff, A., C., Hendriksen, J. G. M., Troost, J., Jolles, J., & Vles, J., S., H. (2004). Reliability and validity of a qualitative and quantitative motor test for 5- to 6-year- old children. *European Journal of Pediatric Neurology*, 8, 135-143
7. Malina, R. (2004). Motor Development during Infancy and Early Childhood: Overview and Suggested Directions for Research. *International Journal for Sport and Health science*, 2, 50-66
8. Ulrich, D.A. (2000). *Test of Gross Motor Development (2<sup>nd</sup> ed.)*. Austin, TX: Pro-ed.
9. Sanders, S. W. (2002). *Active for Life: Developmentally Appropriate Movement Programs for Young Children*. Washington, DC: NAEYC.
10. Zuvela, F., Bozanic, A., & Miletić D. (2011). A new fundamental movement skills test for 8 year old children: construction and validation. *Journal of Sport Science and Medicine*, 10, 157-163

## Acknowledgement

The results of this study are part of the scientific project "Kinesiological education in preschool and primary education", executed with support of Ministry of science, education and sports of Republic of Croatia.



## DIFFERENCES IN MORPHOLOGICAL CHARACTERISTICS, MOTOR SKILLS AND BMI BETWEEN FEMALE HIGH SCHOOL STUDENTS AGE 14-18 ENGAGED IN SOME RECREATIONAL PROGRAM AND THOSE LACKING ANY

Srna Jenko-Miholić<sup>1</sup>, Andrea Čižmek<sup>2</sup> and Josipa Peršun<sup>3</sup>

<sup>1</sup>Faculty of Teacher Education, University of Zagreb, Croatia

<sup>2</sup>First archery club "Zagreb 1955", Zagreb, Croatia

<sup>3</sup>IX. Grammar School, Zagreb, Croatia

### Abstract

The research was carried out on a sample of 208 girls aged 14 to 18 from grammar school in Zagreb, Croatia. The aim of the research was to establish potential differences in morphological characteristics, motor skills and body mass index between girls who are engaged in some organized sport activities outside school and those not engaged. Six anthropometric measures were taken (body height, body mass, upper arm circumference, upper leg circumference, upper arm skinfold and lower leg skinfold) and seven motor tests (obstacle course over and through (coordination), standing long jump (explosive strength), sit-ups (muscular strength of the torso), hold on chin up (muscular endurance of the shoulder girdle and arms), hand tapping (movement frequency), forward bend (flexibility) and one legged balance bench standing (balance)). The results of discriminative analysis have pointed out the significant differences in the in motor skills between some age groups of the girls who are engaged in some organized sport activities outside school and those not engaged.

**Key words:** *body mass index, discriminant analysis, female students, grammar school*

### Introduction

Measuring anthropological characteristics is a common procedure used by physical education teachers which enables planning, programming and conducting a process of physical exercise. Testing protocols include anthropometric measuring as well as performing tests for motor and functional skills evaluation (Findak, 1999).

According to national standard for physical education (published by NASPE – National Association for Sport and Physical Education), a physical education teacher should include usage of movement concepts and principles in learning and developing motor skills, promotion of a physically active lifestyle, and achievement and maintenance of optimal level of physical fitness that is health benefitting. (Hoffman, 2005.) Considering the abovementioned and also praxis, a question arises: do physical education teachers as well as kinesiological programs used in schools as a part of regular curriculum, really able to transform certain anthropological characteristics of children and youth who are lacking any other kind of organized physical activity? Do children understand the need of active lifelong physical activity? Moreover, is there a choice of different kinesiological activities broad enough that can offer children and youth finding and learning (specializing) in an activity of their own preference? (Andrijašević & Jurakić 2010., Persović, 2010.)

BMI stands for body mass index, a simple anthropometric measure and the most frequently used measure of adiposity and often in literature correlated with body mass (Schousboe, et al., 2003). BMI is a calculation of one's weight to height. BMI presents weight information, so values under 18.5 presents underweight, 18.5–24.9 normal weight, 25–29.9 overweight and values of 30 or greater presents obesity (Gallagher, et al., 2000). It can be assumed that BMI is well correlated with the percentage of body fat. However BMI measures nutritional status rather than body composition (Garrido-Chamorro, et al., 2009). Still BMI is generally considered the only practical noninvasive measure of relative body size for survey methods and thus is generally preferred over measures of body composition (Lynch, et al. 2007).

Regardless of gender, BMI positively correlate with body concerns and weight control behaviors (Lynch, et al. 2007). BMI is also related with interaction of a sedentary lifestyle, high-fat and energy-dense diets (Salio-Latheenkorva, Lahelma, 1999). An increased body mass in children is usually associated with a decrease in athletic performance (Delaš, et al. 2008).

The aim of this study was to examine potential existence of statistically significant differences in anthropological status between female high school students engaged in some kind of organized kinesiological activity (apart regular physical education classes) and those lacking any.

In this study we have five hypotheses. First says there are statistically significant differences in anthropological status between girls engaged in some kind of organized kinesiological activity and those lacking any at the age 14-15. Second, third and fourth hypotheses are the same differ for the girls students age (15-16, 16-17 and 18-19). The last hypothesis

says there is statistically significant differences in body mass index (BMI) among subgroups of girls sport involvement or involvement.

The secondary goal of this research was to provoke and induce interest in female students for their anthropological characteristics, possibilities of their changes, indirect influence of motor skills on morphological characteristics and most importantly, understanding the importance of engaging in some kind of recreational program and its health benefactory influence on women.

## Methods

The research was carried out on a sample of 208 girls aged 14 to 18 from grammar school in Zagreb, Croatia. Anthropometric and motor measurements have been performed in the morning school shifts during regular PE classes. Only healthy students, who were not exempt from physical education for health reasons were measured. Based on a questionnaire they were divided into eight groups according to their sport status and age. According to questionnaire analysis, 125 students were not engaged in any kinesiological activity (except regular physical education classes) and 83 students were kinesiological active aside regular physical education classes (Table 1).

The standard procedure was used to calculate the basic and dispersive parameters of measuring instruments. The statistics program Statistika 9.0 licensed for the University of Zagreb was used for data analysis.

*Table 1. Size of subsamples in different age and sport engagement for girls*

AGE (grade)	sport lacking students	sport engaged students	total
AGE 14-15 (1 <sup>st</sup> grade)	37	31	68
AGE 15-16 (2 <sup>nd</sup> grade)	27	25	52
AGE 16-17 (3 <sup>rd</sup> grade)	32	14	46
AGE 17-18 (4 <sup>th</sup> grade)	29	13	42
total	125	83	208

The sample of variables consisted of 13 standard anthropological measures, from which six anthropometric measures and seven test for motor skill evaluation. Anthropometric measures consisted of: body height (ATV), body mass (ATT), upper arm circumference (AONL), upper leg circumference (AONT), upper arm skinfold (ANNAD) and shank skinfold (ANP). Anthropometry was conducted according to International Biological Program (IBP), so height and weight were measured once and skinfolds three times. Basic motor skills assessment was made with tests: MKPOL - jumping and getting through polygon (coordination), MESSDM - standing long jump (explosive strength), MRSPT - forward bent (repetitive strength), MSSIV - hold on chin up (static strength), MBFTAP - hand tapping (movement frequency), MFPR - forward bow (flexibility) and MRU1 - one legged balance bench standing (balance).

## Results

Descriptive parameters were calculated: the mean, minimal and maximal value, standard deviation and skewness and kurtosis. Normality of distribution was verified with Kolmogorov-Smirnov test. Table 2. and Table 3. shows number of entities, mean and standard deviation for subsamples according to sport engagement. Discriminant analysis was conducted to determine differences and determine which variable contributes the most to the difference. ANOVA-Post Hoc Test was used for calculating BMI differences between sport engagement groups and sport lacking groups.

Table 2. Basic descriptive parameters: number of entities (Valid N), Mean and Standard deviation (St.Dev) of subsample of sport engaged students

sport engaged	AGE 14-15 (1 <sup>st</sup> grade) Valid N=31		AGE 15-16 (2 <sup>nd</sup> grade) Valid N=25		AGE 16-17 (3 <sup>rd</sup> grade) Valid N=14		AGE 17-18 (4 <sup>th</sup> grade) Valid N=13	
	Mean	St.Dev	Mean	St.Dev	Mean	St.Dev	Mean	St.Dev
body height	166,48	6,25	165,68	6,21	166,81	6,40	165,73	6,42
body mass	56,79	6,66	57,38	5,75	57,94	5,44	58,95	9,78
upper arm circumference	26,31	2,26	27,01	1,73	28,06	1,48	27,61	3,28
upper leg circumference	53,34	4,39	53,91	2,71	55,48	2,46	55,50	4,36
upper arm skinfold	17,81	3,68	17,67	2,95	17,66	4,37	18,18	4,42
shank skinfold	16,44	4,19	17,53	4,75	15,93	5,06	17,30	4,93
jumping and getting through	17,27	3,78	16,82	3,22	15,45	2,69	17,18	3,21
standing long jump	172,96	12,49	173,48	15,99	182,50	18,27	169,23	21,49
forward bent	44,04	7,55	47,65	6,84	46,14	9,66	44,00	8,31
hold on chin up	34,42	20,91	35,43	13,65	41,89	23,61	23,38	10,81
hand tapping	35,79	4,07	35,17	3,55	37,50	1,65	34,92	3,99
forward bow	68,86	9,30	69,63	7,98	72,21	9,61	68,62	6,93
one legged balance bench	4,42	3,60	5,64	5,08	4,78	2,23	7,85	6,62

Table 3. Basic descriptive parameters: number of entities (Valid N), Mean and Standard deviation (St.Dev) of subsample of sport lacking students

sport lacking	AGE 14-15 (1 <sup>st</sup> grade) Valid N=37		AGE 15-16 (2 <sup>nd</sup> grade) Valid N=27		AGE 16-17 (3 <sup>rd</sup> grade) Valid N=32		AGE 17-18 (4 <sup>th</sup> grade) Valid N=29	
	Mean	St.Dev	Mean	St.Dev	Mean	St.Dev	Mean	St.Dev
body height	166,72	6,41	169,68	6,78	166,53	6,08	166,26	4,76
body mass	59,16	9,24	62,77	11,76	61,52	10,84	57,01	6,40
upper arm circumference	26,81	3,12	28,64	3,45	28,30	3,90	27,54	2,62
upper leg circumference	54,62	5,72	56,20	5,13	55,55	5,93	55,49	4,69
upper arm skinfold	18,17	4,82	20,80	6,40	20,28	5,79	18,17	5,08
shank skinfold	19,39	5,53	20,77	5,97	18,76	6,41	17,59	4,84
jumping and getting through	20,83	6,43	21,41	5,96	19,85	7,71	19,02	3,78
standing long jump	162,68	17,67	166,04	11,98	165,16	15,99	168,70	20,83
forward bent	40,00	7,41	38,13	8,31	39,63	8,66	41,37	9,89
hold on chin up	22,63	14,65	25,65	19,05	22,03	16,62	28,11	19,21
hand tapping	34,53	3,01	33,25	3,39	35,38	3,13	35,41	3,30
forward bow	64,76	10,19	65,13	7,33	65,59	10,37	65,78	9,46
one legged balance bench	4,04	2,62	4,11	2,96	4,27	2,54	4,73	2,53

For the purpose of BMI calculation we used two variables - body height and body mass and based on those two anthropometric measurements, BMI was calculated (weight(kg)/height (m)<sup>2</sup>) (Schousboe, et al., 2003) shown in Table 4. For BMI calculation ANOVA – Post Hoc Test was used.

Table 4. Body mass index (BMI) results for subsamples in different age and sport engagement

	14-15 sport lacking	15-16 sport lacking	16-17 sport lacking	17-18 sport lacking
BMI	21,28	21,82	22,19	20,63
	14-15 sport engaged	15-16 sport engaged	16-17 sport engaged	17-18 sport engaged
BMI	20,50	20,92	20,82	21,47

## Discussion

After conducting descriptive analysis and getting standard parameters of central tendency and variability, discriminative analysis has been carried out, before which Kolmogorov-Smirnoff test confirmed normality of distribution.

Discriminative analysis showed no statistically significant difference ( $p > 0,05$ ) between students engaged in sport programs and those lacking ones, in the variables of anthropometry of subsamples of every grade as shown in Table 5. Period of adolescence which expands from 10 or 11 – 15 or 16 years of age in girls causes noticeable differences of morphological characteristics and body proportions (Kurelić, et al. 1975). The abovementioned can indicate different individual phases of puberty status in which complete morphological modeling still hasn't finished. Moreover, according to the results of many studies concerned with body height and physically active and inactive children, no influence of physical activity on body height has been found (Malina, Bouchard & Bar-Or, 2004). Although one can assume a connection between physical activity and lower body fat percentage, only certain intensity of training can induce body composition changes. Morphological differences between young athletes and non-athletes are more emphasized in girls than boys (Malina 1999) according to Mišigoj-Duraković, (2008). Also, measures of skinfold and circumference did not show statistically significant difference between students engaged in sport programs and those lacking ones. Because of this female students engaged in different sport programs should consider participating in even more activities and try using more of their anthropology resources.

Table 5. Linear discriminative function in anthropometric variables by age based on sport engagement

AGE (grade)	ANTHROPOMETRY					
	Eigen-	Canonicl	Wilks'	Chi-Sqr.	df	p-level
AGE 14-15 (1 <sup>st</sup> grade)	0,196775	0,405488	0,835579	11,13707	6	0,084231
AGE 15-16 (2 <sup>nd</sup> grade)	0,226817	0,429979	0,815118	9,607868	6	0,142167
AGE 16-17 (3 <sup>rd</sup> grade)	0,235774	0,436796	0,809209	8,679600	6	0,192415
AGE 17-18 (4 <sup>th</sup> grade)	0,183488	0,393751	0,844960	5,896309	6	0,434905

Discriminative analysis showed statistically significant difference ( $p > 0,05$ ) between students engaged in sport programs and those lacking ones, in the variables of motorics in subsamples of age 15-16 and 16-17 (2<sup>nd</sup> and 3<sup>rd</sup> grade). Difference ( $p = 0,064$ ) was found between students engaged in sports programs and those lacking ones, in the variables of motorics of age 14-15 (1<sup>st</sup> grade) subsample. No statistically significant difference ( $p > 0,05$ ) was found in the variables of motorics at age 17-18 (4<sup>th</sup> grade) subsample as shown in Table 6.

Table 6. Linear discriminative function in motor variables by age based on sport engagement

AGE (grade)	MOTOR VARIABLES					
	Eigen-	Canonicl	Wilks'	Chi-Sqr.	df	p-level
AGE 14-15 (1 <sup>st</sup> grade)	0,266842	0,458951	0,789364	13,36379	7	0,063725
AGE 15-16 (2 <sup>nd</sup> grade)	0,641538	0,625152	0,609185	20,56879	7	0,004464
AGE 16-17 (3 <sup>rd</sup> grade)	0,506073	0,579674	0,663979	16,58497	7	0,020278
AGE 17-18 (4 <sup>th</sup> grade)	0,239320	0,439438	0,806894	7,402427	7	0,388215

According to factor structure, forward bent test for repetitive strength assessment (centroid projection dominates with sport engaged students) differentiates the most students at the age 15-16 (2nd grade). At the age 16-17, in the 3rd grade, tests for strength assessment differentiate the groups the most: standing long jump (explosive lower extremities strength) and hold on chin up (static strength), both dominant with sport engaged students. Although statistically significant difference among groups (sport engaged and not engaged students) at the age 14-15 (1st grade) is  $p = 0,064$ , there is an interesting dominant centroid projection with sport engaged students in the variables of strength assessment - static, explosive and repetitive (hold on chin up, standing long jump and forward bent), whilst sport not engaged students in the variable of coordination assessment (jumping and getting through polygon) which is reversely scaled variable and have a high contribution of discrimination between groups as shown in Table 7.

Table 7. Factor structure and centroid position on discriminative function

	AGE 14-15 (1 <sup>st</sup> grade)	AGE 15-16 (2 <sup>nd</sup> grade)	AGE 16-17 (3 <sup>rd</sup> grade)	AGE 17-18 (4 <sup>th</sup> grade)
<b>FACTOR STRUCTURE</b>	Root 1	Root 1	Root 1	Root 1
jumping and getting through polygon	-0,644619	0,607257	0,439445	-0,501986
standing long jump	0,647634	-0,336887	-0,687102	0,024607
forward bent	0,529006	-0,797017	-0,480488	0,274199
hold on chin up	0,650763	-0,375242	-0,692945	-0,272703
hand tapping	0,349106	-0,353650	-0,506306	-0,134785
forward bow	0,408844	-0,375416	-0,431323	0,318865
one legged balance bench standing	0,118849	-0,236277	-0,136631	0,716239
<b>CENTROIDS</b>	Root 1	Root 1	Root 1	Root 1
G_1:0-N	-0,461154	0,767232	0,46020	-0,330858
G_2:1-R	0,559973	-0,800590	-1,05188	0,687166

According to Mišigoj-Duraković (2008), children and youth engaged in sport and recreation mostly possess higher level of motor skills. Also, during maturation they start being more sensitive on influence of training processes in a sense of having better functional abilities, primarily muscle power and aerobic endurance. Girls usually reach certain level of abilities in the beginning of high school (14 or 15 yrs of age). Stated can be seen in the results shown in Table 7, and explain domination of sport engaged students in the space of quantitative motor skills, explosive, static and repetitive strength.

## Conclusion

With the goal of enhancing future programming of physical education classes, female high school students in city of Zagreb, Croatia have been tested with 13 anthropological tests. This research has shown statistically significant differences between female students engaged in sport programs and those lacking ones in the space of motor skills on 2<sup>nd</sup> and 3<sup>rd</sup> high school graders (age 15-16 and 16-17), because of which second and third affirmative hypothesis were accepted, while first and fourth were rejected. Also, fifth hypothesis regarding to BMI was rejected, too, since in all four grades (age 14-18) haven't been noticed statistically significant differences between girls who were sport engaged and those who weren't.

Within a single generation of high school female students (1<sup>st</sup> – 4<sup>th</sup> grade, age 14-18), existence of a relatively higher number of students lacking some kind of kinesiological activities is present. Also, during high school period one notices decrease in number of students engaged in kinesiological activities. All stated indicates higher needs in intensifying physical education classes for female students, but also broader offering of different kinesiological activities (even information based) which in future years could help satisfying different movement and physical activity needs.

## References

1. Andrijašević, M., Jurakić, D. (2010.) Programi sportske rekreacije u slobodnom vremenu djece i mladih, In: Andrijašević, M. i Jurakić, D. (ed.): Međunarodna znanstveno stručna konferencija - Kineziološki sadržaji i društveni život mladih, Zagreb, 27. February, pp.13-19, Kineziološki fakultet Sveučilišta u Zagrebu.
2. Delaš N., Tudor A., Ružić L., Šestan B. (2008): Obesity Indicators and Athletic Performance in 11-15 Year-Old Children. *Hrvat. Športskomed. Vjesn.* 2008;23:35-44.
3. Findak, V. (1999.) Metodika tjelesne i zdravstvene kulture, Zagreb, Školska knjiga.
4. Gallagher I., Heymsfield S.B., Heo M., Jebb S.A., Murgatroyd P.R., Sakamoto Y., (2000): Healthy percentage body fat ranges: an approach for developing guidelines based on body mass index. *Am J Clin Nutr* 2000; 72:694-701.
5. Garrido-Chamorro R.P., Sirvent.belando J.E. Gonzalez-Lorenzo M., Martin-Carratala M.L., Roche E. (2009): Correlation between body mass index and body composition in elite athletes. *J Sports Mede Phys Fitness* 2009;49:278-284.
6. Hoffman, S.J. (2005.) Introduction to Kinesiology, Champaign, Human Kinetics.
7. Kurelić N, Momirović K, Stojanović M., Šturm J., Radojević Đ., Viskiž Štalec N. (1975.) Struktura i razvoj morfoloških i motoričkih dimenzija omladine, Beograd, Institut za naučna istraživanja Fakulteta za fizičko vaspitanje univerziteta u Beogradu
8. Lynch W.C., Heil D.P., Wagner E., Havens M.D. (2007): Ethnic differences in BMI, weight concerns and eating behaviors: Comparasion of Native American, White and Hispanic adolescents. *Body Image* 2007;4:179-190.
9. Malina R., Bouchard C., Bar-Or, O. (2004.) Growth, maturation and physical activity, Champaign, Human Kinetics.
10. Mišigoj-Duraković, M. (2008.) Kinantropologija, Zagreb, Kineziološki fakultet Sveučilišta u Zagrebu.

11. Perasović B. (2010.) Kineziološki sadržaji i društveni život mladih: socijalizacija, sport, identifikacija, In: Andrijašević, M. i Jurakić, D. (ed.): Međunarodna znanstveno stručna konferencija - Kineziološki sadržaji i društveni život mladih, Zagreb, 27. February, pp. 40-45, Kineziološki fakultet Sveučilišta u Zagrebu.
12. Salio-Latheenkorva S., Lahelma E. (1999): The association of body mass index with social and economic disadvantage in women and men. *Int J Epidemiol* 1999;28:445-449.
13. Schousboe K., Willemssen G., Kyvik K.O., Mortensen J., Boomsma D.I., Cornes B.K. et al. (2003): Sex Differences in Heritability of BMI: A comparative Study of Results from Twin Studies in Eight Countries. *Twin Research* Vol.6 5:409-421.

#### **Acknowledgement**

The results of this study are part of the research project "Kinesiological education in preschool education and primary education" accepted and supported by the Ministry of Education and Sports of the Republic of Croatia.

## VALIDATION OF REDUCED TRAINING PROGRAM FOR NO SWIMMERS YOUNGER STUDENTS

Besalet Kazazović<sup>1</sup>, Edin Mirvić<sup>1</sup> and Almir Popo<sup>2</sup>

<sup>1</sup>*Faculty of Sport and Physical Education, Sarajevo, Bosnia and Herzegovina*

<sup>2</sup>*Teaching Faculty University „Džemal Bijedić“, Mostar, Bosnia and Herzegovina*

### Purpose

This research is dedicated for problem of training non-swimmers in a non-standard conditions, training non-swimmers in deep water. The reduction was done in a smaller number of hours, as is otherwise required, in the ordinary standards, and some programming contents that can not be realized in deep water.

### Methods

The research was performed in a newly built indoor swimming pool in Sarajevo dimensions of 25x12.5x1.4 to 1.8 m. The program was implemented on 38 students, male, V and VI grade (10 -11 years) and the duration of 5 days (2 hour in the morning and 2 hours. in the afternoon, a total of 20 hours.). For verification of the effects of the program it has been used the control test battery: dive to a depth of 1.5 meters, diving at a distance (meters), evaluation techniques, and time swimming at 50 m (sec). Results were treated with T-test for dependent samples in order to obtain the significance of differences in initial and final testing

### Results

Differences between initial and final measurements, the significance of T-test, all variables were at the level of the sharpest criteria - significance (sig. 000). The biggest movements, improvement of results, participants were recorded in variables: dive to a depth 1.50m (- 25.81), swimming at 50m/Time (-21.87), diving distance/m (-14.90), swimming and evaluation techniques (-10.55). Boys were, an average, improved the diving distance by 13 m, the efficiency of dives in depth by 93%, raised grade techniques of swimming value of 1.2, and swimming speed of 67.2 sec.

### Conclusions

All students have fully embraced this high-speed (implemented in five days) and reduced program and eventually showed remarkable results in the ability to swim and dive. With satisfaction it can be recommended to all instructors / teachers of swimming which will be working with similar populations in similar conditions.

**Key words:** *non-swimmers, T test, crawl*

## HOW HIGH PRESCHOOL CHILDREN JUMP?

Katja Koren<sup>1</sup>, Boštjan Šimunič<sup>1,2</sup> and Rado Pišot<sup>1,2</sup>

<sup>1</sup>University of Primorska, Science and Research Centre, Institute for Kinesiology Research, Koper, Slovenia

<sup>2</sup>University of Primorska, Faculty of education, Department of Primary School Teaching, Koper, Slovenia

### Abstract

Children develop their motor skills at playing as well as with physical activities incorporating many different elements where jumping is one of them. The purpose of this study was to investigate the height of the vertical jump performed by preschool children. The subjects were 107 preschool children, measured longitudinally at 4 and 5 years of age. We analysed the performance of the counter movement jump (CMJ - with and without arms). The height of the vertical jump was measured with a ground reaction force plate. We performed also qualitative 2D lateral video kinematics using high speed camera. The analysis of data revealed no significant differences between gender. However, data analysis did reveal a significant CMJ height improvement for ~25 % with age (effect size = 1.07 and 0.97 for CMJ without and with arm use, respectively). We found out that at age four and five there was no gender difference in jumping performance. While at age five children jump higher than at age four and at age five the majority of them are coordinated jumpers.

**Key words:** ground reaction force, jump explosive power, tensiometric plate, vertical jump height, kindergarten

### Introduction

Gallahue and Ozmun (2006) emphasize that early childhood is a very sensitive period of development and improvement of the elementary motor abilities and for the evaluation of the elementary movement patterns, which are fundamental for determining the global impact on lifestyle changes, increase of motor competences and possibility of their upgrade (motor learning). Davies (2003) and Gallahue (1996) found out that elementary motor abilities and motor skills are required for living. Delayed motor development negatively affects on the future development of the child (Gallahue, 1996). Children refine their motor abilities while they are playing and executing different sports and activities in their early childhood, which in their later maturation allows them a normal life like for example maintaining balance on the bus, climbing the ladder and dealing with different motor activities. Well acquired elementary motor abilities are also a good foundation for dealing with different sports (Gallahue and Ozmun, 2006).

The amount and type of physical activity is also associated with the acquisition of good elementary motor abilities (Cools, De Martelaer, Vandaele, Samaey and Andries, 2009). Many researchers (Medeková, Zapletalová and Havlíček, 2000; Wrotniak, Epstein, Dorn, Jones and Kondilis, 2006) found out, that more physically active children are more skilled than sedentary peers.

An important factor in the children's maturation is regular, adequately intensive exercise and appropriate motor activity, because it protects and strengthens health, it maintains adequate level of physical fitness and significantly contributes to the development of such habits and behavioural patterns to ensure activity throughout the lifespan (Gallahue and Ozmun, 2006; Malina, 1996, Strong et al, 2005). Deli, Bakle and Zachopoulou (2006) found out, that a 10-week program training has a positive impact on the improvement of basic motor skills like running and jumping.

One of the elementary movement patterns is also the jump, which has more types of implementation. Many research studies have been done on adult population, adolescents and pupils, only few of them were made on preschool population, despite the importance of this developmental period.

Every child, after he has acquired the pattern of walking and running, learns jumping and hopping with both feet and later on with jumping on one foot. While jumping children constantly test their acquired knowledge and find where are the limits. In the first five years children should learn jumping on one foot, on two feet, long jumping and drop jumping. Neely and Zebas, (2002) found out that more problems occur while doing the vertical jump because of the problem of coordination between the upper and lower body. The authors have divided children in two groups with respect to kinetic energy while jumping with the use of their arms and without using them. They found out that children with better efficiency jump 19% higher if they use their arms, but on the other hand there were no differences in the jumping height of children with low efficiency. (Clark and Philips, 1985) found out that less than 30% of 3-7 year-olds have a good coordination. Children in elementary school make progress for about 5 cm per year in the height of the jump and 8 to 13 cm in the length of the jump (Haywood and Getchell, 2005). Harrison and Gaffney (2001) found out that 6 years old children already jump as effectively as adults. Moreover, Riddiford-Harland, Steele and Baur (2006) found out that 8-year old children with excess in body mass jump significantly lower than their peers with normal body mass.



In our research we longitudinally measured the height of the vertical jump in 4- and 5-year old children and its importance to the effectiveness on vertical jump.

## Methods

*Children:* In this investigation participated 107 healthy children at age of four years. From them 96 had successfully performed CMJ task at age four years and 98 at age five years. Altogether a sample of 86 children has performed both CMJ tasks, at age four and five years. Descriptive data of children are given in Table 1. All testing procedures conformed to the 1964 Declaration of Helsinki and were approved by the Committee for Medical Ethics at the Ministry of Health (Slovenia). Written informed consent was obtained from all the parents of children prior to their participation in the study. The children sample was selected from the coastal kindergartens in Slovenia.

*Measurements:* Measurements were obtained within national basic research project “Analysis of fundamental motor pattern, skeletal and muscle adaptation on specific sedentary lifestyle factors amongst 4 to 7 years old children”. Until now, the measurements were made of children at the age of 4 and 5 years and have been made in the laboratory of the Institute for Kinesiology Research, University of Primorska, Science and Research Centre of Koper. The basic morphological characteristics were measured with standard tools and bioimpedance method (Maltron). The children had their CMJ test on the tensiometric ground reaction force plate (AMTI). The height of the vertical jump and the time the individual remained airborne were displayed on the computer. The children of the present study were asked to perform 3 CMJ with using arms and 3 CMJ without using their arms. During each jump, there were at least 30 seconds of rest. The best height of the jump of 3 trials (with and without using arms) was taken into account. CMJ height was calculated based on the flight time. Relative difference with-without arms was estimated as a ratio of difference between CMJ height with arms and CMJ height without arms, divided by CMJ height without arms. High-frequency (60Hz) video clip was captured (Fujifilm Finepix HS10) simultaneously for the analysis or arm to leg coordination. Coordinated jumpers used posterior-anterior arm swing, while non-coordinated jumpers did not use arm swing or even anterior-posterior swing. Figure 1 shows a child executing vertical jump: child with fixed arms (Figure 1, left) and child with using arms (Figure 1, right).

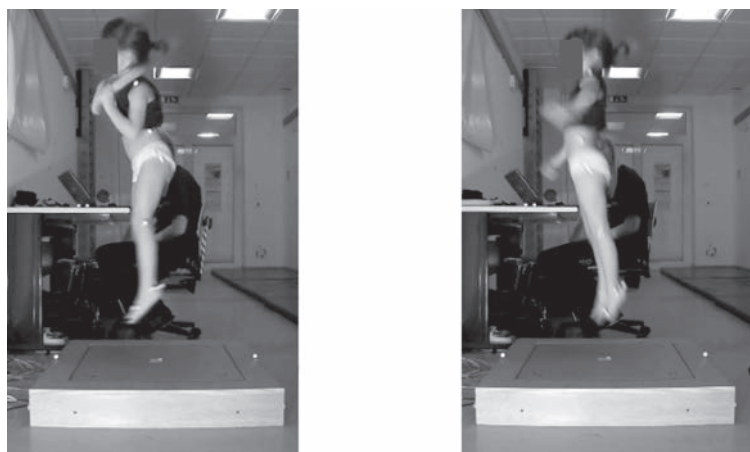

Figure 1. Jumping without using arms (left) and jumping with using arms (right).

*Statistics:* All statistical analysis was conducted using a software package of SPSS for Windows and Microsoft Excel program. Data are presented as means with standard deviation. There was no major deviation from normal distribution. Gender differences were tested with one-way ANOVA. Longitudinal changes were analysed with repeated measures ANOVA, where improvement in jump performance of coordinated and non-coordinated jumpers was analysed with repeated measures ANOVA and one fixed factor (jump coordination). Level of confidence was at  $P < 0.05$ .

## Results

In the project 96 children had successfully performed CMJ task at age four and 98 children at age five. In two consecutive years 86 children have performed both CMJ tasks, while others didn't because they were sick or they were afraid of measurement setup. In the Figure 2 we can see that there was an improvement in jumping with and without using arms after one year. Skewness characterizes the degree of asymmetry of a distribution around its mean. Positive skewness indicates a distribution with an asymmetric tail extending towards more positive values. As the skewness statistic departs further from zero, a positive value indicates the possibility of a positively skewed distribution. The skewness statistic is positive so the distribution is positively skewed. In fact, the difference between the more positively skewed distribution at age 4 and the less positively skewed distribution at age 5 indicates of how much children had learned, improved the jump

height while ageing. Kurtosis characterizes the relative peakedness or flatness of a distribution compared to the normal distribution. Positive kurtosis indicates a relatively peaked distribution. The positive value indicates the possibility of a leptokurtic distribution. A kurtosis value of +/-1 is considered very good for most psychometric use.

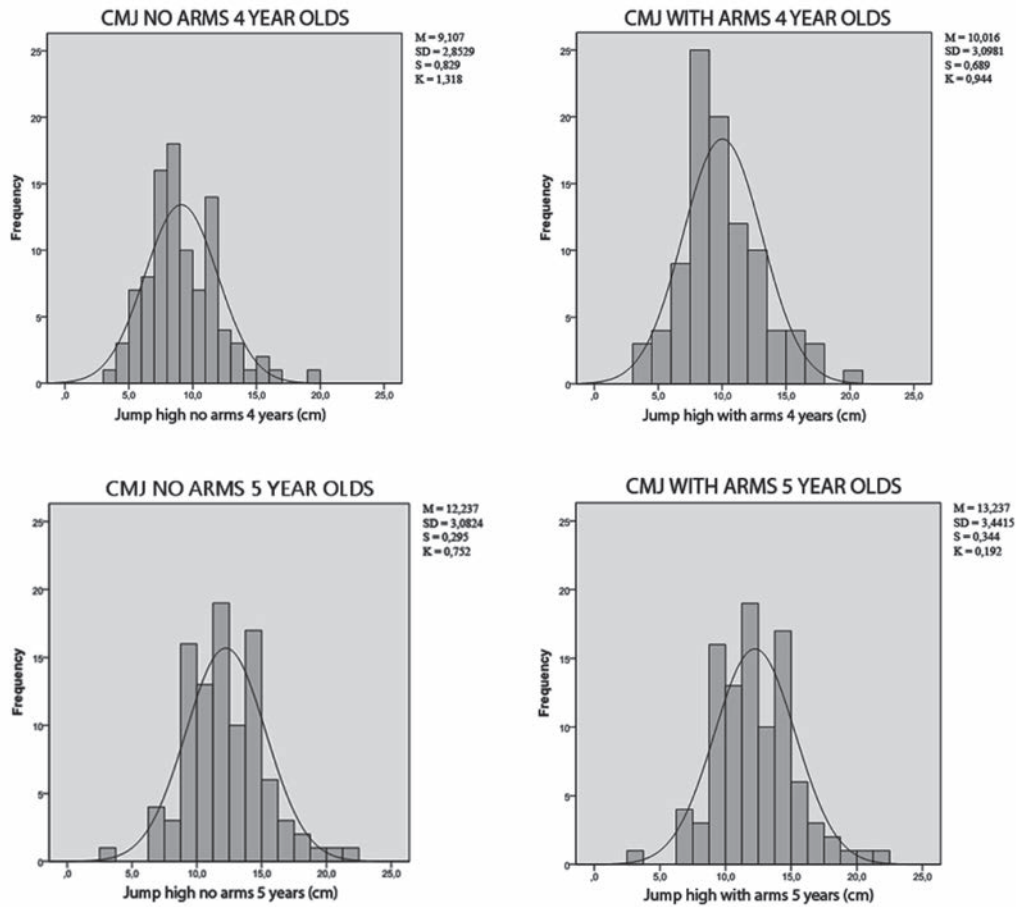

Figure 2. Frequency histograms of vertical jump height.

Table 1. Descriptive analysis of participant's data with statistical test of gender differences.

	4-years			
	All	Boys	Girls	P <sub>GENDER</sub>
N	96	46	50	
Body height / cm	107.9 ± 4.6	107.7 ± 4.8	108.0 ± 4.4	0.751
Body mass / kg	18.5 ± 2.7	18.6 ± 2.6	18.4 ± 2.8	0.791
Fat mass / %	15.8 ± 2.9	15.0 ± 2.9	16.6 ± 2.6	0.006*
Muscle mass / kg	5.4 ± 0.9	5.8 ± 0.8	5.1 ± 0.8	<0.001*
CMJ height without arms / cm	9.1 ± 2.9	9.3 ± 3.2	8.9 ± 2.5	0.571
CMJ height with arms / cm	10.0 ± 3.1	10.4 ± 3.4	9.7 ± 2.7	0.230
Rel. diff. with-without arms / %	11.9 ± 18.6	14.9 ± 17.7	9.2 ± 19.1	0.131
Coordinated jumpers / %	34.0	36.4	32.0	
	5-years			
	All	Boys	Girls	P <sub>GENDER</sub>
N	98	47	51	
Body height / cm	115.4 ± 5.2	114.9 ± 5.3	115.9 ± 5.0	0.319
Body mass / kg	21.0 ± 3.6	20.9 ± 3.7	21.2 ± 3.5	0.725
Fat mass / %	16.2 ± 4.0	15.0 ± 3.7	17.3 ± 3.9	0.004*
Muscle mass / kg	6.3 ± 1.1	6.7 ± 1.1	5.9 ± 0.9	<0.001*
CMJ height without arms / cm	12.2 ± 3.1	11.9 ± 3.1	12.5 ± 3.1	0.308
CMJ height with arms / cm	13.2 ± 3.5	12.6 ± 3.1	13.9 ± 3.6	0.058
Rel. diff. with-without arms / %	9.0 ± 14.4	7.1 ± 15.8	10.9 ± 13.0	0.198
Coordinated jumpers / %	68.0	59.6	76.0	

CMJ – Counter movement vertical jump; \* P < 0.05

Table 1 presents descriptive data of selected children morphological characteristics and jumping performance. Furthermore, a gender comparison was made. At the age of four and five we found significant gender differences just in fat mass and muscle mass. Boys have higher muscle mass and lower fat mass. We found that effect of age is statistically significant ( $P < 0.001$ ). The two groups (with and without arms) have roughly the same progress in one year.

## Discussion

In our study, we have focused on the vertical jump, because it is the most natural form of jumping and is therefore the easiest way to implement for pre-school children. Also to being practical, vertical jump is a good index of leg power (Perrine, 1986).

There was no gender difference in jumping performance. Children jump with arm swing higher than with arms fixed, just as adults, and they further improve their jumping height performance (with and without arms) within one year.

Vertical CMJ performance is clearly dependent of muscle explosive power and with it largely on muscle strength, volume. If we compare elite boys (handball players) with non-elite boys, we found out that elite boys jump 9% higher than non-elite ones (Bencke, Damsgaard, Saekmose, Jørgensen P., Jørgensen K. & Klausen, 2002).

In our study boys have more muscle mass, but Šimunič and Pišot (2010) found that there are no gender differences in leg muscles architecture, which is very important for the muscle power development and therefore for CMJ performance. Moreover, there are two principles of child motor development (cefalo-caudal and proximal-distal) that are very intense in preschool children. Therefore, it could be quite commonly understood that child muscle mass could not be fully controlled and used for explosive power development.

One of the rare studies of CMJ in young children is the study of Neelly and Zebas (2003). They reported average CMJ height (arms used) 18.8 cm in 4.5 year old sample of young children. However, this cannot be directly comparable with our data, since they used video analysis and not tensiometric plate for determining jump height.

In jumping it is very important to use passive upper body segments for central dynamic moments of inertia to get better jumping performance. However, improving the performance of the jump at age of four years is probably due more to differences in the body structure and muscle strength as the result of coordination and control. The authors believe that in the age of 6.5 years the technique of using arms while jumping is already developed (Harrison & Moroney, 2007). The Survey of Neelly and Zebas (2003) found that the kinetically more efficient jumpers, aged four, jumped 19% higher compared to jumpers who didn't use arms, on the other hand, kinetically less efficient jumpers didn't differ between jumping techniques. Furthermore kinetically more efficient group of jumpers jumped 30% higher than kinetically less efficient jumpers. (Neelly & Zebas, 2003).

However, we must not forget that high relative differences between CMJ height with and without arms could also occur in children with very low CMJ without arms (e.g., 1 to 2 cm).

In conclusion we could emphasize that we have set CMJ heights in four and five year old children. It would be interestingly to see how the CMJ performance will develop in those children after another year.

## References

1. Bencke, J., Damsgaard, R., Saekmose, A., Jørgensen, P., Jørgensen, K. & Klausen, K. (2002). Anaerobic power and muscle strength characteristics of 11 years old elite and non-elite boys and girls from gymnastics, team handball, tennis and swimming. *Scandinavian Journal of Medicine & Science in Sports*, 12(3): 171–8.
2. Clark, J. E., & Phillips, S. J. (1985). A developmental sequence of the standing long jump. In J.E. Clark & J.H. Humphrey (Eds.). *Motor development: Current selected research* (Vol. 1). Princeton, N.J.: Princeton Book Co. 73-85.
3. Cools, W., De Martelaer, K., Vandaele, B. Samaey, C. and Andries, C. (2009). Fundamental movement skill development of four to six year-old pre-school children in Flanders. In *Contemporary Sport, Leisure and Ergonomics*. Routledge, New York, 335-352.
4. Davies, M. (2003). *Movement and dance in early childhood* (2<sup>nd</sup> ed.). Paul Chapman publishing. London.
5. Deli, E., Bakle, I. and Zachopoulou, E. (2006). Implementing intervention movement programs for kindergarten children. *Journal of Early Childhood Research*, 4 (1), 5-18.
6. Gallahue, D.L. and Ozmun, J. C. (2006). *Understanding Motor Development. Infants, Children, Adolescent, Adults*, International edition. McGraw-Hill Companies, Inc.
7. Gallahue, D.L. (1996). *Developmental Physical Education for Today's Children* (3<sup>rd</sup> ed.). Brown & Benchmark Publisher.
8. Harrison, A.J. and Gaffney, S. (2001). Motor development and gender effect on stretch shortening cycle performance. *Journal of Science and Medicine in Sport*, 4, 406-415.
9. Harrison, A.J., Moroney, A. (2007). Armaugmentation of vertical jump performance in young girls and adult females. XXV ISBS Symposium, Ouro Preto – Brazil.
10. Haywood, K.M., Getchell, N. (2005). *Life Span Motor Development* (4<sup>th</sup> Edition). Human Kinetics
11. Malina, R. (1996). Tracking of physical activity and fitness across the life span. *Research Quarterly for Exercise and Sport*, 67, 48-57.

12. Medeková, H., Zapletalová, L. and Havlíček, I. (2000). Habitual Physical Activity in Children according to their Motor Performance and Sports Activity of their Parents. *Acta Universitatis Palackinae Olomucensis*. 2000 (1), 21-24.
13. Neelly, K.R. & Zebas, C.J. (2003). Vertical jump kinetics in young children. Retrieved May 14, 2011, from: <http://www.asbweb.org/conferences/2003/pdfs/125.pdf>
14. Perrine, J.J. The biophysics of maximal muscle power outputs: Methods and problems of measurement. In *Human Muscle Power*. N. L. Jones, N. McCartney, and A. J. McComas, eds. Champaign, IL: Human Kinetics, 1986. pp. 15–24.
15. Riddiford-Harland, D. L., Steele, J.R. and Baur, L.A. (2007). Upper and lower limb functionality. Are these compromised in obese children? *International Journal of Pediatric Obesity*, 1 (1), 42-49.
16. Strong, W.B., Malina, R.M., Blimke, C.J., Daniels, S.R., Dishman, R.K., Gutin, B., et al., (2005). Evidence based physical activity for school-age youth. *Journal of Pediatrics*, 146, 732-737.
17. Šimunič, B. & Pišot, R. (2010, October). Development, significance and exercise of Achillestendon in children. In: R. Pišot, V. Štemberger, B. Šimunič, P. Dolenc, R. Malej (Chair) *Child in motion*. University of Primorska, Science and Research Centre, Portorož, Slovenia.
18. Wrotniak, P.T., Epstein, L.H., Dorn, J.M., Jones, K.E. and Kondilis, V.A. (2006). The relationship between motor proficiency and physical activity in children. *Pediatrics*, 118, 1758-1765.

## CAREER OPTIONS OF AEROBICS AND AQUA FITNESS INSTRUCTORS IN LIFELONG LEARNING IN SLOVAKIA

Jana Labudová, Oľga Kyselovičová and Veronika Tirpáková

*Faculty of Physical Education and Sport, Comenius University, Bratislava, Slovakia*

### Purpose

In the context of lifelong learning experts, especially in recreational physical activities in Europe, the question of unified education system resonates for the last few years. Particular attention is given to structure of training programs to fill their content, lecturer's competency, technical background as well as finalization of outputs. Effort of training professionals of countries in the European region is to improve the training and eventual unification of the required criteria for granting certificates of proficiency for future trainers and lecturers in the lifelong learning platforms and their registration.

The authors give the information about the coaches career options of aerobics and aqua fitness instructors in Slovakia within the European educational framework by creating 1) a properly specified e-learning programs, which cover the minimum standards for both the theory and the practical skills and competencies, 2) a platform for an interactive national professional register which will collaborate with other international registers in Europe.

### Methods

The analysis of the curriculum, technical background, quality of lecturers and officers is used to create a coherent Slovakian qualification structure.

### Results

The health and fitness instructor competence framework specifies the minimum knowledge, skills and competencies required by the European educational framework. Currently, 5 qualification levels system of aerobics and aqua fitness instructor's career option is unified in Slovakia. All study programs must be accredited by Ministry of Education, Science, Research and Sport of Slovak Republic. The certificates can be obtained either by the lifelong learning programs, involving general and special part of the training providing teachers with adequate professional profiles, or by full-time study at accredited universities. No single phase of the unified registration at the supranational level is completed.

### Conclusion

The e-learning methodology overcomes economic and territorial barrier, favoring the exploitation of the project in Slovakia.

**Key words:** *unified qualification system, e-learning methodology, study programs*

## SEXUAL DIFFERENTIATION OF MORPHOLOGICAL CHARACTERISTICS AND MOTOR ABILITIES OF ELEVEN-YEAR-OLD CHILDREN

Julijan Malacko<sup>1</sup>, Aleksandra Pejčić<sup>2</sup> and Biljana Trajkovski<sup>2</sup>

<sup>1</sup>Faculty of Sport and Physical Education, University of Novi Sad, Serbia

<sup>2</sup>Faculty of Teacher Education, University of Rijeka, Croatia

### Abstract

The aim of the research is to analyze the sample of 228 eleven-year-old children of both sexes (125 boys and 103 girls) using analysis of variance (MANOVA / ANOVA), and establish sexual differentiation in 12 morphological and 18 motor variables. The results showed that among boys and girls in the system of morphological and motor variables there are multivariate statistically significant differences in arithmetic means at  $p=0.0$ . The boys had better value in 10 out of 12 morphological variables, and the girls in two, whereas the boys had better value in 11 out of 18 motor variables, and the girls in 7 variables. The conclusion is that in morphological area of children at this age there is just a start of the development process based on the gender differentiation and genetic determination, while the sexual differentiation of the motor area is more expressed with boys.

**Key words:** boys and girls, eleven-year-olds, morphological characteristics, motor abilities, sexual differentiation, analysis of variance

### Introduction

Children in the period of childhood and adolescence must satisfy their movement needs, and school must enable them to do so and thus they will be able to maintain and develop their overall anthropological status (morphological, motor, functional, intellectual, psychological, social, etc). The interaction between particular anthropological segments that are considered integral parts of human personality does not allow any hierarchy among them to be established (Trajkovski-Višić, Plavec & Rastovski, 2008). Therefore, the problems of sexual differentiation, which are within a group of problems of total anthropological status of children, have a significant scientific and real-life interest (Gudelj et al., 2009).

Bearing in mind the previous facts, the regularity of development should not be denied, and this regularity indicated that human abilities and characteristics can be developed most successfully in time periods when it is objectively possible (Malacko & Pejčić, 2009). In professional literature these periods are often called "critical periods" (Gužalovskij, 1984) and they are regarded as ontogenetic periods. Within their limits and on the basis of natural laws the greatest tempo of the development of certain personal characteristics and abilities is achieved, capacity of adaptation to the environmental factors is enhanced and the most favourable preconditions are created for certain skills and habits development and information acquisition. The starting assumption is that, in these periods, the human organism is more than in other periods susceptible to external stimuli (transformations), if they are, by their direction, in accordance with the general tendencies of natural course of morphological and motor changes (Pejčić & Malacko, 2005).

The aim of this research is to determine statistically significant multivariate and univariate sexual differentiations in arithmetic mean of morphological and motor variables in the case of eleven-year-old children for the purpose of more optimal modelling, diagnosis, planning, programming and implementing of the control process of teaching and training process.

### Methods

The sample of subjects consisted of 228 eleven-year-olds (125 boys and 103 girls).

The sample of variables consisted of 30 variables, of which 12 variables of morphological characteristics and 18 variables of motor skills.

Test	Measured capacity	Measuring unit
<i>Morphological variables:</i>		
BOH - body height	<i>dimensions of the skeleton</i>	mm
SHW - shoulder width	"	"
PGW - pelvis girdle	"	"
BOM - body mass	<i>body mass and volume</i>	kg
FOC - forearm circumference	"	mm
UPC - upper arm circumference	"	"
THC - thigh circumference	"	"
CAC - calf circumference	"	"
WAC - waist circumference	"	"
UAS - upper arm skinfolds	<i>subcutaneous fatty tissue</i>	mm
SUS - subscapular skinfold	"	"
ABS - abdominal skinfold	"	"
<i>Motor variables:</i>		
PTJ - passing through and jumping over	<i>body coordination</i>	sec
AGA - agility in the air	"	"
OCB - obstacle course backwards	"	"
S3B - slalom with three medicine balls	<i>leg-hand coordination</i>	sec
S2B - slalom by kicking two balls	"	"
HDR - hand dribbling	"	"
HTA - hand tapping	<i>frequency of movement</i>	fr
FTA - foot tapping	"	"
FTW - foot tapping against the wall	"	"
SLJ - standing long jump	<i>explosive strength</i>	cm
MTL - medicine ball throw from supine lying	"	"
20R - 20m running from the standing start	"	sec
ASB - all-out declined sit-ups off the bench	<i>strength endurance</i>	No of repetitions
AHB - all-out hyperextension on the box	"	"
UCB - undergrip chin-ups on the bar	"	"
BFB - bent forward on the bench	<i>flexibility</i>	cm
SSR - straddle sit-and-reach	"	"
SCB - shoulder circumduction backwards with a stick	"	"

In order to determine the differences in the values of arithmetic means of the applied variables between boys and girls, method of analysis of variance (MANOVA/ANOVA). Multivariate testing of null-hypothesis stating that centroids of the groups equal the common centroid (GENERAL MANOVA) is carried out by 1 - Wilks' Lambda test, Rao's R - Rao's coefficient and p - statistical significance ( $p > .05$ ). Univariate statistical significance of differences between the values of arithmetic mean of boys and girls by the variables is calculated through F - test and p - statistical significance ( $p > .05$ ). The data processing was carried out by a software package STATISTICA 8.

## Results

Table 1 and Graphs 1, 2 and 3, where the results of morphological and motor variables are presented, clearly show that boys (Mb) had better values of arithmetic mean in 10 out of 12 variables (the variables are marked with \*), whereas girls (Mg) were better in two variables.

Table 1. Multivariate and univariate (MANOVA/ANOVA) significance of the differences (p) between arithmetic mean of the boys (Mb; N = 125) and girls (Mg; N = 103) in anthropometric and motor variables

Variables	Mb	Mg	F	p
<i>Morphological variables:</i>				
BOH - body height	1464.08	1466.34*	.06	.79
SHW - houlder width	298.56*	291.55	7.31	.00*
PGW - pelvis girdle	22.73*	22.70	.00	.92
BOM - body mass	40.84*	38.97	2.49	.11
FOC - forearm circumference	210.88*	201.45	13.70	.00*
UPC - upper arm circumference	215.56*	208.78	3.57	.06
THC - thigh circumference	458.12	458.30*	.00	.98
THC - calf circumference	300.56*	297.37	.54	.46
WAC - waist circumference	664.36*	624.70	8.02	.00*
UAS - upper arm skinfolds	6.82*	6.42	.64	.42
SUS - subscapular skinfold	5.69*	4.93	2.48	.11
ABS - abdominal skinfold	8.16*	7.08	2.00	.15
$\lambda = .71$ R = 7.08 p = .00*				

Variables	Mb	Mg	F	p
<i>Motor variables:</i>				
PTJ - passing through and jumping over	1623.94*	1704.13	1.76	.18
AGA - agility in the air	601.44*	619.72	.74	.38
OCB - obstacle course backwards	1771.80*	038.18	15.22	.00*
S3B - slalom with three medicine balls	5040.87*	5201.34	5.86	.01*
S2B - slalom by kicking two balls	7108.90*	7613.52	58.64	.00*
HDR - hand dribbling	1016.35*	1172.55	128.95	.00*
HTA - hand tapping	23.37	23.85*	1.74	.18
FTA - foot tapping	18.99	19.54*	6.00	.01*
FTW - foot tapping against the wall	17.84	18.10*	.92	.33
SLJ - standing long jump	153.89*	150.35	2.57	.11
MTL - medicine ball throw from supine lying	592.40*	522.79	57.31	.00*
20R - 20m running from the standing start	394.73	393.13*	.15	.69
ASB - all-out declined sit-ups off the bench	4.39*	3.69	4.84	.02*
AHB - all-out hyperextension on the box	15.28*	13.23	7.90	.00*
UCB - undergrip chin-ups on the bar	1.38*	1.10	5.92	.01*
BFB - bent forward on the bench	28.80	33.15*	30.55	.00*
SSR - straddle sit-and-reach	364.28	419.41*	21.56	.00*
SCB - shoulder circumduction backwards with a stick	50.26	44.34*	24.74	.00*
$\lambda = .64$ R = 10.07 p = .00*				

Legend: Mb - mean value of the boys, Mg - mean value of the girls; ANOVA: F - test, p - significance level > .05; MANOVA:  $\lambda$  - Wilks' Lambda, R - Rao's R, p - significance level > .05

Multivariate statistical significance of the differences in arithmetic mean at the level  $p = .00$  was determined only by three particular morphological variables in the case of boys (SHW - shoulder width, FOC - forearm circumference and WAC - waist circumference), which were statistically significant at the level  $p = .00$ .

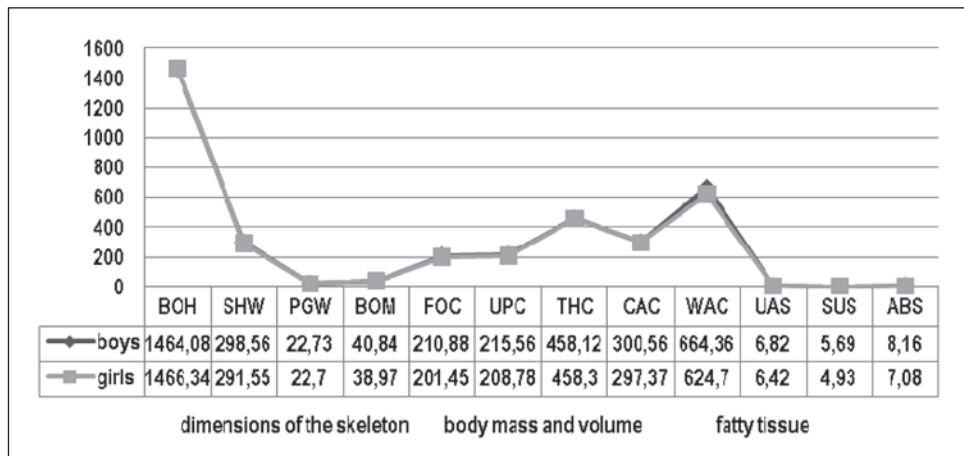

Graph 1. Morphological variables

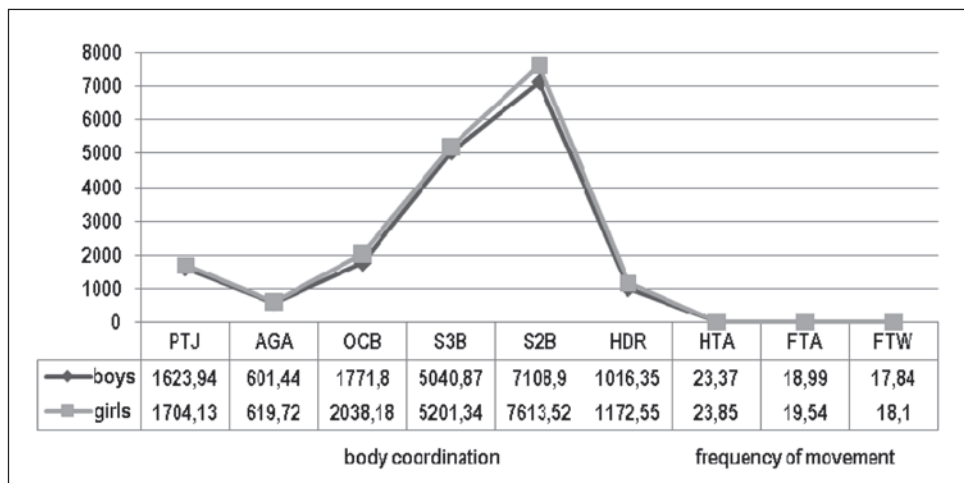

Graph 2. Motor body coordination and frequency of movement



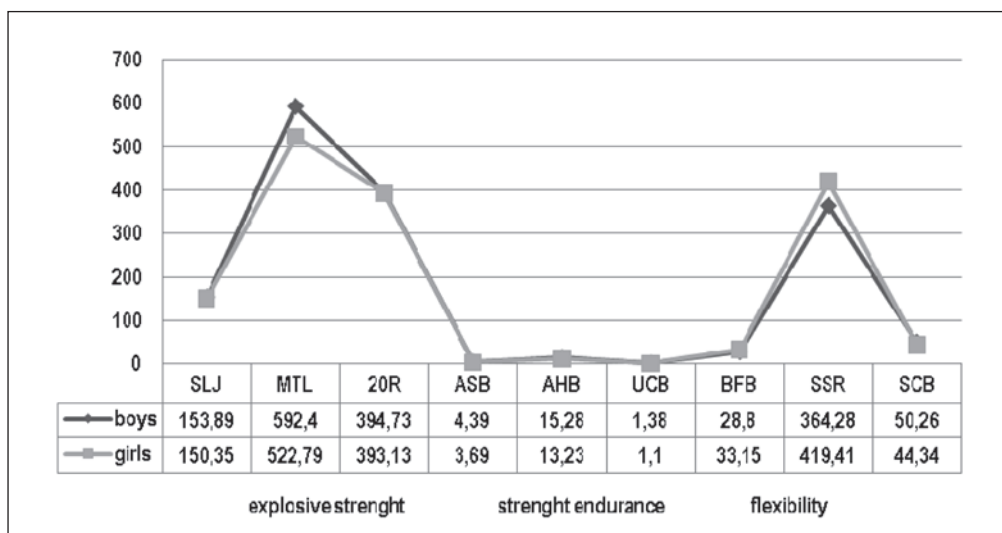

Graph 3. Motor explosive strength, strength endurance and flexibility

The boys achieved better values in arithmetic mean in 11, whereas the girls were better in 7 out of 18 motor variables. Multivariate statistical significance of the differences in arithmetic mean at the level of  $p = .00$  was determined by 8 particular variables in the boys' favour (OCB - obstacle course backwards, S3B - slalom with three medicine balls, S2B - slalom by kicking two balls, HDR - hand dribbling, MTL - medicine ball throw from supine lying, ASB - all-out declined sit-ups off the bench, AHB - all-out hyperextension on the box and UCB - undergrip chin-ups on the bar) and 4 variables in the girls' favour (FTA - foot tapping, BFB - bent forward on the bench, SSR - straddle sit-and-reach and SCB - shoulder circumduction backwards with a stick).

## Discussion and conclusion

Having analyzed the results in the morphological sense, shown in Table 1 and Graph 1, one can notice that the boys had increased values in most morphological variables along with multivariate and univariate statistical significance of differences between their values of arithmetic values ( $p=.00$ ) in their favour; therefore, it can be seen that eleven-year-olds start sexual differentiation, which is considered to be determined by mainly endogenous genetic potentials in the boys' favour.

Sexual differentiation in motor sense is more apparent in the case of boys probably due to their involvement in extracurriculum sports activities so they gained more body coordination and endurance abilities and became more explosive, whereas girls are more flexible and faster in performing the frequencies of movement probably because they have more optimal genetic potentials and have selective involvement in chosen kinesiological activities.

Owing to increased values in explosive and repetitive strength (Graph 2), the boys in term of body coordination and certain parts of body have four out of six variables (PTJ - passing through and jumping over, AGA - agility in the air, OCB - obstacle course backwards, S3B - slalom with three medicine balls, S2B - slalom by kicking two balls and HDR - hand dribbling) with statistically significant differences at the level of  $p=.00-.01$  in decreased values (actually they present increased values because they are expressed in seconds). However, the girls achieved better results in all the three variables (HTA - hand tapping, FTA - foot tapping and FTW - foot tapping against the wall) in terms of the frequency of movement (the task was to make as many repetitive movements as possible in 15 seconds), but only one variable (FTA - foot tapping) had a statistically significant difference at the level of  $p=.01$ .

Graph 3 shows that the boys achieved better results in explosive strength of lower and upper limbs (SLJ - standing long jump and MTL - medicine ball throw from supine lying), with statistically significant difference  $p=.00$  in the variable MTL, whereas the girls had better results in the variable 20R - 20m running from the standing start. The boys had better results within strength endurance (ASB - all-out declined sit-ups off the bench, AHB - all-out hyperextension on the box and UCB - undergrip chin-ups on the bar), which are also statistically significant at the level of  $p=.00-.02$ . The girls achieved much better results than boys within the flexibility variable (BFB - bent forward on the bench, SSR - straddle sit-and-reach and SCB - shoulder circumduction backwards with a stick), which are statistically significant at the level of  $p=.00$ .

The obtained results lead to conclusion that development processes based on sexual differentiation and genetic determinedness are just to start in morphological sense in the case of eleven-year-old children. Sexual differentiation in motor sense is somewhat more expressed because boys, probably due to their involvement in kinesiological activities,

gained better motor coordination and strength endurance and became more explosive, whereas girls are more flexible and faster in performing the frequencies of movement probably because they have more optimal genetic potentials.

## References

1. Gužalovskij, A.A. (1984). Problemi “kritičeskijh” periodov ontogenezi i ee značeniji dlja teoriji i praktiki fizičeskogo vospitanija. *Očerki po teoriji fizičeskijh kulturi*. Moskva: Fizkuljtura i sport.
2. Gudelj, I., Milat, S., Retelj, E., Zagorac, N., Ljubičić, M. & Katić, R. (2009). Sex differences in morphological dimensions in twelve-year-old children from Imotska Krajina. *Collegium Antropologicum*, 33 1: 131–138
3. Malacko, J. & Pejčić, A. (2009). Changes in biomotor dimensions of school boys aged 11: experimental programme of sports games VS standard PE programme. *Sport Science*, 2 1: 52-61.
4. Pejčić, A. & Malacko, J. (2005). The ontogenetic development of morphological characteristics and motor abilities of boys and girls in early elementary school. *Kinesiologia slovenica*, 2 (42-55).
5. Trajkovski-Višić, B., Plavec, D. & Rastovski, D. (2008). Dependency of motor efficiency upon the morphological characteristics of four-year-old children. In *5<sup>th</sup> International Scientific Conference on Kinesiology (574-579)*. Zagreb: Faculty of Kinesiology, University of Zagreb.

## THE INFLUENCE OF MORPHOLOGICAL CHARACTERISTICS ON THE FREESTYLE SWIMMING AMONG HIGH VOCATIONAL SCHOOLS IN SARAJEVO

Edin Mirvić

*Faculty of Sports and Physical Education, University of Sarajevo, Bosnia and Herzegovina*

### Abstract

The main objective of this study was to determine the influence of morphological characteristics on the swimming crawl technique in secondary vocational schools, aged 15-17 years. For this purpose, from a sample of 85 students in second and third grade secondary school in Sarajevo, measurements were taken using 12 morphological tests. Also, collected were data on the effectiveness of crawl swimming technique, and used three tests, on a total of 15 variables. In order to determine the relation between the observed sets of variables, it was applied the factor and regression analysis. Based on the results obtained it is possible to perform a general conclusion about the relatively high and significant impact on the efficiency of morphological characteristics in crawl swimming technique. With the analysis of the impact of individual morphological variables, we can see that the largest and statistically significant impact on the criterion variable have a variable volume of the upper arm (OBNDL), width of hand (SIRS), skin fold back (NBLED) and abdominal skin fold (NBTRB) with a significance level. 05. Which leads us to the conclusion that if we have a broad hand and arm, greater volume increases the surface and creates more resistance in the water during the propulsive phase of the arm so as to there by increase the efficiency of crawl swimming technique. When it comes to skin folds back and abdomen we can conclude that "the lower skin fold higher efficiency of crawl swimming technique". It also shows giving of priority to the equation when forming the specifications on this and similar populations.

**Key words:** *morphological characteristics/ techniques in crawl swimming / students / regression analysis*

### Introduction

One of the new terms used in the numerous researches in the swimming is efficiency of swimming.

The efficiency of swimming is not viewed only from the point of the laws of biomechanics, but in terms of the spatial and temporal dimensions of movement of the swimmer through the water which points on the energy consumption in swimming activities.

The main objective of the sport swimming is rationality that manifests in the economy, even, straight line to overcome the shares with given technique.

On successful implementation undoubtedly affect the morphological characteristics, motor and functional ability and psychological components that will optimally contribute to the forming of individual style (Volčanšek, 2002).

The researches shows that it refers to the dimensionality of the skeleton (.98), voluminosity (.90), subcutaneous fat tissue (.50), that the well-programmed training will mostly affect on the transformation of the subcutaneous fat tissue, then voluminosity, at least on the dimensionality skeleton (Kazazovic, 1998).

The main objective of this Research is to determine the influence of morphological characteristics on the swimming crawl technique in secondary vocational schools, aged 15-17 years.

### Methods

#### Sample of entities

In the sample of subjects were included students from second and third grade secondary vocational school in Sarajevo in academic 2007/2008. year, aged 15-17 years.

Number of subjects which were registered both groups of variables on which made the final processing and analysis was 85 students.

#### Sample of variables

In the study was included 12 treated morphological variables and three variables to estimate the speed swimming: The sample of predictor variables Variables for assessment of morphological characteristics of the sample. The predicted

variables for the assessment of longitudinal characteristics of the human body (length): 1<sup>st</sup> body height (VISTJ), 2 arm length (DUZRK), 3 leg length (DUZNG), The predicted variables to estimate the transverse characteristics of the human body (width, range): 1<sup>st</sup> Hand width (SIRS), 2 width of the wrist (DIRZG), 3 elbow width (DILAK), The predicted variables for evaluation of circular features of the human body (volume), 1<sup>st</sup> chest circumference (OBGRU), 2 volume nadlaktce (OBNDL), 3 body mass (MASTJ). The predicted variables for assessment of subcutaneous fat tissue of the human body: 1<sup>st</sup> skin fold (NBNDL), 2 back skinfold (NBLED), 3 abdominal skinfold (NBTRB). The sample of criterion variables: As the criterion variable there was: 1<sup>st</sup> start time to 10-th meter (PKS10), 2 during the turn 5 +5 (PKO55), 3 swimming 50 meters (PK50M).

### Data processing methods

To determine the relation between the predictor (morphological characteristics) and criterion (start time to 10-meters, during the 5 +5 turns and swim 50 meters with the drawn first factor common component-factor analysis) variables it was applied the regression analysis.

### Results and discussion

Regression analysis of the first principal component in swimming crawl

After examining the tables of regression analysis of the first principal component of the criterion variable crawl swimming technique (tables of no. 1 to 3) in the space of manifest morphological characteristics it was observed a lack of information about the impact of applied morphological variables on success in crawl swimming technique.

Correlation of predictors with the criterion variable was  $R = .566$ , and explains 32% of common variability. Such an association at the significance level .05.

With the analysis of the impact of individual morphological variables (Table no. 3), we can see that the largest and statistically significant impact on the criterion variable have a variable volume of the upper arm (OBNDL), hand width (SIRS), skin fold back (NBLED) and abdominal skin fold (NBTRB) with significance level .05.

From the analysis, we can see that the width of the hand, circumference of upper arm, back skin fold and abdominal skin fold had a positive impact on the efficiency of crawl swimming technique, which gives us the answers, in terms of: the larger the width of the hand and circumference of upper arm, the better propulsion and movement in the propulsive phase of work on hand, assisted with skin fold back and the stomach contributes to better performance in crawl technique. Similar results were obtained by Mirvić, Mekić M. (2008) in his research on the population of student Sport School in Sarajevo, where a width of the hand affected on a higher speed swimming freestyle. In this research, we can conclude that the biggest impact was made by these four variables, which we can see the significance of the coefficient of their analysis and to have an impact on the efficiency of crawl swimming technique, it should be pointed out that if we have a broad hand and arm greater volume it increases the surface and creates greater resistance in the water during the propulsive phase of the arm so as to thereby increase the efficiency of crawl swimming technique.

When a comes to skin folds back and abdomen it can be concluded that “the lower skin fold it is higher efficiency of crawl swimming technique. Also shows and giving priority to the equation when forming the specifications on this and similar populations, so for example Poujade, B., CA Hautier, Rouard A., (2002) in their research which did not get a significant correlations obtained in young swimmers, between the morphological characteristics and energy consumption with freestyle swimming.

A modest number of other valid partial regression coefficients obtained in the framework presented in the regression analysis suggests that the prediction (forecast) of the impact of predictors on the criterion variable can only be performed with the help of the whole system of predictor variables.

Table 1. Model Summary

Model	R	R Square	Adjusted R Square	Std. Error of the Estimate
1	,566	,320	,157	,917

Table 2. ANOVA

Model		Sum of Squares	df	Mean Square	F	Sig.
1	Regression	19,864	12	1,655	1,964	,048
	Residual	42,136	50	,843		
	Total	62,000	62			

Table 3. Coefficients

Model		Unstandardized Coefficients		Standardized Coefficients	t	Sig.
		B	Std. Error	Beta		
1	body height	,005	,003	,358	1,660	,103
	arm length	-,003	,006	-,108	-,527	,601
	leg length	,000	,003	,010	,055	,956
	Hand width	-,098	,040	-,539	-2,487	,016
	width of the wrist	,077	,061	,278	1,267	,211
	elbow width	-,056	,085	-,266	-,661	,511
	chest circumference	-,008	,012	-,381	-,657	,514
	volume nadlaktce	,045	,021	1,187	2,167	,035
	body mass	,000	,000	-,032	-,056	,956
	skin fold	,029	,064	,112	,450	,655
	back skinfold	-,452	,163	-1,842	-2,781	,008
	abdominal skinfold	,183	,080	1,386	2,273	,027

## Conclusions

The main objective of this research is to determine the influence of morphological characteristics on the swimming crawl technique in secondary vocational schools, aged 15-17 years.

For this purpose, a sample of 85 students in second and third grade secondary vocational school in Sarajevo, measurements were conducted using 12 morphological tests. Also gathered were data on the effectiveness of crawl swimming technique, and there were used three tests, a total of 15 variables. In order to determine the relation between the observed sets of variables there was applied the factor and the regression analysis.

Based on the results obtained it is possible to perform a general conclusion about the relatively high and significant impact on the efficiency of morphological characteristics in crawl swimming technique. Dominant predictive value had four morphological tests which were isolated and shown substantial the efficiency for crawl swimming technique in this research. It can be concluded that these four variables (circumference of upper arm (OBNDL), width of hand (SIRS), skin fold back (NBLED) and abdominal skinfold (NBTRB)) are essentials for the formation of the equation specification swimming - freestyle, in this and perhaps a similar population, and that success in the technique swimming - crawl important part of having an impact and other factors, especially in the domain of motor skills.

For mentioned reasons, the results of this research will be primarily of direct importance in selecting candidates for swimming training, specifically the crawl technique, developing a hypothesis for future research, as well as for improving the teaching-learning process in vocational school.

## References

- Grčić, Z.N. (1996). Efficiency of different programs and possible facts of success of swimming teaching. Doctoral dissertation, FFK, Zagreb.
- Kazazović, B. (1998). Swimming like sport and mean of healthy and physical education. Ministry of education science culture and sport, Federation BiH.
- Mekić, M. (1995). Quantitative methods in kinesiology. Faculty of Sports and Physical Education, Sarajevo.
- Mirvić, E. (1999). Checking of statement of model of elementary school swimming by system: A, B, C, D, E. Graduation thesis, FFK, Sarajevo.
- Mirvić, E., F. Rašidagić (2002). Effects of application of cliffiront methods of working to program of school for training of non – swimming, Sport in theory and practice I/02, 71- 78, Institution for physical culture, Sarajevo.
- Mirvić, E., M. Mekić (2008). Influence of morphological characteristics on the swimming front crawl technique participants first and second grades Sport Gymnasium in Sarajevo. 5<sup>th</sup> International Scientific Conference in Kinesiology. Faculty of Kinesiology, Zagreb, Croatia. 842 - 844<sup>th</sup>
- Mirvić, E., Radjo, I., Hodzić, M., Agacević, Z. (2010). Impact of different methods at the school program for training non-swimmers. Biomechanics and Medicine in Swimming XI, Oslo, Norverška, 116-117
- Poujade, B., Hautier, C., Rouard, A. (2002). Determinants of the energy cost of front-crawl swimming in children, European Journal of Applied Physiology, Volume 87, Number 1, 1-6.
- Rado, I. (1998). Transforming processes of motor and functional abilities and different in swimming. Doctoral dissertation, Faculty for physical culture, University of Sarajevo.
- Šoše, H., Rado, I. (1998). Measurement in Kinesiology, Faculty of Physical Education, Sarajevo, pp. 101.
- Vidović, N. (1999). Correlation of morphological characteristics and motor readiness (abilities) with degree of adoption stylized movements in swimming among students youth. Doctoral dissertation, Faculty for physical culture, University of Sarajevo.
- Volčanšek, B. (2002.) Bit of swimming. Faculty of Kinesiology, University of Zagreb.

## SCHOOL FOR HEALTH: PAQ-C QUESTIONNAIRE CORRELATION WITH FACTORS OF ACTIVE LIFESTYLE IN CHILDREN

Valentina Moisis and Massimo Lanza

*Department of neurological, neuropsychological, morphological and movement sciences  
Faculty of Exercise and Sport Sciences, Verona, Italy*

### Purpose

PAQ-C is a questionnaire that provide a general measure of physical activity for children from ages 8-14; the aim of this study was to verify the correlation among PAQ-C and anthropometric measures, stage of change about physical activity assessed with PASCQ, levels of physical fitness (PF), enjoyment in PA, knowledge in healthy lifestyle and levels on Perceived of Physical Ability in Italian students aged 10 to 11 years.

### Methods

74 students (43 females and 31 males) included in a scholastic project about promotion of physical activity and healthy lifestyle were involved in a evaluation protocol. PF were assessed with the Eurofit Fitness Test Battery (adapted) while behaviors and attitudes towards physical activity were measured through some questionnaires: PAQ-C, PACES (physical activity enjoyment scale), PPA subscale (Perceived Physical Ability scale), and PASCQ (Physical activity stage of change), finally the knowledge on healthy lifestyle were assessed with a not standardized multiple choice questionnaire.

### Results

The PAQ-C was not related with any anthropometric parameters instead it was positively with the scores of PACES ( $r=0,286$   $p<0,05$ ) and only one physical ability parameters: handgrip ( $r=0,273$   $p<0,05$ ). Finally it was negatively correlated with questionnaire about lifestyle knowledge ( $r=0,273$   $p<0,05$ ).

On the other hand PASCQ was significantly correlated with many measures: a) anthropometric parameters: BMI ( $r=-0,383$   $p<0,01$ ), waist circumference ( $r=-0,316$   $p<0,01$ ) and waist to hip ratio ( $r=0,238$ ); b) physical fitness: balance ( $r=0,282$   $p<0,05$ ), handgrip ( $r=-0,232$   $p=0,05$ ), sit-ups ( $r=0,239$   $p<0,05$ ); and c) the perceived of physical activity: PPA Subscale ( $r=0,282$   $p<0,05$ ).

### Conclusions

From our data, the questionnaire PAQ-C does not seem to be correlated with the main factors that characterize the active lifestyle: BMI, fitness level and perception of abilities.

Instead the questionnaire PASCQ shows larger correlations with these factors. Also considering that PASCQ is quick and easy to use by children, in the future will be reasonable to study and to validate an adapted version of PASCQ for children.

## DIFFERENCES IN PREFERENCES TOWARD SPORT ACTIVITIES OF FEMALE STUDENTS ON UNIVERSITY OF ZAGREB

**Snježana Mraković, Marijana Hraski and Marija Lorger**

*Faculty of Teacher Education, University of Zagreb, Croatia*

### Abstract

The aim of this research is to establish the differences in preferences toward sport activities between female college students. The research was conducted on a sample of 255 female students from Faculty of Kinesiology, Faculty of Teacher Education and Faculty of Medicine. For evaluating the preferences toward sport activities the questionnaire was applied. The questionnaire contains list of 60 sports based on the scale of behavioural aims with grades from one to five. For determining the difference within all subjects the ANOVA was used. The obtain results show a statistically significant differences in preferences toward sports between all groups. The most differences are established between students of Faculty of Kinesiology and Faculty of Medicine, little less differences are recognized between participants from Faculty of Kinesiology and Faculty of Teacher Education. Between Faculty of Teacher Education and Faculty of Medicine is noticeably less statistically significant differences in preferences toward sport activities.

**Key words:** *higher education institutions, health promotion, physical activity*

### Introduction

A fast way of life, the affect of society on the individual and increasingly demanding obligations of everyday life have an impact on every person including the student population in every respect. These trends, among of all others, have a great influence on selection a particular type of physical activity in leisure time.

Today's students, except they are forced to think about their future professions and occupations, they must make great efforts to ensure the basic needs for living (such as accommodation, food, finances, ect.). In such a way of life physical activity is increasingly appreciate as one of the basic biological needs of human which strives not only satisfy daily needs for exercise, but also to maintain physical and mental health (Kravitz, 2007). However, after second year of study, students of Zagreb University are faced with the end of a systematic and organized physical activity in their schooling. Therefore, it is extremely important that they get as much amount of knowledge and information about the importance of exercise and daily physical activity to use those findings and experiences in the future (Gošnik et al., 2002).

For the needs of this research the Faculty of Kinesiology, Faculty of Teacher Education and Faculty of Medicine are selected. The students of Faculty of Kinesiology are involved in every day systematic exercise during the entire studying, while the students of Faculty of Teachers Education and Faculty of Medicine have once a week physical education lesson on the first and second year. Namely, one of the main reasons for choosing these faculties for this research is that in the basis of their future occupation (professor of kinesiology, teacher and doctor) are preservation of health, healthy lifestyle, health promotion and prevention, educating children about the significance of practicing physical activity etc. Therefore, the students of strict these faculties were selected to determine their interest in sports activities, because relation of a part of the population, in this case students, according to a specific sport indicates to the social position and development of sport in that moment on one side and completes the description of the tested segment of the population on the other side (Prot & Bosnar, 2000).

The aim of this research was to establish the differences in preferences toward sport-recreational activities between female students from Faculty of Kinesiology, Faculty of Teacher Education and Faculty of Medicine, University of Zagreb.

### Methods

The research was conducted during academic year 2009/2010 on a sample of 255 female students from three faculties of the University of Zagreb. Participants were 78 female students from Faculty of Kinesiology (FK), 84 female students from Faculty of Teacher Education (FT) and 93 female students from Faculty of Medicine (FM). All examinees were 19-22 years of age.

Questionnaire was applied to evaluate preferences toward sport activities through list of 52 sports based on the scale of behavioural aims with grades from one to five, prepared by F. Prot (Prot & Bosnar, 2000). To that list was added 8 more sports which were considered to be generally known and attractive to the younger population. Statistical analyses

were performed by STATISTICA 7.1. For determining the differences of preference for certain sports between female students of three faculties the Analysis of variance (ANOVA) was used.

## Results and discussion

Presented are statistically significant differences in preferences toward sport activities between female students of Faculty of Kinesiology and Faculty of Teacher Education (Table 1). Differences between students of those two faculties are noticed in many various sports, such as team sports (basketball), recreational sports (badminton, bicycling, sledding, etc.), aesthetic sports (artistic gymnastics, acrobatics, synchronized swimming, etc.), sports that were specified in some earlier studies (Oglesby & Hill, 1993) as so-called “feminine” sports (aerobics, rollerblading, dance, etc.), sports determined in earlier studies (Špehar et al., 2008) like so-called “male” sports (wrestling, rugby, ice hockey, etc.) and in some outdoor sports like skiing, snowboarding, windsurfing and swimming. The students of Faculty of Kinesiology prefer skiing, artistic gymnastic, athletic, windsurfing, water-skiing and snowboarding, while the students of Faculty of Teacher Education favour swimming, rollerblading, dance, bicycling, badminton, sledding and aerobics (Table 1). These two groups differ in numerous sports.

Table 1. ANOVA results and mean values preferences toward sport activities of female students from Faculty of Kinesiology (FK) and Faculty of Teacher Education (FT), (level of significance  $p < 0,05$ )

	Mean FK	Mean FT	SS Effect	df Effect	MS Effect	F	p
Swimming	3,45	4,00	12,29	1,00	12,29	11,22	0,00
Skiing	3,55	2,77	24,45	1,00	24,45	18,45	0,00
Rollerblading	3,96	4,29	4,25	1,00	4,25	3,95	0,05
Ice hockey	2,40	1,70	19,54	1,00	19,54	17,34	0,00
Basketball	2,92	2,42	10,37	1,00	10,37	6,15	0,01
Artistic gymnastics	3,19	2,56	16,19	1,00	16,19	9,86	0,00
Acrobatics	3,00	2,25	22,75	1,00	22,75	14,34	0,00
Athletics	3,08	2,39	18,93	1,00	18,93	10,60	0,00
Dances	3,77	4,29	10,79	1,00	10,79	8,26	0,00
Table tennis	2,50	2,95	8,28	1,00	8,28	4,99	0,03
Bicycling	3,12	4,00	31,65	1,00	31,65	21,83	0,00
Boules	1,76	2,12	5,32	1,00	5,32	4,65	0,03
Badminton	3,05	4,27	60,45	1,00	60,45	54,80	0,00
Wrestling	2,06	1,64	7,18	1,00	7,18	6,04	0,02
Water-skiing	3,42	2,77	17,05	1,00	17,05	9,16	0,00
Sledding	2,78	3,83	44,7	1,00	44,7	29,20	0,00
Windsurfing	3,05	2,42	16,29	1,00	16,29	9,23	0,00
Rugby	2,29	1,87	7,33	1,00	7,33	4,89	0,03
Synchro. swimm.	2,06	2,64	13,55	1,00	13,55	9,59	0,00
Aerobics	3,40	3,81	6,87	1,00	6,87	4,33	0,04
Bowling	2,29	2,99	19,44	1,00	19,44	11,22	0,00
Snowboarding	3,21	2,61	14,46	1,00	14,46	7,21	0,01

Presented are statistically significant differences in preferences toward sports between female students of Faculty of Kinesiology and Faculty of Medicine (Table 2). These two groups of female students differ significantly in a large number of sports, including some typically “male” sports (ice hockey, boxing, weightlifting, rugby, wrestling, ect.), some typical “female” sports and physical activities (synchronized swimming, pilates, dances, ect.), team sports (football, handball, ect.), outdoor sports (rowing, riding, water-skiing, snowboarding, ect.) etc. Students of Faculty of Kinesiology more prefer skiing, artistic gymnastic, athletic, water-skiing, snowboarding and handball, while the students of Faculty of Medicine favour skating, dance, bicycling, badminton, riding and pilates.



Table 2. ANOVA results and mean values preferences toward sport activities of female students from Faculty of Kinesiology (FK) and Faculty of Medicine (FM), (level of significance  $p < 0,05$ )

	Mean FK	Mean FM	SS Effect	df Effect	MS Effect	F	p
Skating	3,04	3,47	8,01	1,00	8,01	6,27	0,01
Skiing	3,55	2,84	21,54	1,00	21,54	13,10	0,00
Ice hockey	2,40	1,59	27,56	1,00	27,56	22,27	0,00
Artistic gymnastics	3,19	2,45	23,27	1,00	23,27	12,64	0,00
Acrobatics	3,00	2,08	36,28	1,00	36,28	23,01	0,00
Athletics	3,08	2,61	9,13	1,00	9,13	4,89	0,03
Football	2,50	2,08	7,65	1,00	7,65	4,69	0,03
Dances	3,77	4,18	7,26	1,00	7,26	5,29	0,02
Rowing	2,49	2,06	7,58	1,00	7,58	5,74	0,02
Boxing	2,42	1,99	7,98	1,00	7,98	4,11	0,04
Fencing	2,01	2,58	13,68	1,00	13,68	7,93	0,01
Bicycling	3,12	3,71	14,98	1,00	14,98	9,07	0,00
Weightlifting	1,67	1,38	3,58	1,00	3,58	4,41	0,04
Handball	3,29	2,77	11,50	1,00	11,50	6,18	0,01
Badminton	3,05	3,99	37,32	1,00	37,32	30,80	0,00
Wrestling	2,06	1,48	14,28	1,00	14,28	12,84	0,00
Water-skiing	3,42	2,98	8,38	1,00	8,38	4,01	0,05
Riding	3,05	3,74	20,23	1,00	20,23	10,07	0,00
Orientation sport	2,63	2,04	14,53	1,00	14,53	10,77	0,00
Rugby	2,29	1,65	17,91	1,00	17,91	12,13	0,00
Synchro. swimm.	2,06	2,61	12,78	1,00	12,78	7,58	0,01
Bodybuilding	1,78	1,47	4,05	1,00	4,05	4,16	0,04
Lawn hockey	2,10	1,76	4,88	1,00	4,88	4,53	0,03
Pilates	3,41	3,81	6,66	1,00	6,66	4,55	0,03
Snowboarding	3,21	2,47	22,73	1,00	22,73	11,30	0,00

The students from Faculty of Teacher Education and Faculty of Medicine statistically significant differ in the lowest number of sports. These sports are relatively diverse in their character (swimming, rollerblading, fencing ect.). The results could be interpreted that the female students of these two faculties are the most similar to each other concerning preferences toward sports. The students of Faculty of Teacher Education more prefer swimming, rollerblading, table tennis, sledding, orientation sport and bowling, while the students of Faculty of Medicine favour fencing (Table 3).

Table 3. ANOVA results and mean values preferences toward sport activities of female students from Faculty of Teacher Education (FT) and Faculty of Medicine (FM), (level of significance  $p < 0,05$ )

	Mean FT	Mean FM	SS Effect	df Effect	MS Effect	F	p
Swimming	4,00	3,65	5,56	1,00	5,56	4,74	0,03
Rollerblading	4,29	3,97	4,46	1,00	4,46	4,15	0,04
Table tennis	2,95	2,57	6,46	1,00	6,46	4,03	0,05
Fencing	2,08	2,58	10,92	1,00	10,92	5,81	0,02
Sledding	3,83	3,12	22,57	1,00	22,57	13,46	0,00
Orientation sport	2,40	2,04	5,78	1,00	5,78	4,21	0,04
Bowling	2,99	2,57	7,72	1,00	7,72	4,00	0,05

Among all collected results of preferences toward sports between three institutions of higher education it can be seen that the female students from Faculty of Kinesiology differ the most. The reason of that is because the students of Faculty of Kinesiology have a larger amount of theoretical and practical knowledge about sports than students from two other faculties. They are engaged in sport during their entire education and certainly on faculty they are studying. Also they are more aware that such a way of lifestyle has a positive impact on their anthropological status and health.

On the other hand, the students of Faculty of Teacher Education and Faculty of Medicine showed a smaller number of sports that are significantly different. From the kinesiological point of view, their studying programs are similar. Also these female students are less informed and included in sports activities of different character than students of kinesiology. Accordingly, these two groups of female students prefer more recreational type of sport activities that are commercialized and better-known to female population. It is therefore important to better familiarize the students with sports, the opportunities and the conditions of each sport, so they can better choose which sport they want to engage in. Research on the female students' preferences towards sports express the need that this population should be better informed about the characteristics of a particular sport, hoping it will lead to their more frequent sports activities.

## Conclusions

The aim of this study was to establish the differences in preferences toward sports between female students from Faculty of Kinesiology, Faculty of Teacher Education and Faculty of Medicine, University of Zagreb. The obtained results show a statistically significant differences in preferences toward sports between faculties. Largest differences are between students of Faculty of Kinesiology and Faculty of Medicine, little less differences are between participants from Faculty of Kinesiology and Faculty of Teacher Education. Between Faculty of Teacher Education and Faculty of Medicine is noticeably less statistically significant differences in preferences toward sports. It can be concluded that students of these two faculties are different than students of Faculty of Kinesiology in their views and perception of sport in general. Informations which the latter possess certainly have influence on results of this type of questionnaire.

The student population is at the last step of their education, which includes organized physical activities as well, so it should be worked on their stage of awareness about the exceptional importance of movement and systematic exercise. The students from faculties selected for this research are future experts in their professions and should be leaders in promoting health which is in unbreakable connection with physical activity. They should teach individuals, adults and children, how to take care about their health on the right way.

## References

1. Gošnik, J., Bunjevac, T., Sedar, M., Prot, F., & Bosnar, K. (2002). Sport experience of undergraduate students In D. Milanović & F. Prot (Eds.), *Proceedings Books of 3<sup>rd</sup> International Scientific Conference, Opatija, 2002. "Kinesiology-New Perspectives"* (pp. 457-462). Zagreb: Faculty of Kinesiology.
2. Kravitz, L. (2007). The 25 most significant health benefits of physical activity and exercise. *IDEA, Fitness Journal*, 4 (9), 54-63.
3. Oglesby, C. A., & Hill, K. L. (1993). Gender and sport. In Singer, R. N., Murphey, M. & L. K. Tennat (Eds.) *Handbook of Research on Sport Psychology*. New York: Macmillan Publishing Company.
4. Prot, F., & Bosnar, K. (2000). Stavovi prema sportu studenata jednog Kineziološkog fakulteta. U Findak, V. & K. Delija (ur.), *Zbornik radova 9. ljetne škole pedagoga fizičke kulture Republike Hrvatske, Poreč, 2000, "Primjena novih tehničkih i tehnoloških dostignuća u edukaciji, sportu, sportskoj rekreaciji i kineziterapiji"* (pp. 180-182), Zagreb: Hrvatski savez pedagoga fizičke kulture.
5. Špehar, N., Gošnik, J., & Reichel, F.K. (2008.). The preferences toward sports of students in institutions of higher education. In Milanović, D. & F. Prot (Eds.) *Proceedings Book 5<sup>th</sup> International Scientific Conference on Kinesiology, Zagreb, 2008, "Kinesiology research trends and applications"* (pp. 561 – 565). Zagreb: Faculty of Kinesiology.

## Acknowledgement

The results of this study are part of the scientific project "Kinesiological education in preschool and primary education", executed with support of Ministry of science, education and sports of Republic of Croatia.

## COMPETENCES OF EDUCATORS IN THE KINDERGARTEN IN THE FIELD OF SPORT

Miran Muhič

Faculty of Education, University of Maribor, Slovenia

### Abstract

Pre-school period is the foundation of motor development, as the child's organism at that time the most exposed to the environment and also the most dependent on them. Children experience and learn about the sports activities mainly through the game, while the vital role is of the educator, that gives a child basic information and prepares a conducive environment for their motor development. For the quality and effective influence on a child's motor development, the educator needs in addition to general skills also specific competences in the field of sport. In the present study was a sample of 229 educators in Slovenian kindergartens, through a questionnaire with 40 specific competencies, we identified those competencies, according to educators' importance to the implementation of sports activities in kindergarten. Based on the factor analysis we named seven groups of specific competencies that educators should have to work successfully in sport in kindergarten.

**Key words:** *physical fitness, physical fitness teachers*

### Introduction

Competencies that every educator / teacher should have, are defined in Eurydicovem report (Key competencies, 2002). The document distinguishes between *subject-specific* skills that relate to specific subject areas and *general competencies*, which are produced in several different areas. In the Recommendation of the European Parliament on key competences for lifelong learning (2006) the key competencies are defined as a *combination of knowledge, skills and attitudes of the corresponding circumstances*. Various authors (Coolahan, 1996; Perrenoud, 2002; Romainville, 1996) define competence obtaining as a training of individuals for mobilization, utilization and integration of knowledge in complex, diverse and unpredictable situations. Marentič Požarnik (2007) when considering development of skills among teachers and educators, resulting in five areas of teachers' generic skills: *communication and relationships, effective teaching, organization and management, cooperation with the working and social environment, and professional development*.

Pre-school period is the foundation of motor development, as the child's organism at the time the most exposed to the environment and also the most dependent on them. Appropriate physical activities especially in the preschool period are crucial for the child's motor and functional development (Thomas, 1992). Zupancic (2004) argues that changes in the child's motor development occur gradually and cumulatively from birth to death. On some aspects of development genetic factors have more influence, on the other aspects, the environmental factors have more influence, among which is the educator. Pišot and Jelovčan (2006) argue that children learn about and experience the sports activities mainly through the game, while the vital role is of educator who encourages the child, gives basic information, observe his reactions and prepares a supportive environment. The study of sports activities of children in Slovenia (Videmšek, 2001) showed that in Slovenian kindergartens there is a lack of professionally organized and operated sports training.

In the international area there have been two guys engaging with similar issues of the general and specific competences in the field of physical fitness, Laporte (1997), who was trying to unify the European vision in the field of physical fitness, and Gallardo (2006), which compared some of the competencies of teachers beginners with those with years of experience. Hardman with his working group in the project AEHESIS (2008), has identified competencies that include training of teachers of physical education group programs. He defined the model of general and specific learning outcomes, which he divided into *knowledge (know)* and *use of these skills (do)*; and with this, knowledge is represented as the foundation and prerequisite for the acquisition and design skills - the use of knowledge.

In the Slovenian area the problem of skills in the field of physical education has been studied by Kovač, Starc, Strel and Jurak (2005), researching effective general and specific skills on a small sample of physical fitness teachers, while the students of the Faculty of Sport assessed desired skills of future physical fitness teachers. Kovač, Sloan and Starc (2007) on the basis of research that was conducted on a sample of physical fitness teachers in Slovenia, distributed specific competencies in the school curriculum into three groups: the first group called *disciplinary competences* (directly related to the implementation of physical education content and acquired through experience and knowledge of individual sports), another group was called the *systemic competences* (from the general disciplines / biomechanics, physiology, psychology ... / and indirectly related to the implementation of the content of physical education and importantly contribute to a deeper understanding of the subject, its content and skills), the third group was called the *instrumental competences of*

*physical fitness teachers* (representing skills that are not directly involved in the learning system of teacher education curriculum, but are necessary to support the process of successful teaching in the school and may be developed in the context of continuing professional training).

Lepičnik Vodopivec (in Erčulj, 2008) on the basis of research presents the main general competencies that teachers in kindergartens would like to develop. The highest ranks desire for *knowledge in the field of modern technologies*, followed by *the identification of children and adapting the work to their needs* and specificities for both gifted and those with special needs, in third place is the desire of *further developing of areas of professional specialization*.

## Purpose

The aim of our study was to determine which competencies are considered by educators to implement the relevant sports activities in kindergarten and on the basis of responses prepare some groups of specific competencies for teachers to obtain in various forms of education for good results in sport in kindergarten.

## Methods

The study used causal-nonexperimental method, which allowed the study in the level of causal interpretation of data obtained through a questionnaire on a sample of educators in kindergarten. The sample is non-random from the specific population of 229 educators in kindergarten. Measuring instrument is *The questionnaire of the desired competences in the field of sport in kindergarten*, which is made on the basis of already conducted studies (Gallardo, 2006, Kovač et al., 2005, Kovač et al., 2008, Kovač et al., 2010; Laporte, 1997), at the theoretical points of Hardman model (Hardman, 2008) and the questionnaire from Kovač, Starc and Tul (2010) and is designed for the field of sports in kindergarten. The questionnaire covers 40 specific competencies that are evaluated by teachers based on the four-step Likert scale.

## Results

The factor analysis (Hotelling's method of principal components, Kaiser-Gutman's criterion:  $\lambda > 1$ ) based on 40 variables we obtained 7 factors, that together explain 62,023% of the variance of space of specific skills in kindergarten educators in the field of sport (Table1).

Table 1. The resulting number of factors, eigenvalues and explained variance

Faktors	% of Variance	Cumulative %
1	36,000	36,000
2	8,419	44,419
3	4,647	49,066
4	3,615	52,681
5	3,421	56,102
6	3,289	59,391
7	2,632	62,023

Based on a set of specific competences that appear in the pattern matrix obtained in the individual factors were named seven groups of competencies that an educator in the kindergarten should have for the professional and quality work in the field of sport:

1. **qualifications for professional help in getting their children the skills and knowledge in the field of sport;**
2. **knowledge of the natural-science aspects of the sport;**
3. **capacity for planning, implementation and analysis of sports activities;**
4. **knowledge of the social aspects of sport;**
5. **capacity to integrate sport with other areas in the kindergarten;**
6. **knowledge of physical and motor development of children;**
7. **ability to display / demonstration of various sports items.**

## Conclusions

Issues of specific competences of educators in the field of sports in kindergarten by now practically has not been studied yet, but we know very well lawfulness of physical and motor development of children and the impact of regular physical activity in childhood on the quality of life in later periods. If we want to affect the greater competence in kindergarten educators in the field of sport, it is necessary to prepare an appropriate set of specific competences, which should be gained in all forms of self-education of the profession of educators. With the results of our research, we got a similar set of specific competences groups, such as by the area of school physical education were presented by Kovač, Sloan and Starc (2007). Such competence profile will allow educators to have a better understanding of motor development of children and will facilitate the planning, implementation and analysis of sports activities. Sports activities in kindergarten will be even more adapted to the development stage of a child and will have a positive impact on his motor and integrated development and acceptance of sport as positive values in later life.

## References

1. Coolahan, J. (1995). *Secondary Education in Ireland (Guide to secondary education in Europe)*. Strasbourg: Publishing and Documentation Service Council of Europe.
2. Erčulj, J., Ivanuš Grmek, M., Lepičnik Vodopivec, J., Musek Lešnik, K., Retar, I., Sardoč, M. in Vršnik Perše, T. (2008). *Razvoj metodoloških inštrumentov za ugotavljanje in spremljanje profesionalnega razvoja vzgojiteljev, učiteljev in ravnateljev. Projektno poročilo*. Pridobljeno 10.9.2010 iz [www.mss.gov.si/.../Evalvacija\\_Vzgoje\\_in\\_izobrazevanja\\_RS.doc](http://www.mss.gov.si/.../Evalvacija_Vzgoje_in_izobrazevanja_RS.doc)
3. Gallardo, A.M. (2006). Evaluating professional competencies for labor placement of the physical education teacher. *Electronic Journal of research in Educational Psychology*, 10, Vol.4(3), 469-492.
4. Hardman, K., Klein, G., Patriksson, G., Rychtecky, A. in Da Costa, F.C., (2008). *Implementation of the Bologna Process and Model Curriculum Development in Physical Education* V Petry, K., Froberg, K., Madella, A., Tokarski, W. (2008). Higher Education in Sport in Europe. From labour Market demand to Training Supply. UK: Meyer & Meyer Ltd.
5. *Key Competencies* (2002). Survey 5. Brussels: Eurydice, European Unit.
6. Kovač, M., Sloan, S. in Starc, G. (2007). Competencies in physical education teaching: Slovenian teachers' views and future Perspectives. *European Physical Education Review*. Volume14(3): 299–323.
7. Kovač, M., Starc, G., Strel, J. in Jurak, G. (2005). Kompetence učiteljev športne vzgoje in študentov fakultete za šport. *Šport (priloga Športna didaktika)*, Vol.53 (3), 2-7.
8. Kovač, M., Starc, G. in Tul, M. (2010). *Vprašalnik Kompetence študentov Fakultete za šport*. Ljubljana: Fakulteta za šport.
9. Laporte, W., (1997). The Physical Education Teacher for Secondary Schools in the EU. *Journal of the International Council for Health, Physical Education, Recreation, Sport, and Dance*, Vol.3, 43-46.
10. Marentič Požarnik, B. (2007). Čemu potrebujemo širši dogovor o temeljnih učiteljevih zmožnostih/kompetencah. *Vzgoja in izobraževanje*, 38 (5), 44-50.
11. Perrenoud, P. (2002). *Construire des compétences dès l'école*. Paris: ESF.
12. Pišot, R., in Jelovčan, G. (2006). *Vsebinska gibalne/športne vzgoje v predšolskem obdobju*. Koper: Univerza na Primorskem, Znanstveno-raziskovalno središče. *Recommendation of the European parliament and of the council of 18 December 2006 on key competences for lifelong learning* (2006/962/EC)
13. Romainville, M. (1996). Teaching and Research at university: a difficult pairing. *Higher Education Management*, Vol.8(2), 135-144.
14. Thomas, R.M., (1992). *Comparing Theories of Child Development, 3<sup>rd</sup> edition*. Belmont, CA: Wadsworth Publishing Company.
15. Videmšek, M. (2001). *Športne dejavnosti predšolskih otrok*. Ljubljana: Fakulteta za šport.
16. Zupančič, M. (2004). Spoznavni razvoj in vsakdanja kompetentnost v pozni odraslosti. V Marjanovič Umek, L in Zupančič, M. (ur.), *Razvojna psihologija* (str. 774-791). Ljubljana: Znanstvenoraziskovalni inštitut Filozofske fakultete.

## URBAN-RURAL DIFFERENCES IN MOTOR ABILITIES AMONG THE 7<sup>TH</sup> GRADE PRIMARY SCHOOL BOYS IN THE REPUBLIC OF CROATIA

Boris Neljak, Hrvoje Podnar and Ivan Krakar

*Faculty of Kinesiology, University of Zagreb, Croatia*

### Abstract

In the contemporary lifestyle there is observable contrast between rural and urban areas. This contrast is reflected in the lifestyle as well as in the differences regarding climatic and atmospheric conditions. The aim of this study is to determine the differences in kinanthropological characteristics of 7<sup>th</sup> grade elementary school pupils in relation to urban-rural characteristics of the Republic of Croatia. The research was conducted on the sample of 1084 male students (body height 163.87±6.46; body weight 55.84±9.97) in the 7<sup>th</sup> grade in elementary school. A battery of fifteen tests was applied for the evaluation of motor abilities. Coordination, agility, flexibility, explosive and dynamic strength were estimated each with three tests. The differences between the physical fitness profiles of children from urban and rural areas were determined by using Anova and series of t-tests for independent samples with statistical significance set to  $p < 0.05$ . After examining the value of the arithmetic mean of the accomplished results of male students, it is interesting to note that, taking into account the size of the settlements as a criterion, male students from rural areas did not achieve generally better results than their peers from urban areas even though similar researches in Croatia and around the world have regularly pointed out a better quality motor potential of students from rural areas. This is probably so because the consequence of modernization and urbanization is increasingly affecting rural areas, and nowadays it is not surprising that male students from these areas spend more and more time at home, watching TV and playing computer games. All this leads to reduced levels of physical exercise and thus a decrease in the results of their kinanthropological characteristics.

**Key words:** *urban-rural differences, pupils, 7<sup>th</sup> grade, Republic of Croatia*

### Introduction

Like in all countries in transition, growing urbanization and industrialization is also present in Croatia. Physical work disappears due to mechanization and robotics, and widespread physical inactivity is becoming increasingly significant risk factor for the development of the most common diseases today. The pupils are more exposed to different influences as: inadequate lifestyle, inadequate daily obligations, especially regarding the lack of games and movement and parents' requests are not sensible enough regarding their children's abilities (Neljak, 2011). Monitoring and evaluating individuals' characteristics and abilities is of the utmost importance for the optimal growth, development and health of each person (Findak, 1999). Accordingly, in the life of every person the appropriate level of anthropological features, especially those for which we can say that are inevitably involved in defining human health, is almost as important as the quantity and quality of a person's knowledge.

Many authors have researched the differences in some anthropological characteristics among students living in different climatic and geographical conditions (Reyes, Tan, Mallina, 2000; Tsimeas et al., 2005; Ozdirenc et al., 2005; Tognarelli et al., 2004; Felton et al., 2002; Petrić et al., 2007, etc.). They determined that differences exist, especially in weight and that the rural population generally has better anthropological characteristics. Furthermore, the above-mentioned studies indicate that urban lifestyle is leading to greater inactivity and deteriorated kinanthropological characteristics of school children. It was found that students in urban areas spend most of their free time in activities like reading, playing computer games or watching TV (Ruel M et al., 1998), while students in rural areas, due to more spacious environment, stay more in the open space that provides them freedom in movement and playing.

Developing countries, such as the Republic of Croatia, are often characterized by socioeconomic, educational, nutritional, and health care inequities between rural and urban areas. In Croatian cities live 57.1% of population and in villages 42.9%. Four cities have more than 100 000 inhabitants and the largest is the capital city Zagreb with about 900 000 inhabitants. Rural communities live a traditional lifestyle and are small-scale farming economy based. The biggest problem of Croatian village is its demographic decline and the biggest reasons for the emigration of population to urban areas are lack of infrastructure and lack of employment opportunities. The aim of this study is to determine the differences in kinanthropological characteristics of 7<sup>th</sup> grade elementary school pupils in relation to urban-rural characteristics of the Republic of Croatia.

## Methods

This study was approved by the Committee for the Scientific Work and Ethics of the Faculty of Kinesiology, University of Zagreb. This paper presents the results of a larger study with the aim of validating tests and measurements for assessing kinanthropometric characteristics of school children in Croatia. For the understanding of the entire process of selection and division of subjects according to rural-urban characteristics, it is necessary to explain basic aspects of methodological frame of the research.

An important assumption in the analysis of the differentiation between urban and rural areas of the Republic of Croatia is the conceptual definition and methodological separation of groups of urban and rural settlements as spatial demographic and statistical basis of this analysis. Based on the data of the settlement size and the share of agricultural population, the separation of urban settlements across Republic of Croatia in the period from 1953 till 2001 was made by N. Pokos (Pokos, 2002). Accordingly, in this study, the urban-rural area will be divided into three strata: settlements numbering to 5000 inhabitants, settlements between 5000-10000 inhabitants and those in which there are more than 10000 inhabitants.

## Subjects

The study was conducted on a representative sample of male student subpopulation in the 7<sup>th</sup> grade. Sample consisted of 1084 male students (body height  $163.87 \pm 6.46$ ; body weight  $55.84 \pm 9.97$ ). Prior to the participation in the study, a written informed consent was obtained from every participant's parent and a permission to conduct the study from the school principals.

## Physical fitness tests

Students' motor abilities were assessed with 15 tests. Coordination, agility, flexibility, explosive and dynamic strength were estimated each with three tests. For each participant all variables were measured and each variable was measured three times in succession or alternately, except for the tests of dynamic strength, which was measured once. For the assessment of coordination the following tests were used: polygon reverse (PR), ball rolling with non-dominant hand (ROLLING) and polygon turn (PT). Agility was assessed using these tests: side step (SIDE STEP), figure eight with bending (F8) and shuttle and run (SR). Bending forward with legs extension (BFLE), forward bend on a bench (BFB) and forward bend in narrow legs extension (BFNLE) were used to assess flexibility. The explosive strength of lower extremities was assessed by the following tests: standing long jump (SLJ), 20 meters run test (20m), while throwing a medicine ball (1kg) from lying position (BTLF) was used to measure explosive strength of the upper extremities. Lifting body from lying position (LBLE) and lifting body-short (LBS) were carried out to estimate the repetitive power of the front part of the body, while the dynamic strength of the lower extremities was estimated by squats (SQ).

## Statistical analysis

A data analysis was conducted using the Statistical Package for Social Sciences (v18.0, SPSS Inc., Chicago, IL). The descriptive statistics were computed for all the experimental data and separately for the each strata (mean, standard deviation, range, skewness and kurtosis). In addition, the Kolmogorov-Smirnov test was used to test the normality of distribution before further analysis. The differences between the children's kinanthropological characteristics were determined using analysis of variance ANOVA. A series of t-tests for independent samples were made to compare additionally the subjects and thus establish any statistically significant differences between them. The statistical significance was estimated at the level of  $p \leq 0.05$ .

## Results

Descriptive statistical parameters of tests for the assessment of motor skills of male students in the 7<sup>th</sup> grade are presented in Table 1. Regarding tests for coordination assessment in 2 of 3 tests the best results were achieved by students from rural areas (PR  $p=0.46$ , PT  $p=0.30$ ) while in the test ball rolling with non-dominant hand students from urban areas were better (ROLLING  $p=0.24$ ). However, the observed differences between rural and urban students are less than 0.5 seconds. That was also confirmed by analysis of variance and detailed analysis by a series of t-tests (Table 2) which showed no statistically significant difference.

Table 1. Analysis of variance for all tested groups (7<sup>th</sup> – boys)

Variables	Mean±SD			F	p
	< 5000	5000 – 10000	> 10000		
PR	12,88±3,91	13,09±3,67	13,26±3,62	0,773	0,46
ROLLING	17,56±2,99	17,57±2,74	17,20±3,50	1,428	0,24
PT	8,45±2,66	8,85±2,45	8,72±2,27	1,207	0,30
SIDE STEP	10,67±1,49	10,19±1,26	10,39±1,51	4,331	0,01
F8	9,39±1,18	9,50±1,29	9,34±1,32	1,005	0,37
SR	11,45±1,14	11,03±1,02	11,04±1,35	7,234	0,00
BFLE	51,96±12,57	52,13±12,32	51,68±12,68	0,097	0,91
BFB	41,69±9,98	38,08±7,56	39,84±7,30	8,570	0,00
BFNLE	39,52±9,50	38,14±8,49	43,99±10,64	28,373	0,00
SLJ	176,08±24,75	179,37±25,17	180,60±23,59	2,306	0,10
20m	3,81±0,49	3,83±0,37	3,75±0,39	2,439	0,09
BTLP	103,65±22,16	107,48±22,68	103,20±22,49	2,262	0,10
LBLP	43,49±10,80	41,79±8,22	45,22±8,93	10,336	0,00
LBS	55,80±14,03	51,25±11,59	55,81±13,37	8,525	0,00
SQ	46,99±10,78	47,05±10,70	46,54±10,72	0,217	0,80

PR - polygon reverse, ROLLING - ball rolling by a non-dominant hand, PT - polygon turn, SIDE STEP - side step agility, F8 - figure 8 with bending, SR - shuttle and run, BFLE - bending forward with legs extension, BFB - forward bend on a bench, BFNLE - forward bend in narrow legs extension, SLJ - standing long jump, 20m - 20-m run test, BTLP - medicine ball throwing from lying position, LBLP - lifting body from lying position, LBS - lifting body-short, SQ - squats

Although the results of the agility tests show a significant superiority of urban-rural students, mean difference in results of three tested groups are not big (Table 1). In the test side steps (SIDE STEP) and the shuttle and run (SR) range of results is about 0.5 seconds, while in the figure eight with bending (F8) the best results were achieved by urban students with a difference less than 0.2 seconds.

Based on the results of test forward bend on a bench, rural male students are significantly more flexible in the lower back and back thigh than their peers in rural-urban and urban areas (BFB  $p=0.00$ ) which was also confirmed by a series of t-tests for independent samples, shown in Table 2.

Table 2. Results of series of t-tests for independent samples for all tested groups (7<sup>th</sup> – boys)

Variables	< 5000	5000 – 10000	> 10000
PR	< 5000	-	0,88
	5000 – 10000	0,88	-
	> 10000	0,90	0,93
ROLLING	< 5000	-	0,46
	5000 – 10000	0,46	-
	> 10000	0,09	0,01
PT	< 5000	-	0,71
	5000 – 10000	0,71	-
	> 10000	0,65	0,30
SIDE STEP	< 5000	-	0,17
	5000 – 10000	0,17	-
	> 10000	0,73	0,05
F8	< 5000	-	0,71
	5000 – 10000	0,71	-
	> 10000	0,73	0,93
SR	< 5000	-	0,20
	5000 – 10000	0,20	-
	> 10000	0,20	0,01
BFLE	< 5000	-	0,94
	5000 – 10000	0,94	-
	> 10000	1,00	0,93



BFB	< 5000	-	0,03	0,00
	5000 – 10000	0,03	-	0,13
	> 10000	0,00	0,13	-
BFNLE	< 5000	-	0,53	0,12
	5000 – 10000	0,53	-	0,03
	> 10000	0,12	0,03	-
SLJ	< 5000	-	0,91	0,48
	5000 – 10000	0,91	-	0,60
	> 10000	0,48	0,60	-
20m	< 5000	-	0,00	0,00
	5000 – 10000	0,00	-	0,46
	> 10000	0,00	0,46	-
BTLP	< 5000	-	0,92	1,00
	5000 – 10000	0,92	-	0,90
	> 10000	1,00	0,90	-
LBLP	< 5000	-	0,01	0,01
	5000 – 10000	0,01	-	0,51
	> 10000	0,01	0,51	-
LBS	< 5000	-	0,03	0,48
	5000 – 10000	0,03	-	0,05
	> 10000	0,48	0,05	-
SQ	< 5000	-	0,98	0,76
	5000 – 10000	0,98	-	0,73
	> 10000	0,76	0,73	-

PR - polygon reverse, ROLLING - ball rolling by a non-dominant hand, PT - polygon turn, SIDE STEP - side step agility, F8 - figure 8 with bending, SR - shuttle and run, BFLE - bending forward with legs extension, BFB - forward bend on a bench, BFNLE - forward bend in narrow legs extension, SLJ - standing long jump, 20m - 20-m run test, BTLP - medicine ball throwing from lying position, LBLP - lifting body from lying position, LBS - lifting body-short, SQ - squats

On the other hand, test forward bend in narrow legs extension showed better flexibility of urban students compared to their peers from rural area by more than 4 cm ( $p=0.00$ ), however, analysis by a series of t-tests (Table 2) showed no statistically significant difference between them.

In all tests for the assessment of explosive strength of upper and lower extremities, students from rural area did not achieve the best results. Results on the test for explosive strength of lower extremities sprint-type (20m) and jump-type (SLJ) were better for urban students while rural-urban students performed better in test for assessment of explosive strength of upper extremities. However, no significant differences were noticed (SLJ  $p=0.10$  20m  $p=0.09$  BTLP  $p=0.10$ ) thus confirming the results of a series of t-tests presented in Table 2.

Results of univariate analysis of variance, also shown in Table 1, statistically significantly confirm the superiority of male students from the urban environment in the tests for assessment of repetitive strength; LBLP ( $p=0.00$ ), LBS ( $p=0.00$ ), while male students from the rural-urban areas achieved better results on the test for the evaluation of repetitive strength of lower extremities (SQ), however, statistical significance of the results was not found ( $p=0.80$ ).

## Discussion and conclusion

After examining the value of the arithmetic mean of accomplished results of male students, it is interesting to note that, taking into account the size of the settlements as a criterion, male students from rural areas did not achieve generally better results than their peers from urban areas. Similar researches in Croatia and world have regularly pointed out a better quality motor potential of students from rural areas (Medved et al., 1989; Pena et al., 2003; Tsimeas et al., 2005; Ozdirenc et al., 2005; Tognarelli et al., 2004; Felton et al., 2002).

In the modern lifestyle there is a contrast between city and country life. This contradiction is reflected in the lifestyle of residential population and the diversity of climate and atmospheric conditions (Sijerković, 2006). Children and students, who live in rural areas, spend more time outdoors and use outdoor sports facilities than students who live in urban areas. In addition, they are engaged in various sports games that develop almost all motor skills (Petrić and Novak, 2007). This fact, at the present time, could be a huge advantage for the generally better development of anthropological characteristics, and thus the health of children (students) who live in rural areas. However, this study has shown that, in general, there is no statistically significant difference in the results motor abilities tests among students with regard to their rural-urban background. It is to be assumed that the mentioned state changes in favour of students in urban settlements because of induction of mechanization and less need for physical work on the farms, while retaining the nutritional habits that include traditional, high calorie meals (Sheehan C, 2005), but also because of richer offers of organized sport facilities

and programmes in the cities. This is also confirmed by the data from the European Union which consistently indicate that children in urban areas have greater size and mature earlier than their peers in rural areas (Bielicki T, 1986). The size advantage is attributed to the beneficial changes in public health and nutrition and, in general, to the living conditions associated with urbanization (Pena et al., 2003). Hence, the size advantage commonly observed in urban children might also be reflected in the better levels of physical fitness. Also, although the population in the Croatian rural areas has more space and possibilities for physical activity, the fact that the accelerated way of life often disables the time that the modern man needs for the elements that ameliorate the overall anthropological status. The consequence of modernization and urbanization increasingly affects rural areas, and nowadays it is not surprising that male students from these areas spend more and more time at home, watching TV and playing computer games. All this leads to reduced levels of physical exercise and thus falling of results of their kinanthropological characteristics.

Collected information about the level of kinanthropological characteristics of 7<sup>th</sup> grade male students in the Republic of Croatia represent a first step in designing intervention measures aimed to improving the health of the mentioned population. Since it is considered that the population of male and female students in primary and secondary schools represents the driving force of every society and that the foundation of a healthy nation are healthy children, students and youth, the importance of this research thus becomes higher. Researching the differences in kinanthropological characteristics according to the size of settlements will undoubtedly lead to better understanding of connection between those phenomena. At the same time, the research will contribute to determining kinanthropological tasks of teaching physical education and to developing standards in the area of kinanthropological characteristics of students (Neljak et al., 2011).

## References

1. Bielicki, T. 1986. Physical growth as a measure of economic well-being of populations: the twentieth century. In: Falkner, F., Tanner, J.M., editors. Human growth. A comprehensive treatise, vol 3. New York: Plenum Press; p 283-305.
2. Felton, G., Dowda, M., Ward, D.S., Dishman, R.K., Trost, S.G., Saunders, R., Pate, R.R. (2002). Differences in physical activity between black and white girls living in rural and urban areas. *Journal of School Health*. Vol.72. str. 250.
3. Findak, V. (1999). Metodika tjelesne i zdravstvene kulture. Zagreb: Školska knjiga.
4. Medved, R., Mišigoj-Duraković, M., Matković, B., Pavičić, L. Pokazatelji rasta školske djece i omladine muškog spola od 8. do 18. godine života. *Med Vjesnik*. 1989;21(1-2):1-4. Croatian.
5. Neljak, B. (2011). Kineziološka metodika u osnovnom i srednjem školstvu. Interni materijal. Skripta za studente VIII. i IX. semestra. Kineziološki fakultet sveučilišta u Zagrebu, Zagreb.
6. Neljak, B., Novak, D., Sporiš, G., Višković, S. (2011). Metodologija vrednovanja kinantropoloških obilježja učenika u tjelesnoj i zdravstvenoj kulturi – CROFIT NORME. Interni materijal. Kineziološki fakultet sveučilišta u Zagrebu, Zagreb.
7. Ozdirenc, M., Ozcan, A., Akin, F., Gelecek, N. (2005). Physical fitness in rural children compared with urban children in Turkey. *Pediatrics International*. Vol.47. str. 26-31.
8. Petric, V. i Novak, D. (2007). Razlike u antropološkim obilježjima učenika urbanih i ruralnih naselja. *Zbornik radova: Sport za sve u funkciji unapređenja kvalitete života*, Zagreb, 277-284.
9. Pokos, N. Metodologija izdvajanja seoskog stanovništva, njegov raspored i popisne promjene 1953.-2001. godine. In: Štambuk, M., Rogić, I., Mišetić, A., editors. *Prostor iza: kako modernizacija mijenja hrvatsko selo*. Zagreb: Institut društvenih znanosti Ivo Pilar, 2002; 31-56. Croatian.
10. Reyes, M.E., Tan, S.K., Mallina, R.M. (2000). Urban-rural contrasts in the growth status of school children in Oaxaca, Mexico. *Escuela Nacional de Antropología e Historia*, Mexico.
11. Ruel, M., Garrett, J., Morris, S., Maxwell, D., Oshaug, O., Engle, P., Menon, P., Slack, A., Haddad, L. Urban challenges to food and nutrition security: A review of food security, health, and caregiving in the cities. *Food Consumption and Nutrition Division Discussion Paper 51*, International Food Policy Research Institute, Washington, D.C. 1998.
12. Sheehan, C. Kids obesity worse in rural areas. CBS news.[interent]. 2005 Mar [cited 2007 Mar 5]. Available from: [www.cbsnews.com/stories/2005/03/14/health](http://www.cbsnews.com/stories/2005/03/14/health).
13. Sijerković, M. (2006). Klima i urbana naselja – Grad otok topline. In: časopis. (32) godina IX.
14. Tognarelli, M., Piccioli, P., Vezzosi, S., Isola, A., Moretti, F., Tommasetto, E., Fantuzzi, A.L., Bedogni, G. (2004). Nutritional status of 8-year-old rural and urban Italian children: a study in Pistoia, Tuscany. *International Journal of Food Sciences & Nutrition*. Vol.55. str. 381-387.
15. Tsimeas, P.D., Tsiokanos, A.L., Koutedakis, Y., Tsigilis, N., Kellis, S. (2005). Does living in urban or rural settings effect aspects of physical fitness in children? An allometric approach. *British Journal of Sports medicine*. Vol.39. str. 671-674.

## ANALYSIS OF WORKLOAD DURING EXERCISE WITH IMPLEMENTATION OF VARIOUS CONTENTS IN THE MAIN B PART OF THE LESSON

Dario Novak, Ivan Zupčić and Hrvoje Podnar

Faculty of Kinesiology, University of Zagreb, Croatia

### Abstract

The study was conducted on a sample of 13 students (8 male and 5 female students) of private primary school with the public right "Lauder - Hugo Kon" from Zagreb, where the analysis of physiological workload during the implementation of three different contents in the main B part of the lesson. Monitoring physiological workload was performed with the heart rate monitor (Polar RS400), and the results suggest the following conclusions: 1. average registered heart rate for each of the three main contents of B part of the lesson is in the range 162-168 heart beats per minute, 2. in all three contents of the main B part of the lesson students spent most of their time (from 35% to 37%) in the zone of very high intensity, 3. statistical analysis, conducted using program Statistica 7.0 and univariate analysis of variance (ANOVA) determined that contents which were conducted in the main B part of the lesson statistically significantly deviate only in regards to the time spent in the zone of high intensity.

**Key words:** heart rate, students, zones of intensity, physical education lesson

### Introduction

During the lessons, i.e. physical education lessons, students were subjected to the functional, psychological and intellectual workload. Workload can be defined as the total impact on the student's body achieved through overall educational activities in class (Findak, 1999). Achieving optimal physiological workload has an important role in the transformation of anthropological characteristics of students. Physiological workload can be determined with fairly high accuracy since physiological manifestations can be recorded. For the purposes of school practice, physiological workload can be measured through pulse values, that is, by determining the condition of heart rate. Physiological workload is planned depending on the students' abilities and aims of the lesson, and is implemented through the contents of work and organizational forms. Contents applied in the main B part of a lesson vary according to age groups, but from the standpoint of the entire educational field, sports games, basic relay games and basic team games are most frequent.

Selection of appropriate content for the main B part of a lesson is an essential precondition for achieving sub maximum physiological workload and activating students' positive emotional functions (Neljak, 2008). Physiological workload, generally speaking, depends primarily on the intensity of metabolism, which can be controlled, or registered through oxygen use, removing carbon dioxide and measuring heart rate (Findak, 1999). Upon examining the frequency of the heart rate of boys and girls during the implementation of various content in the main B part of the physical education lesson, an attempt will be made to determine whether there were statistically significant differences in the functional responses of boys and girls for better planning and implementation of physical education lessons.

### Methods

Based on the objective of this study, two hypotheses were formulated:

H 01: Various contents of the main B part of the lesson based on average heart rate of students will not significantly differ.

H 02: Various contents of the main B part of the lesson based on the percentage of time spent in various zones of intensity will not significantly differ.

The sample was composed of 13 students of the private primary school with the public right "Lauder - Hugo Kon" from Zagreb. Descriptive parameters of the subjects are shown in Table 1.

Table 1. Average values of the respondents' morphological characteristics

	AS±SD	MIN	MAX
HIGHT (cm)	149,5±5,8	143,0	155,0
MASS (kg)	39,0±8,4	34,0	44,0
AGE (yrs)	11,6±0,6	11,4	11,9

In this study, students have monitored heart rate during the implementation of three physical education lessons. This paper will analyze only the main B part of the lesson, in a way that will determine the average heart rate, maximum heart rate, minimum heart rate, time spent in each zone of intensity and percentage of time spent in individual zones of intensity for each of the content implemented in the main B part of the lesson.

Table 2. Variables

VARIABLES		
1.	HR mean	Mean heart rate
2.	HR max	Maximum heart rate
3.	HR min	Minimum heart rate
9.	MAX I %	Maximum intensity 90%-100% (anaerobic zone)
10.	U HI I %	Ultra high intensity 80%-89% (anaerobic zone)
11.	HI I %	High intensity 70%-79% (aerobic intense zone)
12.	M HI I %	Moderately high intensity 60%-69% (high aerobic extensive zone)
13.	M I %	Moderate intensity 50%-59% (aerobic extensive zone)

MAX I %, U HI I %, HI I %, M HI I %, M I % refers to the percentage of time spent in each zone of intensity

Standard statistical methods were used to calculate the basic descriptive parameters of the variables: mean (AS), standard deviation (SD), minimum (MIN) and maximum (MAX) values and the time and percentage of time spent in each zone of intensity for each of the contents implemented in the main B part of the lesson and univariate analysis of variance (ANOVA) showed if there were statistically significant differences in the contents compared to the average heart rate and the percentage of time spent in different intensity zones.

Data processing was performed using the statistical package Statistica for Windows 7.0 and software package Polar ProTrainer 5.0 (Polar Electro Oy, Finland).

## Results

Table 3. The main indicators of heart rate

Variables	Mean±SD			F	p
	Sports game: Basketball	Relay: Dribbling the basketball	Basic team game: Keep your area clean		
HR mean	167,91±17,64	162,39± 9,84	167,64±10,89	0,5907	0,56
HR max	189,93±14,30	193,55±11,68	195,64± 9,04		
HR min	134,87±14,62	126,00±13,72	117,82±11,37		

The average heart rate for all students is 167.91 beats / min with the maximum average frequency of the individual students from 189.64 beats / min during the implementation of the sports game "Basketball" in the main B part of the lesson. This indicates that students in this part of the lesson reached a sub maximum physiological workload, which is the main objective of this part of the lesson. However, the maximum average frequency of the individual students ranging from 189.64 beats / min and a minimum average frequency of the individual students at 130 beats / min indicate a large heterogeneity among students both in terms of functional ability and in terms of interest and motivation toward physical and health education, or some other contents in physical education.

It is therefore recommended that students be taught the rules and technical elements of a sports game before its inclusion in the content of the main B part of a lesson so that students could be motivated and equally involved in the game itself.

The average heart rate of 162.39 beats / min for all students indicates that the main B part of the lesson during which relay game dribbling the basketball was implemented for almost all students, justified its goal implying that students are expected to reach sub maximum physiological workload in that part of a lesson. The range of average heart rate of individual students (minimum 141.69 beats / min, and the highest 172.31 beats / min) and the range of maximum heart rate recorded individually among students (minimum 174 beats / min, maximum 209 beats / min) indicate that relay games can equally functionally engage students regardless of gender and motor knowledge.

Relay games are recommended for implementation with students aged 11 or 12, after which the ratio of relay games in relation to sports games should gradually decline as the pupils are supposed to start training for the implementation of the sports games because, after completion of first four grades of primary school the students gradually lose interest in relay games.

The average heart rate of 167.64 beats / min for all students indicates that the main B part of the lesson with the basic team game, keep your area clean, fully justified its goal, which implies that students in this part of the lesson need to reach sub maximum physiological load. The range of average heart rate of individual students (minimum 153.39 beats / min, and the highest 183.23 beats / min) and a maximum range of heart rate recorded separately for each student (minimum 182 beats / min, maximum 210 beats / min) indicate that basic team games as well as relay games can equally functionally engage students regardless of gender and motor knowledge. Basic team games and relay are games recommended for implementation with students of younger age groups and students with lower-level motor skills and motor knowledge.

Using the statistical program Statistica 7.0, and univariate analysis of variance (ANOVA), F-value was calculated and it was lower than the limit, therefore, H<sub>01</sub> is accepted and the conclusion is, with a default error of 5%, that there is no statistically significant difference between the average heart rate of students in the contents where sports game "Basketball", relay game dribbling the basketball and the basic team game, keep your area clean, were implemented.

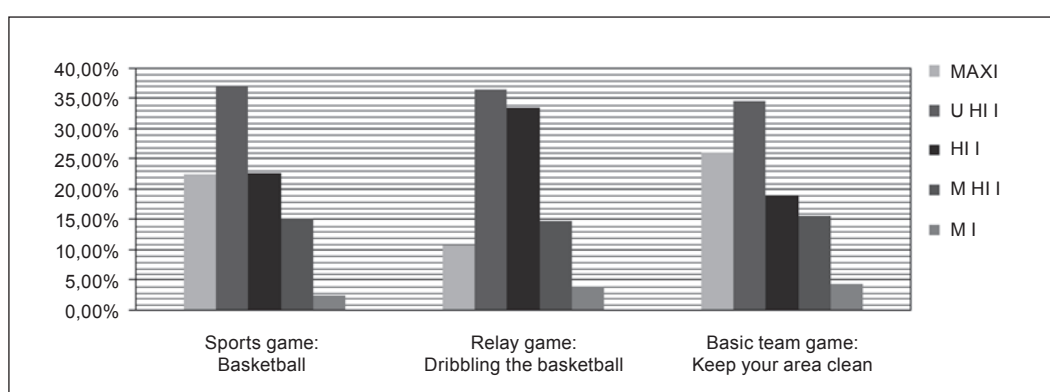

MAX I% - Maximum intensity 90% -100% (anaerobic zone); U HI I% - Ultra high intensity 80% -89% (anaerobic zone); HI I% - High intensity 70% -79% (aerobic intensity zone), M HI I% - Moderately high intensity 60% -69% (high aerobic extensive zone) M I% - Moderate intensity 50% -59% (aerobic extensive zone)

In U HI I, the M HI I and the M I zones the values were almost identical for all three contents of the main B part of the lesson, while in the MAX I zone and HI I zone there is a visible variation in the content in which in the main B part of the lesson relay game-dribbling the basketball, was implemented with students, compared to other contents, spend more time in the zone of high intensity, and less time in the zone of maximum intensity.

The obtained difference can be explained since only relay game of all the implemented games in the main B part of the lesson, is of interval type, while the other two games are of the continuous type.

While implementing all three contents more than 80% of the time in the main B part of the lesson was spent exercising where the intensity of work exceeds 70% HR max, and it is known that at such an intensity many positive changes occur in the human body, including: increased heart chambers, increasing shock and cardiac output, increasing the number of mitochondria, improving the efficiency of the cardiovascular system in the activities of high intensity, increasing the concentration of myoglobin, an increase in anaerobic threshold, increase in strength, increase in glicogenic reserves in the muscles and liver, the maximum intake of oxygen rises to the individual limits that are largely genetically predetermined; the maximum value can be maintained through training, but cannot be further enhanced- the increase in anaerobic power and speed of anaerobic glycolysis, increase in the buffer capacity, increasing the contractile ability of the slow and fast muscle fibres, improvement and acceleration of the glycolytic reactions, increase in the levels of strength, power and speed to the optimum limits (Vučetić and Šentija, 2005).

Thus obtained results indicate that all the activities that were carried out fully justify their goal in terms of physiological workload during the implementation in the main B part of the lesson.

Table 4. Statistical differences between the sports game Basketball, relay game dribbling the basketball and the basic team game, keep your area clean in relation to the percentage of time spent in different intensity zones

Variables	Percentage of time in individual zones (%)			F	p
	Sports game Basketball	Relay game Dribbling the basketball	Basic team game: Keep your area clean		
MAX I %	22,5	11	26	1,4720	0,24
U HI I %	37,1	36	35	0,0444	0,96
HI I %	22,7	34	19	<b>3,3874</b>	<b>0,05</b>
M HI I %	15,2	15	16	0,0109	0,99
M I %	2,5	4	4	0,2495	0,78

MAX I% - Maximum intensity 90% -100% (anaerobic zone); U HI I% - Ultra high intensity 80% -89% (anaerobic zone); HI I% - High intensity 70% -79% (aerobic intensity zone), M HI I% - Moderately high intensity 60% -69% (high aerobic extensive zone)  
M I% - Moderate intensity 50% -59% (aerobic extensive zone)

Using the statistical program Statistica 7.0, and univariate analysis of variance (ANOVA) it was confirmed that in the zone MAX I, U HI I, M HI I and M I there is no statistically significant difference between the sports game Basketball, relay game dribbling the basketball and basic team game, keep your area clean in the percentage of time spent in these zones of intensity, while in the zone HI I there was statistically significant difference between the relay game dribbling the basketball and the basic team game keep your area clean in the percentage of time spent in a given zone.

## Discussion and conclusions

The conducted study monitored the physiological workload during the implementation of various contents in the main B part of the physical education lesson using computer monitor for heart rate (Polar RS400). Given the results of univariate analysis of variance the hypothesis H02 is rejected and the conclusion is, with a default error of 5%, that there is a statistically significant difference in the percentage of time spent in the zone of high intensity between the relay game dribbling the basketball and the basic team game keep your area clean.

Taking into account the desired and the known curve of physiological workload where, during physical education lessons, it rises continuously from the beginning to the end of the main B part of the lesson, then decreases rapidly in the final part of the lesson, and some results of similar studies on this subject (Prce, 2002; Tomljenović, Grahovac and Radošević, 2009), we can conclude that the contents analyzed in this paper, as regards the physiological workload, match the criteria and are recommended for use in the main B part of the lesson.

Average workload during the implementation of the sports game- basketball, the basic team game keep your area clean is 167 beats / min which corresponds with the very high intensity characterizing the workload of 80-89% of HRmax, and the transformational effects are an increase in cardiopulmonary capacity, in addition to the body's ability to metabolize lactic acid. Average workload during the implementation of the relay game- dribbling the basketball is 162 beats / min which corresponds with the high intensity, characterizing workload of 70-79% of HRmax and transformation effects are related to the strengthening of the cardio-vascular system, respiratory system and increased ability to transport oxygen to muscles engaged through exercising and to transport carbon dioxide from them. In all three contents carried out in the main B part of the lesson, students spend the greatest percentage of time in the zone of very high intensity (35% of the time was spent in the basic team game keep your area clean, 36% in relay game- dribbling the basketball and 37% of the time in the sports game, Basketball). Average heart rate of students during the implementation of three different contents in the main B parts of the lesson is not significantly different, while the various activities in the main B part of the lesson based on the percentage of time spent in different intensity zones significantly differ only in the zone of high intensity.

## References

- Findak, V. (1999). Metodika tjelesne i zdravstvene kulture. Zagreb: Školska knjiga.
- Neljak, B. (2008). Opća kineziološka metodika. Zagreb: interni materijal.
- Prce, S. (2002). Funkcionalno opterećenje na nastavi tzk. UV. Findak (ur), Zbornik radova 11. ljetne škole kineziologa RH, Poreč, 2001. (str. 168-170). Zagreb: Hrvatski kineziološki savez.
- Tomljenović, B., Radošević, I., Grahovac, N. (2009). Razlike u vrijednosti frekvencije srca učenika u različitim metodičko-organizacijskim oblicima rada na satu tjelesne i zdravstvene kulture. U B. Neljak (ur.), Zbornik radova 18. ljetne škole kineziologa RH, Poreč, 2009. (str. 81-87). Zagreb: Hrvatski kineziološki savez.
- Vučetić, V. Šentija, D. (2005). Doziranje i distribucija intenziteta opterećenja u trenažnom procesu. Kondicijski trening, 3(2), 36-48.

## DIFFERENCES BETWEEN MEN AND WOMEN IN EFFECTIVENESS OF WINDSURF TEACHING

**Goran Oreb, Nikola Prlenda and Danijela Kostanić**

*Faculty of Kinesiology, University of Zagreb, Croatia*

### Abstract

Basic goal of this research was to determine whether the method of teaching, equipment development and influence of other factors in teaching process are changing the relation between men and women regarding the knowledge of the basic elements of technique attained during seven days teaching program in elementary windsurf school. Furthermore, as windsurf board is very unstable in its construction, and sails are adding to this instability, it was the special aim of the authors to determine how much is balance, as motor ability, influencing the effectiveness of windsurf elements demonstration. The research was done on specimen of 79 Kinesiology faculty students of Zagreb University (54 male and 25 female students). The efficacy in practical part of the exam in Windsurf sailing course was assessed by three judges in three technique elements. The balance was assessed by three tests: horizontal (HORI) and vertical (VERT) balance position astride on a platform, and balance position astride on duplex platform (BODP). The results of research determined that there's no statistically significant difference in the amount of gained knowledge between men and women after passing the seven- days windsurf teaching model. Furthermore, the connection, although very small, was determined between balance tests and exam technique elements realization success. Such results authors are attributing to the more advanced and modern equipment (construction characteristics of the modern windsurf boards – wider boards, new sail shape and shorter bow.)

**Key words:** *windsurf, teaching process, differences between the sexes, balance*

### Introduction

Windsurf is a new sport that appears for the first time in the middle sixties of the twentieth century. Since then all the way to the present days equipment, and also methods of beginners teaching are continuously developing. Besides, teaching of men and women is never ending methodic-didactic challenge considering evident anthropologic differences between sexes. Former experience is showing that quality performance of the basic elements of windsurf is depending on specific conditional, technical and theoretical preparation level on the one side, and different morphological, functional, motor, cognitive and conative dimensions which are adding to the efficacy, on the other side (Vogiatzis, 1999; Schack, 1999; Kurtović, 2003; Ošlak-Kranjc, 2011). Also, Oreb and Saks (1987) have determined in their research, based on the gained results, the significant difference for the mail examinees group, which they attribute to the longer lever, strength and motivation structure of the students. By developing of the equipment the factors which influence differences between the sexes are changing. Windsurf boards are wider (more stable), sails are made in different shape, bows are shorter and it makes the process of learning of the basic technique elements of windsurfing significantly easier. The question occurs, whether the equipment and teaching development, and also development of other factors in teaching process, have changed the relation between men and women regarding the level of mastering of windsurf technique elements after seven-days program of basic windsurf school. Furthermore, there's an aim to determine how much balance is, as motor ability, influencing the effectiveness in windsurf elements demonstration.

### Methods

#### Examinees

The research was made on the specimen of 79 Kinesiology faculty students of the Zagreb University, during the regular teaching of Water sports, which had no experience in windsurfing before this research. The specimen was made of 54 male and 25 female students.

#### Tests for assessment of windsurf knowledge

The assessment of the windsurfing knowledge was made after finishing the practical part of teaching in Water sports course held on Badija Island based on three exam elements:

1. Start (START)

2. Turning upwind-(TUW) – one of the methods of the changing of direction in sailing for 180 degrees, by which we can sail of and sail to the same position, changing the side on which we stand during that turning.
3. Turning downwind-(TDW) – other way or method of changing of direction in sailing in which the sail is sent over the prow on the other side. In this turn the height is lost concerning the direction of wind blowing so the beginner needs much more space than in upwind turning, and the additional aggravating factor for the beginner is the speed which is growing during the realization of this turn.

Success in realization of windsurf sailing elements were assessed by three judges using marks from 1 to 5. The exam was held on modern multiuse boards and with sails suitable for beginners.

For further analysis of data the average mark of all three judges on one exam element was used. The process of windsurf learning itself lasted for seven days. The examinees were divided into groups of 13 to 15 examinees of male and female sex. Weather conditions, respectively the strength of the wind and the height of the sea on which the course was held were between 4 and 6 knots of thermal wind of eastern direction, and calm to lightly rough sea.

### Balance assessment tests

Windsurf board is very instable which creates additional problem to the beginner during the learning of the basic elements, and it forces him to continuously seek balance position and gain balance when it is already disrupted. The balance of the examinees was assessed using three tests: horizontal (HORI) and vertical (VERT) balance position astride on the platform, and balance position astride on duplex platform (BODP), which was for the needs of this research put on the ground with the hemisphere. The basic difference between the first two tests is in the examinees position in relation to the mainstay of the platform. In the first test (HORI) the examinee is standing horizontally in relation to the mainstay of the platform in astride position, while in the second test (VERT) he stands vertically in relation to the mainstay of the platform. On the BODP platform the examinee is also standing in the astride position in a way that his feet are not allowed to get out of the platform. In all three tests assignments are performed in a way that the examinee is standing on the balance platform horizontally, respectively vertically, and that he is holding with his hand to the assistant. When the examinee is ready he moves his hand off the assistant and the measurement begins. The test is finished when any brink of the platform touches the ground or the examinee does the same with any part of his body. The tests were measured three times, and as a final result the best result is taken expressed in seconds.

### Results and discussion

With the aim of determining the differences in learnt knowledge applying the teaching and learning of basic elements of windsurf, the results of descriptive statistics (the mean and the standard deviation) between male and female examinees were compared.

Table 1. The basic descriptive statistic parameters (M- mean, SD-standard deviation) assessment of windsurf sailing elements for the examinees of the two groups

Name of the element	Men		Women	
	M	SD	M	SD
Start	4,16	,67	4,21	,65
Turn upwind	4,02	,76	4,26	,55
Turn downwind	4,07	,81	4,32	,76

From the results in the Table 1. it can be seen that means of the marks of the examinees are higher for the female students in every checked windsurf technique element. The biggest difference in mean is present with downwind turn element - (0.25). Although the differences are very small, the results are showing faster learning of the basic elements with female students, so opposite of the results of the research (Oreb and Saks, 1987) that show faster learning of the technique elements with male students. The results can be attributed to the quality and construction differences in equipment which has conformed to the beginners, and in that way the differences in anthropologic status of the male and female students were reduced. The better results for female students the authors are more attributing to the motivation structure of the female students because for the performing of the technique elements, comparing to the time twenty years ago and with that equipment, the modern equipment doesn't require so much strength. It is not the case with the male students, as the authors think, because according to the "traditional" idea of success, the male students think that success is necessarily connected to the strength. Such an interpretation is backed up by the results of the standard deviations where it can be seen that the marks of the exam technique elements are more varying with male than with female students. With the aim of determining of differences in effectiveness between male and female students, the one way analysis of variance was conducted (Table 2).



Table 2. The results of the one way analysis of variance for the two groups of examinees

Elements of the technique of the Windsurf sailing	Sum of squares	Degrees of freedom	Average square	F	P
Start	,039	1	,039	,088	,768
Upwind turn	,922	1	,922	1,836	,179
Downwind turn	1,034	1	1,034	1,628	,206

The results of one-way analysis of variance are showing that the differences get from the research are not statistically significant. The results are suggesting that the differences that showed can be accidental, and that they don't request for special approach in teaching the groups of male or female students. They also justify the former approach to the training in which male and female groups are passing through the teaching of the basic windsurf elements together using the same teaching models. To determine in what degree the balance is influencing the teaching of the basic windsurf elements, the correlation analysis was conducted in which the results of three motor tests assessing the balance were compared to the marks for the demonstration of the elements of windsurf technique (Table 3.).

Table 3. Correlation analysis of variables

	VERT	HORI	BODP	START	TUW	TDW
VERT	1	,628**	,137	,133	,045	,080
HORI		1	,187	,268*	,239*	,235*
BODP			1	-,047	-,060	,003
START				1	,738**	,849**
TUW					1	,783**
TDW						1

\*\* p< 0.01; \* p< 0.05

Analyzing the Table 3. statistically significant correlations can be seen on the significance level p<0, 05 between motor variable (HORI) and the three variables assessing the knowledge in windsurf (start (0,268), upwind turn (0,239) and downwind turn (0,235)). Although the correlations are statistically significant, they are very small. As it was formerly said, this fact is explained by the authors as a result of equipment development (wider boards, shorter bows, differently shaped sails) by means of which the learning of the basic windsurf elements was made much easier to the beginner learner. By further analysis of the Table 3. it can be noticed that other correlations are very low and that they didn't have statistically significant influence on the amount of knowledge learnt.

## Conclusions

On the basis of the results obtained, we can conclude that there's no statistically significant difference in the amount of the gained knowledge between male and female students after the seven-days windsurf teaching model (adult beginners). Therefore, it brings us to the conclusion that there is no need to separate the groups by sex in the future. Furthermore, small connection between balance tests and realization success of the tested technique elements is determined. Such results are attributed by the authors to the more modern equipment (construction characteristics of the modern windsurf boards – wider boards, different shape of sails and shorter bow.)

## References

1. Kurtović, B. (2003). *Povezanost uspješnosti jedrenja na dasci i nekih motoričkih sposobnosti*. (Graduation paper). Zagreb: Kineziološki fakultet Sveučilišta u Zagrebu.
2. Oreb, G. (1986). *Naučimo jedriti na dasci*. Zagreb: Fakultet za fizičku kulturu.
3. Oreb, G., and Saks, R. (1987). *Razlike između muškaraca i žena u uspješnosti obučavanja likova tehnike osnovne škole jedrenja na dasci*. U I. Berković (ur.), *Zbornik radova 3. kongresa pedagoga fizičke kulture Jugoslavije*, Novi Sad, 19.-21. studenoga 1987. (page 343-348). Novi Sad: Savez pedagoga fizičke kulture Jugoslavije.
4. Schack, T. (1999). *Relation of Cognitive Representation and Performance in Extreme-Surfing*. URL: [archiv.ub.uni-bielefeld.de/vortrag/pdf/schack.pdf](http://archiv.ub.uni-bielefeld.de/vortrag/pdf/schack.pdf)
5. Ošlak-Kranjc, J. (2011). *Povezanost motoričkih i morfoloških obilježja i uspješnosti u jedrenju na dasci*. (Masters paper). Zagreb: Kineziološki fakultet Sveučilišta u Zagrebu.
6. Vogiatzis, I. (1999). *The Physiological Demands of – Pumping – in IMCO Windsurfing*. URL: [www\\_sailing\\_org5.htm](http://www_sailing_org5.htm) (accessed 02.02.2010.)

## CANONICAL RELATIONS BETWEEN THE SYSTEMS OF MORPHOLOGICAL AND MOTOR VARIABLES WITH PRESCHOOL-AGE GIRLS

Aleksandra Pejčić<sup>1</sup>, Biljana Trajkovski Višić<sup>1</sup> and Julijan Malacko<sup>2</sup>

<sup>1</sup>Faculty of Teacher Education, University of Rijeka, Croatia

<sup>2</sup>Faculty of Sport and Physical Education, University of Novi Sad, Serbia

### Abstract

The sample of 161 girls at the preschool age was applied to a system of 28 variables (14 morphological and 14 motor variables), with the aim to apply the canonical correlation analysis and determine their relations. The results showed two obtained canonical correlation ( $R_c = .75$ ,  $R_c = .59$ ), which are statistically significant at the  $p = .00$ . The first canonical structure in morphological space was defined as an integral canonical factor of growth and development, the second one as fat tissue, while in motor area the first as integral canonical factor of motor skills, the second one as canonical factor of flexibility. The conclusion is that preschool-age girls are more successful in motor abilities if they have increased values of the morphological characteristics, and vice versa.

**Key words:** girls, preschool age, morphological characteristics, motor abilities, canonical relations

### Introduction

By the birth of a child anthropological characteristics (morphological, motor, functional, intellectual and other characteristics) are potentials that are likely to optimally transform under the influence of the process of learning and practicing, which depends on the qualitative values of endogenous and exogenous conditions in which the child is growing up and developing. Children's organism does not change equally in all anthropological segments as they are growing up because the changes in one system occur prior to the changes in another organ system. Then there are unfavourable circumstances in a high genetic influence of certain anthropological dimensions as well as the differences between sexes in having motor knowledge (Starč, at all., 2004; Pejčić & Malacko, 2005; Malacko, 2009).

Since anthropological characteristics are connected with significant or less significant positive or negative links, children's organism may be regarded as a network of interactive segments and elements because there are no absolute independent anthropological features, abilities or characteristics, which means that the development of any of them has influence on the others. It means that anthropological characteristics of children ought to be transformed, neutralized and/or made balanced equally and with worked-out plans, and then they should be thoughtfully, efficiently and evenly developed at the preschool age (Pejčić, 2002; Trajkovski, 2011).

The aim of the research is to determine statistically significant canonical relations between the system of morphological variables and the system of motor variables in the case of preschool girls. The obtained information may contribute to optimal, timely and efficient modelling, diagnosis, planning, programming, implementing and controlling of the effects under the influence of selected and/or newly-constructed kinesiological programme activities.

### Methods

The sample of subjects consisted of 161 girls belonging to the pre-primary school age (4, 5 and 6 years old) from Primorsko-Goranska County (including nursery schools from Fužine, Kostrena, Delfin, Delnice, Zamet, Maestral, Krnjevo and Galeb).

The sample of variables consisted of 28 variables, of which 14 variables of morphological characteristics and 14 variables of motor skills.

Test	Measured capacity	Measuring unit
<i>Morphological variables:</i>		
HEB - the height of the body	<i>longitudinal dimension of the skeleton</i>	mm
LEL - the length of the leg	"	"
LEA - the length of the arms	"	"
WEB - the weight of the body	<i>voluminosity of the body</i>	kg
PUA - perimeter of the upper arm	"	mm
PUL - perimeter of the upper leg	"	"
PAB - perimeter of the abdomen	"	"
PHI - perimeter of the hips	"	"
DEL - diameter of the elbow	<i>transversal dimension of the skeleton</i>	mm
DHA - diameter of the hand	"	"
DKN - diameter of the knee	"	"
SUA - skin crease of the upper arm	<i>panniculus adiposus</i>	mm
SCB - skin crease of the back	"	"
SUL - skin crease of the upper leg	"	"
<i>Motor variables:</i>		
MOD - moving the dice	<i>agility</i>	sec
BHS - walking backwards and with hand support	<i>coordination</i>	"
CRH - hopscotch	<i>coordination of the rhythm</i>	"
SLJ - standing long jump	<i>explosive strength of the legs</i>	cm
EWB - endurance while hanging	<i>static strength of arms and shoulders</i>	sec
L15 - lifting the abdomen for 15 seconds	<i>repetitive strength of the abdomen</i>	fr
L30 - lifting the abdomen for 30 seconds	"	"
BWS - bent while sitting	<i>flexibility of hamstrings</i>	cm
SLL - spreading the legs on the wall while lying - left	<i>flexibility of the hips</i>	"
SLR - spreading the legs on the wall while lying - right	"	"
SAW - spreading the arms while lying	<i>flexibility while lying</i>	"
PBA - pulse before the activities	<i>endurance</i>	fr
PAA - pulse after activities	"	"
3MP -3 - minute polygon	"	m

For calculating the relations between the system of morphological variables and of motor variables, canonical correlative analysis has been applied. Testing of statistical significance of hypothesis on global links between two different systems of variables is conducted with the help of:  $\lambda$  - statistically significant characteristic roots,  $R_c$  - quotient of canonical correlation of statistically significant pairs of canonical factors,  $R_c^2$  - squared canonical correlation,  $\chi^2$  - Bartlett's chi-square test and  $p$  - testing of statistical significance at the level .05 to .00 ( $p=.05-.00$ ). The data processing was carried out by a software package STATISTICA 8.

## Results

The analysis of cross-correlation matrix between motor and morphological variables (Table 1) shows that there are statistically significant correlations of the pairs of variables at the level of  $p=.01$  - .05 (\*\* $p_{.01}$  - \* $p_{.05}$ ).

A statistically significant negative (actually logically positive) correlation at the level of  $p=.01$  is obtained between motor variable moving the dice - MOD and morphological variables the height of the body - HEB, the length of the leg - LEL, the length of the arms - LEA, perimeter of the hips - PHI, diameter of the elbow - DEL, diameter of the hand - DHA and diameter of the knee - DKN, whereas the correlation with perimeter of the upper leg - PUL is  $p=.05$ . Walking backwards and with hand support - BHS is in a negative (actually positive) correlation at the level of  $p=.01$  with the height of the body - HEB, the length of the leg - LEL, the length of the arms - LEA diameter of the hand - DHA and diameter of the knee - DKN. The variable hopscotch - CRH is also in a negative (positive) correlation at the level of  $p=.01$  with the height of the body - HEB, the length of the leg - LEL, the length of the arms - LEA, diameter of the hand - DHA and diameter of the knee - DKN, whereas it is in a positive correlation at the level of  $p=.05$  with skin crease of the back - SCB. Standing long jump - SLJ is in a statistically significant correlation at the level of  $p=.01$  with the height of the body - HEB, the length of the leg - LEL, the length of the arms - LEA, diameter of the hand - DHA and diameter of the knee - DKN, whereas diameter of the elbow - DEL and perimeter of the hips - PHI has a statistically significant correlation at the level of  $p=.05$ . The variables lifting the abdomen for 15 seconds - L15 and lifting the abdomen for 30 seconds - L30 are in a statistically significant correlation at the level of  $p=.01$  with the height of the body - HEB, the length of the leg - LEL, the length of the arms - LEA and diameter of the hand - DHA, whereas lifting the abdomen for 30 seconds - L30 is in a statistically significant correlation with a variable perimeter of the hips - PHI. Spreading the legs on the wall while lying right - SLR is in a positive correlation at the level of  $p=.05$  with diameter of the elbow - DEL. The variable spreading the arms while lying - SAW is in a statistically significant correlation at the level of  $p=.01$  with variables the height of the body - HEB, the length of the leg - LEL, the length of the arms - LEA, perimeter of the upper arm - PUA, perimeter of the hips - PHI and the variables diameter of the elbow - DEL, diameter of the hand - DHA and diameter of the knee - DKN, whereas it is in a statistically significant correlation at the level of  $p=.05$  with the variable perimeter of the abdomen - PAB and perimeter of the upper leg - PUL. Pulse before the activities - PBA is in a statistically significant

Table 1. Cross-correlation between variables of morphological characteristics and variables of motor abilities

Variables	MOD	BHS	CRH	SLJ	EWH	L15	L30	BWS	SLL	SLR	SAW	PBA	PAA	3MP
HEB	-.55**	-.40**	-.37	.45**	.06	.27**	.28**	.02	.02	.01	.42**	-.16*	-.15*	.23**
LEL	-.57**	-.39**	-.44**	.48**	.08	.32**	.34**	-.01	.04	-.04	.40**	-.17*	-.10	.27**
LEA	-.53**	-.38**	-.38**	.46**	.07	.27**	.29**	.02	.08	.02	.43**	-.19*	-.13	.24**
WEB	-.12	-.11	-.10	.01	-.02	.07	.07	.06	.05	-.02	.13	-.06	-.04	-.04
PUA	-.13	-.05	-.02	.11	-.05	.04	.06	.07	.13	.13	.20**	-.00	.06	.06
PUL	-.16*	-.07	-.04	.10	-.05	.05	.06	.01	.09	.06	.18*	-.10	.07	.04
PAB	-.14	-.01	-.00	.09	-.06	-.01	-.00	-.03	.05	.03	.15*	.05	.15*	-.05
PHI	-.24**	-.13	-.08	.16*	-.03	.13	.16*	.03	.09	.08	.26**	-.10	.00	.03
DEL	-.23**	-.17	-.04	.19*	-.02	.05	.08	.11	.09	.17*	.30**	-.06	-.05	.01
DHA	-.30**	-.24**	-.19*	.31**	.04	.22**	.21**	.05	-.01	.04	.34**	-.14	-.19*	.16*
DKN	-.33**	-.22**	-.28**	.23**	-.05	.11	.12	.02	.00	-.03	.25**	-.10	-.01	.14
SUA	-.04	.00	-.09	.01	-.11	.02	.01	-.03	.04	-.13	.09	.01	.19*	-.07
SCB	.04	.09	.16*	-.12	-.09	-.04	-.04	.00	.04	.00	.05	.07	.19*	-.13
SUL	.04	.14	.07	-.10	-.11	.00	.01	-.03	.08	-.02	.06	-.00	.17*	-.13
	$\lambda$	Rc	Rc <sup>2</sup>	c <sup>2</sup>	p									
1	.09	.75	.57	340,57	.00*									
2	.21	.59	.35	218,25	.00*									

Legend:  $\lambda$  - Lambda, Rc - canonical correlation, Rc<sup>2</sup> - canonical R - square, c<sup>2</sup> - Bartlett's chi-square test, p - level of significance (<.05)

Morphological variables:

HEB - the height of the body, LEL - the length of the leg, LEA - the length of the arms, WEB - the weight of the body, PUA - perimeter of the upper arm, PUL - perimeter of the upper leg, PAB - perimeter of the abdomen, PHI - perimeter of the hips, DEL - diameter of the elbow, DHA - diameter of the hand, DKN - diameter of the knee, SUA - skin crease of the upper arm, SCB - skin crease of the back, SUL - skin crease of the upper leg

Motor variables:

MOD - moving the dice, BHS - walking backwards and with hand support, CRH - hopscotch, SLJ - standing long jump, EWH - endurance while hanging, L15 - lifting the abdomen for 15 seconds, L30 - lifting the abdomen for 30 seconds, BWS - bent while sitting, SLL - spreading the legs on the wall while lying - left, SLR - spreading the legs on the wall while lying - right, SAW - spreading the arms while lying, PBA - pulse before the activities, PAA - pulse after activities, 3MP - 3-minute polygon

negative correlation at the level of  $p=.05$  with the variables the height of the body - HEB, the length of the leg - LEL and the length of the arms - LEA. Pulse after activities - PAA is in a negative statistically significant correlation at the level of  $p=.05$  with the variables the height of the body - HEB and diameter of the hand - DHA, whereas it is in a positive correlation with perimeter of the abdomen - PAB skin crease of the upper arm - SUA, skin crease of the back - SCB and skin crease of the upper leg - SUL. The variable 3-minute polygon - 3MP is in a statistically significant correlation at the level of  $p=.01$  of the variables the height of the body - HEB, the length of the leg - LEL, the length of the arms - LEA, whereas it is at the level of  $p=.05$  with the variable diameter of the hand - DHA.

By solving characteristic equations of the cross-correlative matrix with the help of Bartlett chi-square test ( $\chi^2=340.57$ ,  $\chi^2=218.57$ ) statistical significance of the quotient of canonical correlation is tested (Rc=.75, Rc=.59). As the roots of these equations, the squares (coefficients of determination) of canonical correlation are obtained (Rc<sup>2</sup> =.57, Rc<sup>2</sup> =.35), which explain the common variance of the variables from the two sets of the total variability of analyzed systems of variables. Thus two independent and statistically significant structures of canonical factors were identified, which are statistically significant at the level of  $p=.00$ .

The results from the matrix of the structure of canonical factors of morphological characteristics and motor abilities (Table 2) show that statistically significant correlations are at the levels of  $p=.01$  (\*\*) and  $p=.05$  (\*) between manifest variables of morphological characteristics and motor abilities with isolated canonical factors.

The structure of the first morphological canonical factor (Fc-1) consists of the variables *longitudinal dimension of the skeleton* (the height of the body - HEB, the length of the leg - LEL, the length of the arms - LEA), *voluminosity of the body* (perimeter of the upper leg - PUL, perimeter of the hips - PHI), *transversal dimension of the skeleton* (diameter of the hand - DHA, diameter of the knee - DKN) and *panniculus adiposus* (skin crease of the back - SCB), so it can be interpreted as integral canonical factor of the growth and development. The second morphological canonical factor (Fc-2) can be regarded as *panniculus adiposus* because it is defined by the variables skin crease of the upper arm - SUA and skin crease of the upper leg - SUL.

Table 2. Structure of canonical factors (Fc) of morphological characteristics and motor abilities

Variables	Fc - 1	Fc - 2
<b>Morphological variables</b>		
HEB - the height of the body	.76**	-.23
LEL - the length of the leg	.83**	-.06
LEA - the length of the arms	.77**	-.18
WEB - the weight of the body	.12	-.06
PUA - perimeter of the upper arm	.11	-.04
PUL - perimeter of the upper leg	.16*	.00
PAB - perimeter of the abdomen	.07	.12
PHI - perimeter of the hips	.24**	-.17
DEL - diameter of the elbow	.22	-.37**
DHA - diameter of the hand	.46**	-.30
DKN - diameter of the knee	.46**	.00
SUA - skin crease of the upper arm	.08	.35**
SCB - skin crease of the back	-.21**	.10
SUL - skin crease of the upper leg	-.14	.20**
<b>Motor variables</b>		
MOD - moving the dice	-.78**	-.19
BHS - walking backwards and with hand support	-.60**	-.29
CRH - hopscotch	-.76**	.22
SLJ - standing long jump	.73**	.14
EWB - endurance while hanging	.14	.13
L15 - lifting the abdomen for 15 seconds	.42**	.10
L30 - lifting the abdomen for 30 seconds	.43**	.18
BWS - bent while sitting	-.03	.38**
SLL - spreading the legs on the wall while lying - left	-.00	.13
SLR - spreading the legs on the wall while lying - right	-.12	.59**
SAW - spreading the arms while lying	.46**	.38
PBA - pulse before the activities	-.25**	-.16
PAA - pulse after activities	-.22	-.56**
3MP - 3-minute polygon	.53**	.00

Since the structure of the first canonical factor of motor abilities (Fc=1) is defined by the variables *agility* (moving the dice - MOD), *coordination* (walking backwards and with hand support - BHS), *coordination of the rhythm* (hopscotch - CRH), *explosive strength of the legs* (standing long jump - SLJ), *repetitive strength of the abdomen* (lifting the abdomen for 15 seconds - L15, lifting the abdomen for 30 seconds - L30), *flexibility while lying* (spreading the arms while lying - SAW) and *endurance* (Trajkovski, 2011), (pulse before the activities - PBA, pulse after activities - PAA, 3-minute polygon - 3MP), it can be interpreted as integral canonical factor of motor abilities. The second motor canonical factor (Fc=2) can be interpreted as a canonical factor of flexibility because it is defined by the variables *flexibility of hamstrings* (bent while sitting - BWS) and *flexibility of the hips* (spreading the legs on the wall while lying - right - SLR).

## Discussion and conclusions

The relations between the first morphological canonical factor, interpreted as integral canonical factor of growth and development and the first motor canonical factor, interpreted as integral canonical factor of motor abilities, show that preschool girls have better results in motor abilities *agility* (moving the dice - MOD), *coordination* (walking backwards and with hand support - BHS), *coordination of the rhythm* (hopscotch - CRH), *explosive strength of the legs* (standing long jump - SLJ), *repetitive strength of the abdomen* (lifting the abdomen for 15 seconds - L15, lifting the abdomen for 30 seconds - L30), *flexibility while lying* (spreading the arms while lying - SAW) and *endurance* - "sliding polygon" (pulse before the activities - PBA, 3-minute polygon - 3MP) if they have increased values in morphological variables *longitudinal* (the height of the body - HEB, the length of the leg - LEL, the length of the arms LEA), and *transversal* (diameter of the

hand - DHA, diameter of the knee - DKN) *dimension of the skeleton, voluminosity of the body* (perimeter of the upper leg - PUL, perimeter of the hips - PHI) as well as reduced values of skin crease of the back – SCB. Conversely, they achieve weaker results in motor abilities if they have reduced values in the above-mentioned morphological variables.

The relations between the second morphological canonical factor, interpreted as *panniculus adiposus* (skin crease of the upper arm - SUA, skin crease of the upper leg - SUL), and the second motor canonical factor, interpreted as the factor *flexibility* (bent while sitting - BWS, spreading the legs on the wall while lying right - SLR) shows that girls have better values in the flexibility if they have increased values in *panniculus adiposus* (skin crease of the upper arm - SUA, skin crease of the upper leg - SUL) and vice versa.

These statements can be respected only in the given moment and under the existing conditions because when there are changes in morphological characteristics (increased or decreased fatty tissue, favourable or unfavourable increase of the skeleton dimensions, etc.), they may become a disorder factor in achieving better results in some relevant motor abilities, especially in agility, coordination and explosive strength. In the context of the immediate educational and/or training activities it means that the certain desired specific (segment) motor ability can be adapted to the morphological characteristics of an individual or a group because it is almost impossible to do the opposite – namely, due to their genetic limitations some morphological characteristics cannot be more or less changed, that is to say, they cannot be adapted to the situations within educational or sports activities.

In conclusion, the results of the research showed that well-balanced programme activities were applied in the operations with the children at this age, which means that they were primarily directed to the development of relevant motor abilities and adapted to morphological characteristics of preschool girls and thus they served as the basis for continuous educational/training process.

## References

1. Malacko, J. (2009). Interaction between genetic and non genetic potentials in the function of creation and development of sportsmen individuality. *Sport Science*, 2 2: 36-40.
2. Pejčić, A. (2002). *Orientation to sporting activities based on morphological and motor attributes of children*. Proceedings Book 3<sup>rd</sup> International scientific conference “Kinesiology-new perspectives”, p.p. 114-118. Zagreb: Faculty of Kinesiology, University of Zagreb.
3. Pejčić, A., Malacko, J. (2005). The ontogenetic development of morphological characteristics and motor abilities of boys and girls in early elementary school. *Kinesiologia slovenica*, 2 (42-55).
4. Starc, B., Čudina Obradović, M., Pleša, A., Profaca, B. & Letica, M. (2004). *Osobine i psihološki uvjeti razvoja djeteta predškolske dobi* [The characteristics and psychological conditions of development of children belonging to the pre-primary school age]. Zagreb: Golden marketing-tehnička knjiga.
5. Trajkovski, B. (2011). *Kinantropometrijska obilježja djece predškolske dobi i njihova povezanost s razinom tjelesne aktivnosti roditelja* [Kinanthropometry features of preschool children and their relationship with the level of the physical activity their parents. In Croatian.] (Unpublished doctoral dissertation, University of Zagreb). Zagreb: Faculty of Kinesiology, University of Zagreb.

## DIFFERENCES IN MORPHOLOGICAL CHARACTERISTICS AND MOTOR SKILLS BETWEEN HIGH SCHOOL GIRLS AND BOYS

Josipa Peršun<sup>1</sup>, Srna Jenko Miholić<sup>2</sup> and Ivan Vrbik<sup>3</sup>

<sup>1</sup>*IX. Grammar School, Zagreb, Croatia*

<sup>2</sup>*Faculty of Teacher Education, University of Zagreb, Croatia*

<sup>3</sup>*Industrial Trades School Sisak, Sisak, Croatia*

### Abstract

This study was a transversal research with the goal of finding existence of differences in morphological characteristics and motor skills between high school girls and boys. For this purpose a total of 410 high school pupils have been examined in Zagreb. The sample included 205 boys and 205 girls, from 15 to 19 years of age. All subjects were tested in the same environment with altogether 13 standard morphologic measures and motor tests. Anthropometric measures were described with following variables: body height, body mass, upper arm girth, upper leg girth, and upper arm skinfold and shank skinfold. Motor abilities were estimated via following motor tests: obstacle course over and through (coordination), standing long jump (explosive strength), sit-ups (muscular strength of the torso), bent arm hang (muscular endurance of the shoulder girdle and arms), arm plate tapping (movement frequency), forward bent (flexibility) and one legged balance bench standing (balance). Basic descriptive parameters were calculated for all the data and canonical discriminative analysis resulted in statistically significant differences between boys and girls

**Key words:** *boys, discriminative analysis, girls, high school pupils, morphological characteristics, motor skills*

### Introduction

Morphological anthropometry is a method of human body measurement, processing and studying of the measures obtained. Morphological anthropometry has found application in numerous fields, e.g., sports kinesiology, recreational and educational kinesiology, sports medicine, pediatrics, and school medicine to monitor growth in children and adolescents, as part of practical standard procedures for nutritional status assessment, in research into specific morphological features during growth and development, correlation of body dimensions with other anthropological characteristics, and in anthropological studies of the population structure (Mišigoj-Duraković, 2008). Growth and development are the basic biologic feature of the child's body, whereby it develops into the maturing body under the influence of disposing factors, various environmental factors and its own activity (Malina, 1984; Forbes, 1987; Shepard, 1991; Malina and Bouchard, 1991). Body growth and development implies an increase in body mass and height, proportional changes, skeletal maturation, and anatomic-functional maturation of organs and organ systems

According to current state-of-the-art, intensive growth and development occurs up to 5 years of age, followed by slowing down for some 3–4 years, then intensifying again to the age of 16–17. On the other hand, the elements of endocrine system undergo constant intensive development to the adolescence, when it shows marked decline. And finally, genital development intensifies after the age 13–14.

The growth and maturation are influenced by gene, hormone, dietary and environmental interactions (Mišigoj-Duraković, 2008). During growth and aging, the body composition undergoes constant changes related to health status, dietary habits and physical activity (Gualdi-Russo et al., 1992).

During their secondary education, young people go through the period of adolescence (Malina, Bouchard & Bar-Or, 2004.; Pangrazzi & Darst, 1997). Adolescence is a specific period marked with numerous biological, physiological and sociological changes which prepare young people for adulthood (Holmes, 1995, Hutchinson & Roussell, 2003). It is a difficult period to define in terms of chronological age because of variation in the time of its onset and termination. The World Health Organization defines the age of adolescence as between 10 and 18 years, but the age ranges 8 to 19 years in girls and 10 to 22 years in boys are more appropriate as limits for adolescence (Malina, Bouchard & Bar-Or, 2004).

A child's motor development is mainly systematically influenced by the process of physical education (PE) within the education system. The purpose of PE classes is to satisfy basic biological needs for physical activity, enhance fitness level of young people, form a healthy lifestyle and positive attitudes towards sport and develop social values, norms, ethical rules and behavioral patterns.

Evaluation of the relevant dimensions of anthropologic status is a basis of every programmed training process in physical education. Anthropologic status is defined by the level and relations of the dimensions evaluated (Katić et

al., 1994; Katić & Viskić-Štalec, 1996.; Katić, 2003.; Katić et al., 2004.). Measuring anthropological characteristics is a common procedure used by physical education teachers which enables planning, programming and conducting a process of physical exercise. Testing protocols include anthropometric measuring as well as performing tests for motor and functional skills evaluation (Findak, 1999). Respecting the differences between boys and girls is a basis of proper planning and programming of educational process.

According to Mišigoj-Duraković (2008), sex is one of the main factors of interindividual variability. Sexual dimorphism is not distinct before puberty for most of the anthropometry characteristics, size, physique and body composition, or for most of the functional abilities. With hormone changes, that will be responsible for sexual maturation, differences in many characteristics and abilities start to develop.

The purpose of the present research was to establish the status, dynamics and structure of morphological and motor status of girls and boys, high school students, and to identify existence of statistically significant differences between male and female students, in morphological characteristics and motor abilities, and to determine which variable contributes the most to the differentiation of the groups. Also, in the interest of this research was to acquaint students of grammar school in Zagreb with their current physical condition and effects of their work and show them why is regularity and quality in physical activity important because period of high school education is very important in creating consciousness about importance of regular physical exercise.

## Methods

**Sample** - The research was conducted in May 2010. during regular PE classes on a sample of 410 students of one grammar school in Zagreb, Croatia. Only healthy students, who were not exempt from physical education for health reasons were measured. Anthropometric and motor measurements have been performed in the morning school shifts during regular PE classes.

Table 1. Size of subsamples in different grade and sex groups

	1 <sup>st</sup> grade	2 <sup>nd</sup> grade	3 <sup>rd</sup> grade	4 <sup>th</sup> grade	TOTAL
MALES	55	51	64	35	205
FEMALES	67	52	46	40	205
TOTAL	122	103	110	75	410

**Variables** - The battery consists of six anthropometric measures and seven tests for motor skill evaluation. The selection of motor tests is based on the model by Kurelić et al (1975). Measurements of anthropometry were conducted according to International Biological Program (IBP), so height and weight were measured once and skinfolds three times.

Table 2. Sample of variables

Abbreviation	Test	Measured capacity	Measuring unit
ATV	Body height	Longitudinal dimension of the body	mm
ATT	Body weight	Volume of the body	kg
AONL	Upper arm circumference	Amount of body fat	mm
AONT	Upper leg circumference	Amount of body fat	mm
ANNL	Upper-arm skinfold	Amount of body fat	mm
ANPK	Lower leg skinfold	Amount of body fat	mm
MBFTAP	Hand plate tapping – 20 seconds	Speed of alternate movement	no. of repetitions
MESDM	Standing long jump	Explosive strength	cm
MKPIP	Obstacle course over and through	Co-ordination of the whole body movement	seconds
MRSPT	60-second sit-ups	Strength of abdominal muscles	no. of repetitions
MFPR	Forward bent	Flexibility	cm
MSSIV	Bent-arm hang	Muscular endurance of the shoulder girdle and arms	seconds
MRU10	One foot on balance bench	Balance	seconds



**Data analysis** - The data were analyzed using the statistical package Statistica for Windows, ver. 7.8. Basic parameters of the distribution of variables were calculated (mean, standard deviation, minimal and maximal value, skewness, kurtosis). Normality of distribution was verified with Kolmogorov- Smirnov test. Discriminant analysis was conducted to determine differences and determine which variable contributes the most to the difference.

## Results

Basic descriptive parameters, means and standard deviations of subsamples according to their sex and grade in all anthropometric and motor variables are shown in Tables 3. and 4.

Table 3. Basic descriptive parameters for boys - grade 1 - 4

	1 <sup>st</sup> grade		2 <sup>nd</sup> grade		3 <sup>rd</sup> grade		4 <sup>th</sup> grade	
	Mean	Std.Dev.	Mean	Std.Dev.	Mean	Std.Dev.	Mean	Std.Dev.
ATV	179,95	8,43	179,69	6,03	182,72	8,30	180,46	8,94
ATT	71,10	11,86	73,18	10,97	74,94	12,10	77,00	12,34
AONL	29,03	3,35	30,41	4,31	29,88	2,95	30,95	2,90
AONT	54,29	5,46	55,80	6,22	55,81	4,83	56,64	4,35
ANNL	13,20	4,93	12,52	4,61	12,74	5,83	14,69	5,72
ANPK	13,61	5,36	12,19	4,68	11,37	4,98	13,49	5,74
MKPIP	16,73	3,88	15,06	3,42	15,14	3,45	17,55	4,08
MESDM	212,09	24,17	219,24	21,86	224,29	27,53	217,26	28,83
MRSPT	53,77	10,19	50,04	12,65	54,56	10,96	49,16	9,59
MSSIV	46,13	21,78	50,52	24,86	57,13	24,65	41,14	25,47
MBFTAP	37,76	3,45	38,57	3,30	39,84	3,34	36,65	3,83
MFPR	64,14	9,20	66,03	10,21	61,38	12,45	63,39	11,65
MRU10	7,80	12,68	7,07	9,26	8,48	11,02	5,16	3,55

Table 4. Basic descriptive parameters for girls - grade 1 - 4

	1 <sup>st</sup> grade		2 <sup>nd</sup> grade		3 <sup>rd</sup> grade		4 <sup>th</sup> grade	
	Mean	Std.Dev.	Mean	Std.Dev.	Mean	Std.Dev.	Mean	Std.Dev.
ATV	166,61	6,29	167,76	6,76	166,61	6,11	166,11	5,19
ATT	58,10	8,21	60,18	9,66	60,43	9,60	57,55	7,40
ANNL	26,58	2,75	27,85	2,86	28,22	3,33	27,56	2,77
ANPK	54,04	5,16	55,10	4,27	55,53	5,09	55,49	4,54
ANNAD	18,00	4,31	19,29	5,24	19,48	5,49	18,17	4,85
ANP	18,05	5,15	19,21	5,61	17,90	6,12	17,51	4,80
MKPIP	19,22	5,64	19,16	5,30	18,51	6,87	18,42	3,67
MESDM	167,32	16,27	169,68	14,42	170,43	18,37	168,88	20,77
MRSPT	41,82	7,68	42,79	8,95	41,61	9,37	42,23	9,38
MSSIV	27,95	18,56	30,44	17,18	28,08	20,90	26,57	16,94
MBFTAP	35,10	3,55	34,19	3,57	36,02	2,92	35,25	3,49
MFPR	66,61	9,94	67,33	7,91	67,61	10,50	66,70	8,73
MRU10	4,21	3,08	4,86	4,16	4,43	2,44	5,75	4,47

After descriptive analysis, Kolmogorov- Smirnov test was conducted for establishing normality of distribution for all 13 morphological and motor variables. Results had shown that distributions don't deviate from normal ones. Then discriminant analysis was conducted to determine statistically significant differences ( $p < 0,05$ ) between boys and girls and to determine which of the previous mentioned variables contribute the most to the difference.

Global differences between girls and boys were observed in the next phase. Tables 5. and 6. show significance of isolated discriminant morphological and motor functions in all 4 grades, and in tables 7. and 8. factor structure and position of centroides on discriminant function are shown.

Table 5. Results of discriminant analysis - morphological variables

	Eigen-	Canonicl	Wilks'	Chi-Sqr.	df	p-level
1 <sup>st</sup> grade	2,832903	0,859710	0,260899	157,2038	6	0,0000
2 <sup>nd</sup> grade	2,545465	0,847319	0,282050	124,0356	6	0,0000
3 <sup>rd</sup> grade	2,454813	0,842941	0,289451	130,1757	6	0,0000
4 <sup>th</sup> grade	2,584417	0,849126	0,278985	88,08512	6	0,000000

Table 6. Results of discriminant analysis - motor variables

	Eigen-	Canonicl	Wilks'	Chi-Sqr.	df	p-level
1 <sup>st</sup> grade	1,525289	0,777178	0,395994	102,3623	7	0,0000
2 <sup>nd</sup> grade	2,322958	0,836100	0,300937	103,8740	7	0,0000
3 <sup>rd</sup> grade	1,671066	0,790960	0,374382	100,7039	7	0,00
4 <sup>th</sup> grade	1,175500	0,735075	0,459664	50,91043	7	0,000000

Table 7. Factor structure of isolated discriminant function- morphology and position of centroides

	1 <sup>st</sup> grade	2 <sup>nd</sup> grade	3 <sup>rd</sup> grade	4 <sup>th</sup> grade
FACTOR STRUCTURE	Root 1	Root 1	Root 1	Root 1
ATV	0,542525	-0,589663	-0,685003	0,632650
ATT	0,398622	-0,398407	-0,414215	0,602276
AONL	0,247660	-0,221954	-0,169011	0,374640
AONT	0,023087	-0,041265	-0,018135	0,081011
ANNAD	-0,305045	0,434213	0,376033	-0,214756
ANP	-0,246496	0,430223	0,378485	-0,252997
centroids	Root 1	Root 1	Root 1	Root 1
G_1:0 -M	1,84239	-1,59530	-1,31618	1,71998
G_2:1-Ž	-1,51241	1,56462	1,83120	-1,46198

Results in table 7. show that the variables body height and weight contribute the most to the differentiation in first, third and fourth grade, while body height and two skinfolds contribute the most in the second grade.

Table 8. Factor structure of isolated discriminant function - motor abilities and position of centroides

	1 <sup>st</sup> grade	2 <sup>nd</sup> grade	3 <sup>rd</sup> grade	4 <sup>th</sup> grade
FACTOR STRUCTURE	Root 1	Root 1	Root 1	Root 1
MBKPIP	0,204064	-0,304477	-0,247546	-0,104707
MESDM	-0,894943	0,897609	0,856147	0,912537
MRSPT	-0,539603	0,220504	0,484794	0,339791
MSSIV	-0,368068	0,327198	0,479274	0,320826
MBFTAP	-0,304334	0,414352	0,464813	0,177820
MFPR	0,104975	-0,039885	-0,222990	-0,152130
MRU1O	-0,163056	0,107027	0,179397	-0,066051
CENTROIDS	Root 1	Root 1	Root 1	Root 1
G_1:0-M	-1,31189	1,54060	1,10312	1,214104
G_2:1-Ž	1,14262	-1,47505	-1,48681	-0,940930

## Discussion and conclusions

At the age of 18 boys achieve 98% of their final height (Payne & Isaacs, 1995), their growth should be finished by around the age of 22 (Malina, Bouchard & Bar-Or, 2004). Throughout the whole growth period, with exception in the early part of the adolescent spurt in which the girls are temporarily taller and heavier because of their earlier growth spurt, boys are, on the average, taller and heavier than girls. As maturation occurs, girls start to do significantly differentiate from the boys in body composition, skinfold thickness and consequently, in body fat percentage (Mišigoj-Duraković, 2008). Results in this research confirm these findings. Girls have bigger values in upper arm and lower leg skinfolds through all four grades. On the average, performance in the standing long jump increases linearly with age in both sexes until 14 years in girls and 18 years in boys. After 14 years of age in girls, attained levels of performance in the standing long jump improve only slightly. Sex differences, like in all motor skills become magnified during adolescence (Malina, Bouchard & Bar-Or, 2004). In this research situation is the same with exception in fourth grade. Girls and boys in fourth grade have lower values in this test than in all other grades before. That can be ascribed to several factors (fat accumulation, changed social interests, lack of motivation and opportunities to participate in some physical activities). The number of sit-ups performed in one minute is a measure of abdominal strength and endurance. It improves linearly with age from 6 to 13 in boys, after which it shows somewhat accelerated development. It also increases with age to 14 years in girls, with no subsequent improvement, on the average (Malina, Bouchard & Bar-Or, 2004). Sex differences become established in adolescence, what results in this research confirm. Upper body muscular endurance is measured by the flexed-arm hang. Girls show better results in first and second grade, while boys show increase in all grades except fourth. Strength increases linearly with age 13 to 14 years of age in boys, when there is acceleration in strength development. In girls, strength improves linearly with age through about 16 or 17 years with no clear evidence for an adolescent spurt as in boys. The sit-and-reach test is a measure of the flexibility of the lower back, hip and upper thigh. Girls are more flexible at all ages than boys. Girls show improvement in all grades except fourth, and boys in all except third. In all grades girls have better results than boys. Balance is essential to the performance of many motor tasks. Balance improves with age, and on average, girls perform better in balance tasks during childhood. Data for adolescence are limited but indicate small differences between boys and girls and a plateau in both sexes. This research showed statistically significant difference in anthropometric measures and motor tests between girls and boys in all four grades. Factor structure of isolated discriminant function in morphology show that body height and weight contribute the most to the differentiation in first, third and fourth grade, while body height and two skinfolds contribute the most in the second grade. Contribution to the difference in motor abilities varies through grades. Results in obstacle course over and through and standing long jump test contribute the most to the difference in the first grade. Results in standing broad jump and sit-ups test in the second and third, and results in standing broad jump and the flexed-arm hang test in the fourth grade. With the goal of enhancing future programming of physical education classes, on a sample of 410 grammar school students divided into subsamples according to grades they attend and sex, 13 measurements and tests were conducted. Aim of this research was to determine existence of statistically significant difference between girls and boys through grades. Discriminant analysis had shown that girls differ statistically from boys in morphological variables and in motor abilities in all four grades, and, therefore, separate PE lessons or more lessons with homogenized groups seem like a good solution to the problems which occur during regular lessons. A question that merits more detailed study is the relative flatness of the performance curves of girls during adolescence. Levels of performance show, on average, little or no improvement during years of their secondary education. Is this trend related to the biological (e. g. sexual maturity, fat accumulation or changes in physique), or is it related to cultural factors such as changing interests and expectations, pressure from colleagues, lack of motivation, or limited opportunities to participate in physical activities? Obtained results can be a good fundament for future research and analysis of changes of anthropological characteristics among high school population.

## References

1. Findak, V. (1999.) *Metodika tjelesne i zdravstvene kulture*, Zagreb, Školska knjiga,
2. Forbes, G. (1987.) *Human body composition: Growth aging, nutrition and activity*. New York: Springer Verlag,
3. Gredelj, M., D. Metikoš, A. Hošek, K. Momirović (1975). Model hijerarhijske strukture motoričkih sposobnosti. 1. rezultati dobiveni primjenom jednog neoklasičnog postupka za procjenu latentnih dimenzija. *Kineziologija*, 5 (1-2); 7-81.
4. Gualdi-Russo, E., Gruppioni G, Guerreschi P, Belcastro MG, Marachesini V. (1992.). Skinfolds and body composition of sports participants. *J Sports Med Phys Fitness*, Sep;32(3):303-313.
5. Himberg, C., Hutchinson, E.G. & Roussell, J.M. (2003.) *Teaching secondary physical education*. Champaign, IL: Human Kinetics
6. Katić, R. (2003.). Identification of Biomotor Structures as a Precondition for Programming Kinesiological Education in Children Aged Seven to Nine Years. *Coll. Antropol.* 27, 1: 351-360.
7. Katić, R., Pejčić, A., Viskić-Štalec, N. (2004.). The Mechanisms of Morphological-Motor Functioning in Elementary School Female First- to Fourth-Graders. *Coll. Antropol.* 28, 1: 261-269.
8. Katić, R., Viskić-Štalec, N. (1996.). Taksonomska analiza morfoloških karakteristika i motoričkih sposobnosti sedmogodišnjih dječaka. *Hrvatski športskomedicinski vjesnik*. 11, 1; 16-24.

9. Katić, R., Zagorac, N., Živičnjak, M., Hraski, Ž. (1994). Taxonomic Analysis of Morphological/Motor Characteristics in Seven-Year Old Girls. *Coll. Antropol.* 18,1: 141-154
10. Kurelić, N., Momirović, K., Stojanović, M., Šturm, J., Radojević, D., & Viskiće-Štalec, N. (1975.). *Struktura i razvoj morfoloških i motoričkih dimenzija omladine*. Beograd: Fakultet za fizičko vaspitanje.
11. Malina, R.M.(1984.). Human growth, maturation, and regular physical activity. In *Advances in Pediatric Sport Sciences, Volume 1. Biological Issues*, R.A. Boileau, editor, pp. 59-83. Champaign, IL: Human Kinetics. (CSB
12. Malina, R.M., Bouchard, C. i Bar-Or, O. (2004). *Growth, maturation and physical activity*. Champaign, IL: Human Kinetics.
13. Mišigoj-Duraković, M. (2008.). *Kinantropologija – biološki aspekti tjelesnog vježbanja*. Zagreb: Kineziološki fakultet Sveučilišta u Zagrebu.
14. Pangrazi, R.P & Darst, P.W. (1997). *Dynamic physical education for secondary school students*. 3rd edition. Boston: Allyn & Bacon.
15. Shephard, R.J. (1991). *Body Composition in Biological Anthropology*. Cambridge Studies in Biological Anthropology. Cambridge: Cambridge University Press.
16. Živičnjak, M., Szivovica, L., Pavičić, L., Smolej-Narančić, N., Janičijević, B., Miličić, J., Rudan, P. (1997.). *The Aging Process - An Analysis of the Latent Structure of Body Morphology (in Males)*. *Collegium Antropologicum* 21, 1; 117-126.

**Acknowledgement:**

The results of this study are part of the research project “Kinesiological education in preschool education and primary education” accepted and supported by the Ministry of Education and Sports of the Republic of Croatia.

## GENDER BASED MOTOR CONDITIONALITY OF FUDAMENTAL MOVEMENT SKILLS

Luka Pezelj, Damir Mumanović and Frane Žuvela

*Faculty of Kinesiology, University of Split, Croatia*

### Abstract

This research was conducted in order to establish possible relationships between fundamental movement skills performance and motor proficiency of school children. 86 children were analyzed, including 30 boys and 56 girls (average age  $9.09 \pm 1.75$  years). Children's fundamental movement skills were assessed with FMS- Polygon. The Bruininks-Oseretsky Test of Motor Proficiency – Second Edition (BOT-2) was used to assess motor proficiency. Correlation between fundamental movement skills and children's motor proficiency was confirmed by using Pearson's correlation coefficient with  $p < .05$ . The results of the research show that fundamental movement skills performance in school children is significantly related to motor performance.

**Key words:** *polygon, motor performance, correlation, BOT-2, 9-year-olds*

### Introduction

Fundamental movement skills are the ABC of movement. According to Mrakovic et al. (1993) all fundamental movement skills or so-called natural forms of movement can be divided according to their utility into the following groups: space covering skills, surmounting obstacles skills, resistance overcoming skills and object control skills. Although fundamental movement skills have been consistently related to anthropological characteristics, there are important limitations to these studies. Much of this research has relied only on motor-functional abilities and has not considered the motor proficiency. The best definition of motor proficiency is the specific abilities measured by tests of running speed and agility, balance, bilateral coordination, strength, upper-limb coordination, response speed, visual-motor control and upper-limb-speed and dexterity (Sherrill, 1993). Motor proficiency is multidimensional and is based upon the performance of flexion, extension and rotational movements that lead to the successful performance of fundamental movement skills. When evaluating a child's level of motor proficiency, selected tasks are judged to be significant indicators of the level of development of these abilities. Although a variety of movement abilities have been proposed to be fundamental to motor skill performance, there is general agreement in the literature that the ability to exhibit speed, precision, strength, balance and coordination are critical factors that must be tested in order to assess any individual's level of motor proficiency. It is already known that higher level of fundamental movement skills acquisition has a positive impact on adoption of specialized motor skills and it positively correlated with motor performance. Considering the importance of a future exploration in a field of motor proficiency the aim of this study was to identify the correlation of motor proficiency and the performance of fundamental movement skills differently by gender. It was hypothesized that youth with greater motor proficiency would have better fundamental movement skills.

### Methods

**Subjects:** The study included a sample of 86 children (30 male and 56 female) aged 8-10 years from elementary schools in Kastela, republic of Croatia. All of them were chosen randomly and gave verbal assent and their parents gave written informed consent. The Ethical Committee of the *Faculty of Kinesiology – University of Split* verified that this investigation complied with all ethical standards for scientific investigations involving human participants.

**Motor proficiency:** The "Bruininks-Oseretsky Test of Motor Proficiency – Second Edition" (BOT-2) (Bruininks & Bruininks, 2005) was used to assess motor proficiency. BOT-2 is used to assess fine and gross movement skill development. The test is suitable for individuals aged 4 to 21 years. The complete BOT-2 features 53 items and is divided into 8 subtests. For the purpose of this research three test for each motor area were selected: *fine motor precision* (drawing lines through paths-curved, connecting papers, folding paper), *fine motor integration* (copying overlapping circles, coping a star, coping overlapping pencils), *manual dexterity* (transferring pennies, placing pegs into a pegboard, stinging blocks), *bilateral coordination* (jumping in place-opposite sides synchronized, pivoting thumbs and index fingers, tapping feet and fingers-opposite sides synchronized), *balance* (standing on one leg on a balance beam-eyes open, standing hell-to-toe on balance beam, standing on one leg on a balance beam-eyes closed), *running speed and agility* (shuttle run, one-legged side hop, two-legged side hop), *upper limb coordination* (dropping and catching a ball-one hand, cathing a tossed ball-one hand,

dribbling a ball-alternating hands) and *strength* (standing long jump, sit-ups, v-up). The result of each task could be a drawing, a number of objects or events, or a length of time. Each result was later transformed into a point score on a graded scale. A total score for each motor area was gained by summing the point scores of the tests.

**Fundamental movement skills:** The fundamental skills test – FMS- POLYGON (Žuvela et al., 2011) was used to assess children's fundamental movement skills. The FMS-POLYGON consisted of 4 tests, one from each motor skills area (space covering skills, surmounting obstacles skills, resistance overcoming skills and object control skills) according to Mrakovic et al. (1993). FMS polygon includes: tossing and catching the volleyball against a wall consecutively; running across obstacles; carrying the medicine balls; and straight running. An area of 10x24 meters, 14 cones, 3 obstacles, 2 medicine balls, a volley ball, a Swedish vault and 4 pairs of photocells are needed for the FMS-POLYGON execution.

**Data analysis:** Data were analyzed using the Statistica for Windows 7.0 package and the statistical significance was set at  $P \leq 0.05$ . Basic descriptive statistics were calculated (mean value, standard deviation and Kolmogorov-Smirnov test). Based on the test for normality, parametric and non-parametric analyses were used. Independent t-tests were used to examine gender differences in variables with normal distribution. Mann-Whitney tests were used to examine gender differences in the variables in which the assumption of normality was not met. The association between the motor proficiency and the fundamental movement skills was analyzed with the use of Pearson correlation coefficient ( $r$ ).

## Results

Significant gender differences were found only for fine motor integration (Table 1). The independent sample t-test found that females performed significantly better than males in the fine motor integration area ( $t = 2.11$ ,  $p = 0.04$ ). Non-normal distributions were found for fine motor integration, bilateral coordination, balance and upper-limb coordination. No gender differences were observed in fine motor integration ( $m-w = 1.78$ ,  $p = 0.08$ ), bilateral coordination ( $m-w = 1.45$ ,  $p = 0.15$ ), balance ( $m-w = 1.74$ ,  $p = 0.08$ ) or in the upper-limb coordination ( $m-w = -0.27$ ,  $p = 0.79$ ).

Table 1. Motor proficiency and fundamental movement skills - mean values (AS), standard deviation (SD) and t-test or m-w test according to gender

	Boys AS±SD	Girls AS±SD	t-test/ m-w test	p/z
<b>Motor proficiency – BOT-2</b>				
Fine motor precision	16.47±3.42	17.98±3.15	2.11	0.04
Fine motor integration	12.23±3.27	13.18±3.27	1.78	0.08
Manual dexterity	16.87±3.16	17.39±3.16	0.79	0.43
Bilateral coordination	7.97±1.67	8.46±1.67	1.45	0.15
Balance	9.70±1.82	10.41±1.82	1.74	0.08
Running speed & agility	21.73±2.65	22.30±2.65	0.92	0.36
Upper-limb coordination	15.30±2.37	15.29±2.37	-0.27	0.79
Strength	15.87±2.69	16.32±2.69	0.87	0.39
<b>Fundamental movement skills</b>				
FMS-Polygon*	25.83±3.79	25.37±3.79	-0.63	0.53

\* variable with the opposite metric orientation

Pearson's correlations were used to analyze the relationships between the studied variables. Table 2 presents the results of correlations for the total sample. The results of the correlation analyses demonstrate a statistically significant correlation between the fundamental movement skills and fine motor precision, fine motor integration, manual dexterity, bilateral coordination, running speed and agility, upper-limb coordination and strength.

Table 2. Correlations between subtests of BOT-2 scores and FMS-Polygon score

	FMS-Polygon (N=86)	
	<i>r</i>	<i>p</i>
<b>BOT-2</b>		
Fine motor precision	-0.45	<b>0.01</b>
Fine motor integration	-0.28	<b>0.01</b>
Manual dexterity	-0.54	<b>0.01</b>
Bilateral coordination	-0.27	<b>0.01</b>
Balance	-0.21	0.05
Running speed & agility	-0.64	<b>0.01</b>
Upper-limb coordination	-0.64	<b>0.01</b>
Strength	-0.74	<b>0.01</b>

## Discussion and conclusion

The performance of 86 Croatian children in eight subtest of the BOT-2 in the present study was analyzed. Among the eight subtests, it was noted that girls performed significantly better in fine motor precision subtest. The present results are consistent with those of Chui et al. (2007), who found that girls performed better than boys in Visual-Motor Control, which was partly contributed by fine motor control. According to the results of this study, gender differences should be considered when evaluating motor skills in Croatian children, especially for fine motor skills subtest. Therefore, the establishment of a set of gender-specific norms is urgently required. Gender differences in fine motor precision can be explained by environmental influences, biological factors, or their interaction. Before puberty, the physical characteristics of boys and girls are similar, and environmental influences are more likely to explain gender differences in motor proficiency (Chui et al., 2007). On the other hand, Ulrich, (2000) states that boys are better than girls when it comes to fundamental movement skills in general, because of the fact that boys dominate in the field of object manipulation. Examining the tests from the FMS- POLYGON it is obvious that a single test assesses the object manipulation skills. So it is highly unrealistic to expect that the possible differences in a single test could affect the final FMS\_POLYGON score. This study, in combination with previous research (Haga et al., 2008) provides a support for the relationship between motor proficiency and fundamental movement skills in youth. The results of this study indicated that running speed and agility and strength are positively associated with fundamental movement skills. This mean the faster that children completed the running speed and agility task (shuttle run, one-legged side hop, two-legged side hop) and more strength they have (standing long jump, sit-ups, y-up) the better FMS\_POLYGON results they have. These results are in accordance with the previous research (Haga et al., 2008) that also provided information about positive motor abilities and fundamental movement skills correlation. This study showed that the results in the two coordination sub-tests (upper-limb coordination and bilateral coordination) are associated whit fundamental movement skills. These results are consistent with previous findings (Toit & Pienaar, 2001) that coordination constitutes primarily of fundamental movement skills. If these skills are not developed at the time that children enter school, children run the risk of later development specific learning difficulties, not only because they lack intelligence, but because the basic systems that are crucial to learning are not fully developed when these children start school. The development of these fundamental skills plays an important role in a child's school readiness, since a child's fundamental movement skills are closely related to his/her fine motor, cognitive and perceptual development (Gallahue & Ozmun, 1998). The correlation between fundamental movement skills and fine motor skills (fine motor precision, fine motor integration and manual dexterity) suggest that hand skills have are very important for mastering different movement skills. Fine motor skills involve the use of the small muscles in the fingers, hand and arm to manipulate, control and use tools and materials. This mean that fine motor abilities form are basis for many of the skills that children will develop and enhance as they move through childhood. Children with greater fundamental movement skills and motor proficiency (fine motor skills) may, therefore, have more opportunities for and choose to participate in more varied physical activities. Balance, is considered to be a basic fundamental movement skill, since all motor skills require some element of balance. Proper development of static and dynamic balance skills is thus considered as essential in the development of motor skills. Considering the results, it can be assumed that a lack of correlation between balance and fundamental movement skills occurred probably because of balance measurement fault.

This research was carried out in order to determine the correlation between motor proficiency and fundamental movement skills in 86 children from first-to-fourth-graders. It is possible to conclude that the gender differences in fine motor skills must be considered when evaluating fine motor performance in school-aged children. The establishment of gender specific normative data is worth further study. The finding from this study indicates that motor proficiency is positively associated with fundamental movement skills. Future research is needed to further examine the relationship

between motor proficiency and fundamental movement skills in children that attend different forms of organized physical activities. Longitudinal studies would provide information on the direction of this association.

## References

1. Haga, M. (2008). The relationship between physical fitness and motor competence in children. *Child: Care, Health and Development*, 34 (3), 329-334.
2. Du Toit, D. & Pienaar, A.E. (2001). Current status and assessment of quantitative and qualitative one leg balance ability in 3-6 year old children. *S.A. Journal for Research in Sport, Physical Education and Recreation*, 23(2), 51-62.
3. Gallahue, D.L., & Ozmun, J.C. (1998). *Understanding motor development: infants, children, adolescents, adults* (4<sup>th</sup> ed.). Dubuque, Iowa; McGraw-Hill.
4. Mrakovic, M., Metikos, D. and Findak, V. (1993). Theoretical model of classification of motor knowledge. *Kinesiology*, 25, 132-140.
5. Sherrill, C. (1993). *Adapted physical education, recreation and sport*. Cross disciplinary and lifespan approach. (4<sup>th</sup> ed). Dubuque IA: Wm.C.Brown.
6. Bruininks, R.H., & Bruininks, R.D. (2005). *Bruininks-Osteretsky Tests of Motor Proficiency* (2<sup>nd</sup> ed.). Circle Pines, MN: American Guidance Service.
7. Zuvella, F., Bozanic, A., Miletic, D. (2011). POLYGON - A new fundamental movement skills test for 8 year old children: Construction and validation. *Journal of Sports Science and Medicine*, 10 (1), pp. 157-163
8. Ulrich, D.A. (2000). *Test of Gross Motor Development*. 2<sup>nd</sup> edition. Pro-ed, Austin, TX.
9. Chui, M.M.Y., Ng, A.M.Y., Fong, A.K.H., Lin, L.S.Y., Ng, M.W.F. (2007). Differences in the fine motor performance of children in Hong Kong and the United States on the Bruininks-Oseretsky Test of Motor Proficiency. *Hong Kong Journal of Occupational Therapy*, 17 (1), 1-9.



## COVERT INACTIVE PARTICIPANT OBSERVATION OF SPORTS VENUE (Observation of a football match using the covert inactive participant observation method as a didactic tool)

Saša Pišot

*Science and Research Centre of Koper, University of Primorska*

*Faculty of Mathematics, Nature sciences and Information technologies, University of Primorska, Koper, Slovenia*

### Abstract

Using an effective didactic approach to help students understand social theories and their application in sports is the primary aim of the present article. Knowing that nowadays observation is the most neglected research technique in sports, we choose it to profit from its advantages. Students of the study programme of applied kinesiology at the Faculty of Mathematics, Natural Sciences and Information technologies, within the elective subject “Physical activity and the social environment” observe social behaviours and interaction of five different pairs of participants (football players, coaches, referees, spectators and support groups) at one sports venue (national league of football match) using the covert inactive observation method and participant observation forms. Based on personal experience and background theory, deeper self-reflections were made by students. In general they found the method very interesting, although it demands the observers’ full attention and they obtained new knowledge about the possible application of interactionist theory in practice.

**Key words:** *Didactic tool, participant observation form, interactionist theory, social interactions and behaviour, sport’s venue participants*

### Introduction

Making “dull” theories understandable and attractive for students and providing them an applicable value is the challenge we describe in this article. Students at the study program of applied kinesiology at the Faculty of Mathematics, Natural sciences and Information Technologies at the University of Primorska, Slovenia, within the elective subject “Physical activity and the social environment (Social issues of physical activity)” become acquainted with the basis of the sociology of sport, social theories and qualitative methodologies used in sports research.

The use of social theories can help them study sports in society and spread their competences from the field of kinesiology to applied social problems. As we examine sports and apply knowledge about sports, normally we use social and cultural theories. Theories provide us with frameworks for asking research questions, interpreting information and uncovering the deeper meaning and stories associated with sports (Coacley and Spike, 2010). With a clear understanding of theories, students can make sense of experiences and the social world.

To bring the interactionist theory closer to students, we created a special task in the student’s seminar.

Interactionist theory is often used to examine the experience of athletes, relationships between them and others and their definition of themselves, other people and the world around them. So the primary goal of interactionists is to develop in-depth understanding of social worlds from the perspectives of the people who create, change and maintain them (athletes, spectators, coaches and others involved in sports).

To apply interactionist theory to practice we created a basic research question: How do people define themselves and interact with others as sport participants in a sporting venue? The research question was also the frame of the research task in the class. For this purpose we had to choose the most appropriate form of qualitative research theories - participant observation.

Participant observation has the aim of discovering the nature of social reality by understanding the actor’s perception, understanding and interpretation of the social world. For this reason, participant observation is sometimes called a naturalistic method and tends to be associated with the interactionist or social action perspective. The methodology is normally seen as primarily interpretive.

Interactionist sociologist George Herbert Mead (Halarambos and Holbolt, 1999) has argued that empathy is a valuable human ability that the researcher should exploit. Presuming that our students have empathy (the ability to take the part of the other), we used this approach in order to understand how sports participants experience the social world. The participant observer, therefore, exploits the human ability to empathise. Because of certain obstacles of the chosen sports venue we examined (football national league mach; uniqueness of event, impossible to “get into the group”), the research technique

was based upon inactive covert observation of participants. Students as researchers followed the task's main objective: to observe and experience the world as they see it, as it responds to interactions, and the behavioural characteristics of the participants/subject they observed while retaining an observer's eye for understanding, analysis and explanation.

In accordance with interactionist theory we focused especially on interactions, meanings and social relations in sports. Sports are given meaning as people interact with one another. They give meaning to participants, others and the world around them. Those meanings are used as a basis for making decisions and taking action in their everyday life and sports (Coakley and Spike, 2010).

On the other hand we also used the positivist approach in the task of observation, with the aim of focusing on behaviour, which could be directly observed. In this process determinants who can't be indirectly observed (feelings, intentions) are not significant and could be misleading, so were exempt from observation.

The observation based positivist approach comes from beliefs that human behaviour may be explained similarly to the behaviour of things. People respond to outside initiatives, so behaviour is a reflection of their responses (Haralambos and Holborn, 1999).

## Methodology

Using the method of covert inactive observation of participants means that students participated inactively at the sport venue as observers. The venue was an official match of the Slovenian national league between the local team (team A) and the guest team (Team B). Observed participants (football players, coaches, referees and spectators and support clubs) were not informed that they were being observed by students.

Students chose between observation either of two players from each team, two referees (the central referee and linesman), and coaches of both teams and support clubs for each team.

Observation lasted from the beginning to the end of the football match. To gather as many interactions and behavioural characteristics as could be observed, students were supplied with a specific form. For this occasion and type of participant observation a special form was adapted and modified according to approaches of "Didactics analysis of the educational process" (Kramar, 1999), which describe teachers interactions and relationships to students and behavioural characteristics in the educational process. Adaptation was needed to adjust the observed variables to sports participants and the type of sporting venue.

Table 1. Form of covert inactive participant observation with 18 characteristics of interactions/behaviours

TASK 1: COVERT INACTIVE PARTICIPANT OBSERVATION Subject of observation: _____					
Frequency in observation unit: Characteristics of handling (behaviour) of observed subject:	dominant, happens often	appears, but it is not dominant	appears rarely	doesn't appear at all	it is not relevant in this situation, not necessary
1. tries to interact with other actors					
2. his behaviour is friendly					
3. his behaviour is unfriendly					
4. his behaviour is offensive (insulting to others)					
5. his behaviour is aggressive					
6. he considers other actors moods					
5. creates friendly atmosphere					
6. creates tense, atmosphere of conflict					
7. encourages others to collaborate					
8. accepts, responds to others' initiatives					
9. despises/ignores others' suggestions					
10. accepts mistakes of others with understanding					
11. acts on his own, does not pay attention to others					
12. reacts angrily to others' mistakes					
13. is intolerant of others					
14. makes fun of others' mistakes					
15. cooperates with just some actors					
16. doesn't pay attention equally to all other actors					
17. doesn't trust other actors					
18. behaves authoritatively					
Task: Make general impression and estimation of interaction of subject and others. Use covert inactive participant approach. Estimate interaction and relationship examined subjects and make comparison between first and second subject. Stress your subjective impression/reflection you've acquired with this observation task (min.200 words).					

## Results

With qualitative analysis on the basis of covert inactive observation of 5 different participants in the football match between two national league teams, A and B, (result: team A won by the score 3 to 0). Students reported the following:

*Football players:* A male student carried out an observation of two football players, both defenders: He noticed that the defender from team B was more active in encouraging others to collaborate, accepting, responding to others' initiatives and accepted others' mistakes with understanding; those characteristics were also found in the defender from team A. In general, the defender from team B interacted more with other team players than the defender from team A. Both acted in a friendly and fair way toward other participants. This observation was the student's first experience (a very positive one) of watching a football match. He also stressed that observation was interesting, but also demanded constant attention from the observer.

Another male student observed both team captains. He reported that they were encouraging to other players, stimulated them and that their leading roles were evident on the field. The team captain from team A behaved a bit aggressively and unpleasantly in response to the referees' decisions, but that was just in some specific situations. The student also noticed that both were acting very supportively, especially toward the young players and in general their interactions with all players were equal. He also noticed that in general players from team A were more motivated (home sports field and spectators) as opposed to the players from Team B, who approached the play a bit too leisurely.

*Referees:* An observation from a male student was made of the central referee and linesman. He noticed that the central referee mostly cooperated with just some actors; at some moments his behaviour was unpleasant; and he didn't pay attention equally to all other actors – though he did accept others' mistakes with understanding. The other subject, 2 the linesman, mostly ignored others' suggestions, but otherwise his behaviour was the same as that of subject 1. The student reported that both subjects acted very professionally, both used correct communication and respected each others' decisions. In accord with their roles their interactions were similar and limited to each other and involved players.

*Coaches:* A female student observed coaches of both teams. She observed that both coaches displayed pleasant, stimulating as well as unpleasant behaviour. The coach from Team B was a bit calmer than the coach from team A, but both reacted very impulsively at critical moments of the match (the coach of team A was very unfriendly to the referees...). Both were constantly encouraging others to collaborate and on the other hand their interactions were not equal with all players in the team. In general, the student saw the coaches' role as very active (they stood up all the time), stressful because of the pressure for a good result, audience pressure and self affirmation.

*Support groups:* A male student observed two support groups. The support group of team B is one of the most popular, active, support groups in Slovenian football, known for their loyalty and organisation. He noticed that the group created a very supportive atmosphere - at some moments the atmosphere was tense (when a goal was scored). They were very well organised, well equipped (drums, trumpets, transparent), cheerleading continued at all times despite the bad score (0:3). The other subject, the support group of Team A, was less active, not as well organised, less experienced, but also focused on their team's performance. Both groups shouted offensive rhymes to insult/provoke the opponent, but that is always a part of the subculture of support groups and didn't affect the general atmosphere.

*Spectators:* The observation of the spectators was made by a female student. She reported spectator-subject 1's (a middle age male) passive interaction with other spectators and also very passive behaviour at the critical moments of the match and no cheerleading or comments – he showed no feelings when his team (team A) won. Subject 2 (a young male) was a more active cheerleader who interacted a lot with his friends and others; his comments were friendly and tolerant, but his behaviour was still quite passive.

## Discussion and conclusions

The observations demonstrated to us that there were several aspects of sports participants' interactions and behavioural characteristics occurring at the same time and at a very specific place – the sports field. Being aware of shortcomings of interactionist theory and the covert inactive observation method, students obtained valuable experience involving sport participant interactions. Therefore, they were able to respond to the question we asked at the beginning: "How do people define themselves and interact with others as sports participants in a sporting venue?" Experiences of observation also helped them to understand the application of interactionist theory. This didactic task could also be adapted to the application of other theories with the parallel use of the proper research method. In the future the challenge might be the creation a similar task for students to analyse deviant interaction and behaviour in sports.

## References

1. Coakley, J., Pike, E. (2010). *Sport in Society: issues and controversies*. Boston, Mass: Irwin/McGraw Hill.
2. Haralambos, M., Holborn, M. (Makarovič, M. et.a). (1999): *Sociologija, teme in pogledi; (Sociology, Themes and Aspects)*. Ljubljana, DZS
3. Kramar, M. (1999). *Didaktična analiza izobraževalno-vzgojnega procesa (Didactic analysis of educational process)*, Ljubljana. Šola za ravnatelje.
4. Research methods: participant observation. www.sociology.org.uk.2003, retrieved in October 2010 from: <http://www.sociology.org.uk/mpoprint.pdf>.

## FUNDAMENTAL MOTOR PATTERNS IN KINDERGARTEN

Matej Plevnik

*University of Primorska, Science and Research Centre of Koper, Institute for Kinesiology Research, Koper, Slovenia*

### Abstract

During early childhood, most children spend a great deal of time in kindergartens. This period is very important for the acquisition and adoption of fundamental motor patterns (FMPs). This study was aimed at analyzing the presence of FMPs in kindergartens and their importance for children's natural and coherent motor development. The sample of subjects consisted of 168 kindergarten teachers aged between 22 and 56 years. The study suggested that the following teachers' opinions are that the FMPs of running and walking are the most important FMPs for children's motor development. They believe that these patterns are also one of the most frequent FMPs in kindergarten, while the most neglected FMPs in kindergarten are crawling and climbing.

**Key words:** *early child development, physical activity, teachers*

### Introduction

Play is an essential part of every child's life and it is vital for the enjoyment of childhood. Considerable research has been done which documents the vital role of play throughout childhood to assure optimal growth, learning and development across social, emotional, intellectual and physical domains (Stine, 1997; Isenberg & Quisenberry, 2002; Little & Wyver, 2008). During early childhood, children's play has been acknowledged as an important context to develop and demonstrate fundamental motor patterns (FMPs), motor skills and knowledge. Early childhood is an essential time for the development, acquisition and adoption of FMPs (walking, running, climbing, crawling, jumping, amongst others) which allow children to interact with and explore their environment (Hardy, et al. 2009; Pišot, et al. 2010a). Through interaction with the environment during physically active play, children gain control and ultimately mastery over their bodies with the development of a range of different motor skills (Little & Wyver, 2008). Brank, Henshall & Lewis (2008) define physically active play as any physical activity where the child is doing what they want to do for their own reasons. Parents and educators understand physically active play differently. While parents describe physically active play in terms of specific activities (such as running and climbing), educators define it in terms of types of movement (Brany, Henshall & Lewis, 2008). Opportunities for outdoor play have greatly decreased during past years. An environment that encourages so-called "street movements" has almost disappeared (Pišot, et al. 2010a). The Playday organization (2007) in the Street Play Research report describes that only 21% of children today play in the street or the area near their home every day, where as 71% of adult report that they used to play outside when they were children. Traffic, "stranger danger" and also parents' fears are considered to be the main barriers to neighbourhood play (Playday, 2007; Little & Wyver, 2008). Through the adoption of FMPs children gain their first movement experiences which play a crucial role in further physical activity levels. Booth and colleagues (1997) note that low motor skills level represent a major barrier to the participation in organized physical activity and sport. Motor competency development is a very important and continuous process where children experience periods of stagnation (Pišot & Planinšec, 2005). Movement skills that have not been mastered at an early age may remain unlearned due to the development of bad habits, self-consciousness or fear of injury (Gallahue & Ozmun, 1998). Gallahue and Ozmun further explain that a high level of differences between children are very common during early childhood, a period wherein children have their own developmental frequency determined by their "biological clocks". The fact that some authors report the low prevalence of FMPs still in primary school children and as well as later on is a cause for concern (van Beurden, Zask, Barnett & Dietrich, 2002; Hands & Martin, 2003). Early childhood is an optimal period to develop competent motor skills due to children's intrinsic playfulness and natural interest in the exploration of their environment. At that time kindergarten teachers play a vital role in a child's life. Even more so nowadays when parents tend to spend a lot of time at work, the role of the kindergarten teacher has become even more crucial. Teachers must offer a lot of different opportunities for play, especially for physically active play. They should motivate children with interesting physically active play which also includes real chances to improve motor skills and abilities through the adoption of different FMPs. The objective of this study was to ascertain what importance kindergarten teachers give to different FMPs.

## Methods

Data was obtained in the framework of the basic research project “Analysis of elementary movement patterns and adaptation of skeletal-muscle system in some of the factors of modern life style of children between 4 and 7 years of age “(J5 - 2397), funded by the Agency for Research of the Republic of Slovenia and by the University of Primorska, Science and Research Centre of Koper, Institute for Kinesiology Research, headed by Prof. Dr. Rado Pišot.

## Sample of subjects

The sample included 168 kindergarten educators, aged between 22 and 56 years (M = 41.9 years; SD = 9.28 years), who participated in the XVIII Professional Conference of Community Kindergartens of Slovenia in 2011.

## Procedure

All educators individually completed a questionnaire which contained 15 different questions mainly about FMPs in children’s play in kindergarten and their opinions about the importance of different FMPs for children’s body and motor development. Answers were ranked from marks 1 to 6, with mark 1 representing the value of highest import.

## Data analysis

The data was analyzed with the statistical program SPSS for Windows 17.0 for all variables. Descriptive statistics and ANOVA tests were used to describe the basic characteristics and differences between groups.

## Results

52.5 % of all teachers came from urban kindergartens, while 18.5% of teachers were from suburban kindergartens and 29% from country kindergartens. There was no significant statistical difference presented in the results between the teachers coming from different localities.

Teachers who participated in this study educated children from 1 to 6 years old, in addition 4.1 % of them taught 1 year old children, 19 % taught 2 years old, 24.5 % taught 3 years old, 21.8 % taught 4 years old, 23.1 % taught 5 years old and 7.5 % taught 6 years old children. There was also no significant statistical difference between the 6 groups with the only exception being in Group 1 (teachers work with 1 year old children), who placed the FMP of crawling in leading place according to the importance for motor development and the FMP of climbing before the FMP of running.

Table 1. FMP that are the most important for children’s motor development on teacher opinion \*



Table 2. The most neglected physical activities in kindergartens \*

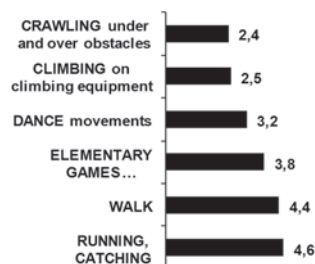

\* An answers were ranked from marks 1 to 6, with mark 1 representing the value of highest import.

The kindergarten teachers arranged the FMPs according to their importance for children’s motor development in the following order (Table 1): walking as the most important FMP, followed by running, crawling, climbing, jumping and finally least important – the FMP of throwing. Teachers who care for children at 1 year of age considered gross locomotor movements like as crawling and climbing the most important.

Table 2 shows which physical activities are the most neglected in kindergarten. Teachers noted that crawling under/over obstacles and climbing on climbing equipment are the most neglected activities, followed by dance movements, elementary games with/without ball and the FMP of walking. The FMP of running and catching seem to be the most frequent physical activity in kindergarten.

Teachers reported that 95.8 % of all kindergartens have playgrounds, 89 % have sandpits, 88 % have climbing equipment, 91 % have toboggan slides and 85 % have swings.

## Discussion and conclusion

Different parts of a child's body grow at different rates. Large-muscle development occurs earliest, so gross motor skills such as crawling, climbing, running, walking and jumping tend to appear first (Pišot, et al. 2010b). This is why providing ample opportunity for physically active play and exercise in early childhood is paramount. In our study, teachers reported that 39 % of all children's play occurred in outside playgrounds, which is encouraging information because children play outside less and less. Playgrounds and also play programs should provide children with a variety of large muscle activities so that they can have the opportunity to acquire and develop a large range of different motor skills. The teachers consider the gross locomotor skills (such as crawling and climbing) at age of 1 year for more important. This fact can lead to the belief that the role of FMPs is important just in the early phase of childhood when FMPs play a so-called "survival role". After that period, the role of gross FMPs decreases, because of many other different kinds of movements. Walking and running are considered by teachers to be two most important FMPs for children's development (Table 1). They are also the most represented FMPs in child's play (Brany, Henshall & Lewis, 2008), which is also evident from our study (Table 2). Running and chasing are, according to teacher observations, the most popular physical activities amongst children at a kindergarten level. Teachers don't consider them to be dangerous despite the fact that the most injuries in the 3 months prior to the proceeding inquiry occurred due to running and catching. They consider climbing to be the most dangerous FMP. Besides crawling, climbing is the most neglected FMP despite being considered essential for children's motor development. After running and catching, climbing is the 3rd most popular physical activity amongst children in kindergarten.

The teacher's role in kindergarten is very important and sadly often overlooked. They teach children at early childhood which is essential for the adoption and acquisition of many motor skills. They achieve this by implementing a variety of physically active games resulting in children experiencing a wide range of new motor experiences which are important for their accordant motor development.

## References

- Booth, M.L., Macaskill, P., McLellan, L., Phongsavan, P., Okely, T., et al. (1997). NSW schools fitness and physical activity survey. Sydney: NSW Department of Education and Training.
- Brany, L.M., Gibb, J., Henshall, A. & Lewis, J. (2008). Play and Exercise in Early Years: Physically active play in early childhood provision (Research report). National Children's Bureau: Department for Culture, Media and Sport.
- Gallahue, D.L., & Ozmun, J.C. (1998). Understanding motor development: Infants, children, adolescents, adults. Boston: WCB/McGraw-Hill.
- Hands, B., & Martin, M. (2003). Fundamental Movement Skills: Children's Perspectives. Australian Journal of Early Childhood, 28(4), 47-52.
- Hardy, L.L., King, L., Farrell, L., Macniven, R., & Howlett, S. (2010). Fundamental movement skills among Australian preschool children. Journal of Science and Medicine in Sport, 13(5), 503-508.
- Isenberg, J.P., & Quisenberry, N. (2002). Play: Essential for all children. Childhood Education, 79(1), 33-39.
- Little, H., & Wyver, S. (2008). Outdoor play: Does avoiding the risks reduce the benefits? Australian Journal of Early Childhood, 33(2), 33-40.
- NPFA (2000). Best Play: what play provision should do for children. London: Children's Play Council with National Playing Fields Association, PLAYLINK and DCSF.
- Pišot, R. & Planinšec, J. (2005). Struktura motorike v zgodnjem otroštvu: motorične sposobnosti v zgodnjem otroštvu v interakciji z ostalimi dimenzijami psihosomatičnega statusa otroka. Koper: Univerza na Primorskem, Znanstveno-raziskovalno središče, Inštitut za kineziološke raziskave, Založba Annales.
- Pišot, R., Šimunič, B., Šarabon, N., Cankar, G., Jelovčan, G., et al. (2010a). Motor competences for healthy and thriving children. In J. Dolinšek (ed.), *Otrok in šport, Obravnava otrok z drisko, Šokovna stanja v otroškem obdobju / XX. srečanje pediatrov in VII. Srečanje medicinskih sester v pediatriji*, 16. and 17. of April 2010, Maribor. (p. 15 - 26). Maribor: Univerzitetni klinični center.
- Pišot, R., Šimunič, B., Šarabon, N., Jelovčan, G., Plevnik, M., et al. (2010b). Fundamental motor patterns in children aged 4-7 years. In M. Kovač, G. Jurak, G. Starc, et al. (Eds.), *5<sup>th</sup> International Congress Youth Sport 2010*, Ljubljana, 2-4 December 2010 (p. 81-93). Ljubljana: University of Ljubljana, Faculty of Sport.
- Playday (2007). Our streets too! National Children's Bureau: Department for Culture, Media and Sport.
- Stine, S. (1997). Landscapes for learning. New York: John Wiley & Sons.
- van Beurden, E., Zask, A., Barnett, L.M., & Dietrich U.C. (2002). Fundamental movement skills? How do primary school children perform? The 'Move it Groove it' program in rural Australia. Journal of Science and Medicine in Sport, 5(3), 244-252.

## Acknowledgement

The author wishes to thank the Slovenian Research Agency for financing the research project "Analysis of fundamental motor pattern, skeletal and muscle adaptation on specific sedentary lifestyle factors amongst 4 to 7 year old children". Special thanks go to the lead of the Professional Kindergarten Community of Slovenia and finally to all of the teachers who participated in this study. The author would also like to thank the head of this project and co-author of this study, Prof. Rado Pišot and co-author Prof. Boštjan Šimunič for helping to realize this study.

## INFLUENCE OF MOTORIC ABILITIES ON SUCCESSFUL PERFORMAMENCE OF HANDBALL ELEMENTS IN THE TEACHINGS OF SPORT AND PHYSICAL EDUCATION

Faris Rašidagić

*Faculty of Sport and Physical Education, University of Sarajevo, Bosnia and Herzegovina*

### Abstract

Subject of this research is the teachings of sport and physical education in secondary vocational school in which the elements of handball were implemented. Sample variables of a predicator area consist of 24 motorical variables, and the sample variables of the criterion area of 3 variables/elements of handball. Aim of the research is faced in the direction of determining the effect of motoric abilities on the performance of situational motoric elements of handball, planned for the implementation in classes of sport. Verification of the effects of the predicator area, of 151 students, was carried out by the use of regression analysis, and the obtained results show that in the relations of the researched areas (motoric/situational-motoric) an appropriate and significant influence appeared.

**Key words:** *motoric abilities, situational-motoric abilities, handball, lessons of sport*

### Introduction

It has been noticed that the game of handball, compare to other sports (basketball, volleyball, soccer), needs less application of organization and implementation of teachings of sport and physical education in schools. This can be interpreted with as less socially popular in comparison to soccer, basketball, or volleyball which, therefore, projects in the teaching process. Far more often are organized, for example: inter-class and inter-school competitions with components of the above three games, rather than it is the case with organizational competitions with components of the sport and game of handball. However, the negative position of handball, in relation to other sports, in terms of motoric difficulties, is not observed, which in his research on the influence of motoric abilities on situational-motoric motion characteristics had also noted Rašidagić, F. (2010). If the facts are also enlisted that for concrete implementation of teaching components of handball, very little space and sport equipment are needed (e.g. a few handballs on an open or closed field) then it is practical to eliminate and doubts about the possibility of applying the components of this game in teaching. In this context, individual teaching components should also be observed, which Findak (2001) advocates and which should be implemented and practically begin to introduce into teaching, but in an area which is still from 1999., by Hardman K. (2008) has no significant practical progress, but is actually possible to perform by using elements of handball. The research conducted in the framework of other sports but treat motoric/situational-motorical relations show that the implementation of component of sport games in teaching can depend on the anthropological statues of students. In accordance to the aforementioned objective in this research can be set in the direction of establishing and verifying influences of motoric abilities on performing situational-motoric elements of handball, treated through components of teaching sport and physical education, where the establishment of such influences contribute to individualization of teaching components and adjusting handball for the use in teaching high school students, of coarse taking into account the results of Kovač, Lekoška and Strela (2007) research where it was confirmed that differences in morphological-motoric structures between student of different high school programs existed, relatively that students of secondary schools achieved poorer results in comparison to student of referent high schools, as well as research results of Brettschneider and Naul (2004) who found e.g. that socio-economic status of a family, educational level of parents and aspirations of the individual have a strong impact on the motorical status of adolescents, which determines the obligation for respect to social statuses before implementation of sport teaching components.

### Methods

**Sample examinees** are defined by the male population of high schools, ages of 16-18. The research included only students that were, during the testing and measuring process, completely healthy. Total number of examinees in the sample is 151 students. All examinees had appropriate conditions of regular attendance of physical and health education, which represented one of the fundamental requirements for the research. The sample cannot be elected by any criterion for admission to high school.

**Sample of predicator variables** is defined according to the following: 1. Variable for the assessment of coordination: MKTKK3 - Coordination with a bat, MKOS3M - Slalom with three medicine balls, MAGOSS - Figure eight with

bending. 2. Variable for the assessment of explosive strength: MESBML - Throwing a medicine ball out from a back laying position, MESSD - Long jump from place, MBR20M - Running 20M. 3. Variable for the assessment of speed frequency of movement: MBFTAN - Foot tapping, MBFTAZ - Foot tapping against a wall, MBFTAR - Hand tapping. 4. Variable for the assessment of repetitive strength: MRASKR - Push-ups on a loom, MRSPTL - Body lifting from a lying position, MRLDCT - Deep squats with a load. 5. Variable for the assessment of balance: MBAUIO - Standing on one foot longitudinally on a bench with open eyes, MBAUIZ - Standing on one foot transversely on a bench with closed eyes, MBAPIZ - Standing on one foot longitudinally on a bench for balance with closed eyes. 6. Variable for the assessment of precision: MPCDŠ - Aiming with a long stick, MPGVCN - Aiming at a vertical target by foot, MPGHCR - Aiming at a horizontal target by hand. 7. Variable for the assessment of flexibility: MFLISK - Flex with a bat, MFLZLG - Leg-cross from a forward lying position, MFLDPK - Deep bend on a bench. 8. Variable for the assessment of speed: MBR20MVS - Running 20M from a high start, MBR20MLS - Running 20M from a flying start, MBR50MVS - Running 50M from a high start

**Sample of criterion variables** are defined by the following: 1. Speed and preciseness of handling the ball: ORBLZ - Throwing ball against a wall. 2. Speed and coordination: ORVLS - Dribbling slalom. 3. Preciseness of shooting: ORIS - Performing a seven.

**A method of processing data** was done by the software package SPSS 12.0 for Windows. For the verification of the effects of the predictor area (multivariate level) was carried out by the use of regression analysis.

## Results

Table 1. ORBLZ - Throwing ball against a wall

Model	R	R Square	Adjusted R Square
1	.495	.245	.102

Table 2. ANOVA

Model		Sum of Squares	df	Mean Square	F	Sig.
1	Regression	905.431	24	37.726	1.707	.031
	Residual	2784.000	126	22.095		
	Total	3689.430	150			

Table 3. Koeficients

Model		Unstandardized Coefficients		Standardized Coefficients	t	Sig.
		B	Std. Error	Beta		
1	Coordination with a bat	-1.111	.441	-.251	-2.518	.013
	Foot tapping against a wall	.352	.145	.250	2.432	.016
	Deep bend on a bench	-.116	.058	-.191	-1.988	.049

Table 4. ORVLS - Dribbling slalom

Model	R	R Square	Adjusted R Square
1	.663	.439	.332

Table 5. ANOVA

Model		Sum of Squares	df	Mean Square	F	Sig.
1	Regression	53.796	24	2.242	4.111	.000
	Residual	68.693	126	.545		
	Total	122.489	150			



Table 6. Koeficients

Model		Unstandardized Coefficients		Standardized Coefficients	t	Sig.
		B	Std. Error	Beta		
1	Figure eight with bending	.121	.041	.250	2.961	.004
	Foot tapping	-.073	.035	-.203	-2.087	.039
	Hand tapping	-.055	.023	-.208	-2.335	.021
	Standing on one foot transversely on a bench with closed eyes	.124	.055	.191	2.272	.025

Table 7. ORIS - Performing a seven, ANOVA

Model		Sum of Squares	df	Mean Square	F	Sig.
1	Regression	69.105	24	2.879	1.066	.392
	Residual	340.378	126	2.701		
	Total	409.483	150			

Table 8. Handball - Latent area

Model	R	R Square	Adjusted R Square
1	.588	.346	.221

Table 9. ANOVA

Model		Sum of Squares	df	Mean Square	F	Sig.
1	Regression	51.857	24	2.161	2.774	.000
	Residual	98.143	126	.779		
	Total	150.000	150			

Table 10. Koeficijens

Model		Unstandardized Coefficients		Standardized Coefficients	t	Sig.
		B	Std. Error	Beta		
1	Figure eight with bending	-.150	.049	-.279	-3.062	.003
	Hand tapping	.061	.028	.208	2.165	.032
	Standing on one foot transversely on a bench with closed eyes	-.134	.065	-.186	-2.054	.042
	Running 20M from a high start	1.227	.597	.215	2.057	.042

## Discussion

Analyzing the results obtained by the regression analysis (Tables 1 to 3) for variable ORBLZ in the manifest area, we notice a certain influence of applied motoric variables on the success of the treated/ referred criterion variable. Correlation of the predictor with the criterion variable is  $R = .49$  and about 24% of the common variability is explained. Correlation is significant on a level of .03 (Table 2). By analysis of the impact of the motoric variables (Table 3) it can be observed that, of 24 motoric variables, only three achieve a statistically significant impact, namely: variable with the highest statistical significance of impact mktkk3- coordination with a bat (.013), followed by variable MBTAZ- foot tapping against a wall (.016) and finally variable MFLDPK- deep bend on a bench (.049). Since it is about a variable that represents areas of coordination, speed frequency and flexibility we can conclude that for the test to be performed, really good coordination, big speed, and adequate skills are needed before handling the ball (in the performed test the ball is thrown into the assigned area- square, the declined again caught, and then the task is repeated as many times possible in a limited time of 30 seconds). These results respond to the research conducted by Milanović, Vulete and Simenc (1997)

who found a hypothetical structure carrying motoric abilities of elite male and female handball players, where in that structure of coordination involves 15%, flexibility of 10% and speed of 20%.

Regression analysis of the criterion variable ORVLS (Table 4 to 6) provides information on four predictor variables that are correlated with the criterion variable. Correlation of the predictor with the criterion variable is  $R = .66$  and explains about 43% of the common variability with the criterion. The above correlation is significant at a level of .00. Analyzing the impact of motoric variables individually, an observance can be made that the largest and statistically significant impact on the criterion variable is the MAGOSS- figure eight with bending variable which represents the coordination area, then we have the influence of two variables representing one area, MBFTAN- foot tapping and MBFTAR- hand tapping, which represent the speed frequency of movement area and MBAU1Z- standing on one foot transversely on a bench with closed eyes which represents the area of balance. Summarizing the obtained relations between variables, we can conclude that for the performance of the above test, coordination and speed were necessary, which can be determined by examining the correlating variables (through speed frequency of movement during running and coordination of the evident characteristics of speed that were obtained in the examinees which is necessary or mastering the path from the start, from dribbling the ball between racks, and reaching the last rack and in the same way return to the point of departure). It can also be stated that the examinees invested maximum efforts during the testing, which is evident by the presence of variables from the balance area, where the examinees tried to maintain the way of movement and shorten the time by maintaining a balanced position by remaining as close as possible to the racks, and while trying not to lose their movement speed, not drop the ball or not to knock over the racks. These parameters correspond to the research results conducted by Pavlin, Šimenc, and Delije (1982) in which latent factors are presented which interpret situational-motoric success in the implementation of handball and where two of four factors actually do "ball handling skills" and "movement speed with a ball". Regression analysis of handball variables ORIS- performing a seven, showed that there was no impact of the predictor on the criterion set (Table 7). *apropos* multiple correlation ( $R$ ), is not on the statistically significant level of .05. It can be stated that the motoric area does not have impact on the enlisted variable of handball (manifest area) like as if this relation of the motoric area towards the situational motoric variable of handball is specific even in contradictions with for example: research results that Stijepić, Nićin and Idrizović (2007) conducted, who stated that preciseness is a significant motorical characteristic that comes to the fore in the realization of certain situational-motoric tasks. Therefore, taking into account the specificity of the test ORIS, for which the realization is necessary just preciseness of guessing, it was expected that these two motorical abilities show statistically significant impact. The cause for the lack of correlation can be defined through unadjusted/ waning situational-motorical test for the treated population which could have caused the loss of variability and reduce the links between the predictor and the criterion area. In order to determine the real facts about the importance of preciseness in the implementation of handball, it would be necessary to apply a battery of tests that would assess only this motoric ability- Pavlin, Šimenc and Delija (1982). Insight into the regression analysis of the first principle component (Table 8 to 10) in the area of handball (semi-latent area) with correlating coefficients of .58 indicate a high multiple correlation and coefficient determination .34 (or 34% of explained variability). The determined correlation is significant at a level of .00, and by analysis of individual variables (Table number 10) can be concluded that a statistically significant impact is based on a total of four motoric variables. Those four variables, according to the significance relation of the predictor-criterion system can be listed as follows: MAGOSS- figure eight with bending which represents the area of coordination and has the highest statistical correlation, subsequently MBTAR- hand tapping which represents speed frequency of movement, and two variables with the same statistical significance and correlation MBAU1Z- standing on one foot transversely on a bench with closed eyes which represents the area of speed. Based on the coefficient significance that is defined by the analysis of the above impact, we can conclude that there are influences of different motoric variables on the overall system of handball- which is represented by three treated elements, as it was primarily significant of combined areas of different motoric sub-areas in the success of handball, which is in agreement with the results of the research received by Marković (2002) on a sample of 100 handball players who found a significant correlation between basic-motoric and situational-motoric abilities in the game of handball, as well as results of Delij and Šimenc (1994) who found that an influence of situational motorical abilities subsist on the success in handball.

## Conclusion

Influence of motoric abilities (24 variables the predictor area) on the performance of situational-motoric elements of handball (3 variables of the criterion area) in the conducted research has been validated by the use of regression analysis. Sample examinees were represented by 151 examinees- students of vocational school, and the aim set assumed that an influence of motoric abilities existed in performing situational- motoric elements of handball. By the use of the regression analysis in the manifest area, an influence of variables from the motoric area on two situational-motoric variables has been proved statistically, *apropos* on (ORBLZ) throwing a ball against the wall and (ORVLS) - dribbling with a ball slalom, while the third variable (ORIS) - performing a seven, this effect has not been confirmed. By the use of regression analysis in the semi-latent area which is represented by the performance of a common factor, i.e. forming the first principle component of three previously enlisted elements of handball, it was statistically confirmed (level of significance from .00) that the influence of motoric variables on the success of handball exists in this area as well. Motoric variables that

dominate the realization of impact in the manifest and semi-latent area belong to the areas of speed frequency of movement and coordination, which in conclusion implies that examinees/students with a higher level of these motoric abilities have more success in implementation of lessons that contain elements of handball. Research has confirmed that performance quality of situational-motoric tasks increases as the level of possession of motoric abilities is larger, thus proving the set aim of the research. In conclusion, it is also important to state that the tests used to represent the game of handball are dynamic, and that there is a relatively small number of motoric variables (predicator area) that achieved a statistically significant correlation with the criterion variable.

## References

1. Brettschneider, S., Naul, S. (2004). *Influence of social status to the level of motor readiness secondary student population*. Kineziology 1/2004, (pp 23-34). Zagreb.
2. Delija, K. and Šimenc, Z. (1994). *The impact of the general situational motor skills and knowledge for success in handball*. Kineziology 26, 1-2, (pp 51-54). Zagreb.
3. Findak, V. (2001). *Methodology of physical education*. School book. Zagreb.
4. Hardman, K. (2008). *Physical education in schools: A global view of the state*. Kineziology 1/2008, (pp 5-28). Zagreb.
5. Kovač, M., Leskošek, B., Strel, J. (2007). *Komparason of morphological characteristics and motor abilities of boys of secondary school students of different programs*. Kineziology 1/2007, (pp 62-73). Zagreb.
6. Marković, S. (2002). *Relationships between motor skills and situational – motoric abilities of the players the federal level*. Fis Comunciations , IX International Conference, (pp 71-72). Niš.
7. Milanović, D., Vuleta, D. and Šimenc Z. (1997). *Diagnosis and analysis of conditional readiness of top male and female handball*. Proceedings 6<sup>th</sup> Internatonal Scientific Sports Symposium in Zagreb, (pp 116-125). Zagreb.
8. Pavlin, K., Šimenc, Z. and Delija, K. (1982). *Reliability analysis of the factor validity of situational-motor tests in handball*. Kinezology 14/5, (pp 177-186). Zagreb.
9. Rašidagić, F., Fazlagić, S. (2010). *Relationship between morphological characteristics and motorical abilities by the performance of situational motoric elements of basketball, volleybal, and handball in the lessons of sport and physical education*. Homo sporticus 1/2010, (pp 61-66). Sarajevo.
10. Stijepić, R., Nićin, Đ. and Idrizović, K. (2007). *Sensitive periods of preciseness with female students*. Proceedings of II International Symposium of New Technologies in Sports, (pp 47-54). Sarajevo.

## EFFECT OF NEW TECHNOLOGIES ON THE ABILITY TO ANALYZE SITUATIONS SPORTS IN UNIVERSITY STUDENTS

**Javier Sampedro, Jorge Lorenzo and Jesus Rivilla**

*Faculty of Physical Activity and Sport Sciences - INEF / Polytechnic University of Madrid, Spain*

### Abstract

#### Purpose

This study examined the effect of the use of ITCs in the ability of perception and analysis competitive situations by university students of basketball, handball and athletics.

#### Methods

Fifty-six students from the Faculty of Physical Activity and Sport (U.P.M.) belonging to High Performance Sports course formed the sample. We carried out an analysis of the evolution of perception and analysis of three groups of students highly educated in sports: athletics (G1, n = 17), handball (G2, n = 21) and basketball (G3, n = 18). All of them learned with a teaching methodology common with frequent and active use of ICTs where classes are taught using media. Students have access to content through a virtual platform and had to do homework and weekly assignments related to new technologies.

The three groups were evaluated at the beginning (T1) and end (T2) of the course, following the methodological process by a specific audiovisual test for each subject. The tests measured the ability of perception and analysis of the students.

#### Results

The results confirmed a significant improvement during the course (T1-T2 = -2.27,  $p < 0.01$ ,  $df = 17$ ,  $t = -7.087$ ) in the three groups. Students in team sports improved greater than athletics. In handball the greatest differences were observed (T1-T2 =  $-4.43 \pm 1.88$ ,  $P < 0.01$ ,  $df = 20$ ,  $t = -10.76$ ) between the average initial test ( $3.05 \pm 1.49$ ) and final test ( $7.47 \pm 1.57$ ). In basketball, the final average ( $7.05 \pm 1.12$ ) was similar to the previous one but the fact that the average initial test ( $4.77 \pm 1.04$ ) was higher means that the differences were lower (T1 -T2 =  $-2.27 \pm 1.36$ ,  $p < 0.01$ ,  $df = 17$ ,  $t = -7.087$ ). While in athletics, the average initial test ( $4.74 \pm 1.71$ ) and final test ( $6.17 \pm 1.95$ ) was lower but the differences were equally significant (T1-T2 =  $-1.44 \pm 0.84$ ,  $p < 0.01$ ,  $df = 16$ ,  $t = -11.973$ ).

#### Conclusions

It could be argued that the frequent and active use of new technologies has a positive impact on improving the ability to appreciate and analysis of sports.

**Key words:** *perception, ICT, sports situations, sports science, education, athletics, handball, basketball, undergraduates*

### Introduction

At present, the use of Technologies of the Information and the Communication (ICTs) in order to optimize the learning in different areas begins to be very frequent. The benefits of the application of the ICT's in the education are multiple: facility of access, flexibility, the pedagogy centred on the pupil and the best opportunities of collaboration. For all this, his integration in the systems of education and formation, specially in the top education, constitutes one of the principal worries of the EU [1-2].

Up to the moment, the majority of the models, systems and plans of evaluation of the usefulness of the use of the ICTs in the classrooms centre only on the utilization of the technological elements and not on his pedagogic integration or in the value that these have inside the program of formation [3].

Though every time there is more frequent the utilization of this type of means in the education in the university, as way to increase the motivation of the student [4], we have detected that exist very few investigations that demonstrate his efficiency and none in reference to the university centers of our speciality: Faculties of the Physical Activity and of the Sport. In our opinion, the use of audio-visual means might favor the learning of different contents of education of the Sports.

In the present document, one gives continuation to a study realized across a project of Educational Innovation (“Design and applications of new methodologies: production of materials of support to the teaching of the team sports”), financed with a help granted by the UPM during the courses 2006/07, 2007/08, 2008/09 and 2009/10, and it uses on behalf of those of the audio-visual materials elaborated in the above mentioned projects

Educational Innovation Group: Sports Collectives FCCAFyD-INEF has conducted research, developed with the help of the Polytechnic University of Madrid, whose main purpose is to analyze the utility of new technologies to improve teaching - learning in the subjects concerning the application of sports in the Faculty of Physical Activity and Sport (INEF-Madrid). The aim, therefore, to evaluate the effect of the application of the Technologies of Information and Communication (ICTs) in the education of the sports, particularly in the Handball, Basketball and Athletics.

## Materialy method

### Participants

The sample was composed by 56 pupils, divided in three groups: (i) Group “Athletics” (n=17), the (ii)nd Group “Handball” (n=21) and the (iii)rd Group “Basketball” (n=18). These groups concerned to the subject “Sport of High Performance”, of 8 credits, which is dealt in the second cycle of the Master in Sciences of the Physical Activity and of the Sport in the Faculty of Sciences of the Physical Activity and of the Sport (INEF) of the Technical University of Madrid.

### Material

For the initial evaluation (Initial Test) and end (Final Test) of three groups, the only questionnaire was in use. The pupils had to observe several sequences of video and images and categorize them correctly from the technical - tactical and regulation point of view, determining the consequence of the observed action.

For the development of the classes there was in use frequently a projector connected to a portable computer of great memory for the storage of the contents multimedia. Equally, the pupils had a portable computer for the accomplishment of the works related to the new technologies. One possessed five portable ones for his lending.

For the categorization, selection and analysis of the sequences of video there was in use a program of edition of specific video (Skaut Systems).

### Procedure

On having begun the semester of class and on having finished the same one, there was evaluated the level of perceptive capacity and of analysis of each one of three groups. Along the semester, three groups followed similar methodologies of education with regard to the utilization of the TIC's, based on a high use of the same ones and in his practical application.

The theoretical classes included the use of audio-visual means to the beginning and at the end of the same ones. The developed contents were the own ones of every subject, being in use the TIC's and the contents multimedia in all the theoretical presentations. Above mentioned material multimedia was also of free access in the virtual institutional platform of the UPM. When existed great quantity of material available multimedia for the pupils, a major effort was necessary for the diffusion and exchange of information. The practical classes realized with a brief theoretical introduction that it was including photos and you sequence multimedia explanatory. At the end of the practical meetings one was thinking about the same ones, with a new support of material multimedia.

The structure of the meetings was very similar in three workgroups.

Additional, the pupils realized works and complementary tasks related to the new technologies. These are some examples:

- Work of analysis and selection of images and sequences of video extracted from royal competitions, cataloguing them adequately from the regulation and technical point of view - tactically.
- Accomplishment of video - assembly of actions realized by the own pupils.

### Statistical analysis

The obtained information was analyzed by means of the statistical package SPSS 15.0 for Windows. The calculation of the averages and diversions standard was realized by means of statistical methods standard. To analyze the differences between groups from the initial test and the final test in each of the groups applied to itself the T test for related samples.

## Results and discussion

The results obtained in both test are presented in the table 1. First, different initial punctuations were observed in three groups. Nevertheless the differences in the initial evaluation between groups were not significant. Equally, a significant improvement was observed in the results of three analyzed groups, being minor the improvement in the group of the individual sport “athletics”.

Table 1.-Results of the initial and final evaluaciones and his differences (DT Happens  $\pm$ )

\*\* It shows significant differences  $p < 0.01$

	PERCEPTIVE CAPACITY AND ANALYSIS (PA)		
	Initial Test (Media $\pm$ DT)	Final Test (Media $\pm$ DT)	Diference(Media $\pm$ DT)
ATHLETICS GROUP	4.74 $\pm$ 1.71	6.17 $\pm$ 1.95	1.44 $\pm$ 0.84**
BASKETBALL GROUP	4.77 $\pm$ 1.04	7.05 $\pm$ 1.12	2.27 $\pm$ 1,36**
HANDBALL GROUP	3.05 $\pm$ 1.49	7.47 $\pm$ 1.58	4.43 $\pm$ 1.88**

Initially, the application of Anova’s test, it determined that in the initial test significant differences between the groups did not exist. Which might be significant of a similar level of item in three analyzed groups. And, of equal way, the differences in the final test, were not also significant, which might mean that the improvement is not so much due to the different teachers but to the used methodology.

This affirmation is checked on having analyzed the differences between the initial and final punctuation in every group. The application of the test T de Student for related samples confirmed significant differences in all the groups ( $p < 0,01$ ) though of different magnitude. The opposing differences were top in the group handball that in basketball, being minor in athletics.

These results allow to affirm that the use of the new technologies this one directly related to the efficiency in the learning process, concretely of the capacity of analysis and perception of the game in Athletics, Basketball and Handball in the Faculty of Sciences of the Physical Activity and of the Sport (INEF) of the Technical University of Madrid.

In future studies, we try to research in different sports and with different contents (technical, tactical and strategics), to verify if these results are applicable to other sports disciplines and in different levels of learning (monitors, trainers, pupils of secondary and primary, sportsman of the studied speciality of different levels of practice and age, etc).

These results are opposed to a previous study not published, realized by our group, in which one was concluding that an active and very frequent use of the ICT’s was not improving the results with regard to the pupils who were using it in a passive way (by means of the observation of the contents showed by the teacher), and that the high use of the technology in the classes was generating a negative vision of the subject, owed probably to the substantial increase in the hours dedicated on the part of the pupil to the subject, on the basis of the major request of works to fulfill the minimal requirements of the subject.

## Conclusions

In the light of the results obtained in three evaluated groups, it is possible to conclude that the use of the new technologies reverberates of direct form in the improvement of the perceptive capacity and of analysis of the student body to university level in Athletics, Basketball and Handball. Equally, the frequent and active utilization of the ICT’s seems to relate to the optimization of the learning of the contents of the sports, logical question to tenor of which without utilization of audio-visual means (traditional methodologies) or similar means difficultly it will be possible improve significantly in capacities of perception and analysis of the same one.

Consistently, the values obtained in the improvement of the learning allow to affirm that the use of the new technologies can be directly related to the efficiency in the learning process of the sports in pupils of the Faculty of Sciences of the Physical Activity and of the Sport (INEF) of the Technical University of Madrid.

An active use of the TIC’s carries to optimize the results. This can be a consequence of to the substantial increase in the hours dedicated on the part of the pupil to the subject, due to the major request of works to fulfill the minimal requirements of the same one.

## Practical reflections

The present study is born of the belief of the importance of using the new technologies in the optimization of the process of education - learning of the sports in the different levels. In the light of the contributed information, the above mentioned affirmation seems to be ratified, nevertheless, it would be opportune to penetrate into this question since there are very small the studies that confirm these question. It would be necessary to determine which is the most suitable degree of utilization of new technologies and which are the most effective traditional means and that should not be rejected in the education of the sports.

On the other hand, one of the most relevant capacities in the sports area is to perceive correctly the situations of competition - training and, later, to take decisions adapted from the above mentioned perception. Bearing in mind that one the fundamental aims in subjects of the different sports is to acquire these capacities related to the perception and capture of decision, it seems to be opportune to look for the means of learning most adapted for the above mentioned acquisition. Of between all, it seems to be coherent to think about a high usefulness of the TIC's for the achievement of perceptive significant learnings. In this line it seems to be important to question in what measure the perceptive capacities are relevant and of analysis of royal actions of the game in the education of the sports to professional futures of the same one.

It thinks that the frequent use of new technologies increases the motivation and satisfaction of the pupil with the subject really is it like that?, the utilization of the TIC's do they increase in a significant way the motivation of the student body? And, in case this way it is, might improvements in the education owe to this bonus of motivation?

We wonder also if there will depend the usefulness of the TIC's of the matter or content that is wanted to give?, or what is the same thing, are TIC's equally useful in the different sports and matters related to the sports area?

The exposed study centres his attention on the education of the sports. Habitually this education has centred on the acquisition of knowledge as well as of skills of the sport, having in it counts the possible professional labor that the pupil will have to recover as trainer and / or teacher, should this perspective be extended towards the perceptive capacities, of analysis and capture of decision in the game or session of training? Are not they these equal or more relevant than capacities previously treated?

Finally, which are the most important capacities that might be promoted thanks to TIC's's habitual use in the education? It is necessary to suppose that the capacities related to the perception and audio-visual analysis need of the TIC's for his utilization, nevertheless, would it be equally productive in other capacities?

## References

1. Company of the Information in Europe. Education and formation for the company of the knowledge. Obtained in February, 2009 in [http:// ec.europa.eu/information\\_society/edutra/index\\_es.htm](http://ec.europa.eu/information_society/edutra/index_es.htm)
2. Technology-enhanced Learning. Obtained in February, 2009 in [http:// cordis.europa.eu/ist/telearn/index.html](http://cordis.europa.eu/ist/telearn/index.html)
3. Ramos Santana, G. (2004). Elements for the design of plans of evaluation of programs of teleformación in the company. Faculty of Philosophy. University of Valencia, Valencia.
4. Mulberry trees, J.M., Thumb, J. and Tardáguila, P. (1996). The technologies of the information and of the communication in the educational Spanish system, in F.J. Weaver and To. García Valcárcel (Eds). Perspectives of the new technologies in the education. Publishing house Narcea, Madrid.

## LEVELS AND STRUCTURES OF SPEED AND STRENGTH QUALITIES OF BOYS OF DIFFERENT MAXIMUM RUNNING SPEED LEVELS

Nusret Smajlović<sup>1</sup> and Slavenko Likić<sup>2</sup>

<sup>1</sup>Faculty of Sport and PE, Sarajevo, Bosnia and Herzegovina

<sup>2</sup>Teacher Faculty, Department of Sport and Health, Mostar, Bosnia and Herzegovina

### Abstract

The paper investigates levels and structures of speed-strength qualities of boys who achieved different levels of maximum running speed. After the classification of boys into the quality groups according to the achieved levels of maximum running speed, MANOVA in the space of speed-strength qualities was used to obtain an overview of the levels of mean values of different quality groups. Univariate F tests confirmed that all variables had maximal statistical significance for the classification of boys into the groups formed according to the level of the achieved maximum running speed. The graph created on the basis of Probit Z5 values reflects levels and structures of speed-strength qualities of the group of boys with different values of maximum running speed. The results can be used as a partial contribution to the model creation applicable to the selection of boys talented for sprinting.

**Key words:** athletics, maximum running speed, speed-strength abilities

### Introduction

All sports careers begin with the processes of selection and direction of talented children into a particular sport. These processes can be performed in many ways – from a spontaneous individual decision-making to engage in a certain sport to the application of scientific methods and procedures by means of which responsible sport-specific performance factors can be detected. Children's potential for a particular sport cannot precisely and safely be assessed if a child has not been subjected to an appropriate set of tests. Gihta (1994) indicates testing and selection of children for a particular sport should be a continuous process if the most talented athletes are to be found. It is implied, of course, that the selection is a dynamic and managed process, aimed at choosing individuals with sport-specific optimal morphological, psychological and physical features relevant to high performance and sports achievements in a particular sport or sports event (Sozanski, 1981). However, whether a child will be successful in athletics in general and in sprinting events in particular depends on numerous factors. Sprinting performance is based upon maximum speed realization in the shortest time possible and upon its maintenance as long as possible (Babić, 2005). Also, the level of maximum running speed is a crucial factor in sprinting potential. The ability to reach the maximum running speed fast and its sustainability demand a high level of starting reaction and action, agility in the period of acceleration, then optimal stride rate and stride length, optimal kinematic and kinetic running parameters and the expressed high achievement drive. Numerous researchers addressed this issue partially by investigating the hereditary nature of motor abilities; kinematic, by conducting kinetic and electromyographic analyses of sprinting; by detecting morphological characteristics and motor abilities relevant to sprinting performance (Wolanski, 1981; Gaisl, 1981; Mero & Komi, 1989; Chengzhi, 1991; Mero, Komi, & Gregor, 1992; Donati, 1995; Brüggemann, Koszevski, & Müller, 1997; Müller & Hommel, 1997; Tomažin, 1999; Čoh, 2001; Čoh, Milanović, & Kampmiller, 2001; Čoh, Mihajlović, & Praprotnik, 2001; Babić, 2005). From the aspect of modelling the talented sprinters identification system it is also important to verify whether children have certain speed-strength qualities relevant to the prediction of maximum speed performance as a crucial precondition of sprinting performance and sports achievements. Hence, the issue addressed in the current paper is the determination and comparative analysis of levels and structures of speed-strength qualities of boys who achieved different levels of maximum running speed. Our assumption is that it is possible in practice, on the basis of information about the levels of speed-strength qualities, to conduct the process of identification and orientation of boys talented for sprinting events. The results of the present study may be a partial contribution to the creation of field tests battery that can be used during regular anthropological measurements in the educational systems.

### Methods

The sample of 81 boys, 10-12 years of age, was divided into three groups according to the level of their maximum running speed. Maximum running speed was measured by the electronic ERGO TESTER-Bosco instruments and the supporting software "Sprint". Classification of subjects into the groups was realized on the basis of the maximum speed results distribution curve. In the space of  $\pm 1$  standard deviation (SD) there were 68.26% subjects belonging to the group



of subjects with the average maximum running speed (n=55). The subjects classified above +1 SD pertain to the group of the above average maximum speed performance (n=12), whereas the subjects classified below -1 SD belong to the group of the below average maximum speed performance (n=14).

The overview of mean values of different quality groups of subjects, classified according to the level of maximum running speed performance, was obtained with multivariate analysis of variance (MANOVA) in the space of their speed-strength qualities. Speed-strength qualities were represented by the following 12 variables: standing long jump (SLJ); Abalakov's test (ABALAK); counter movement jump (CMJ); counter movement jump with free hands (CMJH); right leg jumps over 20m – time (TJ2OR); right leg jumps over 20m – number (NJ2OR); left leg jumps over 20m – time (TJ2OL); left leg jumps over 20m – number (NJ2OL); foot tapping (FTAP); hand tapping (HTAP); standing ball (1kg) throw overhead backwards (STBB); laying ball (1kg) throw overhead forwards (LTBF).

Univariate F tests were used to determine individual statistical significance of the variables of speed-strength qualities for the classification of the subjects into groups of different levels of maximum running speed. On the basis of Probit Z5 values (standardized Z values of the results with the mean value of 5 and SD of 1) a graph was created which presents levels and structures of speed-strength qualities of boys who achieved different levels of maximum running speed.

## Results

MANOVA of speed-strength qualities' variables resulted in an overview of mean values of different quality groups (Table 1) formed according to maximum running speed performance.

Table 1. Mean values of the variables of speed-strength qualities of the groups formed according to the levels of maximum running speed (VMAX) (Group 1 – above average subjects, Group 2 – average subjects, Group 3 – below average subjects)

Variable	Standing long jump (SLJ)		Abalakov's test (ABALAK)		Counter movement jump (CMJ)	
Group	AM	SD	AM	SD	AM	SD
1.VMAX=6.66	165,35	14,113	31,78	3,068	22,54	4,641
2.VMAX=6.01	144,83	15,258	27,14	4,335	20,24	3,764
3.VMAX=5.37	125,66	18,456	21,66	4,334	15,01	1,710
Sample =6.03	145,54	19,096	27,13	5,007	19,87	4,284
Variable	Counter movement jump with free hands (CMJH)		Right leg jumps over 20 m – time (TJ2OR)		Right leg jumps over 20 m – number (NJ2OR)	
Group	AM	SD	AM	SD	AM	SD
1.VMAX=6.66	27,07	3,995	9,43	,980	22,03	3,261
2.VMAX=6.01	24,15	4,013	12,05	2,192	28,18	4,530
3.VMAX=5.37	17,81	2,067	16,38	4,156	37,66	8,370
Sample =6.03	23,72	4,624	12,24	3,122	28,52	6,723
Variable	Left leg jumps over 20 m – time (TJ2OL)		Left leg jumps over 20 m – number (NJ2OL)		Foot Tapping (LTAP)	
Group	AM	SD	AM	SD	AM	SD
1.VMAX=6.66	9,77	1,732	23,21	5,309	20,50	1,286
2.VMAX=6.01	12,18	2,025	28,36	4,979	18,30	1,676
3.VMAX=5.37	15,91	3,499	35,83	7,133	17,33	1,969
Sample =6.03	12,32	2,831	28,58	6,424	18,54	1,904
Variable	Hand tapping (HTAP)		Standing ball throw overhead backwards (STBB)		Laying ball throw overhead forwards (LTBF)	
Group	AM	SD	AM	SD	AM	SD
1.VMAX=6.66	27,78	2,225	5,64	1,068	8,11	1,510
2.VMAX=6.01	25,34	2,612	4,86	,923	6,86	1,162
3.VMAX=5.37	25,41	2,999	4,53	,634	6,02	,993
Sample =6.03	25,77	2,739	4,95	,965	6,99	1,338

All the multivariate tests applied (Pillais, Hotelling's, Wilk's, Roy's) gave the highest statistical significance ( $F=.000$ ) of the differences between the groups formed according to the levels of maximum speed (Table 2).

Table 2. Multivariate tests of significance aimed at classifying the subjects into quality groups by the level of maximum speed realized in the space of speed-strength features

Multivariate Tests of Significance					
Test name	Value	Approx. F	Hypoth. DF	Error DF	Sig. Of F
Pillais	.779	3.615	24.00	136.00	.000
Hotelling's	1.823	5.015	24.00	132.00	.000
Wilk's	.319	4.297	24.00	134.00	.000
Roy's	.620				

Univariate F tests were used to determine individual statistical significance of the variables of speed-strength qualities used to classify subjects into the groups of different levels of maximum speed (Table 3).

Table 3. Univariate F tests of statistical significance of the space of speed-strength features' variables for the classification of the subjects with different levels of maximum running speed into groups

Univariate F – tests with (2.78) D.F.						
Variable	Hypoth. SS	Error SS	Hypoth. MS	Error MS	F	Sig. of F
SLJ	10264.690	18907.408	5132.345	242.402	21.172	.000
ABALAK	661.646	1343.860	330.823	17.228	19.201	.000
CMJ	390.580	1077.308	195.290	13.811	14.139	.000
CMJH	586.000	1124.279	293.000	14.413	20.327	.000
TJ20R	317.931	462.043	158.965	5.923	26.835	.000
NJ20R	1598.869	2017.080	799.434	25.860	30.913	.000
TJ20L	246.260	395.046	123.130	5.064	24.311	.000
NJ20L	1036.977	2264.751	518.488	29.035	17.857	.000
LTAP	74.186	215.912	37.093	2.768	13.400	.000
HTAP	68.289	531.710	34.144	6.816	5.008	.009
STBB	9.250	65.264	4.625	.836	5.528	.006
LTBF	29.871	113.446	14.935	1.454	10.269	.000

In order to obtain clearer picture of the differences in the space of speed-strength qualities among the groups of subjects with different levels of maximum running speed (VMAX) values of the variables were transformed into the mean Probit Z5 values. Table 4 shows mean Probit Z5 values in the space of speed-strength qualities of the subjects pertaining to different quality groups formed according to maximum running speed performance (VMAX).

Table 4. Mean Probit-Z5 values of the variables of speed-strength qualities across the groups formed according to the levels of maximum running speed

Quality group	VMAX	SLJ	ABAL	CMJ	CMJH	TJ20R	NJ20R	TJ20L	NJ20L	LTAP	HTAP	STBB	LTBF
Above average	6.47	6.03	5.92	5.62	5.72	4.10	4.03	4.10	4.16	6.02	5.73	5.72	5.86
Average	4.95	4.96	5.00	5.08	5.09	4.93	4.94	4.95	4.96	4.87	4.84	4.91	4.93
Below average	3.47	3.95	3.90	3.86	3.72	6.32	6.36	6.26	6.12	4.36	4.86	4.57	4.30

In the Graph 1 levels and structures are presented of the variables of speed-strength qualities across the groups formed by the levels of maximum running speed performance. The levels are presented by means of the Probit-Z5 values.

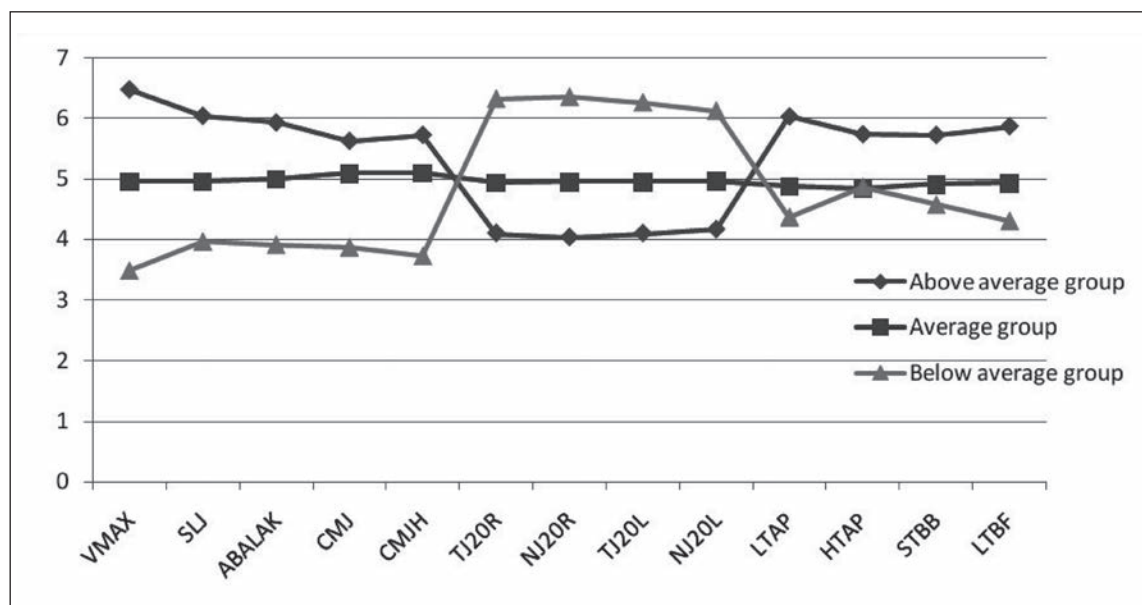

Graph 1. Levels and structures of mean Probit-Z5 values of the variables of speed-strength qualities across the groups formed by the levels of maximum running speed performance.

## Discussion

The analysis of means of speed-strength qualities' variables (Table 1) revealed that the group of subjects with the above average level of maximum running speed performance (Group 1 n=14) demonstrated markedly better means of speed-strength qualities than the average group (Group 2 n=55) and below average group (Group 3 n=12) of subjects from the analysed sample of boys, 10-12 years of age.

All the horizontal and vertical jumping ability tests indicated significant differences in quality between the groups formed according to the levels of the achieved maximum speed. The above average group had better mean values in *standing long jump* by 21.5 cm and 41.7 cm than the average and below average group, respectively. Significant differences between the groups were also obtained in all the variables assessing vertical jumping ability by the Abalakov's test – the above average group had a higher *jump-and-reach* score by 5.4 cm and 10.9 cm than the average and below average group, respectively. The same nature of significant differences is also noticeable in other two variables assessing vertical jumping ability (CMJ and CMJH), especially between the above and below average groups of subjects.

Considerable differences are also noticeable in all the variables of continuous jumping ability (right/left leg) between the three groups both in time and number of jumps needed to cover the distance of 20 m (TJ20L, TJ20R, NJ20L, NJ20R). The boys in the above average group needed a shorter time to jump over the distance of 20 m than their peers in the average and below average group, meaning that they have a higher level of power. The boys with the highest maximum speed needed a fewer number of jumps to cover the distance of 20 m than the subjects in the average and below average group, meaning that they have a higher level of power.

In the variables measuring speed of neuro-muscular excitation (*hand tapping* and *foot tapping*) higher mean values of the above average group are noticeable, whereas the mean values of the average and below average group were almost on the same level. In the variables assessing arm strength (STBB and LTBF) the higher differences were obtained between the groups in the test *laying ball throw overhead - forwards* (LTBF); the above average group achieved mean value of 8.11m, which is by 1.3m and 2.2 m better mean value than the mean values of the average and below average group, respectively. In the variable *standing ball throw overhead backwards* (STBB) the differences between mean differences were considerably lower.

The higher level of speed-strength qualities has a positive influence on the level of maximum running speed achieved. The boys who had a greater speed-strength potential of the horizontal and vertical jumping type, a greater power of the continuous jumping type, a hereditary high speed of neuro-muscular excitation and a greater speed-strength potential of arms achieved higher level of maximum running speed than the peers whose qualities were on the lower levels. Consequently, the former had a bigger speed potential in sprinting than the latter.

It was confirmed by the multivariate tests (Pillais, Hotelling's, Wilk's, Roy's) which showed the highest statistical significant difference between the groups formed according to the levels of maximum running speed achieved (Table 2).

Contribution evaluation (Table 3) revealed that all variables from the space of speed-strength qualities had the highest or pronounced statistical significance for the classification of the subjects into different quality groups according to various levels of maximum running speed achieved (from  $F=0.000$  to  $F=0.009$ ).

In Graph 1, created on the basis of Probit Z5 values of the variables of speed-strength qualities, the differences among the groups formed upon the criterion of maximum running speed performance are obvious with the above average group being considerably better than the other two groups of subjects.

The biggest differences are noticeable in the variables of horizontal and vertical jumping ability, whereas somewhat smaller differences are evident in the variables assessing neuro-muscular excitation (LTAPN and HTAP) and explosive strength of arms (STBB and LTBF).

The lower values in the tests of continuous jumping, expressed both in time and number of jumps needed for covering the distance of 20 m (TJ20R, TJ20L, NJ20R and NJ20L), are the reversely scaled variables and represent the better quality of take-off power.

## Conclusions

Among the groups of boys, 10-12 years of age, formed according to the levels of maximum running speed, the statistically significant differences were found in values of all 12 variables of speed-strength qualities.

The boys with a greater speed-strength potential of the horizontal and vertical jumping type, of the continuous jumping type with hereditary high speed of neuro-muscular excitation and a greater speed-strength potential of arms achieve a higher level of maximum running speed than their peers whose qualities are on the lower levels. Due to its potential to differentiate clearly boys with the considerably high level of maximum running speed from their slower peers, the applied set of variables assessing speed-strength qualities can be used as a partial contribution to the model applicable to the selection of boys talented for sprinting. However, the exclusive application of tests assessing speed-strength qualities has its limitations. The selection model for children talented for sprinting events must also include morphological and physiological characteristics, energy supply capacities and biomechanically optimal movement technique.

## References

1. Babić, V. (2001). Utjecaj motoričkih sposobnosti i morfoloških obilježja na sprintersko trčanje. (Doktorska disertacija). Kineziološki fakultet sveučilišta u Zagrebu.
2. Cissik, J.M. (2002). Technique and speed development for running. *NSCA's Performance Training Journal*, 1 (8), 18-21.
3. Čoh, M., D. Milanović, & T. Kampmiller (2001). Morphological and kinematic characteristics of elite sprinters. *Collegium Antropologicum*, 25, 605-610.
4. Čoh, M., M. Bračić, & N. Smajlović (2010). Methodical aspects of maximum speed development. *Sport Science*, 3(2), 11-14.
5. Gambetta, V. (1991). Essential considerations for the development of a teaching model for the 100 meters sprint. *New Studies in Athletics*, 6 (2), 27-32.

## COMPARISON BETWEEN ELEMENTARY SCHOOL TEACHER AND PHYSICAL EDUCATION TEACHER FROM SLOVENIA, CROATIA AND SLOVAKIA IN SOME OF THE HEALTH DIMENSIONS

Vesna Štemberger<sup>1</sup>, Damir Knjaz<sup>2</sup> and Ljubor Tomanek<sup>3</sup>

<sup>1</sup>Faculty of Education, Ljubljana, Slovenia

<sup>2</sup>Faculty of Kinesiology, University of Zagreb, Croatia

<sup>3</sup>Faculty of Physical Education and Sport, Comenius University in Bratislava, Slovakia

### Abstract

Healthy teacher is one of the most important parts of educational process. Different researches have shown that disease of vocal organ and hearing loss are two of the most common diseases among teachers. In article we present results of research where 476 teachers (from Slovenia, Croatia, and Slovakia) were involved. Results showed up that the most frequent diseases among teachers from the sample are: high blood pressure, allergies, diseases and malfunctions of joints and spine and only by physical education teachers hearing loss. Some statistically significant differences were found out between elementary school teachers and physical education teachers. Elementary school teachers suffer from asthma more than physical education teachers, while on the other hand physical education teachers has diabetes and diseases and malfunctions of joints

**Key words:** *teacher's health, occupational diseases, diseases and malfunctions of joints*

### Introduction

Health is the general condition of a person in all aspects. It is not just absence of disease or infirmity but it is also a state of complete physical, mental and social well-being (WHO, 2006). If we want teachers will do their job (teaching) as good as they can (and we expected) it is of great importance for teachers to be and stay healthy. Data of workers health (sick leaves, occupational diseases, injuries) has been collecting in Slovenia for the last 15 years (Zdravi na delovnem mestu, <http://www.cilizadelo.si/default-20100.html>) but there are no special data only for teachers and their diseases even though we should collect them (Pravilnik o seznamu poklicnih bolezni, 2003). The very same picture we can find out in Croatia, even though Dečkovič-Vukreš (2006, in Kofol Bric, 2007) classified 4 cases (4.3%) of diseases of vocal organ among teachers. Since there are no data only for elementary school teachers (ES teacher) or physical education teachers (PE teacher) it is not possible to know which profile of teachers had that kind of problems.

Some researches were done abroad that found out some of the most frequent occupational diseases of teachers so we can assume that Slovenian, Croatian and Slovakian teachers might have the same health related problems.

Some of the most frequent occupational diseases of teachers:

- Diseases of vocal organ due to excessive voice effort: For teachers, voice disorder risk is five times bigger than for other "voice-working" professionals like lawyers, priests or singers. Phoniatrists point out the main risk factors, such as noise and low speech intelligibility in most classrooms force teachers to speak too loud, too dry and dusty air in the classroom, stress, lack of voice emission training, smoking, lack of fluid (water, tea) during the day. Teachers generally work in rooms (classrooms, lecture theatres, sport halls etc). These rooms should be designed, built and furnished in the way to provide the best possible environment for teacher's vocal effort.
- Stress, burnout: Stress and burnout becoming the second most frequent reason for teachers' sick leave and the second most important health problem of them (Psihosocialni dejavniki tveganja, <http://www.cilizadelo.si/default-61000.html>). Teaching is profession where psychic pressures are relatively high and burnout of teachers is also high (they are on the 10<sup>th</sup> place among 16 professions. On the 1<sup>st</sup> place of burnout are managers, pupils are on the 4<sup>th</sup>) (Pšeničny, 2009). Stress by teachers is a result of different factors, such as social criticism against teachers, overburden of class loads and sundry duties, parental disrespects for teacher authority, low incomes.
- Occupational hearing loss: Noise has very negative impact not only on hearing of someone but it can also cause some other diseases such as high blood pressure, ischemic heart diseases, disturbance of communicating, qualitative disturbance of sleep, tiredness, smaller working efficiency and so on (Hrup, <http://www.cilizadelo.si/default-63100.html>).
- Varicose veins caused by long standing pressure during class.

- Damages of spine caused by long standing. PE teachers have damages of spine because of improper lifting of heavy equipment and because of demonstration of sport elements.
- Autoimmune diseases: It's believed that teachers' relatively high exposure to a large number of children with a variety of viruses could explain their increased risk of death from an autoimmune disease. But there is still low risk for autoimmune diseases among teachers ([http://www.educationworld.com/a\\_issues/issues/issues227.shtml](http://www.educationworld.com/a_issues/issues/issues227.shtml)).

Because there is hardly any research done in Slovenia, Croatia or Slovakia about teacher's health we try to find out if our teachers also have the same health related problems as their colleagues from abroad.

## Methods

AIM The purpose of study was to determine what kind of diseases are the most frequent among Slovenian, Croatian and Slovakian elementary school teachers and physical education teachers.

HYPOTESIS:

H1: All teachers (Slovenian, Croatian and Slovakian; elementary school teachers and physical education teachers) suffer the most from vocational problems (chronic malfunction of vocal chords)

H2: The second most frequent disease among all teachers is hearing loss.

H3: There are differences among elementary school teachers and physical education teachers in diseases and malfunctions of spine and diseases and malfunctions of joints, vocational problems and hearing loss.

METHODS that were used: Data has been collected from April 2010 to January 2011. Statistical programme, SPSS for Windows version 16.0, processed the data obtained. Basic statistical methods were used (number of answers, number of answers in percentage). Chi-square test was made to determine the differences between the two groups (physical education teacher, elementary school teacher) of subjects measured.

SAMPLE OF MEASURMENTES: 354 elementary school teachers were asking to fill out the questionnaire (239 elementary school teachers were from Slovenia, 79 from Croatia and 36 from Slovakia). Average age of teachers was 41.6 years (Slovakian teachers were the oldest with average 47.4 years of age and Slovenian was the youngest with average 40.1 years of age. Average age of Croatian teachers was 43.6 years of age). There were also 122 physical education teachers asking to fill out the questionnaire (32 PE teachers were from Slovenia, 48 from Croatia and 42 from Slovakia). Average age of PE teachers was 45.02 years (48.12 years of age – Slovakian teachers, 44.47 years of age – Croatian teachers and 42.25 years of age – Slovenian teachers).

QUESTIONNAIRE Base of questionnaire was questionnaire "Behavioural style connected with health" done by CINDI Slovenia (<http://www.p-ng-si>) and adapted for needs of this research. The questionnaire is divided into 3 parts (general data, health related problems and injuries). For purpose of this article only part of the "health related problems" part was used.

## Results

Table 1. Number and percent of elementary school teachers who suffer from one of the most common disease

DISEASE	TOGETHER		SLOVENIA		CROATIA		SLOVAKIA	
	number	%	number	%	number	%	number	%
High blood pressure	49	13.8	19	7.9	20	26.0	10	27.8
Diseases and malfunctions of spine	45	12.7	37	15.5	4	5.2	4	11.1
Diseases and malfunctions of joints	18	5.1	7	2.9	6	7.8	5	13.9
Bronchial asthma	12	3.4	6	2.5	2	2.6	4	11.1
Diseases of vocal organ	9	2.5	7	2.9	0	0.0	2	5.6
Allergies	53	15.0	41	17.2	4	5.2	8	22.2
Hearing loss (partly, completely)	19	5.4	3	1.3	16	20.8	0	0.0
Autoimmune disease (hepatitis, a multiple sclerosis...)	5	1.4	1	0.4	4	5.2	0	0.0

Table 2. Number and percent of physical education teachers who suffer from one of the most common disease

DISEASE	TOGETHER		SLOVENIA		CROATIA		SLOVAKIA	
	number	%	number	%	number	%	number	%
High blood pressure	12	9.9	3	9.4	3	6.3	6	14.6
Diabetes	6	5.0	1	3.1	2	4.2	3	7.3
Diseases and malfunctions of spine	12	9.9	6	18.8	3	6.3	3	7.3
Diseases and malfunctions of joints	18	5.1	7	2.9	6	7.8	5	13.9
Diseases of vocal organ	4	3.3	0	0.0	1	2.1	3	7.3
Allergies	10	8.3	3	9.4	4	8.3	3	7.3
Hearing loss (partly, completely)	12	9.9	0	0.0	10	20.8	2	4.9
Autoimmune disease (hepatitis, a multiple sclerosis...)	5	4.1	0	0.0	3	6.3	2	4.9

In the tables only the most frequent answers are shown. At least 5% of teachers from one country had to choose this answer.

Table 3. Differences between physical education teachers and elementary school teachers

DIABETES	Value	df	Asymp. Sig (2-sided)
Pearson Chi <sup>2</sup>	13.581	1	.000
Likelihood Ratio	10.551	1	.001
ARTHRITIS, ARTHROSIS	Value	df	Asymp. Sig (2-sided)
Pearson Chi <sup>2</sup>	12.342	1	.000
Likelihood Ratio	10.861	1	.001
ASTHMA	Value	df	Asymp. Sig (2-sided)
Pearson Chi <sup>2</sup>	4.208	1	.040
Likelihood Ratio	7.162	1	.007

## Discussion and conclusions

The most frequent disease among ES teachers is different kind of allergies. Results of some researches done all over the world shows increase of allergies in last ten years. At these days 35% of all population is estimated to have occasional symptoms of allergy. In Slovenia there are nearly 40.000 children with allergies. 31.5% of Croatian people also have problems with allergies (Ružička, <http://www.ambrozija.hr/alergije/16.htm>). Allergies are also problems for PE teachers but not in the same extent as for ES teachers. It is hard to say what the reason that ES teachers suffer more from allergies than PE teachers is (even there are no statistically significant differences between them).

In general there are no differences between ES teachers and PE teachers in high blood pressure; even though we can find out that Slovakian and Croatian ES teacher have a lot of problems with it. We can assume that this is connected with the age of teachers and probably with their physical activity to. Almost 80.0% of Slovenian ES teachers are physically active for 3.54 hours per week while Croatian teachers on the other hand spend 4.10 hours per week for physical activity but there are 70.0% of them that are physically active at all. Physical activity is probably one of the main reasons why PE teachers do not have as many problems with high blood pressure as ES teachers.

Diseases and malfunctions of spine were between year 2001 and 2005 the main reason for all disabilities (32%) and the 4<sup>th</sup> most important reason for disability of 1<sup>st</sup> category, which cause complete retirement. (Odsotnost z dela zaradi zdravstveno opravičenih razlogov, 2007, pp. 7). As mentioned before there are no special data only for teachers but as it is seen a lot of them have problem with diseases and malfunctions of spine. Because there were no differences between elementary school teachers and physical education teachers we think the main reason is inappropriate carrying for spine (inappropriate weight lifting, inappropriate sitting, incorrect charging of spine, wearing high heels and abdominal and dorsal musculature weakened in whole).

Hearing loss which was expected as very common disease has shown up only by Croatian teacher. It is hard to say what the reason for that kind of results is.

Diseases and malfunctions of joints are generally connected to age, overweight and overburdening (or wrong burdening) of joints and ligaments. Physical education teacher has to shown different elements of sport disciplines to children, has to assist by dangerous elements. That is why more physical education teachers have problems with joints and ligaments as elementary school teachers. So we can assume that problems with joints and ligaments are more connected to work of physical education teachers than to age or overweight.

Asthma is (similar as diabetes) more often shown in the group of elementary school teachers as in the group of physical education teachers. We think that student with asthma probably will not try to study on Faculty of sport because it can

cause some troubles by studying. This is of course not necessary because asthma is a disease which can be controlled with drugs but still a lot of children with asthma is not physically active as they should be.

Considering results we have got we can conclude:

We cannot confirm the 1<sup>st</sup> hypothesis, because most of the teachers (regardless of country of living and profile of teaching) do not have problems with vocal organ diseases.

We cannot confirm the 2<sup>nd</sup> hypothesis, because elementary school teachers have more problems with allergies, high blood pressure and diseases and malfunction of spine as with hearing loss. Physical education teachers have more problems with malfunctions of joints and as often as with hearing loss also with high blood pressure and diseases and malfunction of spine.

We cannot confirm the 3<sup>rd</sup> hypothesis, because differences between groups of measurements were only shown in variables: diabetes, malfunctions of joints and asthma.

Results are valid only for sample of measurements, because there were not enough teachers in sample so we cannot deduce them on entire population. Teachers who participated in research do not have typical “teacher’s” diseases (hearing loss, vocal organ problems); they have more or less the same problems as other people who are the same age. If we want to get more reliable results we should include more teacher in sample, but that was not possible in the moment we did our research. Still results can help us by education of teacher how to take care of his/her health.

## References

1. *Autoimmune Diseases Hit Teachers Hard*. Gained from World Wide Web 3. 5. 2011 [http://www.educationworld.com/a\\_issues/issues/issues227.shtml](http://www.educationworld.com/a_issues/issues/issues227.shtml)
2. Hrup [Noise]. Gained from World Wide Web 5. 8. 2009 <http://www.cilizadelo.si/default-63100.html>
3. Kofol Bric, T. (2007). *Odsotnost z dela zaradi zdravstveno opravičenih razlogov*. Inštitut za varovanje zdravja.
4. *Pravilnik o seznamu poklicnih bolezni*. (2003). Uradni list Republike Slovenije, No. 85/2003.
5. Pšeničny, A. (2009). Razširjenost izgorelosti v Sloveniji [Distribution of Burn Out Syndrom in Slovenia]. *Delo + varnost*, 54, No. 1, pp. 23 – 30.
6. *Psihosocialni dejavniki tveganja (Psychosocial Risk Factors)*. Gained from World Wide Web 22. 4. 2011 <http://www.cilizadelo.si/default-61000.html>
7. Ružička, I. *Alergija na ambroziju*. Gained from World Wide Web 9. 5. 2011 <http://www.ambrozija.hr/alergije/16.htm>
8. *World Health Statistics*. (2006). Geneva : World Health Organization
9. *Zdravi na delovnem mestu [Healthy employees]*. Gained from World Wide Web 3. 8. 2009 <http://www.cilizadelo.si/default-20100.html>



## DIFFERENCES IN ANTHROPOLOGICAL FEATURES AMONG PUPILS IN THE FIFTH, SIXTH, SEVENTH AND EIGHTH GRADES IN REGULAR CLASSES AND PUPILS ORGANIZED IN SPORTS ACTIVITIES IN GOSPIĆ

**Braco Tomljenović<sup>1</sup>, Ivan Radošević<sup>2</sup> and Frane Tomljenović<sup>3</sup>**

<sup>1</sup>*Faculty of Teacher Education, Department in Gospić, University of Rijeka, Croatia*

<sup>2</sup>*Tourist Board of Ličko-senjska Country, Croatia*

<sup>3</sup>*Faculty of Kinesiology, University of Zagreb, Croatia*

### Abstract

This research was done on the sample of 236 pupils, in order to determine quantitative changes in anthropological features among pupils in the fifth, sixth, seventh and eighth grades in regular classes and pupils involved in school sports. For that purpose participants were measured by eleven standard measures and tests for anthropological features evaluation in elementary school. By the analysis of the results it can be concluded that significant differences are visible among pupils in the fifth and the eighth grade and in two variables among pupils in the sixth and the seventh grade.

**Key words:** *elementary school, anthropological features, school sports activities, classes, physical education classes*

### Introduction

Anthropological features are organized system of all features, abilities and motor knowledge and their mutual relation. Anthropological features include anthropometric characteristics, motor, functional and cognitive abilities, conative features and social status. Understanding of anthropological features of age and sex groups pupils/athletes/amateur athletes and understanding of fundamental indicators of their health is a precondition to safe and quality work in kinesiology education, sport and recreation ( Mišigoj, Duraković 2009.) Physical exercise and sport are integral part of education system in the Republic of Croatia. Terms physical exercise and sport in education system imply obligatory Physical Education classes and extracurricular sport activities. Physical education implies regular and optional classes. Regular classes are being implemented by prescribed curriculum twice a week. Optional classes are being held twice a week for 45 minutes. The extracurricular school activities are very important. They aim to reduce differences between scientific and proven, children and youth's need for sport activities and real sports activities in education system. School sport is the main content of extracurricular sport activities of children and youth (Milanović,2009.) Based on the questionnaire from 2007/2008., 29,76 % pupils in elementary schools in Lika-Senj County were involved in practice, workouts and competitions of school sports society. If we take into consideration that effective pupil's time of work during the Physical Education class is 18 minutes and that pupils from the eighth grade spend 34 minutes playing per day, we can conclude that contemporary way of life turns children, pupils and youth into sitting civilization with many negative consequences ( Neljak, 2001.) among which the number of overweight children and adults is emphasized, with the tendency of earlier registration and tracing numerous chronic diseases. The aim of this research is to determine quantitative changes in anthropological features among pupils in the fifth, sixth, seventh and eighth grades in regular classes and pupils involved in school sports in Gospić.

### Methods

The sample of respondents is made of 236 pupils in the fifth, sixth, seventh and eighth grades of Gospić elementary school. The pupils are classified in eight groups in a way that the first group is made of pupils in the fifth grades. They attend regular Physical Education classes. The second group is made of pupils in the fifth grades, who are besides regular classes involved in school sports. The third group is made of pupils in the sixth grades. The fourth group is made of the sixth grades pupils included in school sports. The fifth group is made of pupils in the seventh grades. The sixth group includes seventh grades pupils who attend school sports. The seventh group is made of pupils in the eighth grades, and the eighth group is made of pupils of eighth grades included in school sports. The respondents are measured by standard measures and tests for anthropological features evaluation in elementary school. Anthropological features of pupils are measured by tests: body height ( ATV), body weight ( ATT), forearm scope ( AOP) and the upper arm skin fold ( ANN). Motor abilities are checked by tests: hand tapping ( MTR), long jump ( MSD), sit ups (MPT), bent-feet apart ( MPR), polygon backwards (MPN) and muscular endurance by flexed arm hang (MIV). Functional abilities are checked by tests of aerobic endurance (F800). The test is performed in a manner that the time a pupil achieves on 800 m long track is measured. It is used instead of standard test of aerobic endurance ( F6) because it is easier to motivate pupils. Analysis of the differences between the groups is conducted in a way that the univariant analysis of variance ANOVA is made.

## Results

With the insight into the basic statistical parameters of respondents by classes, it has been determined that distribution of the value of the results is normal. The arguments are based on the fact that the value measures of asymmetry (Skewness), convex curves (Kurtosis) and Kolmogorov – Smirnov test are not being significantly different from limit deviation. By cursory look at the results of analysis of differences among the fifth grade pupils, statistically significant differences in some tests between pupils who attend regular Physical Education classes, and pupils who are besides regular classes involved in school sports, can be noticed. Listed changes are registered at variables that determine: morphological characteristics in variable (ANN), and motor abilities in variables (MTR, MSD, MPN, MPT, MIV). There were no statistically significant differences ( $p=0.05$ ) between groups in variable morphological characteristics.

Table 1. ANOVA- univariant analysis of variance, fifth grade

Variable	Analysis of Variance							
	SS Effect	df Effect	MS Effect	SS Error	df Error	MS Error	F	p
ATV	75,000	1	75,000	14287,67	46	310,6014	0,24147	0,625485
ATT	27,000	1	27,000	4176,67	46	90,7971	0,29737	0,588173
AOP	8,333	1	8,333	149,33	46	3,2464	2,56696	0,115963
ANN	5,603	1	5,603	57,52	46	1,2504	4,48137	0,039705
MTR	108,000	1	108,000	347,25	46	7,5489	14,30670	0,000447
MSD	2451,021	1	2451,021	14090,46	46	306,3143	8,00165	0,006901
MPN	172,710	1	172,710	701,82	46	15,2569	11,32019	0,001554
MPT	884,083	1	884,083	1497,17	46	32,5471	27,16320	0,000004
MPR	85,333	1	85,333	2553,67	46	55,5145	1,53714	0,221332
MIV	2282,521	1	2282,521	15541,96	46	337,8687	6,75565	0,012518
F800	0,000	1	0,000	2,98	46	0,0647	0,00000	1,000000

By the insight in the results of analysis of differences between the sixth grade pupils, statistically significant differences in motor ability variables (MSD, MPN), at the level of statistic significance  $p=0.05$ , can be noticed.

Table 2. ANOVA- univariant analysis of variance, sixth grade

Variable	Analysis of Variance							
	SS Effect	df Effect	MS Effect	SS Error	df Error	MS Error	F	p
ATV	3,742	1	3,742	4887,10	60	81,4516	0,045944	0,831004
ATT	53,667	1	53,667	10080,80	60	168,0133	0,319423	0,574062
AOP	0,765	1	0,765	457,41	60	7,6235	0,100365	0,752491
ANN	1,999	1	1,999	211,38	60	3,5231	0,567398	0,454240
MTR	12,242	1	12,242	384,10	60	6,4016	1,912366	0,171826
MSD	4566,013	1	4566,013	30105,34	60	501,7557	9,100071	0,003746
MPN	102,367	1	102,367	926,78	60	15,4463	6,627306	0,012529
MPT	308,119	1	308,119	5466,80	60	91,1133	3,381710	0,070874
MPR	0,068	1	0,068	10437,43	60	173,9572	0,000391	0,984294
MIV	279,018	1	279,018	30408,08	60	506,8013	0,550547	0,460989
F800	1,726	1	1,726	30,18	60	0,5030	3,432108	0,068861

By the insight in the results of analysis of differences among the seventh grade pupils, statistically significant differences in motor ability variables (MPT, MIV), at the level of statistic significance  $p=0.05$ , can be noticed.

Table 3. ANOVA- univariant analysis of variance, seventh grade

Variable	Analysis of Variance (Spreadsheet1)							
	SS Effect	df Effect	MS Effect	SS Error	df Error	MS Error	F	p
ATV	122,081	1	122,081	6371,35	60	106,1892	1,14965	0,287916
ATT	68,145	1	68,145	11644,32	60	194,0720	0,35113	0,555699
AOP	7,456	1	7,456	420,27	60	7,0046	1,06440	0,306355
ANN	2,601	1	2,601	242,16	60	4,0361	0,64455	0,425237
MTR	20,903	1	20,903	589,48	60	9,8247	2,12761	0,149881
MSD	1446,778	1	1446,778	54729,56	60	912,1594	1,58610	0,212761
MPN	14,710	1	14,710	790,68	60	13,1780	1,11628	0,294957
MPT	473,285	1	473,285	6613,43	60	110,2238	4,29386	0,042556
MPR	136,516	1	136,516	10247,42	60	170,7903	0,79932	0,374869
MIV	5903,629	1	5903,629	35141,29	60	585,6882	10,07982	0,002366
F800	8,202	1	8,202	142,66	60	2,3776	3,44955	0,068179

By insight in the results of analysis of differences among the eight grade pupils, statistically significant differences in some test values between pupils who attend regular Physical Education classes and pupils who are besides regular classes involved in school sports can be noticed. Listed changes are registered, at the level of statistic significance  $p=0.05$ , at variables that determine: morphological characteristics in variable (AOP), motor abilities in variables (MTR, MSD, MPN, MPT, MIV), and aerobic endurance in variable (F800).

Table 4. ANOVA- univariant analysis of variance, eight grade

Variable	Analysis of Variance (Spreadsheet26)							
	SS Effect	df Effect	MS Effect	SS Error	df Error	MS Error	F	p
ATV	1,562	1	1,562	6488,38	62	104,651	0,01493	0,903143
ATT	430,563	1	430,563	12026,88	62	193,982	2,21960	0,141338
AOP	72,250	1	72,250	709,50	62	11,444	6,31360	0,014597
ANN	21,530	1	21,530	344,16	62	5,551	3,87849	0,053381
MTR	105,062	1	105,062	1288,69	62	20,785	5,05466	0,028125
MSD	6422,019	1	6422,019	89353,77	62	1441,190	4,45605	0,038817
MPN	200,152	1	200,152	516,67	62	8,333	24,01798	0,000007
MPT	1105,563	1	1105,563	4476,88	62	72,208	15,31088	0,000229
MPR	370,563	1	370,563	8733,19	62	140,858	2,63075	0,109887
MIV	4472,266	1	4472,266	39858,84	62	642,885	6,95656	0,010543
F800	21,751	1	21,751	118,96	62	1,919	11,33630	0,001310

## Conclusion

This research was done on the sample of 236 pupils, in order to determine quantitative changes in anthropological features among pupils in the fifth, sixth, seventh and eighth grades in regular classes and pupils involved in school sports in Gospić. For that purpose participants were measured by eleven standard measures and tests for anthropological features evaluation in elementary school. By the analysis of the results it can be concluded that significant differences, at the level of statistic significance  $p=0.05$ , are visible among pupils in the fifth and the eighth grade and in two variables among pupils in the sixth and the seventh grade. It can be concluded that the changes are the result of the influence of both, obligatory Physical Education classes (45 minutes, two times per week) and extracurricular sport activities. It also needs to take into consideration that anthropological features are influenced by the age, growth, entering the period of puberty, and the puberty itself.

## References

1. Boris, N., Milanović, D. (2007). *Organizacijski, programski i materijalni uvjeti za redovito tjelesno vježbanje djece i mladeži*. U: Jukić, I., Milanović, D., Šimek, S. Zbornik radova 5. godišnja međunarodna konferencija Kondicijska priprema sportaša. Kineziološki fakultet Sveučilišta u Zagrebu. (st.32-39).
2. Findak, V., Neljak, B., (2008). *Stanje i perspektiva razvoja u područjima edukacije, sporta, sportske rekreacije i kineziterapije*. U: B. Neljak (ur.) Zbornik radova 17. ljetne škole Kineziologa RH, Poreč, 2008., (str. 16-30). Poreč: Hrvatski kineziološki savez.
3. Marjeta Mišigoj-Duraković, Zijad Duraković (2007). *Antropološke i zdravstvene pretpostavke rada u kineziološkoj edukaciji, sportu i rekreaciji*. U: Findak, V. (ur.) Zbornik radova 116. ljetne škole Kineziologa RH, Poreč, 2007., (str. 55-62). Poreč: Hrvatski kineziološki savez.
4. Mišigoj-Duraković, M. (2008). Kinantropologija. Zagreb: Kineziološki fakultet Sveučilišta u Zagrebu.
5. Milanović, D., Čustonja, Z., Neljak, B. i sur. (2009). *Strategija razvoja školskog sporta u Republici Hrvatskoj 2009.-2014*. Ministarstvo znanosti, obrazovanja i sporta RH, Hrvatski školski sportski savez. Zagreb. 2009. (str.13-115).
6. Milanović, D., Čustonja, Z., Jukić, I. (2008). *Stanje i perspektiva razvoja školskog sporta u Republici Hrvatskoj*. U: B. Neljak (ur.) Zbornik radova 17. ljetne škole Kineziologa RH, Poreč, 2008., (str. 42-59). Poreč: Hrvatski kineziološki savez.
7. Milanović, D. et al. (2004). *Tjelesno vježbanje i sport u odgojno-obrazovnom procesu: strateški pristup. // Škola i razvoj = School and development: međunarodni znanstveno stručni skup: zbornik radova, Topusko 13 i 14 svibnja 2004*. Petrinja: Visoka učiteljska škola, 2004. (st. 28-38).
8. Tomljenović, B., Tomljenović, F. (2005). Procjena razlika morfoloških obilježja učenika prvih razreda osnovnih škola u Lici. U: V. Findak (ur.) Zbornik radova 14. ljetne škole Kineziologa RH, Rovinj, 2005., (str. 129-133). Rovinj: Hrvatski kineziološki savez.

## ATTENDANCE AT DANCE CLASSES IN RELATION TO DANCE RESULTS

Jadranka Vlašić, Stjepka Leščić and Goran Oreb

*Faculty of Kinesiology, University of Zagreb, Croatia*

### Abstract

Class attendance is an important factor in academic success. The aim of this paper is to determine how the attendance at theoretical/practical classes and Dance course exercises is related to success in folk and social dancing. The regression analysis revealed a statistically significant relation between class attendance and the overall success in folk dancing, but the relation between class attendance and the success in social dancing was not statistically significant. This is caused by the Dance course curriculum, the number of hours, and the sequence of instruction for folk and social dances.

**Key words:** *academic success, dance course exercises, folk, social dancing*

### Introduction

The common opinion of many researchers, educators and professional associates who participate in the educational process is that there is a positive relationship between attendance and academic success.

The relationship between attendance and exam success has been the subject of several published studies. Many of them have confirmed the positive impact of attendance on exam success for university subjects (Park and Kerr, 1990; Van Blerkom, 1992; Romer, 1993; Gunn, 1993; Durden and Ellis, 1995; Devadoss and Foltz, 1996; Marburger, 2001; Bratti and Staffolani, 2002; Dolton, et al., 2003; Kirby and McElroy, 2003; Rodgers, 2001; Rocca, 2003; Stanca, 2006; Lin and Chen, 2006).

Students who attend regularly are more successful in exams (Lamdin, 1996; Nichols, 2003). Some studies point out the fact that the presence of students in class can be regarded as a relevant factor in the quality of the faculty (Coutts, 1998). Certain studies consider attendance to be sufficiently important in assessing the academic results of students (King, 2000; Lehr, Sinclair and Christensen, 2004; Sheldon, 2007), suggesting that increased attendance is not a direct indicator but a determinant of academic success.

However, there are studies that examine the students' absence from classes, their reasons, and its negative impact on academic achievement. The conclusions of research conducted among the high school population suggest that lower attendance at high school has negative effects on school success and that it can be a predictive factor of poor attendance for higher education (Finn, 1993; Lehr et al., 2004; Stouthamer-Loeber & Loeber, 1988). On the other hand, student absences can negatively affect even the students who attend classes regularly, because of the frequent repetition of information, instructions and explanations for the benefit of those who were absent from previous sessions (Fjortoft, 2005; Longhurst, 1999).

On the basis of the findings above, this paper intends to determine how the attendance of theoretical/practical classes and Dance course exercises is related to the success in folk and social dancing. Dance is a subject in the curriculum of the integrated graduate study of kinesiology that is taken in the 5th semester. It consists of a total of 75 hours: 15 hours of theoretical lectures and 30+30 hours of theoretical and practical lectures and exercises. During the theoretical and practical lectures and exercises, the students learn, adopt and practice motor skills in folk and social dances.

The expected hypothesis is that students with regular attendance and fewer absences from theoretical/practical lectures and Dance course exercises will be more successful folk and social dancing.

### Methods

The study was conducted on a sample of 165 students of the Faculty of Kinesiology of the University of Zagreb, who were regularly enrolled in the third year of study, with the mean age of  $22 \pm 1$  years.

The variables for assessing dance success represented the scores, based on video recordings, that were given by dance experts to each subject during the performance of 5 folk dances (Sotiš, Došla sam vam japa dimo, Slavonsko kolo, Poskočica, Vrličko kolo) and 5 social dances (English waltz, Rumba, Cha-cha-cha, Samba, Slowfox). The unannounced video recording was made after completing the lessons in folk and social dances. In order to ensure equal conditions for the demonstration of acquired knowledge of each subject, after the explanation of the assessment process, the subject had to demonstrate a given dance. After demonstrating a sequence of five folk dances and five social dances with prerecorded

music, each subject had to remain in the hall until all the other subjects ended their demonstrations. In this way, the next subjects could not be informed about the dance tasks, and the prerecorded music ensured equal musical conditions for all the subjects.

All the evaluators assessed the demonstrated knowledge simultaneously and independently from one another. The demonstration of dance knowledge was assessed with scores from 1 to 5. The results of evaluation were expressed on a five-degree scale belonging to the ordinary measurement scale (Supek, 1981, in Mejovšek, 2003).

When choosing dances that were representative for the folk dance group and the social dance group, several criteria were taken into account: the Dance course curriculum, the structural analysis of each dance, the variety of rhythms and tempos, the ethnochoreological determination for folk dances. For the demonstration of knowledge of specific dances to be estimated with scores from 1 to 5, it had to meet exact pre-determined criteria. These criteria enabled the evaluators to focus on the same parts of specific dances when assessing dance demonstrations.

The attendance variable was obtained from the students' attendance records for the Dance classes, separately for folk dances and separately for social dances. It was expressed by the frequency of classes attended by a student.

In accordance with the research objective, the obtained results were processed by the software package Statistica for Windows 7.0. The objectivity of the judicial assessment was verified by the reliability analysis (Alpha, Stand. Alpha) and the average correlation between the judges' scores (AVR). Furthermore, the basic descriptive parameters were calculated: arithmetic mean, standard deviation, minimum value, maximum value. Normal result distribution was checked with the Kolmogorov-Smirnov test.

To test the hypothesis, to determine the correlation between the Dance class attendance and the success in folk and social dancing, the regression analysis was used.

## Results

The results of the descriptive analysis in Table 1 indicate the average scores of individual judges for folk dances was in the range from 2.59 to 3.07, and the overall average score for folk dances was 2.87 (SUCFD). The average scores of individual judges for each social dance was in the range from 2.65 to 3.04, and the overall average score for social dances was 2.77 (SUCSD). The Kolmogorov-Smirnov test showed that the results of all the variables were normally distributed.

Table 1. Descriptive parameters of variables for assessing success in dancing

VAR	N	MEAN	MIN	MAX	SD	MAX D	p
Sotis	165	3,07	1,00	5,00	0,80	0,17	<0,01
Japa	165	2,92	1,00	5,00	1,02	0,15	<0,01
Slkolo	165	2,59	1,00	5,00	1,16	0,11	<0,05
Posko	165	2,98	1,00	5,00	1,10	0,12	<0,05
Vrlika	165	2,80	1,00	5,00	1,02	0,14	<0,01
SUCFD	165	2,87	1,08	4,84	0,90	0,05	<0,20
Eng	165	3,04	1,00	5,00	0,92	0,16	<0,01
Rumba	165	2,76	1,00	5,00	1,06	0,17	<0,01
Cha	165	2,65	1,00	5,00	1,04	0,16	<0,01
Samba	165	2,72	1,00	5,00	1,01	0,12	<0,05
Slow	165	2,68	1,00	5,00	1,02	0,18	<0,01
SUCSD	165	2,77	1,00	4,92	0,88	0,05	<0,20

The reliability analysis verified the objectivity of judges for each dance, as shown in Table 2. The coefficients of the average correlation between the judges (AVR) had values higher than 0.89, and the Cronbach reliability coefficient (ALPHA) had values higher than 0.97.

Table 2. Reliability analysis for judges' assessments

VAR	ALPHA	STAND.ALPHA	AVR
Sotis	0,97	0,97	0,89
Japa	0,98	0,98	0,91
Slkolo	0,98	0,98	0,93
Vrlika	0,97	0,97	0,9
Posko	0,98	0,98	0,92
Eng	0,98	0,98	0,94
Rumba	0,98	0,98	0,92
Cha	0,98	0,98	0,94
Samba	0,98	0,98	0,91
Slow	0,98	0,98	0,94

Table 3 shows the descriptive parameters of the Dance class attendance, where it is obvious that the students were absent from 33.74 hours out of a total of 40 hours of folk dancing and from 16.7 hours out of a total of 20 hours of social dancing.

Table 3. Descriptive parameters of variables of attendance at folk and social dances

VAR	N	MEAN	MIN	MAX	SD	MAX D	p
ATTENDFD	165	33,74	2	40	5,8	0,18	<0,01
ATTENDSD	165	16,7	6	20	3,21	0,21	<0,01

The regression analysis (Table 4) identified a small but statistically significant correlation ( $R = 0.19$ ) between class attendance and the overall success in folk dancing with the margin of error of 0.01. The correlation between the overall success in social dancing and class attendance is statistically significant with the margin of error of 0.6, which means that it is not statistically significant.

Table 4. Regression analysis of success in folk dancing and class attendance

SUCFD	R=0,19; R <sup>2</sup> =0,03; Adj. R <sup>2</sup> =0,03; F=6,14; p=0,01				
	B	Std. Pog.	Beta	t	P
ATTENDFD	0,02	0,01	0,19	2,47	0,01

Table 5. Regression analysis of success in social dancing and class attendance

SUCSD	R=0,04; R <sup>2</sup> =0,00; Adj. R <sup>2</sup> =-0,00; F=0,26; p=0,60				
	B	Std. Pog.	Beta	t	P
ATTENDSD	-0,01	0,02	-0,04	-0,51	0,60

## Discussion and conclusions

The objective of this study was to determine how Dance class attendance affects success in folk dancing and social dancing. The overall success score for both dance types was calculated as the average score of the five judges for each dance and then as the average score for all five dances, both folk and social. The regression analysis showed that dance success was related to folk dances, but not to social dances.

Regarding the presented results, the authors believe that they can be explained from the viewpoint of the number of hours, the curriculum, the didactic/methodical procedures and the structural characteristics of dances.

As for the number of hours, folk dances took 40 teaching hours (20 hours of theory/practice lectures and 20 hours of exercises) and social dances took 20 hours (10+10).

Therefore, a statistically significant correlation ( $R = 0.19$ ) between class attendance and the success in folk dancing, which took twice as many hours, seems logical. It should be noted that the teaching of folk dances presented 27 folk dances from 4 Croatian ethnochoreological regions; the teaching of social dances presented 10 social dances from among the world dances. Although the ratio of folk and social dances, and of the numbers of hours, was not exactly proportional, given the achieved average scores of folk (2.87) and social (2.77) dances, the authors considered this phenomenon to be negligible for further discussion.

Interestingly, this was the first time the students studied Dance, so that the graduality, appropriateness and dosage of teaching was given far more attention than later in the teaching process. Students were initially accustomed to music through easier motor tasks, simpler rhythms and slower musical tempos. That principle was also respected when choosing folk songs at the beginning of the teaching process.

The relation between attendance and dance success for folk dances can also be explained by frequent repetitions of particular dance elements and entire dances. The preparatory parts of classes almost always used already trained dance elements and entire dances, which undoubtedly resulted in a greater number of repetitions of the motor stereotype and its stabilization, than for social dancing. In addition, because of the frequent repetition of the motor stereotype, students listened more to specific music, which is another relevant factor for exam success.

Finally, the relation between attendance and dance success for folk dances was most probably helped by the rhythmic and motor structural similarity (Oreb, 1993). The 2/4 “ta-ta-te” dance pattern (Slavonian three steps) that the student masters at the beginning of folk dance classes is completely identical to the 4/4 S-Q-Q dance pattern of rumba (basic step), but at a slower pace. Therefore, the student masters an already known dance pattern, regardless of the stylistic features, so it is possible that he does not dedicate enough attention to it. On the other hand, he has less time to practice rumba than the Slavonian “kolo” dance.

It remains to be verified whether the results would be the same if the curriculum distribution was different – in other words, if social dances were taught at the beginning of the semester and folk dances at the end of the semester. But the practice showed and science confirmed that the motor stereotype can be set up with quality instruction and stabilized with the necessary number of repetitions.

In conclusion, it can be argued that attendance is an important factor in academic success (Stanca, 2005), but in future research it would certainly be necessary to include other factors that influence academic success, such as social status and environment, success in previous education, motivation, attitudes, behavior (Salisa et al., 2009). It should also be pointed out that the attendance is mandatory in most cases (courses) and that non-mandatory class attendance would greatly change this type of research.

## References

1. Bratti, M. and S. Staffolani (2002). Student Time Allocation and Educational Production Functions, Working Paper Number 170, Economics Department, University of Ancona.
2. Coutts, D. (1998). How to better track effective school indicators: The control chart techniques. *American Secondary Education*, 27, 2-10.
3. Devadoss, S. and J. Foltz (1996), Evaluation of Factors Influencing Student Class Attendance and Performance, *American Journal of Agriculture Economics*, 78, 499-507.
4. Dolton, P., Marcenaro, D. and L. Navarro (2003). The Effective Use of Student Time: a Stochastic Frontier Production Function Case Study, *Economics of Education Review*, 22, 547-560.
5. Durden, C. and V. Ellis (1995). The Effects of Attendance on Student Learning in Principles of Economics, *American Economic Review*, 85, 343-346.
6. Finn, J. D. (1993). School engagement and students at risk. Washington, DC: National Center for Education Statistics.
7. Fjortoft N. Students' motivations for class attendance. *Am J Pharm Educ*. 2005; 69(1): Article 15.
8. Gunn, P. (1993). A Correlation between Attendance and Grades in a First-year Psychology Course, *Canadian Psychology*, 34, 201-202.
9. King, A. R. (2000). Relationships between CATI personality disorder variables and measures of academic performance. *Personality and Individual Differences*, 29, 177-190.
10. Kirby, A. and B. McElroy (2003). The Effect of Attendance on Grade for First Year Economics Students in University College Cork, *The Economic and Social Review*, 34, 311-326.
11. Lamdin, D. J. (1996). Evidence of student attendance as an independent variable in education production functions. *Journal of Educational Research*, 89, 155-162.
12. Lehr, C. A., Sinclair, M. F., & Christenson, S. L. (2004). Addressing student engagement and truancy prevention during the elementary school years: A replication study of the Check & Connect model. *Journal of Education for Students Placed at Risk*, 9, 279-301.
13. Longhurst R.J. Why aren't they here? Student absenteeism in a further education college. *J Further High Educ*. 1999;23(1):61-80.

14. Marburger, R. (2001). Absenteeism and Undergraduate Exam Performance, *Journal of Economic Education*, 32, 99-110.
15. Nichols, J. D. (2003). Prediction indicators for students failing the state of Indianahigh school graduation exam. *Preventing School Failure*, 47, 112-120.
16. Oreb, G. (1992). *Relativna efikasnost utjecaja plesa na motoričke sposobnosti studentica*. (Dissertation). Zagreb: Faculty of physical education.
17. Park, H. and P. Kerr (1990). Determinants of Academic Performance: a Multinomial Logit Approach, *Journal of Economic Education*, 21, 101-111.
18. Rocca, A. K. (2003). Student Attendance: A Comprehensive Literature Review, *Journal on Excellence in College Teaching*, 14, 85-107.
19. Rodgers, R. (2001). A Panel-data Study of the Effect of Student Attendance on Academic Performance, unpublished manuscript.
20. Romer, D. (1993). Do Students Go to Class? Should They?, *Journal of Economic Perspectives*, 7, 167-174.
21. Sheldon, S. B. (2007). Improving student attendance with school, family, and community partnerships. *Journal of Educational Research*, 100, 267-275.
22. Stanca, L. (2005). The Effects of Attendance on Academic Performance: Panel Data Evidence for Introductory Microeconomics, forthcoming, *Journal of Economic*.
23. Stouthamer-Loeber, M., & Loeber, R. (1988). The use of prediction data in understanding delinquency. *Behavioral Sciences and the Law*, 6, 333-354.
24. Van Blerkom, L. (1992). Class Attendance in an Undergraduate Course, *Journal of Psychology*, 126, 487-494.
25. Vlašić, J. (2010). *Razlike između studentica i studenata u plesnoj uspješnosti i stavovima prema plesu*. (Dissertation). Zagreb: University of Zagreb Faculty of Kinesiology).



## THE DIFFERENCES IN THE MOTORIC PREKNOWLEDGE OF ARTISTIC GYMNASTICS AMONG THE FEMALE STUDENTS OF FACULTY OF KINESIOLOGY

Kamenka Živčić Marković and Ines Čavar

*Faculty of Kinesiology, University of Zagreb, Croatia*

### Abstract

The aim of this study was to test the prior knowledge of basic gymnastic elements among the second year students, as the basic guidelines for the conduction of Gymnastics course at the Faculty of Kinesiology in Zagreb, and to determine the differences among the three generations. The research was conducted on a sample of 153 students of three different generations of faculty of Kinesiology, University of Zagreb. To determine the statistical significant difference between the three generations of students it was used the Kruskal-Wallis one-way analysis of variance, and for the determination of differences between the three generations on the basis of rated elements Mann-Whitney's nonparametric test was used. The level of significance was calculated with Bonferroni correction. We found significant differences between groups in some variables. Groups 1 and 2 significantly differ in three basic elements of gymnastics: STOP, PRSTRD and PRSTRD ( $\alpha = 0,001$ ), while in the remaining elements significant difference has not been established. Groups 1 and 3 have statistically significant differences in five rated elements: KOLNAP, STOP, PRSTRD, PRSTRD ( $\alpha = 0,001$ ) and UZMAH ( $\alpha = 0,005$ ), while between Group 2 and 3 significant statistical differences are minimal and manifest only in one element: STOJ ( $\alpha = 0,001$ ). It can be concluded that during the primary education, the female students of the Faculty of Kinesiology did not have enough motor information about the artistic gymnastics.

**Key words:** *artistic gymnastics, gymnastic elements*

### Introduction

Gymnastics is included in all curricula of physical education, at each level of education, in a way that the selection of objectives, content and knowledge standards are adapted to the level of students development. In the curriculum for primary schools (MZOS, 2006), due to the technical foundation and current scientific and theoretical knowledge, artistic gymnastics is represented in a large number of educational topics. Of course, a large amount of gymnastic themes in the school curriculum is the reason of its numerous effects on the children's health and development and also its contents largely satisfy the general and targeted objectives of physical education.

An important fact that influences the importance of gymnastics in the curriculum is that it is particularly suitable for the adoption of essential, basic movement structures that are stored in the motor base in the form of motor fundamentals necessary for a harmonious and efficient movement and their application in everyday life (Novak et al., 2008). For this reason, it is the most common in elementary schools where the largest number of fundamental gymnastic movements is being thought. Throughout the entire primary school education, of the total number (205) of teaching topics and units of physical education the presence of gymnastic themes in relation to the remaining sports facilities is 33% (67) among male pupils and 38% (77) among female pupils (Živčić, 2010).

Therefore, the aim of this study was to test the prior knowledge of basic gymnastic elements among the second year students, as the basic guidelines for the conduction of Gymnastics course at the Faculty of Kinesiology in Zagreb, and to determine the differences among the three generations.

### Methods

The research was conducted on a sample of 153 students of three different generations of faculty of Kinesiology, University of Zagreb: 49 students of the school year 2008/09 (1), 48 of the school year 2009/10 (2) and 56 of the school year 2010/11 (3). The testing of basic motor skills of school gymnastics was done in the first class of the Gymnastics course. The technique was judged by the expert team (4 gymnastics experts). The technique of eight gymnastic elements that are an integral part of the curriculum of physical education for primary school was estimated: *forward roll* (KOLNAP), *backward roll* (KOLNAT), *right cartwheel* (PRSTRD), *left cartwheel* (PRSTRL), *handstand beside vertical surface* (STOJ), *pullover* (UZMAH), *releve walk on the balance beam* (GREDH) and *safety walk on the balance beam* (GREDS) (Živčić, 2007, Novak, Čuk, Kovač, 2008, Živčić & Breslauer, 2011). The Technique of gymnastic elements was rated with school marks, on a scale 0-5.

Data processing was performed by statistical package SPSS version 11.5. Basic descriptive statistical parameters (mean, standard deviation, range, minimum and maximum scores, and flattening the curvature distribution) were calculated for all the variables. The frequencies of class and frequency histograms were also calculated. Normality of distribution was checked by Kolmogorov-Smirnov test. To determine the statistical significant difference between the three generations of students it was used the Kruskal-Wallis one-way analysis of variance, and with the aim of determination of differences among the three generations on the basis of rated elements Mann-Whitney's nonparametric test was used. The level of significance was calculated with Bonferroni correction.

## Results

Comparing the basic descriptive parameters (Table 1) among three generations of students of the Faculty of Kinesiology in Zagreb it could be seen that the results of the tests are in areas of lower values (0-1) in most of the measured fundamental movement skills in gymnastics, especially for the group 3. In group 1 the average results are moving in the zone of values from 1.51 to 3.37 with standard deviation from 1.063 to 1.196. Slightly lower values are also seen in the Group 2 (Mean 0.67 to 2.77) and Group 3 (Mean 0.13 to 2.95) while the standard deviations are of similar values (STD = Group 2: 1.111 to 1.533, group 3: 0.715 to 1.168). K-S test showed that data were not normally distributed.

Considering that the analyzed values had positive asymmetric distribution (Table 1), for the determination of statistically significant differences between groups Kruskal-Wallis one-way analysis of variance was applied. Table 3 shows that there are significant differences between groups in some variables. Statistically significant difference was found in the variables: KOLNAP, STOJ, PRSTRD and PRSTRL ( $\alpha = 0,001$ ).

Analyzing the results based on the rated gymnastic elements, Table 4 shows statistically significant differences between groups. Groups 1 and 2 significantly differ in three basic elements of gymnastics: STOP, PRTSRD and PRSTRD ( $\alpha = 0,001$ ), while in the remaining elements significant difference has not been established. Groups 1 and 3 have statistically significant differences in five rated elements: KOLNAP, STOP, PRTSRD, PRSTRD ( $\alpha = 0,001$ ) and UZMAH ( $\alpha = 0,005$ ),

Table 1. Descriptive Statistics

GROUP 1	N	Min	Max	Mean	Std. Err	Std.	Variance	Skew	Std. Err	Kurt	Std. Err
KOLNAP	49	1	5	2,71	,20	1,399	1,958	,061	,340	-1,347	,668
KOLNAT	49	1	5	1,96	,18	1,258	1,582	1,259	,340	,635	,668
STOJ	49	0	5	1,51	,15	1,063	1,130	2,088	,340	4,037	,668
PRSTRD	49	0	5	1,90	,19	1,358	1,844	1,077	,340	-,181	,668
PRSTRL	49	0	5	1,78	,18	1,279	1,636	1,312	,340	,637	,668
UZMAH	49	1	5	2,55	,18	1,292	1,669	,487	,340	-,808	,668
GREDH	49	1	5	2,84	,17	1,196	1,431	-,053	,340	-1,027	,668
GRES	49	1	5	3,37	,19	1,318	1,737	-,439	,340	-,900	,668
<b>GROUP 2</b>											
KOLNAP	48	1	5	2,12	,20	1,362	1,856	1,029	,343	-,190	,674
KOLNAT	48	1	5	1,69	,17	1,188	1,411	1,757	,343	2,111	,674
STOJ	48	0	5	,67	,17	1,191	1,418	2,030	,343	3,778	,674
PRSTRD	48	0	5	,98	,19	1,313	1,723	1,336	,343	1,067	,674
PRSTRL	48	0	5	1,00	,16	1,111	1,234	1,749	,343	3,815	,674
UZMAH	48	0	5	2,02	,19	1,345	1,808	,399	,343	,416	,674
GREDH	48	0	5	2,56	,21	1,486	2,209	,117	,343	-1,010	,674
GRES	48	1	5	2,77	,22	1,533	2,351	,219	,343	-1,405	,674
<b>GROUP 3</b>											
KOLNAP	56	0	5	1,84	,17	1,304	1,701	1,125	,319	,512	,628
KOLNAT	56	0	5	1,55	,20	1,464	2,143	,648	,319	-,528	,628
STOJ	56	0	5	,13	,10	,715	,511	6,308	,319	41,588	,628
PRSTRD	56	0	5	,88	,17	1,237	1,530	1,980	,319	3,871	,628
PRSTRL	56	0	5	,73	,16	1,168	1,363	2,326	,319	5,784	,628
UZMAH	56	0	5	1,62	,18	1,369	1,875	,367	,319	-,392	,628
GREDH	56	0	5	2,23	,22	1,651	2,727	,544	,319	-1,088	,628
GRES	56	0	5	2,95	,19	1,407	1,979	-,146	,319	-1,024	,628

while between Group 2 and 3 significantly statistical differences are minimal and manifest only in one element: STOJ ( $\alpha = 0,001$ ).

## Discussion

Based on the analysis, it could be stated that there are sufficient facts that determine the differences between the three groups of students based on eight basic assessment techniques of gymnastic elements. After examining the ordinal clustering data (table 2) and based on an analysis of descriptive statistical parameters, it is noticeable that the student ratings of individual elements are ranged up in the zone of lower values, or among grades 0, 1 and 2. This indicates that their basic knowledge acquired in elementary and secondary education system is not satisfactory or without complete structure of the movement. The grades 4 and 5 for the assessment of the technique were found in a very small number of students. It should be noted that in all three generations a certain number of students were previously involved in systematic physical training in gymnastics, as well as related sports and recreational activities (rhythmic gymnastics, various kinds of dance, synchronized swimming and figure skating).

Table 2. Frequency

MARKS	KOLNAP		KOLNAT		STOJ		PRSTRD		PRSTRL		UZMAH		GREDH		GRES	
	N	%	N	%	N	%	N	%	N	%	N	%	N	%	N	%
0	3	1,9	18	11,8	87	57,0	53	34,7	49	32,0	27	17,7	8	5,2	1	0,7
1	65	42,5	69	45,1	42	27,5	59	38,6	70	45,8	18	11,7	41	26,8	32	20,9
2	29	19,0	30	19,6	12	7,8	15	9,8	14	9,2	61	39,9	30	19,6	22	14,3
3	23	15,0	18	11,7	5	3,3	10	6,5	8	5,2	26	17,0	28	18,3	35	22,9
4	19	12,4	9	5,9	3	2,0	10	6,5	6	3,9	10	6,5	28	18,3	33	21,6
5	14	9,2	9	5,9	4	2,6	6	3,9	6	3,9	11	7,2	18	11,8	30	19,6
<b>TOTAL</b>	153	100	153	100	153	100	153	100	153	100	153	100	153	100	153	100

Table 3. Kruskal-Wallis one-way analysis of variance for the differences among three groups

	KOLNAP	KOLNAT	STOJ	PRSTRD	PRSTRL	UZMAH	GREDH	GRES
Chi-Square	10,844	3,836	80,923	25,801	29,875	10,001	5,446	4,386
df	2	2	2	2	2	2	2	2
Asymp. Sig. ( $\alpha$ )	,004	,147	,000	,000	,000	,007	,066	,112

Table 4. Mann-Whitney's nonparametric test for the differences among the three generations on the basis of rated elements

Group 1-2	KOLNAP	KOLNAT	STOJ	PRSTRD	PRSTRL	UZMAH	GREDH	GRES
Mann-Whitney U	898,00	1000,50	503,00	646,00	729,50	950,00	1041,00	909,50
Wilcoxon W	2074,00	2176,50	1679,00	1822,00	1905,50	2126,00	2217,00	2085,50
Z	-2,08	-1,43	-5,18	-4,00	-3,52	-1,70	-,99	-1,97
Asymp. Sig. ( $\alpha$ )	,037	,154	,000	,000	,000	,089	,319	,049
Group 1-3	KOLNAP	KOLNAT	STOJ	PRSTRD	PRSTRL	UZMAH	GREDH	GRES
Mann-Whitney U	893,50	1106,50	114,00	672,00	593,50	895,50	1017,50	1136,50
Wilcoxon W	2489,50	2702,50	1710,00	2268,00	2189,50	2491,50	2613,50	2732,50
Z	-3,201	-1,76	-8,91	-4,79	-5,36	-3,15	-2,33	-1,55
Asymp. Sig. ( $\alpha$ )	,001	,078	,000	,000	,000	,002	,020	,122
Group 2-3	KOLNAP	KOLNAT	STOJ	PRSTRD	PRSTRL	UZMAH	GREDH	GRES
Mann-Whitney U	1176,50	1218,00	953,00	1319,50	1069,00	1149,00	1153,50	1245,50
Wilcoxon W	2772,50	2814,00	2549,00	2915,50	2665,00	2745,00	2749,50	2421,50
Z	-1,17	-,86	-3,87	-,17	-1,95	-1,35	-1,27	-,66
Asymp. Sig. ( $\alpha$ )	,243	,389	,000	,862	,052	,178	,203	,511

Analyzing the differences in the individual elements of technique between the three groups of students, it is evident that there was no discrimination on the basis of all measured variables, but according to differences in generations. So, in the variables GREDH and GREDS students are largely estimated from the higher grades where it can be seen that 48,4% received a score of 3-5, and even more than half of students (67.1%) was successfully and safety maintain the equilibrium position during walking on the high beam. These data suggest that most of them has met with this kind of technology in PE teaching, in sports training or in everyday life and thus managed to develop a particular type of surety along the narrow, elevated area. According to this, variables did not significantly discriminated measures in these three groups.

It can also be noted that the variable UZMAH has not statistically significant impact the difference between group 1 and 2 ( $\alpha = 0.89$ ), while the Groups 1 and 3 had statistically significant differences in the above variable ( $\alpha = 0,002$ ). In this variable 70.6% of students have received a positive evaluation of performance for this gymnastic element where they average ratings ranged from 1.62 (3), 2.02 (2) to 2.55 (1). The basic explanation could be found in the fact that the generation of student in the school year 2008/09. year enrolled in college (in the classification procedure) the pullover exercise for the past ten years as the test question for the gymnastics. Thus, the future students were preparing and partially overcome by a technique which resulted in satisfactory values by a larger number of passing grades.

Low values for individual assessment of techniques from multiple gymnastic elements indicate a lack of primary motor information from the artistic gymnastics in primary school which is not understandable for several reasons. In the Curriculum of Physical Education learning the forward roll (KOLNAP) begins as early as the first grade, and the technique is further improved through thematic units in the remaining seven classes. Learning of backward roll (KOLNAT) starts at second class and the technique is also improved through the remaining classes. Cartwheel (PRSTRL and PRSTRD) is being learned through a methodical process entirely in the third class and through a variety of treatments especially in the 7 and 8 grades. Handstand beside vertical surface (STOJ) is a major theme in 5 grade, and previous is taught through various forms of preparation and methodical exercise.

## Conclusion

With many sports and additional structures, in the curriculum of primary schools (Ministry of Science, 2006) it has been noticed a large number of subjects of sports gymnastics, which indicates their significance and applicability in the realization of basic and special educational and anthropological tasks of school children. Accordingly, we can say that exercise has an important role in training of students for independent practice for the enhancement the quality of life, effectively changing properties and develop skills which directly provides health promotion as an irreplaceable factor in all human activities, and define the main objective of physical education (Findak, Prskalo & Pejčić 2003). Based on our analysis, there is disturbingly low level of the prior knowledge in the artistic gymnastics, which dictate the way of thinking about, and access to all of their implementation in primary and secondary school children and youth in the Republic of Croatia. The same could be stated for the candidate who is focused on Physical Education because it is well known that the sports gymnastics is one of the main spots that have multiple effects on the development of motor skills, especially on coordination, as one of the important factors in learning and mastering the new movement structures. For this reason, and based on the data obtained, it can be concluded that during the primary education, the students of Faculty of Kinesiology did not have enough motor information from the sport gymnastics.

## References

1. Findak, V., Prskalo, I., Pejčić, A. (2003). Additional exercise as an efficiency factor in physical Education lessons. *Kinesiology – Internacional Journal of Fundamental anal Applied Kinesiology*,35(2), 143-154.
2. Ministarstvo znanosti, obrazovanja i športa (2006). HNOS - Nastavni plan i program za osnovnu školu. Zagreb: Ministarstvo znanosti, obrazovanja i športa. <http://www.mzos.hr>
3. Novak, D., Kovač, M., Čuk, I. (2008). *Gimnastična abeceda*. Ljubljana: Fakulteta za šport Univerze v Ljubljani.
4. Živčić, K. (2007). *Akrobatska abeceda u sportskoj gimnastici*. Zagreb: Kineziološki fakultet Sveučilišta u Zagrebu.
5. Živčić Mrković, K. (2010). Uloga i značaj sportske gimnastike u razrednoj nastavi. *Zbornik radova Međimurskog veleučilišta u Čakovcu*, 2(1), 113-121.
6. Živčić Marković, K., Breslauer, N. (2011). *Opis nastavnih tema i kriteriji ocjenjivanja – tjelesna i zdravstvena kultura u razrednoj nastavi* - LIP Print, Zagreb.

## RELATIONSHIP BETWEEN MOTOR-FUNCTIONAL ABILITIES AND FUNDAMENTAL MOVEMENT SKILLS IN EIGHT YEAR-OLD CHILDREN

Frane Žuvela, Saša Krstulović and Danijela Kuna

*Faculty of Kinesiology, University of Split, Croatia*

### Abstract

This research is conducted to establish relationship between performance of fundamental movement skills and motor-functional abilities for eight years old boys and girls. 73 children were analyzed, including 36 boys and 37 girls, of average age  $8.09 \pm 0.25$  years. Children's fundamental movement skills were assessed with Test of Gross Motor Development – Second Edition – TGMD-2. Agility, explosive strength, endurance and speed are assessed by using set of five motor-functional tests. Correlation between fundamental movement skills and children's motor-functional abilities was confirmed by using Pearson's correlation coefficient with  $p < .05$ . The results of the research show that performance of fundamental movement skills of eight years old boys and girls is significantly related to motor-functional abilities.

**Key words:** TGMD-2, locomotor movement skill, manipulative movement skill, correlation

### Introduction

Fundamental movement skills (FMS) are defined as “common motor activities with specific patterns. They are the general skills that form the bases for the more advanced and more specific motor activities, such as sport skills” (Wickstrom, 1983). Fundamental movement skills are assumed to provide a framework upon which more complex skills develop. For example, the mature pattern of the movement skill of stationary ball dribbling is necessary for the development of more complex skills such as dribbling a ball while moving forward or the lay up in basketball that requires a combination of dribbling a ball, running and jumping. Former studies point to the fact that motor abilities are for the most part responsible for quality acquisition and performance of movement structures. The correlation of general motor abilities and fundamental movement skills has been repeatedly scientifically proven. Butterfield and Loovis (1998) confirmed the significant correlation between striking, catching, throwing and shooting skills which were assessed with the help of a test entitled “Ohio State University Scale of Intra-Gross Motor Assessment - OSU-SIGMA” with good results in the static and dynamic balance assessment test. Overlock and Yun (2006) also found the correlation between balance, and locomotor and manipulative fundamental movement skills of children aged 5-9. Motor development specialists (Wickstrom, 1983) agree that it is crucial that such FMS are learned during the “fundamental movement skill phase”. The fundamental movement phase goes from about 2 to 7 years-of-age and it is believed to be one of the most important periods within the motor skill development. However, there is a lack of studies which would determine the relationships of a number of motor abilities and fundamental movement skills in children of early school age.

Therefore, the main aim of this study was to determine the correlation between motor-functional abilities, and fundamental movement skills of eight-year-old boys and girls by applying the classic correlation analysis.

### Methods

**Subjects:** Seventy-three children (36 boys and 37 girls) aged 8 years old ( $8.09 \pm 0.25$ ) attending elementary schools in Split, Croatia participated in the investigation. They all gave verbal assent and their parents gave written informed consent.

**Motor-functional abilities:** A standard battery of 5 variables used to assess the motor-functional status of the children. The motor-functional variables included standing long jump (cm),  $\frac{1}{4}$  miles run (s), 30-m run (s), side-steps (s) and ball throwing (m).

**Fundamental movement skills:** Test TGMD-2 (Ulrich, 2000) is valid and reliable in school children and therefore was used in this study. The purpose of the TGMD-2 (Ulrich, 2000) is to measure the fundamental movement skills of children from 3 years to 10 years of age. The test is composed of two subtests that measure fundamental movement skills of children. Twelve fundamental movement skills are grouped into two subtests: locomotor subtest and manipulation subtest (MAN). Each skill has a set of performance criteria and the child's performance is assessed using a 0 or 1 for each trial.

**Proxy-questionnaire (Organized PA):** A proxy-questionnaire was adapted from the “Past Year Physical Activity Questionnaire”.

**Data analysis:** Data were analyzed using the Statistic for Windows 7.0 package and the statistical significance was set at  $P \leq 0.05$ . Basic descriptive statistics were calculated (mean value, standard deviation, skewness, kurtosis and Kolmogorov-Smirnov test). The association between the TGMD-2 test and motor-functional abilities was analyzed through the Pearson correlation coefficient ( $r$ ).

## Results

Table 1 shows the descriptive statistical parameters of variables for the assessment of fundamental movement skills and motor-functional abilities. The average value of the results of eight-year-old boys in the locomotor skills assessment subtest amounts to  $30.17 \pm 10.00$  points, and varies between 7 and 45 points, while the arithmetic mean in the manipulative (MAN) skills subtest totals  $30.75 \pm 8.03$ , and varies between 12 and 46 points. With regard to girls, the average value of the results of the locomotor skills assessment subtest amounts to  $30.78 \pm 7.42$  points, and varies between 15 and 43 points, while the arithmetic mean in the manipulative skills subtest totals  $23.43 \pm 7.11$ , and varies between 9 and 39 points. The results of both subtests for fundamental movement skills assessment for both sexes are consistent with the previous research (Urlich, 2000). The results of the Kolmogorov-Smirnov test (max, D) show that there is no statistically significant deviation from normal distribution in the assessment tests of locomotor and manipulative fundamental movement abilities and in the assessment tests of motor and functional abilities.

Table 1. Statistical parameters (mean, standard deviation – SD; minimal result – MIN; maximal result - MAX; KS test – max D) of motor variables for elementary school second-grade

	Boys (N=36)				Girls (N=37)			
	Mean±SD	Min	Max	Max D	Mean±SD	Min	Max	Max D
<b>Fundamental movement skills</b>								
Locomotor skills (points)	30.17±10.00	7.00	45.00	0.08	30.78±7.42	15.00	43.00	0.11
Manipulation skills (points)	30.75±8.03	12.00	46.00	0.10	23.43±7.11	9.00	39.00	0.13
<b>Motor-functional abilities</b>								
Standing long jump (cm)	126.92±17.78	89.33	176.67	0.07	122.94±11.70	91.00	147.00	0.12
20-m run (s)	4.46±0.34	3.84	5.05	0.13	4.62±0.29	4.07	5.28	0.08
Ball throwing - 200 g (m)	12.71±4.32	5.63	21.57	0.14	8.84±3.27	3.77	22.70	0.14
Side-steps (s)	11.63±5.25	8.99	15.59	0.09	12.30±1.28	9.95	15.49	0.05
¼ miles run (s)	137.92±18.86	101.20	173.60	0.14	143.13±22.20	108.56	196.46	0.13

max D = 0.154 for N=73

The results of the correlation analysis demonstrate that it is possible to determine a statistically significant correlation between the locomotor skills subtest and the manipulative skills subtest, and the result in all tests for the assessment of motor-functional abilities for boys and girls.

Table 2. Pearson correlation coefficients ( $r$ ) between motor-functional abilities and classification of boys and girls in each task in the TGMD-2 test

	Boys (N=36)				Girls (N=37)			
	Locomotor skills subtest		Manipulation skills subtest		Locomotor skills subtest		Manipulation skills subtest	
	$r$	$p$	$r$	$p$	$r$	$p$	$r$	$p$
<b>Motor-functional abilities</b>								
Standing long jump (cm)	0.81	0.001	0.68	0.001	0.36	0.030	0.55	0.001
20-m run (s) *	-0.78	0.001	-0.64	0.001	-0.67	0.001	-0.62	0.001
Ball throwing- 200 g (m)	0.68	0.001	0.71	0.001	0.38	0.022	0.57	0.001
Side-steps (s) *	-0.73	0.001	-0.78	0.001	-0.50	0.002	-0.56	0.001
¼ miles run (s) *	-0.62	0.001	-0.54	0.001	-0.68	0.001	-0.51	0.001

\* variable with the opposite metric orientation

## Discussion

This research analysed the correlation between motor-functional abilities and fundamental movement skills (TGMD-2) for boys and girls separately. The given results indicate that there is a statistically significant correlation between tests for fundamental movement skills assessment and all applied tests for motor-functional abilities assessment. The correlation between FMS and endurance test results (running ¼ of a mile) correspond to the results of the research conducted by Okely et al. (2001) stating that the performance of tasks which include the assessment of locomotor (running and jumping) and manipulative fundamental movement skills (catching, throwing, striking and shooting) are significantly correlated with the results of endurance tests of children aged 13 to 15. Significant correlation of results in motor abilities assessment tests (standing long jump, standing ball throw, sideways steps and a 20-meter run) and the results of locomotor and manipulative subtests of the TGMD-2 test is completely expected. To elaborate, the listed tests are an integral part of the "TGMD-2" test, but they are constructed for the purpose of performance process assessment. The existence of a significant correlation between quality and quantity assessment of fundamental movement skills has been proven in the studies of McIntyre, 2000. The author points to the significant correlation between distance and performance quality in children aged 7 and 12 during an over-the-shoulder ball throw. Although the correlation coefficient values for motor-functional abilities and fundamental movement skills are significant for both boys and girls, it is still necessary to emphasise that there are certain differences between sexes. Said differences are probably due to the type of organised physical activities in which boys and girls participate. From a total of 36 boys, 36% were involved in activities that are characterized by manipulation of objects (soccer); 28% attended activities in which moving and controlling the body in space is the main objective (dance, gymnastics, swimming, ballet); 22% participate in combat sports which are comprised of resistance overcoming (karate, taekwondo, judo); and 14% did not participate in any organized activities. On the other hand, from a total of 37 girls, only 3% were involved in activities that are characterized by manipulation of objects (soccer); 69% attended activities in which moving and controlling the body in space is the main objective (dance, gymnastics, swimming, ballet); 15% participate in combat sports which are comprised of resistance overcoming (karate, taekwondo, judo); and 13% did not participate in any organized activities.

The presented results show that there are important differences in the type of organised sporting activities between the sexes. Boys usually take part in activities in which manipulative kinesiological operators (sports games) prevail; while the girls mostly participate in activities where moving and controlling the body in space is the main objective. It can be assumed that children will generally use their spare time to participate in activities which they perform in an organised manner because they feel more comfortable in these activities. Therefore, most boys will probably be able to practice their favourite activities (football, basketball and the like) because they are more accessible, as opposed to the girls who do not have the opportunity to practice the elements of gymnastics, swimming, etc. in their free time. This is possibly the cause of a numerically greater correlation between motor-functional abilities and fundamental movement skills for boys than for girls.

## Conclusion

A research was carried out in order to determine the correlation between motor-functional abilities and fundamental movement skills of eight-year-old boys (N=36) and girls (N=37) by applying the classic correlation analysis. The entire subject sample underwent tests for the assessment of motor-functional abilities and of fundamental movement skills. The results indicate that fundamental movement skills are significantly correlated with motor-functional abilities in both sexes. This correlation is more expressed in boys, which is explained by the differences between sexes when choosing organised kinesiological activities and performing these activities in free time. Future studies should determine the trends and laws of correlation of analysed factors in children of different ages.

## References

1. Butterfield, S.A., & Loovis, E.M. (1998). Kicking, catching, throwing and striking development by children in grades k-8. *Journal of Human Movement Studies*, 34 (2), 67-81.
2. McIntyre, F. (2000). Gender differences and developmental trends in the overarm throw: *A qualitative and quantitative analysis*. Unpublished Honours, University of Western Australia, Perth.
3. Okely, A. D., Booth, M. L., & Patterson, J. W. (2001). Relationship of physical activity to fundamental movement skills among adolescents. *Medicine & Science in Sports & Exercise*, 33(11), 1899-1904.
4. Overlock, J.A., & Yun, J. (2006). The relationship between balance and fundamental motor skills in children. *Journal of Human Movement Studies*, 50 (1), 29-46.
5. Ulrich, D.A. (2000). *Test of Gross Motor Development* (2<sup>nd</sup> ed.). Austin, TX: Pro-ed.
6. Wickstrom, R.L. (1983). *Fundamental motor patterns* (3<sup>rd</sup> ed.). Philadelphia: Lea & Febiger.



# Kinesiological Recreation

**6<sup>th</sup> INTERNATIONAL  
SCIENTIFIC  
CONFERENCE ON  
KINESIOLOGY**

**“INTEGRATIVE POWER OF  
KINESIOLOGY”**

**Editor:**

**Prof. Mirna Andrijašević, PhD**

**Peer Reviewers:**

**Prof. Mirna Andrijašević, PhD**

**Prof. Mato Bartoluci, PhD**

**Prof. Herman Berčić, PhD**

**Sanja Ćurković, PhD**

**Prof. Stjepan Heimer, PhD**

**Prof. Ivan Prskalo, PhD**

**Prof. Donald Roberson, PhD**

**Sanela Škorić, PhD**



**Secretary:**

**Danijel Jurakić, PhD**



## CHARACTERISTICS AND LEVELS OF PHYSICAL ACTIVITY AMONG UNIVERSITY STUDENTS

Sanja Ćurković<sup>1</sup>, Mirna Andrijašević<sup>2</sup>, Romana Caput-Jogunica<sup>1</sup> and Nenad Zvonarek<sup>3</sup>

<sup>1</sup>Faculty of Agriculture, University of Zagreb, Croatia

<sup>2</sup>Faculty of Kinesiology, University of Zagreb, Croatia

<sup>3</sup>Faculty of Mechanical Engineering, University of Zagreb, Croatia

### Abstract

The aim of this study was to examine the level of physical engagement among university students and to explore possible differences between the students in physical activities by gender and age. An anonymous questionnaire of 48 variables was examined in 1646 students at the University of Zagreb, aged between 19 and 27. Data were analyzed by statistical analysis: using descriptive statistics,  $\chi^2$  analysis, logistic regression and multiple linear regression analysis. The results have shown that the student's population does not have a satisfactory level of physical activity which influences the preservation of health; it was noted that by maturing, young people are reducing their participation in sports - male students were significantly more active in comparison with female students and, there was no difference in physical activities by their age.

**Key words:** University students, physical activity, health

### Introduction

Modern living and working conditions significantly reduced physical activity (King et al., 2002; Saelens et al., 2003), dangerously increasing a number of obese individuals, thus influencing a development of various diseases associated with physical inactivity (Humpel et al., 2002; Van der Wilk and Jensen, 2005; Keating, 2005, Rhodes et al., 2006). Epidemiological studies showed a rapid decline in physical activity among young people aged between 18 and 24 (Kilpatrick et al., 2005, Ćurković, 2010). Research on the topic of physical activity among university students has been increased because of students' increased sedentary lifestyle. Majority of the research is made up of descriptive studies which reflect students participation in physical activities, changes related to physical activities and their determinants, and is related to intervention programs which promote physical activities among university students (Sparling & Snow, 2002, Nahas et al., 2003; Buckworth & Nigg, 2004). Researches show that between 35% and 70% of the student population (depending on the area of living) have not satisfied level of physical activity recommended by the World Health Organization (WHO, 2003). The researchers found that 84.7% of those who exercised regularly during the study, kept these habits for the following 5-10 years, while 81.3% of those who were not active, remained sedentary in their lifestyle (Sparling and Snow, 2002).

The aim of this study was to examine the level of physical activities among university students and to investigate whether engagement differs in physical activities by student's gender and age.

### Methods

The study included a total of 1646 student at the University of Zagreb (745 male and 901 female students), aged between 19 and 27, from different regions in Croatia. An anonymous questionnaire of the 48 variables was used, and that included current involvement in sport, individual preferences according to their physical activities, involvement in sports and recreational activities in the last month and the last seven days. Relative frequencies had to be calculated for each variable to arrive to a descriptive level.  $\chi^2$  analysis, logistic regression and multiple linear regression analysis were used to determine the difference in physical activities by sex and age.

## Results

Table 1. Participation in physical activities

PARTICIPATION IN PHYSICAL ACTIVITY	
Never involved in sports 8.7%	Recreational level 58.9%
	Actively involved in sports 32.4%
	Regional rank 20%
	National rank 9.2%
	International rank 3%
	member of the national team 0.2%

Based on the analysis for the whole area of physical activities we can safely say that 8.7% of university students were never involved in sports. The most common reasons for this are: students are not interested in sport and for most it was not possible to participate in desired sports where they grew up. The most participation in the recreational forms of physical activities was riding a bike, running, volleyball, aerobics and dance. Seasonal activities (depending on the season), 22.8% of students engaged in swimming, 15% diving, sledding 15.4%, ice skating 10.7% and 8.3% in skiing. Analysis of active participation in sport has shown that 32.4% of the students were or still are active athletes who participate in competitions of varying quality. Data on the cessation of sports in our study suggest that the initial exit from the sport happens between the ages of 13-14 (3.0%), growing at 9.0% with the ages of 15-16, and by the age of 17 16.2% of young athletes leave sports. Before enrolling into college, 28.2% of current students have dropped from sports activity, which indicates that only 4.2% of students are currently active in sports. The most common reasons for cessation from active sports are: the impossibility to harmonize the school and sports commitments (9.2%), injuries (8.1%) and inadequate training time (6.4%).

Analysis of the involvement in physical activities during the last month showed that 9.3% of students did not participate in any form of physical activity, while 70.5% were engaged in some physical activities between 2-12 times a month. Only 20.2% of those students were active at the recommended level (at least three times a week at a minimum of 30 minutes). Weekly engagement gives similar results, provided that the increased number of students in that period did any part in any form of physical activity (17.7%).

Differences by gender analysis showed that a higher number of female students never did sports and to were less active in sports (20.7% male compared to 11.4% female) while female students were more engaged in recreational activities (37.31% female and 21.5% male). Male students are much more involved in the following physical activities: soccer (13.65% versus 2.12%), basketball (8.90% versus 3.88%) and table tennis (8.73% versus 4.53%) and female students in riding a bike (23.44% versus 13.39%), rollerblading (11.03% versus 3.2%), volleyball (9.51% versus 4.40%), dance (17.08% vs. 2.84%), aerobics (16.09% versus 1.88%) and badminton (8.72% versus 3.02%). Results in physical activities such as running, hiking, tennis, rowing, scuba diving, diving, sailing and water skiing show that, a significantly higher number of girls had never participated in these activities. Male students are involved in sports at an earlier age (between 7 and 9 years old), do more sports, and many of them leave sports between the ages of 15 and 17.

Table 2. Active participation in sport

Active participation in sport	GENDER		x <sup>2</sup>	p
	M %	F %		
Earlier involvement in sport	9.02	4.36	104.9982	.0001
Weekly commitment: more than three times	14.84	8.96	111.2436	.0001
Daily workout 1-2 hours	11.69	7.15	112.1976	.0001
Out of sports between the 15 <sup>th</sup> and 17 <sup>th</sup> year	15.75	9.39	82.7698	.0001

In addition to  $\chi^2$  analysis, logistic regression analysis with gender as the criteria indicator variable (men were assigned value 1) and the physical activities as predictors were performed. The model with the predictor was significantly better than the initial model with the constant (3, N = 1646) = 105.311, p < 0,01; -2LL = 2161.722; which indicates that the basis of physical activity can reliably differentiate between subjects of different genders. However, based on an insight into physical activity as predictor, we obtained a relatively modest reduction of errors in forecasting to which gender respondent belonged to, while R<sup>2</sup> is only 0.083, which represents 8.30% of the variance by gender and measured participation in sports activities.

Table 3., 4. Model with and without predictor

Table3.		Hi2	df	P				
Model 1	Model	105.311	3	.000	Model	-2 Log likelihood	Cox & Snell R2	Nagelkerke R2
	Block	105.311	3	.000				
	Model	105.311	3	.000				
					1	2161.722 <sup>a</sup>	.062	.083

Table 5 shows regression coefficients (B) with standard error and statistical significance (Wald), as well as changes in the ratio of the likelihood that the respondent was male (OR).

Table 5. Logistic regression analysis of gender differences and sporting activities correlation.

		B	St. pog.	Wald	df	P	OR
Model 1 <sup>a</sup>	CURRENT ACT	+4.420	.062	45.759	1	.000	1.522
	MONTH ACT	.064	.075	.731	1	.393	1.066
	WEEK ACT	+1.154	.062	6.206	1	.013	1.167
	Constant	-1.807	.177	104.073	1	.000	.164

According to the Wald's criterion, two predictors were associated with respondent's gender: current activity and weekly activity. From the signs of regression coefficients (B) and changes in the ratio of the likelihood that the respondent was male (OR), it can be concluded that students had significantly higher scores in the variables of the current activity and weekly activity and, an increase of 52.2 % in the variable of current activity to the increase of 16.7% in the variable of the weekly activity, thus increasing the probability that the respondent is male. Whereas, the increase of the value in the monthly activity variable has no independent, statistically significant contributing factor for correct classification of subjects according to gender. Given the above, we may conclude that the current activity alone is the best predictor of genders. In addition, a multiple linear regression analysis was conducted to determine the age difference, with the age of subjects as the main criterion (expressed in years of life; higher score indicates the greater age of the respondents), and for the current sports activities we used predictor variables (higher score represents respondents that are more active in sports). Based on this analysis it was shown that the age was not significantly associated with sports activity ( $R^2 = .004$ ,  $F(3,1646) = 2.176$ ,  $p > .05$ ). According to the results shown in the Table 30, not a single measure of sports activity could be a significant predictor of age.

Table 6. Regression analysis of age and sports activities; coefficients and significance of predictors

Model	Not standardized coefficients		Standardized coefficients	t	p	
	B	Standard error				
1		20.378	.128	159.090	.000	
	CURRENTACT	.055	.046	.031	1.188	.235
	MONTHACT	.035	.058	.025	.608	.543
	WEEKACT	.026	.048	.023	.551	.582

## Discussion and conclusions

The results of this study indicate that the students' current engagements in sports activities are not satisfactory. From the total number of students in this survey 20.2% were active at the recommended level (at least 3 times a week at a minimum of 30 minutes) which is consistent with previous research, indicating high percentages of inactivity or low activity in this age group throughout the world (Sparling and Snow, 2002, Nahas et al., 2003; Buckworth and Nigg, 2004, Haase et al., 2004, Keating et al., 2005; Reed, 2007). DeWahla and associates' (2005) research showed a high presence of physically inactive students, particularly female students, which has been proven in this research. Similar to this study, Nelson and associates' (2007) research indicates a large drop out of the sport during high school. Gender differences were demonstrated by other researches. Buckwort and Nig (2004), Miller and colleagues (2005) suggest that gender is one of the better predictors when it comes to participation in sports. Everything that is linked to active participation in sports is also

associated with male students, which is confirmed by other researchers - Huang et al (2003) and Miller (2005). One of the reasons why men are more persistent in the sport could be friends – as a main motivation factor for men, it is important for them to belong to a group (Reed, 2007). For participation in recreational activities literature provides inconsistent results. While some argue that male students are much more involved in recreational physical activities, others deny it. The results of this study show that female students (37.3%) in comparison with male students (21.5%) are more inclined towards forms of recreational activities. Stone and colleagues (2002) and Buckwort and Nigg, (2004) suggest that male students prefer team sports and heavy duty work, while female students are more interested in programs such as aerobics, dance, yoga, cycling, which is in accordance with this research. Differences analysis in this study in physical activities by age showed no significant statistical differences, which is not in accordance with earlier investigations. Specifically, researches by Garman (2004), and Read and Phillips (2005) learned that younger students are more active than their older counterparts. These facts suggest the importance of motivating young people to persevere in physical activity programs. The reasons for this are numerous. On one hand, concern for health and maintenance of physical and mental fitness, improvement of satisfaction and self-esteem; on the other hand, prevention of weight gain and various diseases that occur as a result of physical inactivity combined with poor eating habits. Given that students are exposed to numerous social conditions and codes of conduct, institutions for higher education have a special environment in which it is possible to promote active lifestyle through physical activity and affect the consciousness of a large number of students. The data suggests a need for the research into areas of motivation to participate in physical activities, so that researchers could develop better programs and thus motivate students to engage in more physical activities.

## References

1. Buckworth, J., & Nigg, C. (2004). Physical activity, exercise and sedentary behavior in college students. *Journal of American College Health*, 53, 28-34.
2. Ćurković, S. (2010). Kineziološke aktivnosti i rizična ponašanja studenata. Disertacija, Kineziološki fakultet, Sveučilište u Zagrebu.
3. DeVahl, J., King, R., Williamson, J.W. (2005). Academic incentives for students can increase participation in and effectiveness of a physical activity program. *Journal of American College Health*, 53(6), 295-298.
4. Haase, A., Steptoe, A., Sallis, J.F., Wardle, J. (2004). Leisure-time physical activity in university students from 23 countries: Associations with health beliefs, risk awareness and national economic development. *Preventive Medicine*, 39, 182-190.
5. Garman, J.F., Hayduk, D.M., Crider, D.A., Hodel, M.M. (2004). Occurrence of exercise dependence in a college-aged population. *Journal of American College Health*, 52, 221-228.
6. Humpel, N., Owen, N., Leslie, E. (2002). Environmental factors associated with adult's participation in physical activity: a review. *American Journal of Preventive Medicine*, 22, 188-199.
7. Keating, D.X., Guan, J., Pinero, H.C., Bridges, D.M. (2005). A meta-analysis of College Students Physical Activity Behaviors. *Journal of American College Health*, 54, (2), 116-125.
8. Kilpatrick, M., Hebert, E., Bartholomew, J. (2005). College Students' Motivation for Physical Activity: Differentiating Men's and Women's Motives for Sport Participation and Exercise. *Journal of American College Health*, 54 (2), 87-94.
9. Nahas, M.V., Goldfine, B., Collins, M.A (2003). Determinants of PA in adolescents and young adults: the basis for high school and college physical education to promote active lifestyles. *Physical Educator*, 60(1), 42-56.
10. Nelson, T.F., Gortmaker, S.L., Subramanian, S.V., Wechsler, H. (2007). Vigorous physical activity among college students in the United States. *Journal of Physical Activity & Health*, 4(4), 495-508.
11. Miller, K., Staten, R.R., Rayens, M.K., Noland, M. (2005). Levels and characteristics of physical activity among a college students cohort. *American Journal of Health Education*, 36, 215-220.
12. Reed, J.A. (2007). Perception of the availability of recreational physical activity facilities on a university campus. *Journal of American College Health*, 55(4), 189-194.
13. Read, J.A., Phillips, D.A. (2005). Relationships between physical activity and the proximity of exercise facilities and home exercise equipment utilized by undergraduate university students. *Journal of American College Health*, 53(6), 285-290.
14. Rhodes, R.E., Blanchard, C.M., Matheson, D.H. (2006). A multicomponent model of the theory of planned behavior. *British Journal of Health Psychology*, 11, 119-137.
15. Sparling, P.B., Snow, T.K. (2002). Physical activity patterns in recent college alumni. *Research Quarterly in Exercise and Sport*, 73, 200-205.
16. Van der Wilk, E.A., Jansen, J. (2005). Lifestyle-related risks: Are trend in Europe converging? *Public Health*, 119, 55-66.
17. World Health Organization (2003). *The European Health Report 2002*. Available at: <http://www.who.dk/europeanhealth-report>. Copenhagen: WHO Regional Office

## ASSESS THE STATE OF POSTURE, PHYSICAL FITNESS AND MENTAL HEALTH OF STUDENT OF THE UNIVERSITY

Alena Cepková

*Department of Physical Education and Sport, Faculty of Mechanical Engineering, Slovak Technical University, Bratislava*

### Abstract

The paper is to present the state of posture college students and their physical fitness and mental health. The hours of compulsory physical education are an important factor in influencing the quality of human life - student university. Very important to confirm the positive impact of physical activity on the current mental state, which encourages students to play an active approach to the sport and raise awareness of their own health and indirectly to improving physical fitness. Students with better posture were more resistant to stress and mental stress, they were more balanced.

**Key words:** *Mattias test, UNIFITTEST (60-60), CMS*

### Introduction

Dynamics of changes in the way of life increases the demand for social adaptability of humans to the changed and changing living conditions. To such belongs the transition to university studies. Increases the psychological stress, reduce the demand for movement and physical exertion. Predominant sedentary lifestyle. For university students dominated activities focused on education, in order to acquiring knowledge in specialized fields. Physical education is in many cases the only area that is active during the study of their physical development. Assessment of the state of physical development, physical fitness of students is an important part in terms of comprehensive development of students. The proof is on the various research works (Cepková 2008, Zidek 2009), in which the authors evaluate the dynamic level of physical fitness and physical development of university at age group. Equally important is the evaluation of students' posture. Through physical education and sports activities can also influence the acquisition of habituation correct posture. When negative habits can develop various health problems - headaches, loss of appetite, difficulty breathing, abdominal pressure in the belly and below. The upright posture is a typical manifestation of man and represents his whole personality. And reflects the state of emergency throughout the body to adapt to living conditions. Posture is the result of a particular shape of the spine, particularly the work of postural muscles, postural reflexes and function of the spine.

### Objective

The paper is to present the state of posture college students and their physical fitness and mental health.

### Methodology

Object of investigation was a students from FME STU Bratislava. Overall, we were 4 measurements: A - first at the beginning of the 2.semester academics year 2008/09, the number of students was  $n = 320$ , B - a second measurement was performed in 1. semester next academic year, the number of students was  $n = 238$ , C - third measurement was performed at the beginning of the second semester academic year 2009/2010, where the number of students was  $n = 267$  and the last was performed in D - 4. Measurement in 1.semester ac.year 2010/2011  $n = 194$ . Testing conducted on the hour of physical education, at the beginning of the semester. Content of the physical education was football, hockey, fitness enhancing, basketball, table tennis, fives.

Clap prowess, we have searched UNIFITTEST (Mekota, Smith, 1995). Dynamic strength of the legs - jumping from place, to determine the dynamic power of hip-abdominal muscles, we used light set for 30s and 60s., arm strength we tested by the pull-ups on horizontal bar. Endurance capacity was evaluated during the shuttle run. Good posture, we have searched by Matthias test (Fig. 1). Students was asked to take the following posture: standing erect with slightly you legs shoulder width apart, arms held in forward, head in the trunk extension. After one minute, we evaluated posture. Number 1, we evaluated the correct posture and 0 incorrect posture according to Fig.1. Observed data were processed statistically and undergo substantive and logical analysis. For comparison of individual files, we used t-test. The table 1 levels of statistical significance: (\*)  $p < 0.10$ , \*\*  $p < 0.01$ , \*  $p < 0.05$ ,  $n$  = number of students, 0 = incorrect posture, 1 = good posture. A group of students were first and 2<sup>nd</sup> class, B = 2 class and 3 class, C = first and 2<sup>nd</sup> class and D = 2 class and 3 class. On each hour PE we tested the current mental state (CMS).

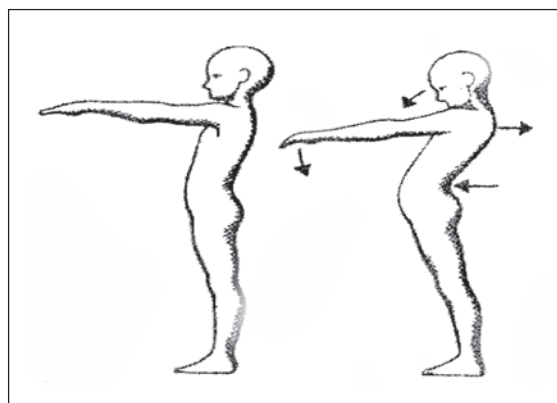

Figure 1. Test by Mattias

## Results

Posture is the result of a particular shape of the spine, particularly the work of postural muscles, postural reflexes and function of the spine. Is an inherent feature of all activities and of itself is an activity, exercise habits, which we largely control our will. Test by Mattias (Fig. 1), we evaluated students' posture in which prevailing sedentary lifestyle focused mainly on the study. Is there some wrong habits in posture. Nevertheless, we found that most students have good posture. Even assuming that the assessment by Mattias reveal deficiencies, which can be detected at a more detailed assessment of posture by other methods such as under Jaroš- Lomnička and others. Table 1 gives us a detailed review and distribution of students at each test and the individual grades in the right (1) and incorrect posture (0). We can say that in almost all

Table 1. Posture and physical fitness

	BH	BW	BMI	waist circum.	Hip circum.	WHR	Lie-sit30s	Lie-sit60s	Jump from place	Schuttle-run	Pull-ups	%fat
A 1roč. 0 n=53	181,0	76,98	23,49	80,89	94,62	0,85	25,74		211,4	49,40		
A 1roč. 1 n=122	181,4	76,88	23,34	82,25	96,43	0,85	26,61		216,9	51,78		
t - test	0,376	0,045	0,246	0,823	1,234	0,15	1,243		1,275	0,914		
A 2roč. 0 n=42	184,5	79,50	23,31	82,00	96,52	0,85	25,10		214,1	49,43		
A 2roč. 1 n=103	181,7	79,03	23,91	84,92	98,18	0,87	26,53		216,6	50,25		
t - test	<b>2,188*</b>	0,206	1,089	<b>1,823(*)</b>	1,094	0,92	<b>1,861(*)</b>		0,592	0,292		
B 2roč. 0 n=29	180,4	78,19	23,99	82,31	95,97	0,86	25,31	44,21	210,2	48,28	6,69	
B 2roč. 1 n=119	181,7	77,38	23,43	81,61	95,18	0,86	26,39	42,52	217,6	54,41	7,07	
t - test	0,966	0,264	0,627	0,39	0,507	0,13	1,31	1,12	1,382	<b>1,846(*)</b>	0,44	
B 3roč. 0 n=35	182,1	80,86	24,36	82,09	97,74	0,84	25,74	41,91	211,2	50,20	7,09	
B 3roč. 1 n=55	184,2	79,00	23,30	80,64	95,35	0,85	26,56	40,89	218,1	55,56	7,07	
t - test	1,383	0,758	1,586	0,82	1,424	0,60	0,94	0,64	1,261	<b>1,852(*)</b>	0,02	
C 1roč. 0 n=25	184,7	83,64	24,44	82,92	99,28	0,83	24,24	40,56	206,3	51,08	3,76	
C 1roč. 1 n=91	181,9	76,98	23,25	82,15	97,26	0,84	25,73	43,38	212,7	58,22	6,08	
t - test	<b>1,863(*)</b>	<b>2,173*</b>	1,426	0,35	1,149	1,01	1,37	1,64	1,024	1,621	<b>3,042**</b>	
C 2roč. 0 n=32	187,0	83,78	23,86	86,81	100,47	0,86	24,66	41,94	209,5	43,16	5,03	
C 2roč. 1 n=119	181,3	77,76	23,67	82,24	96,19	0,86	26,08	42,06	220,9	48,05	6,38	
t - test	<b>4,465**</b>	<b>2,827**</b>	0,357	<b>2,817**</b>	<b>3,127**</b>	0,72	1,59	0,08	<b>2,301*</b>	<b>2,146*</b>	<b>1,742(*)</b>	
D 2roč. 0 n=15	177,4	76,47	24,22	83,13	97,4667	0,85	24,13	43,40	222,0	52,40	6,00	12,91
D 2roč. 1 n=66	182,12	79,44	23,76	84,21	98,2727	0,86	25,80	42,67	219,5	54,70	5,32	12,09
t - test	<b>2,452*</b>	0,862	0,494	0,42	0,386	0,16	0,97	0,36	0,374	0,530	0,60	0,54
D 3roč. 0 n=37	180,16	80,54	24,8579	86,95	100,0	0,87	25,11	45,32	202,89	43,22	5,70	14,21
D 3roč. 1 n=76	181,64	76,9	23,50	81,88	96,5263	0,85	24,41	41,25	214,36	46,30	7,51	12,11
t - test	1,109	1,454	<b>1,931(*)</b>	<b>2,803**</b>	<b>2,803**</b>	<b>1,875(*)</b>	0,683	<b>2,094*</b>	<b>2,100*</b>	1,065	1,28	<b>1,945(*)</b>

measurements, we found that students with better posture (1) also had better values than the physical development of students with poor posture (0). Only in some indicators of the opposite situation. The measurements in A 2 class we found that students with good posture (1) had significantly greater circumferential extent  $p < 0.10$ . In most cases the students the correct posture (1) lower than with poor posture (0), significantly in A 2 class,  $p < 0.01$  C 1 class  $p < 0.10$  and C 2 class  $p < 0.01$  and 1 Students with (1) have less value in the most peripheral rates in C1 and C 2 class  $p < 0.01$ , which also had significantly lower weight with students (1) as (0)  $p < 0.01$ . We found that in most measurements of students with correct posture to achieve better results in motor tests than students with poor posture. The most significant differences can be seen in A 2 class S-30s for L  $p < 0.10$ , in B 2 class, in B 3 class  $p < 0.10$  and C 2 class shuttle run  $p < 0.05$ . The jump from the place were significantly more students with (1) and especially in C 2 class and D 3 class  $p < 0.05$ . Pull-ups in the test were significantly better student with an attitude (1) the measurement of C 1 class  $p < 0.01$  and C 2 class  $p < 0.10$ . For assessment of physical fitness test battery was used UNIFITTEST (60-60):

- explosive power unit capacity - Jump from place. We have found that student achievement in all three measurements of nearly the same average value. In A reached 215.5 cm, in B reached 215.9 cm in C reached 215.4 cm and in D reached 214.5 cm. There were no statistically significant change between each measurement. According to the standard 5-point UNIFITTEST (21-60), FME students evaluated in this test than the average. Significant difference to the detriment of our students, we found among our probands and university students in Czechoslovakia, 1986 (Kolar, Mekota, Sorm, 1989), which reached an average value in the long jump 231.55 cm. (Table 2).
- Endurance capacity power unit in the abdominal area - Lie-sit for 30s and 60s. Lie-sit in the 60s we started to evaluate the second measurement (B). In the test lie-sit 30s, we found significant changes between measurements, without statistical significance. The measured and found to average 26.24 repeats, 26.20 in B, C in D 24.99 and 25.61 times. In the test lie-sit 60s, the average value 42.26 B, C in D 42.68 and 42.36 times. According to the standard 5-point UNIFITTESTU (21-60), FME students evaluated in this test than the average. In this test, reached the same level as students Palacky Univesity (Mekota, 1991-unpublished), who achieved an average 42.54 repeated/60s. (Table 2).
- aerobic endurance ability was tested during the endurance shuttle run. We found that the average overrun sections, the individual terms differ significantly. And when measuring the mean overrun sections 50.58, we found the largest number of overrun sections - 53.31 - in C, the decrease took place at 51.21 and 49.04 D, the lowest overrun sections. (Table 3).
- power arm - Pull-ups. This test was launched from the second measurement. Found average values in B were 7 reps, in C the number of repetitions decreased to 5.8 and in D were 6 repetitions. According to the standard 5-point UNIFITTESTU (21-60), FME students evaluated in B than average. In C and D compared to those among below average. Students Czechoslovak universities, 1986 (Kolar, Mekota, Sorm, 1989), reached an average of 6.66 repetitions, which is under UNIFITTEST value classified as substandard. (Table3).

Table 2. Physical fitness

	Lie-sit30s				Lie-sit60s				Jump from place			
	A	B	C	D	A	B	C	D	A	B	C	D
aritm.pr	26,24	26,20	25,61	24,99		42,26	42,36	42,68	215,5	215,9	215,4	214,5
smer.od.	4,26	4,00	4,64	5,50		7,33	7,79	8,81	24,94	25,76	26,49	25,61
median	26,0	27,0	26,0	25,0		41,0	42,0	42,0	217,0	219,0	220,0	217,0
min.	15,0	14,0	5,0	14		22,0	22,0	25	135,0	136,0	114,0	105
max.	39,0	38,0	40,0	66		61,0	66,0	97	284,0	290,0	273,0	279
var.rozp.	24,0	24,0	35,0	52		39,0	44,0	72	149,0	154,0	159,0	174
t - test		0,110	1,515	1,308		0,387	0,141	0,411		0,161	0,224	0,342

Table 3. Physical fitness

	Schuttle-run				Pull-ups			
	A	B	C	D	A	B	C	D
aritm.pr	50,58	53,31	51,21	49,04		7,025	5,869	6,304
smer.od.	15,61	15,22	16,30	15,34		4,104	3,735	6,009
median	50,0	50,0	50,0	48,0		7,0	5,0	5,0
min.	16,0	16,0	20,0	17		0,0	0,0	0
max.	99,0	110,0	125,0	95		20,0	23,0	60
var.rozp.	83,0	94,0	105,0	78		20,0	23,0	60
t - test		2,062*	1,489	1,448			3,315**	0,956

In assessing current psychological states, we found that most student, more than 80%, had an hour before a negative current mental condition. This means that they were no mood, sad, nothing they did not want and only 20% had almost before an hour TV cheerful, active. After hours up to 67% of students are marked curent mental state (CMS) as excellent, happy, cheerful, with vigor and only 20% are marked CMS as sad, tired. These results show us that hours of physical education have a positive effect on students' current mental state. Games on the Physical Education reduced stress and mental fatigue. Good mental well-being can affect the quality of education.

Table 4. Curent mental state

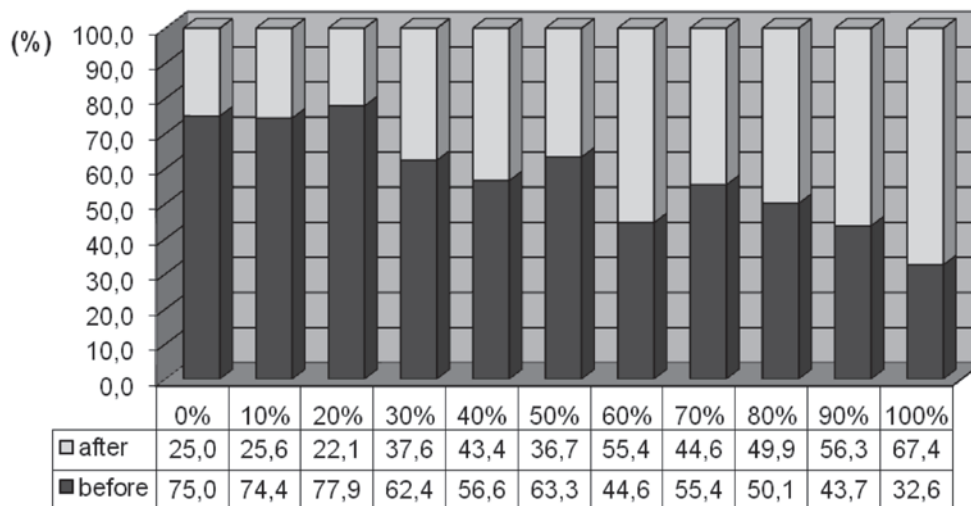

### Conclusion

For everyone, it is important to maintain good posture and continuously improve the exercise habits of a lifetime. Education on proper posture is to be understood not only as a process of keeping the resting position, but as education and raised capacity to deal with physical tasks of daily life at school, at home, at work (sit, lie, learn, run, jump, draw, cook, etc. ). Based on the results we can conclude that for most students FME STU we found incorrect posture. Despite the prevailing sedentary students, when there is a study of low demands on the body, leading to hypokinesy. The threshold energy is expected to fall right in activities under 4.1 kJ.min-1 (Mekota, Cuberek, 2007). Physical activity to them in most cases, guaranteed school physical education. FME STU students prefer mostly games - football, hockey, basketball, fresbee and bodybuilding. Individual measurements are documented, that during the study to students with no significant changes in tests. We found that students belong to a group of people, with almost no risk cardiovascular diseases and diseases resulting from obesity. The 5-point standard lie-set60s was 40 to 42 repetitions, jumping from place to achieve an average of 215 cm in pull-ups made from 5 to 7 bends. Probands were specific sample of students with mostly psychological employment. Their professional focus does not require general or special physical training, motor development fitness. It is realizing the importance of each individual's daily physical activity for health is important. You just mandatory physical education in college, where physical education teachers have the possibility and also role and motivates students to learn to regular physical activity. This study also confirmed by various authors (Palovičová, J, 2001, Buková, A. 2008).We can talk about health-oriented physical activity for students. This means that their current status in college does not get worse, but that was its maintenance. In conclusion, the hours of compulsory physical education are an important factor in influencing the quality of human life - student university. Very important to confirm the positive impact of physical activity on the current mental state, which encourages students to play an active approach to the sport and raise awareness of their own health and indirectly to improving physical fitness. Students with better posture were more resistant to stress and mental stress, they were more balanced.



## References

1. Cepkova, A. (2007). Physical development and functional ability students FME STU Bratislava. In: Physical education, sport and research at universities, Bratislava: STU.
2. Buková, A-Staško, I-Gajdošová, B. (2008). Physical activity UPJŠ students. In: Physical education and sport, health and movement. Proceedings of 2 grade science - pedagogical conferences teachers TV. Prešov: s. 132 – 136. ISBN 978-80-8045-515-6.
3. Zidek, J. (2007). Physical and functional development of students FME STU Bratislava. In: Curricular Transformation of Education in Physical Education and Sport n Slovakia. Nitra.
4. Kolar, V., Měkota, K., Sorm, G.(1989). Motor performance and physical development of students in 1<sup>st</sup> year university Czechoslovakia 1986. In.: Physical Culture - Proceedings of members' work departments of Physical Education and Sports Medicine 21<sup>st</sup> Olomouc, Univ. Palackého, 5-63.
5. Měkota, K., Smith, R. et al. (1996). UNIFITTEST. Prague, Faculty of Education, University of Ostrava, 94s.
6. Mekota, K., Cuberek, R. ( 2007). Physical skills, work-performance. Palackého University, Olomouc, p. 163
7. Palovičová, J. (2003). Regular physical activity in daily mode at students at the university. In.: Current status and trends of university sport and physical education before joining the European Union. Bratislava. Mff KTVS UK, SAUŠ, p. 52 – 56. ISBN 80-223-1880-9.

## PHYSICAL ACTIVITY AND BARRIERS TO EXERCISE AMONG STUDENTS FROM FACULTY OF PHILOSOPHY IN ZAGREB

Lucija Mudronja, Tin Petračić and Željko Pedišić

*Faculty of Kinesiology, University of Zagreb, Croatia*

### Abstract

From the public health point of view, it is important to track the prevalence and major determinants of insufficient physical activity in specific subpopulations. Therefore, the aim of this study was to estimate physical activity level of students from the Faculty of Philosophy in Zagreb and to assess their barriers to exercise. The survey was conducted on a stratified random sample of 134 students from the Faculty of Philosophy in Zagreb, using International Physical Activity Questionnaire – IPAQ and 14 items regarding perceived barriers to exercise. Leisure time energy expenditure was 13.20 and 15.30 MET-hour/week among female and male students, respectively, which could be considered adequate. The most salient barriers were “I am too lazy” and “Exercise interferes with my studies”. Future physical activity promotion programs in this subpopulation should be primarily based on behavioral and social approaches.

**Key words:** *Exercise, Obstacles, College Students, IPAQ*

### Introduction

Regular physical activity has been widely recognized as a highly important health behaviour. Each year an increasing number of studies is published confirming different health benefits of physical activity (Bauman, 2004). Despite the strong evidence on the benefits, the prevalence of insufficient physical activity in Europe is still high. The prevalence rates of insufficient physical activity in the general population of European countries range from 56 to 77% (Sjöström et al., 2006). This undesirable behaviour is highly prevalent in Croatia as well. Jurakić et al. (2009) found that more than 50% of Croatian inhabitants did not meet the current physical activity recommendations, i.e. at least 30 minutes of moderate-intensity physical activity 5 days a week or 20 minutes of vigorous-intensity physical activity 3 days a week (Haskell et al., 2007).

From the public health point of view, it is important to regularly track the prevalence and major determinants of insufficient physical activity in specific subpopulations. The current information about physical activity patterns and correlates is needed to properly tailor physical activity promotion programmes. A suitable target population for conducting physical activity interventions are, among others, college students (Leslie et al., 2000; Mack & Fotheringham, 2004; Ince, 2008), since they can be easily reached in a university setting, i.e. student dormitories and university facilities, which is essential for effective physical activity promotion.

Studies have shown that the prevalence rates of insufficient physical activity in different populations of university students range from 30 to 60% (Irwin, 2004). The most recent data on the physical activity level in Croatian students were published in the article by Andrijašević et al (2005). Therefore, the current physical activity level of Croatian students is relatively unknown. Since Andrijašević et al., (2005) have used a sample of students only from selected departments of the University of Split (Faculty of Maritime Studies, Faculty of Economics, Academy of Arts, Teacher Education Academy, Faculty of Medicine, and Academy of Pedagogy – Preschool Education Department), physical activity level of students from other colleges could only be roughly estimated. Besides, that study assessed only the frequency of exercising rather than the total level of physical activity, i.e. the sum of activities in the domains of leisure, household, transport, and work. Furthermore, studies on college students show that perceived barriers to exercise are among the most important determinants of physical activity (Grubbs & Carter, 2002; Brown et al., 2006). Also, studies show that the most salient barriers to exercise among college students are the lack of: time, energy, motivation, social support, and exercise facilities (Daskapan et al., 2006; Lovell et al., 2010). To our knowledge, there are no data about barriers to exercise in Croatian university students.

Therefore, the aim of this study was to estimate the physical activity level in a cohort of Croatian university students from different departments of the Faculty of Philosophy in Zagreb and to assess their barriers to exercise.

## Methods

This study was a part of a larger research project entitled “Physically Active Students”. Within this project, a questionnaire survey was conducted on a stratified random sample of 1163 students living in dormitories in Zagreb, with stratification performed according to dormitory (5 student dormitories in Zagreb) and gender. The survey was conducted during July 2009. For the purpose of this study we used only a subsample of students from the Faculty of Philosophy in Zagreb. This faculty is one of the largest in Zagreb and consists of 23 independent study programs such as anthropology, history, psychology, sociology, linguistic studies, etc. The total number of participants in this study was 134 (83% females). The participation in the survey was anonymous and voluntary. The survey protocol was approved by the Scientific and Ethics Committee of Faculty of Kinesiology, University of Zagreb.

The physical activity level was estimated by a long version of the International Physical Activity Questionnaire (IPAQ) (Craig et al., 2003). The long IPAQ consists of 27 questions regarding physical activity in 4 domains (work, transport, domestic & garden, and leisure-time) and provides separate domain-specific scores in metabolic equivalent-minutes per week (MET hours/week). Barriers to exercise were assessed using a questionnaire developed by Steinhardt & Dishman (1989). The questionnaire contains 14 statements with a response options on a five-point Likert scale, where 1 indicates “strongly disagree” and 5 indicates “strongly agree”. Typical examples of statements in the questionnaire are: “The major reason when I do not exercise is that exercise is boring” and “The major reason when I do not exercise is that I have family obligations”. Finally, we used separate questions to collect the data on demographics and selected biological characteristics of our sample.

Statistical analyses were performed by STATISTICA 8 (StatSoft, Inc., Tulsa, OK, USA). According to official IPAQ scoring protocol, we used median  $\pm$  interquartile range to present the data on physical activity in each domain and overall physical activity. According to Steinhardt & Dishman (1989), results regarding barriers to exercise are presented as mean  $\pm$  standard deviation. In order to test gender differences in physical activity and barriers to exercise we used Mann-Whitney U test and unpaired t-test, respectively.

## Results

The mean age of the students in our sample was  $21.87 \pm 1.82$  years, with the largest number of them being sophomores (34.3%), followed by seniors (29.1%), juniors (21.6%), freshmen (14.9%) and postgraduate students (1.5%). Average body mass index (BMI) (calculated according to self-reported height and weight) was  $21.59 \pm 2.72$ . A large majority of students had normal BMI (84.3%), 6.0% were underweight, 6.0% overweight and 3.0% obese.

The highest physical activity level was found in the transport domain for both genders (Table 1). Namely, nearly 50% of total energy expenditure was aggregated in the transport domain. Female and male students did not differ significantly in work, transport, leisure and total physical activity. The only significant difference was found in the domestic & garden domain, where female students had two times higher energy expenditure than male students (6.00 vs. 3.00 MET-hour/week).

Table 1. Total and domain specific physical activity levels of university students

Domain	Physical activity (MET-hour/week)		p <sup>†</sup>
	females	males	
work	0.00 $\pm$ 0.00	0.00 $\pm$ 0.00	0.809
transport	19.80 $\pm$ 29.70	23.10 $\pm$ 28.05	0.761
domestic & garden	6.00 $\pm$ 16.50	3.00 $\pm$ 3.67	0.040
leisure	13.20 $\pm$ 37.90	15.30 $\pm$ 21.45	0.635
total PA	49.65 $\pm$ 73.20	41.60 $\pm$ 44.55	0.514

\*median  $\pm$  interquartile range

†p value according to Mann-Whitney U test

The most salient barriers to exercise among female students were: “I am too lazy” (3.83  $\pm$  1.28), “Exercise interferes with my studies” (3.60  $\pm$  1.23), “I am too busy” (3.51  $\pm$  1.29), “I do not have enough time to exercise” (3.13  $\pm$  1.41), and “Lack of facilities” (2.95  $\pm$  1.40). Male students evaluated their barriers to exercise almost equally as female students. Namely, male students perceived “Exercise interferes with my studies” (3.65  $\pm$  1.19), “I am too busy” (3.43  $\pm$  1.20), “I am too lazy” (3.35  $\pm$  1.27), “I do not have enough time to exercise” (3.13  $\pm$  1.29), and “Lack of motivation” (3.00  $\pm$  1.09) as the most important barriers. Moreover, male and female students evaluated only two barriers significantly different. Namely, male students attributed greater importance to “Limiting health reason” and “Family obligations” than females (p<0.01).

Table 2. Barriers to exercise as perceived by university students

Barrier	mean $\pm$ standard deviation		p'
	females	males	
Too lazy	3.83 $\pm$ 1.28	3.35 $\pm$ 1.27	0.102
Interferes with studies	3.60 $\pm$ 1.23	3.65 $\pm$ 1.19	0.863
Interferes with work	2.57 $\pm$ 1.43	2.70 $\pm$ 1.11	0.686
Too fatigued by exercise	1.87 $\pm$ 1.15	1.96 $\pm$ 0.98	0.748
Too inconvenient	1.89 $\pm$ 1.22	2.35 $\pm$ 1.19	0.105
Too busy	3.51 $\pm$ 1.29	3.43 $\pm$ 1.20	0.788
Exercise is boring	1.99 $\pm$ 1.29	2.04 $\pm$ 1.07	0.855
Too tired	2.81 $\pm$ 1.31	2.91 $\pm$ 0.95	0.723
Lack of motivation	2.92 $\pm$ 1.40	3.00 $\pm$ 1.09	0.792
Bad weather	2.16 $\pm$ 1.16	2.35 $\pm$ 0.98	0.477
Limiting health reason	1.53 $\pm$ 0.93	2.17 $\pm$ 1.15	0.004
Family obligations	1.42 $\pm$ 0.83	2.04 $\pm$ 1.15	0.003
Not enough time	3.13 $\pm$ 1.41	3.13 $\pm$ 1.29	0.989
Lack of facilities	2.95 $\pm$ 1.40	2.74 $\pm$ 1.10	0.506
Barrier - average	2.57 $\pm$ 0.65	2.70 $\pm$ 0.51	0.376

\*p value according to unpaired t-test

## Discussion and conclusions

Overall energy expenditure in both male and female students was lower than in Croatian general population (Jurakić et al., 2009). This finding was expected taking into account the almost zero physical activity of students in the work domain. On the other hand, leisure time physical activity among students was more than two times higher than in the general population (Jurakić et al., 2009). Leisure time physical activity was significantly higher among students than in the general youth population (15-24 years old), too. This might be partially explained by higher health awareness, which is expected due to their high level of education. The determined levels of physical activity in leisure domain could be considered quite high for both genders. Leisure time energy expenditure of 13.20 MET-hour/week, which was assessed among female students, is equivalent to 40 minutes of moderate intensity physical activity 5 days per week. Likewise, leisure time energy expenditure of 15.30 MET-hour/week, which was assessed among male students, is equivalent to approximately 46 minutes of moderate intensity physical activity 5 days per week. According to ACSM/AHA (American College of Sports Medicine/American Heart Association) guidelines, these levels of physical activity could be considered as sufficient for achieving health benefits (Haskell et al., 2007).

Total physical activity of Croatian students was significantly higher when compared with Turkish students (Cengiz et al., 2009). This could be a consequence of somewhat different questionnaires used for physical activity assessment. We used the long version IPAQ, while Cengiz et al. (2009) used the short version. However, leisure time physical activity in our sample was similar to that of the college students in the USA. Namely, Reed & Phillips (2005) reported an average of 44 and 57 minutes of daily leisure time physical activity among female and male students, respectively.

Students in our sample perceived similar barriers to exercise as Turkish students (Daskapan et al., 2006), but quite different than students in the USA (Grubbs & Carter, 2002) and England (Lovell et al., 2010). One of the most salient barriers perceived by American and English students was "I get too fatigued by exercise". This barrier was perceived as one of the least important by Croatian students. The high importance of the barrier "Lack of time", i.e. "I do not have enough time to exercise" was found by all the mentioned studies.

In conclusion, physical activity level of the majority of students from the Faculty of Philosophy in Zagreb could be considered adequate. Since great importance was attributed to the barriers "I am too busy", "I do not have enough time to exercise" and "I am too lazy", future physical activity promotion programs among these students should be primarily based on behavioral and social approaches.

## References

1. Andrijašević, M., Paušić, J., Bavčević, T., & Ciliga, D. (2005). Participation in leisure activities and self-perception of health in the students of the University of Split. *Kinesiology*, 37(1), 21-31.
2. Bauman, A.E. (2004). Updating the evidence that physical activity is good for health – an epidemiological review 2000-2003. *Journal of Science and Medicine in Sport*, 7(1), S6-S19.
3. Brown, S., Huber, D., & Bergman, A. (2006). A perceived benefits and barriers scale for strenuous physical activity in college students. *American Journal of Health Promotion*, 21(2), 137-140.
4. Cengiz, C., Ince, M., & Çiçek, S. (2009). Exercise stages of change in Turkish university students by sex, residence, and department. *Perceptual And Motor Skills*, 108(2), 411-421.
5. Craig, C.L., Marshall, A.L., Sjöström, M., i sur. (2003). International Physical Activity Questionnaire: 12-Country Reliability and Validity. *Medicine & Science in Sports & Exercise*, 35(8), 1381-1395.
6. Daskapan, A., Tuzun, E.H., Eker, L. (2006). Perceived barriers to physical activity in university students. *Journal Of Sports Science And Medicine*, 5(4), 615-620.
7. Grubbs, L., & Carter, J. (2002). The relationship of perceived benefits and barriers to reported exercise behaviors in college undergraduates. *Family & Community Health*, 25(2), 76-84.
8. Haskell, W.L., Lee, I.M., Pate, R. i sur. (2007). Physical Activity and Public Health: Updated Recommendation for Adults from the American College of Sports Medicine and the American Heart Association. *Medicine & Science in Sports & Exercise*, 39(8), 1423-1434.
9. Ince, M. (2008). Use of a social cognitive theory-based physical-activity intervention on health promoting behaviors of university students. *Perceptual & Motor Skills*, 107(3), 833-836.
10. Jurakić, D., Pedišić, Ž., Andrijašević, M. (2009). Physical Activity of Croatian Population: Cross-sectional Study Using International Physical Activity Questionnaire. *Croatian Medical Journal*, 50(2), 165-173.
11. Leslie, E., Fotheringham, M., Veitch, J., & Owen, N. (2000). A university campus physical activity promotion program. *Health Promotion Journal of Australia*, 10(1), 51-54.
12. Lovell, G., El Ansari, W., & Parker, J. (2010). Perceived exercise benefits and barriers of non-exercising female university students in the United Kingdom. *International Journal Of Environmental Research And Public Health*, 7(3), 784-798.
13. Mack, M., & Shaddox, L. (2004). Changes in Short-Term Attitudes Toward Physical Activity and Exercise of University Personal Wellness Students. *College Student Journal*, 38(4), 587-593.
14. Reed, J., & Phillips, D. (2005). Relationships Between Physical Activity and the Proximity of Exercise Facilities and Home Exercise Equipment Used by Undergraduate University Students. *Journal of American College Health*, 53(6), 285-290.
15. Sjöström, M., Oja, P., Hagströmer, M., Smith, B.J., & Bauman, A. (2006). Health enhancing physical activity across European Union countries: the Eurobarometer study. *Journal of Public Health*, 14(5), 291-300.
16. Steinhardt, M., & Dishman, R. (1989). Reliability and validity of expected outcomes and barriers for habitual physical activity. *Journal Of Occupational Medicine: Official Publication Of The Industrial Medical Association*, 31(6), 536-546.

## LEVEL OF PHYSICAL ACTIVITY AND INACTIVITY OF SLOVAK ADOLESCENTS

Jaromír Šimonek

Constantine the Philosopher University, Nitra, Slovakia

### Abstract

The poster is focused on the measurement of physical activity as well as inactivity of students of primary school in the region of Nitra, Slovakia. The research was realized in February and March 2010. 33 students (20 boys and 13 girls) at the age of 12-15 agreed to participate. Using pedometers SILVIA we searched daily number of steps covered. The results were compared with the recommendations of other authors and the WHO values. Physical activity of the boys reached an average of 11.390 steps per day but Frömel et al. (1999) recommend 13.000 steps per day. Physical activity of the girls reached an average of 8.218 steps per day but Frömel et al. (1999) recommend 11.000 steps per day. Boys achieved higher physical activity than girls, even though they fell short of the recommended level. Boys and girls reached 10587 steps per working day, while on weekend days it was only 9024 steps. The most active boys spent reached the least time by inactivity, while in girls it was the opposite. Boys reached on average by 30 min lower level of inactivity than girls. Pupils recorded higher inactivity time during the working days (548) than on weekend days (336).

**Key words:** physical activity, inactivity, pedometer, recommended levels of the physical activities, leisure time, health

### Introduction

Motor activity takes a share in the whole course of ontogenesis, it co-creates and guides the development of human organism. Generally, it is inevitable for physical and psychic growth of a man. The level of motor activity in children depends on various factors (Chovanová, 2009). The volume of spontaneous motor activity is rather high in the pre-pubescency period (approx. 5.5 hrs a day). During pubescency the level of spontaneous physical activity reaches 4-4.5 hrs reaching its peak values at the age of 12-13. Then, there is a rapid decrease in motor activity of adolescents. Boys are more active than girls.

The volume of motor activity has gone down in the last decades. As a result of the lack of motor activity many diseases like obesity, cardio-vascular diseases, diabetes, high blood pressure, and osteoporosis represent a serious threat in the adult age, etc. Currently, to increase the amount of motor activity at school seems to be impossible due to serious reasons: the low number of P.E. lessons, the lack of financial means for maintaining sport facilities, etc. Motor activity realized in adolescents' leisure time has a decisive meaning for the healthy development of a child. It is also the space, where unskilled, obese and lazy children can find their place for going for at least some exercises.

Motor activity shows positive impact on health in case that its overall volume and intensity reach certain threshold values. For children it is very difficult to fix a certain minimum limit of motor activity to be carried out for their healthy growth. In the practice we can find some attempts to determine the threshold value of volume of motor activity and the zone of intensity of loading (Corbin et al., 2004; Heller, 1996; Fromel et al., 1999). (Tab. 1).

Bunc et al. (2004) found that the current period is characterised in children by a decreasing level of motor activity with the growing age. The average found values of overall daily energy expenditure in children of age 10 reached  $5.3 \pm 1.8$  kcal.kg.day in boys and  $4.7 \pm 1.2$  kcal.kg.day. In older children – lower values were found:  $5.1 \pm 1.1$  kcal.kg.day in boys and  $4.5 \pm 1.0$  kcal.kg.day, while the recommended values are 6-8 kcal.kg.day (Bunc et al., 2000).

Table 1. Recommended volume and intensity of motor activity of children and youth (Frömel et al., 1999)

Authors	State	Recommended level of motor activity
Corbin et al. (2004)	USA	<i>Minimum health standard:</i> everyday 30 min activity of average intensity with energy consumption of 3-4 kcal.kg.day <i>Optimum functional standard:</i> everyday 60 min activity at least of average intensity with energy expenditure of 6-8 kcal.kg.day
Fromel et al. (1999)	Czech Rep.	<i>Everyday energy consumption:</i> 11 kcal.kg.day in boys. 9 kcal.kg.day in girls; Everyday number of steps: 13.000 in boys. 11.000 steps in girls. <i>The share of motor activity</i> on the whole weekly energy consumption should represent 25%.
Heller (1996)	Czech Rep.	<i>Everyday minimum intensity:</i> 30 min aerobic exercises within the target zone: HR=60-85% of max.
Presidents Council (2001)	USA	5 times a week 11.000 steps a day.

Presidents' Council on Physical Fitness and Sports (2005) expects that 6-17 years old boys should do at least 13.000 steps per day and girls 11.000 steps per day.

Fromel et al. (1999) recommends 11.000 steps in girls and 13.000 steps in boys per week in university students. The daily expenditure of energy should reach at least 11 kcal per kg a day in boys, while in girls 9 kcal per kg and day.

Tudor-Locke & Bassett (2004) recommend 10.000 steps daily for adults.

## Aims and tasks

The aim of this study was to find out the level of motor activity in boys and girls aged 12 to 15 in the region of Nitra, Slovakia and to compare the results with the overall recommendations of experts for the counts of steps.

Task 1: To randomly select elementary school pupils.

Task 2: To wear Pedometer equipment during 5 weeks and record the data into a form. To use mathematical and statistical methods for finding out the standard data: average number of steps per day (Monday to Sunday), average number of steps per month, average number of steps per person and group.

Task 3: Pupils should record the times of inactivity during a day.

Task 4: To compare the obtained results as to the sex, as well as with the similar ones published by other authors and with the ones recommended by health experts.

## Methods

The research was held at a rural elementary school in the Nitra district during the months of February and March 2010. The average age of 13 female students was  $14.9 \pm 0.7$  years, and of 20 male students was  $14.4 \pm 0.9$  years (Tab. 2). Pedometer Silva equipment measuring the number of steps, distance covered and calories burnt was used for the measurement of basic data. The stepmeter was worn from the moment, when pupils got up from beds until they went to sleep at night, with the exception of swimming or other unfavourable conditions for measurement. The pupils used a form for registering the above mentioned data as well as the times of inactivity every day. Pupils wore pedometer during 5 weeks (between February 8, 2010 and March 21, 2010, with an exception of the week of spring holidays) and recorded the step counts in a diary. Pupils participated in 2 (2x45 min) lessons of school P.E.

Table 2. Average data of pupils

Sex	Average height [cm]	Average weight [kg]	Average BMI index	PA at school [min./week]
Boys	168.3	60.1	21.4	90
Girls	163.8	50.3	19.2	90

## Results

**Hypothesis No.1: Physical activity of boys does not reach the recommended standards (13 000 steps/day).**

Table 3. Statistical characteristics of step counts during a week (boys)

Number of steps	Monday	Tuesday	Wednesday	Thursday	Friday	Saturday	Sunday
Average	12054	11560	12813	11781	10829	10869	9819
Max. value	26250	31074	34212	32300	40276	36867	39948
Min. value	1345	2971	496	1716	1129	716	679
Standard deviation	4864	5549	6507	6716	7332	7857	6137
Difference max-min	24905	28103	33716	30584	39147	36151	39269
(n)>13000	8	8	7	6	4	4	6
(n) >13000 (%)	40	40	35	30	20	20	30

The total average number of steps per week in boys amounted to 11390 steps/day (Tab. 3). The highest average step count was reached on Wednesday (12813) and Monday (12054). The lowest levels were recorded towards the end of the week.

The reason for this is the fact that during the week boys attended sport activity in a club. Especially two pupils influenced the total step count during the week because they were training for a steeplechase competition. The results

show big individual differences. The boys reached 88% of the recommended standard but only 31% of them exceeded the level of 13000 steps/day.

The total average number of steps per week in girls amounted to 8218 steps/day, which represents only 75% of the recommended value (Tab. 4). The highest average step count was reached on Friday (9284) and Thursday (9079). The lowest levels were recorded towards the end of the week.

The reason for this is the fact that during the week girls did not attend any sport activity, except for 2 P.E. lessons, but their contents was rather static. The results show wide individual differences. Only 30.8% of girls reached the standard on Thursday, although this was the day with most step counts. During weekends only one girl reached the level of 11000 step counts. Others lagged behind by more than 4000 steps.

Table 4. Statistical characteristics of step counts during a week (girls)

Number of steps	Monday	Tuesday	Wednesday	Thursday	Friday	Saturday	Sunday
<b>Average</b>	8458	8059	8659	9078	9284	6835	7151
<b>Max. value</b>	27586	23323	20483	23006	26928	21628	17890
<b>Min. value</b>	2456	1138	1019	1458	1786	1197	150
<b>Standard deviation</b>	4427	4355	4014	4366	5458	3801	4125
<b>Difference max-min</b>	25130	22185	19464	21548	25142	20431	17740
<b>(n)&gt;13000</b>	2	2	3	4	3	1	1
<b>(n) &gt;13000 (%)</b>	15.4	15.4	23.1	30.8	23.1	7.7	7.7

Table 5. Statistical characteristics of step counts on working days (boys+girls)

Number of steps	Monday	Tuesday	Wednesday	Thursday	Friday
<b>Average</b>	10637	10181	11177	10716	10221
<b>Max. value</b>	27586	31074	34212	32300	40276
<b>Min. value</b>	1345	1138	496	1458	1129
<b>Standard deviation</b>	5003	5379	5999	6035	6682
<b>Difference max-min</b>	26241	29936	33716	30584	39147
<b>(n)&gt;13000</b>	10	10	10	10	7
<b>(n) &gt;13000 (%)</b>	30.3	30.3	30.3	30.3	21.2

Tab.6 Statistical characteristics of step counts on weekend days (boys+girls)

No. of steps	Saturday	Sunday
<b>Average</b>	9280	8768
<b>Max. value</b>	36867	39948
<b>Min. value</b>	716	150
<b>Standard deviation</b>	6842.2	5575.6
<b>Difference max-min</b>	36151	39798
<b>(n)&gt;13000</b>	5	7
<b>(n) &gt;13000 (%)</b>	15.2	21.2

The average number of step counts on working days reached 10587 steps/day, while on weekend days it was only 9024 steps/day (Tab.5,6,7). The reasons for lower weekend step counts are: walking to and from school, walking breaks in school, P.E. lessons, leisure time filled with inactivity, etc. Only 28.5% of pupils reached the recommended level on working days, while on weekend ones there were only 18.3% of pupils.



Table 7. Comparison of the step counts on working days and weekend days

Hypothesis 3	Average step counts		Comparison
	Working days	Weekend days	
Step counts	10587 (28.5%)	9024 (18.2%)	1563 (10.3%)
Km	7.98	6.76	1.22
Kcal	342.7	297.3	45.4

**Hypothesis No.2: Pupils with the highest number of step counts will record lowest inactivity values**

Inactivities included: sitting in a bus, chatting with friends, standing in a queue, watching Tv, learning for school, working with PC, etc. 3 pupils with the highest step counts were observed for their time spent in inactivity (min).

Table 8. Physical activity and inactivity of the most active boys

Boys with the highest PA		No. of steps	Inactivity (min)
	Boy 1	21905	363
	Boy 5	19016	430
	Boy 12	18467	482
	<b>Average value</b>	<b>19796</b>	<b>425</b>

Table 9. Physical activity and inactivity of the least active boys

Boys with the lowest PA		No. of steps	Inactivity (min)
	Boy 14	7193	480
	Boy 7	7090	498
	Boy 16	6415	536
	<b>Average value</b>	<b>6899</b>	<b>505</b>

Table 10. Physical activity and inactivity of the most active girls

Girls with the highest PA		No. of steps	Inactivity (min)
	Girl 32	15158	605
	Girl 26	10907	499
	Girl 30	9324	593
	<b>Average per day</b>	<b>11796</b>	<b>566</b>

When we compare the relationship of physical activity and inactivity in boys (Tab. 8, 9, 10 and 11) we can see that the 3 most active individuals exceeded the recommended standard by 6796 step counts, while their inactivity per week reached only 425 min per day. On the contrary, the 3 least active boys covered on average only 6899 steps and reached 505 min per day of inactivity, thus overcoming the active boys by 80 minutes per day. The 3 most active girls exceeded the limit by 796 steps and their inactivity reached 566 minutes per day. The 3 least active girls recorded 4905 steps per day and inactivity grew to 489 min/day, which was paradoxically by 77 min less than in the active girls.

Table 11. Physical activity and inactivity of the most active girls

Girls with the lowest PA		No. of steps	Inactivity (min)
	Girl 22	6195	608
	Girl 33	4693	398
	Girl 31	3827	461
	<b>Average per day</b>	<b>4905</b>	<b>489</b>

**Hypothesis No.3: Boys will record more time spent by inactivity than girls.**

Girls (506) spent by 30 min more time with inactivity than boys (476). Boys were more inactive only on Saturdays, while on Sundays and Mondays the values were equal (Tab. 12).

Table 12. The amount of inactivity of boys and girls during the week

Inactivity - boys	Min	Inactivity - girls	Min
Monday	567	Monday	567
Tuesday	550	Tuesday	577
Wednesday	530	Wednesday	582
Thursday	534	Thursday	588
Friday	477	Friday	554
Saturday	326	Saturday	325
Sunday	346	Sunday	346
<b>Average</b>	<b>476</b>	<b>Average</b>	<b>506</b>

**Hypothesis No.4: Pupils will be more inactive on working days than on weekend days.**

The average inactivity of both boys and girls on working days exceeded the values of inactivity during weekend days by 212 min/day (Tab. 13).

Table 13. Average time spent by inactivity on working days

Inactivity – working days	Monday	Tuesday	Wednesday	Thursday	Friday	Average	Saturday	Sunday	Average
Min	567	561	551	555	507	<b>548.2</b>	325	346	<b>335.5</b>

**Discussion and conclusions**

The comparison with the recommendations by Tudor-Locke & Bassett (2004) we can assume that boys were quite successful in reaching this value, while girls reached only 82% of the value. Recommendations of **Presidents' Council** (2005) in USA present the standard of 11000 steps 5 times per week. Boys again meet this level, while girls fulfilled this standard in no day at all, reaching only 75% of the recommended value. Our selection of pupils did not meet the recommended levels of physical activity during a week.

Our measurements of the average number of step counts per 5 weeks showed that:

1. Boys averaged 11390 step counts per week.
2. Girls averaged 8218 step counts per week.
3. Boys and girls reached 10587 steps per working day, while on weekend days it was only 9024 steps.

Our observation of pupils' inactivity showed that:

1. The most active boys reached the least time spent by inactivity, while in girls it was the opposite.
2. Boys reached on average by 30 min lower level of inactivity than girls.
3. Pupils recorded higher inactivity time during the working days (548) than on weekend days (336).

The results proved that in order to increase the amount of physical activity of adolescents it is necessary to offer at least 3 lessons of obligatory physical education and sport lessons per week and in case of good personal and material conditions to add another 2 hours of sport activities in after school activities. Parents should collaborate with P.E. teachers in the way that they should encourage their children to go in for sport activities on weekends and on their leisure time to increase the amount of PA spent by their children. Only through cooperation of teachers and parents we can cope with the issues of the lack of physical activity and growing amount of inactivity of our young generation.

## References

1. Bunc, V. 2000. *Školní mládež v konci 20. století. Závěrečná zpráva projektu MŠMT ČR, VS 97 131*. Praha: FTVS UK.
2. Bunc, V. 2004. *Současné pohledy na identifikaci sportovního talentu*. In *Identifikace pohybových talentů*. Praha: FTVS UK, 2004, s. 19-24.
3. Chovanová, E. 2009. *Rozvoj koordinačních schopností dětí*. Prešov: FŠ PU, 2009, 83 s. ISBN 978-80-8068-967-4.
4. Corbin, C.B. – Pangrazi, R. P. – Lemasurier, G. C. 2004. *Physical Activity for Children: Current Patterns and Guidelines*. President's Council on Physical Fitness and Sport Research Digest, 5(2), 1-8.
5. Frömel, K. - Novosad, J. - Svozil, Z. 1999. *Pohybová aktivita a sportovní zájmy mládeže: Výzkumná zpráva*. Olomouc: FTK UP.
6. Heller, J. 1996. "Cílové zóny" srdeční frekvence v školní tělesné výchově. *Těl. Vých. Sport. Mlád.*, roč. 62, č.4, s. 38-44.
7. Presidents' council for physical fitness and sport. 2005. *The presidential active lifestyle award fact sheet*. [online]. Washington: 200 Independence Ave. [cit. 2007. 19.07]. Retrieved from <[http://fitness.gov/challenge/pala\\_fact\\_sheet/pala\\_fact\\_sheet.html](http://fitness.gov/challenge/pala_fact_sheet/pala_fact_sheet.html)>
8. Tudor-Locke, C. - Bassett, D. R., jr. 2004. How many steps/day are enough? Preliminary pedometer indices for public health. *Sports Medicine*, 34(1), 2004. 1-8.

## SPORTING ACTIVITY PREFERENCES OF PEOPLE OF DIFFERENT AGE AND GENDER IN RURAL AREAS

Vilko Petrić, Dario Novak and Boris Neljak

*Faculty of Kinesiology, University of Zagreb, Croatia*

### Abstract

The main purpose of this study was to determine the similarities and the differences regarding sports preferences among people of different chronological age and gender. 705 adult persons aged 20 to 65 were questioned in the study. The canonical discriminant analysis revealed three significant discriminant functions ( $p < 0,00$ ). The first function can be identified as the function of gender stereotypes, the second as the function of social values and the third as the function of a smaller or greater risk of injury. It can be concluded that there are differences regarding interests toward different kinds of sports according to gender and age in this population, but also that social values of a person may play an important role in what kind of sports a person will choose.

**Key words:** *rural population, adult persons, sports, interests, differences*

### Introduction

The peak in the development of motor and functional abilities is reached in young adulthood, while in middle age it comes to a weakening of the functions of all systems. The quality of life at that age is a predictor of mortality and the quality of life in old age. (Strandberg et al., 2004). Regular physical activity prolongs life and delays the loss of motor skills (Wang et al., 2002). Despite the proven benefits of exercise, there are significantly more people with a sedentary life style in many areas. (King et al., 2000).

Furthermore, in the rural area where the data for this study (the municipality of Marčana) were collected the sports infrastructure is almost non-existent and the results could be of great benefit for taking the first steps in a possible future construction of certain facilities.

The field of interest in sport activities, as well as the differences of interests by gender and age have been studied by many authors (Prot and Bosnar, 2007; Oglesby et al., 1993; Koivula, N. 1995; Petric, V. and Novak, D. 2008; Myers, L., et al., 1996; Hager, M.S. et al., 2001; etc.) and they all found that there are sports in which the male are more interested, sports for which the interest is equal, and sports which are preferred by the female, but also that there are differences in these interests between populations. Therefore, it is recommended to repeat the studies on interests for each population separately in order to obtain the data on the exact state of a given population and to continue numerous epidemiological studies in the world.

The basic objective of this study was to determine the interests and differences by sports for persons of different chronological age and gender.

### Methods

The study was conducted in the municipality of Marčana, a rural part of the Istrian Region. The municipality does not have any sporting infrastructure, so it can be assumed that we avoided that the material conditions for doing sports influence the interest in a particular sport. The study examined 705 adults aged 20 to 65 years. The sample was divided into four groups according to sex and age (Erikson, 1993). In other words, two groups consisted of 165 adult men and 171 women aged 20 to 40 years (young adults) and 176 mature men and 193 women aged 41 to 65 years (middle adulthood).

The respondents were given a list containing the names of 31 kinds of sport (Table 1) that can be practiced in their region or are organized to be practiced elsewhere (skiing).

The participants evaluated their level of interest in every sport they were offered according to the Likert scale of five degrees. They gave a five (5) to the sport that they would definitely like to practice if they were able to, a four (4) to the sport that they would like to practice, a three (3) to the sport which they would practice from time to time or in appropriate circumstances, a two (2) to all sports that they would not like to practice and would do so just in case they had no other choice and finally a one (1) to the sports which they would not like to practice at all and under no circumstances.

The data were processed in two steps with help of the Statistica 7.0 program. The first step consisted of the calculation of the basic descriptive parameters (the estimate and standard deviation means) in order to gain insight into the respondents'

interests toward sports, while in the second step the canonical discriminant analysis was done to determine the differences between the formed groups. The statistical significance was tested at  $p < 0,05$ .

## Results

The Table 1 contains the arithmetic means and standard deviations of the estimates for the total sample and the four subsamples of respondents. The greatest general interest in sports was shown by mature men with a general average of 2,97.

Mature women show the weakest interest with a general average of 2,6. The well-accepted sports with an average of more than the neutral 3 in all four samples are swimming, volleyball, basketball, cycling, handball and tennis. Bodybuilding is the only sport which got an average rating of less than 1,95 in all four groups and which is also generally the worst accepted sport, whereas volleyball is generally the best accepted kind of sport with an average rating of 3,86. Considering the total sample, the lowest variability is present also in these two kinds of sport.

Besides the previously mentioned sports and regarding the average scores, the group of adult women mostly prefers skiing, dance, badminton and aerobics, while the group of mature women, besides dance, badminton and aerobics, is mostly interested in bowling. Besides bodybuilding, both groups of women show the least average interest in martial sports and underwater fishing.

The group of adult men shows the greatest special interest in skiing, football and traditional bowling, while the mature men in skiing, mountaineering, football, table tennis, traditional bowling, sport fishing and bowling. The male groups gave the least average grades to bodybuilding, inline skating, aerobics and synchronized swimming.

Three significant discriminant functions were found in the results of the canonical discriminant analysis of sport preferences (Table 2).

Table 1. Basic descriptive parameters: arithmetic mean (M), standard deviation (SD)

	TOTAL		YOUNG ADULT W.		MIDDLE ADULT W.		YOUNG ADULT M.		MIDDLE ADULT M .	
	M	S.D.	M	S.D.	M	S.D.	M	S.D.	M	S.D.
SWIMMING	3,84	1,09	3,98	0,98	4,00	1,14	3,61	1,22	3,75	1,03
SKIING	3,08	1,34	3,10	1,33	2,53	1,40	3,24	1,34	3,46	1,30
INLINE SKATING	2,33	1,09	2,90	1,29	2,41	0,96	1,82	0,98	2,19	1,12
VOLLEYBALL	3,86	1,00	4,27	1,05	4,06	0,83	3,47	0,89	3,63	1,22
MOUNTAINEERING	2,93	1,23	2,87	1,36	2,73	1,43	2,84	0,86	3,29	1,27
BASKETBALL	3,39	1,19	3,27	1,16	3,73	1,13	3,37	1,13	3,17	1,32
FOOTBALL	3,28	1,14	2,54	1,29	2,43	1,06	3,95	1,18	4,20	1,03
DANCE	3,59	1,17	4,21	0,87	4,45	1,06	3,13	1,23	2,58	1,50
JUDO	2,25	1,31	1,75	1,30	1,86	1,46	2,55	1,25	2,83	1,22
TABLE TENNIS	2,96	1,24	2,60	1,35	2,96	1,37	2,79	1,02	3,49	1,22
ROWING	2,49	1,24	2,10	1,29	2,35	1,30	2,61	1,15	2,88	1,22
DIVING	2,42	1,31	2,37	1,21	2,08	1,37	2,21	1,36	3,00	1,30
UNDERWATER FISHING	2,21	1,28	1,75	1,17	1,49	1,06	2,55	1,46	3,05	1,44
TAE KWON DO	2,01	1,20	1,54	1,00	1,69	1,25	1,95	1,01	2,86	1,54
CYCLING	3,30	1,20	3,00	1,19	3,39	1,30	3,18	1,04	3,63	1,26
TRADITIONAL BOWLING	3,08	1,10	1,83	1,04	2,98	1,25	3,97	0,85	3,54	1,24
HANDBALL	3,24	1,32	3,50	1,20	3,10	1,34	3,00	1,32	3,34	1,40
BADMINTON	2,97	1,39	3,37	1,36	3,24	1,49	2,89	1,37	2,37	1,35
TENNIS	3,38	1,14	3,33	0,94	3,04	1,43	3,68	0,93	3,47	1,24
WRESTLING	1,93	1,02	1,44	0,83	1,31	0,62	2,24	1,36	2,73	1,26
WATER SKIING	2,10	1,38	2,31	1,41	1,92	1,34	2,00	1,41	2,17	1,34
WATERPOLO	2,46	1,26	1,77	1,04	2,33	1,28	2,82	1,29	2,92	1,41
EQUESTRIAL SPORTS	2,78	1,49	2,69	1,50	2,31	1,50	3,11	1,52	3,00	1,44
KARATE	2,07	1,13	1,90	1,24	1,53	0,87	1,95	0,93	2,90	1,47
WINDSURFING	2,31	1,45	2,21	1,45	2,14	1,53	2,32	1,32	2,56	1,50
DIVING (JUMPING INTO WATER)	2,16	1,36	1,88	1,18	2,27	1,48	2,39	1,37	2,10	1,39
SYNCHRONIZED SWIMMING	2,10	1,16	2,67	1,45	2,29	1,34	1,45	0,69	2,00	1,14
BODYBUILDING	1,73	1,05	1,69	1,13	1,84	1,09	1,45	0,69	1,95	1,28
AEROBICS	2,79	1,30	3,58	1,38	3,61	1,40	1,89	1,06	2,08	1,36
SPORT FISHING	2,42	1,36	2,02	1,21	2,24	1,44	2,18	1,33	3,25	1,46
BOWLING	2,97	1,25	2,12	1,35	3,12	1,30	3,03	1,13	3,59	1,22
<b>TOTAL</b>	<b>2,72</b>	<b>1,23</b>	<b>2,60</b>	<b>1,21</b>	<b>2,63</b>	<b>1,25</b>	<b>2,70</b>	<b>1,15</b>	<b>2,97</b>	<b>1,31</b>

The standard discriminative coefficients and the correlations with the discriminant function (Table 3) reveal that the first function can be identified as a function of gender stereotypes. It is defined by football, traditional bowling, sport fishing, waterpolo and martial arts on the positive pole and by inline skating, volleyball, dance, synchronized swimming and aerobics on the negative pole.

Table 2. Results of the canonical discriminant analysis: discriminant function (F), eigenvalues (E), canonical correlation coefficient (C), Wilk's Lambda (W), Hi – square test (X2), degrees of freedom (df), statistical significance (p)

F	E	C	W	X2	df	p
1	3.09	0.87	0.11	1488.02	108	0.00
2	0.66	0.63	0.46	525.27	70	0.00
3	0.30	0.48	0.77	178.55	34	0.00

Table 3. Canonical coefficients (X) and the correlations with the canonical variable (F)

	X 1	F 1	X 2	F 2	X 3	F 3
SWIMMING	-0.07	-0.08	0.06	-0.01	0.36	0.20
SKIING	-0.03	0.09	0.23	0.28	-0.21	-0.27
INLINE SKATING	-0.25	-0.18	0.17	0.25	-0.03	0.02
VOLLEYBALL	-0.33	-0.26	-0.03	-0.05	0.24	0.25
MOUNTAINEERING	0.03	0.09	0.10	0.03	-0.05	0.15
BASKETBALL	-0.11	-0.06	-0.42	-0.21	-0.20	-0.21
FOOTBALL	0.29	0.37	-0.28	-0.23	-0.04	-0.02
DANCE	-0.30	-0.37	-0.12	-0.14	0.38	0.26
JUDO	0.20	0.26	-0.03	0.05	-0.02	-0.01
TABLE TENNIS	0.09	0.12	-0.19	-0.12	0.33	0.19
ROWING	0.01	0.17	-0.18	-0.07	0.10	0.04
DIVING	0.35	0.12	0.24	0.20	0.05	0.13
UNDERWATER FISHING	0.13	0.31	0.21	0.24	-0.25	-0.24
TAE KWON DO	-0.05	0.26	0.26	0.04	-0.37	-0.18
CYCLING	-0.03	0.05	0.04	-0.10	-0.06	0.10
TRADITIONAL BOWLING	0.27	0.33	-0.46	-0.45	0.29	0.23
HANDBALL	0.05	-0.01	-0.22	-0.23	-0.06	-0.02
BADMINTON	-0.10	-0.12	0.37	0.31	-0.15	-0.13
TENNIS	-0.09	0.08	0.23	0.26	-0.29	-0.16
WRESTLING	0.42	0.37	0.11	0.14	-0.04	0.01
WATER SKIING	-0.06	0.04	0.29	0.25	-0.20	-0.23
WATERPOLO	0.23	0.17	-0.39	-0.28	-0.03	-0.07
EQUESTRIAN SPORTS	0.14	0.10	0.28	0.29	-0.21	-0.28
KARATE	0.21	0.25	0.16	0.18	-0.01	0.20
WINDSURFING	-0.09	0.10	0.24	0.23	0.39	0.01
DIVING (JUMPING INTO WATER)	-0.23	-0.17	-0.76	-0.13	-0.51	-0.26
SYNCHRONIZED SWIMMING	-0.21	-0.17	0.13	0.14	0.02	0.07
BODYBUILDING	0.13	0.15	-0.14	-0.01	0.17	0.13
AEROBICS	-0.67	-0.31	-0.01	-0.01	0.20	0.28
SPORT FISHING	0.20	0.17	-0.19	-0.09	0.40	0.39
BOWLING	0.07	0.20	-0.59	-0.31	0.39	0.28

For the second discriminant function can be said that it differentiates the sports that require more money to be set aside from those for which less or almost no money is needed. This function can be called a “function of social values”. It is defined by skiing, diving, underwater fishing, badminton, tennis, windsurfing, water skiing and equestrian sports on the positive pole and the interest in football, basketball, handball, waterpolo and traditional bowling on the negative pole.

The third discriminant function can be identified as the function that divides sports into those with greater risk and those with lower risk of injuries. It is defined by the interest in swimming, volleyball, table tennis, traditional bowling, bowling, aerobics, dance and sport fishing on the positive pole and the interest in skiing, underwater fishing, basketball, tae kwon do, equestrian sports, water skiing and diving (jumping into water) on the negative pole.

If we analyse the group centroids (Table 4), it can be deduced that the first function differentiates the groups of men with significantly positive results from the groups of women with significantly negative results.

The second discriminant function differentiates the group of adult women and mature men with a greater interest in elite sports from the group of mature women and adult men who tend to non-elite sports, yet it can be noticed that the men groups have slightly lower projections that are closer to the starting point in comparison with the female groups, i.e. the function differentiates the female groups more than the male groups.

Regarding the third discriminant function, the groups of mature men and women with positive results and a tendency towards sports with lower risk of injury differ from the groups of adult men and women with negative results and a tendency toward sports with a much higher risk of injury.

Table 4. Group centroids for discriminant functions (C1 – C3)

	C 1	C 2	C 3
<b>Men (20-40)</b>	1.47	-0.32	-0.98
<b>Men (41-65)</b>	2.02	0.25	0.56
<b>Women (20-40)</b>	-1.81	1.04	-0.11
<b>Women (41-65)</b>	-1.55	-1.15	0.25

## Discussion and conclusions

It is believed that man is capable of physical activity as long as he lives and that chronological age is not the limit. It is only important to correctly determine the amount of strain. Each activity must be adequately dosed so that the desire for further activity always remains.

Petrić and Novak (2008) found in their research on primary school pupils in the municipality of Marčana that pupils prefer ball sports (complex) and cyclical sport activities such as cycling and swimming. It can be said that the grown-ups in this municipality also prefer the same kinds of sport. Furthermore, this fact can also be linked to the research of Ozdirenc et al. (2005), in which they proved that the inhabitants of rural areas mostly prefer ball sports, riding a bike and swimming.

From the medical point of view, bike riding has a positive impact on the development of functional abilities of the heart and the cardiovascular system, while, as a recreational activity, it is particularly beneficial in obese people with knee osteoarthritis in the early stages, since the bike carries the weight of the body. As for swimming, it is considered to be one of the most suitable forms of physical activity from the medical and especially the orthopaedic point of view. There is virtually no age limit; children can swim from birth and older people until the end of life. Swimming lowers the pressure on the circulatory system, because the circulation loop of the large circulatory system is in a horizontal position and the hydrostatic pressure on the surface of the body has a beneficial effect on the venous blood flow. Since the body loses its weight in the water, swimming is particularly suitable for obese people, who usually do not easily find an appropriate form of recreational activity.

The domain of sports and physical activities traditionally consists of the sports that are more suitable for women and those more appropriate for men (Koivula, 1995). Like it was noticed in other environments, this population also divides sports into so called “male” and “female” (Oglesby and Hill, 1993). The male population prefers sports like football, traditional bowling, sport fishing, kayak and canoeing, as well as martial arts like wrestling, karate and judo, while the female population mostly prefers sports with a dominating aesthetic component, i.e. sports like dance, aerobics, synchronized swimming, diving (jumping into water), inline skating and of complex sports - volleyball. Bosnar and Žugaj (2008) proved in their research that students also have prejudices regarding sports and that they divide them into distinctively masculine and distinctively feminine.

The populations of older men and younger women prefer elite sports like skiing, water skiing, windsurfing, diving, tennis, badminton and equestrian sports, whereas the populations of younger men and older women mostly prefer non-elite sports like basketball, football, handball, traditional bowling, bowling, waterpolo, wrestling, tae kwon do etc. It can be assumed that the most part of older men have a regular income and therefore can afford the mentioned elite sports. These are mostly individual sports and are therefore more suitable for people in a mature or older age when it is more and more difficult to gather a larger number of persons for practicing sports recreation. (Andrijašević, 2010). Younger men mostly use outdoor sports facilities, so it can be assumed that this is another reason for a greater interest in the previously mentioned sports. The most common reason for older women doing sports is to have an opportunity to socialize (Andrijašević, 2010). This fact can explain their greater interest in non-elite sports, i.e. in sports that are mostly collective and allow “healthy” socializing.

The population of younger men and women prefers sports like skiing, dance, underwater fishing, water skiing, diving (jumping into water) and equestrian sports, whereas the population of older men and women prefers swimming, volleyball, basketball, table tennis, traditional bowling, bowling, aerobics etc. Andrijašević (2010) divides sports and recreation programs according to the characteristics of the participants' age groups. The previously mentioned sports do perfectly fit into programs for younger, adult and older age groups, respectively.

It can be concluded that there are differences in interests toward sports by gender and age in this population, but also that social values of a person may play an important role in what kind of sport a person will choose.

## References

1. Andrijašević, M. (2010). Kineziološka rekreacija. Kineziološki fakultet Sveučilišta u Zagrebu. Zagreb, str. 415.
2. Bosnar, K. and Žugaj, S. (2008). Gender typing of sports in Croatian university students. Sport, Culture and Society: Abstract book of the 5th conference, Bled, 60.
3. Erikson, E.H. (1993). *Childhood and society*. Norton: USA.
4. Koivula, N. (1995). Ratings of Gender Appropriateness of Sports Participation: Effects of Gender- Based Schematic Processing. *Sex Roles*, 58, 3-9.
5. King, A., Castro, C., Wilcox, S., Eyler, A.A., Sallis, J.F., Brownson, R.C. (2000). Personal and environmental factors associated with physical inactivity among different racial-ethnic groups of U.S. middle-aged and older aged women. *Health Psychology*, 19, 354-364.
6. Hagger, M.S., (2000). The influence of self-efficacy and past behaviour on the physical activity intentions of young people. *Journal of Sports Science*, 19, 711-725.
7. Mayers, L. (1996). Physical and sedentary activity in school children grades 5-8: the Bogalusa heart study. *Medicine and Science in Sport and Exercise*, 28(7), 852-859.
8. Oglesby, C. A. & Hill K. L. (1993). Gender and sport. In Singer R.N., M. Murphy and L. K. Tennant (Eds.) *Handbook of research in sport psychology*. McMillan, New York.
9. Ozdirenc, M., Ozcan, A., Akin, F., Gelecek, N. (2005). Physical fitness in rural children compared with urban children in Turkey. *Pediatrics International*. Vol.47. str. 26-31.
10. Petric, V. and Novak, D. (2008). Interes za sportske aktivnosti učenika i učenica ruralnih sredina. Zbornik radova: Kineziološka rekreacija i kvaliteta života. Kineziološki fakultet Sveučilište u Zagrebu, 105-110.
11. Prot, F., Bosnar, K. (2007). Razlike preferencija sportova urbanih adolescenata. VII. Konferencij o športu Alpe-Jadran, Opatija, 287-295.
12. Strandberg, A., Strandberg, T.E., Salomaa, V.V., Pitkala, K., Hapola, O., Miettinen, T.A. (2004). A follow-up study found that cardiovascular risk in middle age predicted mortality and quality of life in old age. *Journal of Clinical Epidemiology*, 57, 415-421.
13. Wang, B.W.E., Ramey, D.R., Schettler, J.D., Hubert, H.B., Fries, J.F. (2002). Postponed development of disability in elder runners. *Archives of Internal Medicine*, 162, 2285-94.



## ASPECTS OF SPORTS TOURISM FOR PEOPLE WITH DISABILITIES; THE CASE OF FRANCE AND ROMANIA

Sorina Cernaianu and Claude Sobry

*Université Lille Nord De France*

### Abstract

The aim of this paper is to present an overall picture of sports tourism focused on the people with disabilities in two different countries. In France, people with disabilities are becoming a growing group of consumers of travel, sports, leisure and other products and services. An important role in the development of tourism offers for disabled people in this country has "Tourism and disability" Association which has created a label with the same name. For the Romanian disabled people insufficient financial resources draw on limiting access to tourist and sports activities. Most hotels, transportation, facilities and tourist sites are not physically accessible in this country. Tourism employees are not trained to deliver adapted services for disabled persons.

**Key words:** *adapted sports tourism, accesibility, sports activities, disabled people, services, label*

### Introduction

Sports tourism seems increasingly out of reach for people with various disabilities. Studies at European level show that, in tourism and leisure, customers, here referring to persons with disabilities, represent a potential for tourism industry.

The number of Europeans physically disabled, financially solvent and able to travel could be considered to 36 million (Touche Ross, 1993) on 50 million people with disabilities in Europe, which represent 11% of the total European population. Consider that in most of the cases, these people travel with an attendant, therefore, study indicates that customers could generate 239 million room night tourist potential (Study Eurostat, 1995). In this situation, the economic benefits deriving from these activities have multiplied. This phenomenon of "tourism multiplier effect" is not negligible for an economic system.

The disabled are people for whom social, physical, sensory and mental impairments, damage or limit their access to equal opportunities in social life, through age, sex, material factors, social and cultural features, which require special protection measures meant to support their social and professional integration (Act No. 519 of 12 July 2002 approving Government Emergency Ordinance no. 102/1999 on the special protection and employment of people with disabilities).

The social model approved by the European Union implies a purely medical change of concept referring to disability as a personal problem directly caused by illness, accident or other cause which can be treated or improved by medical intervention. It helps identify and eliminate discrimination and social barriers. This change requires a multidisciplinary approach to identify knowledge, needs and rights of persons with disabilities and the accountability of all authorities and sectors of social life.

The concept of equal opportunity is the result which indicates that various systems of society, physical environment and social services, activities, information and documentation are accessible to everyone, especially to people with disabilities.

Article 7 of *Global Code of Ethics for Tourism*, entitled "Right to tourism" precise that "The prospect of direct and personal access to the discovery and enjoyment of the planet's resources constitutes a right equally open to all the world's inhabitants" and "Family, youth, student and senior *tourism and tourism for people with disabilities*, should be encouraged and facilitated".

### Sports tourism for people with disabilities: the case of France

Western European country, with a population of 65.8 million inhabitants (INSEE, January 2011) and a land area of 674.843 km<sup>2</sup>, France is one of the most developed countries in the world. According to the World Tourism Organization, France is the world's first destination with 20.3 million arrivals in 2010.

In France, people with disabilities represent a growing group of consumers of travel, sports, leisure and other products and services. Tiralo and hippocampe wheelchair, sailing for disabled persons, handikayak, trimarans specially equipped in order to facilitate their access, handiski, tandemski, dual ski and other summer and winter sports activities are all examples of practices performed in sports tourism in France, selected by an increasing number of people and represent subjects to the attention of specialist tour operators.

According to data from the French Statistics Institute (INSEE), in 2007 the number of disabled people represents 3.72% of French population. A study by the same institute on a sample of 430 disabled people (July 2008 - January 2009) shows that only 38% of respondents went on holiday once a year and 50% several times a year.

An important role in the development of tourism offers for disabled people in France has “Tourism and disability” Association which was founded in 2001. This association has created a label with the same name, which was awarded by the Ministry of Tourism and guarantees the accessibility of disabled people to the tourist sites, services and equipments (like accommodation, catering, culture and sports activities, outdoor activities and so on). The logo contains four types of disabilities (motor, visual, hearing and mental) to indicate the accessibility degree of tourism infrastructure to people with disabilities, as well as the adaptation level of the equipments for this category of persons. A large number of tourist sites adopted this label in France. A distribution according to various types of disability is presented in Table 1.

During the last 5 years, the total number of labeled sites has increased more than 200% (from 1200 sites in 2005 to 4183 in 2010), the highest increase being registered for those sites accessible to all four types of disability (672,45%) which proves the growing interest of economic agents to develop this segment of tourism.

Table 1. Distribution of sites awarded “Tourism and disability” label in France (2005-2010), according to various types of disability (table adapted from [www.tourisme-handicaps.org](http://www.tourisme-handicaps.org) that contains annual newsletters)

Date	Motor		Visual		Hearing		Mental		All four disabilities		Total
	No.	%	No.	%	No.	%	No.	%	No.	%	
10/06/2005	780	65	264	22	396	33	900	75	98	8	1200
30/08/2006	1139	67	408	24	680	40	1309	77	181	10,64	1700
30/09/2007	1536	65,3	584	24,82	1002	42,6	1860	79,08	285	12,11	2352
20/10/2008	1980	66	810	27	1380	46	2430	81	414	13,8	3000
31/12/2009	2623	68,99	1179	31	2015	52,99	3156	83	626	16,46	3802
10/09/2010	2928	69,99	1380	32,99	2342	55,98	3514	84	757	18,09	4183
Difference 2005-2010	2148	4,99	1116	10,99	1946	22,98	2614	9	659	10,09	<b>2983</b>
Difference (%)	275,38	-	422,73	-	491,41	-	290,44	-	672,45	-	<b>248,58</b>

Concerning the equipments, a distribution of “Tourism and disability” label sites awarded according to various types of services like accommodation, catering, tourism offices and visitors’ bureau and so on, has shown us that “Sports activities or outdoor activities” represent around 4% of the total number of activities, every year (see table 2).

Table 2. Distribution of sites awarded “Tourism and disability” label in France (2005-2010), according to various types of equipments (table adapted from [www.tourisme-handicaps.org](http://www.tourisme-handicaps.org))

Equipments	Distribution of sites %					
	10/06/2005	30/08/2006	30/09/2007	20/10/2008	31/12/2009	10/09/2010
Accommodation	46	49	51,8	52,7	52,5	53,7
Museum-craft	16	14	12	3	11,5	10,2
Catering	10	10	8,9	7,7	8	7,5
Tourism offices and visitors' bureau	4	4	4,5	5,9	5,9	7
<b>Sports activities or outdoor activities</b>	<b>4 (48 sites)</b>	<b>4 (68)</b>	<b>4,2 (99)</b>	<b>4 (120)</b>	<b>4,1 (156)</b>	<b>4 (167)</b>
Camping	4	5	4	3,9	3,9	3,7
Educational farm/Animal park	2,5	2	2,8	2,4	2,5	2,2
Castle/Church/Monument	2,5	2,5	2,5	2,3	2,4	2,2
Park/Garden/Forest	2	2	1,5	1,4	1,5	1,5
Cellars, local gastronomy	2	1,5	1	1,1	1,2	1,5
Others*	7	7	6,8	6,6	6,8	6,5

\*Congres center, cinema, entertainment, mediatheque, touristic train, theme parks, mining, beach ...

Although the number of labeled sites for sporting activities is increasing, from 48 sites in 2005 to 167 in 2010, which represents 247.9% growth (see figure 1). Since 2011 a new label “Destinations for all” is launched in France by “Tourism and disability” Association and Ministry of Tourism. This label completes “Tourism and disability”, providing additional guarantees of accessibility to disabled persons like services of everyday life (shops, public services, health services, help and support services and so on), thereby promoting a global tourism offer.

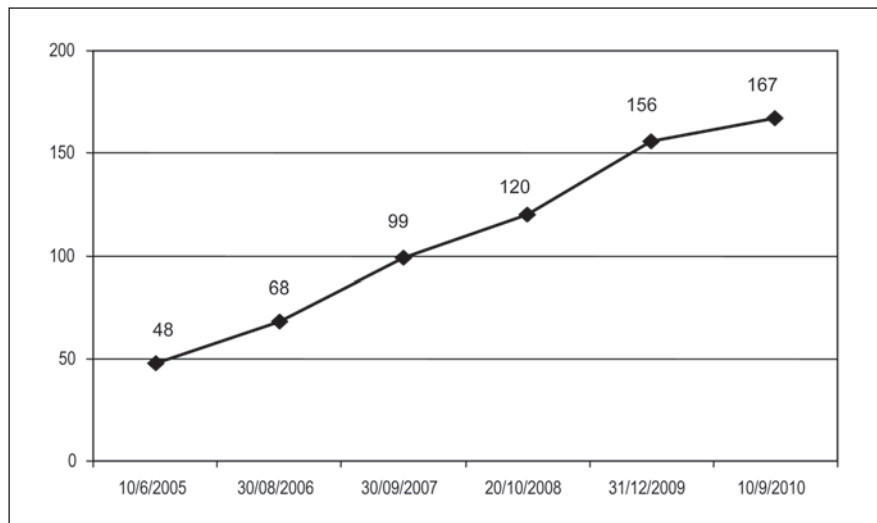

Figure 1. Distribution of sites for “Sports activities or outdoor activities” awarded “Tourism and disability” label in France (2005-2010)

In term of initial staff training the creation of an option named “Reception the tourists with special needs” as part of the BTS Tourism (a national diploma of French higher education, prepared in two years after the baccalaureate) represents a positive step. Concerning the continuous training, a lot of short courses organized by regional tourism committees, regarding especially the accessibility and the reception of tourists with disabilities, are intended to help the tourism employees.

Information regarding the accessibility, divided by geographical area, type of disability or activity on a number of Internet sites like <http://fr.franceguide.com/> or [www.tourisme-handicaps.org](http://www.tourisme-handicaps.org) is one of the positive aspects of adapted tourism development.

## The facts regarding adapted sports tourism development in Romania

Located in the southeastern part of Central Europe, with a population of about 22 million people and covering a vast area of 237,500 square kilometers, Romania is a country of diversity, characterized by beautiful landscapes, traditions, World Heritage sites and cultural crossroads between Latin culture, Balkan and Orthodox Christianity. The tourism potential is very varied and diverse, characterized by a historical and architectural heritage internationally appreciated, favorable climate, rich flora and fauna, with species and unique ecosystems in Europe.

In terms of consumption of tourism services in Romania, a study by INSOMAR in August 2009 on a sample of 2502 persons, representative for the Romanian population greater than or equal to 18 years, shows that in 2009 only 26% of respondents went on holiday. The same study indicates that only 4.1% of respondents practiced various sports activities during their holidays.

A study conducted by TNS Opinion & Social network (Special Eurobarometer survey “Sport and Physical Activity”, 2009) on 26,788 European citizens from the 27 European Union Member States shows that, in Romania, 69% of people never play sport during their free time or do so less than once a month, which leads to a low level of involvement in sport and physical activities as compared to other countries in Western Europe.

According to the National Authority for Disabled People in Romania, the number of registered disabled people represents 3% of the Romanian population (689,680 people in December 2010), compared to World Health Organization estimates, according to which, on average, 10% of the population has a disability. The eligibility criteria are imposed by national policies based on an exhaustive list of medical diagnoses.

By processing data from the General Department for Social Assistance and Child Protection, on the 31<sup>st</sup> of December 2010 the percentage of disabled persons, aged between 18 and 60, non-institutionalized and employees, represented only 8.52%. According to a study conducted in 2009 by the Academic Society of Romania with the support of “Motivation” Foundation, the low percentage is largely due to difficult access to education, especially for people with serious physical

disabilities, somatic or visual impairments, who are being offered poor quality segregated education or homeschooling. Moreover, people with disabilities register significantly low revenues as compared to the general population (the average net salary is about 65% of the national average). As the education and revenue level affects their lifestyle, the insufficient financial resources for this category of population draw on limiting access to tourist and sports activities.

In Romania most hotels, transportation, facilities and touristic sites are not physically accessible for many people with disabilities although, according to Article 21 of the Romanian Law 448/2006 states that: “The competent authorities of public administration are obliged to facilitate access for people with disabilities to cultural values, heritage, tourism, *to sports and recreation*”. The same article states that “... to provide access for disabled people to culture, sports and tourism” the authorities of public administration are obliged to take specific measures as “providing conditions for the performance of sports activities by people with disabilities.”

In 2009 a report of the Department for Social Inspection of the Ministry of Labour performed, on the request of National Authority for Disabled People with Disabilities, on a sample of 183 targets (airports, hotels, halls), shows that in Romania, the access of persons with disabilities to physical environment, information and communication is undertaken in an inappropriate manner, noticing the violation of the Law 448/2006 concerning the protection and promotion of disabled people’s rights.

Tourism employees are not trained to deliver adapted services for disabled individuals. This situation is associated with the absence of explicit government policies and strategies for the promotion of accessible tourism, the lack of performing tourism services and the lack of tourism programs meant to meet those needs.

## Conclusions

Although Romania has natural and anthropic resources, tourist infrastructure is generally not adapted to persons with disabilities. So, it is necessary an inventory of sports tourism offer in terms of accessibility. Following the French model, we propose to create a national label concerning the accessibility for tourist equipment and its promotion. Regarding financial support, it is required the involvement of several ministries such as Ministry of Regional Development and Tourism, Ministry of Labor, Family and Social Protection etc. In the same time, it is necessary to create a differentiated offer by type of disability, as well as to incorporate the specific curriculum into university courses and to train the employees in the tourism industry, in order to provide high quality services to the people with disabilities. A market research in order to know the expectations and needs of tourists with disabilities represents one of priorities, too.

In Romania there is no centralized information about the possibilities to spend the holiday for people with disabilities. So, we propose to create a database available on the Internet which includes information on accessible sites and sports tourism programs adapted to this category of population.

Once these problems will be solved, this tourism sector in Romania will register significant economic growth.

## References

1. *Adapter l'offre touristique aux handicaps. Etude de marche: la population des personnes en situation de handicap et l'offre touristique française.* Guide de savoir-faire. (2009). Agence de Développement Touristique de la France (ATOOUT).
2. Christofle S., Massiera B., Parisot D., Gay J.-C., *Tourisme, loisirs et handicap en espace littoral. La Côte d'Azur entre représentations sociales, enjeu stratégique et aménagement*, Actes du colloque international pluridisciplinaire “Le littoral: subir, dire, agir”, Lille, France, 16-18 janvier 2008.
3. National Authority for Disabled People in Romania. Retrieved from [www.anph.ro](http://www.anph.ro)
4. National Institute of Statistics and Economics Studies (INSEE). Retrieved from [www.insee.fr/en/](http://www.insee.fr/en/)
5. *Personnes handicapées: données statistiques.* (1995). Study Eurostat, Office statistique des communautés européennes, Luxembourg.
6. Sobry, C. et al. (2004). *Le tourisme sportif.* Villeneuve d'Ascq: Presses Universitaires du Septentrion.
7. Special Eurobarometer 334 / Wave 72.3 – TNS Opinion & Social, Sport and Physical Activity, March 2010. Retrieved from [http://ec.europa.eu/public\\_opinion/archives/ebs/ebs\\_334\\_en.pdf](http://ec.europa.eu/public_opinion/archives/ebs/ebs_334_en.pdf)
8. Touche Ross (1993). *Profiting from Opportunities - A new market for tourism.* London: Touche Ross & Co.
9. “Tourism and disability” Association. Retrieved from [www.tourisme-handicaps.org](http://www.tourisme-handicaps.org)
10. World Health Organization. Retrieved from [www.who.int](http://www.who.int)

## MASS SPORTS EVENTS AS A LIFESTYLE: AN EXAMPLE OF CYCLING MARATHON FRANJA 2011

**Samo Rauter and Mojca Doupona Topič**

*University of Ljubljana, Faculty of sport Ljubljana, Slovenia*

Interest in mass sport events all over the world is high and is still rising. In Slovenia, for instance the number of participants in sport events, such as marathons and cycling events is growing. Reasons why people choose active participation in mass sport events are different. It seems that sport and social motives are the most important one. For many of them participation at mass sport events is an integral part of their life or style of life including traveling habits. Cycling festivals and marathons across the world attracts sport enthusiasts, which travel to specific destination because of the reason to attend the event. The study sample consisted of participants of the Cycling marathon Franja, which takes place in Ljubljana. Moreover, 16 in-depth interviews were conducted with selected participants of the event. The aim of this paper is to determine the meaning of active participation in mass sports event for the individuals and how it relates to their travel habits and leisure activities in their daily lives. Furthermore, we will analyse the habits and experiences of the participants of mass events and find out the influence of mass sport events on their lifestyle.

Our study involves a specific population of participants (cyclists) for whom sport activities are important factor of their leisure time. We established correlation between higher level of involvement and the frequency of sport activity and, consequently, more frequent participation in sport events. It was established that experiences from past sport events influenced their way of spending their leisure time. Participation in an event is seen mainly as a social event and a motive for physical activity through the whole year. The latter helps them spend their leisure time in a physically active way more often.

**Key words:** *mass sport events, cyclists, lifestyle*

## GARDENING: NATURAL PANACEA FOR LIFE

**Donald N. Roberson, Jr. and Michal Kudlacek**

*Palacký University, Olomouc, Czech Republic*

### **Purpose**

It is important for us to consider how recreation activities can add to one's health. People all over the world are choosing to spend free time as gardening. And more important, gardening can help meet one's physical activity requirements for a healthy life. But perhaps even more important it may provide a place for leisure and social activity. There are various types of gardens, from formal to incidental plots of ground in one's backyard. Garden colonies are groups of individual gardens near urban areas; they are prominent in central Europe. The purpose of this study is to learn more about the gardener's experience within a garden colony.

It is common knowledge that more people today are living in urban areas or cities with crowded and noisy situations. Even though gardening used to be for a few privileged, we suggest that gardening offers a redemption of this lost time for today's busy individual. Gardens can be a place where we remember what life used to be as well as a positive use of one's free time.

There is a need to provide places for safe and effective physical activity. Physical activity can waiver between mundane workouts to trendy workout facilities with the latest fads in health and fitness. The increase in medical expense, as well as the rise in preventable diseases such as Type 2 Diabetes call for a revision of our concept of physical activity, recreation, and free time.

### **Method**

The methodology of this research is based on observations, interviews, questionnaires, and focus group. We chose a garden colony near the town of Olomouc, Czech Republic. We observed this garden colony, received questionnaires from 50 gardeners, interviewed and visited two of the gardeners, and formed a focus group.

### **Results**

Findings indicate gardening and the garden space are a vital part of the lives of these participants, the garden colony provides a community of individual plots of gardens, and participants sense they are healthier because of gardening.

### **Conclusion**

Implications are significant as our population is aging, and older adults are looking for ways to spend their time. Further, our free time seems to be lost among busy activities; garden colonies offer a unique and historical way to redeem our free time.

**Key words:** *garden colony, Czech Republic, questionnaire, focus group, physical activity*

## RELATIONS BETWEEN PHYSICAL ACTIVITY AND ANXIETY SYMPTOMS

Danijel Jurakić, Željko Pedišić and Zrinka Greblo

*Faculty of Kinesiology, University of Zagreb, Croatia*

### Purpose

Although there is a solid body of evidence regarding the role of exercise programs in reduction of anxiety symptoms, the studies of relations between habitual physical activity (PA) and anxiety symptoms are still rare. The goal of this study was to determine the relations between PA in four domains (work, transport, domestic, and leisure-time) and anxiety symptoms in the general population.

### Methods

The study was conducted on a random sample of 1029 Croatian inhabitants (51.6% women). In order to assess PA and symptoms of anxiety, the International Physical Activity Questionnaire (IPAQ) and Check-list of Anxiety Symptoms (chest pressure, insomnia, intrusive memory, lump in the throat, nervousness, and rapid heart rate) were used, respectively.

### Results

Among women, Spearman rank correlations showed that work domain PA was positively related to insomnia ( $r=0.09$ ) and lump in the throat ( $r=0.09$ ), while leisure-time PA was inversely related to nervousness ( $r=-0.18$ ) and intrusive memory ( $r=-0.16$ ). Among men, domestic domain PA was positively related to nervousness ( $r=0.11$ ), while transport domain PA was inversely related to chest pressure ( $r=-0.10$ ), and leisure-time PA to all anxiety symptoms, except insomnia (ranged from  $-0.10$  for rapid heart rate to  $-0.19$  for chest pressure). All correlations were controlled for age, size of settlements, educational level, personal income, smoking, alcohol intake, and body mass index.

### Conclusion

The findings suggest that the relationship between PA and anxiety symptoms varies throughout different PA domains. Anxiety symptoms were positively related to PA in work and domestic domains and inversely related to PA in transport and leisure-time domain. It can be concluded that relations between PA and anxiety symptoms represent a complex research issue, since not only that there are opposite relations between different domains of PA and some anxiety symptoms but also patterns of those relations differ among women and men.

**Key words:** *physical activity, anxiety, population-based study, International Physical Activity Questionnaire, IPAQ*

## **“COMBAT SPORTS PROPEDEUTICS – BASICS OF JUDO” AS EMPIRICALLY VERIFIED PROPOSITION FOR ALL TYPES OF SCHOOLS AND AS MODERN HEALTH-RELATING TRAINING**

**Roman M. Kalina**

*The Podhale State Vocational School of Higher Education, Nowy Targ, Poland*

*Faculty of Physiotherapy, Academy of Physical Education, Katowice, Poland*

### **Abstract**

There is ample empirical proof that an effectively implemented judo training may be accepted as one of the most valuable and attractive ‘life sports’ – i.e. one that can be practiced from early childhood until old age. Yet there is data that more than 60% of judo adepts leave their dojo during the first three month of training. Unfortunately this negative effect results from focusing attention by judo trainers on technologies of training and striving at quick sports achievements. Judo is first of all a universal and timeless system of physical and moral education, which may be considered a truism. Judo may be recommended successfully in at least four fields: 1) biological development; 2) movement competencies (safe falling as protection of the body in situations of impacts and falls; preparation in the scope of self-defense; efficiency and coordination of body movements); 3) spiritual (moral) development; 4) quality of social functioning. Consequently it is the goal of this study to recommend “Combat sports propedeutics” (two parts: basics of judo; judo in self-defense) as an empirically verified programme proposal for all types of schools and for all education levels – from primary schools to universities. In my opinion the application value is all the more important as judo may constitute an alternative to a lot of pathologies of modern schools including in particular the pathology of violence and aggression. “Combat sports propedeutics – basics of judo” is also an excellent program to achieving the main goals of complementary health-related training, whose leading element is the prevention of injuries. This training can be implemented in the family or/in friends circle, etc. It can also be an effective alternative to the inadequacies of physical education.

**Key words:** *complementary health-related training, prevention of injuries, self-defense*







**6<sup>th</sup> INTERNATIONAL  
SCIENTIFIC  
CONFERENCE ON  
KINESIOLOGY**

**“INTEGRATIVE POWER OF  
KINESIOLOGY”**

**Kinesiology and  
Social Sciences  
(Sociology,  
Psychology,  
History,  
Philosophy)**

**Editors:  
Prof. Ksenija Bosnar, PhD**

**Peer Reviewers:  
Prof. Ksenija Bosnar, PhD  
Prof. Benjamin Perasović, PhD  
Prof. Vesna Buško, PhD  
Prof. Matej Tušak, PhD  
Prof. Rado Pišot, PhD  
Prof. Franjo Prot, PhD**



**Secretary:  
Prof. Goran Sporiš, PhD**

## EMOTION-CENTERED AND ACTION-CENTERED PROFILING IN SPORT: INCORPORATING THE CONCEPT OF INDIVIDUAL DIFFERENCES

Juri L. Hanin

*Research Institute for Olympic Sports, Jyväskylä, Finland*

### Abstract

The study of emotions related to athletic performance has been greatly enhanced by the availability of standardized emotions scales (e.g., STAI, CSAI-2, STAXI, POMS, PANAS, and Affect Grid). The recent development includes more emphasis on the individualized profiles with athlete-generated idiosyncratic emotion labels (e.g., the standard IZOF-profiling and the aggregated Emotion State Profile (ESP-40) Hanin (2010). Progress in emotion-centered profiling (ECP) is possible if emotional experiences (pleasant-unpleasant and functionally optimal-dysfunctional) are connected with such modalities of the *psychobiosocial* (PBS) state as *cognitive, motivational, volitional, bodily, kinesthetic, operational (action), communicative* (Ruiz, Hanin, & Robazza, 2011). However, a better understanding of emotion-performance relationships requires also the assessment of the *task execution process*. Existing assessment tools usually focus mainly on performance *outcomes* (objective-subjective and normative or self-referenced) but not on performance process (action). Even “performance profiling” proposed by Butler (1992) assessed general qualities important for successful performance in the selected sport and on the characteristics of top performers. The ideal performance characteristics (physical, technical, psychological) were then contrasted with the athlete’s levels to identify the direction of his or her future development.

To address these concerns, the action-centered profiling (ACP) as a supplement and extension of the IZOF-based ECP was proposed and its validity and practical utility were examined across twelve sports (Hanin & Hanina, 2006, 2009; Hanin, 2010). The main focus in the ACP is on a *task execution or performance process* described by the self-perceived actions or a movement sequence (“a chain”) performed in a competition. The ACP within the framework of the Identification-Control-Correction (ICC) program (Hanin & Hanina, 2009) provides a practical tool for dealing with inconsistency of athletic performance (*skill instability*, a “*lost move syndrome*”, and “*habitual*” performance errors). The ACP includes four parts based on the analysis of athlete’s past performance history and the present situation: 1. Optimal Focus in training and competitions; 2. Athlete-generated Action Sequence (a chain); 3. Effort Intensity Dynamics in Action; and 4. Action Outcomes (qualitative & quantitative). Our findings suggest that ECP and ACP can be used to evaluate the efficacy of emotion-focused and action-focused coping and the interactions between emotion and action. For instance, it was revealed that optimization of action triggers functionally optimal emotions whereas dysfunctional emotions reflect the disrupted performance process. Therefore, the ECP and ACP should be included in the assessment program as a part of emotion-focused and action-focused coping in high achievement sport. Examples of ECP and ACP in different sports will be presented and future research directions using both types of profiling will be suggested.

**Key words:** *emotion-focused, action-focused, ECP, ACP*

### Introduction

The study of emotion-performance relationships has been one of the most important research directions and in sport psychology for several decades. In earlier research, the emphasis was usually on assumptions based on task characteristics or inter-individual and group effects. Numerous of research findings suggest that a better understanding of emotion-performance relationships can be achieved by employing the frameworks that account for individual differences (Raglin, 1992; Hanin, 1997). An explicit incorporation of the concept of individual differences in sport is especially relevant considering the fact that emotion-performance relationships are bi-directional. On the one hand, emotions affect the quality of performance process and the level of performance outcomes; on the other hand, performance process and performance outcomes impact the content and intensity of emotional experiences (Hanin, 2000). Therefore, to investigate this relationship, of crucial importance is an accurate assessment of both actions and accompanying emotional experiences. Although there is a clear abundance of various tools to assess performance-related emotions, methods to describe task execution process (action) are still missing. The goal of this presentation is to review selected issues in emotion and action (performance) measures and to explore how the concept of individual differences can be incorporated in the assessments of both emotions and actions.

## Emotion-centered profiling in sport

### Emotion as a category of experience

To study something as an *indivisible unity*, according to Vygotsky (1926/1984), it is necessary to find a construct that appropriately captures the characteristics of both interacting elements. In psychology, *experience* is such a construct to study person-environment (P-E) interactions as it reflects a person's attitude towards different aspects of the environment and the meaning of the environment for the person. Emotional experience has a biosocial orientation and is best represented as a unit of consciousness and as an indivisible component of total human functioning reflects the nature of past, ongoing, or anticipated P-E interactions. Thus the analysis of any difficult situation should focus not so much on the situation or on the person per se but on *how this situation is experienced by this person* (see Hanin, 2007 for a more detailed review).

Vygotsky (1926/1984) proposed to identify three types of P-E interactions: the predominance of an organism over the environment, the P-E balance, and the predominance of the environment over an organism. These notions were applied to performance emotions in sport (Hanin, 1997) and it was proposed that P-E interactions are best represented by the relationships between task demands and a person's resources (Hanin, 2003). From this perspective, emotion research in sport should describe, predict, and explain an athlete's optimal and dysfunctional *experiences* accompanying individually successful and poor performances. A working definition of experience includes the totality of past and present characteristics that determines the quality of a person's performance (Hanin, 2003).

### State-like, trait-like experiences and meta-experiences

In the sport context, there are three interrelated types of performance-related experiences: *state-like experiences* or situational emotional states as a component of situational, multimodal, and dynamic manifestations of total human functioning; *trait-like experiences* or relatively stable repeated emotion patterns (emotionality, emotion expertise, dispositions, qualities, habits) reflecting a nature of athletic activity; and *meta-experiences* (awareness, attitudes, preferences, rejections of one's experiences) which are the reflected experiences or lessons learned in successful and unsuccessful performances (Hanin, 2007). In contrast to actual situational states and repeated patterns of experience, meta-experiences reflect how an athlete feels about his or her past, present, or anticipated emotional experiences and the perceived effects of these emotional experiences on performance and/or general well-being.

If an athlete, for instance, feels nervous prior to a competition, that characterizes his or her situational emotional state triggered by a specific meaning of this particular situation. On the other hand, feeling nervous can be a typical (repeated) experience of this athlete's emotional response in similar situations. In this case, trait competition anxiety would indicate how often the athlete experienced elevated anxiety and felt nervous and tense prior to or during competition. An athlete's meta-experience is an attitude to experiencing a high level of competition anxiety and awareness of its helpful (or harmful) effects on performance. Meta-experiences are formed when athletes spontaneously or deliberately reflect on the conditions leading to their successful and unsuccessful performances. Meta-experiences determine an athlete's perception and a choice of coping and self-regulation strategies, and therefore should be a major target of interventions. Most of research in sport psychology during the past two decades has focused mainly on situational emotional states (such as competition anxiety) and relatively stable emotion patterns (for instance, trait anxiety). Meta-experiences in sport, although undefined as a separate parameter (Hanin, 2003), were actually implied in the assessment of optimal and dysfunctional zones of emotion intensity (Syrjä & Hanin, 1998), and in the ratings of "directional" anxiety (or perceived impact) on performance (Jones, 1995). In practice, emotion regulation is often based on reframing an athlete's attitudes to specific situations and emotional experiences. Meta-experience adds a special meaning and quality to perceived situational state which is interpreted (or re-interpreted) as facilitating or debilitating. Therefore, the role of meta-experiences as determinants of appraisal and coping processes should be re-emphasized, especially in intervention studies. Therefore, based on Vygotsky's suggestion, emotion in our approach is construed not so much as a reaction (as in traditional frameworks) but as a situational or repeated experience and meta-experience reflecting the dynamics of P-E interactions.

### Multidimensionality of performance-related experiences

Five basic dimensions capture defining characteristics of emotion experience as a component of different psychobiosocial (PBS) states related to performance (Hanin, 1997, 2000, 2003). It is argued that emotional experience is always manifested in some *form* (subjectively perceived or observable); it has specific *content* (or quality); it is characterized quantitatively by its *intensity* and as a process that unfolds over *time* (Folkman & Lazarus, 1985) in a particular *context*. Thus the multilevel and system description of emotion as a component of performance-related PBS states should include at least five interrelated dimensions: *form*, *content*, *intensity*, *time*, and *context*. These five basic dimensions provide a tool for a systems description of emotional experiences (for more detail, see Hanin, 1997, 2000, 2003; Robazza, 2006). The following sections focus on emotion-centered profiling based on a brief characterization of form, content, and intensity dimensions that incorporate the concept of individual differences. Specifically, the emphasis is on within-individual assessments of

experiences in a particular athlete across different situations and on employing the individual-oriented (self-generated and idiosyncratic) descriptors (emotion and non-emotion labels) - see below.

### **Emotion and Non-emotion Experiences**

Because emotion, as a concept, remains largely undefined, it is not surprising that distinctions between emotion and non-emotion experiences are sometimes not quite clear. In fact, there is often an overlap, especially in the assessments, between emotion and non-emotion. For instance, an inspection of the 10 global affect scales described by Watson and Tellegen (1985) shows that some of the items are “conceptually faulty and would not be considered emotions by appraisal-centered theorists” (Lazarus, 2000, p. 239). In other words, it is acknowledged that emotion descriptors in existing emotion scales often represent not only “pure” emotions, but also non-emotion components of a state (cognitive, motivational, bodily, or behavioral). Obviously, in research, it is important to clearly distinguish among emotion, non-emotion and borderline modalities of a state (Lazarus, 2000). From the applied perspective, however, a more holistic description of the performance-related state, including emotions and non-emotion experiences, could be equally important and appropriate, especially in individual-oriented interventions.

Several studies were undertaken to examine emotion and non-emotion components of the PBS state. For instance, Hanin (1999), used seven positively toned items (*motivated, willing, desirous, hopeful, keen, daring, and interested*) and seven negatively toned descriptors (*unmotivated, unwilling, reluctant, hopeless, bored, compelled, and uninterested*), that are often used in self-descriptions of athletes motivations. These items discriminated quite well the motivational states in 29 highly skilled ice-hockey players before their successful and unsuccessful games. Another direction of research focused on how the athletes use their own vocabulary of idiosyncratic labels to describe their performance-related experiences. As expected, this vocabulary included not only emotion words but also several non-emotion modalities (Hanin, 1997; Hanin & Stambulova, 2002; Robazza, Bortoli, and Hanin, 2004; Ruiz & Hanin, 2004). As of today, these data suggest that an athlete’s performance-related state manifests itself in the eight (Hanin, 2010; Ruiz, Hanin, Robazza, 2011) instead of initially proposed seven (Hanin, 1997) basic modalities. These modalities with selected descriptors include *cognitive* (alert, focused, confused, distracted), *affective or emotional* (worried, nervous, happy, angry, joyful, fearful), *motivational* (motivated, willing, desirous, interested), *volitional* (determined, brave, daring, persistent), *bodily* (tired, jittery, restless, sweaty, painless, breathless), *kinesesthetic* (sluggish, relaxed, sharp), *operational* (smooth, effortless, easy, clumsy actions), and *communicative* (connected, related, in touch) modalities. The validity of these assumptions regarding multimodal description of PBS states were tested empirically in different sports (Bortoli & Robazza, 2007; Hanin & Stambulova, 2002; Ruiz & Hanin, 2004; Würth & Hanin, 2005).

### **Emotion content dimension**

Emotion content as a qualitative characteristic is one of the basic dimensions in the systematic study of emotional experiences. Both quality and intensity determine the functional impact of emotions upon performance and well-being. Two traditional approaches to categorizing emotion content are the *dimensional* (global affect) approach and *discrete* (basic) emotion approach. The global approach emphasizes pleasantness-unpleasantness (valence or hedonic tone), tension-relaxation, and quiescence-activation (Russell, 1980; Watson & Tellegen, 1985). The discrete emotion approach centers on discrete categories of emotion based on their qualitative content (anxiety, anger, joy, etc.) and claims that there are clusters of “universal” and discrete emotion syndromes (Lazarus, 2000). Although the notion of emotion types is attractive for some emotion researchers, they still reject the idea that there is a set of “basic” emotions. Another objection is that any list of basic (discrete) emotions, ranging from three (Spinoza), to six (Ekman), or ten (Izard) and fifteen (Lazarus), remains arguable. Hanin (1999) compared basic emotion labels proposed by 23 investigators representing eight different approaches to emotion research. It was found that, all in all, there were 47 labels of basic emotions (with 32 negatively toned and 15 positively toned emotion descriptors). The most selected emotion labels were *fear* (19 researchers), *anger* (18), *sadness* (9), and *disgust* (7); 23 labels were proposed only once, and ten labels were selected twice (see Hanin, 2007 for a review).

Although any list of discrete emotions is arguable, at least two important aspects were clearly identified by Lazarus (2000). First, the list should include both negatively-toned emotions (e.g., anger, anxiety, fright, sadness, guilt, shame, envy, jealousy, disgust) and positively-toned emotions (relief, hope, happiness/joy, pride, love, gratitude, compassion). Second, regardless of the exact list, a primary empirical and theoretical concern is to identify the *most important emotions*, their distinctive characteristics, antecedent causal variables and consequences, and *how they might influence competitive performance in sports*” (Lazarus, 2000, p. 232, italics added). It is argued that in competitive and high achievement sports, the most important emotions are usually personally relevant, task specific and functionally helpful or harmful emotions.

This assumption has received a strong empirical support (Hanin, 1997, 2000, 2007, 2010; Robazza, 2006) and is based on the notion that “under similar environmental conditions, people perceive themselves differently, think differently, cope differently, and experience and display emotions differently” (Lazarus, 1998, p. 213). Thus, the functional importance of emotional experiences is associated with their goal relevance and with the extent that each athlete is able to perform up to his or her potential using effectively available resources. In contrast, the usual laboratory study of emotion assumes that

if the stimulus conditions are equal for all subjects, then the average of all subjects' responses best represent the group for the variable measured. Implicit in this assumption is the idea of equivalent life and performance histories, which obviously cannot be met in studies with humans.

### **Idiosyncratic Emotion Content**

To identify person-relevant and functionally important emotional experiences, the Individual Zones of Optimal Functioning (IZOF) model (Hanin, 1993, 1997, 2000, 2007, 2010) proposes that athletes use their own vocabulary of self-generated idiosyncratic labels. These self-generated emotion labels describe athletes' subjective pleasant and unpleasant experiences prior to (or during) their successful and poor performances. The implication here is that success-related experiences are helpful for (or at least do not disturb) an athlete's performance, whereas failure-related experiences are detrimental (harmful) for this individual's performance. For instance, the functionality of emotions can be based on anticipated emotion effects on post-performance recovery, performance-induced injuries (Devonport, Lane, Hanin, 2005; Würth & Hanin, 2005), or an athlete's general well-being. Empirical findings also suggest that functionality of emotions relevant with respect to one criterion, for instance, performance, is not necessarily relevant for other outcomes, such as leisure quality, post-injury recovery, or general well-being in healing or educational settings. In other words, in each particular setting, emotion function-dysfunction should be clearly specified as a set of intrapersonal, interpersonal, health, or well-being consequences (see Oatley & Jenkins, 1992 for a general discussion of emotion function and dysfunction).

In the IZOF approach developed for the high-achievement setting, emotion content is conceptualized within the framework of two interrelated factors: *hedonic tone* or valence (pleasure-displeasure) and *performance functionality* (optimal and dysfunctional effects on performance processes and outcomes). Both factors reflect qualitatively different aspects of emotional experiences related to individually successful and poor performances (Hanin, 1997). Selected idiosyncratic emotion labels are classified into one of the four global emotion categories derived from the hedonic tone and performance functionality: pleasant and functionally optimal emotions (P+), unpleasant and functionally optimal emotions (N+), pleasant and dysfunctional emotions (P-), and unpleasant and dysfunctional (N-) emotions. Optimal (P+ and N+) emotional experiences accompany successful performances, whereas dysfunctional (N- and P-) emotional experiences are usually related to poor performance.

These four emotion categories provide an initial structure that is sufficiently broad and robust to generate a pool of individually relevant and task-specific emotions experienced by athletes prior to, during, and after their successful and unsuccessful performances. It is important that athlete-generated labels describe idiosyncratic and experientially grounded emotions. Moreover, the individualized framework provides an opportunity for athletes to reflect on and report their most significant pleasant and unpleasant emotional experiences related to their individually successful and poor performances. Self-generation of idiosyncratic personally relevant labels assisted by an emotion stimulus list (Hanin, 1997, 2000, 2003; Robazza & Bortoli, 2003) or based on aggregated emotion profile (ESP-40, Hanin, 2010), is a feature that makes the IZOF approach different from the global affect and discrete emotion approaches.

In the individualized approach, the pleasure-displeasure distinction is similar to a global dimensional approach, which however, does not have "function-dysfunction" distinction. Additionally, the four category global framework does not limit, in any way, the selection of most appropriate idiosyncratic emotion descriptors. Therefore, athletes reconstruct their performance-related experiences by generating their own idiosyncratic labels. They are not forced to "squeeze" their unique subjective experiences into researcher-generated descriptors of pre-selected discrete emotions (such as anxiety, anger, joy, etc). Moreover, self-generated labels reflecting an athlete's perspective, when aggregated across athletes and sport events (e.g., ESP-40), identify prototype (most often selected) emotional experiences that can be re-categorized using a selected discrete emotion framework (Hanin, 2000, 2010; Robazza, 2006; Ruiz & Hanin, 2004, Ruiz, Hanin, Robazza, 2011; Syrjä & Hanin, 1998).

### **Group-oriented and individualized emotion measures**

Research findings and practical experiences in assessments suggest that the content of athlete-generated emotion labels are often different from researcher-generated emotion labels used in several existing standardized scales. To test this assumption, emotion experiences of individual athletes should be contrasted with standardized group-oriented emotion scales that are currently used to describe how athletes feel before, during or after performance. The most popular scales developed in non-sport settings are Spielberger, Gorsuch, and Lushene's (1970) State-Trait-Anxiety Inventory (STAI), McNair, Lorr, and Droppleman's (1971) Profile of Mood State (POMS), and Watson and Tellegen's (1985) Positive and Negative Affect Schedule (PANAS). Sport-specific scales include Martens, Vealey, and Burton's (1990) Competitive State Anxiety Inventory (CSAI-2) and Smith, Smoll, and Schutz's (1990) Sports Anxiety Scale (SAS).

One problem with most group-oriented scales is that they use a pool of researcher-generated items with "fixed" emotion content (global or discrete). These similar emotion items usually imply the same psychological meaning of emotion descriptors for all athletes. However, in most cases, it is not known to what extent emotion content assessed with the group-oriented scales reflects emotion content really experienced by individual players in their successful and

poor performances. Two studies involving 50 skilled soccer players and 46 ice-hockey players compared the content of emotion items in STAI, POMS, PANAS, and CSAI-2 scales and individual emotional experiences assessed by athlete-generated labels (Syrjä & Hanin, 1998). The findings revealed that from 80% to 85% of self-generated emotion labels were not included in the selected standardized scales. In other words, the scales with researcher-generated items did not assess most of the emotional content of athletes' performance-related subjective experiences. These findings received additional empirical support in the study involving Spanish elite karate athletes who expressed individual preferences in the selection of idiosyncratic labels describing their anger states of varying intensity (Ruiz, 2004).

In another study (Ruiz & Hanin, 2004), idiosyncratic emotion labels generated by 16 high-level Spanish karate athletes were compared with the list of 15 discrete emotions proposed by Lazarus (2000). In individualized emotion profiling, these athletes generated 98 idiosyncratic, symbolic, and functionally meaningful metaphors and 167 interpretative labels describing how they felt prior to, during, and after their best and worst performances. As expected, self-generated interpretative emotion descriptors were highly idiosyncratic and context-specific. These self-generated idiosyncratic labels were related to three pleasant discrete emotions (happiness, pride, and relief) and three stress-related unpleasant emotions (anger, anxiety, and sadness). Additionally, athletes' experiences in worst performance were related to fright and shame. Interestingly, the athletes' self-generated labels had no content overlap with seven other discrete emotions (love, hope, compassion, gratitude, envy, jealousy or guilt) proposed by Lazarus (1991, 2000). These findings suggest a specificity of emotion content in high achievement settings, especially if the emphasis is on such extreme and qualitatively different situations as success and failure.

Most of the research in sport psychology during the last decades has focused on selected stress-related emotions, such as anxiety. As a result, the complex picture of actual emotional experiences was oversimplified and incomplete. Research into pleasant and unpleasant idiosyncratic emotions has made it increasingly clear that in real life situations, athletes' experiences are better described by mixed rather than by single selected emotions (Gould & Tuffey, 1996; Hanin, 1997, 2000, 2003; Jones, 1991; Morgan, 1984; Plutchik, 1980; Schimmack, 2001; Syrjä & Hanin, 1998). Also the effect of discrete emotions, such as anxiety or anger, should be analyzed within the context of other, potentially related, emotions. It was also revealed that there are emotion mixtures and mixtures of non-emotion components (*alert, energized, motivated, determined*) of the psychobiosocial state (Hanin, 1993, 1997). Progress in emotion-centered profiling can be enhanced if idiosyncratic emotional experiences (pleasant-unpleasant and functionally optimal-dysfunctional) are related to such non-emotion modalities of the PBS state as *cognitive, motivational, volitional, bodily, kinesthetic, operational (action), communicative* (Ruiz, Hanin, & Robazza, 2011).

## Action-centered profiling

### Assessment of performance outcomes

A better understanding of emotion-performance relationships requires also the individual-oriented assessment of the *task execution* or *performance process*. A serious issue in emotion-performance research involves the quantification of sport performance (Raglin, 1992). Assessment of performance in sport is still problematic because the existing assessment tools usually focus mainly on performance *outcomes* (objective-subjective and normative or self-referenced) but not on performance process (action). First, the absolute or "raw" performance (outcome) scores which are misleading because transitory factors may affect outcome; Second, the use of absolute values limits meaningful contrasts across athletic events; Third, a better option was to quantify each athlete's attained performance in relative, self-referenced terms (a percentage of one's own personal best ; average capability (intraindividually based measure), the average (recent, current season, composites measures), and criterion-referenced method (a qualifying standard). All these options deal mainly with the use of the measures at the interindividual and group level of comparison. Apparently, a different and more individualized approach should be employed for intra-individual (within) comparisons. As already mentioned, incorporating the concept of individual differences into emotion-performance relationships involves intra-individual measures capturing idiosyncratic aspects in both – emotional experiences (IZOF profiling) and in action (task execution process).

### Butler's (1992) Performance profiling

Performance profiling as an assessment method was proposed by Butler (1992) to quantify the general *qualities* important for successful performance in the selected sport and the characteristics of top performers in this sport. The ideal performance characteristics (physical, technical, psychological) were then contrasted with the athlete's levels to identify the direction of his or her future development. The method actually assessed these factors as perceived by the coach and athletes to facilitate their cooperation and communication. Although performance profiling proved to be useful in mainly individual sports, it did not assess task execution as a continuous performance process.

### Action-centered profiling

To address these concerns, the action-centered profiling (ACP) as a supplement and extension of the IZOF-based emotion-centered profiling was proposed and its validity and practical utility were examined across twelve sports (Hanin, 2010; Hanin & Hanina, 2009). The emphasis in the ACP is similar to emotion profiling: the action labels generated by the athlete are idiosyncratic; action profiles are constructed based on the analysis of successful and unsuccessful performance situations. However, the main focus in the ACP is on a *task execution* or *performance process* as described by the self-perceived actions or a movement sequence (“a chain”) performed in a competition. This sports-specific research-based psycho-pedagogical program (termed *Identification-Control-Correction* – ICC program) deals mainly with performance difficulties in top-level athletes. Such a framework was developed and tested in multiple case-studies in athletics (jumping, throwing, and running), swimming, diving, car racing, pistol shooting, volley-ball, and soccer. The ACP within the framework of the Identification-Control-Correction (ICC) program (Hanin & Hanina, 2009) provides a practical tool for dealing with inconsistency of athletic performance. A movement sequence is performed and described by the quality of interconnected actions. The ICC program includes identification of individually optimal performance, control and monitoring of performance in practices and competitions, and correction of habitual performance errors. In the sections that follow, a brief overview of the assessment procedures employed in the ICC program is provided. The entire approach is described in more details elsewhere (Hanin & Hanina, 2009).

### Identification of Individually Optimal Performance

In the identification of individually optimal performance, the athlete constructs an image of the motor task in her sport as a chain of interrelated action components. For instance, the Olympic level diver described a forward dive in pike position with 2.5 somersaults (105B) as a sequence of eight action components: *forward approach, pre-jump (hurdle), take off, throw the arms forward, pike down, line up and water entry* (see Hanin & Hanina, 2009, pp. 89-91 for details).

A list of self-generated task components serves as a starting point for self-reflection to increase conceptual (self-knowledge) and physical (bodily) awareness of the optimal movement pattern. Optimal execution of each component in the chain (movement sequence) is then described with accompanying experiences. To identify and enhance an athlete’s awareness of optimal and non-optimal movement patterns and to examine the differences between successful and unsuccessful task executions, the athletes select three personally best and three poor task executions in their specific event. Self-ratings help the athlete to learn the rating procedure and see if a draft of the initially selected components works well in self-descriptions. Usually self-ratings of 10-15 task executions are sufficient to make an athlete aware of effects of different components on performance outcomes and how these components affect each other. Athletes also begin to understand how their different foci affect performance (Rantanen, Hanin, & Hanina, 2007).

By the end of the action identification, the athlete has a clear picture of the components of the chain and understands the role of optimal difference in intensity of effort (starting and final). Athletes are also aware of the variability ranges of each component in their good and poor performances. This analysis is complete when an athlete can report how he or she perceives the process of the task execution and thus the conceptual (self-knowledge) awareness of the skill is achieved. Additionally, an athlete acquires a new understanding of why he or she is successful or unsuccessful in the task execution.

To summarize, the ACP includes four parts based on the analysis of the athlete’s recalled past performance history and the present situation. The athlete first describes using his own words the entire action as a sequence of interconnected components. Then he selects three best and three poor performance actions. The notion of individually optimal performance reflects a person’s individual style in realization of skill based on one’s strengths and special characteristics affecting performance. The ICC program starts with the *identification* of individually optimal performance, which includes: a) Athlete-generated list of subjectively perceived movement components; b) Description of the ideal performance of each component based on the athlete’s past experience; c) Core component(s) affecting positively the outcomes of the task execution; d) A list of pre-performance foci (mind-sets and thoughts) in successful and unsuccessful performances; e) The notion of effort intensity and its optimal range in successful performances.

In other words, a complete action profile includes four parts: 1. Optimal focus in training and competitions; 2. Athlete-generated action sequence (a chain) with the description of its optimal execution; 3. Effort intensity dynamics in action (from the beginning till the end of action); and 4. Action outcomes (qualitative & quantitative). An athlete recalls retrospectively (usually assisted by videos) his or her successful and unsuccessful performances. Optimal execution of each component in the chain is then defined with any accompanying subjective experiences.

Our findings suggest that emotion-centered and action-centered profiling can be used to evaluate the efficacy of emotion- and action-focused coping and the interactions between emotion and action. For instance, it was revealed that optimization of action triggers functionally optimal emotions whereas dysfunctional emotions reflect the disrupted performance process. Therefore, the emotion-centered and action-centered profiling should be included in the assessment program as a part of coping in high achievement sport.



## A summary and conclusions

The proposed emotion-centered and action-centered profiling suggests an individualized approach to the analysis of emotion-performance relationships. Emotion profiling has been already sufficiently individualized by using within-individual assessments and the employment of idiosyncratic emotion descriptors. Action-centered profiling with idiosyncratic process measures aims to assess intra-individually the action process at the situational level as well. Both forms of individualized emotion and action profiling aim to enhance a better understanding of emotion-performance relationships.

## References

1. Devonport, T.J., Lane, A.M., Hanin, Y.L. (2005). Emotional States of Athletes prior to Performance-induced Injury. *Journal of Sports Science and Medicine*, 4, 382-394.
2. Folkman, S. & Lazarus, R.S. (1985). If it changes it must be a process: Study of emotion and coping during three stages of a college examination. *J. of Personality and Soc. Psychology*, 48 (1), 150-170.
3. Gould, D. & Tuffey, S. (1996). Zones of optimal functioning research: a review and critique. *Anxiety, Stress, and Coping*, 9 (1), 53-68.
4. Hanin, Y.L. (1997). Emotions and Athletic Performance: Individual Zones of Optimal Functioning Model. *European Yearbook of Sport Psychology*, 1, pp. 29-72.
5. Hanin, Y.L. (Ed.). (2000). *Emotions in sport*. Champaign, Illinois: Human Kinetics.
6. Hanin, Yuri L. (2003, February). Performance Related Emotional States in Sport: A Qualitative Analysis [48 paragraphs]. Forum Qualitative Sozialforschung / Forum: *Qualitative Social Research* [On-line Journal], 4 (1). See at: <http://www.qualitative-research.net/fqs-texte/1-03/1-03hanin-e.htm>
7. Hanin, Y. (2007). Emotions in Sport: Current issues and perspectives. In G. Tenenbaum & R.C. Eklund (Eds.). *Handbook of Sport Psychology* 3<sup>rd</sup> ed. (pp. 31-58). Hoboken, NJ: John Wiley & Sons.
8. Hanin, Y.L. (2010). Coping with Anxiety in Sport. In: Adam Nicholls (Ed.) *Coping in Sport: Theory, Methods, and Related Constructs* Nova Science Publishers, Inc. (pp. 159-175).
9. Hanin, J., & Hanina, M., with the Commentators (2009). Optimization of performance in top-level athletes: An Action-Focused Coping. *International Journal of Sport Sciences & Coaching*, 4 (1), pp. 47-91.
10. Hanin, Y.L., & Stambulova, N. B. (2002). Metaphoric description of performance states: An application of the IZOF model. *The Sport Psychologist* 16 (4), 396-415.
11. Jokela, M., & Hanin, Y. (1999). Does Individual Zones of Optimal Functioning Model discriminate between successful and less successful athletes? A meta-analysis. *Journal of Sport Sciences*, 17, 873-887.
12. Jones, G. (1995). Competitive anxiety in sport. In: S.J.H. Biddle (Ed.), *European Perspectives on Exercise and Sport Psychology*. (pp.128-153). Leeds, UK: Human Kinetics.
13. Lazarus, R.S. (2000). How Emotions Influence Performance in Competitive Sports. *The Sport Psychologist*, 14, 229-252.
14. Oatley, K., & Jenkins, J.M. (1992). Human emotions: function and dysfunction. *Annual Review of Psychology*, 43, 55-85.
15. Raglin, J.S. (1992). Anxiety and sport performance. In: J.O. Holloszy (Ed.), *Exercise and sports sciences reviews*, (Vol. 20, pp.243 - 274). Baltimore, MD: Williams & Wilkins.
16. Robazza, C. (2006). Emotion in sport: An IZOF perspective. In S. Hanton & S. D. Mellalieu (Eds.), *Literature reviews in sport psychology* (pp. 127-158). New York: Nova Science.
17. Robazza, C., Pellizzari, M., & Hanin, Y. (2004). Emotion Self-regulation and Athletic Performance: An Application of the IZOF Model. *Psychology of Sport and Exercise*, 5 (4), pp. 379-404.
18. Ruiz, M.C., & Hanin, Y. L. (2004). Metaphoric description and individualized emotion profiling of performance related states in high-level karate athletes. *Journal of Applied Sport Psychology*, 16 (3), 1-16.
19. Ruiz, M., Hanin, Y. L. & Robazza, C. (2011). *Assessment of Performance-related Psychobiosocial (PBS) state: An exploratory study*. A poster presentation at the AASP conference, 20-24 September, Honolulu, HI.
20. Syrjä, P., & Hanin, Y. (1998). Individualized and group-oriented measures of emotion in sport: A comparative study. *Journal of Sports Sciences*, 16 (5), 398-399.
21. Vygotsky, L.S. (1926/1984). *Sobranie sochinenii*, [A six-volume collection of works], In D. B. El'konin (Ed.) *Child Psychology* (vol.4, p. 247). Moscow, USSR: Pedagogika. (Original work published in 1926).
22. Würth, S. & Hanin, Y.L. (2005). Der emotionale Vorstartzustand im Zusammenhang mit Sportverletzungen.(Pre-performance Emotional State related to Sport Injuries). *Leipziger Sportwissenschaftliche Beiträge (LSB)*, 46 (1), 117-143. Academia Verlag. Sankt Augustin.

## COMPETITIVE ANXIETY AND GOAL ORIENTATION IN CROATIAN ATHLETES

Renata Barić<sup>1</sup> and Igor Čerenšek<sup>2</sup>

<sup>1</sup>*Faculty of Kinesiology, University of Zagreb, Croatia*

<sup>2</sup>*Faculty of Philosophy, University of Zagreb, Croatia*

### Abstract

Current literature in the field of sport psychology suggests a relationship between goal orientation, pre-competition anxiety and other relevant factors such as self-confidence, gender, level of competition, type of sport etc. For that purpose we investigated these relationships expecting to find a positive relationship between ego goal orientation and pre-competition anxiety, and a negative relationship between task goal orientation and pre-competition anxiety. Our results did not confirm this hypothesis, but instead revealed that team sports especially for males may have a positive effect on self confidence in those athletes who are ego goal oriented and also experience less pre-competition anxiety. This is especially true for male athletes. Also, this study revealed us that Croatian athletes may have lower levels of somatic and cognitive anxiety than the American college athletes, but they also have lower self confidence levels, which is especially true for our female athletes.

**Key words:** *task, ego, anxiety, self-confidence, sport*

### Introduction

Contemporary professional and semi professional or even collegiate sports are excessively high in demand and they will insist on all sorts of physical and psychological adjustments from the athletes. Participating in athletic activities may carry many benefits including both emotional and physical health, adjustment and self confidence, however, if one has decided and has the objective chance in succeeding and becoming professional in ones sport by having good predispositions, it is merely not enough. One has to be both physically and mentally prepared for what is coming up in the preceding years of hard work and competition. Sometimes a hard year's work pays off only at the end of the season, in one match, game or race, and athlete has to be at his best, both physically and psychologically at that moment. That can put a lot of pressure on the athlete, because there is often a lot at stake, when one has been training all year long and now it all comes to this secluded moment in time. It is to be expected that some athletes, more than the others will in such occasions experience high levels of stress, nervousness, or as we may call it anxiety.

Anxiety associated with performance or competition has been identified as key predictor of the quality and duration of one's experiences in athletics and other achievement domains, including music, academics, and business (Gould, Greenleaf, & Krane, 2002). Available research has taught us that athletes of all ages are frequently exposed to the stress of competition (Hackfort & Spielberger, 1989) so further exploration of this field may help athletes to control and researchers to better understand the true nature of this problem. Competitive anxiety can be defined as both trait and state anxiety. If we define it as state anxiety, then it is a "state characterized by subjective, consciously perceived feelings of apprehension and tension, accompanied by or associated with activation or arousal of the autonomic nervous system" (Spielberger, 1966, p.17). If we define it as a trait anxiety then it is a "motive or acquired disposition that predisposes an individual to perceive a wide range of objectively non-dangerous circumstances as threatening and to respond to these with state anxiety reactions disproportionate in intensity to the magnitude of the objective danger" (Spielberger, 1966., p.17). By that being said we can conclude that those individuals who have excessive high trait competitive anxiety will be more prone to react with state anxiety in situations that they find threatening, but it has not yet been defined as a rule. Martens and colleagues proposed a model of competitive anxiety and they suggest three simple steps in developing anxious reaction. First step is perception of objective demand (stimulus) which can in case of athletes be competition. Second step is perceiving threat as a mediator, which can include perception of one's abilities and strengths being in discrepancy with the demands in the competition. The third step is a response or state anxiety, which is a reaction that can and will manifest itself both physiologically and psychologically (Martens, Vealy & Burton, 1990). Now, the main question that arises is: how the perception in the step two of the model is being formed and what can influence it? Surely, there will be athletes with similar level of capability who will find themselves in the same situation, but will react differently. One possible explanation is that those individuals with no anxious reaction will have lower trait anxiety. Another possible explanation is that there is another factor involved in the process and that it is not the proneness of an athlete that will account for the 100% of anxiety response. If that were the case, then all the individuals with high trait anxiety would at all threatening situations react with anxiety response with no less than 100% chance of occurrence. It is unlikely that

this would happen. It may be possible that an important cognitive factor involving their motivation and focus can work as a moderator for the response. In such case we suggest that individual goal orientation may be that moderating factor which can be related to competitive state anxiety in athletes who have higher competitive trait anxiety levels.

Achievement goal orientations refer to a generalized tendency in defining success in sport, physical education or any exercise context. We can currently identify two main types of goal orientations: ego goal orientation and task orientation. Ego oriented athletes will tend to focus more on total scores and manifestations of their games and matches as being measured by success or failure, and they will overlook their performance and developing ability which will be the main focus of those with task goal orientation. If one is more oriented towards his performance he/she will inevitably experience more disappointment as one has to both win and lose in sport, while those with task goal orientation will have a better opportunity to experience more pleasure and satisfaction due to their orientation on improving or learning ones skills. Those who are task oriented will weigh competitive situations to learn more and improve their skills and they will also learn from their mistakes which they will interpret as possibilities and cues on how to become even better at what they do (Stoeber et al., 2008.). In return they may suffer less from anxiety and gain more pleasure and satisfaction from their work. With this in mind we are suggesting that athletes who are mainly performance or ego oriented will perceive competitions as chances to satisfy their egos, to prove themselves and others that they are good and better than others and they will be more focused on winning their sport than mastering it. In return they will experience less happiness, fulfillment and satisfaction from their sport and more pressure and anxiety in competitive situations. In case of losing, those athletes will be prone to feelings of shame, doubt, guilt, dissatisfaction and may experience lack of self-confidence and more anxiety in the upcoming competitions. In fact, in order to protect their ego, once they experience failure and loss, they will try to avoid it at any cost, and at those moments when escape becomes impossible they will once again experience competition anxiety which over time may even intensify.

The aim of this study is to investigate a relationship between competition anxiety and goal orientation in athletes. We would hypothesize that athletes who incorporate ego goal orientation will experience higher levels of competitive state anxiety than those who are mostly task oriented. Also, we presume that some relevant variables, such as gender, type of sport or level of competition, can moderate those relationships. It can be presumed that ego goal orientation contributes to the level of all competitive anxiety dimensions and that task goal orientation lowers cognitive and somatic precompetitive anxiety, especially in female athletes. Finally, it can be presumed that higher levels of competitive anxiety can be found in individual sports, especially in ego oriented athletes, due to the fact that all is dependent on the single athlete and there is no diffusion of responsibility on other team members as it can be found in team sports. In line with that we expect higher self confidence levels for those athletes in team sports as well. We expect no differences in level of competitive state anxiety with regard to the level of competition, regardless of type of goal orientation.

## Methods

*Participants.* 137 sophomore students from School of Kinesiology in Zagreb participated in the study. The sample consisted of 98 males and 39 females, with the mean age of participants being 20.51 yrs. ( $sd = .90$ ). All students were athletes, 79 of them were former athletes and 58 of them are currently competing in one of 27 different sports disciplines (10 team and 17 individual sports).

*Instruments and variables.* Individual differences in goal orientation were assessed by the 13-item Croatian version of *Task and Ego in Sport Orientation Questionnaire* (CTEOSQ, Barić, Horga, 2007) which measures two different goal orientation patterns, namely *task* (i.e. 'I learn a new skill by trying hard') and *ego* (i.e. 'I feel the most successful in my sport when I'm the best'). The Cronbach alpha for task subscale was .83, and for ego subscale was .78. Item's mean value represented different athletes' goal orientation. The level of competition anxiety was assessed by *Croatian version of competitive state anxiety inventory, CSAI-2* (Martens, Vealey & Burton, 1990), applied for the first time on Croatian athletes, and measures three dimensions of competitive anxiety: *cognitive anxiety* ('I was concerned about competition';  $\alpha=.82$ ), *somatic anxiety* ('I felt nervous';  $\alpha=.82$ ), and *self-confidence* ('I felt comfortable',  $\alpha=.83$ ). Each subscale consists of 9 items and the sum of evaluations given on 4-point scale represents the anxiety level of athlete. Beside that, demographic variables as age, gender, type of sport (individual, team) and level of competition (high – achieved successful international results, middle – achieved successful results on national level, low-trained and competed on regional level) were collected.

*Procedure.* All questionnaires were administered once, in a group setting. All the participants fulfilled the questionnaires voluntarily and were awarded with 2 points of extra credit for their participation that contributes to final grade of Kinesiological psychology which is a required class on the 2<sup>nd</sup> year at School of Kinesiology in Zagreb. The measurement took approximately 15 minutes and it was conducted by a psychologist.

## Results

The MANOVA was used to test differences in competitive anxiety dimensions with the regard to relevant variables as gender, level of competition and type of sport (individual or team). The results obtained showed that there is significant differences in all competitive anxiety dimensions with regard to gender, that there are no differences in competitive anxiety dimensions with regard to competition level, and that athletes from individual and team sport partly differ in competitive anxiety (Table 1.) Descriptive parameters are presented in Table 2.

Table 1. Differences in competitive anxiety

	Gender (Nm=98, Nf=39)	Competition level (N1=26, N2=65, N3=46)	Type of sport (individual=43, team=94)
Cognitive anxiety	F=6.27 df=1 p<.01	F=.89 df=2 p>.05	F=.96 df=1 p>.05
Somatic anxiety	F=9.48 df=1 p<.01	F=1.99 df=2 p>.05	F=7.31 df=1 p<.01
Self-confidence	F=6.61 df=1 p<.01	F=.39 df=2 p>.05	F=13.57 df=1 p<.01

Legend: N1- highest level of competition, N2- middle level of competition, N3-lowest level of competition

Table 2. Descriptive parameters (M/sd)

	Gender		Competition level			Type of sport	
	male	female	high	middle	low	individual	team
Cognitive anxiety	14.1 /3.00	15.5 /3.20	14.5 /3.31	14.8 /3.20	14.0 /2.90	14.9 /3.41	14.3 /2.98
Somatic anxiety	16.0 /3.55	18.0 /3.54	17.8 /4.42	16.4 /3.46	16.0 /3.37	17.8 /3.59	16.0 /3.56
Self-confidence	18.7 /3.15	17.1 /3.76	17.9 /3.73	18.1 /3.70	18.6 /2.75	16.7 /2.96	18.9 /3.38

To investigate the relationship between goal orientation and competitive anxiety dimensions it is necessary to respect those significant differences (Table 1 and 2). We tested the relationship between goal orientation and competitive anxiety dimensions using simple correlation coefficients and regression analysis, separately for those subsamples where significant differences were obtained. Results didn't confirm the relationship between task and ego goal orientation with somatic and cognitive anxiety or self-confidence in an expected way. The exception was self-confidence dimension, despite the low percent of variance of self-confidence explained by goal orientation variables ( $R=0.29$ ,  $R^2=.08$ ,  $df=95$ ,  $F=4.31$ ,  $p<.05$ ). The results showed that ego goal orientation is positively correlated with self-confidence ( $\beta=.24$ ,  $t=2.45$ ,  $p<.05$ ). The contribution of goal orientation to competitive anxiety dimensions was tested with regard to type of sport. The results showed that 9% of self-confidence variance may be explained by goal orientation ( $R=0.31$ ,  $R^2=.09$ ,  $df=91$ ,  $F=4.68$ ,  $p<.01$ ), i.e. that ego goal orientation contributes to self-confidence level in team sport athletes ( $\beta=.26$ ,  $t=2.84$ ,  $p<.01$ ). The regression analyses of all competitive anxiety dimensions and goal orientation patterns showed no significant relationship with regard to competition level. Additional analyses of the relations obtained showed that the main factor that contributes to higher self-confidence is not gender ( $F=3.02$ ,  $df=1$ ,  $p<.05$ ) or ego goal orientation ( $F=1.28$ ,  $df=.22$ ,  $p>.05$ ), but type of sport ( $F=7.37$ ,  $df=1$ ,  $p<.01$ ). The results confirm that obtained positive correlation between ego goal orientation and self-confidence is moderated by type of sport. When this relationship is calculated within male team sport athletes, the obtained  $r=.20$  is not significant ( $p<.05$ ).

## Discussion and conclusion

Overall, by analyzing the obtained results it can be concluded that the level of somatic anxiety in our sample is higher than cognitive anxiety. In comparison to CSAI norms obtained for American college athletes (Martens at al. 1990), male and female Croatian athletes have lower level of somatic and cognitive anxiety, but also a lower level of self-confidence. The same is true for athletes from different competitive level and different type of sport. According to within subsamples comparison (Table 1), Croatian female athletes are less self-confident than male athletes and experience more symptoms of cognitive and especially of somatic competitive anxiety. With regard to type of sport it can be Croatian athletes from team sports in our sample are more self-confident and experience less symptoms of somatic anxiety before and during competition than individual sport athletes.

Furthermore, we expected that the gender, type of sport and level of competition will work as moderators for our observed variables. We can confirm that male athletes who are more ego oriented with regard to sport have also higher level of sport self-confidence. Also, we found that higher ego goal orientation in team sport athletes relates to better self-confidence and according to results it can be cautiously concluded that athletes from team sports who showed higher

level of self-confidence also have lower levels of competition anxiety in comparison to individual sport athletes and we suggest that team aspect of a sport may have the main influence. Also, according to the results obtained, it seems that goal orientation variables are not directly related to competitive anxiety, i.e. it seems that only ego goal orientation can contribute to self-confidence in a positive way. Therefore, it seems that type of sport more than ego goal orientation contributes to athletic self-confidence.

Finally, it is possible that the obtained results would differ if our sample consisted of all the current athletes and if our sample size was bigger. If that were the case our results may be even more consistent with the current literature, but this way we may question some current knowledge and retest what we may have been confident in. Another issue that may have had an influence on the results is the question whether these athletes truly competed recently, or not, because if they did not, their rapport on the questionnaire may be different than if they did. Also, it would be interesting to investigate what would be obtained if our sample consisted of higher diversity of athletes, including different ages, background etc. The contribution of this research is the application of the CSA inventory that have not been used on Croatian population before. It questions some of the current knowledge in the field of sport psychology and it has given us some new information on the relationship between confidence, gender, anxiety and sports type. We plan on further investigation on what has been found here, which is needed before making any strong conclusions and before implementing this gained knowledge in practice.

## References

1. Barić, R., & Horga, S. (2007). Psychometric Properties of the Croatian Version of Task and Ego Orientation in Sport Questionnaire (TEOSQ). *Kinesiology*, 38(2), 135-142.
2. Martens, R., Vealey, S.R., & Burton, D. (1990). *Competitive anxiety in sport*. Champaign, IL: Human Kinetics.
3. Gould, D., Greenleaf, C., & krane, V. (2002). The relationship between arousal and athletic performance: Current status and future directions. In T.S. Horn's (Ed). *Advances in Sport Psychology*. Champaign, Illinois: Human kinetics.
4. Spielberger, C.D. (1966). Theory and research on anxiety. In C.D. Spielberger (Ed.), *Anxiety and behavior* (pp. 3-22). New York: Academic Press.
5. Spielberger, C.D. (1989). Stress and anxiety in sports. In D. Hackfort & C.D. Spielberger (Eds.), *Anxiety in sports: An international perspective* (pp. 3-17). New York: Hemisphere.
6. Stoeber, J., Stoll, O., Pescheck, E., Otto, K. Perfectionism and achievement goals in athletes: Relations with approach and avoidance orientations in mastery and performance goals. *Psychology of Sport and Exercise*, 2008. 9: 102–121.

## PROUD TO BE CROAT – NATIONAL IDENTITY AND SPORTS IN THE ADVERTISING WORLD

Sunčica Bartoluci<sup>1</sup> and Diana Tomić<sup>2</sup>

<sup>1</sup>*Faculty of Kinesiology, University of Zagreb, Croatia*

<sup>2</sup>*Faculty of Humanities and Social Sciences, University of Zagreb, Croatia*

### Abstract

This paper analysed Croatian TV commercials in order to determine the way in which advertising utilizes national identity. The corpus consisted of 50 television ads placed either in a sports setting, employing sports imagery or including a celebrity athlete (Hilliard and Hendley, 2005). The analysis also included verbal and non-verbal expressions of national identity. The results show that dominant sports are soccer and handball in which national team is successful; dominant product is beer; sport setting is not unavoidable and it is often supplemented by sport supporters' gatherings in various situations. The celebrities are most often national selectors or players. National identity is expressed verbally through slogans or songs which often exceed the limits of particular commercial and become national supporting songs. It is interesting to notice that except for the usual symbols of national identity (white and red checkered patterns, etc.) commercials often include Croatian natural beauty or cultural heritage.

**Key words:** *national identity, sport, advertising, television commercials, Croatia*

### Introduction

Every person possesses several different identities, like gender, family, class, professional or religious identity, but national identity as “a need for collective immortality” today has a far more powerful and lasting influence than the other aspects (Smith, 1998:270).

Based on shared values, customs, symbols, or cultural heritage national identity gives a sense of belonging to a group with common cultural, historical and territorial specificity. That way, events related to sports are an efficient means of creating national identity and unity, but also a means of promoting reputation and power of certain groups, communities and nations as a whole.

In the last fifty years sociological research has shown sports to be irreplaceable as one of the basic societal institutions (Coakley, 2009). All-around presence and popularity of sports contribute to events like the Olympics, world soccer or handball championship becoming an effective way of national identification, but also a powerful tool for the political and economic elite in fulfilling their own goals on both domestic and international levels. That way, sport events get a wider social meaning and athletes become ambassadors of their countries, presenting their country, nation and national culture. Their voice is often heard much more than the regular means of promotion manage to be heard, so sport becomes an important communication channel. Croatia is no exception.

It is well known that sport success and presence of national symbols, like the national flag, anthem, jersey, etc. can provoke awakening of national feelings and creating awareness on belonging to a certain community even in a completely apolitical but also sport-wise disinterested population. Eric Hobsbawm says: “What has made sport so uniquely effective a medium for inculcating national feelings, at all events for males, is the ease with which even the least political or public individuals can identify with the nation as symbolized by young persons excelling at what practically every man wants, or at one time in life has wanted, to be good at. The imagined community of millions seems more real as a tem of eleven named people. The individual, even the one who only cheers, becomes a symbol of his nation himself.” (Hobsbawm, 1990:143). Success of the national team becomes the success of every member of the nation personally, which in turn the corporations in Croatia (even though they are often foreign-owned, like InBev for Ožujsko beer, Heineken group for Karlovačko beer) greatly use by signing endorsements with the national teams. That way national identity becomes a “commodity” which sells the product well.

The relationship between sports and media, especially advertising has also been the topic of recent sociological research (Messner & Montez de Oca (2005); Zwarun & Farrar (2005)) whose results emphasize the importance of sport marketing and various advertising strategies implemented by global corporations all over the world using national symbols on a regular basis. Silk and Andrews (2001:183) say that “sport (either in terms of sporting practices, spectacles, or celebrities) is frequently used within advertising campaigns as a de facto cultural shorthand delineating particular national contexts”. Although there are some papers about advertisements and marketing strategies (Gjuran-Coha and

Pavlović, 2009) in Croatian context, the relationship between sport and national identity as the content of advertisements has so far not been researched.

## Method

In order to get a better insight into the relationship of sports and national identity within advertising, television advertisements which were aired between 2006 and 2011 by Croatian networks (HRT, RTL, NovaTV) have been collected. The advertisements are available on the Internet. They were chosen in accordance with the criterion of them entailing a sports characteristic, regardless of whether it was sports surroundings, famous athletes or a sporting event. Seeing that this was a preliminary research which does not include marketing coverage of a certain sporting event like the World Soccer Championship or in-season period of a specific sport as it was done by Hillard and Hendley (2005), and the frequency of airing for each advertisement, we believe that this corpus and the criterion for collected ads gives more detailed information for understanding the relationship of sports and national identity in advertisements. The collected corpus included 50 advertisements meeting the determined criteria.

Criteria for the assessment of TV ads (Hillard and Hendley, 2005) were slightly adapted and entailed the following: product, sport setting, sport imagery and celebrity athlete, in addition to the sport referred to in the advertisement, celebrities in general and elements of national identity (expressed either verbally or non-verbally). The authors assessed the advertisements independently, and by comparing the results, the degree of mutual agreement was 95%.

Descriptive statistics was used to create to ads profile providing insight into the representation of certain sports, products and the presence of national identity within the corpus. It also enables a better understanding of examples which are singled out because of strong emphasis on national pride.

## Results and discussion

As expected, considering the influence sport has in society, all advertisements use some sport symbols. A total of 54% was related to soccer, which is not surprising, not only because of its global popularity, but also because of the success of Croatian national soccer team, which is present in almost every world or European competition. Thus a thesis that Croatia is a successful sporting (soccer, handball, skiing, ...) nation is often mentioned in the public. Media role of sports, in the sense of promoting the nation into a wider social context has shown itself indispensable. This particular matter became especially important during the period when Croatia was being constituted as an independent state. "Through its success in soccer, and in other sports, Croatia has been able to enhance its image as a nation prepared to play a more significant role in the European Community and in the world." (Sack and Suster, 2000:318)

Even the examples which do not contain a sport setting are somehow related to soccer, like in the telecommunications' advertisement with a setting at the cash register of a store, which paraphrases the name of national soccer team member Ivica Olić in a slogan "Olićan Internet" (Olić is the surname of Croatian soccer player) or in another example where business telecommunication services are advertised, while the product is advertised in a soccer field.

Soccer is followed by handball with a 20%. Since the first Olympic medal was won in 1996 and the success that followed it, handball has been very popular in Croatia. Other sports include, interestingly enough, hockey (which has been popularized in the last two years thanks to a well-planned campaign of Medveščak hockey team) and water polo (8%), which still has to be "targeted" by the sponsors, especially since the team won a gold medal in the European championship in 2010, as well as athletics (2%) and basketball (2%).

The results of product representation in advertisements correspond to the results in similar research (Hillard and Hendley, 2005; Messner and Montez de Oca, 2005); the most common product in the corpus is beer with 46%. In Croatia, beer is followed by a national supermarket chain with 24% and telecommunication services with 20%. Non-alcoholic beverages are rare (4%), as are food products, digital television and ENC (2% respectively). Dominating products also give information about the popularity of sports and national identity as topics of advertisements.

The occurrence of sport settings in Croatian advertising is similar to the finds in the US ads, 32% of advertisements have a sporting field (soccer, handball, hockey) as a setting. Placing the remaining advertisements – 35% take place in a café, living room, restaurant, or a place to socialize, which is not an element for such advertisement in other countries – shows the influence of sport in the social life of Croatian citizens. For Croatian people, sport is not primarily recreation or activity as much as it is getting together with a purpose of celebrating the victory of the national team. The need for gathering while watching competitions in which the national team participates, bonding based on that strong emotional experience (regardless of whether the outcome of the game would be positive or negative) and pride on account of sport success of one's nation are very much emphasized in Croatian society which is the reason why those elements found their place in advertisements.

Sport imagery like fan props, jerseys, flags etc. is not dominant in Croatian advertisements and is present in 30% of them. What predominates is a presence of a celebrity (in 74% of advertisements), which is more than the results in the USA showed when similar methodology was applied (Hillard and Hendley, 2005). Among the advertisements with celebrities, a

total of 78% are athletes, sports stars whose media attractiveness is being used in order to suggest to potential consumers to become the consumers of those advertised products. In that way, the consumers' consciousness and their identification with an athlete and his/her "habits" (e.g. the coach of the Croatian national soccer team Slaven Bilić or handball national team coach of many years Lino Červar in Konzum) in a way that suggests the most successful, national sport champions are customers of the national shopping chain – "the best at the best".

In 80% of advertisements, national identity is used for marketing purposes. From that, 73% is achieved through transmitting a verbal message (through slogans, songs or the text of the advertisement itself). The analysis brought forth several slogans: *It's the best to be Croatian when Croatia is in the field* which entails belonging to the nation, pride and sport, *Always faithful* which adds faithfulness and loyalty to the mentioned aspects, both of which are high on the scale of importance in the Croatian society. The other slogans and scenarios emphasize superlatives, *the best, of the best quality, the most important, the most reliable* related either to the product and the company or the celebrity athlete and the team, and pride (*Proud sponsor...*, *Produced with pride*). Sport values (hard work, togetherness and team spirit) are not excluded from the advertisements, but appear in special versions, e.g. in Konzum's holiday ads in which the main actors are soccer or handball selector and one team member, and can be considered more of an exception than a rule.

Finally, two songs were emphasized among verbal messages. The text to Konzum's advertisements became a national fans' anthem which has been sung in all major sporting events ever since it has been aired. Its message contains previously mentioned values: national pride, loyalty, love, willingness to sacrifice, gratitude and celebration of success. In transmitting that message, typical national topoi like love, homeland, national pride, regions of Croatia are expressed, while the verbal forming is dominated by emotion-filled, "strong" images like: value in life, tear from the eye, life given by the land (nation), one's people, kissing the national coat of arms and eternal glory. The second example is the text to the advertising called Fans' prayer which is recited along with a background drumming sound symbolizing heartbeat and with an increasing tempo as the advertisement peaks. Visually, in addition to the text, there are symbolic shots from the field in which the viewer can see candles, rings of fire and soccer national team members lined as soldiers, which creates an impression of a fight to the very last drop of blood. These shots interchange with shots of Croatian natural beauty, which additionally contributes to the feeling of national pride. The advertisement starts by invoking god and asking for a blessing. This is strong enough in itself, having in mind the significance of religion in Croatia. This act determines the advertisement as a prayer. It emphasizes holy colors – national colors, it mentions pride (*let them walk with their chin up high*), loyalty and faithfulness (*...no fear, no surrendering...*, *...we go, to the very last of us...*). It then paraphrases the Croatian national anthem using the familiar anaphora (*Whilst our...*) with the verses containing images from sports fighting: tears shed, jersey.

It is interesting that 70% of advertisements use non-verbal elements, mostly red and white checkered pattern, flag or its colors and fan jerseys. We could say that sport imagery, which has been somewhat less represented in advertisements is actually supplemented national imagery because if a jersey appears, it is rarely a jersey of a sport club, it is mostly the jersey of the national team. Same goes for all other fan props. Due to limitations of the sample, that relationship cannot be questioned in detail in this paper, but it can be said with certainty that it exists in Croatian advertisement messages.

Furthermore, national identity and pride can be seen through the usage of national iconography (in several advertisements, Croatian natural beauty and shots of large cities can be noticed) because this also suggests "national unity", togetherness which directly influences the consumers. 38% of advertisements use both verbal and non-verbal communication code. Those are stronger, richer, more layered and cause an intense emotional reaction with the viewers. For example, combination of a paraphrased prayer and Croatian national anthem followed by beautiful shots of nature and a background drumming symbolizing a heartbeat can leave very few people indifferent, by influencing both the aware and unaware aspects of people.

## Conclusions

Due to all-encompassing acceptance, in a very subtle way and in a relatively short time span, sports and sport success have managed to go places where, despite all efforts, political and economic elite haven't for years. This is why companies use sports in advertising their products and with the help of strong verbal and non-verbal messages, put in national context, are trying to record as high profits as they can. This is clearly seen in the content analysis of advertisements which have been airing in the last several years in the Croatian media, i.e. television, which in turn shows that this phenomenon should be approached interdisciplinary and see its wider social influence. Although this was a small corpus, preliminary research was done in order to observe all forms and contexts in which national symbols appear in the advertisements, which would serve as guidelines for further larger scale research over a longer period of time.

Analyzed advertisements put sporting events into the center of their interest, and use the question of national identity on a regular basis by putting together what, at first glance, cannot be put together – nation and beer, nation and shopping chain, etc.

Every social system manipulates sports as such in a certain way, with the purpose of achieving its own goals. Contemporary sport becomes a ruthless race for money, power and fame. Celebrity athletes are encouraged to participate in new, highly-paid competitions in which they do not wear the national colors, but the colors of their sponsors, so the



concept of nation is starting to fall to the second place, behind the concept of trademark (Bourg, in: Bodin et al., 2007:133). Corporations use sport success of individuals and teams to suggest to the wider public that they are the “proud sponsor of the Croatian national soccer team” or those who follow “the best”. That way their product becomes synonymous to success.

## References

1. Bodin, D., Robène, L. & Héas, S. (2007). *Sport i nasilje u Europi* [Sport and violence in Europe]. Zagreb: Knjiga trgovina.
2. Coakley, J. (2009). *Sports in Society: Issues and Controversies*. 10<sup>th</sup> edition. McGraw Hill.
3. Gjuran-Coha, A. & Pavlović, Lj., (2009). Elementi reklamne retorike u hrvatskim reklamnim porukama. *Fluminensia*, 21, (1), 41-54.
4. Hillard, D. & Hendley, A. (2005). Celebrity Athletes and Sports Imagery in Advertising During NFL Telecasts. The Brown Working Papers in the Arts and Sciences. Vol. 5. (<http://www.southwestern.edu/academics/bwp/> last accessed Feb 21, 2011)
5. Hobsbawm, E. J. (1990). *Nations and Nationalism since 1870: Programme, Myth, Reality*. Cambridge: Cambridge University Press.
6. Messner, M. & Montez de Oca, J. (2005). The Male Consumer as Loser: Beer and Liquor Ads in Mega Sports Media Events. *Signs*, 30 (3), 1879-1909.
7. Smith, A. D. (1996). *Nacionalni identitet* [National Identity]. Beograd: Biblioteka XX vek.
8. Sugden, J. & Tomlinson, A. in Sack, Allen, L. & Zeljan Suster (2000). Soccer and Croatian Nationalism: A Prelude to War. *Journal of Sport and Social Issues*, 24, 3, 305-320.
9. Silk, M. & Andrews, D. (2001). BEYOND A BOUNDARY? Sport, Transnational Advertising, and the Reimagining of National Culture. *Journal of Sport & Social Issues*, 25(2), 180-201.
10. Zwarun, L. & Farrar, K., (2005). Doing What They Say, Saying What They Mean: Self-Regulatory Compliance and Depictions of Drinking in Alcohol Commercials in Televised Sports. *Mass Communication & Society*, 8(4), 347-371.

## ATTEMPTS TO ORGANISE AND ADVANCE EDUCATION IN CROATIA IN 1861 AND 1865 AND POSITION OF PHYSICAL EDUCATION

Zrinko Čustonja and Dario Škegro

*Faculty of Kinesiology, University of Zagreb, Croatia*

### Abstract

The aim of this study is to analyse attempts and discussions regarding further organisations and advance of schooling system in Croatia emphasized on physical education in 1861 and 1865. New elections for the newly convoked Croatian Parliament (Sabor) were organised in April 1861, after 13 years of the Bach's Absolutism. Among many questions, on the agenda were again school reforms and new curricula for grammar, modern and elementary schools. First proposals on school reforms were submitted to the Croatian Parliament in May and they were discussed during the session in September 1861 and then again in 1865. Discussions and activities regarding position of physical education are interesting from a historical point of view since they are first discussions in Croatian Parliament about physical education. The main primary source used is a work by Antun Cuvaj "Sources of the history of education in the kingdoms of Croatia and Slavonija from the ancient times till nowadays". Archive and library documents from the Croatian State Archives and the National and University Library of Zagreb were also used.

**Key words:** *history, physical education, Croatian Parliament*

### Introduction

First serious attempt to organise an advance education in Croatia occurred in the Civil Croatia in 1848. The proposal of the law on education, "Basics of Principal Rules for Public Instruction in Croatia and Slavonia" ("Osnove temeljnih pravila javnog obučavanja za Hrvatsku i Slavoniju") was prepared in very short time (Cuvaj, 1910). This act specified compulsory PE classes in elementary and secondary schools, but due to political developments in 1848, the war against Magyars and the Octroyed Constitution enactment in the Habsburg Monarchy in March 1849, the detail were neither elaborated nor was the act ever implemented. Nevertheless, the "Basics" from 1848 are the first so far known written source on compulsory PE teaching in the schools of the Civil Croatia. The "Basics" were the first autonomous legislative attempt to organise schooling in Croatia. (Bobić, Čustonja, 2005)

New elections for the newly convoked Croatian Parliament (Sabor) were organised in April 1861, after 13 years of the Bach's Absolutism. Among many questions, on the agenda were again school reforms and new curricula for grammar, modern and elementary schools. First proposals on school reforms were submitted to the Croatian Parliament in May and they were discussed during the session in September 1861 and then again in 1865. Those discussions are interesting from a historical point of view since they are first discussions in Croatian Parliament about physical education.

The aim of this study is to analyse attempts and discussions regarding further organisations and advance of schooling system in Croatia emphasized on physical education in 1861 and 1865.

The main primary source used is a work by Antun Cuvaj "Građa za povijest školstva kraljevina Hrvatske i Slavonije od najstarijih vremena do danas" ["Sources of the history of education in the kingdoms of Croatia and Slavonija from the ancient times till nowadays"], 2<sup>nd</sup> edition, volumes I-XI, 1910-1913, the most comprehensive and most frequently used source in national history studies on education. Archive and library documents from the Croatian State Archives and the National and University Library of Zagreb were also used.

### Croatian Parliament about physical education in 1861

Three separate discussions on three new laws, regarding elementary, grammar and modern schools, were registered in the period of September 12-27, 1861. (Cuvaj, 1910) A discussion regarding PE instruction was initiated during the discussion on the modern schools – "Basics for modern and commercial-apprenticeship schools in the Kingdom of Dalmatia, Croatia and Slavonia" ("Osnove za realke i trgovačko-obrtničke učione u kraljevini Dalmaciji, Hrvatskoj i Slavoniji"). Member of parliament Dragutin Jelačić suggested, "to include gymnastics into the obligatory subjects" because "every human being needs sound body and soul". (Cuvaj, 1910) The proposal was corroborated by MP's Matija Mesić: "For the young, who have to work extensively and strenuously in school, it would be beneficial to have gymnastic session several times a week" (Cuvaj, 1910) and Franjo Žužel:

“I stick to the principal that it is beneficial to the state: mens sana in corpore sano; that progress needs sturdy body and that, allegedly, healthier body means more vivid spirit of a human ... It is true ... that our youngsters are getting weaker every day ... they are weak because they spend too much time sitting in schools ... natural consequence is weakening of the body. I would like to include classes of gymnastics instead of some other subjects. The young man having an hour of exercise, will progress with his books as if he has worked two hours.”

Avelin Čepulić underlined benefits of exercise for military purposes, whereas Mirko Šuhaj, PhD, on whose proposal optional PE instruction had been already introduced into grammar schools, said that the “children who are engaged in gymnastics are more practical and have no fears”. (Cuvaj, 1910) The only opponent to the proposal of Dragutin Jelačić was the Stjepan Ilijašević:

“It is quite enough to have gymnastics as the non-compulsory subject ... gymnastics may be dangerous ... let our young people wonder across Croatian fields and meadows, as they are used to ... To avoid the name of primitives, let those who need or want gymnastics, for example, those who wish to join the army, to have it, but leave it optional ...” (Cuvaj, 1910)

By a majority vote, PE instruction was adopted as a compulsory subject in the modern schools (Realschule) and vocational (apprenticeship and technical orientation) schools. Instruction of the compulsory subject was planned two hours a week, and it should have been conducted according to the “Spiess’s system”. (Cuvaj, 1910)

Further, by the provisions of the laws on elementary and teacher training schools, as well as on grammar schools PE instruction became non-compulsory subject taught in the schools which had appropriate facilities. German influence is more than obvious (Spiess’s system) in the curriculum. It seems that the representatives in the Croatian Sabor in 1861 had forgotten the fact that the conditions for implementation of PE instructions were very poor in Croatia - there was a shortage of professionally trained PE teachers and material conditions (adequately arranged facilities) were terrible.

The Emperor of the Habsburg Empire must ratify any law passed in the Croatian Sabor. When the Emperor Francis Joseph I. got all the decrees and laws passed during the assembly of the Croatian Sabor from April to November 1861, he decided to dissolve the Sabor due to political reasons on November 8, 1861 and not to ratify any of the legal documents. Among the most important issues on the agenda of the then Croatian Sabor was the definition of the state-constitutional relationship of Croatia to Austria and Hungary, the request for unification of all Croat lands, and versatile internal affairs concerning intrastate organisation (Pavličević: *Povijest*, p. 221). No consensus was reached concerning the open questions of relationship with Hungary, so the Emperor dissolved the Croatian Sabor with no decision ratified. Reorganisation of schools and introduction of PE instruction was stopped in that way. Instruction was conducted according to the “Systema scholarum elementarium” from 1845 and some other decrees from the time of Absolutism. Instruction in PE was not planned. Its implementation was a free will of a teacher or a headmaster, frequently determined by conditions of a particular school in the territory of the then Civil Croatia.

### **New attempts to reorganize schooling system in 1865**

After the Sabor had been dissolved in 1861, another intermission in the public life occurred. It lasted until November 1865 when the Sabor was convoked again with the primary goal to finally put in order the state and constitutional relationships of Croatia with Austria and Hungary. Nevertheless, in the meantime activities regarding organisation of education in Croatia were never interrupted. Re-Croatianisation of elementary and secondary schools was the prime task after the termination of the Bach’s Absolutism and the period of strong Germanisation. The biggest problem was a small number of Croat teachers and those who were able to taught in the Croatian language, and a shortage of quality enough books and handbooks written in Croatian. Franjo Rački, PhD, the Croatian Principal School Inspector (1863 - 1867), distinguished himself in resolving many educational problems. F. Rački was a priest, Zagreb’s dean, historian and politician, one of the founders and the first President (1867 - 1886) of the today’s Croatian Academy of Sciences and Arts. The then Croatian educational system was an absolutistic-centralistic system strongly pro-Germany oriented in which “deserts were found regarding rearing and education of the young Croats” (Cuvaj, 1910). Due to insecure political position of Croatia in the then unstable Empire, there was an atmosphere of general social inertness, stagnation and fear, which resulted in avoidance of any serious engagement or activity in any aspect of public life whatsoever. It seems that F. Rački managed not to drown in the “social marshes”. In the period 1864-1866 he initiated foundation of 24 new lower elementary schools; several school textbooks were published in the Croatian language; he paid particular attention to teacher training schools (preparandija) because in them “a new generation of worthy Croatian teachers were educated” he founded the Society for Supporting Poor Teachers and many other progressive things (see Cuvaj, 1910). In October 1865 he founded the Teachers’ Association in Zagreb, the first Croatian society of that kind. The Association soon elaborated the “Constitution of elementary school in the Triune Kingdom” (“Ustav pučke škole u Trojnoj Kraljevini”). A new proposal on organisation of schooling system in Croatia, although based on the “Systema scholarum elementarium” from 1845 and the elementary school law proposed in 1861, presented some novelties. Among other things, PE instruction was included in the list of the elementary school subjects.

“The purpose of gymnastics in elementary school is strengthening of the body, development of movement agility, training of senses, proper body posture, exact assessment of resistance and strength needed, and skilful group routines. Not a definite number of hours has been allocated to gymnastics, but youngsters should exercise according to the circumstances – one or two hours every week outside the regular schedule. In rural communities gymnastic exercises consist of natural movements: running, jumping, jumping over, racing in running, throwing, shooting, climbing up and down, lifting, wrestling, and so on. Therefore, each school should have spacious playgrounds with trees on it, where children can play alone or under control of teachers. Only in the municipal higher elementary schools, if circumstances allow it, systematic gymnastics will be implemented. Wherever there are opportunities, the young should be instructed in swimming.” (Cuvaj, 1910)

A few crucial elements should be accentuated in this short description of PE instruction as imagined by a group of Croatian educators in 1865: 1) this is the longest and most detailed description of the planned PE instruction written up to 1865; 2) a distinct detachment from the German influence and the system of A. Spiess is obvious; and only four years ago (1861) the German system had been regarded as a basis of both the compulsory and optional PE classes; 3) for the first time it is stipulated that each school, according to its potential, should have its own exercise facility or playground; 4) a shortage of PE professionals was solved in a way that children were supposed to execute basic motor movements alone (running, jumping, throwing, aiming, climbing up and down, lifting, wrestling ...), or under supervision of their general teacher (he/she does not conduct exercise session); 5) differences in working conditions between rural and urban communities were supposed; gymnastic sessions should be regular in the latter and conducted by PE professionals (a PE teacher was working in Zagreb schools from 1859); 6) for the first time swimming was mentioned as a necessity for children, which was a revolutionary novelty. The proposed legal fundamentals is a giant step-out towards better understanding the position and role of PE in the process of education in the then Croatia. V. Janković, PhD, in his book “Iz prošlosti fizičkog odgoja u školama Hrvatske” [“From the history of physical education in Croatian schools”] says “the progressive interpretation of the role physical exercise plays in education of youngsters emerged under the influence of pedagogical concepts of Rousseau and Pestalozzi.” (Janković, 1954) After the preamble, in the first article of the “Constitution”, the rationale and the role of elementary school is defined:

“The rationale of the elementary school is to foster harmonious development of the intellectual and physical abilities of the young in order to teach them so much, individually tailored, knowledge and skills that are necessary for honest living and to make each of them a valuable and useful member of the humanity.” (Cuvaj 1910)

M. Ogrizović in “Prilozi nacionalnoj povijesti pedagogije” [“Contributions to national history of pedagogy”] also recognises obvious influence of J. J. Rousseau and J. Pestalozzi, J. A. Komensky and A. Diesterweg, as well as other humanists and pedagogues on the authors of the “Constitution”. (Ogrizović, 1989)

The “Constitution” was submitted for consideration in the Croatian Sabor and the Sabor’s Committee for Education discussed about it, but it was never included in the agenda of any of the public assemblies neither it became a law. So, instruction in schools continued in the same way despite the positive reaction of the professional public to the “Constitution”.

## References

1. Janković, V. (1954). *Iz prošlosti fizičkog odgoja u školama Hrvatske*. Zagreb: Društvo učitelja, nastavnika i profesora fizičkog odgoja NR Hrvatske.
2. Pavličević, D. (2002). *Povijest Hrvatske*. Zagreb: Naklada Pavičić.
3. Macun, J. (1859). Skerb o telesnom blagostanju školske mladeži. *Napredak* 1(1), str. 4.
4. Ogrizović, M. (1989). *Prilozi nacionalnoj povijesti pedagogije*. Zagreb: Školske novine.
5. Löffler, A. (1874). Tjelovježba u pučkoj školi. II. Obća hrvatska učiteljska skupština u Petrinji, 25.-27. kolovoza, str. 223-237. Zagreb: Centralni odbor obćih hrvatskih učiteljskih skupština.
6. Pavličević, D. (2000). *Croatian History*. (In Croatian.) Zagreb: Naklada P.I.P. Pavičić.
7. *Croatian Official Gazette* (1874). Exercise school (In Croatian). No.170, July 28<sup>th</sup>, p. 3.
8. Croatian State Archives, sources of Hungarian Regency Council (Ugarsko namjesničko vijeće), dep. Scholastici 27071844, box 6.
9. Croatian State Archives, sources of the Zagreb County, protocol No. 36, para. 22 from September 13, 1797.
10. Cuvaj, A. (1910). *Sources of the history of education in the kingdoms of Croatia and Slavonija from the ancient times till nowadays* (In Croatian). Vol. I-XI. Zagreb: Kraljevska hrvatska-slavonska-dalmatinska zemaljska vlada, Odjel za bogoštovlje i nastavu.
11. Petris-Martinčić, R. (1992). Acts on Croatian schooling system in 19<sup>th</sup> century (In Croatian). *Anali za povijest odgoja*, 1, 121-124.

## ACHIEVEMENT GOAL ORIENTATION IN UNIVERSAL SPORTS SCHOOL PARTICIPANTS

**Zoran Grgantov, Jelena Matešić and Mia Perić**

*Faculty of Kinesiology, University of Split, Croatia*

### Abstract

In the present study 111 children (mean age 9.2 years), participants of universal sports school were investigated. The aim of the study was to determine their structure orientation towards physical exercising. Descriptive analysis showed higher task orientation (TO) (Mean=4.56) and lower ego orientation (EO) (Mean=2.86). Cluster analysis revealed four groups of participants by the level of their EO and TO. Analysis of variance showed significant differences between groups in EO and TO. Post hoc analysis (Fisher LSD test) revealed significant differences between all groups in EO. First group had the lowest and fourth group had the highest values of EO, while the second and the third group were characterized by average values. In TO, children from first, third and fourth group had very high similar values (above 4.5). The only exception were children from the second group, who had significantly lower values of TO than children in other groups.

**Key words:** *task orientation, ego orientation, children, cluster analysis, analysis of variance*

### Introduction

Fundamental movement skills are developed by frequent physical activity and exercising, especially in children. In universal sports schools, organized physical exercising should result in commitment and desire for progressing in training sessions, same as originate children to spend their leisure time in physical activity. In long term, good program of physical exercising should promote healthy and active way of life. By exercising in universal sports schools, children are allowed to test their abilities and achieve certain goals. Achievement goal theory helps in understanding motivating processes in achievement situations. According to that theory (Duda, 1989), there are two different ways in which an individual can estimate a level of his/her abilities and efficacy. First conception is represented by individuals who are orientated on learning or improving certain activity (task orientated - TO). Those persons set their goals in order to their past performance, they motivate themselves by advancing and improving certain task and they feel successful after learning something new and doing efforts. In the other conception, success and ability are defined by social comparison. Individuals are orientated towards demonstration of their superiority in certain task, whether to themselves or the others (ego orientated - EO). Those individuals define their success as a situation in which they are superior to others and they don't think of sport activity as their own experience, since their goal is not activity on its own. They are more interested and motivated in sport activity as something that could contribute to greater goal, such as victory, acknowledgment etc. According to Thomas (2008) levels of TO and EO tend to change during the sport carrier, but also depending on the training or competition period.

Influence of TO and EO affects cognitive processes, emotions and behaviour (Grgantov, Gabrić and Miletić, 2008). Motivating environment, which could be influenced by parents, friends, colleges etc., has a great role in structure of orientation in every child, due to training process. Some kind of consensus about positive influence of TO on cognition, emotions and behaviour exists in literature, (Duda, 1989; Moreno i sur., 2008; Thomas, 2005) while the EO has a different influence on those character traits. Same authors consider that EO in combination with bad image of own abilities, results in negative emotions and behaviour. Researches also indicate a mutual independence of TO and EO. Considering the later, there are four combinations of interrelationship in practice:

1. High level of TO: low level of EO
2. High level of TO: high level of EO
3. Low level of TO: low level of EO
4. Low level of TO: high level of EO

In previous studies among athletes (Thomas 2005.), it was found that TO and EO are prone to changes during the athlete's career same as during the competitive season. It is the reason why it is important to create a motivating environment focused on learning and developing skills in working with children. Considering the mentioned facts, the aim of this study was to determine the levels of TO and EO in children, participants in universal sports school. Special aim is to group the participants considering their orientation structure to physical exercising, same as to determine significant differences in TO and EO between those groups.

## Methods

The sample was comprised of 111 children (71 girls and 40 boys), all participants in universal sports school, aged between 7 and 11 years (mean age = 9.2 years). With the help of professionals, all participants answered the TO and EO questionnaire (Duda 1989). The questionnaire was consisted of 13 questions. Each question had to be answered by grade 1 (totally disagree) to 5 (totally agree). Six question estimated EO, and seven questions estimated TO. Mean values for those groups of questions were the final scores for EO and TO (Table 1).

Table 1. Task and ego orientation questionnaire in sport (Duda, 1989)

When do you feel most successful in sport? In other words, when do you feel a sport activity has gone really good for you? I feel most successful in sport when...						
A	I'm the only one who can do the skill	1	2	3	4	5
B	I learn a new skill and it makes me want to practice more	1	2	3	4	5
C	I can do better than my friends	1	2	3	4	5
D	Others can't do as well as me	1	2	3	4	5
E	I learn something that is fun to do	1	2	3	4	5
F	Others mess up and I don't	1	2	3	4	5
G	I learn a new skill by trying hard	1	2	3	4	5
H	I work really hard	1	2	3	4	5
I	I score the most points	1	2	3	4	5
J	Something I learn makes me want to go and practice	1	2	3	4	5
K	I am the best	1	2	3	4	5
L	A skill I learn really feels right	1	2	3	4	5
M	I do my very best	1	2	3	4	5

Basic descriptive statistics (mean values, standard deviations and minimum and maximum results) were calculated for all variables. Parametrical methods were used considering a large number of participants ( $N > 100$ ) and interval scale of the questionnaire's final results. Cluster analysis ("K-means clustering") was used to establish groups by EO and TO variables. Analysis of variance (post hoc Fisher LSD test) was used to establish the differences between the groups. Data were analyzed using the Statistica for Windows 7.0 package and the statistical significance was set at  $P \leq 0.05$ .

## Results

Table 2. Basic descriptive statistics for EO and TO variables (M – mean value, SD – standard deviation, MIN – minimum result, MAX – maximum result)

	M	SD	MIN	MAX
TO	4.56	0.40	2.71	5.00
EO	2.82	0.77	1.00	4.50

From the data in Table 2 very high values of TO in all participants (above 4.5) can be observed, same as below average values of EO. The results of cluster analysis and analysis of variance (Table 3 and Table 4) show more detailed view in the structure of participants' orientation to physical exercising.

Table 3. Cluster analysis results (mean values for the groups); ANOVA (F value)

	GROUP 1 (N=39)	GROUP 2 (N=14)	GROUP 3 (N=41)	GROUP 4 (N=17)	F
TO	4.61	3.91	4.72	4.61	25.62*
EO	2.00	2.76	3.13	3.97	141.33*

\* significant differences

Table 4. Post-hoc Fisher LSD between the groups for TO and EO (p values)

CLUSTER	TO				CLUSTER	EO			
	1	2	3	4		1	2	3	4
1		0,00	0,10	0,94	1		0,00	0,00	0,00
2	0,00		0,00	0,00	2	0,00		0,00	0,00
3	0,10	0,00		0,18	3	0,00	0,00		0,00
4	0,94	0,00	0,18		4	0,00	0,00	0,00	

Considering the linear independence of EO and TO, “K-means clustering” (four groups) was used in this study. The first, third and fourth group of children were characterized with very high values of TO (above 4.5), but significantly differ in EO values. First group has low, third group has moderately, and fourth group has moderately high level of EO. Second group has significantly lower level of TO comparing to other groups (3.9), but this group’s TO dominate in relation to their EO (2.76).

## Discussion and conclusions

TO is the dominate factor in relation to EO among all participants of the universal sports school. These results are consistent with previous research (Grgantov, Gabrić and Miletić, 2008). When comparing these results with the results of older population, we observe higher values of TO and lower values of EO in children. Although those differences are not big they could be an indicator of negative changes in the structure of orientation in children during their sport careers. More detailed view of structure of orientation towards physical exercising in children could be revealed using the cluster analysis and the analysis of variance. Most of the tested children (N=80), forming the first and the third group, have acceptable structure of orientation with very high level of TO and low (first group) or moderate (third group) level of EO. That kind of relation between TO and EO is positively correlated with respecting opponents, compliance with rules or injuring an opponent. Besides that, TO persons enjoy what they do, they are harder to give up after failure and they choose less difficult goals. Also, they are less likely to give up sports (Cervello, Escarti and Guzman, 2007), and they are the ones involved in the high level performance more frequently. It can be assumed that the structure of orientation in some children from the third group could be influenced by some external factors and changed into structure that is characteristic for group four (high level of TO and EO). That kind of structure, characteristic for 17 children in this study, could result in negative emotions and behaviour in some future sport situations. Persons with high level of EO who have negative image of their abilities, are characterized by reduced performance quality after failure. Besides that, they choose either too hard or too easy goals and they think of sport as an opportunity to improve their social status. But according to Thomas (2005), a high level of EO does not necessarily have to have negative connotations. In professional athletes with positive image of their abilities, high level of TO and EO could lead to quality adjustment in various situations.

Compared to other three groups, the second group is characterized by significantly lower values of TO (3.91). Detailed view of the results shows that this group consists of few unmotivated children with low values of TO and EO. It is possible that their low skills level produce frustration and lack of motivation. Coaches should do the effort to adjust the exercises to their abilities or make the whole training process more interesting. Before making a conclusion about the levels and interactions between TO and EO, it is important to focus on results by Thomas (2005):

- During the sport career level of EO and TO tend to change
- During the training session, same athlete can be TO, and during the competition the same athlete can be EO
- In children, it is good to have higher level of TO, and it should be encouraged by coaches

So it would be useful for further researches of TO and EO, to get the following answers: is the structure of orientation stable or does it change? Do those changes grow positively or negatively (increase of EO)? Could giving up sports be predicted by the structure of orientation towards organized physical activity? Are those negative emotions and behaviour in children correlated with the structure of orientation to physical exercising?

## References

1. Cervello, E.M., Escarti, A. and Guzman, F. (2007). Youth sport dropout from the achievement goal theory. *Psicothema*, 19 (1), 65-71.
2. Duda, J.L. (1989). The relationship between task and ego orientation and the perceived purpose of sport among male and female high school athletes, *Journal of Sport and Exercise Psychology*, 11, 318-335.
3. Grgantov, Z., I. Gabrić, Đ. Miletić (2008). Intrinzična i ekstrinzična orijentacija kod mladih odbojkašica. U: Maleš (ur.), *Zbornik radova međunarodnog znanstvenog kongresa “Suvremena kineziologija”*, Mostar, 104-109.
4. Moreno, J.A., Hellin, P., Hellin, G., Cervello, E. and Sicilia, A. (2008). Assessment of motivation in Spanish PE students: Applying achievement goals and self determination theories. *The open educational journals*, 1, 15-22.
5. Thomas A.J. (2005). *Achievement goal profiles among elite baseball players*. Master thesis. Faculty of the Graduate School, University of North Carolina Greensboro.

## NEW LAW AND REORGANISATION OF ELEMENTARY SCHOOLS IN THE CIVIL CROATIA IN 1874 – INTRODUCTION OF COMPULSORY PHYSICAL EDUCATION

Zrinko Grgić<sup>1</sup> and Zrinko Čustonja<sup>2</sup>

<sup>1</sup>Croatian Sports Museum, Zagreb, Croatia

<sup>2</sup>Faculty of Kinesiology, University of Zagreb, Croatia

### Abstract

The aim of this research was to analyse the activities and the events preceding and enabling to passing of the first Croatian Act on Education - *Zakon ob ustroju pučkih školah i preparandijah za pučko učiteljstvo u kraljevinah Hrvatskoj i Slavoniji* [Act of the constitution of primary schools and teacher-training schools for teachers in the kingdoms of Croatia and Slavonia – In Croatian.] in 1874 by which the obligatory physical education classes were introduced into primary schools in Croatia. On the whole this Act is considered to be one of the most advanced acts on primary school in the then Europe. The archival materials, mostly unprocessed until now, of the Croatian State Archives, the Croatian Sports Museum and the National and Univeristy Library in Zagreb were used. The introduction of obligatory physical education classes into Croatian primary schools is connected with the development of the bourgeois society and pedagogical idea in Croatia.

**Key words:** history, physical education, Croatia, elementary schools, obligatory classes

### Introduction

From the 16<sup>th</sup> century and the moment the Kingdom of Croatia had established state-constitutional relationship with the Habsburgs' crown (1527) until the second half of the 18<sup>th</sup> century, the most diligent in the matters of education in the territory of today's Croatia were ecclesiastical orders: Paulist Fathers, Franciscans and Jesuits. They founded first grammar schools (in 1503) and universities (in 1669). In the time of Maria Theresa (1740-1780), the schooling system in Hungary, Croatia was then its administrative component was organised by the document «Ratio educationis» in 1777. Later, two decrees – “Ratio educationis publicae” in 1806 and “Systema scholarum elementarium” in 1845 – also regulated questions concerning education in the Habsburg Empire. The documents were not comprehensive laws on education, but just administrative orders (Petris-Martinčić, 1992) which did not address physical education (PE) at all.

It was found that the political motives, that is, the strong processes of Germanization of Croatia during the 1850s, dominantly conditioned the introduction of nonobligatory physical education classes and the arrival of the first physical education teachers to Croatia who held the classes exclusively in German and in accord with the principles of the German gymnastics system. (Bobić, Čustonja, 2005)

First serious attempt to organise an advance education in Croatia occurred in the Civil Croatia in 1848. The proposal of the law on education, “Basics of Principal Rules for Public Instruction in Croatia and Slavonia” (“Osnove temeljnih pravila javnog obučavanja za Hrvatsku i Slavoniju”) was prepared in very short time (Cuvaj, 1910). This act specified compulsory PE classes in elementary and secondary schools, but due to political developments in 1848, the war against Magyars and the Octroyed Constitution enactment in the Habsburg Monarchy in March 1849, the detail were neither elaborated nor was the act ever implemented. Nevertheless, the “Basics” from 1848 are the first so far known written source on compulsory PE teaching in the schools of the Civil Croatia. The “Basics” were the first autonomous legislative attempt to organise schooling in Croatia. (Bobić, Čustonja, 2005)

The Law on Organisation of Elementary Schools and Teacher Training Schools in the kingdom of Croatia and Slavonia (“Zakon ob ustroju pučkih školah i preparandijah za pučko učiteljstvo u kraljevinah Hrvatskoj i Slavoniji”) was passed in 1874 as the first Croatian law on education drawn entirely by the Croatian educators and approved by the Croatian Sabor (Parliament). The Law stipulated, among other things, the compulsory PE classes in all elementary schools and teacher training schools (preparandija) across the Civil Croatia (the Banska Croatia).

The aim of this study is to analyse activities and events that preceded the enactment of the first Croatian law on education: The Law on Organisation of Elementary Schools and Teacher Training Schools in the kingdom of Croatia and Slavonia, by which the compulsory PE were introduced into elementary schools in the territory of entire Croatia. Cultural and civilisation influences will be investigated, as well as circumstances in which the decision was reached.

The main source used is a work by Antun Cuvaj “Građa za povijest školstva kraljevina Hrvatske i Slavonije od najstarijih vremena do danas” [“Sources for the history of education in the kingdoms of Croatia and Slavonia from the ancient times till nowadays”], 2<sup>nd</sup> edition, volumes I-XI, 1910-1913, the most comprehensive and most frequently used



source in national history studies on education. A number of archive and library documents from the Croatian State Archives, the Croatian Sports Museum and the National and University Library of Zagreb were also used.

### Political circumstances in Croatia

The Emperor Francis Joseph I. was forced in 1867 to come to Agreement (Ausgleich) with Hungary and to relinquish some royal authority to it. By the Austro-Hungarian Agreement the Habsburg Empire was divided into two halves and became the Austro-Hungarian Monarchy. The Civil Croatia (Croatia-Slavonia) became a dependency of Hungary, whereas Istria and Dalmatia were under direct control of Austria. The Military Frontier was under the military administration, i.e. indirectly it was under the Viennese control. Due to the special state right position of Croatia in the Habsburg Empire, the Magyars were forced into separate Croato-Hungarian Nagodba (Agreement) in 1868 by which Croat statehood was recognised, although reduced to a bare minimum. The Croat Sabor and Ban retained the control over the internal affairs, administration, justice, education and religious affair. (Pavličević, 2000)

As a consequence, the Croatian State Government, responsible to the Croatian Sabor, was established in 1869. This was the beginning of a new era in the Croatian history of executive authority which guaranteed autonomy in the matters of education, thus providing the essential preconditions for the forthcoming reorganisation. The second political precondition was met in 1873 by the appointment of Ivan Mažuranić as Ban (Vice-Roy). Ivan Mažuranić (1814-1890) was the first Croatian non-aristocratic Ban (1873 - 1880); a poet, lawyer and politician; several times elected as representative in the Croatian Sabor; in the period 1861-1865 he was the Croatian chancellor in Vienna; frequently referred to as the Ban Reformer due to his efforts to foster administrative, economical, cultural and educational improvements in Croatia. He modernized the judicial system and state administration, introduced the law on the freedom of press and many other laws and decision regulating versatile aspects of public life. In the times of his governor's tenure, the foundations of modern Croatia were set. The new law on education stipulated a four-year compulsory general education, elementary schools were exempted from the control of Church, and the revived and reorganised University started to operate. (Pavličević, 2000)

### Advances of pedagogy in Croatia

Some other preconditions for a new law on schooling must have been also met besides these two basic, political ones. The most important among them were advances of pedagogy in Croatia, which were manifested in 1865 in foundation of Teachers' Association (Učiteljska zadruga) and in a proposal of modern law on schooling under the title Constitution of Elementary Schools in the Triune Kingdom. Further, Stjepan Novotny published the first textbook on pedagogy in the Croatian language in 1867, and "Didactics" of J. A. Komensky was translated into Croatian in 1871. In the same year the Croatian Pedagogical-Literary Association was founded. This professional pedagogical society had a tremendous influence on organisation and professional advancements of Croatian teachers. Many pedagogical titles were published and many libraries were opened. Particularly important for the development of education in Croatia was the First General Conference of Croatian Teachers held in Zagreb in 1871. There were approximately 1,400 participants. The Conference defined the attitude of the body of Croatian teachers towards the role of school in society and clearly denoted the rights and responsibilities of teachers as a social group, underlining that it should be independent of church. (Ogrizović, 1989)

The question of a school reform was an everlasting public topic, despite the fact that the Croatian Sabor did not have it on its agenda until 1874. A. Cuvaj points to three newspaper articles from 1869 which present the following issues: previous proposals of law on education, a discussion about education held in the assembly of the Zageb County Council, a petition of the Croatian Pedagogical-Literary Association to the Croatian Sabor in 1873 and their application to Sabor from September 1873 to "include urgently the issue of elementary school reform on the agenda". (Cuvaj, 1910) A lively public debate was incited by the request of teachers to change their insecure social position (local administration was in charge of teachers' salaries; low and irregular income) and become civil servants. (Cuvaj, 1910) All the mentioned were the social and political circumstances in which the school reform was inevitable.

### New Law on Education and PE

During April 1874, a conference was held on the reorganisation of elementary schools in Autonomous Banovina of Croatia, which was summoned and presided personally by the Croatian Ban Ivan Mažuranić. On the basis of the proposal of the legislative foundation for establishment of plebeian (elementary) schools, made by the Principal of the Government Office for Religious Affairs and Teaching Pavao Muhić, PhD, and his counsellor Janko Jurković, the "Outline of the Law on Organisation of Plebeian Elementary Schools and Teacher Training Schools in the Kingdoms of Croatia and Slavonia" ("Osnova zakona ob ustrojstvu pučkih škola i preparandija za pučko učiteljstvo u kraljevinah Hrvatskoj i Slavoniji") was prepared at the Conference. The Ban Ivan Mažuranić submitted the Outline to the Sabor in August 1874. (Cuvaj, 1910)

On September 8, 1874, the Croatian Sabor passed, after vivid and substantial discussion, the Law on Organisation of Elementary Schools and Teacher Training Schools in the Kingdoms of Croatia and Slavonia, and the Emperor Francis Joseph I. ratified the Law on October 14, 1874. It was the first law which regulated education in Croatia. Among other things,

a four-year comprehensive, all-inclusive compulsory education was introduced, elementary schools became general and public, they were exempted from the church control, and the compulsory PE was introduced. The law in its integrity was evaluated as one of the most progressive law on elementary school in the then Europe. (Ogrizović, 1989, Dumbović, 1999)

## Conclusion

Constitutional (state-right) position of Croatia and unfavourable political circumstances in the 19th century influenced powerfully the process of introducing compulsory PE classes in the then educational system. Namely, if Croatia had been autonomous enough, that is if Croatian educators had been free to decide on the matters of education autonomously, the educational system in the then Croatia would have been legally put in order in 1848, meaning that compulsory PE would have been introduced into elementary and secondary schools even then.

In 1861 representatives in the Croatian Sabor passed the law on education which provided both compulsory and optional PE classes. Unfortunately, the Emperor, for political reasons, suspended all the decisions and laws passed in the Sabor in 1861. Later, educators managed twice (in 1865 and 1871) to draw attention of the Croatian public and politics to the issues of educational system, but primarily due to political reasons it was not until 1874 that the issues of education were settled by the first Croatian law on education which provided compulsory PE. Two political preconditions facilitated the settlement: the Croatian-Hungarian Nagodba from 1868, that guaranteed Croatian autonomy in educational matters, and appointment of Ivan Mažuranić to the position of the Croatian Ban (“Reformer”) in 1873.

A strong development of pedagogy characterised the period between the Bach’s Absolutism (1850-1860) and the year 1874, the year of compulsory PE introduction in Croatia. In the time when Croatian sport and exercise movement was not alive yet, the circles of general educators (teachers) were generators of the motion and eager advocates for inclusion of PE in the curricula, as can be seen in the first Croatian professional journal on pedagogy “Napredak” from 1859.

## References

1. Ogrizović, M. (1989). Prilozi nacionalnoj povijesti pedagogije. Zagreb: Školske novine.
2. Pavličević, D. (2000). Croatian History. (In Croatian.) Zagreb: Naklada P.I.P. Pavičić.
3. Croatian Official Gazette (1874). Exercise school (In Croatian). No.170, July 28<sup>th</sup>, p. 3.
4. Croatian State Archives, sources of Hungarian Regency Council (Ugarsko namjesničko vijeće), dep. Scholastici 27071844, box 6.
5. Croatian State Archives, sources of the Zagreb County, protocol No. 36, para. 22 from September 13, 1797.
6. Cuvaj, A. (1910). Sources of the history of education in the kingdoms of Croatia and Slavonija from the ancient times till nowadays (In Croatian). Vol. I-XI. Zagreb: Kraljevska hrvatska-slavonska-dalmatinska zemaljska vlada, Odjel za bogoštovlje i nastavu.
7. Petris-Martinčić, R. (1992). Acts on Croatian schooling system in 19<sup>th</sup> century (In Croatian). Anali za povijest odgoja, 1, 121-124.
8. Bobić, G., Čustonja, Z. (2005). Early Beginings of Physical Education in Croatia. Proceedings Book of the 4th International Scientific Conference ”Science and Profession – Challenge for the Future”, Opatija, Croatia, Septemer 7 – 11, 2005. pp. 757-760.
9. Dumbović, I. (1999). Razvoj pedagoške misli u Hrvatskoj. U: A. Mijatović (ur.) Osnove suvremene pedagogije, str. 81-100, Zagreb: Hrvatski pedagoško-književni zbor.

## THE INFLUENCE OF PHYSICAL FITNESS ON PHYSICAL SELF-CONCEPT IN TEN YEARS OLD SLOVENIAN BOYS

Črtomir Matejek and Jurij Planinšec

*University of Maribor, Faculty of Education, Maribor, Slovenia*

### Abstract

The aim of our research was to establish whether there is a correlation between the physical fitness and physical self-concept of preadolescent boys. The research has been carried out on ten years old 216 boys. In order to assess the physical fitness, six Eurofit tests and Polygon backwards test have been used. The Physical Self- Inventory – short form questionnaire was used to obtain the physical self-concept. To define the bivariate correlation between the physical fitness tests and the physical self-concept the Pearson's correlation coefficients were calculated. Multiple-regression analyses found that the physical self-concept is influenced by cardiorespiratory endurance and explosive leg power. The present findings suggest that physical self-concept is closely related to physical fitness in ten years old boys.

**Key words:** *global self-esteem, motor development, general self-concept, motor abilities*

### Introduction

It is a fact that physical self-concept is difficult to define in a way that a general agreement about what physical self-concept actually is would be reached. Fox (1998) defined physical self-concept as a whole of knowledge, feelings, memories, and experience that individuals experience in connection to their own bodies. Forming of self-concept represents one of the key development tasks of childhood and adolescence, which is directed from the state of relative generality and non-differentiation towards the state of increasing complexity, stratification, and hierarchic order (Schaffer, 1996). Shalveson et al. (1976) suggested the first complex theoretical model of self-concept, which was defined as individuals perception of themselves formed on the basis of experience and with the interpretation of their social environment, which is supposedly under the influence of evaluation of the significant others (Marsh, 2005). Physical self-concept represents a mental picture of our own body, which is formed in our minds (Schilder, 1999) and is not necessarily connected to the actual appearance of the individual (Cash, 1997). According to the self-concept model of Shalveson et al. (1976), where physical self-concept as one of the fields of non-academic self-concept is comprised of physical activity and physical appearance, Fox and Corbin (1989) developed a multidimensional hierarchic concept of physical self-concept consisting of four subfields: appearance, power, endurance, and sports competence. Physical self-concept has a special place in the structure of self-concept as through its appearance, talents and characteristics the body is a mediator between an individual and external world (Fox, 1997). When growing up, self-concept of children is becoming increasingly structured and complex (Marsh et al., 1998). In the period of childhood and adolescence individuals develop different competences including physical competence, which could be understood as individuals' awareness of their physical fitness that is crucial for successful learning and performing of different physical skills. Physical activity can have a great influence on co-forming the entire self-concept when a child values this field as important (Planinšec, 2002). Negative self-concept can be displayed as eating disorders (Cash & Deagle, 1997), social anxiety (Cash & Fleming, 2002a), low general self-concept (Powell & Hendricks, 1999), weakened sexual activity (Wiederman, 2002), and reduced quality of life (Cash & Fleming, 2002b). It is more likely for young people with negative self-concept to behave unhealthy and have an unhealthy lifestyle, as they would more frequently reach for cigarettes (Faucher, 2003) and drink alcohol (Stein et al., 1998). Important contribution to raising the general self-concept is brought by that physical activity, which contributes to increasing the physical fitness to a higher level (Schneider et al., 2008). Men value their physical self-concept more than women (Asçi et al., 2005), while on the contrary women value physical appearance more (Moreno et al., 2007). Research so far has put a lot of attention to establishing the influence of physical activity and physical fitness to physical self-concept (Fridlund Duton et al., 2006), but in Slovenia research on children in the transition from childhood to adolescence has not been done yet. The question is whether and how reduction of physical skills in children that we witness in the last decade reflects on the perception of their physical self-concept.

## Methods

**Participants:** Participants consisted of 219 boys aged 10 ( $M = 9.8$ ,  $SD = 0.8$ ) from various primary schools in northeastern Slovenia. Data was acquired within the framework of an extensive research on the influence of several environmental factors on growth and development of children. All participants were healthy at the time of the survey. Parents of the participating children were acquainted with the purpose of the research and the course of survey and have previously signed a written consent about their children's inclusion into the research.

**Variables and instruments:** In order to assess the physical fitness, six Eurofit tests have been used: 20 meters Endurance Shuttle run, Standing Broad Jump, Flamingo test, Sit-ups 30 seconds, Plate Tapping, Sit and Reach (Adam et al., 1993), in addition Polygon Backwards (Pišot & Planinšec, 2005) test was used. Data on age, gender, and physical self-concept were acquired by The Physical Self-Inventory – short form (PSI-SF) (Maiano et al., 2008). It is the short version of the Fox and Corbin (1989) questionnaire Physical Self-perception Profile, L'inventaire du Soi Physique (Ninot et al., 2000). Total of three statements contains one of the six extensions of physical self-concept. High reliability of the Slovene version of the questionnaire was established previously (Pepevnik, 2009). Questionnaire for establishing physical self-concept of adolescents consisted of 18 questions. Using a 6-point true–false response scale, participants reported the extent to which they endorsed statements about their physical appearance and abilities.

**Data collection:** Measurements were carried out in spring, always before noon in especially prepared facility. The entire testing of one child did not exceed one hour. All measurements were carried out by qualified experts. Results of the measurements were entered into pre-prepared charts. Children completed the questionnaire of the physical self-concept after physical fitness tests.

**Data analysis:** Before data analyses, screening procedures tested assumptions for parametric tests the Distribution of polygon backwards was positively skewed and consequently was subjected to a logarithmic transformation. Pearson correlations examined the bivariate association of physical fitness to physical self-concept. The unique contributions of physical fitness tests to physical self-concept were determinate through multiple-regression analyses. Age was entered as control variable. Statistical significance was set at an  $\alpha$  level of 0.05.

## Results

First we present the results of the Bivariate correlation, and next the regression analysis of the influence of physical fitness to physical self-concept. Boys evaluated their physical self-concept in the range from 26 to 106 ( $M = 74.71$ ,  $SD = 17.34$ ).

### Bivariate Relationship between Physical Self-Concept and Physical fitness tests

Table 1 presents the two-way correlations between physical fitness measurements and physical self-concept. Physical self-concept positively correlates with following tests *20 meters Endurance Shuttle run*, *Standing Broad Jump*, *Sit-ups*, *Plate Tapping* ( $p < .001$ ), and negatively correlates with the *Flamingo balance* and *Polygon Backwards tests* ( $p < .001$ ). We should point out that in tests mentioned, lower values represent better results. Results of the Sit and Reach test do not correlate with physical self-concept.

Table 1. Bivariate Correlations among Physical Self-Concept and physical fitness in Slovenian boys

Physical fitness tests	Physical Self- Concept	Mean (SD)
Polygon Backwards (sec)	-,366**	8,16 (2,489)
Plate Tapping (N°)	,230**	33,06 (4,824)
Sit and Reach (cm)	,045	15,42 (6,157)
20 meters Endurance Shuttle run (vo2max)	,524**	29,10 (5,618)
Standing Broad Jump (cm)	,471**	151,59 (24,367)
Flamingo balance (N°)	-,244**	14,38 (6,739)
Sit-ups (N°)	,393**	18,63 (4,363)

\*\* $p < .001$

## Independent influence of Physical Fitness tests on Physical Self-Concept

Independent influence of physical efficiency variables to physical self-concept was established with the multiple regression analysis. Table 2 shows standardized regression coefficients ( $\beta$ ) and total determination coefficient ( $R^2$ ) of physical self-concept. Boys physical fitness significantly ( $p < .001$ ) influences on physical self-concept, as it explains as much as 32 % of variance of physical self-concept ( $R^2 = .320$ ). Table 2 shows that results in the physical self-concept of boys are significantly explained by endurance ( $p < .001$ ) and explosive leg power ( $p < .05$ ). Regression coefficient ( $\beta = 0.344$ ) shows that boys with better endurance and explosive leg power ( $\beta = 0.223$ ) have higher physical self-concept.

Table 2. Summary of Multiple Regression Analyses for Variables Predicting Physical Self-Concept

Physical fitness tests	Standardized Coefficients $\beta$	Overall adj. $R^2$
Polygon Backwards (sec)	-,101	
Plate Tapping (N°)	-,033	
Sit and Reach (cm)	-,035	
20 meters Endurance Shuttle run (vo2max)	,344**	0,320**
Standing Broad Jump (cm)	,223*	
Flamingo balance (N°)	,038	
Sit-ups (N°)	,098	

\* $p < .05$ , \*\* $p < .001$

## Discussion and conclusions

Present research has established that physical efficiency correlates with the physical self-concept evaluation of older boys, which was also established by Carraro et al. (2010). There is a distinctively positive correlation between physical self-concept evaluation and endurance, explosive leg power, body power, speed of alternative movements as well as balance and coordination of the whole body. Results of the regression analysis have shown that endurance and explosive leg power influence on physical self-concept. Similar results were reached by Fridlund Dunton et al. (2006), who established positive correlation between the maximum oxygen consumption, as a measure of endurance and all the dimensions of physical self-concept in girls. Carraro et al. (2010) established a positive correlation between endurance and physical self-concept in both genders. More endurable boys have higher physical self-concept than their less endurable peers. In addition, ten-year-old boys with higher explosive power have higher physical self-concept than their peers. Results of the research show high significant ( $p < .001$ ) correlation of boys' physical self-concept with all physical fitness tests, with the exception of Sit and Reach test, which measures the flexibility of the body. Number of experiences correlated to the body increases with years, which certainly reflects in an increasing connection of the mentioned variables. It is also clear that regular, suitably intensive, and frequent enough physical activity contributes to the improvement of physical fitness. So it can be concluded that this was the reason that physical self-concept is related with physical fitness. Similarly, Fridlund Dunton et al. (2006) established that physical fitness as well as physical activity both closely correlates with a subjective evaluation of a physical self-concept. Physical activity contributes to the positive physical self-concept only when it contributes to the improvement of physical fitness as well (Schneider et al., 2008), which was confirmed by the findings of our research as well. Boys, whose physical fitness is on a high level, have higher physical self-concept than their less physically fit peers. It is a fact that physical fitness is genetically determined to some extent (Gaskill et al., 2001). One of the possible conclusions of our research is that individuals that have genetic predisposition to higher level of physical fitness are similarly in advantage in terms of their physical self-concept. Such individuals get even more positive experience from being physically active and as a consequence they value their physical self-concept better. It seems reasonable to enhance above all the physical activity of less physically fit boys and thus contribute to their positive physical self-concept. The period of adolescence, which starts at about the age of ten or eleven, is the most critical period regarding physical self-concept (Grogan, 1999). It is the period of changes, self-awareness, and identity search. Findings confirm the fact that by the end of their late childhood, children are already aware of their bodies and their own physical fitness, which all indirectly influence their self-perception. Efficiency of different approaches to enhance positive physical self-concept depends mainly on the parents, teachers, coaches, and other people. Our research calls attention to the fact that physical fitness have important role in forming children's physical self-concept. Problems occur when badly developed physical fitness are the cause for development of negative feelings connected to the body and its fitness. To ensure a stimulative environment, which strengthens and supports children's self-perception, parents, teachers and others can redirect children's attention to their strong areas and thus reduce the effect of physical appearance on the children's self-evaluation helping them to form a more real image of themselves.

## References

1. Adam, C., Klissouras, V., Ravazzolo, M., Renson, R., & Tuxworth, W. (1993). *Eurofit: European Tests of Physical Fitness*, 2<sup>nd</sup> edn. Strasbourg: Council of Europe, Committee for the development of sport.
2. Asçi, F., Eklund, R.C., Whitehead, J.R., Kirazci, S., & Koca, C. (2005). Use of the CY-PSPP in other cultures: A preliminary investigation of its factorial validity for Turkish children and youth. *Psychology of Sport and Exercise*, 6, 33-50.
3. Carraro, A., Scarpa, S., & Ventura, L. (2010). Relationships between physical self-concept and physical fitness in Italian adolescents. *Perceptual and motor skills*, 110 (2), 522-530.
4. Cash, T. F., & Deagle, E. A. (1997). The nature and extent of body-image disturbances in anorexia nervosa and bulimia nervosa: A meta-analysis. *International Journal of Eating Disorders*, 22, 107-125.
5. Cash, T.F., & Fleming, E.C. (2002a). Body image and social relations. In T.F. Cash & T. Pruzinsky (Eds.), *Body image: A handbook of theory, research, and clinical practice* (pp. 277-286). New York: Guilford Press.
6. Cash, T.F., & Fleming, E.C. (2002b). The impact of body-image experiences: Development of the Body Image Quality of Life Inventory. *International Journal of Eating Disorders*, 31, 455-460.
7. Cash, T.F. (1997). *The Body Image Workbook*. Oakland: New Harbinger Publications.
8. Faucher, M.A. (2003). Factors that influence smoking in adolescent girls. *J. Midwifery Womens Health*. 48:199-205.
9. Fridlund Dunton, G., Schneider, M., Graham, D.J., & Cooper, D.M. (2006). Physical activity, Fitness and Physical Self-Concept in Adolescent Females. *Pediatric Exercise Science*. 18, 240-251.
10. Fox, K.R. (1998). Advances in the measurement of physical self. In J.L. Duda (Ed.), *Advances in sport and exercise psychology measurement* (pp. 295-310). Morgantown, WV: Fitness Information Technology.
11. Fox, K.R., & Corbin, C.B. (1989). The physical self-perception profile: Development and preliminary validation. *Journal of Sport and Exercise Psychology*, 11, 408-430.
12. Gaskill, S.E., Rice, T., Bouchard, C., et al. (2001). Familial resemblance in ventilatory threshold: the HERITAGE Family Study. *Med. Sci. Sports Exerc.*, 33,1832-1840.
13. Grogan, S. (1999). *Body image: Understanding body dissatisfaction in men, women and children*. London & New York: Routledge.
14. Maïano, C., Morin, A.J.S., Ninot, G., Monthuy-Blanc, J., Stephan, Y., Florent, J.F., & Vallée, P. (2008). A short and very short form of the physical self-inventory for adolescents : Development and factor validity. *Psychology of Sport and Exercise*, 9, 830-847.
15. Marsh, H.W. (2005). *Self-concept theory, measurement and research into practice: The role of self-concept in educational psychology*. The British Psychological Society: Durham University.
16. Marsh, H.W., Craven, R. in Debus, R. (1998). Structure, stability and development of young children's self-concepts: A multicohort-multioccasion study. *Child Development*, 69, 1030-1053.
17. Moreno, J.A., Cervello, E., Vera, J.A., & Ruiz, L.M. (2007). Physical self-concept of Spanish schoolchildren: Differences by gender, sport practice, and levels of sport involvement. *Journal of Education and Human Development*, 1 (2),
18. Ninot, G., Delignieres, D., & Fortes, M. (2000). L'Evaluation de l'estime de soi dans le domaine corporel' *STAPS*, 53, 35-48.
19. Pepevnik, D. (2009). The physical self image of Slovene and French primary school pupils from the perspective of physical activity. *Journal of Elementary Education*, 2-3, 5-17.
20. Pišot, R., & Planinšec, J. (2005). *Motor space structure in early childhood*. Koper: Založba Annales.
21. Planinšec, J. (2002). The influence of sport activities in the formation of stable and positive self-concept. In R. Pišot, V. Štemberger, F. Krpač, T. Filipčič, (Eds.). *Child in motion: proceedings* (pp. 354-359). Ljubljana: Faculty of Education.
22. Powell, M.R., & Hendricks, B. (1999). Body schema, gender, and other correlates in nonclinical populations. *Genetic, Social, and General Psychology Monographs*, 125, 333-412.
23. Schaffer, H. R. (1996). *Social development*. Oxford: Blackwell Publishers
24. Schilder, P. (1999). *The image and appearance of the human body*. London: Routledge. (Original work published 1950)
25. Schneider, M., Fridlund Dunton, G., & Cooper, D.M. (2008). Physical Activity and Physical Self-Concept among Sedentary Adolescent Females; An Intervention Study. *Psychol Sport Exerc.* 9(1):1-14.
26. Shavelson, R.J., Hubner, J.J., & Stanton, G.C. (1976). Self-concept: Validation of construct interpretations. *Review of Educational Research*, 46(3), 407-441.
27. Stein, K.F., Roeser, R., & Markus, H.R. (1998). Self-schemas and possible selves as predictors and outcomes of risky behaviors in adolescents. *Nurs. Res.* 47:96-106.
28. Wiederman, M.W. (2002). Body image and sexual functioning. In T.F. Cash & T. Pruzinsky (Eds.), *Body image: A handbook of theory, research, and clinical practice* (pp. 287-294). New York: Guilford Press.

## COMPETITIVE STATE ANXIETY IN FEMALE VOLLEYBALL PLAYERS

Jelena Matešić<sup>1</sup>, Zoran Grgantov<sup>1</sup> and Dražen Čular<sup>2</sup>

<sup>1</sup>Faculty of Kinesiology, University of Split, Croatia

<sup>2</sup>CAF ("Citius – Altius – Fortius") Scientific – Sport Society

### Abstract

A revised version of the Competitive State Anxiety Inventory-2 (CSAI 2-R, Jones and Swain, 1992) was used on a sample of 66 female volleyball players competing at the junior championships of Dalmatia to test the level and direction of their competitive state anxiety. All subjects filled out the inventory about an hour before the beginning of the game. After the championship had ended, teams taking 1<sup>st</sup> to 6<sup>th</sup> place were identified. Descriptive indicators show that on average female volleyball players have a low level of somatic anxiety and a moderate level of cognitive anxiety and self-confidence. They view somatic and cognitive anxiety as irrelevant to their performance in the competition. They believe that self-confidence has a moderately positive effect on their performance. The univariate analysis of variance showed that there is a significant difference between teams in cognitive anxiety, and the level and direction of self-confidence. A Scheffe post-hoc analysis was also conducted on these variables in order to determine the significance of differences between certain teams. The analysis proved that the fourth-place team experienced a significantly greater level of self-confidence right before the first championship game than the first-place and sixth-place team. In addition, the fourth-place team found that their self-confidence had a significantly more positive effect on their game performance than the first-place and second-place team.

**Key words:** junior female players, CSAI 2-R, competition ranking, analysis of variance

### Introduction

Anxiety is defined as a complex, uncomfortable feeling of uneasiness, fear and tension accompanied by the activation of the autonomic nervous system. The state of anxiety, resulting from environmental stimuli, is connected with the increase of arousal. Arousal is a neutral psychological phenomenon which might be connected to negative (anxiety) and positive (flow) affects.

It is important to study emotions in sports because they affect the performance and give information about the relationship of the athlete and his/her environment (e.g. competition). The information may help understanding the behaviour of the athletes and create a programme for the improvement of certain athletes' performance. Along with challenges and stimuli, sport is also characterised by great uncertainty. Stress and uncertainty may increase the motivation level in some athletes, and they may cause anxiety in others. If the athletes have a positive perspective on their abilities (i.e. the abilities of the team in team sports), and if they believe that they have control over the situation in the competition, they will generally view the anxiety symptoms as positive (Kais, 2005). The multidimensional anxiety theory (Martens et al., 1990) assumes a negative linear correlation of cognitive anxiety and sports performance, a reverse "U"-shape relationship between somatic anxiety and performance and a positive linear correlation of self-confidence and sports performance. Martens et al. created a questionnaire comprising 27 statements (CSAI-2) to evaluate certain anxiety components. Jones and Swain (1992, according to Kais, 2005) claim that the way in which the athlete perceives anxiety is also very important, so this directional component or the direction of anxiety was included in the questionnaire. The CSAI2-R questionnaire, consisting of 17 statements, was created as a response to the critique of the factor structure of the questionnaire (Cox, Martens and Russell, 2003).

Studies identifying the relationships between certain anxiety components and sports performance (Woodman and Hardy, 2003) have determined that cognitive anxiety has a significantly greater negative effect on sports performance in male athletes in comparison to female athletes. In addition, the negative effect of this component was also greater in competitions of greater quality and importance. Self-confidence had a significantly greater positive effect on the sports performance of men and in competitions of higher levels of quality. Craft et al. (2003) did not find a significant correlation between cognitive anxiety and sports performance, while the correlation between somatic anxiety and sports performance was negligible, negative and did not prove to be statistically significant. A positive correlation between self-confidence and sports performance was identified albeit it was less than expected. The aim of this research was to determine the correlation between particular anxiety components and performance of junior female volleyball players in a competition.

## Methods

The sample of subjects in this research included 66 female volleyball players, members of 6 teams which competed in the 2010 championship of Dalmatia. All of the subjects filled out the CSAI2-R questionnaire (Cox, Martens and Russell, 2003) about an hour prior to the start of their first game. The CSAI2-R consists of 17 statements evaluated on a four-point Likert scale:

1. Completely incorrect
2. Mostly incorrect
3. Mostly correct
4. Completely correct

Out of 17 items in the questionnaire, seven evaluate the somatic anxiety component (e.g. “I feel excited”, “My body feel tense”), while the cognitive component (e.g. “I am concerned about choking under pressure”, “I am concerned that we can lose the game”) and self-confidence (e.g. “I am confident that I can meet the challenge”, “I am confident of coming through under pressure”) are assessed by five items each.

The results in the items belonging to the same anxiety component are added so three variables (anxiety components) are obtained from these 17 items:

CSAI SOM – somatic component, CSAI KOG – cognitive component, CSAI SAM – self-confidence

The possible range of results in the somatic anxiety component spans from 7 to 28, and the cognitive component and self-confidence from 5 to 20.

The subjects also evaluated the direction or the “directional perception” of anxiety for each item (statement) (Jones and Swain, 1992, according to Kais, 2005). Thereby, they responded to the statement:

“For my performance this is”: ... They circled numbers on a scale from -3 (very negative) to 0 (irrelevant) to +3 (very positive).

The results obtained from the same components are added in this case as well, so the variable of somatic direction (“USMJSOM”) may assume values from -21 to +21, and the cognitive direction (“USMJKOG”) and self-confidence (“USMJSAM”) from -15 to +15. The situational performance of female players was evaluated with regard to their competition ranking. The teams were ranked from 1<sup>st</sup> to 6<sup>th</sup> place according to this criterion.

Data were processed in such a way so that the distribution normality of six variables was initially tested in order to assess the intensity and the direction of particular anxiety components. Afterwards, basic descriptive indicators were calculated: mean value, standard deviation, and minimal and maximal values.

The univariate analysis of variance tested the significance of differences in the measured variables with regard to team rankings. Differences between individual teams were analysed for the variables which obtained significant differences by Scheffe post-hoc analysis.

## Results

Table 1. Descriptive indicators of certain anxiety evaluation variables: mean (AS), minimal (MIN) and maximal (MAKS) values; standard deviation (SD) and the Kolmogorov-Smirnov normality test (KS)

	AS	MIN	MAKS	SD	KS*
CSAISOM	12.652	7.000	21.000	3.130	0.13
CSAIKOG	11.318	6.000	18.000	2.684	0.13
CSAISAM	13.227	7.000	19.000	2.618	0.10
USMJSOM	1.621	-10.000	20.000	5.670	0.13
USMJKOG	-0.879	-14.000	11.000	4.770	0.10
USMJSAM	5.576	-8.000	14.000	5.283	0.10

\*d value of the KS test for N=66 equals 0.17

The results of every variable in the Kolmogorov-Smirnov test for distribution normality assessment (table 1, column 6) are lower than the limit values for the studied sample of subjects. Therefore, it may be concluded that all variables have a normal distribution, and that it is possible to continue with further parametric data processing. By analysing the obtained descriptive statistical parameters (table 1, columns 2-5), it may be noted that female volleyball players have on average a low level of somatic and cognitive anxiety, which is only slightly higher than the minimal values. The subjects generally regard the somatic and cognitive anxiety as something irrelevant to their performance, and they believe that self-confidence has a moderately positive effect on their performance.



Table 2. Descriptive variable indicators with regard to team rankings (1-6), univariate analysis of variance (*F* test) and Scheffe post-hoc test

RANKING	CSAISOM	CSAIKOG	CSAISAM	USMJSOM	USMJKOG	USMJSAM
1	11.18	10.36	11.18	0.64	-2.00	2.73
2	13.40	11.70	13.40	0.30	-0.10	2.50
3	12.33	10.83	13.75	3.00	-0.50	6.33
4	11.58	9.75	15.58	3.50	0.75	10.08
5	13.09	12.82	13.27	2.09	-0.27	6.64
6	14.70	12.80	11.80	-0.40	-3.50	4.30
F-test		2.88*	5.31***			4.11**
SCHEFFE			4:1**			4:1*
POST-HOC			4:6*			4:2*

\*  $p < 0.05$ ; \*\*  $p < 0.01$ ; \*\*\* $p < 0.001$

Table 2 shows mean values of analysed variables for each team separately, as well as the results of the analysis of variance in these variables with regard to team rankings. Univariate analyses of variance showed significant differences between the teams in three out of six observed variables: the level of cognitive anxiety, the level of self-confidence and the direction of self-confidence. Post-hoc analysis determined a significantly greater level of self-confidence in the fourth team in comparison to the teams which took first and sixth place. It was also found that the fourth-place team believed that self-confidence had a significantly more positive effect on performance than the first-place and second-place teams.

## Discussion and conclusion

Performance in a competition depends on numerous factors: fitness abilities, techniques and tactics, commitment, team cohesion, etc. The level of individual anxiety components right before the competition may also contribute to or decrease performance. If the competition results were only affected by the level of certain anxiety components, it would be possible to predict that the team which took 4th place in the championship would win the championship based on the results from the CSAI2-R questionnaire obtained in this research. Such a prediction may be explained by the lowest level of their cognitive anxiety and the highest level of self-confidence and the direction of self-confidence. Recent studies confirm the negative linear correlation of cognitive anxiety and competition performance and the positive linear correlation of self-confidence and competition performance (Woodman and Hardy 2003, Craft et al. 2003).

The fourth-place team entered the competition as a favourite on paper. Based on the descriptive variable indicators, it may be assumed that they too were aware of this role (lower level of somatic and cognitive anxiety and more self-confidence compared to the other teams). It is possible that this casual and confident approach to the competition resulted in a decreased involvement at the beginning of the competition (underestimating the opponent). And when performance was not going in the right direction, they didn't properly respond as a team, so the results were not good. On the other hand, the first-place team was not a favourite, which is also confirmed by the low level of their self-confidence prior to the beginning of the championship in comparison to the other teams. It can be assumed that the level of self-confidence rose during the competition as it was influenced by the good results. The limitations of this study arising from the fact that it is not possible to come to more certain conclusions are as follows:

- situational performance is determined by the ranking of the team which is only a framework performance criterion (e.g. a much more precise quality indicator is the situational performance of female players assessed on the basis of the quality of performance of technical and tactical elements of particular female players)
- the questionnaire was filled out only once, i.e. immediately prior to the first game played by a particular team in the championship. In that way it is not possible to identify potential changes in the anxiety level of particular female players at different stages of the competition.

## References

1. Cox, R.H., M.R. Martens, W.D. Russell (2003). Measuring anxiety in athletics: The Revised Competitive State Anxiety Inventory-2. *Journal of Sport and Exercise Psychology* 25: 519-533.
2. Craft, L., T.M. Magyar, B.J. Becker, D.L. Feltz (2003). The relationship between the competitive state anxiety inventory-2, and sport performance: A meta-analysis. *Journal of sport and exercise psychology*, 25 (1): 44-66.
3. Kais, K. (2005). Precompetitive state anxiety, self-confidence, and athletic performance in volleyball and basketball players. Dissertation, Institute of sport pedagogy and coaching science, university of Tartu, Tartu Estonia
4. Martens, R., D. Burton, R.S. Vealey, L.A. Bump, D.E. Smith (1990). Development and validation of the Competitive State Anxiety Inventory-2. In *Competitive Anxiety in Sport* (edited by R. Martens, R.S. Vealey and D. Burton), pp. 117-190. Champaign, IL: Human Kinetics.
5. Woodman, T., L. Hardy (2003). The relative impact of cognitive anxiety and self-confidence upon sport performance: a meta analysis. *Journal of Sports Sciences*, 21, 443-457

## INTRINSIC AND EXTRINSIC ORIENTATION IN FOLK DANCES

Ivana Musa<sup>1</sup> and Đurđica Miletić<sup>2</sup>

<sup>1</sup>Faculty of Natural science, Mathematics and Education, University of Mostar, Bosnia and Hercegovina

<sup>2</sup>Faculty of Kinesiology, University of Split, Croatia

### Abstract

The purposes of the present research were to identify the possible influence of intrinsic and/or extrinsic approaches on folk dance performance through detecting differences between three dancing ability groups: high dance performance (H, N=31) medium dance performance (M, N=14) and low dance performance (L, N=34). Three independent judges evaluated the dance performances of four specific folk dance steps throughout choreography. For group of orientation profiles definition, taxonomic analysis by K-means clustering was applied. In the repeated clustering, three groups of subjects were formed and intrinsic orientation was dominated. Low values of the extrinsic orientations were established. The results obtained (one-way MANOVA with the post-hoc Tukey's test) indicate significant differences for task (intrinsic) orientation in the group of high dance performance subjects in advantage for the low dance performance group. Intrinsic oriented subjects seem to provide a crucial element for the higher level of dance performance.

**Key words:** choreography, aesthetic movements, expression

### Introduction

In aesthetic movements expression is considered to be an ability of performance in which the idea of the choreography is transferred. Art impression differentiates itself from the accuracy of the performance; it is about understanding of the aesthetic model of the performance and it depends on the subjective assessment of a judge or a spectator. Emotions that serve as a foundation to the expressive performance can only be expressed through an inspired body movement. So, it is necessary to provoke certain emotion within a dancer for him to be able to express it through that body movement. Therefore, in dancing activities, it is of great importance to analyze the type of the motivation because it is assumed that the intrinsic orientation will dominate in the expressive performance.

The best known and most widely used measuring instrument to assess the level of intrinsic (IO) and extrinsic (EO) orientation is the TEOSQ questionnaire (Task and Ego Orientation in Sport Questionnaire). It is constructed by Duda and Nichols in 1992. Later on, certain conducted researches have determined stable factor structure of the questionnaire, satisfactory test-retest reliability and high internal connectivity (Fox and associates, 1994.). Barić & Horga (2006) have constructed and validated the Croatian version of that questionnaire. The authors came to the realization that there are four groups, or four possible orientation profiles: high IO/high EO, low IO/low EO, high IO/low EO, and low IO/high EO. The first group shows the biggest motivation for the activity, while the least motivation is seen within the second group. When regarding the folk dance it is particularly interesting to establish the relationship between the dominant type of orientation and different levels of dance abilities.

The main objectives of the research were: (1) to determine some metric characteristics of newly designed test for assessing level of folk dance performance (folk dance choreography); (2) to determine the existence of significant differences in the levels of dancer's intrinsic and extrinsic orientation between three dancing ability groups: high dance performance (H), medium dance performance (M), and low dance performance (L).

### Methods

The sample for this study consisted of 77 subjects (age of 19 to 22), students of the Faculty of Natural science, Mathematics and Education (Physical Education) in Mostar. The sample was divided according to the successful performance of the dance choreography in three groups: H-high dance performance (N=31), M – medium dance performance (N=14) and low dance performance (N=34).

All the subjects were obliged to perform four basic figures of Herzegovina's traditional folk dances and to complete TEOSQ. The subjects task was to learn to perform correctly the exact dance steps throughout choreography. Three independent judges evaluated the performances on 0 to 8 point scale. Scoring was based on giving a 0, 1, or 2 for each of the 4 dance segments. A 0 was given if a segment was missing from the performance. A score of 1 was given if the segment was performed incorrectly, while a score of 2 was given if the segment was performed correctly. To establish an overall performance score for each trial, the 4 segment scores were totalled. Thus, the final score could range from 0 to 8.

The Task and Ego Orientation in the Sport Questionnaire (TEOSQ) is an assessment of the dispositional achievement goal orientations. It is a 13-item scale asking participants to respond to task end ego statements following from the stem, “I feel successful in (dance) when...” Each item is answered on a five - point scale. Task orientation is assessed by statements revolving around the feeling of success derived from learning new skills, fun, trying hard, and practising. Assessment of ego orientation is based on the responses concerning doing better than friends, scoring most points, and being the best.

To establish sensitivity for all the applied variables, standard statistic parameters (Mean and Standard deviation) a KS test were calculated. To establish the objectivity of the estimation for the three judges (variable for assessing dance performance), Cronbach Alpha were calculated (.98). K-means clustering was used to derive three group of subject's according to IO and EO. A multivariate analysis of variance (one-way MANOVA) with the post-hoc Tukey's test was used to test the differences between the three groups of dancers according to IO and EO.

## Results

The results of the descriptive statistics (table 1) register a normal distribution of analyzed variables which, according to the KS test, shows no significant deviation from the Gaussian curve at the level of error of 0.05.

Table 1. Basic statistics (Mean  $\pm$  SD) and Kolmogorov-Smirnov test (K-S)

	Mean $\pm$ SD	K-S
Dance choreography	5.3 $\pm$ 2.2	.16
Extrinsic orientation (EO)	2.3 $\pm$ 0.7	.11
Intrinsic orientation (IO)	3.8 $\pm$ 0.7	.09

When proven that there are four groups of orientation profile (Fox and associates, 1994; Moreno and associates, 2008.b) it is also assumed that clusters would show up on the sample of dancers that were used for this research. But, using taxonomic analysis it turned out that this is not the case. In fact, from those four groups only three of them can be defined: high IO/high EO, low IO/low EO and high IO/low EO, while the group of low IO/high EO was not possible to define since IO dominated in every group.

Table 2. K-means clustering analysis set on four clusters (arithmetic means in EO and IO variables)

	group 1	group 2	group 3	group 4
Extrinsic orientation	2.7	3.1	1.8	1.8
Intrinsic orientation	2.9	4.3	3.3	4.3

Therefore, an additional taxonomic analysis has been calculated, (an option “K-means clustering” – three groups) and the next orientation profiles are the result of it: high IO/low EO, low IO/low EO and high IO/low EO (table 3).

Table 3. K-means clustering analysis set on three clusters (arithmetic means in EO and IO variables)

	group 1	group 2	group 3
Extrinsic orientation	2.24	3.09	1.75
Intrinsic orientation	3.03	4.26	4.20

According to the Wilks' test, (graph 1) there was a significant multivariate effect ( $F = 4.1$ ;  $p < 0.03$ ), meaning that the whole set of composites could significantly discriminate the groups.

To investigate which dependent variables contributed to the significant effect, post-hoc Tukey's HSD test was performed. The results (Table 4) show that the high dance ability group (4.0) had significantly higher values than the low dance ability group (3.6) concerning intrinsic orientation.

Table 4. Descriptive statistics for groups of H-high; M-medium and L-low dancing ability and results of MANOVA analysis (Post-hoc Tukey's Test)\*

	EO	IO
High dance ability (H)	2.4±0.8	4.0±0.6
Medium dance ability (M)	2.6±0.7	3.7±0.7
Low dance ability (L)	2.2±0.6	3.6±0.7*

\*Group L is significantly lower than group H;  $p < 0.05$ .

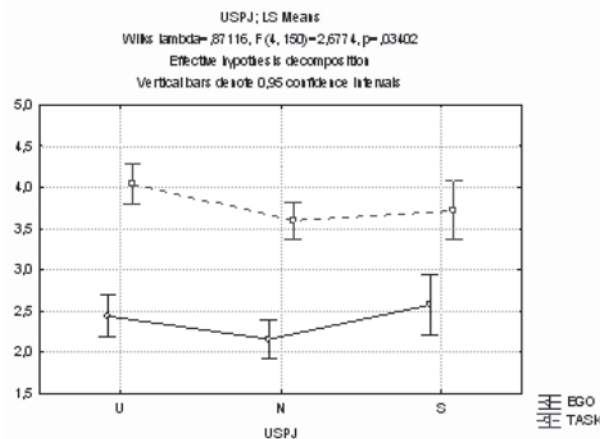

Graph 1. Wilks lambda tests of significance for different dancing ability groups in variables assessing IO and EO

## Discussion and conclusions

The newly designed test, which is being used to assess the level of the folk dance performance, is a precise and objective instrument and has good characteristics of sensitivity (differentiating the subject's). Judges have achieved a satisfactory level of objectivity and the subject's have, through a certain time period, learned the dance structure to the satisfactory level. The results have shown that those dancers that were more successful have their IO higher than their EO. Therefore, the second and the third group in Table 3 can be described like task oriented groups. According to the analysis of the differences between the groups, made by the quality of the dancing performance of the subject's, the best dancers have significantly higher levels of IO in relation to those dancers with the poor performance. At the same time their EO is not remarkably different. Unlike other researches that were made by the other authors (Fox and associates, 1994) and that established the existence of groups with a dominant EO such a group is not formed in this study. Dancing, as an aesthetic activity, is impossible to perform without certain emotions and expressions. Therefore, the lack of the group that has a low IO/high EO is understandable. These results comply with Miletic et al. (2008). This is a positive phenomenon given that Duda et al (1991) claim that dancers with high EO have low quality of performance and given effort after the failure.

Subjects define their folk dance competence on the basis of how well they improve their performance rather than comparing their performance to that of others. Intrinsic rather than an extrinsic approach in learning dances generally is expected because of aesthetic component of the dance. Aesthetic activity implies expressive performance, and only inspired movement produced expressiveness. Task - oriented subject were probably enjoy in the dance classes, and their expressiveness were visible to the judges. As Miletic et al (2008) suggests, task-oriented subjects were preoccupied with the dance steps improvement and persistent in correcting errors and improving their final performance. It seems that, when a dance performance is an issue, enhanced capacity for co-operation and personal mastery are more important than beliefs that success in dance is related to some external factors.

In conclusion, the intrinsic oriented subjects seem to provide a crucial element for the higher level of dance performance. This presupposition could be confirmed only if the subjects have approximate skills and abilities. Therefore, future studies that correlate dance skills with other anthropological features are necessary to confirm results of this investigation.

## References

1. Barić, R., Horga, S. (2006). Psychometric properties of the Croatian version of task and ego orientation in sport questionnaire. *Kinesiology*, 38(2): 135-142.
2. Duda, J.L., Nichols, J.G. (1992). Dimensions of Achievement Motivation in Schoolwork and Sport. *Journal of Educational Psychology*, 84 (3):290-299.
3. Duda, L.J., L.K. Olson, T.J. Templin (1991). The relationship of task and ego orientation to sportsmanship attitudes and the perceived legitimacy of injurious acts. *Research quarterly for exercise and sport*, 62 (1): 79-87.
4. Fox, K., M. Goudas, S. Biddle, J. Duda, N. Armstrong (1994). Children's task and ego profiles in sport. *British journal of educational psychology*, 64: 253-261
5. Miletić, Đ., Miletić, A., Maleš, B. (2008). Do task and/or ego orientation influence better dance performance? *U Proceedings of the 5<sup>th</sup> International Scientific Conference on Kinesiology, Faculty of Kinesiology - University of Zagreb, (623-626)*. Zagreb: Faculty of Kinesiology.
6. Moreno, J.A., P. Hellin, G. Hellin, E. Cervello, A. Sicilia (2008). Assessment of motivation in Spanish PE students: Applying achievement goals and self determination theories. *The open educational journals* 1: 15-22.

## SPORT AND KINESIOLOGICAL ACTIVITIES IN LEISURE TIME STRUCTURE OF ZAGREB STUDENTS

**Benjamin Perasović<sup>1,2</sup>, Marko Mustapić<sup>1</sup> and Sunčica Bartoluci<sup>2</sup>**

<sup>1</sup>*Institute of Social Sciences Ivo Pilar, Zagreb, Croatia*

<sup>2</sup>*Faculty of Kinesiology, University of Zagreb, Croatia*

### Abstract

Leisure time is a very important factor of youth culture, thus of college student population. Sport and physical activities contribute not only to young people's health, but also to stability and progress of the society as a whole. Hence, the aim of this study has been to establish the amount of time spent in sport and kinesiological (physical) activities, as well as latent dimension and structure of fundamental determinants of complete leisure time activities. In 2010, a research was conducted on a tree-stage-stratified sample of Zagreb University students. The results have shown that only a smaller number of students is often or on the regular basis involved in kinesiological activities or sport. These results have also shown that within the leisure time structure, the mentioned activities involve watching sport or entertainment, socialising and friends, betting and gambling.

**Key words:** *sport, kinesiological (physical) activities, leisure time, students, University of Zagreb*

### Introduction

Students are a specific part of youth general population. According to the Scientific Work and Higher Education Law (Act. 86), the student status in the Republic of Croatia is achieved by enrolling in a university, a two-year or four-year college; and it is proven by a valid student's ID. In the Republic of Croatia there are approximately 130 schools of higher education, of which 80 are faculties (4-year colleges). These schools of higher education are mostly sections of the following seven universities: Dubrovnik, Osijek, Pula, Rijeka, Split, Zadar and Zagreb. University of Zagreb consists of 33 schools of Higher Education divided in seven scientific fields (science, technical, biomedical, biotechnical, philosophy, humanities and fine arts fields). Considering the number of such schools, staff members and students it is the largest university in Croatia. Last year the number of enrolled students was 60,000 which is a bit less than half of the students population in Croatia. Therefore, from the rest of the youth population, higher education students mainly differ in acquired knowledge and education.

Leisure time is one of the essential factors in the youth culture. Youth culture, thus higher education culture is strongly determined by the way they spend time and by their relations with friends and different peer groups. Due to the fact, the leisure time in the adults everyday life is the time left after obligatory work, students leisure time is the time left after lectures, studying and similar duties during their higher education. M. Bartoluci and associates (2007) point out that it is essential to study the phenomenon of leisure time within the specific social context, and its interpretation depends on the time and the society which is being studied. Epochal social changes that had occurred in Europe (Beck, 1992; Berger, 1995; Castells, 1996; Dahrendorf, 1996), did not escape Croatia (Županov, 1995; Cifrić, 1998; Kalanj, 2000; Rogić, 2000), therefore, it is essential to keep in mind that the development of the free-market and consumer society during Croatia's transitional period undoubtedly has also had a huge impact on the leisure time structure activities of Croatian citizens. Žugić and S. Bartoluci (2004) point out that all contemporary sociological interpretations of leisure time are based on work leisure dichotomy work/leisure as structural components of post-industrial society that determined the behaviour of people in the world of work and idle. S. Bartoluci and Perasović (2007) stated that numerous researches prove that engaging in physical activities on the regular basis contributes to the stability and progress of the society as a whole. The same authors, Perasović and S. Bartoluci (2008), when talking of youth leisure time separate four key factors according their importance: 1.) leisure time is essential to the growth of a young person so he or she can maturely take the roles of parenthood; 2.) during leisure time young people often develop personal identities and life styles of their own; 3.) leisure time is essential for the quality of life and the way a person spends it, is directly connected with the quality life indicators; 4.) kinesiological activity or "engagement in sport" is of crucial importance to the health of the individual and the society. Ilišin (2002, 2007) has proven that the leisure time patterns among young people in Croatia are very stable. Young people are primarily interested in the phenomenon of private sphere, while at the same time they are a lot less interested in public and political issues.

## Methods

The general aim of this study is to establish latent dimensions and the structure of fundamental determinants of student activities in leisure time during the research implementation. Prior to this, it ought to be established a student's estimate of how often chosen activities in leisure time are practiced by them and also whether there are any sociodemographic or interpretative differences or similarities between the subgroups of subjects (gender, year and field of study). In tune with the research aims we compiled schools of higher education and ended up with two separate fields "science-technical-biomedical-biotechnical" and "humanities and fine arts". In order to achieve these aims field research data have been gathered (In 2011, Mustapić carried out a research for his Ph.D. dissertation, a survey of which consisted of total of 44 questions with 175 variables.). The replies to survey task have been analyzed "State how often you engage in the following activities in your leisure time." with the choice of 13 activities which the participants evaluated on the scale of four multiple choice answers: 1.) *Seldom or never*; 2.) *Occasionally*; 3.) *Often*; 4.) *Regularly*. The survey data have been gathered by written surveying of students during the period of 26 April to 10 May 2010 on a three-stage stratified cluster sample, whose participants came from 14 schools of higher education. The sample included 612 students being 1% of University of Zagreb student body population. The sample consisted of two thirds women (63.9%). Similar to that one third of the sample consisted of freshmen students (32.3%), while the rest covered older students (67.7%). As far as the major field is concerned, (55%) came from "humanities and fine arts" compared to 45% from "science-technical-biomedical-biotechnical" majors. The basic level of statistic data processing was done by using univariate statistic techniques by which we got the frequency distribution, percentages, average values and standard errors. Following this, correlations were calculated using *t-tests* in order to prove the existence of differences between certain surveyed subgroups ( $p < 0.05$ ) in relations to the questioned ways of spending leisure time. In the end the replies of the participants to the question of leisure were subjected to factor analysis.

## Results and discussion

Table 1. Students personal estimate of leisure time activities

Leisure time activities	M	Standard deviation	Never, seldom or occasionally (%)	Often or regularly (%)
Socializing and hanging out with friends	3.08	0.9	27.7	72.3
Family time	2.79	0.9	3.4	61.6
Private life (boyfriend or girlfriend)	2.68	1.17	4.6	55.4
Watching or reading sports or entertainment news	2.54	0.93	5.2	49.8
Physical activities (sport, yoga, fields trips...)	2.46	0.94	5.2	42.8
Diversion (computer games, enigmetics...)	2.45	1	5.1	46.9
Doing nothing constructive	2.40	1.02	59.3	40.7
Culture events	2.16	0.80	69	31
Taking care of pets	2.02	1.16	6.5	34.5
Personal education (foreign language and other courses)	1.99	0.91	75.6	24.4
Actively participating in culture or entertainment	1.78	0.93	8.4	19.6
Student body work	1.37	0.77	91.5	8.5
Betting and gambling	1.31	0.71	9.9	8.1

In students leisure time most frequent activities are socialising and privacy (*spending time with friends, family, boyfriend or girlfriend*). Next on the scale are activities concerning sport; the participants are more prone to watching sports ( $M = 2.54$ ) than actively engaging in sports ( $M = 2.46$ ). It is essential to point out that the majority of the surveyed young people (57.2%) are *never, seldom or occasionally* engaged in physical or sport activities compared to those who are engaged often or regularly (42.8%). The results prove that during leisure time any form of social activism or personal growth of the surveyed young people is weakly represented. Generally, it can be concluded that the students are more prone to *consumer* than *proactive* ways of leisure time spending.

The testing of the differences among certain surveyed subgroups proved how often these activities occur during leisure time and also have not got any statistically significant differences between the student generations. However, there are three surveyed activities depending on the field of study and there are five depending on the gender. Humanities and fine arts students *more often keep track of culture events* ( $t = 2.912$ ;  $p = 0.004$ ), *work more on personal growth* ( $t = 2.563$ ;  $p = 0.011$ ) and are more involved in work with the student body ( $t = 3.597$ ;  $p = 0.000$ ). Men are statistically more than their female colleagues *actively engaged in physical activities* ( $t = 3.620$ ,  $p = 0.041$ ), *keep track of sports and entertainment*

news ( $t = 3.335$ ;  $p = 0.005$ ) or bet and gamble ( $t = 7,026$ ;  $p = 0,000$ ), while the women more *often take care of pets* ( $t = -4.683$ ;  $p = 0.000$ ) and “*do nothing constructive*” ( $t = -2.852$ ;  $p = 0.010$ ). Therefore, the questioned population is mostly homogenous based on the leisure time research results.

The structure of practicing certain activities in leisure time of University of Zagreb students was determined by five-factor intercorrelation matrix. At the same time, we chose as significant correlations only those over  $\pm 0.3$ .

Table 2. Five-factor intercorrelation result matrix of student estimate of personal engagement in certain activities in leisure time with projections absolutely over  $\pm 0.3$  ( $N = 612$ )

Leisure time activities	FACTORS				
	1	2	3	4	5
Simply: Doing nothing constructive	0.829				
Diversion (computer games, enigmatics...)	0.501				
Betting and gambling	0.324	-0.342		0.403	
Following culture events		0.582			
Actively engaging in culture and entertaining events (playing, singing and acting)		0.567			
Socialising and going out with friends			0.314	0.302	
Family time			0.543		
Taking care of pets			0.408		
Privacy (spending time with girlfriend or boyfriend)			0.397		
Engaging in physical activities (sport, yoga, jogging, field trips...)				0.434	
Following sport or entertainment news				0.598	
Personal growth (foreign languages, courses, professional growth)					0.467
Engaging in student body work					0.376

F1 = diversions; F2 = culture; F3 = socialising and privacy; F4 = sports and socialising; F5 = student activity and personal growth

All five activities factors in leisure time together explain 34.5% variance. The first factor is **diversion with 9.3%** variance, where of the given activities are: *doing nothing constructive, diversion (computer games and enigmatics and similar)* and also *betting and gambling*. **Culture** is the second factor and explains 7% variance. It includes *actively engaging in culture and entertaining events* and as well as their *tracking* interaction with negative correlation, *betting and gambling*. The third factor, **socialising and privacy**, explains the 6.9% variation and covers *socialising and going out with friends, family time, taking care of pets* and *private life*. The fourth factor, **sport and socialising**, explains the 6.7% variation covers *engaging in physical activities, following sport and entertainment news, spending time with friends, betting and gambling*. **Student body involvement and personal growth** is the fifth factor which explains the 4.5% variations and covers *personal growth and student body activities*. Due to the fact that this is about a very transparent and easily interpreted factor structure, factors can be treated as separate components. Factors analysis shows a match and logical grouping of students activities in their leisure time. It is clear that *kinesiological* and *following sports and entertainment activities* permeate among themselves.

## Conclusions

Based on health importance of physical activities, we cannot be satisfied with such form of merging, duo to the fact that potential health directed physical activity mixes with passive form of leisure time spending. These results are directed towards the need of public action taking, as it has been indicated more than once by different “nation strategy for youth”, also in course of strengthening and developing university sports, in course of broadening physical activities and sport recreation as an essential factor for a healthy society which is nowadays burdened by passively and non-active form of leisure time spending.

## References

1. Bartoluci, M.; Bartoluci, S.; Škorić, S. (2007). Slobodno vrijeme i aktivni odmor u turizmu. U: Bartoluci, M.; Čavlek, N. (ur.). *Turizam i sport - razvojni aspekti*, str. 70-78. Zagreb: Školska knjiga.
2. Bartoluci, S.; Perasović, B. (2007) Sport i slobodno vrijeme mladih. U: *Zbornik radova VII. konferencije o športu RZ Alpe-Jadran*, str. 243-250. Zagreb: Ministarstvo znanosti, obrazovanja i športa RH.
3. Beck, U. (1992). *Risk society: towards a new modernity*. London; Newbury Park; New Delhi: Sage.



4. Berger, P.L. (1995). *Kapitalistička revolucija*. Zagreb: Naprijed.
5. Castells, M. (1996). *The Rise of the Network Society, The Information Age: Economy, Society and Culture*. Vol. I. Cambridge, MA; Oxford, UK: Blackwell.
6. Cifrić, I. (1998). Tranzicijski izazovi i globalizacijski kontekst. U: Cifrić, I.; Čaldarović, O.; Kalanj, R.; Kufrin, K. (ur.), *Društveni razvoj i ekološka modernizacija: prilozi sociologiji tranzicije*. str. 79-108, Zagreb: Hrvatsko sociološko društvo i Zavod za sociologiju Filozofskog fakulteta Sveučilišta u Zagrebu.
7. Dahrendorf, R. (1996). *Razmatranja o revoluciji u Europi*. Zagreb: Antibarbarus.
8. Ilišin, V. (2002). Interesi i slobodno vrijeme mladih. U: Ilišin, V. i Radin, F. (ur.), *Mladi uoči trećeg milenija*, str. 269-302. Zagreb: Institut za društvena istraživanja; Zavod za zaštitu obitelji, materinstva i mladeži.
9. Ilišin, V. (2007). Slobodno vrijeme i interesi mladih. U: Ilišin, V. i Radin, F. (ur.) *Mladi: problem ili resurs*, str. 179-200. Zagreb, IDIZ.
10. Kalanj, R. (2000). *Ideje i djelovanje - Ogledi o kulturnim promjenama i razvoju*. Zagreb: Odsjek za sociologiju Filozofskog fakulteta.
11. Mustapić, M. (2011). *Studentska procjena važnosti aktualnih društvenih problema*. Doktorski rad. Zagreb: Filozofski fakultet.
12. Perasović, B.; Bartoluci, S. (2008) Slobodno vrijeme i kvaliteta života mladih. U: Andrijašević, M. (ur.). *Zbornik radova međunarodne znanstveno-stručne konferencije Kineziološka rekreacija i kvaliteta života*. Zagreb: Kineziološki fakultet.
13. Rogić, I. (2000). *Tehnika i samostalnost: Okvir za sliku treće hrvatske modernizacije*. Zagreb: Hrvatska sveučilišna naklada.
14. Zakon o znanstvenoj djelatnosti i visokom obrazovanju. Narodne novine (123/2003).
15. Žugić, Z.; Bartoluci, S. (2004). Slobodno vrijeme i sport. U: Bartoluci, M. (ur.) *Menedžment u sportu i turizmu*, str. 58-69. Zagreb: Kineziološki fakultet, Ekonomski fakultet.
16. Županov, J. (1995). *Poslije potopa*. Zagreb: Nakladni zavod Globus.

## THE EFFECT OF THE BASIC PSYCHOLOGICAL NEEDS ON SELF-CONFIDENCE OF UNIVERSITY STUDENTS

Ersin Eskiler, İhsan Sarı and Fikret Soyer

*Sakarya University, School Of Physical Education and Sport, Sakarya, Turkey*

### Abstract

This study aims to find out whether satisfaction of the basic psychological needs (need for autonomy, need for competence and need for relatedness) contributes self-confidence. 232 participants consisting of 136 males (%58,6) and 96 females (%41,4) participated to the study. Participants were chosen from the students of a state university in Turkey. Self-confidence Scale and the Basic Psychological Need Scale were used for data collection. Pearson's correlation analysis revealed a negative significant correlation between self-confidence and need for autonomy; self-confidence and need for competence; self-confidence and need for relatedness ( $p < 0,00$ ); need for competence and need for relatedness ( $p < 0,05$ ). Need for autonomy and need for relatedness significantly explained almost 35 % of the total variance in self-confidence ( $F=60,28$ ;  $p < 0.00$ ). Results suggest that satisfaction of the basic psychological needs enhances self-confidence of university students.

**Key words:** *the basic psychological needs, self-confidence, university students*

## THE RELATIONSHIP BETWEEN MOTOR VARIABLES ASSESSING EXCITATION, TONUS AND SYNERGISTIC REGULATORY MECHANISMS AND THOSE ASSESSING MENTAL POTENTIAL OF HANDBALL, VOLLEYBALL AND BASKETBALL PLAYERS

Franja Fratrić<sup>1</sup>, Snežana Vujanović<sup>2</sup>, Dragana Golik-Perić<sup>2</sup>, Vojin Jovančević<sup>2</sup>, Nenad Sudarov<sup>2</sup>, Damjan Jakšić<sup>3</sup> and Branko Đukić<sup>2</sup>

<sup>1</sup>The University of EDUCONS, Novi Sad, Serbia

<sup>2</sup>Provincial Institute for Sport, Novi Sad, Serbia

<sup>3</sup>Faculty of Sport and Physical Education, Novi Sad, Serbia

### Abstract

It has long been established that mechanisms for the regulation of psychomotor activities (mental characteristics and motor abilities) in athletes are closely related to one another. The mechanism for energy regulation is made up of two latent dimensions: the mechanism regulating the intensity of excitation, and the one regulating its duration. The mechanism for the regulation of movement is also made up of two latent dimensions: the mechanism for synergistic and tonus regulation, and the one organising the structure of movement. Motor functioning depends on the functioning of both regulatory mechanisms, but also on the functions of cognitive processors. In this study, we looked at the relationship between the already mentioned mechanisms and variables assessing mental potential. Following the testing of mental abilities, and observing various situations in competitions, it was concluded that functions of regulators of movement in CNS are intertwined with mental functions, which greatly determine the efficacy of motor behaviour. In other words, the better the function of movement regulators, the better mental function is, where total number of errors, as well as lost time, are both decreased in tests for the assessment of certain mental functions. All measurements were taken at the diagnostic centre of the Provincial Institute for Sport in Novi Sad.

The aim of this study was to determine the quality and relevance of the relationship between the chosen motor variables for the assessment of mechanisms for synergistic, tonus and excitation regulation, and the variables from a mental potential test battery in 13 basketball, 11 volleyball and 11 handball players.

**Key words:** *mental potential, motor abilities, regulatory motor mechanisms, athletes*

## GAME PLAYING AS A “CHALLENGE”: FROM PHILOSOPHICAL DILEMMAS TO PEDAGOGICAL IDEAS

Felix Lebed

*Kaye Academic College of Education, Beer-Sheva, Israel*

### Abstract

The purpose of the study was to suggest pedagogical approaches to the study and teaching of games based on the philosophical resemblances and distinctions between “play”, “game”, and “sport”.

In many sources, the philosophical comprehension of play is usually focused on two dilemmas. The first dilemma proposes an “activity – stance” dichotomy of the nature of playing. The second pertains to an “autotelicity – instrumentality” dichotomy of play. The discussion necessarily involves a division of playing into three forms: (1) free playing, (2) game playing, and (3) sport playing. The philosophical analysis in the paper offers a possible model of a singular situation in which game playing is possible as both a special skillful activity and an amusing psychological stance. Such a situation can be considered a “challenge” and interpreted as playing that implies the possibility of both success and failure. Pedagogical development of the notion of “challenge” leads to at least two methodological suggestions. The first suggestion can be connected to a “complexity” vision of game playing, which opens a new angle of study of complex systems acting in games. The second methodological idea emphasizes teaching games in three consecutive stages in keeping with the three different levels of the “challenge”. Each step would increase the difficulty level and involve increasingly more types of student motivation. These are the stages: (1) a “play stage” based on amusement motivation only, where the “challenge” emerges from participating in preparatory games performed without the required skills for real games; (2) a “game stage”, based on the previous motivation and a new motive: winning and increasing personal status, where the “challenge” is developing mastery that translates into a competitive advantage; (3) a “sports stage” based on the two previous motivational stages as well as a new motive – to be a sports star. The main “challenge” of the “sports stage” is to justify one’s self- and social- expectations.

## THE RELATIONSHIP BETWEEN LIFE SATISFACTION, SELF-ESTEEM AND GENERAL SELF-EFFICACY OF UNIVERSITY STUDENTS

İhsan Sarı, Fikret Soyer and Ersin Eskiler

*Sakarya University, School of Physical Education and Sport, Sakarya, Turkey*

### Abstract

The aim of this research is to find the relationship between self-efficacy, self-esteem and life satisfaction in university students. It was also aimed in this study to discover whether self-efficacy, self-esteem and life satisfaction differ according to some demographic characteristics. 157 participants participated to the study. T-test analysis revealed that there was not any significant difference of general self-efficacy, life satisfaction and self-esteem of participants according to gender and status of doing sportive activities. A positive significant correlation was found among all the three variables. Findings suggest that self-efficacy, self-esteem and life satisfaction are significantly related to each other. The results were discussed in line with the relevant literature.

**Key words:** *life satisfaction, self-esteem, self-efficacy*



**6<sup>th</sup> INTERNATIONAL  
SCIENTIFIC  
CONFERENCE ON  
KINESIOLOGY**

**“INTEGRATIVE POWER OF  
KINESIOLOGY”**



# **Kinesiology in Physical Conditioning**

**Editor:  
Prof. Igor Jukić, PhD**

**Peer Reviewers:  
Prof. Igor Jukić, PhD  
Prof. Asim Bradić, PhD  
Luka Milanović, PhD  
Sanja Šalaj, PhD  
Daniel Bok, MagKin  
Cvita Gregov, MagKin**

**Secretary:  
Cvita Gregov, MagKin**

## POWER PRODUCTION DURING SETS OF RESISTANCE EXERCISES ON STABLE AND UNSTABLE SURFACE

Erika Zemková and Dušan Hamar

*Department of Sports Kinanthropology, Faculty of Physical Education and Sport, Comenius University, Bratislava, Slovakia*

### Abstract

The study compares the power output during six sets of resistance exercises on stable and unstable surface. A group of 14 physical education students performed randomly in different days 6 sets of 8 reps of a) barbell chest presses on the bench and Swiss ball, respectively, and b) barbell squats on the stable surface and Bosu ball (all of them with 70% 1RM). A PC based system FiTRO Dyne Premium was used to monitor the power in concentric phase of lifting. Results showed that power produced throughout sets decreased more profoundly during chest presses and squats on unstable surface (19.9% and 11.4%, respectively) than on stable support base (11.8% and 9.6%, respectively). It may be concluded that power outputs during sets of resistance exercises is more profoundly compromised under unstable than stable conditions.

**Key words:** chest presses, instability, power output, squats

### Introduction

Recently, resistance exercises performed on unstable surface has become a part of athletic training and rehabilitation. Accordingly, their role in performance and health started to be a matter of interest among conditioning specialists and researchers.

It has been demonstrated lower values of force (approximately 6%), velocity and power (approximately 10%) when chest presses were performed on unstable surface (Koshida et al., 2008). Also our experiments showed significantly lower power in concentric phase of resistance exercises performed on unstable than stable surface (Zemková, & Hamar, 2010/a). This indicates that unstable support base compromises power output in concentric phase of lifting. Such an effect is more evident during barbell chest presses on Swiss ball than during barbell squats on Bosu ball (Zemková, & Hamar, 2010/b), which may be attributed not only to the type of exercise but also the instability of devices used.

Other variables, such as number of repetitions and sets, have to be also taken in account. Our recent experiments showed faster drop of power during a set of resistance exercises performed on unstable than stable surface. This finding implies for importance of monitoring power under the conditions similar to the one used during the training. In such a way the number of repetitions close to the maximal power may be estimated. However, there is no information on power output produced during typical sets applied in resistance training. Therefore, the aim of the study was to compare the power production during six sets of resistance exercises on stable and unstable surface.

### Methods

A group of 14 physical education students (age  $22.9 \pm 1.8$  y, height  $178.4 \pm 8.8$  cm, and weight  $78.8 \pm 9.5$  kg) volunteered to participate in the study. All of them had experience with resistance training involving exercises such as chest presses and squats among many others. However, they had no experience with instability resistance exercises. They were asked to avoid any strenuous exercises during the study. All participants were informed on the procedures and on the main purpose of the study. The procedures presented were in accordance with the ethical standards on human experimentation.

Prior to the study, subjects were exposed to a familiarization session, during which the techniques of both exercises, in particularly on unstable surfaces, were explained. Emphasis was placed on achieving a knee angle of  $90^\circ$  during squats and on the same cadence of movement during both exercises. Exercises were performed with countermovement (CM) using maximal effort in concentric phase.

Afterwards they performed randomly in different days 6 sets of 8 reps of a) barbell chest presses on the bench and Swiss ball, respectively, and b) barbell squats on the stable support and Bosu ball (all of them with 70% 1RM). Rest interval of 2 minutes was applied between particular sets.

The barbell chest presses were performed in the supine position with placement of the Swiss ball in the thoracic area and with the feet placed on the floor. This provided a wider base of support than squats performed in standing position

on Bosu ball. Squats were performed from full extension to a knee angle of 90° while holding a barbell on the back. Laboratory assistant stood behind the subjects to impede a possible fall.

A PC based system FiTRO Dyne Premium based on precise analogue velocity sensor with sampling rate of 100 Hz was used to monitor biomechanical parameters involved in lifting exercises ([www.fitronic.sk](http://www.fitronic.sk)). Force is calculated as a product of mass moved and the sum of an instant acceleration and gravitational constant. The acceleration is obtained by derivation of velocity, registered by rotating analogue sensor coupled with the barbell by means of nylon tether. Power is calculated as a product of force and velocity. The device was placed on the floor and anchored to the bar by nylon tether. Subjects performed exercises while pulling a nylon tether of the device (Figure 1).

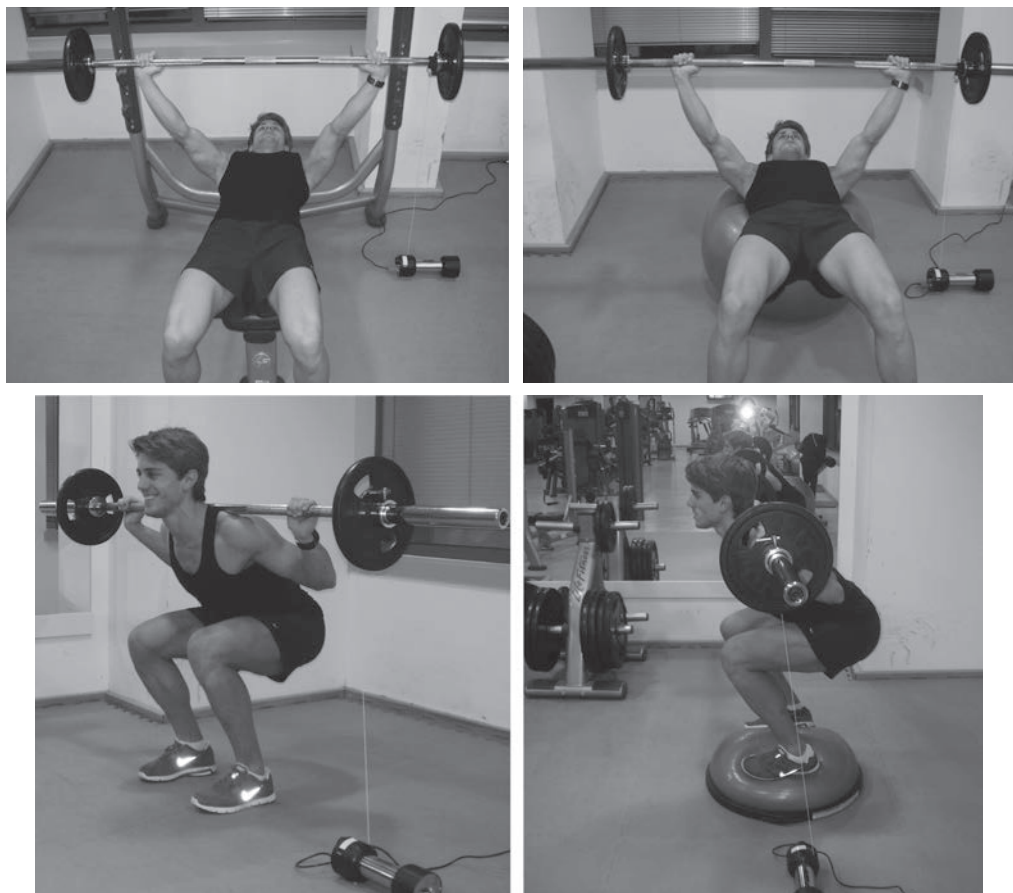

Figure 1. Measurement of strength parameters during barbell chest presses and squats performed on stable and unstable surface, respectively

Ordinary statistical methods including average and standard deviation were used. A paired t-test was employed to determine the statistical significance of differences between power output during resistance exercises on stable and unstable surface,  $p < 0.05$  was considered significant.

## Results

Results showed that mean power in concentric phase of lifting decreased more profoundly during chest presses on Swiss ball than on the bench, namely in final two sets (from  $394.7 \pm 23.3$  W to  $316.3 \pm 28.1$  W and from  $437.4 \pm 32.2$  W to  $385.7 \pm 24.9$  W, respectively) (Figure 2). This may be corroborated by greater reduction rates of power during unstable than stable chest presses (19.9% and 11.8%, respectively).

On the other hand, the power declined similarly throughout sets of squats on Bosu ball and on the stable surface (from  $418.7 \pm 37.4$  W to  $371.1 \pm 32.8$  W and from  $500.1 \pm 44.1$  W to  $452.1 \pm 38.6$  W, respectively) (Figure 3). This may be documented by only slightly higher fatigue index during unstable than stable squats (11.4% and 9.6%, respectively).



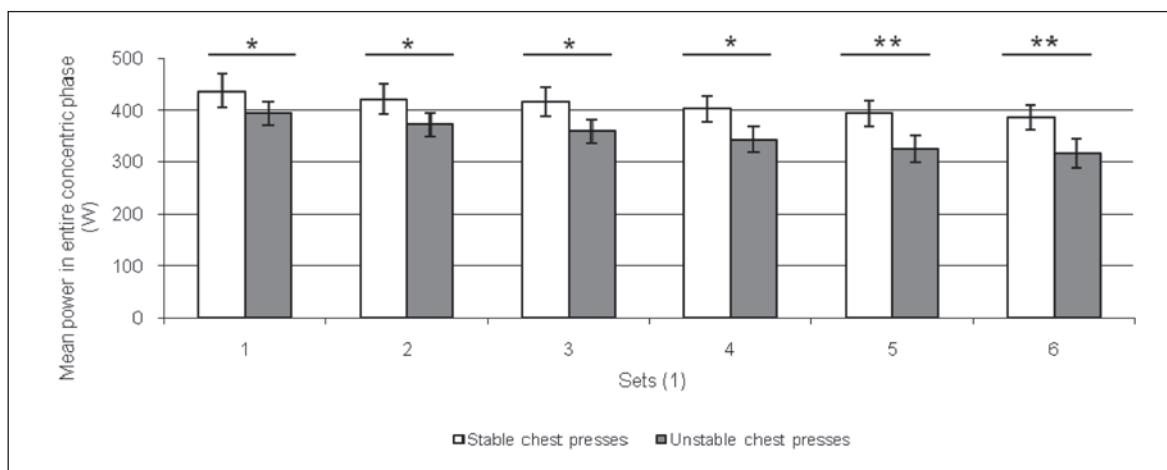

Figure 2. Mean power in concentric phase of chest presses performed with countermovement on the bench and Swiss ball, respectively

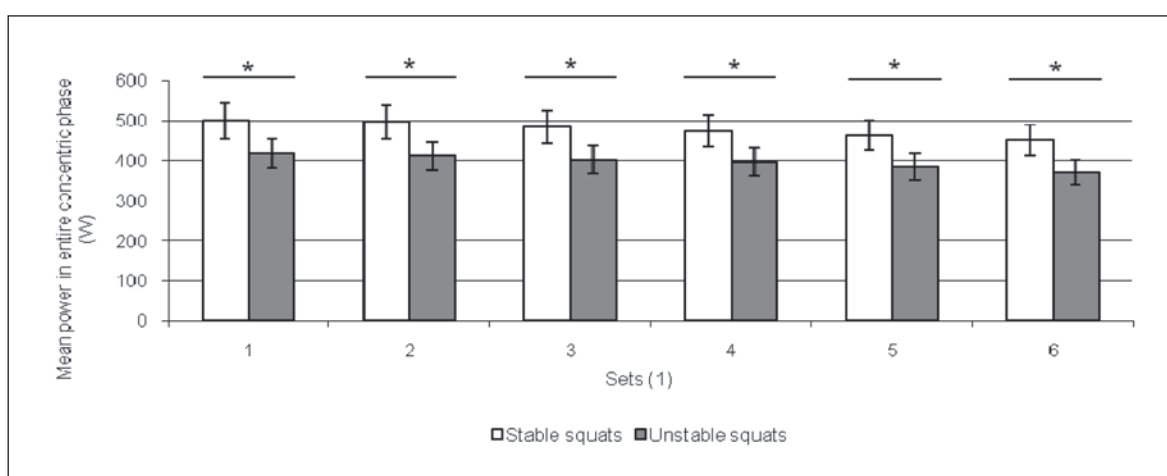

Figure 3. Mean power in concentric phase of squats performed with countermovement on stable surface and Bosu ball, respectively

## Discussion and conclusions

Power output decreased during sets of resistance exercises more profoundly under unstable than stable conditions. This may be corroborated by higher fatigue index during chest presses on Swiss ball than on the bench (19.9% and 11.8%) and during squats on Bosu ball than on the stable surface (11.4% and 9.6%). From figure above is evident that power fails mainly in final two sets of instability chest presses.

It may be assumed that Swiss ball imposed greater degree of instability resulting in higher difficulty of the task. This may be documented by significantly greater electromyographic (EMG) activity of trunk-stabilizing muscles during dumbbell chest press on unstable than stable surface (Marshall, & Murphy, 2006). The high muscle activation during exercises performed under unstable conditions can be attributed to their increased stabilization function. This is due to additional stresses imposed on the synergistic and stabilizing muscles of the trunk during chest presses on Swiss ball placed in the upper thoracic area with the feet placed on the floor (Behm, & Anderson, 2006). This additional task presumably induced greater fatigue of neuromuscular system than the same exercise on stable surface.

It is known that fatigue-induced decrease in power production during exercise involving countermovement has more pronounced influence on concentric phase of stretch-shortening cycle (SSC). The mechanism of power production using SSC employs the energy storage capabilities of series of elastic component and the stimulation of stretch reflex to facilitate the muscle contraction over a minimal amount of time. However, when resistance exercises are performed on unstable surface, lower amount of energy is accumulated in elastic tissues of muscles and tendons involved and consequently can be utilized for subsequent concentric contraction. This is mainly due to delayed and prolonged amortization phase of SSC. Around the turning point, where the eccentric phase changes into the concentric one, maximal force is produced. At the same time subject must stabilize torso on unstable surface in order to provide firm support for contracting muscles. This additional task may compromise the contraction of muscles acting on the barbell. Their less intensive contraction

not only prolongs the change of movement direction, but because of lower peak force, negatively impairs accumulation of elastic energy. Consequence is lower velocity and power in concentric phase of lifting.

Greater decline of power production was also observed during squats on Bosu ball than on stable support base. Under such conditions, subjects must stabilize body during the movement, namely at the transition from eccentric to concentric phase. This is an additional task requiring greater co-contractile activity of trunk-stabilizing muscles. There is a significantly higher EMG activity of abdominal stabilizers, upper lumbar erector spinae, and lumbo-sacral erector spinae muscles during squats on unstable than stable surface (Anderson, & Behm, 2005). Increased EMG activity in the soleus during instability squats indicates also greater demand on postural muscles. However, muscles used to aid in joint stability can contribute significantly to EMG signals without altering measurable force. This may partly explain only slight differences in rate of power reduction during squats on stable and unstable surface.

These findings are in accordance with previous studies (e.g., Zemková, & Hamar, 2010/b) documenting that power production during resistance exercises on unstable surface depends not only on its type but also on the degree of instability of devices used. Chest presses on Swiss ball most likely provided greater challenges to neuromuscular system as compared to squats on moderately unstable Bosu ball. As a result was more profound decrease of power production throughout sets of chest presses on unstable than stable surface. This fact has to be taken into account in the assessment of individual's performance because significant inter-individual differences were observed toward the end of more exhaustive sets under unstable conditions. This may be attributed not only to their strength capabilities but also the ability to tolerate fatigue and perform exercises with maximal effort in concentric phase of lifting. From practical point of view it underlines the importance of monitoring the power produced during sport-specific task (e.g. instability resistance exercises). Only such an assessment can provide reliable information necessary for design of efficient training program.

Power output decreases more profoundly during sets of resistance exercises on unstable than stable surface. This effect is more evident during chest presses on Swiss ball than during squats on Bosu ball, namely towards final sets. This fact has to be taken into account when instability resistance exercises are implemented into the training programs designed to improve explosive power. In sports involving high-velocity, movements workouts should be tailored with respect to avoid high fatigue of neuromuscular system, which can be greater during instability than traditional resistance exercises.

## References

1. Anderson, K., & Behm, D. G. (2005). Trunk muscle activity increases with unstable squat movements *Can J Appl Physiol*, 30, 33-45.
2. Behm, D. G., & Anderson K. (2006). The role of instability with resistance training. *J Strength Cond Res*, 20, 716-722.
3. Koshida, S., Urabe, Y., Miyashita, K., Iwai, K., & Kagimori, A. (2008). Muscular outputs during dynamic bench press under stable versus unstable conditions. *J Strength Cond Res*, 22(5), 1584-1588.
4. Marshall, P. W., & Murphy, B. A. (2006). Increased deltoid and abdominal muscle activity during Swiss ball bench press. *J Strength Cond Res*, 20, 745-750.
5. Zemková, E., & Hamar, D. (2010/a). Unstable support base compromises power output in concentric phase of resistance exercise. *7<sup>th</sup> International Conference on Strength Training*. Bratislava: Faculty of Physical Education and Sport, 243-244.
6. Zemková, E., & Hamar, D. (2010/b). Muscular power during chest presses and squats performed on stable and unstable surface. *1<sup>st</sup> Wingate Congress of Exercise and Sport Sciences*. Israel: The Zinman College of Physical Education and Sport Sciences and the Wingate Institute for Physical Education and Sport, 95-96.

## Acknowledgements

This project was supported by a Slovak Research and Development Agency (No. SK-SRB-0023-09)

## ADAPTATION EFFECTS OF EXPLOSIVE WEIGHT TRAINING WITH VS. WITHOUT COUNTERMOVEMENT

**Tomáš Michalík and Marián Vanderka**

*Department of Athletics, Faculty of Physical Education and Sport, Comenius University, Bratislava, Slovakia*

### Abstract

The purpose of this study was to compare the effects of explosive concentric strength training with and without counter movement on strength parameters such as power, RFD and 1RM. 30 university students age 22,1±2,5 year, weight 78,3±16,1 kg, height 178,2±12,2 cm, different previous experiences with strength training participated on training study. The subject had been randomly assigned to two groups. They did not significantly differ in 1RM and peak power (Pmax) by input testing. Experimental design: both groups trained 2 times per week for 11 week. They performed basic exercises for the upper body (bench-press) in the first week 3 times 6 repetition each with the weight 50% of 1RM with 2 min. rest between the sets. The progression during the next weeks was by increasing weight (5%) and on the next weeks one more set has done. They reach maximal load in the eighth week 6 times 6 reps with weight 70% of 1RM. There was only one difference in the training of two groups, group 1 (n=14) (PR) performed repetitions with rebound or counter-movement, group 2 (n=16) (ST) performed repetitions without rebound (with 2 second stop in the lowest position). Prior to and after training period 1RM, maximal power in concentric phase (Pmax) using the maximal effort single reps with increasing weights (Hamar, 2008) were carried out. The rate of force development (RFD) was also evaluated in isometric contraction (90 degrees in elbow). Statistics analysis was used to determine significant differences between the means by rank method double sided Mann-Whitney and Wilcoxon t-test. Maximal strength improved in both group significantly (p<0.05). One-off repetition maximum PR increases of 6,5±5,4 kg (8,2%), ST an about 6,7±5,0kg (7,3%). Mean peak power enhancement in PR1 group was by not significant of 2,3%, in ST it was significant (p<0.05) of 28,9±42,1 W (6,4%). In comparison of these increases there was between group significant difference (p<0.01). Mean rate of force development (RFD) was the parameter that was mostly influenced by concentric explosive type of strength training. Only in one parameter was proved hypothesis about substantial affect of training with counter-movement in comparison with without counter-movement training on RFD increases. It was found significant difference between increases across mean RFD 100 ms (p<0.05). From a practical perspective, if previous training is focused on hypertrophy and maximal strength, forewent the explosive strength training leads to higher subsequent increases in speed - power capacity.

**Key words:** *development of strength abilities, power, rate of force development, counter movement, adaptation*

### Introduction

The fast movements such as sprint running, jumping, karate, or boxing typically involve contraction times of 50 – 250 ms. For this reason athletes concentrate on the improvement of the capability to generate force in within the early phase of muscle contraction. On of the typical program used for this purpose includes the counter-movement exercise. Thus, there are some evidences that counter-movement exercises are utilizing the elastic properties of the muscle tendon complex and the reflexes and it results in greater force and power output in concentric phase of muscle contraction (Bosco et al., 1982; Cronin et al., 2001; Häkkinen et al., 1986; Tihanyi, 2006). Therefore, the purpose of this study was to compare the effects of explosive concentric strength training with and without counter movement on strength parameters such as power, RFD and 1RM.

To test the hypothesis whether the strength exercise program consisting of sets performed with higher intensity in concentric phase due to counter movement would yield a different training outcome that the program based on lifting performed also with maximal effort, however without potentiation of power output in concentric phase by counter movement.

### Methods

Subjects: 30 university students age 22,1±2,5 year, weight 78,3±16,1 kg, height 178,2±12,2 cm, different previous experiences with strength training participated on training study. The subject had been randomly assigned to two groups. They did not significantly differ in 1RM and peak power (Pmax) by input testing. Experimental design: both groups trained 2 times per week for 11 week. They performed bench press exercise in the first week 3 times 6 repetition each with the weight 50% of 1RM with 2 min. rest between the sets. The progression during the next weeks was by increasing

weight (5%) and on the next weeks one more set has done. They reach maximal load in the eighth week 6 times 6 reps with weight 70% of 1RM. There was only one difference in the training of two groups, group 1 (n=14) (G1) performed repetitions with rebound or counter-movement, group 2 (n=16) (G2) performed repetitions without rebound (with 2 second stop in the lowest position). Prior to and after training period 1RM, maximal power in concentric phase ( $P_{max}$ ) using the maximal effort single reps with increasing weights (Hamar, 2008) were carried out. The rate of force development (RFD) was also evaluated in isometric contraction (90 degrees in elbow and knee angle respectively). Statistics analysis was used to determine significant differences between the means by rank method double sided Mann-Whitney and Wilcoxon t-test.

## Results

Maximal strength improved in both group significantly ( $p < 0.05$ ). One-off repetition maximum (1RM) G1 increases of  $6,5 \pm 5,4$  kg (8,2%). G2 group an about  $6,7 \pm 5,0$ kg (7,3%). Mean peak power enhancement in G1 group was not significant of 2,3 %, in G2 it was significant ( $p < 0.05$ ) of  $28,9 \pm 42,1$  W (6,4%) (Fig. 1). In comparison of these increases there was between group significant difference ( $p < 0.01$ ). Mean rate of force development (RFD) was the parameter that was mostly influenced by concentric explosive type of strength training. There were significant increases of RFD almost in the first 50 ms in both groups ( $p < 0.01$ ). In G1 group RFD 50 ms was increased of  $3,29 \pm 2,5$  (95,5%) from the value of 3,44 to  $6,73$   $N \cdot m \cdot s^{-1}$ . Group G2 increased of  $3,43 \pm 3,09$  (78,4%) from 4,38 to  $7,81$   $N \cdot m \cdot s^{-1}$ . Only in one parameter proved hypothesis about substantial affect of training with counter-movement in comparison with without counter-movement training on RFD increases. It was found significant difference between increases across mean RFD 100 ms ( $p < 0.05$ ) (Fig. 2). G1 improved in this parameter an about  $3,38 \pm 1,58$  (80,1%) and G2 only of  $1,26 \pm 0,49$   $N \cdot m \cdot s^{-1}$  (38,4%).

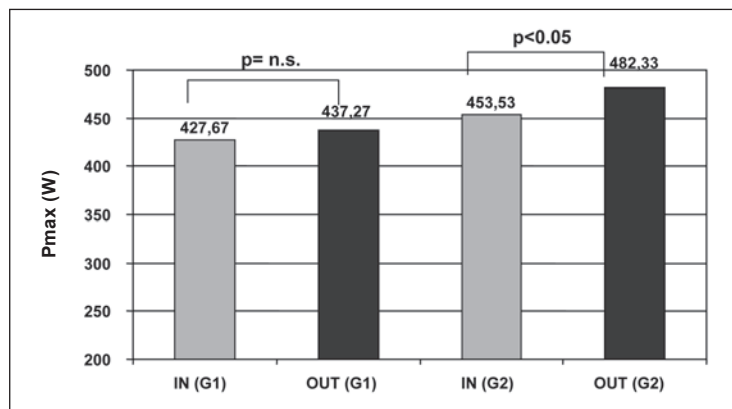

Figure 1. Bench press mean peak power (W) output before (IN) and after (OUT) 11 weeks training period; (G1) trained with counter-movement, (G2) trained without counter-movement

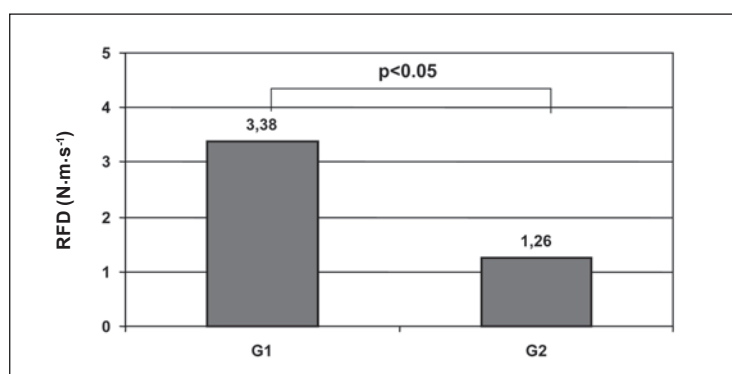

Figure 2. Bench press mean increases of RFD ( $N \cdot m \cdot s^{-1}$ ) in the first 100 ms; (G1) trained with counter-movement, (G2) trained without counter-movement

## Discussion and conclusions

Conflicting results were found in this research with respect to the influence of these two training protocols on power production and RFD. The assumption that the rebound (counter-movement) weight exercise has more significant impact to these parameters was partly confirmed when compared with only concentric training. The loss of larger differences between groups could be attributed to the dissipation of elastic energy or the inability of the muscle to generate force at higher weight according to the force-velocity relationship of muscle. If power is the product of strength and speed, the heavier loading proposed by this research would seem a better option for inducing hypertrophic as well as SSC adaptation. This corresponds with traditional assumption that strength is more trainable than speed. There were also intra-individual differences in adaptation. Subjects with longer experience with the slow “bodybuilding” strength training showed more significant gains in RFD and Pmax as compared to mostly speed and power trained or untrained subjects. Furthermore, the relatively short duration and volume of the intervention two times per week for 11 weeks may not be sufficient for significant increases in Pmax, which appears to be very stable and less trainable.

A significant enhancement was found by explosive weight training of both groups in maximal strength, whereas was not at all in maximal power. The main effect of the counter-movement exercise weight training was to produce greater RFD especially in the first 100 ms of isometric contraction. From a practical perspective, if previous training is focused on hypertrophy and maximal strength, forewent the explosive strength training leads to higher subsequent increases in speed - power capacity.

## References

1. Bosco, C., Viitasalo, J.T., Komi, P.V., Luthanen, P. (1982). Combined effect of elastic energy and myoelectrical potentiation during stretch-shortening cycle exercise. *Acta physiol. Scand.*, 114, pp. 74-83.
2. Cronin, J., McNair, P.j., and Marshall, R.N. (2001). Developing explosive power: A comparison of technique and training. *Journal of Science and Medicine in Sport* 4, (I): 59-70.
3. Häkkinen, K., Komi, P.V., Kauhanen, H. (1986). Electromyographic and force production characteristics of leg extensor muscles of elite weight lifters during isometric, concentric, and various stretch-shortening cycle exercises. *International journal of sportsmedicine*. Vol. 7, No. 3, pp. 144-151.
4. Hamar, D. (2008) Monitoring of power in the weight room. In: 6<sup>th</sup> International Conference on Strength Training, Colorado Springs, pp. 355-359.
5. Tihanyi, J. (2006). A mechanikem vibráció. *Fitnessz és Turkmány*, 2, No. 1, pp. 24-27.

## EFFECT OF FATIGUE ON COORDINATION AND SKILL-RELATED PERFORMANCE IN TEAM SPORTS\*

Igor Jukić<sup>1</sup>, Daniel Bok<sup>1</sup>, Luka Milanović<sup>1</sup> and Tamara Despot<sup>2</sup>

<sup>1</sup>Faculty of Kinesiology, University of Zagreb, Croatia

<sup>2</sup>Football Club Dinamo, Zagreb, Croatia

### Abstract

Numbers of studies with time motion analyses have shown that player's physical performance is decreasing during competitive match as a result of fatigue development. Decrements in physical performance have been documented in variety of physiological parameters as well as in the parameters of situational efficiency. In most team sports the heart rate and blood lactate concentrations decrease throughout the match, while players perform less high-intensity running and sprinting in the second periods of a game. As physical performance decrements during the game have been well documented and confirmed, the aroused question was would the onset of fatigue also trigger decrements in the proficiency of skill-related performance. Factors which contribute to decrements in technical performance under fatigued conditions as well as mechanisms which underlie such decrements were also in the focus of interest for number of investigators. This paper is aimed to review current scientific literature engaged in investigating the changes in technical and skill-related performance due to muscular fatigue.

**Key words:** *physical performance, proficiency, co-ordination, technical performance*

### Introduction

Specific co-ordination is defined as a motor ability responsible for successful performance of specific movements or sports techniques and it is especially utilized and important for sports comprised of a large number of different techniques (Metiškoš, Milanović, Prot, Jukić, & Marković, 2003). High level of the athlete's specific co-ordination can be perceptible in the proficiency and the execution frequency of skill-related performances. Team sports belong to the group of complex activities which are comprised of a large number of different and complex movements. As team sports are considered as *intermittent sports* in which specific and complex movements must be performed frequently, it is very important for an athlete to be able to perform all of those complex movements with the same intensity throughout the entire game. Notation analyses in of different sport games revealed that a soccer player performs 1500 different movements or techniques during the soccer match and basketball player performs around 1000 movement during the basketball match. All those movements and techniques must be performed proficiently, precisely and efficiently throughout the entire game and the quality of those movements should not be influenced by fatigue. The purpose of this paper is to review current scientific literature engaged in investigating the effect of fatigue on co-ordination and skill-related performance in team sports.

### Effects of match-related fatigue on skill-related performance

Rampinini et al. (2009) analysed technical performance during 416 Italian Serie A soccer matches and documented decrements in physical (distance covered) and in technical performance (involvements with the ball, number of short passes, number of successful short passes) throughout the game, all due to accumulated fatigue. It was concluded that the difference between the most successful and less successful teams of the Serie A soccer league is actually emphasised in the technical performance variables in which the biggest decrements during the match were registered. In other words, if we want to have more successful team in terms of a higher position on the rank, decrements in technical performance due to fatigue should be reduced to minimum.

Rampinini et al. (2008) have also documented decrements in short-passing ability (accuracy, total time of *Loughborough Soccer Passing Test* (LSPT) performance, total time of LSPT performance with penalties) due to accumulated and temporary (caused by high-intensity match phases of relative short duration) fatigue. They have also documented 43% and 62% decrements in short passing ability after first and second half of a soccer game, respectively. Furthermore, decrements in

---

\* This research was supported, in part, by grant no. 034-0342610-2609 (Programming of transformational procedures for physical conditioning) from Croatian Ministry of science, education and sport.

short passing ability were detected after 5 minutes high intensity activities as well and it was thus concluded, that both accumulated and temporary fatigue are producing declines in technical performance of soccer players. The mechanisms responsible for technical decrements are probably the same ones causing decrements in physical performance: dehydration, hyperthermia, glycogen depletion, potassium accumulation in the muscles; but could also be caused by some factors not directly related to decrements in physical performance such as impairment of central nervous system and cognitive functions. Besides the above mentioned factors, this investigation confirmed that the physical fitness level also plays a major role in maintaining the high level of skill-related and technical performance. Namely, physically superior players fell less fatigued during the game played with the same intensity and, therefore, those players experience less decrement in technical performance.

Carling and Dupont (2011) reported, somewhat, different results compared to Rampinini et al., (2008, 2009) as they found no statistical decrements in technical performances (number of passes, successful passes percentage, ball possession, possessions gained, possessions lost, touches per possession, duels and percentage of duels won) throughout the 15-minute game periods, even though decrements in physical performance between first and the last two 15-minute game intervals were registered. However, analysis of 5-minute game periods revealed statistical difference in both, physical and technical performances. The authors concluded that technically and physically superior subjects sample is probably the main reason why such discrepancies, compared to the studies of Rampinini et al., (2008, 2009), were documented. Carling and Dupont (2011) also reported slight, non-significant, decrement in physical performance (high-intensity running), but no decrements in technical performances across three consecutive soccer games played within a period of 7 days. It was concluded that 3 consecutive games played within the period of 7 days do not have negative influence on player's technical performance, moreover, such stimuli could produce beneficial effects as some technical parameters were improved throughout the games analysed.

### Effects of locally or globally induced fatigue on skill-related performance

Decrement in physical and technical performance due to accumulated or temporary fatigue have been well documented in studies with game-induced fatigue protocols. However, better insight into effects of fatigue on technical and skill-related performance could be reached through investigations in which local or global fatigue is induced with different moderate or high-intensity activities. Such investigations were conducted on soccer, basketball and water polo players.

Stone and Oliver (2009) documented significant decrements in technical performance (ball dribble and shooting and passing accuracy) following 45-minute soccer specific exercise protocol. This exercise protocol did not lead to decrements in physical performance (sprinting), and, therefore, the authors concluded that decrements in technical performance can occur already after first half of the soccer game and do not have to be caused by decrements in physical performance. The authors also emphasised utilization of the specific tests for assessment of the technical performance, which was different in comparison to other investigations in which situational parameters were used. Technical performance of specific tests is far more demanding and, therefore, decrements in such performance can occur earlier and without preceding physical performance decrement.

Lyons, Al-Nakeeb & Nevill (2006a) investigated the effect of local fatigue, induced with moderate and high-intensity activities, on technical performance of soccer players. Passing accuracy and proficiency, assessed with LSPT, was slightly improved following moderate activity, while decreased following high-intensity activity. The same team of investigators documented decrements in passing accuracy in top-level and novice basketball players following moderate and high-intensity local fatiguing protocol (Lyons, Al-Nakeeb & Nevill, 2006b). Predictably, the decrement in accuracy was higher with novice basketball players and it was especially noticeable after high-intensity fatiguing protocol.

Young et al., (2010) reported similar results on Australian football players. Namely, physically superior players managed to maintain their high-level of shooting accuracy while physically inferior players showed larger decrement. Additionally, more experienced players also had 16% more accurate shoot on goal compared to less experienced players.

The studies in which locally-induced fatigue was used to investigate changes in athlete's performance showed similar results as the studies in which game-related fatiguing process was used.

There are several mechanisms proposed as theoretical explanations for technical decrement following fatiguing process. Among others, the *Inverted-U Theory*, proposed by Yerkes and Dodson (1908), puts forward that variations in arousal would produce a change in attentional processes (Lyons et al., 2006b). This theory argues that when arousal is low the attention is focused on both relevant and irrelevant cues and, thus, performance remains poor (Lyons et al., 2006b). As arousal rises, the athlete's attention is focused on the relevant cues only and, therefore, the technical performance becomes optimal. When arousal increases above optimal level, as a result of fatigue caused by high-intensity activities, the attention will narrow and even relevant cues will get missed, so the performance deteriorates.

## Effects of fatigue on biomechanical parameters of skill-related performance

With the purpose of investigating the factors which influence technical performance under fatiguing conditions, a number of biomechanical studies were conducted. Kellis, Katis and Vrabas (2006) documented alternations in kinetic and kinematic parameters of soccer kick performance after fatigue and concluded that changes in the function of the neuromuscular system and force generation capacity can significantly influence technical performance. Forestier and Nougier (1998) also documented changes of movement stereotypes in precise multi-joint movements as a result of muscle fatigue. With fatigue, movement co-ordination is modified in order to maintain good motor performance in terms of spatial accuracy. Movement accuracy and perfection is maintained with co-activation of antagonist muscles, which compensate the lost strength and power in the agonistic group of muscles. During that process the movement stereotype as well as the perception of the movement execution may be dramatically changed.

## Training methods for improvement of technical performance under fatigued conditions

Effect of fatigue on skill-related and technical performance has been widely investigated in terms of determining the physiological, psychological and biomechanical factors responsible for technical performance decrements. As a sequence of those studies, several studies have tested different training methods for improvement of technical performance under fatigued conditions.

Gabbett (2008) registered high correlation of aerobic endurance, agility and power with performance of tackling technique in rugby and, therefore, proposed improvement of physical fitness status in order to reduce decrements in technical performance after fatigue. Impellizzeri et al. (2008) and Helgerud, Engen, Wisløff & Hoff (2001) also proposed aerobic endurance and specific endurance training for preventing decrements in technical performance of soccer players.

## Conclusions

Decrements in technical performance after fatigue have been documented in the number of studies conducted with different fatiguing protocols. It was also proved that physical, psychological and biomechanical factors are responsible for decrements in performance proficiency. Based on the results obtained in these investigations, some concrete proposals for training programmes can be made. As maintenance of technical proficiency during the entire game is essential for successful appearance in team sports, further studies addressing this issue from various aspects are needed in order to understand better the underlying mechanisms and to help in developing the preparation strategies for better coping with the demands of the game.

## References

1. Carling, C., & Dupont, G. (2011). Are declines in physical performance associated with a reduction in skill-related performance during professional soccer match-play? *Journal of Sports Sciences*, 29(1), 63-71.
2. Gabbett, T.J. (2008). Influence of fatigue on tackling technique in rugby league players. *Journal of Strength and Conditioning Research*, 22(2), 625-632.
3. Helgerud, J., Engen, L.C., Wisløff, U., & Hoff, J. (2001). Aerobic endurance training improves soccer performance. *Medicine and Science in Sports and Exercise*, 33(11), 1925-1931.
4. Impellizzeri, F.M., Rampinini, E., Maffiuletti, N.A., Castagna, C., Bizzini, M., & Wisløff, U. (2008). Effects of aerobic training on the exercise-induced decline in short-passing ability in junior soccer players. *Applied Physiology, Nutrition, and Metabolism*, 33, 1192-1198.
5. Kellis, E., Katis, A., & Vrabas, I.S. (2006). Effects of an intermittent exercise fatigue protocol on biomechanics of soccer kick performance. *Scandinavian Journal of Medicine and Science in Sports*, 16, 334-344.
6. Lyons, M., Al-Nakeeb, Y., & Nevill, A. (2006a). Performance of soccer passing skills under moderate and high-intensity localized muscle fatigue. *Journal of Strength and Conditioning Research*, 20(1), 197-202.
7. Lyons, M., Al-Nakeeb, Y., & Nevill, A. (2006b). The impact of moderate and high intensity total body fatigue on passing accuracy in expert and novice basketball players. *Journal of Sports Science and Medicine*, 5, 215-227.
8. Rampinini, E., Impellizzeri, F.M., Castagna, C., Azzalin, A., Bravo, D.F., & Wisløff, U. (2008). Effect of match-related fatigue on short-passing ability in young soccer players. *Physical Fitness and Performance*, 40(5), 934-942.
9. Rampinini, E., Impellizzeri, F.M., Castagna, C., Coutts, A.J., & Wisløff, U. (2009). Technical performance during soccer matches of the Italian Serie A league: effect of fatigue and competitive level. *Journal of Science and Medicine in Sport*, 12, 227-233.
10. Stone, K.J., & Oliver, J.L. (2009). The effect of 45 minutes of soccer-specific exercise on the performance of soccer skills. *International Journal of Sports Physiology and Performance*, 4, 163-175.
11. Young, W., Gulli, R., Rath, D., Russell, A., O'Brien, B., & Harvey, J. (2010). Acute effect of exercise on kicking accuracy in elite Australian football players. *Journal of Science and Medicine in Sport*, 13, 85-89.



## HEART RATE MONITORING DURING TESTING OF ENDURANCE ABILITIES IN FOOTBALL

**Martin Zvonar, Josef Maleček, Igor Duvač, Vladimír Psalman and Martin Sebera**

*Faculty of Sport Studies, Masaryk University, Brno, Czech Republic*

### Abstract

Training process in team sports, especially in football, requires suitable management of players. Having correct and precise information about internal physical reactions of players seems to be very useful since then coaches are able adjust sport loading individually. Modern monitoring device such as the Suunto Team POD is quite comfortable to wear and efficient, especially while training for football. The aim of this study was to measure special endurance abilities required for football by monitoring heart rate. Heart rate measurements were recorded using the Suunto Team Pack, which consists of sophisticated heart rate recorders and wireless transmitters. Training aim was to achieve a workload at 170 bpm and higher during each training stand and in each series. Duration of the whole test took from 7 to 8 minutes. The test began at the end of a training session and 2 km run were done by football player. There were different heart rates in the tested players. A heart rate monitoring device, such as the Suunto Team Pack, represents a useful system for onsite training management and is valid for the diagnostics of endurance abilities required in football.

**Key words:** *football, endurance abilities, heart rate monitoring, test validity*

### Introduction

Football training and matches are composed of many various details and suitable management of players is needed since having specific information concerning a player's status at the right time, may be the key to final success training or winning a match. Knowing more about internal reactions of players seems to be very helpful to coaches since this information allows them to adjust sport loading perfectly. The Suunto Team POD heart rate monitoring device is comfortable to wear and efficient, especially used in football training. Direct measurement of oxygen consumption during matches and training is almost impossible and that is why heart rate monitors are one of the favorite and most commonly used pieces of measurement equipment. The most often used heart rate monitoring systems are probably Polar Electro from Finland or Hosand TM 2000 but they have some disadvantages in on-site management (MORAVEC 2005). The first company to create a very sophisticated on-site device with software to provide immediate measurement feedback for play/training management was Suunto. Their device allows observation of more than 10 players at the same time and so that a coach can monitor levels of fatigue or even exhaustion in individual players.

Division of endurance abilities comes from general endurance as a basement and from specific endurance, which manifestation is influenced by concrete sport activity (e.g. long endurance – running over 1500m speed endurance – 400m, 800m running, strength endurance – kicks, explosive endurance – sprint running...). Endurance abilities depend on functional capability of the cardiovascular system, amount and quality of slow twitch red oxygen fibers, metabolic systems (ATP, CP, LA, O<sub>2</sub>, ...), and psychological resistance. An adequate level of endurance is conditioned by oxygen and nutrient status in working muscles, by clearance of metabolic exchange and by resistance against metabolic destruction. The main parameters are stroke volume, lungs ventilation per minute, diffusion capacity of lungs, transport blood capacity, and heart rate (KASA 2001).

Purpose of our research was to find individual heart rate values recorded by on-site diagnostic system, Suunto Team Pack, during specific endurance activities in football to verify validity of a test (running 2 km).

### Tasks

1. Selection of athletes
2. Selection and preparation of diagnostic equipment
3. Logical and statistical suggestions of individual heart rate in specific levels of loading intensity

## Methods

Training methods in football:

Warm up under 10 minutes

Preparation drill for bouncing passes+diamant – interval of performance - 3 minutes, rest 90 second, number of series - 2

Offensive game combinations (cycle), Interval of performance - 8min., number of series - 2

Scrimmage 5 on 5 with helping passers, (length of one game - 4 min., number of series - 4)

2 km run

*Diagnostic methods.* For the diagnostics of a endurance abilities test of running (2 km) was chosen. The testing participants consisted of ten professional football players in Slovak National League. Their ages were 20 to 25years old, with an average age of 22.4. Testing was organized during the winter of 2010-2011 in Trenčín, Slovak Republic. Heart rate monitoring and physiological processes were measured by the Suunto Team POD, which uses wireless data transfer up to 100 meter distance from the device and is very effective for team training.



Figure 1. Suunto Team POD device

Device in Figure 1 and its software allows measurement and analyses almost immediately of heart rate during sport loading during training or a match.

## Results

The device used for heart rate monitoring with its sophisticated software allowed regulating behavior of cardiovascular system and level of sport loading during a football match and training unit. We reason that based on heart rate measurements in sport competition we can divide loading into five bio-energy levels which represent a more precise and objective evaluation of sport loading (in Figure 3). The garnered results lead to extending the knowledge in the area of individual intensity evaluation during training and competition. Individual values of achieved heart rates during testing of specific endurance abilities are shown in Figure 2.

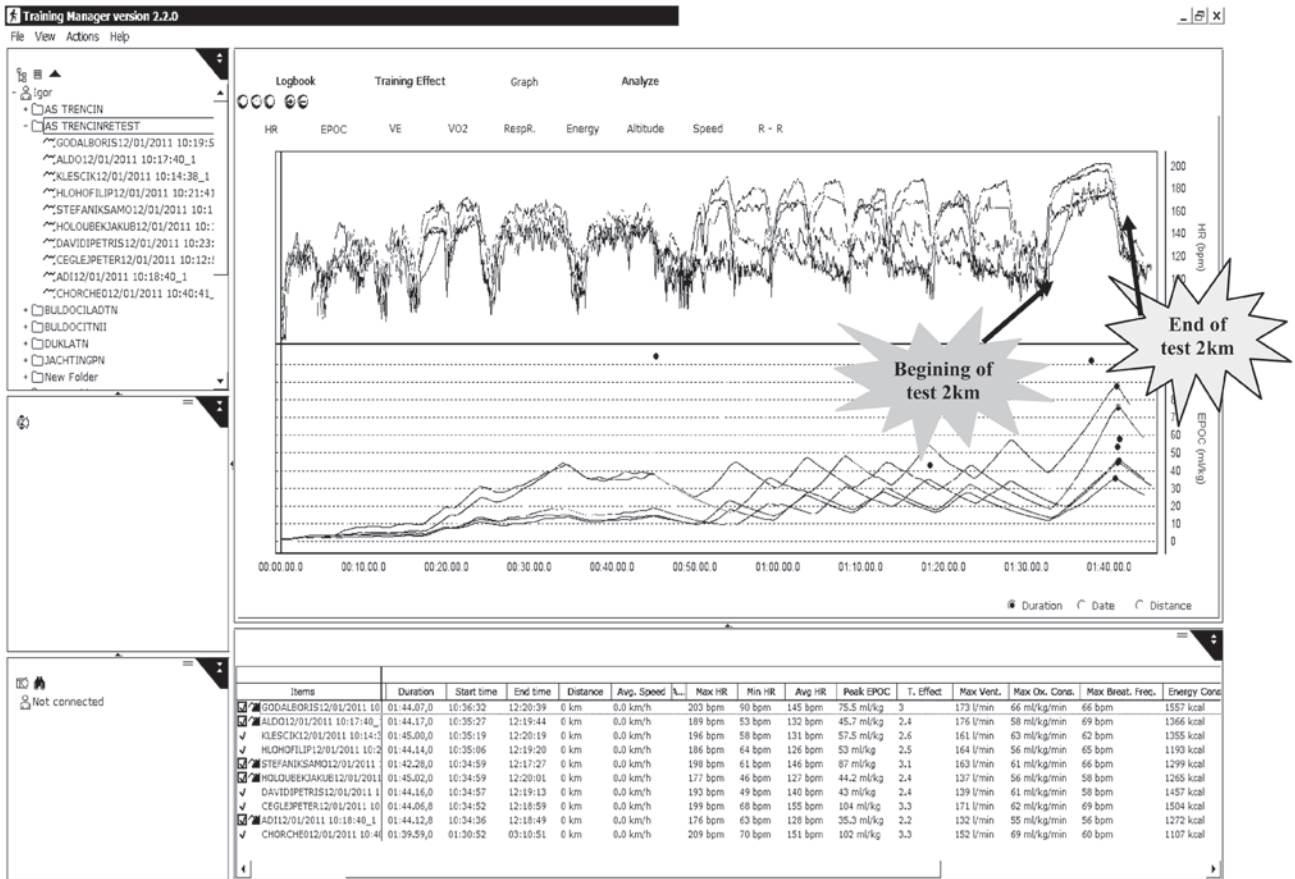

Figure 2. Heart rate monitoring during training 10 players

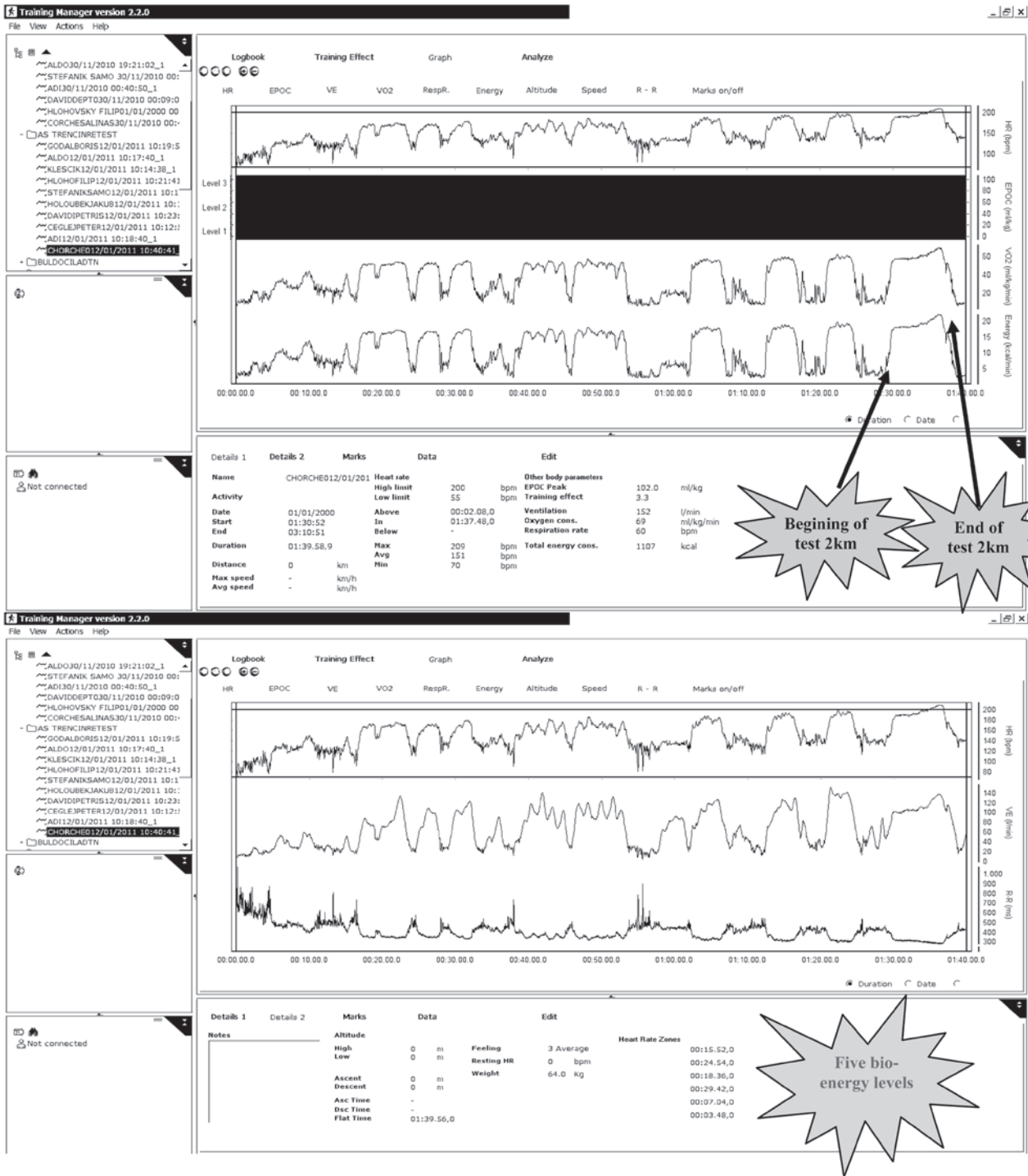

Figure 3. Example of five bio-energy levels of the best player in test

Because achieved heart rate values are very steady, aligned and test duration is more than seven minutes, we can evaluate this test as being valid (test has logical and formal validity) for diagnostics of specific endurance abilities in football. Level of maximal heart rates range between 165 and 205 bpm (depends on football player) is quite high for endurance activities but represents difficult and intensive sport loading. Establishing reliability of this test will be a goal of our future research.

## Conclusions

Achieved results are helpful and extend optimization of loading intensity during sport training and competition. We expect that this new specific test for football (2km) enriches the battery of tests for testing specific endurance abilities in football.

## References

1. Argaj, G. (2005). Analýza tréningového a herného zaťaženia vo vybraných športových hrách. In: Zborník vedeckých prác katedry hier. Bratislava: PEEM, 2005 s. 65-68.
2. Bös, K. (1987). Handbuch Sportmotorischer Tests. Göttingen – Toronto – Zurich, Verlag für Psychologie, 1987. 539 s.
3. Čelikovský, S. (1973). Pohybové schopnosti a jejich struktura jako užité hodnoty tělesných cvičení. Praha, Universita Karlova, 1973. 161 s.
4. Kasa, J. (2001). Športová kinantropológia. Terminologický a výkladový slovník. Bratislava, SVSTVŠ, FTVŠ UK, 2001. 112 s.
5. Steinhofner, D. (2003). Grundlagen des Athletiktrainings. Munster:Philippka-Sportverlag, 2003.
6. Tomajko, D. (2000). Efekty tréningového procesu ve sportovních hrách. In:Efekty pohybového zatížení v edukačním prostředí TV a Sportu. Olomouc: UP, 2000, s. 156-162.

## EFFECTS OF UNILATERAL HANDBALL TRAINING IN COMPARISON WITH EFFECTS IN SPORTS WITH DOMINANT BILATERAL LOADS IN TRAINING - DIFFERENCES IN MOTOR PERFORMANCE OF DOMINANT AND NONDOMINANT SIDE OF THE BODY

Ivan Belčić<sup>1</sup>, Alen Marošević<sup>1</sup> and Saša Rodić<sup>2</sup>

<sup>1</sup>Faculty of Kinesiology, University of Zagreb, Croatia

<sup>2</sup>High school Jastrebarsko, Jastrebarsko, Croatia

### Abstract

The aim of this paper is to determine the differences between the dominant and nondominant side of the body in indicators of motor performance by unilateral and bilateral athletes. 17 subjects were examined (members of the university handball team of the Faculty of Kinesiology) which represented unilateral athletes (in further text – UA) and 14 subjects (swimmers, gymnasts and bodybuilders, all students of the Faculty of Kinesiology) which represented bilateral athletes (in further text – BA). All respondents were male gender and had been tested in 5 tests. Tests were chosen to be the nearest representatives for activities in handball which are the most significant for success in this sport (hypothetical structure of success in handball). The obtained results indicate a significant difference in tests between the dominant and nondominant side both at unilateral and bilateral athletes. By BA statistically significant difference are appearing only in tests throwing the handball ball in sitting position on the ground with legs wide apart and hand tapping. Differences are interpreted by training methods and teaching process at the Faculty of Kinesiology, where BA spent the same training as UA, and UA spent the same training as BA in their parent (main) sport.

**Key words:** unilateral loads, bilateral loads, ambidexterity, situational effectiveness, handball

### Introduction

Unilateral and bilateral loads are present in the sports at training and at competitions. In bilateral sports athlete's body is loaded equally on both sides of the body, while in unilateral sports there are mostly loads on dominant side of the body. Guiding principle in the writing of this study were different studies which have been analyzing the effects of dominant and nondominant side of the body on specific performance in sport (Čular et al. 2010; Sabau et al. 2007). In analyzing the impact of the dominant and nondominant side of the body to specific performance in battle (Čular et al., 2010) it shows the difference in various types of kicks in taekwondo between the dominant and nondominant side. Bilateral or ambidextrous taekwondoists are more successful than those who have only limited kicks on the dominant side of the body. Ambidexterity is best defined as the ability to perform a specific task equally with the same precision and the ability both with dominant and nondominant side of the body (Sabau et al., 2007). Handball belongs to the complex poly-structural root of the sports (Milanović, 2009), which means that it is structured of simple and complex movements that are performed through cooperation and coordination of multiple players. Players are assigned to the positions in which dominant unilateral loads are dominating. These loads are defining the situational effectiveness which would be the largest in ambidextrous players. Considering this, in top-level handball, ambidextrous players are very rare (they almost do not exist) due to continuous unilateral training in all age categories.

### Methods

The sample which was tested in this study was total of 31 subjects, students from the Faculty of Kinesiology of the University of Zagreb. There were two groups of subjects. One group representing UA consisted of handball players and they are members of Faculty of Kinesiology university handball team. They also play regularly for their clubs which are competing from the highest level of competition in Croatia - Premier League till Croatian second divisions and they are all at the age of 19-25 years. BA sample consisted of 14 subjects, also students from the Faculty of Kinesiology at the age of 19-24 years and active athletes in gymnastics, swimming and body building. Those sports were chosen because they all use bilateral loads and way to train. All subjects were healthy and not injured during the testing.

Subjects were tested in five motor tests (basic and specific) that are closely representing activity in handball on the field. Tests that are covering parts of the unilateral activities in handball are: one leg jump from stance, throwing the handball ball in sitting position on the ground with legs wide apart, thrust of the hand behind back up the mast, hand tapping and amortization of handball ball rejecting it into the wall. Activities which are described with these tests are: jumps during jump shot, throws during more types of shots, the flexibility of the dominant and nondominant hand, and

basic and backhand pass. All tests were conducted according to the prescribed protocol (Metikoš et al. 1989) and repeated three times (except test one leg jump from stance that was repeated four times).

All the measured test results are analyzed in statistical software package Statistica 5.0.

## Results

Table 1. Descriptive statistic parameters (mean (Mean), minimum score (Min), maximum score (Max), range (Range) standard deviation (Standard Dev.), the coefficient of asymmetry (skewness), the coefficient of curvature (Kurtosis))

Test	Unilateral athletes – N = 17				Dominant side				Nondominant side					
	Mean		Min		Max		Range		Standard Dev.		Skewness		Kurtosis	
Strana	D	N	D	N	D	N	D	N	D	N	D	N	D	N
SAR	41,26	35,59	27,00	20,33	50,00	45,00	23,00	24,67	6,35	6,83	-0,93	-0,60	0,76	-0,21
BRL	25,63	13,47	16,23	10,33	30,83	17,40	14,60	7,07	3,40	1,78	-1,23	0,39	2,64	0,23
JAR	54,51	61,16	46,00	54,33	66,00	72,00	20,00	17,67	4,70	4,38	0,96	0,93	1,88	0,98
TAP	39,26	31,55	29,00	25,67	48,33	40,67	19,33	15,00	5,65	4,22	-0,14	0,95	-1,03	0,29
AMZ	7,84	10,40	6,13	7,87	10,30	13,67	4,17	5,80	1,13	1,24	0,71	0,56	-0,06	2,74
Test	Bilateral athletes – N = 17				Dominant side				Nondominant side					
	Mean		Min		Max		Range		Standard Dev.		Skewness		Kurtosis	
Strana	D	N	D	N	D	N	D	N	D	N	D	N	D	N
SAR	38,03	35,55	23,00	22,67	48,33	49,00	25,33	26,33	7,30	7,07	-0,32	0,42	-0,37	0,01
BRL	19,22	11,35	11,90	8,33	24,80	16,47	12,90	8,14	4,02	2,34	-0,64	0,53	-0,64	0,07
JAR	54,17	54,43	39,33	40,67	63,00	65,00	23,67	24,33	7,87	8,05	-0,62	-0,34	-0,88	-1,22
TAP	39,76	36,10	34,67	31,67	46,67	40,00	12,00	8,33	3,65	2,62	0,59	-0,08	-0,46	-0,91
AMZ	9,30	10,10	7,13	8,30	13,43	13,47	6,30	5,17	1,55	1,34	1,19	0,99	3,33	1,90

The deficit with nondominant side of the body is accentuated by the unilateral and by the bilateral athletes in test *throwing the handball ball in sitting position on the ground with legs wide apart (BRL)* and *hand tapping (TAP)*. This deficit can be interpreted primarily by innate characteristics of the human species. It could be concluded that the handedness (laterality) is the probability of a genetic component and the relationship of sex, birth order, multiple birth, first-degree relative's handedness on subject's handedness (Perelle, I.B., Ehrman, L. 1994), and a negligible extent by the structure of training and teaching at the Faculty of Kinesiology.

Table 2. Chi square test for the discriminant function (Eigenvalue (eigen-value), canonical correlation (R Canonici), Wilks Lambda (Wilks'  $\lambda$ ), the results of chi-square test ( $\chi^2$ ), degrees of freedom (df), statistical significance (p)). Differences between 1 - UA dominant side, 2 - UA nondominant side, 3 - BA dominant side, 4 - BA nondominant side, 5 - UA dominant and nondominant side, 6 - BA dominant and nondominant side

	1 – 2	3 – 4	1 – 3	2 – 4	5 – 6
Eigen- value	8,20	2,11	1,11	1,52	3,39
Canonical R	0,94	0,82	0,72	0,78	0,88
Wilks' $\lambda$	0,10	0,32	0,47	0,40	0,23
Chi-Sqr.	65,48	26,65	19,74	24,46	39,21
df	5	5	5	5	5
p	0,00	0,00	0,00	0,00	0,00

Chi square test showed that the differences between the observed features in all statistical analyses are significant. It was not expected that differences in performance of dominant and nondominant side of the body between the BA would be statistically significant.

Table 3. Connection of manifest variables with the discriminant function. Differences between 1 - UA dominant side, 2 - UA. nondominant side, 3 - BA dominant side, 4 - BA nondominant side, 5 - UA dominant and nondominant side, 6 - BA dominant and nondominant side

	1 – 2	3 – 4	1 – 3	2 – 4	5 – 6
<b>SAR</b>	0,15	0,12	0,23	0,00	0,24
<b>BRL</b>	0,81	0,86	0,85	-0,43	0,41
<b>JAR</b>	-0,26	-0,01	0,03	-0,45	-0,64
<b>TAP</b>	0,28	0,41	-0,05	0,53	0,32
<b>AMZ</b>	-0,39	-0,20	-0,53	-0,10	-0,44

Statistically significant and the highest correlation with discriminant function by UA and BA is in test *throwing the handball ball in sitting position on the ground with legs wide apart (BRL)*. That kind of a result was expected by UA, while by BA this result is interpreted in two ways. The first is the already mentioned innate characteristics of the human species (laterality). While the second way of interpreting the results can be justified by the educational system (teaching) on the Faculty of Kinesiology where sports with unilateral loads as handball, basketball, volleyball, soccer, jumping and throwing in athletics and elective courses like racquet sports are dominant.

## Discussion and conclusions

Tests which were conducted have a large share in describing the hypothetical structure of success in chosen sport with unilateral loads - handball. Velocity of movement, flexibility, specific strength, basic strength and coordination with test amortization of handball ball rejecting it into the wall have all been measured with these tests. The results obtained in all tests are showing statistically significant difference between dominant and nondominant side of the body by UA, while by BA differences occur only in two tests. Result in those tests is consequence of quality speed-explosive characteristics of the upper extremities. Differences are interpreted by many years of training and teaching process at the Faculty of Kinesiology, where BA spent the same training as UA, and UA spent the same training as BA in their parent (main) sport. Another very interesting significant difference is found between UA and BA by deviation of the dominant and nondominant hand (5 - 6) where are the most pronounced differences in the tests *thrust of the hand behind back up the mast (JAR)* and *amortization of handball ball rejecting it into the wall (AMZ)*, which is inversely scaled because lower result of the test gives a higher order on scale (test is measured in seconds). The result of the test *thrust of the hand behind back up the mast (JAR)* is interpreted with bigger muscle mass and less flexibility on dominant side of the body, while in test *amortization of handball ball rejecting it into the wall (AMZ)* better specific coordination and better ability of manipulating objects (handball ball) comes to expression. These bilateral trainings must be conducted from the youngest age group onwards in the training process where they would have significant affect on ambidexterity in all unilateral sports because it increases more capacity and performance in situational conditions (Sommer, 2006) from (Porac, Coren, 1981; Annett, 1985; Barfield, 1995) and efficiency on the ground in sports with unilateral loads, such as handball, football, basketball, volleyball, water polo and others. Other very important thing with bilateral training, especially from the youngest age groups and onwards in the training process in all activities would be a significant affect on the prevention of injuries. Those injuries in sports with unilateral loads usually occur because of the disparity between the left and right side of the body and with bilateral training these kinds of injuries would be reduced to minimum.

## References

1. Barfield, W.R. (1995). Effects of selected kinematic and kinetic variables on instep kicking with dominant and non-dominant limbs. *Journal of Human Movement Studies*, (29), str. 251-272.
2. Čular, D., Miletić, Đ. and Miletić, A. (2010). Influence of dominant and non-dominant body side on specific performance in taekwondo, *Kineziologija* 42(2), str. 184-193.
3. Metikoš, D., Hofman, E., Prot, F., Pintar, Ž. i Oreb, G. (1989). *Mjerenje bazičnih motoričkih dimenzija sportaša*. Zagreb: Fakultet za fizičku kulturu Sveučilišta u Zagrebu.
4. Milanović, D. (2009). *Teorija i metodika treninga*. Zagreb: Društveno veleučilište u Zagrebu, Kineziološki fakultet Sveučilišta u Zagrebu.
5. Perelle, I.B. and Ehrman, L. (1994). An international study of human handedness: The data. *Behaviour genetics*, 24 (3), str. 217-227.
6. Sabau, E., Gheorghe, D., Popescu, F., Ionita, M., Alupoae, M., Sandulache, S. and Teusdea, C. (2007). Study on lateralization and ambidexterity in children of early childhood age – first grade. *Bucuresti : Seria Educație Fizică, Sport și Kinetoterapie*. An IV, nr 4. str. 9-16.
7. Sommer, M. (2006). *Bilaterality in sports – an explorative study of soccer and ice-hockey players*. Umeå: Department of Psychology at Umeå University.



## TREND OF MORPHOLOGICAL CHARACTERISTICS OF TOP-LEVEL BODYBUILDER: A CASE STUDY

Saša Vuk<sup>1</sup> and Neven Čorak

<sup>1</sup>Faculty of Kinesiology, University of Zagreb, Croatia

### Abstract

The main purpose of this study was to estimate a trend of some morphological characteristics under programmed training process of a top-level bodybuilder aimed at competition *Mr Universum* during season 2004/2005. Subject had to increase his body mass (lean muscle mass and body fat) as much as he could during the *mass* period and also to reduce body fat and to preserve as much as possible his lean muscle mass in *definition* period. Set of simple regression analysis provided functional relationships between training process and some morphological characteristics (body mass, body fat, and volume of the chest, waist, thigh, shin and upper-arm). Functions and trends of morphological characteristics can be used as model values in future preparations for competitions, and also for other competitors with the same or similar morphological characteristics.

**Key words:** training process, bodybuilding, definition, mass

### Introduction

Trend analysis in kinesiology is mostly applied in analysis of development and in predicting of sports results. Skorowski (1965, according to Zatsiorsky, 1973) shows how analysis of record achievement indicates to possibility of identifying new methodical methods. Tracking of sports records dynamics gives insights to regularity which by means of statistical and mathematical methods enables rational predicting of development of sports results in the future. It also gives insights about perennial conditioning structure, about technique training efficiency, about effects of new training technology and about quality of diagnostic devices applied. In planning and programming of training processes for achieving the best results coaches, according to results analysis, get insights about results that have to be accomplished for the following event. For the trend analysis the most appropriate are accurately measurable events, like in athletics, swimming, weight lifting, etc. Further, another very important issue is a rate of expected results achievement. It gives general principles of individual result achievements which provides predicting of the most possibly results of an athlete (Wazny, 1978).

In previous studies, Zatsiorsky (1973) researched a rate of results achievement and results prediction and concluded that a number of factors affect a rate of results achievement. Therefore, it is impossible to determine adequate mathematical model which would explain mechanism of that process. Wazny (1978) monitored a rate of results development in athletics in period 1951-1974 of 18 athletic events and predicted the results for the following events till year 2000. He determined that all events do not have equal rate of results development. Jokl (1983, according to Harasin, 2002) predicted future results in athletic events, but also encompassed social indicators. Pavičić (1987) analyzed a trend of results development in high jump held in Olympic Games in period 1948-1984, Lukenda (1988) analyzed a trend of results development in shot put held in Olympic Games in period 1896-1980, and Bogunović (1990) analyzed trends of results development in long jump and triple jump held in Olympic Games in period 1948-1984.

There is a lack of papers that inquiries case studies because diagnostic results of top-level athletes, especially bodybuilders, are confidential or they are clinic and rehabilitation oriented.

Bodybuilding is a sport in which one of the purposes is to gain extra muscle mass and to lose as much as possible of body fat. Development of muscle strength and muscle endurance and the gain of entire body muscle hypertrophy are secondary aims of bodybuilding (Quill, 2005).

There are two basic periods in professional bodybuilding: *mass* and *definition* (Čorak, 2001). During the *mass* period the aim is to get extra muscle mass for the following competition (Čorak, 2001; Meletis et al., 2005). Fat mass is expected too, 15-17% (Too et al., 1998). Calories intake is increased and training sessions are based on high intensity resistance training. Aerobic activities are reduced or completely terminated. The main purpose of the *definition* period is to preserve as much as possible lean muscle mass gained in the *mass* period and also to reduce gained body fat (Čorak, 2001; Van der Ploeg et al., 2001). In this period calories intake is reduced (Rankin, 2002), resistance training volume is increased and intensity is decreased. Aerobic exercises are also present (Kelley and Kelley, 2006; Okura et al., 2005; Volek et al., 2005).

The main purpose of this study is to estimate a trend of some morphological characteristics under programmed training process of a top-level bodybuilder.

## Methods

A measurement of the morphological characteristics was realized two times per month during preparation for bodybuilding contest *Mr. Univerzum 2005*, in period from 15, October 2004 till 8, October 2005, which resulted in a sequence of morphological variables. A body mass, a proportion of body fat, volume of the chest, volume of the waist, volume of the upper-arm during contraction in flexion, volume of the thigh during contraction in extension and volume of the shin were measured.

The series of regression analyses were performed to attain the relationship between training program and some morphological characteristics.

## Results

The results of some morphological characteristics are presented in the table 1, regression analysis coefficients are presented in the table 2. Functions of the trends of some morphological characteristics of periods *mass* and *definition* are shown in the table 3 and in figure 1.

Table 1. Results of some morphological characteristics in periods *mass* and *definition*

DATE	BODY MASS (kg)	BODY FAT (%)	VOLUME OF THE CHEST (cm)	VOLUME OF THE WAIST (cm)	VOLUME OF THE UPPER-ARM (cm)	VOLUME OF THE THIGH (cm)	VOLUME OF THE SHIN (cm)	
<i>mass</i>	15.10.04.	116	9.5	137.75	88	50.75	76.5	49.25
	01.11.04.	123	13.2	139.5	93.75	51.75	77.25	50
	15.11.04.	127.5	15	142	100	52	78	50.5
	01.12.04.	130	16.4	142.5	102	52.25	78.25	50.75
	15.12.04.	131	17.1	143	104	52.5	78.5	50.75
	01.01.05.	131.25	17.3	143	103.75	52.25	78.75	51
	15.01.05.	131	17.1	143	104	52.5	78.5	50.75
	01.02.05.	131	17.1	143	104	52.5	78.5	50.75
	15.02.05.	133	17.2	143.5	104.5	52.75	78.25	51
	01.03.05.	133.75	17.3	143.25	104.25	53	79.25	51
	15.03.05.	134	17.2	143.25	104	52.75	79	51
	01.04.05.	133.75	17.2	143.5	104	52.5	78.75	51
	15.04.05.	133.75	17.2	143.25	103.5	52.75	79	50.75
	01.05.05.	129	16.9	142.75	102	52.75	78.75	51
	15.05.05.	133.75	17.2	143.25	104.5	52	79	51
01.06.05.	135	17.3	143.5	104	53	79.25	51.25	
<i>definition</i>	15.06.05.	133.75	17.2	143.25	104	52.75	79	51
	01.07.05.	128	15	142.5	99	52	79	51
	15.07.05.	125	13.2	141.75	95	51.25	78.75	50.75
	01.08.05.	121.5	10.7	140.25	90.25	51	78.75	50.75
	15.08.05.	117	8.4	140	87.5	51	78.25	50
	01.09.05.	114.25	6	139.75	85	50.75	78	49.75
	15.09.05.	111	4.5	138.25	82	50.5	77.75	49.75
<i>contest</i>	08.10.05.	108.25	3.1	138.75	80.75	50	77.25	49.25

Table 2. Multiple regression coefficients (*R*), coefficients of determination ( $R^2$ ) and *p*-level

		BODY MASS (kg)	BODY FAT (%)	VOLUME OF THE CHEST (cm)	VOLUME OF THE WAIST (cm)	VOLUME OF THE UPPER-ARM (cm)	VOLUME OF THE THIGH (cm)	VOLUME OF THE SHIN (cm)
<i>mass</i>	<i>R</i>	0.95	0.98	0.97	0.98	0.89	0.95	0.96
	$R^2$	0.90	0.96	0.95	0.96	0.79	0.90	0.93
	<i>p</i>	0.00	0.00	0.00	0.00	0.00	0.00	0.00
<i>definition</i>	<i>R</i>	0.99	0.99	0.96	0.98	0.95	0.97	0.96
	$R^2$	0.98	0.98	0.92	0.96	0.90	0.95	0.93
	<i>p</i>	0.00	0.00	0.00	0.00	0.00	0.00	0.00

Table 3. Functions of the trends of some morphological characteristics in periods mass and definition

	MASS	DEFINITION
BODY MASS	$y = 111.57 + 6.57x - 0,65x^2 + 0.02x^3$	$y = 135.93 - 3.57x$
BODY FAT	$y = 7.46 + 5.08x - 0,52x^2 + 0.02x^3$	$y = 24.98 - 2.87x$
VOLUME OF THE CHEST	$y = 135.88 + 2.42x - 0,25x^2 + 0.008x^3$	$y = 143.72 - 0.7x$
VOLUME OF THE WAIST	$y = 82.14 + 7.47x - 0,77x^2 + 0.03x^3$	$y = 105.46 - 3.34x$
VOLUME OF THE UPPER-ARM	$y = 50.38 + 0.67x - 0,06x^2 + 0.002x^3$	$y = 52.67 - 0.34x$
VOLUME OF THE THIGH	$y = 75.85 + 0.87x - 0,09x^2 + 0.003x^3$	$y = 79.48 - 0.25x$
VOLUME OF THE SHIN	$y = 48.75 + 0.74x - 0.08x^2 + 0.003x^3$	$y = 51.47 - 0.27x$

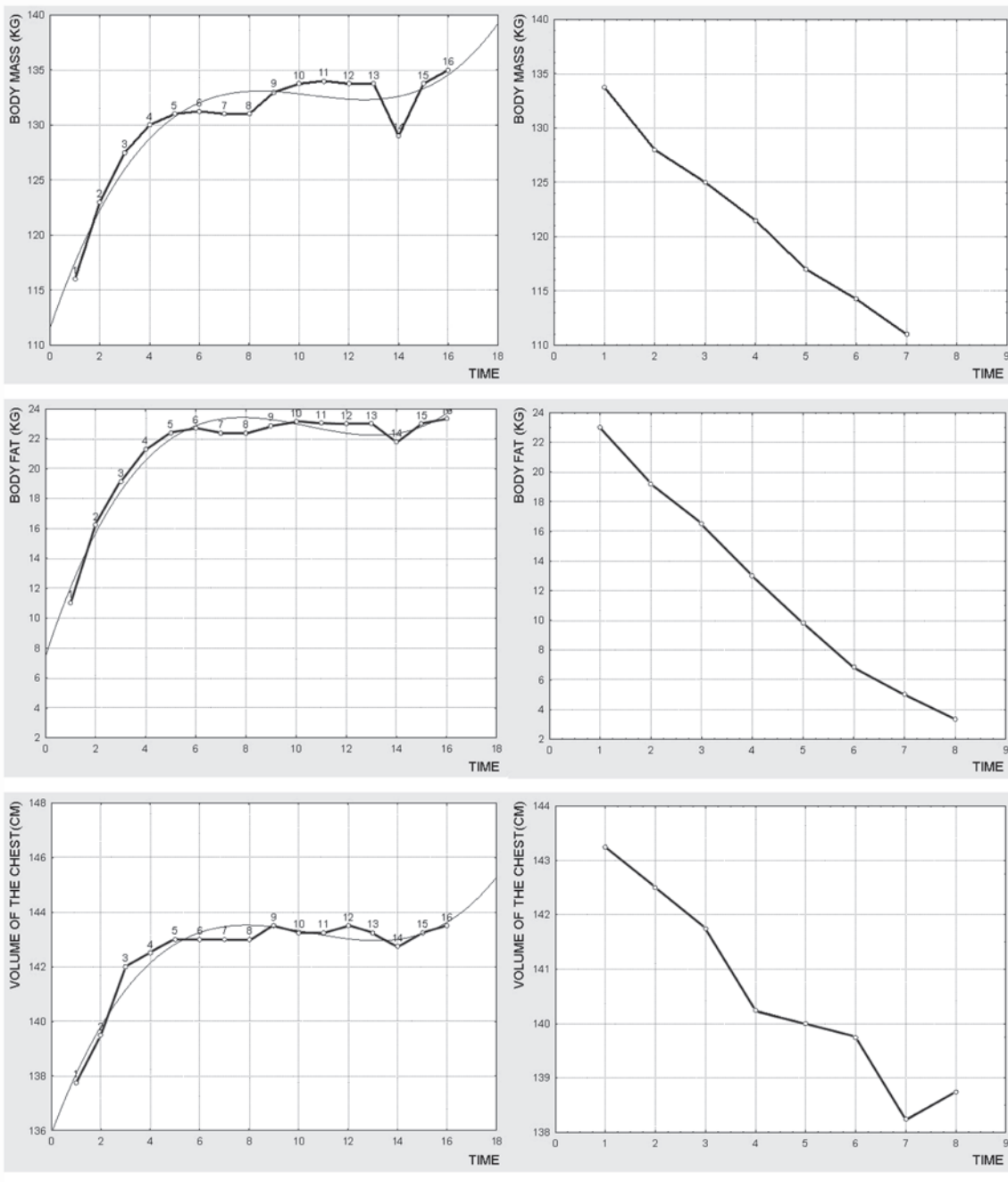

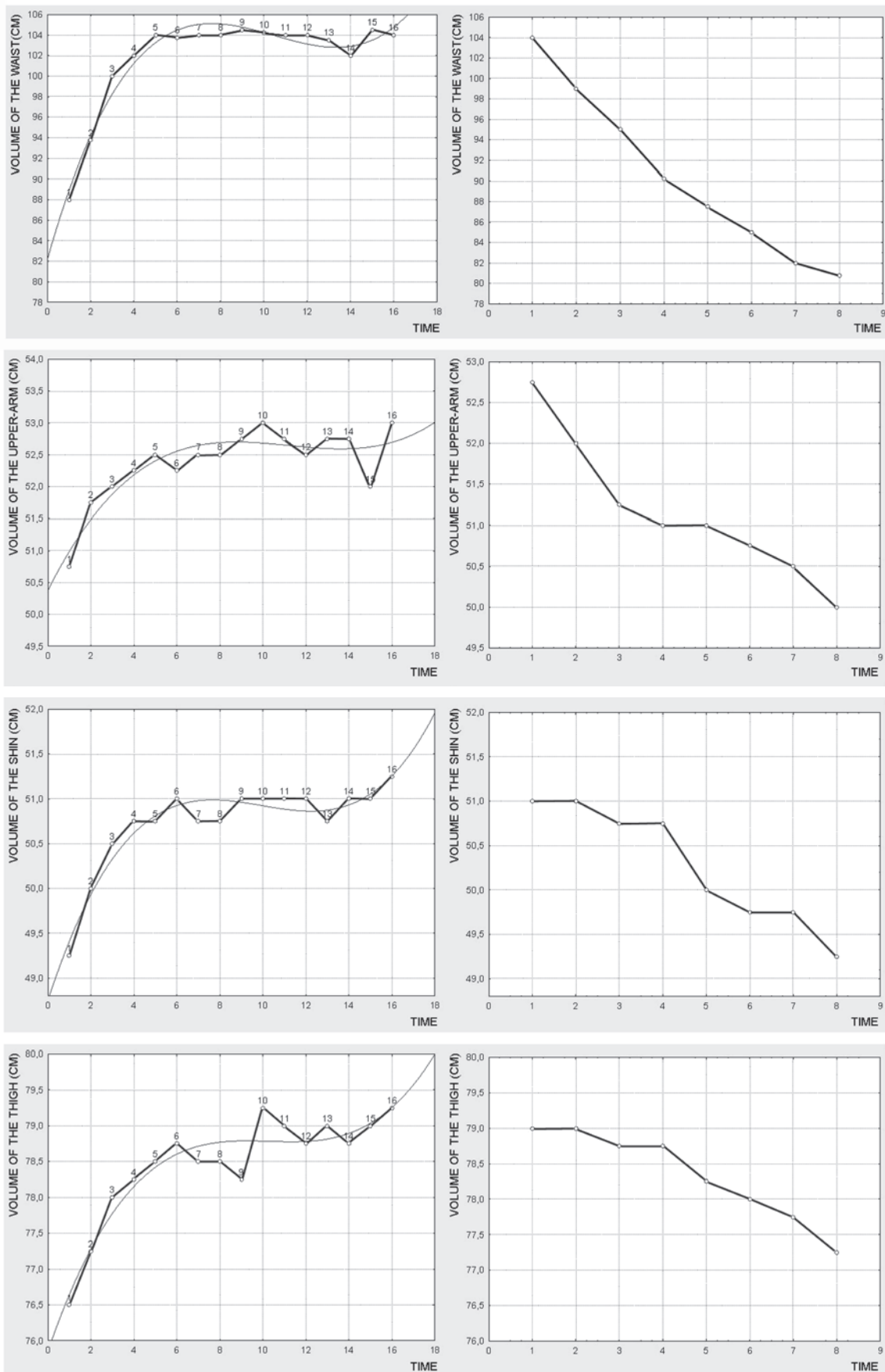

Figure 1. Trends of changes of morphological characteristics under mass period (left) and definition period (right)

Multiple correlations coefficients in training period *mass* are slightly lower than in period *definition*, with values 0.89-0.98 and 0.95-0.99, respectively. Correlation coefficients show that training process has a great influence on the morphological characteristics of the subject. Large coefficients of determination imply that there is a notable amount of concerted variance, i.e. about a great predictive power of a treatment influence on the morphological characteristics. Regression analysis gave the regression coefficients and time function of trends of morphological characteristics in treatments *mass* and *definition* (Table 3). These regression coefficients represent mean values of dynamics. Functions of period *mass* are best approximated as polynomial functions of third degree and functions of period *definition* are best approximated as linear functions.

## Discussion and conclusions

According to results shown on figure 1 it is easy to notice that all morphological characteristic in period *mass* have steep trend of growth in first 10 weeks. For example, body mass increased for 15 kg, mostly because of 10 kg body fat. The remaining period of time is stagnation of morphological values. Period *definition* has a linear trend and affects equally in all time periods. Body mass drops 1.79 kg per week, of which 1.44 kg belongs to body fat (Table 3). It means that period *definition* primary affects body fat. Similarly, in the period *definition*, volumes of all measured characteristics decline under training processes. Specifically, the significant decline is noticed in variable volume of the waist where subject lost 1.67 cm per week. Consequently, there is also noticed a loss of lean muscle mass, but it is in line with the aim of the period *definition*.

In this study the effects of programmed training sessions on morphological characteristics were identified. Functions and trends of morphological characteristics of top-level bodybuilder can be used as model values in future preparations for competitions, and also for other competitors with the same or similar morphological characteristics.

## References

1. Bogunović, A. (1990). Analiza trendova olimpijskih rezultata u skoku u dalj i troskoku. Diplomski rad. Fakultet za fizičku kulturu. Zagreb.
2. Čorak, N. (2001). *Fitness & Bodybuilding*. Hinus. Zagreb.
3. Harasin, D. (2002). Analiza trenda razvoja bacačkih disciplina na Olimpijskim igrama. Magistarski rad. Kineziološki fakultet Sveučilišta u Zagrebu.
4. Kelley, G.A., Kelley, K.S. (2006). *Effects of aerobic exercise on C-reactive protein, body composition, and maximum oxygen consumption in adults: a meta-analysis of randomized controlled trial. Clinical And Experimental [Metabolism]*. 2006 Nov; Vol. 55 (11), pp. 1500-7.
5. Lukenda, Ž. (1988). Analiza trenda razvoja rezultata u bacanju kugle na Olimpijskim igrama od 1896. do 1980. godine. Diplomski rad. Fakultet za fizičku kulturu. Zagreb.
6. Meletis, C.D., Zabriskie, Nieske (2005). *Natural Supports for Gaining and Maintaining Muscle Mass. Alternative & Complementary Therapies*; Oct 2005, Vol. 11 Issue 5, p257-263, 7p.
7. Okura, T., Nakata, Y., Lee, D. J., Ohkawara, K., Tanaka, K. (2005). *Effects of aerobic exercise and obesity phenotype on abdominal fat reduction in response to weight loss. International Journal of Obesity*; Oct 2005, Vol. 29 Issue 10, p1259-1266, 8p.
8. Pavičić, A. (1987). Analiza dinamike rezultata skoka u vis kod vrhunskih atletičara u periodu 1948.-1987. godine. Diplomski rad. Fakultet za fizičku kulturu. Zagreb.
9. Quill, S. (2005). *Get a Grip on a Better Bench Press. Men's Health* (10544836); Dec 2005, Vol. 20 Issue 10, p192-192, 1/3p, 1 chart, 1c.
10. Rankin, J.W. (2002). *Weight loss and gain in athletes. Curr Sports Med Rep*. 2002 Aug; 1(4):208-13.
11. Too, D., Wakayama, E.J., Locati, L.L., Landwer, G.E. (1998). *Effects of precompetition bodybuilding diet and training regimen on body composition and blood chemistry. J Sports Med Phys Fitness*. 1998 Sep; 38(3): 245-52.
12. Van der Ploeg, G.E., Brooks, A.G., Withers, R.T., Dollman, J., Leaney, F., Chatterton, B.E. (2001). *Body composition changes in female bodybuilders during preparation for competition. Eur J Clin Nutr*. 2001 Apr; 55(4):268-77.
13. Volek, J.S., VanHeest, J.L. (2005). *Diet and Exercise for Weight Loss: A Review of Current Issues. Sports Medicine*; 2005, Vol. 35 Issue 1, p1-9, 9p.
14. Wazny, Z. (1978). Sistem sportskog treninga. Partizan. Beograd.
15. Zatsiorsky, V.M. (1973). Matematika, kibernetika i sport. Partizan. Beograd.

## EFFECTS OF CONCENTRIC TRAINING ON POWER AND CHANGE-OF-DIRECTION SPEED\*

Sanja Šalaj<sup>1</sup>, Cvita Gregov<sup>1</sup> and Leonard Sovina<sup>2</sup>

<sup>1</sup>Faculty of Kinesiology, University of Zagreb, Croatia

<sup>2</sup>FC Lokomotiva, Zagreb, Croatia

### Abstract

Main purpose of this study was to determine and analyse effects of concentric training on jumping power and change-of-direction speed. Ninety-seven healthy physically active men participated in this study (age:  $20 \pm 2$  yrs; body mass  $76.1 \pm 7.4$  kg; body height  $181.3 \pm 5.7$  cm). Experimental procedure consisted of initial testing, 10 weeks of concentric jumping training and final testing.

Motor abilities were measured using seven tests for determining power (4) and change-of-direction speed (3). Experimental group conducted concentric jumping training for 10 weeks, 3 times per week. Control group continued with their regular daily activities. Differences between groups at the beginning and at the end of experiment were determined using discriminative analysis. Main results of this research show that concentric jumping training has a negative influence on change of direction speed. These results imply that in agility training, concentric jumping exercises should not be performed.

**Key words:** strength, jump, agility

### Introduction

Physical conditioning, as a part of a training process, comprises various programs for the development of the components of physical fitness of persons involved in regular exercise activities. The fundamental didactic assumption of the proposed research is: various training operators (contents) activate various functional (energy and cardio-respiratory capacities), motor and morphological systems in humans. Transformational processes of physical conditioning attract paramount attention of researchers, professionals and program users. On the basis of previous findings and inferences it is possible to define objective criteria for the determination of transformational procedures aimed at physical attributes development and sustenance. The main goal of the research was to program and evaluate transformational procedures of physical conditioning which have considerable influence on the development of physical fitness components, specifically, power and change-of-direction speed (often referred to as agility). In studying transformational processes special accent is put on scientific research on effects of different training methods on maximal strength and power (Colliander i Tesch, 1990; Lytle i sur., 1996; Wilson i sur., 1996; Delacluse, 1997; Peterson i sur., 2005; Crewther i sur., 2005; van den Tillaar, 2004).

The results of previous research as well as practical experience show that differently planned training procedures of speed and explosiveness can efficiently develop power and change-of-direction speed. Change-of-direction speed is mostly developed by the training process like the quick change of direction (lateral, frontal and horizontal), while power is developed by applying weight training with a small and medium loads and plyometric technology of training (Sheppard & Young, 2006; Marković, 2004). Recent study (Markovic & Mikulic, 2010) shows that plyometric training may improve vertical jump height, with greater effects in vertical jumps containing either slow (countermovement jump: 6.9% and 10%) or fast stretch-shortening cycles (drop jump: 8.1%) than in concentric-only vertical jumps (squat jump: 4.3%). Agility performance following a plyometric training intervention improved on average by 4.8% (Markovic & Mikulic, 2010). Main purpose of our study was to evaluate effects of concentric-only jumping training on power and agility. In this type of jumping there is no benefit from stretch shortening cycle because jumping is performed from static, pre-stretched position. Furthermore, in this research landing is dominantly performed to a high box, so the effects of eccentric landing phase is also excluded.

\* This research was supported, in part, by grant no. 034-0342610-2609 (Programming of transformational procedures for physical conditioning) from Croatian Ministry of science, education and sport.

## Methods

Ninety-seven healthy physically active men volunteered to participate in this study (age:  $20 \pm 2$  yrs; body mass  $76.1 \pm 7.4$  kg; body height  $181.3 \pm 5.7$  cm). Subjects were randomly divided into experimental (45) and control (52) group. Power and agility were tested using seven tests from table 1.

Table 1. Performed tests for power and agility

NO.	MOTOR QUALITY	TEST
1.	Power	Squat jump (SJ) (Bosco, 1992)
2.	Power	Counter-movement jump (CMJ) (Bosco, 1992)
3.	Power	Horizontal jump (HJ) (Metikoš i sur., 1989)
4.	Power	Reactive jumps from the ankle joint (RJ) – five consecutive reactive jumps with little amplitude of movement in the knee, minimal time of foot-ground contact and maximal jump high (modified according to Bosco, 1992)
5.	Change of direction speed	20 yards (Y20) (Salaj & Markovic, 2011)
6.	Change of direction speed	Lateral stepping (LS) (Salaj & Markovic, 2011).
7.	Change of direction speed	Figure-of-eight run (F8) (Salaj & Markovic, 2011).

Power and change of direction speed were tested before and after concentric jumping training protocol. Duration of training protocol for the experimental group was 10 week with frequency of three times a week. Experimental training protocol consisted of jumping exercises that were performed concentric-only. That means that jumps were performed from a stabile half-squat position to a box of different heights to avoid eccentric contractions in start and landing phase. Participants did not jump from a box down, but they walked down the bench. Jumping exercises were performed progressively: squat jump, squat jump to a box of 40-60cm height, squat jump over hurdle of 40-60cm height, squat jump to a box of 40-60cm height using additional load (medicine ball). Initial jumping height was defined using initial testing values for each participant. Subjects performed between 60-75 jumps per training unit, and rest between exercises and sets lasted for 3-5 minutes. During 10 weeks of training for experimental group, control group continued with their regular daily activities.

Data were analyzed using Statistica for Windows, ver. 7.0. Central and dispersive statistic parameters were calculated for all variables. Differences between groups at the beginning and at the end of experiment were determined using discriminative analysis.

## Results

Table 2 shows mean values in each power and agility test before and after the training protocol for experimental and control group.

Table 2. Results in power and change-of-direction speed tests before and after the training protocol

		Before			After		
		Mean	±	Std.Dv.	Mean	±	Std.Dv.
Experimental group	SJ	43,57	±	6,09	43,43	±	5,56
	CMJ	45,75	±	6,34	44,93	±	6,16
	RJ	39,20	±	5,33	40,81	±	4,62
	HJ	242,86	±	17,30	240,30	±	17,70
	Y20	5,03	±	0,21	5,32	±	0,32
	LS	7,94	±	0,49	8,47	±	0,62
	F8	11,62	±	0,64	12,17	±	0,74
Control group	SJ	43,53	±	5,35	41,66	±	4,35
	CMJ	45,32	±	4,82	44,14	±	5,02
	RJ	36,00	±	4,75	39,88	±	4,69
	HJ	243,05	±	15,21	240,71	±	15,41
	Y20	5,04	±	0,26	5,34	±	0,32
	LS	7,94	±	0,52	8,41	±	0,60
	F8	11,49	±	0,59	12,41	±	0,77

From the results in table two it is visible that experimental group after the concentric jumping training impaired change-of-direction speed in Y20, LS i F8 (higher value means poorer result in change-of-direction measures), but improved reactive jumping ability (RJ). In final testing, control group had poorer results in change-of direction speed (Y20, LS i F8), squat and countermovement jumping ability (SJ i CMJ), but better results in reactive jumping (RJ). Table 3 shows the results of discriminative analysis that was used to analyse the differences between experimental and control group at the end of experiment. At the end of experiment, experimental and control group differed significantly ( $P < 0.04$ ). At the univariate level F-test showed statistically significant differences between groups in squat jump ( $P = 0.005$ ), and in one test of change-of-direction speed (F8). Numerically, experimental group had similar test results in squat jump in initial and final testing, while control group had lower values in final testing (see Table 2). Since the groups did not differ significantly before the experimental training protocol, this differences in final testing can be attributed to concentric jumping training protocol that experimental group conducted for ten weeks.

Table 3. Differences between experimental and control group at the end of experiment

Discriminant Function Analysis Summary: No. of vars in model: 7; Grouping: GRUPA (2grps) Wilks' Lambda: ,85556 approx. F (7,89)=2,1465 p< ,0467						
	Wilks&apos	Partial	F-remove	p-level	Toler.	1-Toler.
<b>SJ</b>	0,93	0,92	8,19	0,01	0,24	0,76
<b>CMJ</b>	0,86	0,96	3,76	0,06	0,26	0,74
<b>RJ</b>	0,86	1,00	0,43	0,52	0,71	0,29
<b>HJ</b>	0,88	0,97	2,67	0,11	0,51	0,49
<b>Y20</b>	0,86	1,00	0,03	0,86	0,49	0,51
<b>LS</b>	0,88	0,98	2,13	0,15	0,56	0,44
<b>F8</b>	0,91	0,94	6,03	<b>0,02</b>	0,52	0,48

## Discussion and conclusions

Main result of this research is that experimental training protocol that consisted of concentric jumping influenced the squat jump and change-of-direction speed differences between the groups at the end of experiment. Specifically, control group had poorer power results at the end of experiment (approximately 2cm lower SJ values), and lower change-of-direction speed (92 seconds lower mean value in F8), while experimental group practically did not change leg power (0.14cm lower SJ in final testing) and change-of-direction speed in F8 test was lower for 0.55 seconds.

Secondly, since experimental group had numerically lower results in all change-of direction speed tests and in some power tests, apparently, prescribed concentric training protocol has negative influence on change-of-direction speed and insufficient influence on leg power measures.

Based on the results of this study it can be assumed that jumping concentric training negatively influences change-of-direction speed. Previous research has usually compared concentric and eccentric training effects on different physical characteristics such as strength or muscle mass (Gur et al, 2002; Miller et al., 2006; Roig et al, 2009). Results from this research show that eccentric training is performed at higher force levels and is superior to concentric-only training. Research from Markovic & Mikulic (2011) also suggests that type of contraction in training influences the specificity of training effects, and that pyometric training has a greater impact on fast and slow stretch-shortening cycle jump test values (drop jump, countermovement jump) than on concentric-only jump test values (squat jump). When analyzing effects of concentric-only training obtained in this research, it can be seen that concentric training did not influence power and change-of-direction speed as we expected. Obtained results show that effects of concentric training on power can be described as maintaining effects, since the results in experimental group stayed the same, and in control group were lower.

Reason for this can be searched in insufficient training program in number of jumps per training, jump height, training frequency and overall duration of training program.

Most change-of-direction tasks require a rapid switch from eccentric to concentric muscle action in leg extensor muscles (stretch shortening cycle muscle function - SSC (Markovic & Mikulic, 2010), thus it was suggested that plyometric training positively affects change-of-direction speed. This can be a reason that in our research negative changes in change-of-direction speed were found. Specificity of change of direction movement regarding the type of contraction, possibly demand diversity in training regimens: jumping from which an eccentric phase was excluded, apparently is not a good way to develop high SSC movement ability. As seen in this research, this concentric-only training negatively influences change-of-direction ability and a plyometric training could be a better way to develop this physical characteristic.



Practically, in sport activities in which change-of-directions are frequent it would not be advisable to isolate concentric-only from eccentric-concentric jumps in training programs. On the other hand, concentric-only training could have some positive influence in sport activities that require moving the objects from a static position, such as in weightlifting or in block start in athletics. Further research with higher training volumes of concentric-only exercises is needed to determine its specific influence on various performance measures.

## References

1. Bosco, C. (1992). L' évaluation de la force par le test de Bosco. Roma, Societa Stampa Sportiva.
2. Colliander, E.B., P.A. Tesch (1990). Effects of eccentric and concentric muscle actions in resistance training. *Acta Physiologica Scandinavica* 140: 31-39.
3. Crewther, B., Cronin, J., Keogh, J. (2005). Possible stimuli for strength and power adaptation: acute mechanical responses. *Sports Medicine* 35(11): 967-989.
4. Delecluse, C. (1997). Influence of strength training on sprint running performance. Current findings and implications for training. *Sports Medicine* 24(3): 147-156.
5. Gür, H., Cakin, N., Akova, B., Okay, E., Küçükoğlu, S. (2002). Concentric versus combined concentric-eccentric isokinetic training: effects on functional capacity and symptoms in patients with osteoarthritis of the knee. *Archives of Physical Medicine and Rehabilitation* 83(3):308-316.
6. Lyttle, A.D., G.J. Wilson, K.J. Ostrowski (1996). Enhancing performance: maximal power versus combined weights and plyometric training. *Journal of Strength and Conditioning Research* 10(3): 173-179.
7. Marković, G. (2004). *Utjecaj skakačkog i sprinterskog treninga na kvantitativne i kvalitativne promjene u nekim motoričkim i morfološkim obilježjima*. Doktorska disertacija. Kineziološki fakultet, Zagreb.
8. Markovic, G., Mikulic, P. (2010). Neuro-Musculoskeletal and Performance Adaptations to Lower-Extremity Plyometric Training. *Sports Medicine* 40 (10): 859 - 895.
9. Metikoš, D., E. Hofman, F. Prot, Ž. Pintar, G. Oreb (1989). *Mjerenje bazičnih motoričkih dimenzija sportaša*. Zagreb: Fakultet za fizičku kulturu Sveučilišta u Zagrebu.
10. Miller, L.E., Pierson, L.M., Nickols-Richardson, S.M., Wootten, D.F., Selmon, S.E., Ramp, W.K., Herbert, W.G. (2006). Knee extensor and flexor torque development with concentric and eccentric isokinetic training. *Research Quarterly in Exercise and Sport* 77(1): 58-63.
11. Peterson, M.D., Rhea, M.R., Alvar, B.A. (2005). Applications of the dose-response for muscular strength development: a review of meta-analytic efficacy and reliability for designing training prescription. *Journal of Strength and Conditioning Research* 19(4): 950-958.
12. Roig, M., O'Brien, K., Kirk, G., Murray, R., McKinnon, P., Shadgan, B., Reid, W.D. (2009). The effects of eccentric versus concentric resistance training on muscle strength and mass in healthy adults: a systematic review with meta-analysis. *British Journal of Sports Medicine* 43(8): 556-568.
13. Salaj, S., Markovic, G. (2011). Specificity of Jumping, Sprinting, and Quick Change-of-Direction Motor Abilities. *Journal of Strength and Conditioning Research* 25(5): 1249-1255.
14. Sheppard, J.M., & Young, W.B. (2006). Agility literature review: Classifications, training and testing. *Journal of Sport Sciences*, 24(9):912-932.
15. van den Tillaar R. (2004). Effect of different training programs on the velocity of overarm throwing: a brief review. *Journal of Strength and Conditioning Research* 18(2): 388-396.
16. Wilson, .GJ., Murphy, A.J., Giorgi, A. (1996). Weight and plyometric training: effects on eccentric and concentric force production. *Canadian Journal of Applied Physiology* 21(4): 301-315.

## Acknowledgments

The study was supported by the Croatian's Ministry of Science, Education and Sport grant no. 034-0342610-2609.

## CHANGES IN POWER MEASUREMENTS INFLUENCED BY MEDICINE BALL BALLISTIC TRAINING\*

Cvita Gregov, Sanja Šalaj and Dragan Milanović

*Faculty of Kinesiology, University of Zagreb, Croatia*

### Abstract

The main purpose of this research is to determine whether medicine ball throwing training program influences power and strength performance. 154 subjects aged  $22.5 \pm 4.5$  to 27 participated in this study and underwent training program consisted of 8 different types of throwing exercises in duration of 10 weeks, 3 times per week. Subjects were assigned in two groups, experimental and control. Only the experimental group performed throwing exercises. All subjects were measured pre- and post-training by 12 performance tests for estimating power and strength. The results indicated no positive transformational effects regarding the majority of tests applied. Based on these findings it can be concluded that 10-week ballistic medicine ball training program, conducted 3 times per week and in duration of 60 minutes, cannot produce statistically significant effects on sprinting, jumping and throwing power neither on maximum strength.

**Key words:** *strength, motor abilities, throwing*

### Introduction

Power represents one of the most important motor abilities that largely influence all motor performances which demand high muscle force generation in shortest time possible (Marković, 2003., Newton i Kraemer, 1994) and those in which body mass, parts of the body or some external object must be accelerated, i.e. ballistic movements such as jumping, sprinting, throwing and kicking. Such movements also comprise performance tests for estimating power generated by a certain subject.

Most of the current research that evaluates power exercises for performance improvements deals with jumping, much less with sprinting and especially throwing exercises.

Power manifested in throwing movements is estimated by velocity attained from the object thrown or distance achieved after the throw. In order to improve throwing power most commonly used objects for training are medicine balls of different sizes.

Throwing training programs are ballistic and consist mostly of such movements that can be performed by isolated concentric contraction or by plyometric type eccentric/concentric contraction, i.e. stretch-shortening cycle, and are aimed at throwing an object. There is a scarce of ballistic training research that evaluate throwing training programs, especially those using the medicine ball (Newton & McEvoy, 1994; McEvoy & Newton, 1998; Szymanski et al., 2007).

Therefore, the main purpose of this research is to determine whether medicine ball throwing training program influences power and strength performance.

### Methods

**Subjects.** 154 subjects aged  $22.5 \pm 4.5$  to 27 participated in this study. All of them were students at Faculty of Kinesiology, University of Zagreb conveniently assigned in experimental ( $n=94$ ) and control ( $n=60$ ) group due to their regular courses schedule.

**Sample of variables.** Sample of variables consisted of 12 performance tests for estimating power and strength: 5-metre sprint (SPRINT5; s), 10-metre sprint (SPRINT10; s), 20 metre sprint (SPRINT20; s), squat jump (SJ; cm), counter-movement jump (CMJ; cm), repetitive jumps in 15 seconds (SP15S; cm and W/kg) (Bosco, 1992), sitting chest 3 kg medicine ball throw (SMT; km/h), straight legged sitting handball ball throw (HTS; km/h), straight legged sitting 1 kg medicine ball throw (MT1; km/h), overhead medicine ball throw (OMT; dm) and bench press (IRM; kg). All sprint tests were measured using telemetric photocells (RS Sport, Zagreb) and represent time achieved for the given distances in seconds (s). Jump

\* This research was supported, in part, by grant no. 034-0342610-2609 (Programming of transformational procedures for physical conditioning) from Croatian Ministry of science, education and sport.

height was measured by *QUATTRO JUMP* force plate and accompanied software (Kistler, Winterthur, Switzerland). All jump heights were expressed in centimeters (cm).

Experimental design. Subjects assigned in experimental group undertaken an experimental medicine ball throw training program in duration of 10 weeks, 3 times per week. Each session lasted 60 minutes. At the same time and extent, the control group had undertaken regular Basic kinesiological transformations classes consisting of basic movements' terminology, stretching exercises and basic weight training exercises. Experimental program consisted of 8 different types of throwing exercises. Intensity of each exercise was increased by increasing the number of repetitions and medicine ball weight (Table 1). Following exercises were performed: (1) *squat jump medicine ball throw (SJMT)*, (2) *forward medicine ball throw after four-stride sprint start (FMT4)* (3) *overhead medicine ball throw (OMT)*, (4) *forward medicine ball throw from below (leap) (FMTL)*, (5) *standing chest medicine ball throw (SCMT)*, (6) *forward medicine ball throw from above (no leap) (FMT)*, (7) *single hand (both hands) handball throw (medicine ball) (SHHT)* and (8) *Lying forward medicine ball throw (by sitting up) (LFMT)*.

Table 1. Medicine ball throw program

Throws	1. i 2. week	3. week	4. week	5. week	6. week	7. week	8. week	9. week	10. week	11. week	12. week	13. & 14. week
	Pre-training testing	Double hand throw 3 kg Single hand throw 1 kg			Double hand throw 4 kg Single hand throw 2 kg				Double hand throw 5 kg Single hand throw 2 kg			Post-training testing
SJMT		2x6-8 (45")	3x6-8 (45")	4x6-8 (45")	3x6-8 (45")	4x6-8 (45")	4x6-8 (45")	2x6-8 (45")	3x6-8 (45")	4x6-8 (45")	4x6-8 (45")	
FMT4		2x5-7 (45")	3x5-7 (45")	4x5-7 (45")	3x5-7 (45")	4x5-7 (45")	4x5-7 (45")	2x5-7 (45")	3x5-7 (45")	4x5-7 (45")	4x5-7 (45")	
OMT		2x6-8 (45")	3x6-8 (45")	4x6-8 (45")	3x6-8 (45")	4x6-8 (45")	4x6-8 (45")	2x6-8 (45")	3x6-8 (45")	4x6-8 (45")	4x6-8 (45")	
FMTL		2x6-8 (45")	3x6-8 (45")	4x6-8 (45")	3x6-8 (45")	4x6-8 (45")	4x6-8 (45")	2x6-8 (45")	3x6-8 (45")	4x6-8 (45")	4x6-8 (45")	
SCMT		2x6-8 (45")	3x6-8 (45")	4x6-8 (45")	3x6-8 (45")	4x6-8 (45")	4x6-8 (45")	2x6-8 (45")	3x6-8 (45")	4x6-8 (45")	4x6-8 (45")	
FMT		2x6-8 (45")	3x6-8 (45")	4x6-8 (45")	3x6-8 (45")	4x6-8 (45")	4x6-8 (45")	2x6-8 (45")	3x6-8 (45")	4x6-8 (45")	4x6-8 (45")	
SHHT		2x6-8 (45")	3x6-8 (45")	4x6-8 (45")	3x6-8 (45")	4x6-8 (45")	4x6-8 (45")	2x6-8 (45")	3x6-8 (45")	4x6-8 (45")	4x6-8 (45")	
LFMT		2x8-10 (45")	3x8-10 (45")	4x8-10 (45")	3x8-10 (45")	4x8-10 (45")	4x8-10 (45")	2x8-10 (45")	3x8-10 (45")	4x8-10 (45")	4x8-10 (45")	

Table 2. Training session design

Warm up	Verbal health examination (5 min) Jogging and stretching (5 min)
Throwing session	16 - 32 sets x 5 - 10 repetitions, 8 different throws, 45' rest interval, medicine ball weight 2 - 5 kg (45 min)
Cool down	Stretching (5 min)

*Statistical analysis.* Statistica for Windows (version 7.0) was used for statistical analysis. Means (m) standard deviation (sd), minimum (min) and maximum value (max), range (ran), skewness (skw) and kurtosis (kur) for each variable were calculated. MANOVA was used in order to determine pre-training and post-training differences between experimental and control group. In order to determine changes due to training program between two groups and each test separately, 2-way ANOVA for repeated measures was used. Time x group interaction was included in determination model.

## Results

The results of pre-training MANOVA showed no statistically significant differences between groups ( $P=0,099$ ) (Table 3). ANOVA for each variable showed significant differences only in (BMP) i (SJ) ( $P<0,05$ ). In order to equalize groups pre-training, ANCOVA and MANCOVA will be used. Table 3 also shows means and standard deviations.

Table 3. Means (m) and standard deviations (SD) of pre-training strength and power tests for control and experimental group

	Experimental group		Control group	
	m	sd	m	sd
SPRINT5 (s)	1,18	0,17	1,15	0,15
SPRINT10 (s)	1,89	0,20	1,86	0,13
SPRINT20 (s)	3,08	0,25	3,08	0,14
SMT (km/h)	24,25	4,13	22,89	1,50
HTS (km/h)	49,65	5,05	50,10	4,82
MT1 (km/h)	40,43	3,85	40,16	3,98
OMT (dm)	130,48	16,35	132,05	13,47
SJ (cm)	42,11	4,99	40,34	5,04
CMJ (cm)	45,62	5,14	44,82	6,02
SP15 (cm)	41,35	4,76	40,97	5,08
SP15 (W/kg)	25,74	3,32	25,36	3,39
BP (kg)	76,93	15,43	76,29	14,25

Table 4. Pre-training results of MANOVA and ANOVA for each test

Wilks' lambda	Rao's R	Effect df	Error df	p-level
0,877401	1,595	12	137	0,099719

	SS Effect	df Effect	MS Effect	F	p-level
SPRINT5	0,0332	1	0,0332	1,161	0,282905
SPRINT10	0,0291	1	0,0291	0,89	0,348226
SPRINT20	0,000	1	0,000	0,00	0,986532
SMT	67,18*	1	67,18*	5,909*	0,016243*
HTS	4,3	1	4,3	0,18	0,674656
MT1	6,1	1	6,1	0,41	0,522584
OMT	66	1	66	0,28	0,597464
SJ	105,8*	1	105,8*	4,198*	0,042206*
CMJ	18,1	1	18,1	0,596	0,441139
SP15 (cm)	2,2	1	2,2	0,09	0,760980
SP15 (W/kg)	4,03	1	4,03	0,357	0,550999
BP	15,9	1	15,9	0,070	0,791013

Legend: Wilks' lambda – multivariate F value based on error variance and effect variance comparison; Rao's R – Rao's F value; Effect df, Error df – degrees of freedom; p-level – level of difference significance; SS Effect – square sum between groups; df Effect – number of degrees of freedom between groups; MS Effect – SS Effect/df effect; F – MS Effect/MS Error

These results show that the alphabetical order of assigning subjects into groups did not contribute pre-training differences between experimental and control group and therefore further analysis of differences post-training could be performed.

Table 6 and 7 show post-training differences between groups. It is obvious that the experimental group subjects increased their results in some throwing tests, whereas control group showed increases in sprinting tests.

Table 5. Means (m) and standard deviations (sd) of post-training strength and power tests for control and experimental group

	Experimental group		Control group	
	m	sd	m	sd
SPRINT5 (s)	1,17	0,13	1,13	0,10
SPRINT10 (s)	1,91	0,14	1,88	0,11
SPRINT20 (s)	3,14	0,17	3,10	0,15
SMT (km/h)	23,98	1,96	23,06	1,64
HTS (km/h)	51,16	5,25	50,93	4,18
MT1 (km/h)	41,63	4,36	40,67	3,47
OMT (dm)	154,81	17,08	141,31	12,34
SJ (cm)	42,50	4,45	40,78	4,51
CMJ (cm)	45,27	5,18	44,50	4,53
SP15 (cm)	41,18	4,26	40,63	4,63
SP15 (W/kg)	24,72	3,08	24,39	3,13
BP (kg)	79,46	14,86	78,30	12,90

Table 6. Post-training results of MANOVA and ANOVA for each test

Wils' lambda	Rao's R	Effect df	Error df	p-level
0,706475	4,743	12	137	0,000002*

	SS Effect	df Effect	MS Effect	F	p-level
SPRINT5	0,0686*	1	0,0686*	4,72*	0,031434*
SPRINT10	0,0403	1	0,0403	2,23	0,137663
SPRINT20	0,077	1	0,077	2,73	0,100386
SMT (km/h)	30,69*	1	30,69*	8,91*	0,003304*
HTS (km/h)	2,4	1	2,4	0,10	0,750095
MT1 (km/h)	36,3	1	36,3	2,21	0,139234
OMT (dm)	6582*	1	6582*	27,67*	0,000000*
SJ	97,7*	1	97,7*	4,88*	0,028685*
CMJ	16,7	1	16,7	0,68	0,409794
SP15 (cm)	7,1	1	7,1	0,37	0,546015
SP15 (W/kg)	3,88	1	3,88	0,399	0,528448
BP	43,9	1	43,9	0,218	0,641327

Legend: Wilks' lambda – multivariate F value based on error variance and effect variance comparison; Rao's R – Rao's F value; Effect df, Error df – degrees of freedom; p-level – level of difference significance; SS Effect – square sum between groups; df Effect – number of degrees of freedom between groups; MS Effect – SS Effect/df effect; F – MS Effect/MS Error

The results of MANOVA (Table 6) show significant differences in post-training strength and power tests ( $P < 0.05$ ). ANOVA showed differences in four analysed variables: 5-metre sprint (SPRINT5), sitting chest medicine ball throw (BMP), overhead medicine ball throw (BMPG) and squat jump (SJ). Interestingly, 5-metre sprint results significantly increased but in favor of the control group.

*Interaction* between group and time between pre- and post-training results were determined by 2-way repeated measures ANOVA (2x2 ANOVA) for each variable (Table 7). MANOVA was used to determine the differences between groups pre- and post-training generally.

Table 7. The MANOVA results between groups and pre- and post-training

	Wilks' lambda	Df Effect	Df Error	F	p - level
GROUP	0,772471	12	134	3,29	0,000343
MEASUREMENT	0,290216	12	134	27,31	0,000000
MEASUREMENT x GROUP	0,740057*	12	134	3,92	0,000036*

MANOVA determined significant differences between groups between pre-training results and post-training results which are probably due to 10-week medicine ball throwing program. ANCOVA (univariate analysis of covariance) and mean pre- and post- training results of both groups allowed analysis of the real contribution of the experimental, 10-week medicine ball throwing program throwing program.

*Changes in sprint tests.* Table 8 shows mean values of sprint tests for experimental and control group pre- and post-training. Larger value in sprint variables represents inferior result of sprinting ability. Results suggest that both groups improved their sprinting abilities only in 5-metre sprint test, whereas lesser results were achieved in other two tests. Table 9 shows repeated measures ANOVA for 5-metre, 10-metre and 20-metre sprint tests.

Table 8. Means (M) and standrad deviations (SD) of sprint tests for experimental and control group pre- and post-training

	Pre-training		Post-training	
	Experimental group	Control group	Experimental group	Control group
	M ± SD	M ± SD	M ± SD	M ± SD
SPRINT5	1,18 ± 0,17	1,15 ± 0,15	1,17 ± 0,13	1,13 ± 0,10
SPRINT10	1,89 ± 0,20	1,86 ± 0,13	1,91 ± 0,14	1,88 ± 0,11
SPRINT20	3,08 ± 0,25	3,08 ± 0,14	3,14 ± 0,17	3,10 ± 0,15

Table 9. Sprint tests ANOVA results for repeated measurements

	df Effect	MS Effect	F	p-level
SPRINT5	1	0,003	0,16	0,688799
SPRINT10	1	0,000	0,02	0,884914
SPRINT20	1	0,037	1,43	0,233630

No significant between group and measurement interactions were determined for any of the sprint variables. Therefore, it can be concluded that the experimental training program had no effect on sprinting abilities.

*Changes in throwing tests.* Table 10 shows mean values of throwing tests for experimental and control group pre- and post-training for the experimental group. All throwing test results improved except sitting chest medicine ball throw. Overhead medicine ball throw test improvement was the greatest. Control group achieved improvements in all throwing tests. Table 11 shows repeated measures ANOVA for all throwing tests.

Table 10. Means (m) and standard deviations (sd) of throwing tests for experimental and control group pre- and post-training

	Pre-training		Post-training	
	Experimental group	Control group	Experimental group	Control group
	m ± sd	m ± sd	m ± sd	m ± sd
SMT (km/h)	24.25 ± 4.13	22.89 ± 1.50	23.98 ± 1.96	23.06 ± 1.64
HTS (km/h)	49.65 ± 5.05	50.10 ± 4.82	51.16 ± 5.25	50.93 ± 4.18
MT1 (km/h)	40.43 ± 3.85	40.16 ± 3.98	41.63 ± 4.36	40.67 ± 3.47
OMT (dm)	130.48 ± 16.35	132.05 ± 13.47	154.81 ± 17.08	141.31 ± 12.34

Table 11. Throwing tests ANOVA results for repeated measurements

	df Effect	MS Effect	F	p-level
SMT (km/h)	1	3,4	0,68	0,412247
HTS (km/h)	1	6,4	0,87	0,351591
MT1 (km/h)	1	6,3	0,99	0,320530
OMT (dm)	1	4042*	47,49*	0,000000*

ANOVA showed statistically significant differences based on between group and measurement interactions for overhead medicine ball throw variable (OMT). Great improvements in that variable largely contributed significant differences obtained in multivariate area. Most likely the cause for such improvement in OMT is the fact that testing procedure was the same movement pattern as one of the training exercise during experimental program. Improving the overhead throw technique largely contributed improvement in post-training results.

Such explanation corroborates the fact that this is the only variable with statistically significant improvement between two measurements. Importance of the experimental program is diminished by another finding – increased results in throwing tests for the control group.

*Changes in jumping tests.* Table 13 shows that the only improvement for the experimental group was found in squat jump test (SJ). A slight improvement in SJ only was also found for the control group. Table 13 shows repeated measures ANOVA for all jumping tests.

Table 12. Means (m) and standard deviations (sd) of jumping tests for experimental and control group pre- and post-training

	Pre-training		Post-training	
	Experimental group	Control group	Experimental group	Control group
	m ± sd	m ± sd	m ± sd	m ± sd
SJ	42,11 ± 4,99	40,34 ± 5,04	42,50 ± 4,45	40,78 ± 4,51
CMJ	45,62 ± 5,14	44,82 ± 6,02	45,27 ± 5,18	44,50 ± 4,53
SP15 (cm)	41,35 ± 4,76	40,97 ± 5,08	41,18 ± 4,26	40,63 ± 4,63
SP15 (W/kg)	25,74 ± 3,32	25,36 ± 3,39	24,72 ± 3,08	24,39 ± 3,13

Table 13. Jumping tests ANOVA results for repeated measurements

	df Effect	MS Effect	F	p-level
SJ	1	0,1	0,01	0,918571
CMJ	1	0,0	0,00	0,967015
SP15 (cm)	1	0,7	0,17	0,680389
SP15 (W/kg)	1	0,0	0,002	0,963082

ANOVA and ANCOVA for SJ variable showed insignificant changes as a result of the experimental medicine ball throwing program applied. Therefore, it can be assumed that such training program does not affect jumping abilities.

*Changes in maximum strength test.* Table 14 shows improvements in maximum strength test for experimental group, whereas the control group notes decrements. Table 15 reveals insignificant changes in strength under as a result of the experimental training program. However, different trend of development in control and experimental group suggests possible positive effects of the medicine ball training program. Future research dealing with medicine ball training effects should involve additional tests of maximum strength in order to determine its positive effects.

Table 14. Means (m) and standard deviations (sd) of maximum strength test for experimental and control group pre- and post-training

	Pre-training		Post-training	
	Experimental group	Control group	Experimental group	Control group
	m ± sd	m ± sd	m ± sd	m ± sd
BP	76,93 ± 15,43	76,29 ± 14,25	79,46 ± 14,86	78,30 ± 12,90

Table 15. Maximum strength test ANOVA results for repeated measurements

	df Effect	MS Effect	F	p-level
BP	1	17	1,465	0,227996

## Discussion and conclusions

The main purpose of this study was to determine whether medicine ball throwing training affects strength and power.

Up to this time, relatively few research dealing with ballistic medicine ball training and its effects on motor abilities, and therefore strength and power, has been conducted. Researches dealing with medicine ball training programs were mostly implemented in baseball training programs aiming at improvement of baseball players' speed abilities. Results of such studies confirmed positive effects of implemented programs but with small changes. However, regarding present finding suggested by recent research on power training (plyometric, sprint) programs, it can be assumed that ballistic training consisted of several types of medicine ball throws would yield positive changes, especially in power tests. If such findings were to be studied and confirmed, broader utilization of such programs would be expected.

These findings indicate no positive transformational effects regarding the majority of tests applied. Significant effects were noted only in overhead medicine ball throw (OMT) for the experimental group probably due to the fact that exact movement pattern was used as training exercise. Improving OMT technique definitely contributed significant result changes post-training for the experimental group.

Based on these findings it can be concluded that 10-week ballistic medicine ball training program, conducted 3 times per week and in duration of 60 minutes, cannot produce statistically significant effects on sprinting, jumping and throwing power neither on maximum strength.

## References

1. Bosco, C. (1992). *L' évaluation de la force par le test de Bosco*. Roma: Societa Stampa Sportiva.
2. Marković, G. (2004). Utjecaj skakačkog i sprinterskog treninga na kvantitativne i kvalitativne promjene u nekim motoričkim i morfološkim obilježjima. Doktorska disertacija. Kineziološki fakultet Sveučilišta u Zagrebu.
3. McEvoy, K.P., & Newton, R.U. (1998). Baseball throwing speed and base running speed: The effects of ballistic resistance training. *Journal of Strength and Conditioning Research*, 12: 216-221.
4. Newton, R.U., & McEvoy, K.P. (1994). Baseball throwing velocity: A comparison of medicine ball training and weight training. *Journal of Strength and Conditioning Research*, 8:198-203.
5. Szymanski, D.J., Szymanski, J.M., Bradford, T.J., Schade, R.L., & Pascoe, D.D. (2007). Effect of twelve weeks of medicine ball training on high school baseball players. *Journal of Strength and Conditioning Research*, 21(3): 894-901.



## DISCRIMINATION OF FUNCTIONAL CHARACTERISTICS BY USING THREE DIFFERENT DEVICES WITH TRAINING LOAD SETUP

Igor Jelaska, Marko Erceg and Boris Maleš

*Faculty of Kinesiology, University of Split, Croatia*

### Abstract

The purpose of this paper is to determine the differences between functional characteristics by using three different devices with training load setup by implementing a progressive exercise protocol until the exhaustion of female subjects. The research included the following variables: absolute maximal oxygen uptake, relative maximal oxygen uptake, maximum minute ventilation, maximum heart rate, and absolute oxygen uptake at the anaerobic threshold, relative oxygen uptake at the anaerobic threshold, minute ventilation at the anaerobic threshold and heart rate at the anaerobic threshold. The results of the comparative analysis show that the heart rate and oxygen uptake variables consistently discriminate successful female students from the less successful ones by each individual device.

**Key words:** *forward stepwise discriminant analysis, orbitrek elliptical trainer, bicycle ergometer, treadmill*

### Introduction

Spiroergometric tests and functional parameters obtained thereof, such as maximal oxygen uptake ( $VO_{2max}$ ), anaerobic threshold, ventilation and heart rate, have lately been used quite often to describe and evaluate physical adaptations to training (Loftin et al., 2004, Lafortuna et al. 2010). Among the devices with training load setup, the bicycle ergometer and the treadmill are used most often, although in the last few years sport and medical laboratories have been increasingly using specific ergometers for particular sports (rowing, kayak, swimming, cross-country skiing, etc.) which truly reproduce the dynamic movement stereotype specific for each sport. It is necessary to stress that the measured maximal values of oxygen uptake on a treadmill are higher by about 5-15% in comparison to the bicycle ergometer (Shephard, 1984, Loftin et al., 2004). Moreover, continuous exercise tests on bicycle ergometers and treadmills are primarily utilized today. Here the load is increased either by increasing the speed of the treadmill or by increasing the incline of the treadmill or by progressively increasing both the speed and the incline. The test is generally performed until the subject is exhausted unless there are contraindications or limiting factors (Rowland, 1996). In addition to the two standard devices with training load setup, the orbitrek elliptical trainer was also used in this research to measure the functional characteristics of female students. Until now, this device has not been used in sport scientific and professional studies as a measuring instrument. Despite the growing popularity of use of controlled exercise devices, recent scientific studies have not been based on the discrimination of functional characteristics, which is the primary objective of this research.

### Methods

The sample comprised 30 female students of the Department of Kinesiology at the University of Split, and they were tested on three different devices (orbitrek elliptical trainer, bicycle ergometer, treadmill). The research included the following variables: absolute maximal oxygen uptake ( $VO_{2max}$ ), relative maximal oxygen uptake ( $RVO_{2max}$ ), maximum minute ventilation ( $VE_{max}$ ), maximum heart rate ( $HR_{max}$ ), absolute oxygen uptake at the anaerobic threshold ( $VO_{2max}/AT$ ), relative oxygen uptake at the anaerobic threshold ( $RVO_{2max}/AT$ ), minute ventilation at the anaerobic threshold ( $VE/AT$ ) and heart rate at the anaerobic threshold ( $HR/AT$ ).

A progressive exercise protocol was also implemented in accordance with the measured variables until the exhaustion of the female subjects. Firstly, all variables were subjected to the testing of distribution normality in all measurements by using a KS test and the following descriptive statistical parameters were calculated: arithmetic mean, minimal result, maximal result, standard deviation, skewness and kurtosis coefficients. The correlation coefficients between variables from different measurements were also calculated. Moreover, the z-score was calculated for every variable obtained in all three measurements, thus getting an average result of each entity in all variables. After the female students have been ranked by the average z-score, relatively homogenous taxons of female students – successful ( $G_1$ ) and less successful ( $G_2$ ) – were generated. Accordingly, a forward stepwise discriminant analysis was conducted for each of the measurements, and the structure of the discriminant root and the related eigenvalue, the Wilks' lambda, the canonical correlation coefficient, the significance level, the chi-square test value and the group centroid projection were calculated.

## Results

The KS test demonstrated that all variables on all devices followed normal distribution which corresponded to the measured values of the skewness and kurtosis coefficients. By analysing the obtained descriptive statistical parameters, it may be noted that the highest numerical values were recorded on the treadmill, followed by the orbitrek elliptical trainer, and finally the bicycle ergometer (Tables 1, 2 and 3).

Table 1. Descriptive statistical parameters for measurements on the orbitrek elliptical trainer (AM – arithmetic mean, Min – minimal result, Max – maximal result,  $\sigma$  – standard deviation,  $\alpha_3$  – skewness coefficient,  $\alpha_4$  – kurtosis coefficient)

	AM	Min	Max	$\sigma$	$\alpha_3$	$\alpha_4$
VO2 <sub>max</sub>	2.59	1.72	3.36	0.50	-0.16	-1.30
RVO2 <sub>max</sub>	42.66	30.72	57.62	7.16	0.07	-0.90
VE <sub>max</sub>	85.96	59.50	123.40	15.81	0.36	-0.16
HR <sub>max</sub>	186.27	175.00	202.00	6.60	0.62	0.12
VO2 <sub>max</sub> /AT	1.95	1.26	2.80	0.42	0.14	-0.91
RVO2 <sub>max</sub> /AT	32.12	22.44	44.62	5.50	0.36	-0.53
VE/AT	49.73	31.80	72.60	11.64	0.21	-0.77
HR/AT	164.63	147.00	181.00	7.96	-0.02	-0.01

Table 2. Descriptive statistical parameters for measurements on the bicycle ergometer (AM – arithmetic mean, Min – minimal result, Max – maximal result,  $\sigma$  – standard deviation,  $\alpha_3$  – skewness coefficient,  $\alpha_4$  – kurtosis coefficient)

	AM	Min	Max	$\sigma$	$\alpha_3$	$\alpha_4$
VO2 <sub>max</sub>	2.42	1.45	3.44	0.45	0.02	0.05
RVO2 <sub>max</sub>	39.47	29.62	53.74	6.03	0.93	0.64
VE <sub>max</sub>	82.18	48.20	124.10	19.81	0.47	-0.48
HR <sub>max</sub>	180.37	169.00	191.00	5.59	-0.36	-0.27
VO2 <sub>max</sub> /AT	1.67	1.05	2.34	0.32	0.10	-0.30
RVO2 <sub>max</sub> /AT	27.27	20.66	35.20	3.99	0.29	-0.69
VE/AT	43.48	25.70	64.90	8.76	0.20	0.13
HR/AT	152.87	135.00	166.00	6.91	-0.31	0.17

Table 3. Descriptive statistical parameters for measurements on the treadmill (AM – arithmetic mean, Min – minimal result, Max – maximal result,  $\sigma$  – standard deviation,  $\alpha_3$  – skewness coefficient,  $\alpha_4$  – kurtosis coefficient)

	AM	Min	Max	$\sigma$	$\alpha_3$	$\alpha_4$
VO2 <sub>max</sub>	2.84	1.95	3.88	0.46	-0.27	0.00
RVO2 <sub>max</sub>	46.68	34.35	64.66	6.66	0.74	0.73
VE <sub>max</sub>	98.82	54.10	127.10	17.26	0.03	0.44
HR <sub>max</sub>	185.23	176.00	196.00	4.49	-0.35	0.41
VO2 <sub>max</sub> /AT	2.16	1.46	2.91	0.35	0.037	0.47
RVO2 <sub>max</sub> /AT	35.49	27.71	45.56	4.42	0.54	0.03
VE/AT	59.72	43.80	80.80	10.36	0.57	-0.31
HR/AT	168.53	157.00	178.00	5.92	-0.05	-0.87

Table 4 shows correlation coefficients between subjects tested on different devices.

Table 4. Correlation coefficients between results of subjects by devices

	1 vs 2	2 vs 3	1 vs 3
VO2 <sub>max</sub>	0.77*	0.71*	0.67*
RVO2 <sub>max</sub>	0.68*	0.77*	0.58*
VE <sub>max</sub>	0.45*	0.71*	0.66
HR <sub>max</sub>	0.52*	0.58	0.55*
VO2 <sub>max</sub> /AT	0.73*	0.52*	0.58*
RVO2 <sub>max</sub> /AT	0.58*	0.56*	0.45*
VE/AT	0.66*	0.54*	0.49*
HR/AT	0.54	0.60*	0.62*

\* Statistically significant coefficients p&lt;0.05

The z-score was calculated for all obtained variables in all three measurements. By using the formula:

$$z_{uk}^i = \frac{\sum_{j=1}^8 z_{i,j}}{8} \quad i = 1, 2, 3,$$

we found the average result of each  $i$  entity in all variables, thereby enabling the generation of two relatively homogenous taxons of female students – successful and less successful. Accordingly, two grouping variables were derived for the forward stepwise discriminant analysis for every single device. Moreover, the forward stepwise discriminant analysis was conducted for each measurement, and the results are shown in Table 5.

Table 5. Structure of discriminant functions: DF<sub>1</sub> – orbitrek elliptical trainer, DF<sub>2</sub> – bicycle ergometer, DF<sub>3</sub> – treadmill, Beta – beta coefficients of discriminant functions, FSM – correlation coefficients of variable with discriminant function, G<sub>1,2</sub> – corresponding centroid projections

	DF <sub>1</sub>		DF <sub>2</sub>		DF <sub>3</sub>	
	Beta	FSM	Beta	FSM	Beta	FSM
VO2 <sub>max</sub>	0.60	0.66				
RVO2 <sub>max</sub>	0.56	0.22				
VE <sub>max</sub>						
HR <sub>max</sub>	0.45	0.52	0.69	0.72	0.91	0.77
VO2 <sub>max</sub> /AT			0.79	0.11	0.05	0.75
RVO2 <sub>max</sub> /AT			0.50	0.71	0.76	0.12
VE/AT	0.36	0.15			0.53	0.69
HR/AT	0.63	0.28			0.77	0.08
G <sub>1</sub>	2.04		1.62		1.27	
G <sub>2</sub>	-2.04		-1.62		-1.27	

Table 6. Testing the significance of discriminant functions (Eigenval – eigenvalue, CanR – canonical correlation coefficient, Wλ – Wilks' lambda, χ<sup>2</sup> – chi-square test value, df – number of degrees of freedom, ReClass – percentage of successful (re)classification of cases, p – significance level)

	Eigenval	CanR	Wλ	χ <sup>2</sup>	df	ReClass	p
DF <sub>1</sub>	4.46	0.90	0.18	43.29	5	96,7%	0.00
DF <sub>2</sub>	2.80	0.86	0.26	35.41	3	96,7%	0.00
DF <sub>3</sub>	1.74	0.80	0.36	25.72	5	90,0%	0.00

It should be pointed out that the different values of the degrees of freedom result from the use of the forward stepwise algorithm in choosing the discriminant model on every single device.

## Discussion and conclusions

Given that two groups of entities were discriminated, it should be observed that a single 100% reliable discriminant function was generated for each device. Tables 1, 2 and 3 clearly demonstrate that often the local, and not the general muscular endurance limits the reach in the test on the bicycle ergometer due to a lower active muscle mass ratio. Additionally, the treadmill has an advantage over the bicycle ergometer and other ergometers due to the possibilities of natural forms of locomotion – walking and running. Also, the measured maximal oxygen uptake values are higher by approximately 5 - 15% compared to the bicycle ergometer (Shephard, 1984, Loftin et al., 2004). Accordingly, it can be seen that the orbitrek elliptical trainer also allows for the use of more muscle groups than the bicycle ergometer because the muscle groups of the arms, the shoulder girdle and the torso are additionally activated unlike the bicycle ergometer, which corresponds to the results of the research. We may become aware of the compatibility of the results among individual devices (Table 4), i.e. that the results achieved on the devices consistently describe the area of the functional characteristics of the female subjects (Jelaska, Erceg and Maleš, 2011).

The analysis of descriptive parameters (Tables 1, 2 and 3) clearly shows that the heart rate and the oxygen uptake values recorded on the treadmill and the orbitrek elliptical trainer are similar, and that they are somewhat lower on the bicycle ergometer, which is in accordance with former studies (Loftin et al., 2004). The exercise test on the orbitrek elliptical trainer was a bit longer so the oxygen uptake values were a bit lower than on the treadmill, which was also confirmed in previous studies (Barros et al., 1999). This was probably due to dehydration, increased body temperature, muscle discomfort or the decrease in motivation. With regard to the bicycle ergometer, it is often the local, and not the general muscular endurance which limits the reach in the test due to a lower active muscle mass ratio. This was also the case in the conducted research. As was already mentioned, the exercise lasted a bit longer on the orbitrek elliptical trainer than the bicycle ergometer and the treadmill because the female subjects did not reach the maximal oxygen uptake level until the end of the exercise. The exercise on the orbitrek elliptical trainer device was finely, gradually and progressively programmed so that the aerobic component itself is a significant discrimination indicator as opposed to the others. It is precisely for this reason that the variables of oxygen uptake on the anaerobic threshold better discriminate (Tables 5, 6) the female subjects on the treadmill and the bicycle ergometer because said values are a better indicator of the level of fitness than the absolute and relative oxygen uptake values where the anaerobic components of fitness, in addition to the aerobic one, is quite significant as well.

Table 5 reveals that forward stepwise algorithmic selection of variables into the discriminant model has eliminated 3 variables from  $DF_1$ , 5 variables from  $DF_2$  and 3 variables from  $DF_3$  as not significant enough. Also through table 5 we have insight into the structure of discriminant function through beta coefficients of discriminant function and correlations of selected variables with discriminant function. As it was expected, due to positive values of centroid projections of more successful students on all devices, all calculated values of correlation coefficients are positive. Biggest value of correlation coefficient with  $DF_3$  have variable  $HR_{max}$  (0,77) and high value is not exception, due to the fact that two more correlation coefficients values ( $VEO_{2max}/AT$  and  $VE/AT$ ) are relatively near. Also it has to be noted that also variable  $HR_{max}$  have biggest correlation coefficient with  $DF_2$  (0,72) so we can see that this variable consistently discriminates, on all three devices, given groups of female students.

Furthermore, it can be seen that the structure of the discriminant function is bipolar and that through various effects the discriminant variables make a positive contribution to the discrimination of successful students on consecutively the orbitrek elliptical trainer, the bicycle ergometer and the treadmill, which is in line with the high correlation coefficients (0,90, 0,86 and 0,80) and low Wilks' lambda values (0,18, 0,26 and 0,36). As it can be seen in table 6, the validity of discriminant function was also tested by calculating a percentage of successful reclassifications of cases by using discriminant function. Given successful reclassification percentage is very high – 96,7% for orbitrek elliptical trainer, 96,7% for bicycle ergometer and 90,0% for treadmill device and results can be also interpreted as the proof of quality of chosen research model.

In conclusion, although the application of controlled exercise devices in scientific and professional practice is on the rise, it is insufficiently studied. Therefore, future studies of this type should be based on the homogenous samples of top athletes and the given results would probably be of key importance for training planning and control.

## References

1. Barros Neto, T.L., Cesar, M.C. & Tambeiro, V.L. (1999). Avaliacao da aptidao cardiorrespiratoria. In: Ghorayeb, N., Barros Neto, T. O Exercício: Preparacao Fisiologica, Avaliacao Medica, Aspectos Especiais e Preventivos. Sao Paulo, Atheneu, 15-24.
2. Jelaska, I., Erceg, M. & Maleš, B. (2011). Povezanost ranga na različitim spravama za dozirano opterećenje i ranga trčanja na 800 metara. (Relation between the Ranking on Different Controlled Exercise Devices and the Ranking in an 800-m Run). Collected papers of the 4<sup>th</sup> International Symposium of New Technologies in Sports, Sarajevo 2011 (in print).
3. Loftin, M., Sothorn, M., Warren, B. & Udall, J. (2004). Comparison of VO<sub>2</sub> peak during treadmill and cycle ergometry in severely overweight youth. *Journal of Sports Science and Medicine*, 3, 254-260.
4. Lafortuna, C.L., Lazzer, S., Agosti, F., Busti, C., Galli, R., Mazzilli, G. & Sartorio, A. (2010). Metabolic responses to submaximal treadmill walking and cycle ergometer pedalling in obese adolescents, *Scandinavian Journal of Medicine and Science in Sports*, 20(4), 630-637.
5. Shephard, R.J. (1984). Tests of maximum oxygen intake: a critical review. *Sports Medicine*, 1, 99-124.

The article was written within the scientific project no. 315-1773397-3332 (Laboratory Measuring Instruments in Kinesiology), supported by the Ministry of Science, Education and Sports of the Republic of Croatia.

## HEART RATE RECOVERY AFTER A GRADED EXERCISE TEST IN SPRINTERS, MIDDLE DISTANCE, LONG DISTANCE AND 400 METER RUNNERS

Vlatko Vučetić<sup>1</sup> and Tomislav Dokman<sup>2</sup>

<sup>1</sup>Faculty of Kinesiology, University of Zagreb, Croatia

<sup>2</sup>Armed Forces of the Republic of Croatia

### Abstract

This study tested the heart rate recovery in sprinters (S), middle distance runners (MD), long distance (LD), and 400m runners (S4) after performed an incremental treadmill test (1 km/h speed increase per minute, 1.5% grade) to volitional exhausting, and walked at 5 km•h<sup>-1</sup> during the first five minutes of recovery. Data were analyzed during five minutes of post exercise recovery in 10s interval and compared between the different national level male running groups. The long distance group (LD) had lower maximum heart rate (HR max)  $187.1 \pm 7.4$  and faster postexercise recovery of % HRR max. The 400m runners (S4) had highest heart rate (HRmax)  $200.6 \pm 6.8$  and slower heart rate recovery (HRR) and recovery of %HRRmax. The heart rate recovery (HRR) was fastest in long distance runners (LD), while 400m runners (S4) had the slowest heart rate recovery. Repeated measures of ANOVA showed that long distance group (LD) had lower heart rate (HR) than other running groups during intervals of recovery. These results suggest that athletes competing in running events with predominantly aerobic metabolic demands are likely to have lower maximum heart rate (HRmax) and faster heart rate recovery HRR during the first five minutes after a grade exercise treadmill test than runners competing in events with predominantly anaerobic metabolic demands.

**Key words:** treadmill, anaerobic, athletes, recovery, aerobic

### Introduction

Heart rate (HR) is the one of the most usable physiological variables in applied condition (Achten and Jeukendrup 2003). Heart rate (HR) monitoring was ranked as a moderate and objective method for the assessment of physical activity (Westerterp, 2009). Heart rate recovery (HRR) is the rate at which HR decreases (or the time taken for HR to recover) after exercise and is dependent on the relationship between parasympathetic and sympathetic nervous activity (Boresen and Lambert, 2008). Aerobic capacity and endurance performance can be increased by both continuous and high-intensity interval endurance training (Astrand et al., 2003). Previous cross-sectional (Darr et al., 1988; Imai et al., 1994; Preini et al., 2006) and longitudinal studies (Hagberg et al., 1980; Sugawara et al., 2001; Yamamoto et al., 2001) have showed that heart rate recovery (HRR) is accelerated in endurance-trained subjects with elevated aerobic capacity. Some studies have shown that heart rate recovery is also related to VO<sub>2</sub>max (Darr et al., 1988; Du et al., 2005). In these studies, faster heart rate recovery (HRR) was observed in athletes with higher VO<sub>2</sub>max than non-athletes. Furthermore some factors such as age, exercise habit, and cardiac vagal activity which affect VO<sub>2</sub>max are also associated with HRR. Although the mechanisms behind endurance training-induced changes in HRR are still not fully understood, these results suggest that post-exercise HRR could be a useful marker of training-induced changes in autonomic control (Borresen and Lambert, 2008). Absolute and relative reliability of HR may vary according to the duration of recovery and the way to quantify heart rate (Bosquet et al., 2008). HR increase during exercise in response to a combination of sympathetic activation and parasympathetic withdrawal with the reverse occurring during the recovery (Kannankeril and Goldberger, 2002). Short term HRR during the first minute of recovery is lower after high-intensity and intermitten exercise sessions compared to continuous exercise sessions, suggesting that changes in post-exercise autonomic function are modality specific (Buchheit et al., 2007a, 2009). Intermittent athletes have faster heart rate recovery after maximal exercise than the athletes engaged in continuous endurance sports (Ostojic et al., 2009). Data regarding HRR were analyzed within five minutes after graded exercise test, averaged and analyzed at 10 sec intervals which could be good indicators in programming training for aerobic and anaerobic athletes. The main aim of this study was to examine the influence of athletes with predominantly aerobic metabolic demands versus athletes with anaerobic metabolic demands on HR response during 10 second intervals for the first five minute of recovery after maximal exercise. We hypothesized that athletes participating in continuous running events would exhibit a faster HRR during recovery following maximal exercise than sprinters and 400m runners.

## Methods

**Subjects.** Forty-eight national level male runners, competing in different running events: 10 sprinters (S) ( $184.9 \pm 4.8$  cm,  $76.6 \pm 4.8$  kg), fourteen 400m runners (S4) ( $180.9 \pm 4.2$  cm,  $73.0 \pm 6.3$  kg), 11 middle distance (MD) ( $180.4 \pm 5.7$  cm,  $68.6 \pm 6.2$  kg) and 13 long distance (LD) ( $179.1 \pm 6.7$  cm,  $69.5 \pm 7.0$  kg) runners participated in the study. The participants were classified into four groups based on their running events. All subjects were fully informed verbally and in writing about the nature and demands of the study as well as the known health risk. All subjects performed an incremental treadmill test (1 km/h speed increase per minute, 1.5% grade) to volitional exhausting, and walked at 5 km•h<sup>-1</sup> during the first five minutes of recovery. Heart rate, as well as breath-by breath gas exchange data were averaged and analyzed at 10 sec intervals. The data were presented in absolute (HRR) and relative (%HRR max) heart rate values. Descriptive data expressed as means  $\pm$  SD. The training background on HRR at 10 sec intervals was analyzed by means one-way ANOVA analysis of variance between four group (S, S4, MD and LD).

**Experimental procedures.** All procedures were performed in accordance with the Declaration of Helsinki. The study was approved by the Ethics Committee of the Faculty of Kinesiology, University of Zagreb. Subjects were admitted in the study if they had a minimum training age of 3yr, engaged in strenuous training at least 10 h per week and were currently active in competition. Each runner had previous experience of treadmill running and testing. After warm-up and stretching, based upon the subject's habits, one of incremental protocols on a calibrated treadmill (Run Race 900, Tehnogym, Italy) with 1.5% inclination was applied. Body mass was assessed to the nearest 0.1 kg using beam balance scale with the athletes wearing minimal clothing. Body height was assessed to the nearest 0.1 cm using portable stadiometer. The stadiometer and scale were calibrated periodically during the study. Expired gas was sampled continuously and O<sub>2</sub> and CO<sub>2</sub> concentration in expired gas were determined using stable and fast Zirconium Oxygen and NDIR Carbon Dioxide analyzers (breath-by-breath gas exchange system Quark b<sup>2</sup>, COSMED, Italy) which were calibrated prior to and following each test using precision reference gases. The system was calibrated before each test using gases of known concentrations. Heart rate (HR) was collected continuously during the tests using telemetric heart rate monitor (Polar Electro, Kempele, Finland), and stored in PC memory. The testing was performed in morning hours (between 9 a.m. and 11 a.m.) in thermo-neutral conditions. Expired airflow was measured with digital turbine flow meter (COSMED, Italy), which was calibrated prior to and following each test using a 3 l syringe at flow rate and volumes in the expected physiological range. Temperature and humidity of expired gas were measured using a rapidly-responding sensor (Quark b<sub>2</sub>, COSMED, Italy).

## Results

The HRmax ( $187.1 \pm 7.4$ ;  $197 \pm 7.1$ ;  $200.6 \pm 6.8$  and  $195 \pm 5.7$  bpm for long distance (LD), middle distance (MD), 400m runners (S4) and sprinters (S), respectively), as well as heart rate recovery (HRR) and %HRRmax at each 10 sec interval throughout recovery were lowest in the long distance group (LD) ( $p < 0.01$ ). The heart rate recovery (HRR) was fastest in long distance group (LD) and middle distance runners (MD) (expressed in bpm), while sprinters (S4) had the slowest heart rate recovery (expressed in %HRRmax and HR bpm). Ten (10) sec intervals were analyzed by one-way ANOVA, between groups (S, S4, MD and LD) in HRR and %HRmax, where statistical significant found at  $p < 0.01$  and  $p < 0.05$ . Biggest difference between groups in HR recovery, analyzed with post-hoc Bonferoni at level  $p < 0.01$  was found between 80 -100 sec and 120-180 second of recovery.

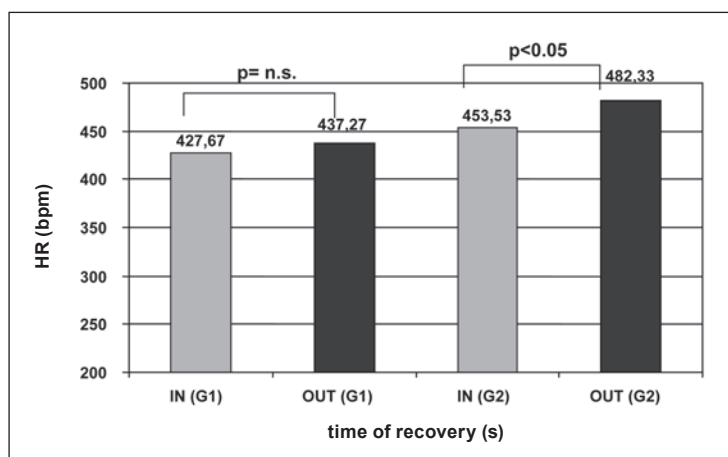

Figure 1. Change in heart rate recovery (HRR) within five minutes of recovery.

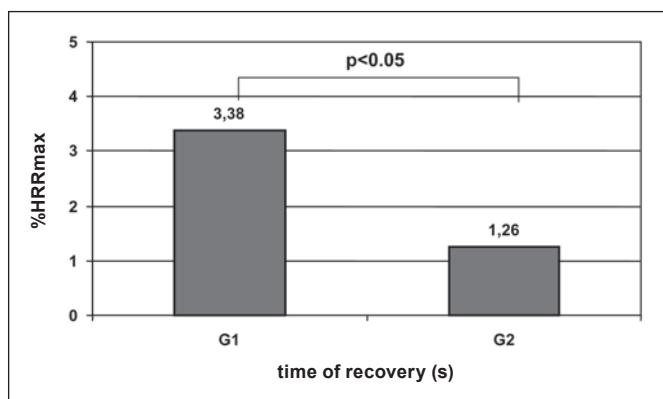

Figure 2. Post-exercise recovery of %HRRmax. Start of post-exercise period was denoted as 100% of HRRmax recovery, and value proceeded toward lower % recovery of HR.

Table 1. Heart rate (HR) in athletes from sprinters (S), 400m runners (S4), middle distance (MD) and long distance runners (LD) recorded after graded exercise test

	S (n=10)	S4 (n=14)	MD (n=11)	LD (n=13)	p-value	Post hoc
HRR at 10	191±11	197±11	194±7	185±7	0.027	*
HRR at 20	190±8	198±8	186±19	183±8	0.014	*
HRR at 30	188±6	195±8	184±16	179±6	0.001	**
HRR at 40	184±7	190±9	180±15	173±8	0.002	**
HRR at 50	180±8	188±7	176±16	166±9	0.000	&, **, π
HRR at 60	170±20	181±11	171±15	158±8	0.001	**
HRR at 70	167±19	174±22	168±13	150±10	0.008	**
HRR at 80	167±7	173±15	164±13	144±11	0.000	#
HRR at 90	164±7	170±14	159±14	139±11	0.000	#
HRR at 100	160±7	165±14	155±15	135±11	0.000	#
HRR at 110	151±19	161±14	152±16	131±11	0.000	\$, &
HRR at 120	150±13	158±15	149±15	127±11	0.000	#
HRR at 130	149±8	154±15	145±15	124±11	0.000	#
HRR at 140	147±8	152±12	142±15	122±12	0.000	#
HRR at 150	145±8	151±12	140±15	120±11	0.000	#
HRR at 160	142±8	149±12	137±16	118±11	0.000	#
HRR at 170	142±8	146±11	136±17	116±11	0.000	#
HRR at 180	139±9	143±12	134±17	115±12	0.000	#
HRR at 190	138±9	141±12	133±16	115±11	0.000	\$\$, ##
HRR at 200	137±9	143±11	131±15	115±11	0.000	\$\$, ##
HRR at 210	136±9	143±11	130±16	114±10	0.000	\$\$, ##
HRR at 220	135±9	141±10	129±17	113±10	0.000	\$\$, ##
HRR at 230	133±9	139±10	129±17	113±10	0.000	\$\$, ##
HRR at 240	132±11	138±10	127±19	113±10	0.000	\$\$
HRR at 250	130±12	137±10	127±19	111±12	0.000	*, £
HRR at 260	129±13	136±11	126±19	111±11	0.000	**, £
HRR at 270	131±11	135±12	125±21	111±11	0.000	**, £
HRR at 280	130±10	136±10	124±21	109±11	0.000	\$\$
HRR at 290	128±11	136±11	124±18	109±12	0.000	\$\$
HRR at 300	127±12	135±11	123±17	109±10	0.000	£, **

Values are means ± SD – standard deviation; \*-significant LD:S4 p<0.05; \*\*-significant LD:S4 p<0.01; #-significant LD:S:S4:MD p<0.01; \$-significant LD:S4:MD p<0.01; &-significant LD:S p<0.05; \$\$-significant LD:S:S4 p<0.01; ##-significant LD:MD p<0.05; £- significant LD:S p<0.05; π-significant MD:S4 p<0.05.



Table 2. Heart rate (expressed as percent of maximal exercise heart rate, %HRmax) in athletes from sprinters (S), 400m runners (S4), middle distance (MD) and long distance runners (LD) recorded after graded exercise test

	S (n=10)	S4 (n=14)	MD (n=11)	LD (n=13)	p-value	Post hoc
%HR max 10	98,1±4	98,3±3.9	98,5±1.6	99,2±0.7	0.793	
%HR max 20	97,8±2.4	98,8±1.5	94,5±8.2	97,8±1.0	0.085	
%HRR max 30	96,7±1.4	97,2±1.8	93,5±6.1	95,7±1.7	0.043	*
%HR max 40	94,3±1.9	94,7±3.5	91,3±5.8	92,8±2.5	0.134	
%HR max 50	92,5±2	93,8±2	89,3±6.1	88,6±3.3	0.002	*, #
%HR max 60	87,3±9.3	90,2±4.24	86,8±5.7	84,4±3.8	0.099	
%HR max 70	85,5±8.7	86,9±10.8	85,1±4.8	80,6±4.9	0.211	
%HR max 80	85,7±2	86,3±7.2	83,3±5.1	77,2±5.6	0.000	**
%HR max 90	84,2±2.8	84,7±6.2	80,9±5.8	74,5±5.4	0.000	**,\$
%HR max 100	82,1±2.9	82,6±6.3	78,8±6.4	72,3±5.3	0.000	**,\$
%HR max 110	77,5±9	80,4±6.5	77,2±6.6	70,1±5.5	0.003	#
%HR max 120	77,1±5.7	78,7±6.9	75,7±6.4	68,0±5.5	0.000	**,\$
%HR max 130	76,8±3.4	76,8±6.9	73,7±6.6	66,6±5.2	0.000	**,\$
%HR max 140	75,7±3.5	75,9±5	72,1±6.4	65,3±5.3	0.000	**,\$
%HR max 150	74,4±3.6	75,1±4.7	71,1±6.5	64,10±5.1	0.000	**,\$
%HR max 160	73,2±3.5	74,3±4.7	69,8±6.5	63,0±5.1	0.000	**,\$
%HR max 170	72,8±3.8	73,0±4.3	68,9±7.1	62,3±5.1	0.000	**,\$
%HR max 180	71,5±3.9	71,3±4.7	68,2±7.5	61,3±5.7	0.000	**,\$
%HR max 190	70,9±4	70,5±4.7	67,3±7.1	61,5±4.9	0.000	**
%HR max 200	70,6±3.6	71,2±4.2	66,7±6.6	61,4±5.0	0.000	**
%HR max 210	70,1±3.6	71,2±4.1	65,8±7.1	61,2±4.4	0.000	**
%HR max 220	69,1±3.7	70,6±3.9	65,7±7.4	60,5±4.3	0.000	**
%HR max 230	68,3±3.8	69,6±3.9	65,5±7.6	60,4±4.4	0.000	**
%HR max 240	67,6±4.1	69,0±4.1	64,6±8.3	60,3±4.4	0.001	£, #
%HR max 250	66,8±4.9	68,6±3.9	64,4±8.8	59,6±5.1	0.002	£, #
%HR max 260	66,1±5.1	67,8±4.5	63,9±8.8	59,3±4.7	0.005	#
%HR max 270	67,1±4.1	67,3±5.2	63,3±9.8	59,4±4.6	0.008	£, €
%HR max 280	66,5±3.9	67,9±4	62,8±10	58,6±4.6	0.001	£, #
%HR max 290	65,8±4.1	67,7±4.2	63,0±8.1	58,3±5.2	0.000	£, #
%HR max 300	65,3±4.4	67,3±4.4	62,4±7.7	58,3±4.1	0.000	€, #

Values are means ± SD – standard deviation; \*-significant MD:S4 p<0.05; #-significant LD:S4 p<0.01; \*\*-significant LD:S:S4 p<0.01; \$-significant LD:MD p<0.05; £-significant LD:S p<0.05; €-significant LD:S4 p<0.05.

## Discussion and conclusions

Heart rate is known to decrease and likely reflect both sympathetic withdrawal and parasympathetic reactivation (Imai et al., 1994). Increased vagal activity associated with a faster HRR has been shown to be associated with a decrease in risk of death (Hull et al., 1995). After high levels of exercise during which sympathetic stimulation dominates, the sympathetic drive may continue well into the recovery phase and contribute to sustained tachycardia despite the reactivation of the parasympathetic system (Pierpont et al., 2000). This would alter or delay the first order exponential decay that can be applied to heart rate recovery (Pierpont et al., 2000). Heart rate recovery is usually quantified by taking the absolute difference between the final HR at exercise completion and HR recorded following 60 s of recovery or by analyzing the first 30 s of HRR (Buchheit et al., 2007b). Already Monod highlighted some of the factor that can affect heart rate measurements like; digestion, temperature, noise, infections and pharmacological or non-pharmacological substances known to influence the autonomic nervous system. It is presumed that the recovery in HR after maximal exercise is mediated by intrinsic, neural and humoral factors (Savin et al., 1982, Darr et al., 1988, Arai et al., 1989.) Furthermore, Lamberts et al. (2009a, b) demonstrated that HRR is a sensitive marker which tracks changes in training status of endurance athletes. Athletes engaged in intermittent endurance sport are likely to have faster HRR at 10 and 20 s after maximal exercise than the athletes engaged in continuous endurance sports (Ostojic et al., 2009). The recovery in HR after high intensity exercise was faster in those individuals who had a higher aerobic capacity (Darr et al., 1988). The

present study analyzed the differences in HRR within five minutes, averaged and analyzed at 10 sec interval between athletes competing in running events with predominantly aerobic metabolic demands and runners competing in events with predominantly anaerobic metabolic demands. Among the athletes of different metabolic demands, those engaged in continuous endurance sports like LD and MD runners have faster HRR after maximal exercise than the sprinters. Longitudinal studies have shown that both continuous and interval endurance training short-term HRR (Buchheit et al. 2008; Hagberg et al. 1980; Lamberts et al. (2009b).

The results suggest the athletes competing in running events with predominantly aerobic metabolic demands are likely to have faster heart rate recovery after graded exercise treadmill test than runners competing in events with predominantly anaerobic metabolic demands. Our results in combination with findings Ota's (2002) and Singh's et al. (2008) demonstrate that exercise endurance capacity is linearly related to heart rate recovery (HRR). The present study also demonstrate that the aerobic capacity is moderately, but significantly correlated with the kinetics of heart rate recovery which could be of particular interest for athletes and experts involved in the process of physical preparation and athletic training.

## References

1. Achten, J., Jeukendrup, A.E. (2003). Heart rate monitoring: Applications and limitations. *Sports Medicine*, 33 (7), 517-538.
2. Arai, Y., Saul, J.P., Albrecht, P., Hartley, L.H., Lilly, L.S., Cohen, R.J., Colucci, W.S. (1989). Modulation of cardiac autonomic activity during and immediately after exercise. *Am J Physiol* 256:H132-141.
3. Astrand P-O., Rodahl, K., Dahl, H.A., Strome, S.B. (2003). Textbook of work physiology, 4th edn. Human Kinetics, Champaign, IL.
4. Boreresen, J., Lambert, M.I. (2008). Autonomic control of heart rate during and after exercise: measurement and implications for monitoring training status. *Sports Med* 38:633-646.
5. Bosquet, L., Gamelin, F.X., Berthoin, S. (2008). Reliability of postexercise heart rate recovery. *Int J Sports Medicine*, 29, 238-243.
6. Buchheit M, Laursen PB, Ahmaidi S (2007a) Parasympathetic reactivation after repeated sprint exercise. *Am J Physiol Heart Circ Physiol* 293:H133-H141.
7. Buchheit, M., Al Haddad, H., Millet, G.P., Lepretre, P.M., Newton, M., Ahmaidi, S. (2009). Cardiorespiratory and cardiac autonomic responses to 30-15 intermittent fitness test in team sport players. *J Strength Cond Res* 23:93-100.
8. Buchheit, M., Papelier, Y., Laursen, P.B., Ahmaidi, S. (2007b). Noninvasive assessment of cardiac parasympathetic function: postexercise heart rate recovery or heart rate variability? *AM J Physiol Heart Circ Physiol* 293:H8-H10.
9. Buchheit, M., Millet, G.P., Parisy, A., Pourchez, S., Lause, P.B., Ahmaidi, S. (2008). Supramaximal training and postexercise parasympathetic reactivation in adolescents. *Med Sci Sports Exerc* 40:362-371.
10. Darr, K.C., Basset, D.R., Morgan, B.J., Thomas, D.P. (1988). Effect of age and training status on heart rate recovery after peak exercise. *Am J Physiol* 254:H340-H343.
11. Du, N., Bai, S., Oguri, K., Kato, Y., Matsumoto, I., Kawase, H., et al. (2005). Heart rate recovery after exercise and neural regulation of heart rate variability in 30-40 year old female marathon runners. *J Sports Sci Med*, 4:9-17.
12. Hagberg, J.M, Hickson, R.C., Ehsani, A.A., Holloszy, J.O. (1980). Faster adjustment to and recovery from submaximal exercise in the trained state. *J Appl Physiol* 48:218-224.
13. Hull, S.S., Vanoli, E., Adamson, P.B., De Ferrari, G.M., Foreman, R.D., Schwartz, P.J. (1995). Do increases in markers of vagal activity imply protection from sudden death? The case of scopolamine. *Circulation* 91:2516-2519.
14. Imai, K., Sato, H., Hori, M., Kusuoka, H., Ozaki, H., Yokoyama, H., Takeda, H., Inoue, M., Kamada, T. (1994). Vagally mediated heart rate recovery after exercise is accelerated in athletes but blunted in patients with chronic heart failure. *J Am Coll Cardiol* 24:1529-1535.
15. Kannankeril, P.J., Goldberger, J.J. (2002). Parasympathetic effect on cardiac electrophysiology during exercise and recovery. *Am J Physiol Heart Circ Physiol* 282:H2091-H2098.
16. Lambert, R.P., Swart, J., Capostagno, B., Noakes, T.D., Lambert, M.I. (2009a). Heart rate recovery as a guide to monitor fatigue and predict changes in performance parameters. *Scand J Med Sci Sports*.
17. Lambert, R.P., Swart, J., Noakes, T.D., Lambert, M.I. (2009b). Changes in heart rate recovery after high-intensity training in well-trained cyclists. *Eur J Appl Physiol* 105:705-713.
18. Monod, H. (1967). The validity of heart rate measurement in ergonomics. *Ergonomics* 10:485-537.
19. Perini, R., Tironi, A., Cautero, M., Di Nino, A., Tam, E., Capelli, C. (2006). Seasonal training and heart rate and blood pressure variabilities in young swimmers. *Eur J Appl Physiol* 97:395-403.
20. Ostojić, S., Marković, G., Calleja-Gonzalez, J., Jakovljević, D.G., Vučetić, V., Stojanović, M.D. (2009). Ultra short-term heart rate recovery after maximal exercise in continuous versus intermittent endurance athletes. *Eur J Appl Physiol*.
21. Ota, Y. (2002). Evaluation of the whole body endurance capacity by treadmill all-out run. *Bull Fukuoka Univ Edu*. 51:71-77
22. Pierpont, G.L., Stolpman, D.R., Gornick, C.C. (2000). Heart rate recovery post-exercise as an index of parasympathetic activity. *J Auton Nerv Syst* 80:169-174.

23. Savin, W.M., Davidson, D.M., Haskell, W.L. (1982). Autonomic contribution to heart rate recovery from exercise in humans. *J Appl Physiol* 53:1572-1575.
24. Singh, T., Rhodes, J., Gauvreau, K. (2008). Determination of heart rate recovery following exercise in children. *Med Sci Sports Exerc.* 40(4):601-605.
25. Sugawara, J., Murakami, H., Maeda, S., Kuno, S., Matsuda, M. (2001). Change in post exercise vagal reactivation with exercise training and detraining in young men. *Eur J Appl Physiol* 85:259- 263.
26. Westerterp, K.R. (2009). Assessment of physical activity: A critical appraisal. *European Journal of Applied Physiology*, 105 (6), 823-828.
27. Yamamoto, K., Miyachi, M., Saito, T., Yoshioko, A., Onodera, S. (2001). Effects of endurance training on resting and post-exercise cardiac autonomic control. *Med Sci Sports Exerc* 33:1496-1502.

## MAXIMUM AND RELATIVE ISOMETRIC MUSCLE FORCE IN JUNIOR FOOTBALL, BASKETBALL, VOLLEYBALL PLAYERS AND CADETS

Dušan Gutović<sup>1</sup>, Nenad Sudarov<sup>2</sup>, Franja Fratrić<sup>3</sup> and Dragana Golik Perić<sup>2</sup>

<sup>1</sup>Faculty of Sport and Physical Education, University of Novi Sad, Serbia

<sup>2</sup>Regional Institute of Sport, Novi Sad, Serbia; <sup>3</sup>Faculty of Business Economy, Educons University, Novi Sad, Serbia

### Abstract

The main aim of the study was to determine whether there is a difference in the maximum and relative isometric muscle force, in upper body extremities, lower extremities and torso, of four groups of football, basketball and volleyball players, (14, 15, 16 and 17 years of age). ANOVAs recognize all, except one, statistically significant differences in mean values of the applied variables at the level of  $p = 0.05$ . The differences between examinees decrease when maximum force of certain muscle groups is put in relation to body weight. T-test for groups of examinees aged 14 and 17 years showed a statistically significant difference in the results of each of the examined variables. When comparing the groups aged 15 and 16, it can be concluded that the examinees belong to the same population. The conclusion is that changes in maximum and relative muscle force are affected by biological growth well as taking part in various sports activities.

**Key words:** dynamometer, force, team sports

### Introduction

Strength is an athlete's ability that is manifested in overcoming different types of resistance. Maximum strength is the highest level of force an athlete can produce during dynamic muscle work, for example, during heavy weight lifting. The difference between force and strength is reflected in their mechanical properties. According to Newton's Second Law, force  $F$  is the product of the body's mass  $m$  and its acceleration  $a$ .

$$F = m \times a$$

The unit used to measure force is Newton [N]. In static (isometric) conditions there is no movement or acceleration of the body, so force is manifested as external, that is to say, force is the resistance that is overcome (for example, the weight lifted). When there is no change in muscle length, and external resistance is at its highest, maximum isometric force is also realized. A person achieves the highest level of force in the isometric mode; on the other hand, when the speed of movement increases, force decreases while strength grows.

Force and strength cannot be completely separated because of the influence of body mass on them. It is a known fact that muscle force depends on the physiological cross-sectional area of muscle. Therefore, maximum force and relative muscle force are separately defined. Maximum force equals maximal isometric muscle force ( $F_{max}$ ); while relative muscle force ( $F_{rel}$ ) is the ration of maximal isometric force and body mass ( $M$ ).

$$F_{rel} = F_{max} / M$$

Previous researches showed that with the increase of body mass, maximum muscle force also increases while relative muscle force decreases (Verhošanski, Šestakov, Novikov and Nićin, 1992).

The biological development in children and adolescents is accompanied by the development of muscle strength as well as muscle force, partly because of the increase in body mass. Andersen et al. (1986) compared the muscle force achieved on a dynamometer after maximal voluntary contraction of flexor muscles of the elbow joint, knee extensors and torso flexors and extensors in Danish adolescents aged 16 to 19. They concluded that adolescent boys achieve higher levels of maximum muscle force in all four muscle groups examined, and that this was due to greater body mass in boys, since muscle force was the same (38 N/cm<sup>2</sup>) per cross-sectional area of muscle.

The highest increase in morphological development of the child is perceived in the period between 13 and 16 years of age. Growth hormone significantly increases muscle mass and muscle strength, that is, the ability of muscles to develop great force. Filin (1974) used a dynamometer to determine the level of development of muscle strength. A particularly major increase in static strength is noted in the period from 13 to 15 years of age, while from 17 to 18 years of age the increase in static strength is notably lower.

Sinaki et al. (1996) examined the correlation between the strength of torso and age as well as the correlation between gender and the strength of torso muscles on a sample consisting of 137 healthy boys and 109 healthy girls, aged 5 to 18. The conclusion was that age, gender, height, and weight are all important preconditions for strength in children.

This issue had previously been dealt with in researches that tested maximum and relative strength of different muscle groups and compared groups of athletes of different age who practiced football, basketball or volleyball. For example, in 2003, Buchanan and Vardaxis compared the maximum and relative force of flexors and extensors of the knee joint in two groups of basketball players aged 11 to 13 and 15 to 17. Testing was conducted on the Cybex II dynamometer. Similarly to this research, they noted that boys aged 15 to 17 showed a significantly higher absolute and relative strength of the quadriceps femoris muscles. In 2009, Shiltz et al. came to similar conclusions, noting that there is a difference in leg extensor muscles in subjects of different ages. They, however, compared senior and junior basketball players and concluded that there is a difference in the maximum strength of leg extensor muscles in favor of the senior players, while no difference was noted in the relative strength of the same muscle group.

The main aim of this study is to determine whether there is a difference in the maximum and relative isometric muscle force in athletes of different ages, varying from 13.50 to 17.49 years of age, in decimals. The subjects were players of team sports, including football, basketball and volleyball.

## Methods

*Subjects.* The research was conducted on a sample of 124 junior football, basketball and volleyball players and cadets. All the subjects were members of local sports clubs and they were divided into four age groups: 14 years (n=40, 13.50 to 14.50 years, in decimals), 15 years (n=28, 14.51 to 15.49 years, in decimals), 16 years (n=26, 15.50 to 16.50 years, in decimals), and 17 years (n=30, 16.51 to 17.49 years, in decimals).

*Sample of variables.* Sample of variables were the results achieved on the tests conducted for the assessment of maximum muscle force in upper body extremities, lower extremities and torso, as well as the relative values of isometric muscle force.

1. Maximal isometric force of finger and right hand flexors (MIFFRHF),
2. Relative isometric force of finger and right hand flexors (RIFFRHF),
3. Maximal isometric force of finger and left hand flexors (MIFFLHF),
4. Relative isometric force of finger and left hand flexors (RIFFLHF),
5. Maximal isometric force of torso flexors (MIFTF),
6. Relative isometric force of torso flexors (RIFTF),
7. Maximal isometric force of back extensor muscles (MISBEM),
8. Relative isometric force of back extensor muscles (RISBEM),
9. Maximal isometric force of leg extensors (MIFLE),
10. Relative isometric force of leg extensors (RIFLE).

Testing of the maximal isometric muscle force (maximum strength) was conducted under laboratory conditions at the Dynamometer Test Laboratory of the Regional Institute of Sport in Novi Sad.

*Data Processing.* Central and dispersion parameters of the variables (minimum and maximum value, result range, arithmetic mean and standard deviation, skewness and kurtosis) were calculated for all subjects together as well as for the groups of subjects divided based on decimal age. In the sample of subjects as a whole as well as for each group of subjects, a normal distribution of each of the variables was noted. ANOVAs were used to determine whether there is a statistically significant difference in the results of each variable between the four groups formed according to age (14, 15, 16 and 17 years of age). T-test was used to examine the differences between each group and the other groups, for each of the variables tested.

## Results

Table 1. Statistical Parameters of all Subjects and the Differences between the Groups Formed According to Subjects' Age

	MIN	MAX	MEAN	ANOVA
MIFFRHF	20	89	42.99	0.000
RIFFRHF	0.31	1.02	0.6698	0.051
MIFFLHF	18	81	41.70	0.000
RIFFLHF	0.31	0.93	0.6512	0.063
MIFTF	19	105	50.23	0.000
RIFTF	0.33	1.27	0.7730	0.031
MISBEM	49	242	122.9	0.000
RISBEM	0.91	3.31	1.9205	0.020
MIFLE	66	440	213.15	0.000
RIFLE	1.36	6.03	3.2687	0.000

The distribution of variables was tested using the Kolmogorov-Smirnov method and it was concluded that the distribution of all variables does not deviate from normal. It can be noted that, according to the skewness and kurtosis values, the variables of relative force are normally distributed; that is to say, the subjects show homogeneous results in terms of relative force. Uniformity can also be detected in the maximum and relative force of the right hand grip and the left hand grip, which indicates that the development of locomotion is symmetrical. The maximum force of leg extensors of the subjects was stronger than the force of the hand grip. This is probably due to the fact that the specific training programs of the subjects focused more on developing the strength of lower extremities, which is a common characteristic of football, basketball and volleyball players.

Univariate analysis of variance was used to determine the significance of the differences in arithmetic means of the groups formed according to subjects' age. Statistically significant differences were noted in mean values of the applied variables at the level of  $p. 05$ . No statistically significant difference was noted in the variables used to assess relative hand grip strength, although the results are on the verge of being significant. From the aforementioned, it can be concluded that subjects of different age belong to different statistical populations in terms of the variables studied.

Based on the F-ratio, it was concluded that groups differ significantly in the properties studied, and that the oldest group of subjects achieved the best results. T-test was used in comparing the groups.

## Discussion and conclusions

Based on the univariate analysis of variance of each variable, we concluded that subjects of different ages do not belong to the same statistical population, according to the properties studied. Based on the results, it can also be concluded that there is a statistically significant difference between the four groups of football, basketball and volleyball players of different ages, in the whole system of variables used in the assessment of maximum and relative muscle force.

By comparing the groups aged 14 and 15 we concluded that for none of the variables studied there was a statistically significant difference in the arithmetic means of the groups, which means that the two groups of subjects belong to the same statistical population in terms of maximum and relative force.

By analyzing the results we determined that, for the groups aged 14 and 16, t-test values are statistically significant in the variables used to assess the strength of the grip of the right and left hand, the maximum force of back extensors and the maximum and relative force of leg extensors.

The values of t-tests between the arithmetic means of the groups of subjects aged 14 and 17 were negative for each of the variables, which indicates that the difference is in favor of the oldest group of subjects, which is a completely logical conclusion. It can be concluded that the two groups of quality players of football, basketball and volleyball who were included in the study belong to different statistical populations in terms of maximum and relative muscle force.

For the groups aged 15 and 16, t-test is statistically significant for the variables used to assess the maximum strength of the left hand grip and back extensors at the level of  $p. 05$ . The difference is in favor of the oldest group of subjects.

The arithmetic mean of the groups aged 15 and 17 differ in a statistically significant way in almost all of the properties tested in terms of maximum and relative muscle force. No statistically significant differences were noted for the variable used in the assessment of maximum strength of the left hand grip and the relative force of back extensors, as these two values were above the borderline value of 0.05.

Finally, the arithmetic means of the groups of subjects aged 16 and 17 were compared, and it was concluded that there is a statistically significant difference in the variables used in the assessment of maximum and relative force of torso flexors and maximum force of leg extensors. The differences in the aforementioned properties go in favor of the oldest group of subjects. In the remaining variables, t-test does not show any statistical significance at the level of 0.05, which means that these two groups of subjects do not differ in the properties studied, thus leading us to the conclusion that they belong to the same statistical population.

In 2008, Loko et al. compared motor status on a sample of 902 Estonian girls, aged between 10 and 17. Among other things, they compared the isometric force of back extensors and torso flexors. They concluded that the difference in most of the properties studied stabilize in the age of 13 and 14. Positive differences appear between the groups aged 14 and 15, and 15 and 16, in favor of the older girls, in all properties studied. They concluded that the final stabilization of motor abilities occurs at the age of 16 and 17.

In the research that we conducted, no statistically significant differences were noted in the force of torso flexors and extensors in subjects aged 14 and 15, while subjects aged 16 showed a statistically significant difference compared to subjects aged 15 in terms of maximum force of back extensors. Subjects aged 17 showed more maximum and relative strength of torso flexors than subjects aged 16.

The conclusion is that changes in maximum and relative muscle force are affected by biological growth and development in puberty and adolescence as well as taking part in various sports activities.

The obtained results may prove useful for trainers in the adequate selection, programming, planning and conducting training processes. Above all, it could be used in the selection of resources and methods for the training of junior football, basketball and volleyball players and cadets so as to avoid the one-directional process of training, and to achieve a balance between the force of upper and lower extremities.

## References

1. Andersen, L.B. & Henckel, P. (1987). Maximal voluntary isometric strength in Danish adolescents 16 - 19 years of age. *European Journal of Applied Physiology and occupational Physiology*, 56 (1), 83-89.
2. Buchanan, P.A. & Vardaxis, V.G. (2003). Sex-Related and Age-Related Differences in Knee Strength of Basketball Players Ages 11–17 Years. *Journal of Athletic Training*. 38(3), 231-237.
3. Loko, J., Aule, R., Sikkut, T., Erleine, J. & Viru, A. (2008). Motor performance status in 10 to 17-year-old Estonian girls. *Scandinavian Journal of medicine & Science in Sports*, 10(2), 109-113.
4. Shiltz, M., Lehance, C., Maquet, D., Bury, T., Crielaard, J.M. & Croisier, J.L. (2009). Explosive Strength Imbalances in Professional Basketball Players. *Journal of Athletic Training*, 44(1), 39-47.
5. Sinaki, M., Limburg, P.J., Wollan, P.C., Rogers, J.W., & Murtaugh P.A. (1996). Correlation of trunk muscle strength with age in children 5 to 18 years old. U *Mayo Clinic proceedings*, (1047-54). Phoenix: Mayo Clinic.
6. Verhošanski, J.V., Šestakov, M.P., Novikov, P.S. & Nićin, Đ.A. (1992). *Specifična snaga u sportu teorija i metodika*. Novi Sad: Prometej i Fakultet fizičke kulture. Zajedničko izdanje.

## TRANSFORMATIONAL PROCESSES OF MOTORIC ABILITIES OF YOUNG SOCCER PLAYERS UNDER THE INFLUENCE OF SITUATIONAL MODEL OF TRAINING

Ekrem Čolakhodžić<sup>1</sup>, Almir Popo<sup>1</sup>, Almir Pokvić<sup>2</sup>, Admir Poturović<sup>3</sup> and Meris Husanović<sup>4</sup>

<sup>1</sup>Teacher Training Faculty, "Džemal Bijedić" University, Mostar, Bosnia and Herzegovina

<sup>2</sup>FC „Sloga,,, Gornji Vakuf, Bosnia and Herzegovina

<sup>3</sup>FC „Radnik“, Donji Vakuf, Bosnia and Herzegovina

<sup>4</sup>The Universal school of sport „Lider“, Zavidovići, Bosnia and Herzegovina

### Abstract

The aim of this research was to define the changes of motor abilities under the influence of situational training. The longitudinal study was conducted on a sample of 75 soccer players from 12 - 15 years old. Respondents were included in a training process and the pioneer league of Herzegovina – Neretva Canton, for over 3 years. For assessment of motor abilities eighteen variables were used (Metikoš et al. 1989), the assessment of changes was done on the basis of differences between the initial and the final testing. The programme lasted through the period of 6 month, where 72 training units were realized and 8 league matches were played. The structure of the programme is conceived on solving the problem of soccer through the game (Wein, 2004), and the situational method of work in its all 5 phases was applied. Discriminant analysis under the model of differences for defining changes was used. Analysing obtained results, it can be concluded that a very statistically significant quantitative changes were obtained and the greatest contribution for discrimination between the initial and the final measurements was realized by variables that determine the area of explosive power, speed of movement and flexibility. On the basis of obtained results it can be concluded that soccer players of this age, through the situational method of game, show a very high adoption degree of specific motor structures, which are especially characteristic for soccer, and very quickly they adjust themselves to situational demands of the game.

**Key words:** motor abilities, soccer, situational training

### Introduction

The transformational process represents the change of an athlete in a particular anthropological characteristic, under the influence of defined systematic operator (Malacko & Rađo 2004). For those reasons, an important significance in the management of transformational process of athletes marks the available feedback during training process, from the initial to the final state. The specific quality in the management during the period of training process consists of the effect on the athletes with the appropriate training contents, whose reactions are mostly unknown and that means if we apply one and the same effect the same retroactive reactions can not be achieved. For these reasons, back links, which go from the subject towards the person who manages the process, are very important, as well as the information about subject's behaviour and the information about current, prolonged or cumulative effect of exercise.

It stems from these reasons that in a contemporary training, it's necessary to take care about the extent, intensity and quality of work and this is especially related to work with younger categories. The relations between motor abilities and attainment of motor skills are always multidimensional and complex. It is considered that a high level of motor abilities is the basic precondition for effective learning and leading out some new motor structures. For their improving and irreproachable application in a game, the preparation of the whole motor apparatus must be done previously, that is directly linked to other systems as cardio– vascular, respiratory, muscular, and nervous and others. From all these mentioned above, it stems that before starting achieving even the most elementary techniques and tactics related to soccer, it is necessary to create the initial conditions for that, and all that can be achieved by various and versatile preparation of psycho motor dimensions of soccer player, especially motor skills (Colakhodzic et al., 2008). The problem of this research is set through establishing transformational levels in a set of motor abilities of soccer players from 12 - 15 years old under the influence of situational model of training. The aim of the researching was to determine (establish) the level of changes emerged under the influence of situational model of training, which lasted through the period of 6 months. The structure of the programme was conceived on the modern vision of young soccer players' development by solving soccer trouble through the game (Wein, 2004), and situational method of work in its all 5 phases was applied.



## Methods

*Subjects.* The sample of respondents in this research consisted of 75 soccer players from 12 – 15 years old, who were for 3 years actively involved in training process and league competition in the pioneer league of Football Association of Herzegovina – Neretva Canton. The training process lasted through the period of 6 months, 72 training units have been realized and 8 league matches were played. All respondents are in good health status and without any psychophysical aberrations.

*The sample of variables.* To estimate emerged changes in the area of motor abilities, 18 variables were used which cover the latent space of velocity, explosive power, repetitive strength, flexibility, balance and coordination (Metikos et al. 1989): bend–rotating body aside– touch (MBFPZD); taping of foot (MBFTAN); taping of foot against the wall (MBFTAZ); long jump from the place (MESSDM); the high jump from the place (MESSVM); the sprint from the high start of 20 metres (MES20V); flex rod (MFLISK); deep bend (touch toe) on the bench (MFLPRK); deep bend (touch – toe ) astride in the sitting (MFLPRR); slalom with legs using 2 balls (MKOSNL); figure eight with bowing (flexion) (MAGOSS); steps aside (MAGKUS); lying - sitting (MRSLES); push – ups (MRSSKL); lying in the huts – raising body up (MRSZTL); standing on one foot longitudinally on a bench with open eyes ( MBAU10); standing on one foot longitudinal on a bench with your eyes closed (MBAUIZ); standing on two feet transversally on a bench with closed eyes (MBAP2Z).

*Methods of data processing.* The data about respondents were obtained by measuring variables before the start and at the end of the programme, relatively at 2 time points. For input, data processing and analysis of results, the appropriate mathematical – statistical methods and procedures were used. Result processing is done in a software package STATISTICA 6.0 and SPSS 12.0 For Windows. On the multivariate level for determining the quantitative differences Canonical discriminant analysis under the model of differences was used (Rado & Wolf 2002). The criterion for discriminant strength of treated variables was so called Wilk's Lambda. Determination of statistical characteristic of each discriminative variable will be made on the basis of Burtlet's Chi – square test. For interpretation, isolated, significant discriminant variables were used, that explain a certain percentage of variability.

## Results

Based on the results which are shown in Tables of the number 1 to number 4, the differences between the initial and the final measurements in the effects of programme which lasted through the period of 6 months, 3 times a week for 90 minutes, were analyzed. Based on the results listed in the tables it can be defined whether there was a significant global move in tests related to motor abilities in the interval that enclosed the programme. In Table 1 (Box's M- test) the similarity matrix of covariance between the two samples was tested (between the initial and the final measurements) which was the starting base for this analysis. From the table it can be seen that the difference matrix of covariance is statistically significant (Sig = .04), and that is the condition for accessing to further procedure of Canonical discriminant analysis.

Table 1. Boxes test equality of covariance matrices of motor abilities

Box's M		234,38
F	Approx.	1,19
	df1	171
	df2	67233,97
	Sig.	,04

In Table 2 the results of discriminant analysis of motor abilities were shown. One very significant discriminant function was obtained, which has statistically significant value (Canonical Correlation =.90), and it shows in which correlation is the data set, which was used for discriminant analysis and the results in discriminant functions. The value of Wilks' Lambda, that tells us about discrimination among groups (measurements) is 0.17), and it confirms the high discrimination (difference) between the initial and the final measurements.

Table 2. Discriminant analysis in the manifest area of motor abilities

Function	Eigenvalue	% of Variance	Cumulative %	Canonical Correlation	Wilks' Lambda	Chi-square	df	Sig.
1	4,62	100,0	100,0	,90	,17	240,19	18	,000

On the basis of the results in Table 3 it can be seen that the highest correlation with discriminant function, respectively to variable which differs the results value of the motor abilities in the initial and the final measurements to a maximum degree have the following variables: MES20V, MRSZTL, MBFPZD and MFLPRR. It is the one variable from the area (space) of the explosive power, repetitive strength, speed of movement (velocity of movement) and flexibility. By further analysing the structure matrix where are shown the correlations with the discriminant function, which differs, to a maximum degree the first from the second measurements in the structure matrix, it can be seen that there are some positive changes in the majority of the motor abilities, especially those that represent above listed variables. The position of the test for the frequency of movement MBTAZ and MBFTAN is very important as well as MAGOSS test for balance, which have a significant correlation with discriminant function, but a bit lower than previously mentioned variables.

Table 3. Standardized coefficient of discriminatory structures and discriminant function of motor abilities

Variable	Function 1	Variable	Function 1
MBFPZD	,197	MES20V	-,625
MBFTAZ	,334	MRSZTL	,440
MBFTAN	-,030	MBFPZD	,349
MFLPRK	-,687	MFLPRR	,316
MFLPRR	,394	MAGOSS	-,281
MFLISK	-,007	MBFTAN	,251
MAGOSS	-,066	MRSLES	,239
MAGKUS	-,005	MBFTAZ	,221
MKOSNL	,218	MBAP2Z	,199
MRSSKL	-,032	MRSSKL	,198
MBAU1O	-,053	MBAU1O	,198
MBAU1Z	,376	MAGKUS	-,193
MBAP2Z	,141	MBAU1Z	,184
MESSDM	-,012	MFLISK	-,171
MESSVM	-,461	MESSVM	,161
MES20V	-,716	MKOSNL	-,139
MRSLES	,087	MESSDM	,107
MRSZTL	,560	MFLPRK	-,044

In other words, the programme conducted in this group of respondents had been extensive in response to situational method of work, respectively the game which in its movement structure has this psychomotoric characteristics – explosive power and repetitive strength, flexibility, the frequency of the movement and coordination, characteristics that had made the difference here. Well, this is the case (issue) of football game dominated by powerful, explosive movements with the agility, agilely and the body control in the space. Probably, a huge role in the difference between the final and the initial measurements had elements of the growth (developments) through the game, where the children mostly give it all (try to give the best). It is interesting that in the matrix structure, variables of coordination and balance behaved differently than other variables, so they had a bit lower level of coordination with discriminant function. The different position coordination tests and balance tests on the discriminant function can be attributed to greater number of motor activities during the program, which had provoked different motor reactions. Well, it is about so called agility and balance which are in the function of all sports games as well as in the individual sports. Certainly, in this situation we have to keep in mind the factor of permanent growth and development of motor abilities and morphological characteristics at boys of this age, but it is likely that quantitative changes in the motor area (space) are the consequence of significant increase of cyclic and acyclic types of movement, which were represented in the programme of the group. We have to take in consideration the changes in educational terms, when we talk about learning new movements. The experience, gained by the respondents in the range from the first to the second measurements, is the scope where they met (knew) the complexity and structure of movements-the activities embraced with the applied measurement instruments. The global improvement of the results was probably influenced by decrease of time required for understanding and remembering sequence of tasks in tests, which is always present during the first facing with the complex motor situations, and this is especially expressed among the correspondents of this age.

Table 4. Centroids of motor abilities in a significant discriminative function

Group	Function 1
1	- 2,137
2	2,137

## Discussion and conclusions

The changes in a set of motor abilities at soccer players from 12 – 15 years old, emerged under the influence of soccer programme is the basic question and the basic aim of this research. What sort and what kinds are the changes emerged in motor area (space) after the particular period of training and under the influence of a specific programme is the question always actual in sports technology. For the purpose of defining the levels of changes Canonical discriminative analysis in the space of motor abilities, was applied. Isolated orthogonal vectors in the area (space) of manifested variables are set in a such way, so they can separate the groups of correspondents in the researching variable area, as best as they can. In this research we have one group of correspondents measured in two time points. After the initial measurement, soccer programme lasted through the period of six months, was conveyed, and after its end, we approached to the final testing of the correspondents. After the processing and analysing obtained results in the area of motor abilities, it can be concluded that statistically significant quantitative changes were obtained, and the greatest contribution to discrimination between the initial and the final measurements was realized by variables that determine the area of explosive power, repetitive strength, the speed (velocity) of movements and flexibility. On the basis of obtained results of this research it can be concluded that there are statistically significant differences between these two measurements under the influence of situational training, and this is confirmed by the position of group centroid (measurements) on a significant discriminant function. Soccer players of this age through the situational method of game show a very high degree of adopting specific motor structures that are characteristic for soccer, and very simply they adjust themselves to the situational demands of soccer. From all this it can be concluded that situational method of training has a positive influence to all psychomotoric abilities of soccer players, especially for those who take a high place in success equation of this sport.

## References

1. Bunc, V., and Psotta, R. (2001). *Physiological profile of very young soccer players*. Journal of Sports Medicine and Physical Fitness, 41, 337-341.
2. Casajus, J.A. (2001). *Seasonal variation in fitness variables in professional soccer players*. Journal of Sports Medicine and Physical Fitness; 41, 4; ProQuest Nursing Journals pg. 463.
3. Čolakhodžić, E., Rađo, I., Mahmutović, I., Skender, N. (2008). *Qualitative changes of Motoric abilities at soccer players under the Effect of Situational Soccer training*. Sarajevo: Homosporticus, vol. 10., pg. 6-10.
4. Čolakhodžić, E., Rađo, I., Alić, H. (2009). *Processes of transformation of morphological dimensions among youth category soccer players caused by situational training*. Sarajevo: Homosporticus, vol. 11., 18-22.
5. Malacko, J., Rađo, I. (2004). *Tehnologija sporta i sportskog treninga* (Technology of sport and training. In Bosnian). Sarajevo: Fakultet sporta i tjelesnog odgoja.
6. Malina, M. (2003). *Growth and maturity status of young soccer players*. In Reilly, T., Williams, M. A. (Ed.). Science and Soccer-Second edition (pg. 286-306). New York: Routledge.
7. Metikoš, D., Hofman, E., Prot, F., Pintar, Ž., Oreb, G. (1989). *Mjerenje bazičnih motoričkih dimenzija sportaša* (Measurements of basal motoric dimension of athletes. In Croatian). Zagreb: Fakultet za fizičku kulturu.
8. Rađo, I., Wolf, B. (2002). *Methods for classification in sport*. Sarajevo: College of Physical Education.
9. Reilly, T., Bangsbo, J. and Franks, A. (2000). Anthropometric and physiological predispositions for elite soccer. Journal of Sports Science, 18, 669-683.
10. Wein, H. (2004). *Entwicklung der Spielintelligenz im Fussball*. Heinsberg: Peter Schreiner.

## THE EFFECTS OF PILATES TRAINING PROGRAM ON DYNAMIC STRENGTH IN FEMALE SOCCER PLAYERS

Lejla Šebić<sup>1</sup>, Dženan Baždarević<sup>1</sup> and Gordana Furjan-Mandić<sup>2</sup>

<sup>1</sup>Faculty of Sport and Physical Education, University of Sarajevo, Bosnia and Herzegovina

<sup>2</sup>Faculty of Kinesiology, University of Zagreb, Croatia

### Abstract

In this paper, a special attention was paid to the segment of dynamic strength as well as opportunities to develop these skills in female soccer players through somewhat different, innovative, and interesting approach by using the Pilates exercise method. The problem of work is set to determine the size of the actual or real effect of the applied experimental Pilates program in achieving transformational goals. Sampled for this study were 19 active female soccer players from the soccer club "SFK 2000" in Sarajevo, 18-25 years of age. The transformation process was programmed and carried out in order to determine the achieved effects. A total of 5 variables were applied for assessment of dynamic strength in the subjects: (MRSSKL) push ups, (MRSDDL) to lift the body up while lying down, (MRSZTL) hid the body while lying, (MRSCUC) squats with a load (MRSPNL) lifting up legs while lying down. During a transition period, the soccer players were involved in the daily Pilates program for 30 minutes, over 18 days. T-test and discriminant analysis were used for data analysis. This research has proven that the Pilates method can be an effective complement or substitute for the classic approach of developing dynamic strength through a program of work in the gym and introduces a new and modern - physiological fitness program for athletes to maintain a good condition.

**Key words:** *experimental program, a transitional period, the transformation*

### Introduction

Transformational process, in general sense, means change or conversion. All changes in the conditions of input and output in the system is carried out in a way that some inputs in the course of time turn into output; in some initial state is transformed into a newly formed (transitive, final) state (Malacko & Rađo, 2004).

Kinesiological science and practice to this day has developed a number of recreational exercise programs such as various types of aerobics, Pilates, yoga, tai-chi, etc. However, it is still a relatively unexplored issue of the real impact of these programs on some of the anthropological status dimensions of the trainees' recreation. Another less explored area is the influence of such programs on improving certain motor skills in top athletes. In this paper, special attention was paid to the segment of dynamic strength and opportunities to develop these skills in female soccer players through somewhat different, innovative and interesting approach to using the Pilates exercise method. Pilates method of exercise was defined as a unique and specific combination system: stretching exercises, strength and balance (Siler, 2005). In its original form of Pilates method, as a concept of therapeutic effects on muscles was developed by the German trainer Joseph H. Pilates in the 20-ies of the last century. It is believed that this type of exercise strengthens and shapes the muscles, corrects posture, improves flexibility and balance, unites body and mind, and improves the body shape.

Unlike most training systems that are based on the exercise of individual muscles, muscle groups or partial parts of the body, the Pilates method treats the body as a whole. The concept of exercising all the muscles at the same time with constant rotation movement is the most effective way to increase muscular endurance. The exercises are specific, because of the number of repetitions and the sequences of exercises, their names are accurately determined. The program consists of 34 primary and over 500 other various exercises. The breathing rhythm is precisely defined for each exercise. All exercises are performed very slowly, without sudden movements, with the constant reliance on the surface. During the time of Pilates, physiological load can be compared with medical yoga or low intensity aerobics (Jago et al., 2006). The basic elements that create a unique method of Pilates are: concentration, control, centring, breathing, the movements sequence, proper posture, precision, endurance and relaxation. Soccer is energetic and tough game that puts extreme stress on the whole body of the players, be it the head, shoulders, arms, waist, knees, ankles, or any other body part. Very often, during tough practices and games, a player may suffer from different disorders, particularly stress, fatigue, headaches, muscle tension, pain in the neck and back. By using Pilates exercises, players can basically control the posture, achieve greater agility and balance, improve flexibility, improve breathing patterns and concentration, as well as improve muscular endurance. Because of all the effects from this type of exercise, a growing number of athletes decide to use the Pilates method as a supplementary means for the regular conditional preparation. It is well known that every operator of Kinesiology causes adaptation of the subject on which he applied. However, the question on level of transformation of

anthropological dimension under the influence of the operator remains unanswered. The problem of work is related to determining the size of the actual effect of the applied experimental Pilates program to achieve the transformational goals.

## Methods

Sampled for this study were 19 female soccer players "SFK 2000" from Sarajevo, 18-25 years of age, who are involved in the training process and soccer competitions. The subjects participated in an experimental program of Pilates exercises, which lasted three weeks (18 training units, each 30 minutes long) and was conducted by skilled Pilates instructors in the transitional period when the soccer players rest and generally do not have any other training or practice. The study was longitudinal, and measuring the power dimensions was conducted before the realization of the program (the initial test), as well as by the end of the Pilates program (final testing). The variables for assessment of dynamic strength consisted of 5 tests: MRSSKL - push-ups, MRSDDL - raising body while lying down, MRSZTL - hid the body while lying, MRSCUC - squats with the load, MRSPNL - raising the legs while lying down. In all applied variables, the results of respondents were analyzed with standard descriptive methods. At the unvaried level, for each applied variable, the difference was tested by T-test for paired samples, which were made through two time points (initial and final measurement). In order to determine the global quantitative differences between the initial and final measurement, the discriminate analysis was applied at the multivariate level.

## Results

According to the indicators of central and dispersion parameters in Table 1, it is noticeable that the values of most variables (repetitive power tests) are in the range expected for this population of active athletes. The results of Skewness and Kurtosis, as well as the K-S test, indicate that these are normal distribution results and they enable us to further analyze the data. Table 2 presents basic statistical indicators of the second measurement. As can be seen, all the variables indicate normality of distribution. In the final measure, the value of art environment has increased for all variables in relation to initial measure, which tells us that there have been certain changes due to the applied program.

Table 1. Basic statistical parameters in the first measurement

Initial	Valid N	Mean	Minimum	Maximum	Std.Dev.	Skewness	Kurtosis	K-S
MRSSKL	19	24.73	10	45	8.69	0.29	0.01	.128
MRSDDL	19	51.05	20	102	21.53	1.31	1.63	.149
MRSZTL	19	38.22	26	55	8.43	0.42	-0.74	.103
MRSCUC	19	43.57	18	99	18.30	1.43	3.66	.156
MRSPNL	19	32.05	10	60	12.19	0.45	0.46	.088

Table 2. Basic statistical parameters in the second measurement

Final	Valid N	Mean	Minimum	Maximum	Std.Dev.	Skewness	Kurtosis	K-S
MRSSKL	19	38.84	22	56	10.28	0.00	-1.19	.068
MRSDDL	19	133.05	56	300	60.10	1.27	1.90	.112
MRSZTL	19	68.42	38	141	24.12	1.59	3.57	.158
MRSCUC	19	77.94	43	118	21.98	0.21	-0.73	.062
MRSPNL	19	50.47	29	76	11.99	0.18	0.26	.089

Correlation matrix of variables in initial measurement (Table 3) show that only two variables statistically and significantly correlate: (MRSDDL) to raise body while lying and (MRSPNL) lifting up legs while lying. These are the variables for the evaluation of repetitive body forces - abdominal muscles, so this correlation is quite logical and expected.

Table 3. Correlation of Initial measurement

Initial	MRSSKL	MRSDDL	MRSZTL	MRSCUC	MRSPNL
MRSSKL	1				
MRSDDL	0.25	1			
MRSZTL	0.26	0.34	1		
MRSCUC	0.39	0.09	0.44	1	
MRSPNL	0.49	0.68	0.15	0.30	1

Table 4. Correlation of final measurement

Final	MRSSKL	MRSDDL	MRSZTL	MRSCUC	MRSPNL
MRSSKL	1				
MRSDDL	0.61	1			
MRSZTL	0.55	0.72	1		
MRSCUC	0.55	0.69	0.62	1	
MRSPNL	0.61	0.40	0.39	0.39	1

In the final measurement of the correlation matrix of variables (Table 4) show that the situation has now changed and that most of the variables showed a statistically significant correlation. Such correlation in the final measurement points us to the conclusion that there was a certain space of integral repetitive forces under the influence of the experimental program of Pilates. At the invariant level, each applied variable was tested for differences in the mean T-test, which occurred through the two time points (initial and final measurement). As seen in Table 5, mean values of all variables showed a statistically significant difference between the first and second measurement, and the level of significance is  $p = .00$ . It is clear that the applied training treatment caused the expected changes on the level of repetitive strength in soccer players.

Table 5. T-test difference

Variable	Mean	Mean				Valid N	Valid N	Std.Dev.	Std.Dev.	F-ratio	p
	G_1:1	G_2:2	t-value	df	p	G_1:1	G_2:2	G_1:1	G_2:2	variance	variance
MRSSKL	24.74	38.84	-4.57	36	.00	19	19	8.69	10.28	1.40	0.48
MRSDDL	51.06	133.05	-5.46	35	.00	18	19	21.53	60.11	7.79	0.00
MRSZTL	38.22	68.42	-5.02	35	.00	18	19	8.43	24.13	8.18	0.00
MRSCUC	43.58	77.95	-5.24	36	.00	19	19	18.30	21.99	1.44	0.44
MRSPNL	32.05	50.47	-4.69	36	.00	19	19	12.20	11.99	1.03	0.94

The discriminative analysis method was applied in order to determine the global quantitative differences of the initial and final measurement. This method considers the size of some quantitative variables and their mutual relations. The discriminative model is a special type of factor analysis that isolates the orthogonal vectors in the area of manifest variables, and they are placed to best separate the groups of sampled in the space of variables (Rado and Wolf, 2002). The criterion for discriminate strength of applied variables is known as Wilks Lambda. By analysis results in Table 6, it can be seen that it is obtained a statistically significant discriminative function with a highly significant value of .68. This indicates where the correlated data set applied based on which we performed the discriminative analysis.

Table 6. Wilks' Lambda

Function 1	Eigenvalue	% of Variance	Cumulative %	Canonical Correlation
	.898 <sup>a</sup>	100,0	100,0	.688
Test of Function(s) 1	Wilks' Lambda	Chi-square	df	Sig.
	.527	21,458	5	.001

Based on the results in Table 7, it can be seen that the correlation with the discriminative function, known as variable, completely differs the strength of repetitive forces between the initial and final measurements, and the MRSCUC test - squats with a load, has the maximum value of .851. Further seeing the results in Table 7, in all other variables, we see that there are statistically significant differences between initial and final measurements. The following are the variables for the evaluation of dynamic forces: lifting legs while lying down (MRSPNL), lifting the body while lying down (MRSDDL) and hid the body while lying (MRSZTL) with approximately equal values of discriminative functions that range in value from .792 to .722. The lowest but still statistically significant discriminative function value of .650 is a variable for assessment of dynamic strength of upper limb push ups (MRSSKL). In the analysis of the results in Table 8, it is noticeable that the results of the group measured at the beginning of Pilates are on the negative part of the discriminative function, and results in the final measurement are on the positive findings of the discriminative function.

Table 7. Structure of discriminative function

Variable	Function
	1
MRSCUC	,851
MRSPNL	,792
MRSDDL	,746
MRSZTL	,722
MRSSKL	,650

Table 8. Centroids

GROUP		Function
		1
dimension0	1,00	-,875
	2,00	,972

## Discussion and conclusions

Unlike other motor skills, repetitive force has a relatively low coefficient of innateness, and with the adequate training process, its level can be significantly affected. Development of dynamic strength is usually related to work in the gym where a large number of training devices are designed for targeted work on individual muscle groups. However, the application of Pilates program, strength exercises are aimed at both strengthening the entire body (no isolation strength exercises), so with proper programmed training process, dynamic strength can be extremely successful in terms of equal development of all muscle groups. The highest correlations of 0.72 show the following variables: (MRSDDL) raising body while lying down and (MRSZTL) hid the body while lying (Table 4). These variables evaluate repetitive strength of abdominal and back muscles. For realization of these two tests, the most activated muscles are as follows: m. obliquus externus and internus abdominis, m. rectus abdominis and m. erector spinae. These muscles serve as powerful stabilizers of the body. Since most Pilates' exercises are directly or indirectly focused through the centering principle, on strengthening the abdominal muscles and achieving stability of the torso, it is clear that under the influence of the experimental program appears a significant association between these two variables that estimate the strength of abdominal and back muscles. Joseph Pilates referred to the body center as "the center of power" or "powerhouse" (Shiler, 2005). According to him, all the necessary energy for Pilates' exercises comes from the center and flows out to the limbs, so it builds a strong foundation on which we may rely on, not only in sports, but in everyday life. Strong abdominal and back muscles allow proper posture, well-controlled movement of the entire body, maintaining balance, the preservation and proper functioning of the internal organs and spine.

The experimental Pilates program (Table 7) has had a significant impact on a repetitive force of lower extremities. Specific Pilates' exercises can focus on areas prone to injuries in soccer players such as hamstrings, calf muscle and joints. Such exercises strengthen these areas in order to avoid all possible injuries. Players often suffer from the feedback disruption on the back. Pilates' exercises that simultaneously strengthen and stretch the muscles also help to reduce the pain and prevent the constant muscle tearing. A large number of soccer players use Pilates as part of their rehabilitation program or recovery process after the injury. These exercises do not place an undesirable high pressure on sore muscles, and with various stretching and toning exercises, they help injured muscles heal faster. Clearly, the Pilates program has a significant effect on muscle strength of arms and shoulder belt, which confirms the hypothesis that Pilates exercises evenly work the muscles on the entire body (not isolated strength exercises). Soccer is a sport with high pressure and the player's concentration is on the game, where the player is faced with a large crowd and while keeping concentration on the game, the player must coordinate with his players from the team. The effect of Pilates helps in this case. With proper breathing techniques, a soccer player can control most situations when "the adrenaline jumps".

The controlled breathing techniques in Pilates can alleviate the stress in players, including the stretching and flexing exercises that tone out the muscles and prepare them for this sport. This research has proven that Pilates method may be a useful supplementary tool in training soccer players, in terms of increasing and improving the dynamic strength level. Unlike most training processes that are based on the exercise of individual muscles, muscle groups or partial body parts, the Pilates method treats the body as a single entity through a combination of specific stretching exercises, strength and balance. It should be noted that such practice does not increase the muscle volume, but it makes the muscles elastic, supple and spindle-shaped, as this is of a great importance in soccer as well. Pilates program that treats the body as a single entity, may correct the imbalances that arise when the need for maximum effect requires a lot from specific muscle groups at the expense of others. Pilates' method of exercise can be an effective complement or substitute for the classic approach to developing dynamic strength through a program of work in the gym and introduces a new and modern physiological fitness program to maintain athletes in good condition.

## References

1. Jago, R., Jonker, ML, Missaghian, M., T. Baranowski (2006). The effects of Pilates program on the young girl's body composition. *Preventive Medicine* 42/177 – 180.
2. Malacko, J., Rađo, I. (2004). The technology of sports and sports training. The Faculty of Sports and Physical Education, Sarajevo.
3. Rađo, I., Wolf, B. (2002). Quantitative methods in sport. The Faculty of Sports and Physical Education, Sarajevo.
4. Rađo, I., Talović, M. (2003). Transformational processes of motor and functional abilities under the influence of soccer program. *Sports logos*, 1: 7-19, Mostar.
5. Siler, B. (2005). Pilates body. The ultimate guide to strengthening and development of muscle tone at home – without devices. Bauer-grupa d.o.o., Biovega, Zagreb.



## **INFLUENCE OF THE MORPHOLOGICAL CHARACTERISTICS AND MOTOR ABILITIES AT THE PERFORMANCE OF SOME HAND JUDO TECHNIQUES OF BOSNIA AND HERZEGOVINA JUDOKAS**

**Amel Mekić, Husnija Kajmović, Adis Kapur and Nada Katica**

*Faculty of Sport and Physical Education, University of Sarajevo, Bosnia and Herzegovina*

### **Purpose**

Purpose of this research is to determine the influence of the morphological characteristics and motor abilities at the performance of some hand judo techniques of Bosnia and Herzegovina judokas.

### **Methods**

Research was conducted in 2008 under the auspices of the Judo association of B&H, during summer training camps. Sample consisted of 87 judokas, senior and junior age and included all of the seven weight categories. Predictor variables for the assessment of the morphological characteristics: Body height and Body weight. Predictor variables for the assessment of the motor abilities: Flexibility test: Toe Touching, Shoulder Flexibility and Standing Front split. Explosive strength tests: Vertical jump, Broad jump and 20 m Sprint. Coordination tests: Bat Coordination, Air coordination, Ground coordination and Letter run test. Grading criterion for the some hand judo techniques (kata-guruma) experimental performance of technique, was graded by the five (1–5) grades scale. The determination of the morphological characteristics and motor abilities influence at the performance of some hand judo techniques of Bosnia and Herzegovina judokas was done by the use of the regression analysis.

### **Results**

Results of the regression analysis show that morphological characteristics, body mass precisely influence of the some hand judo techniques (kata gurume), while motor ability of explosive strength has fundamental, large influence at the technique performance of some hand judo techniques (kata gurume) of the treated sample, of top level male judokas in Bosnia and Herzegovina.

### **Conclusions**

To conclude, regression analysis paints us a real existing picture which shows that the fundamental ability for the successful and efficient performance of some hand judo techniques (kata – gurume) is explosive strength. The reasons for this state can be found in training process and training technology of the judokas at their clubs.

*Key words: judokas, morphological characteristics, motor abilities, hand techniques*



**6<sup>th</sup> INTERNATIONAL  
SCIENTIFIC  
CONFERENCE ON  
KINESIOLOGY**

**“INTEGRATIVE POWER OF  
KINESIOLOGY”**

# **Kinesiology of Physically Demanding Jobs**

**Editors:**

**Prof. Dražen Harasin, PhD  
Prof. Boris Maleš, PhD**

**Peer Reviewers:**

**Prof. Dražen Harasin, PhD  
Prof. Boris Maleš, PhD  
Prof. Igor Jukić, PhD  
Prof. Goran Sporiš, PhD  
Matija Aračić, PhD  
Daniel Bok, MagKin**



**Secretary:  
Daniel Bok, MagKin**

## EFFECT OF A 6 MONTH DEPLOYMENT TO AFGHANISTAN ON PHYSICAL FITNESS\*

Daniel Bok<sup>1</sup>, Dražan Dizdar<sup>1</sup> and Tamara Despot<sup>2</sup>

<sup>1</sup>Faculty of Kinesiology, University of Zagreb, Croatia

<sup>2</sup>FC Dinamo Zagreb, Croatia

### Abstract

The purpose of this investigation was to examine the effect of six month deployment to Afghanistan on the measures of physical fitness of Croatian professional soldiers. A sample of 59 members of the Croatian Armed Forces (CAF) deployed to ISAF mission in Afghanistan was measured before and after a 6 months deployment. Physical fitness measurements included 7 motor tests for the assessment of coordination, agility, jumping power, sprinting power, flexibility, repetitive abdominal and upper body strength, and 2 functional tests for the assessment of aerobic and anaerobic endurance. All tested motor and functional abilities, except flexibility and  $VO_{2max}$ , were decreased postdeployment. Significant decreases ( $p < .05$ ) were obtained in agility ( $p = .00$ ), repetitive abdominal ( $p = .02$ ) and upper body ( $p = .00$ ) strength, aerobic ( $p = .00$ ) and anaerobic ( $p = .00$ ) endurance. Flexibility and  $VO_{2max}$  increased, but not statistically significant. Six months deployment to Afghanistan negatively affected agility, coordination, repetitive strength, jumping and sprinting power, aerobic and anaerobic endurance. Decreases in most physical abilities were significant and can be considered as a major problem for optimal performance and health. If additional investigations show similar results, changes in physical preparation predeployment as well as implementing supervised physical training programmes for soldiers during deployment should be considered.

**Key words:** military, deployment, training, strength, endurance

### Introduction

As a member of a NATO pact, Croatia is obligated to participate in abroad military peace operations and missions. Among other, the CAF are regularly sent to Afghanistan on a six months ISAF mission. As high physical readiness is a job requirement for soldiers they are constantly subjected to physical training with the purpose to get optimally prepared. It is also very important for soldiers to maintain their physical readiness on the highest necessary level once it's reached. Maintenance of high level physical readiness is somewhat easier when soldiers are positioned in their bases, but during abroad deployments, especially in exotic environments, this job is much harder. Unavailability or not existence of physical fitness facilities, limited training time, decreased physical activity due to specific job requirements (standing and sitting), changes in dietary habits as well as hot environment exposition can all influence on changes in physical readiness (Sharp et al, 2008). Therefore, soldiers and their superiors are often faced with changes in physical fitness during deployments. However, recent studies focused on investigating the magnitude of changes in physical fitness of soldiers deployed to military missions documented minor decreases and concluded that the changes do not present major fitness and health concerns (Sharp et al, 2008; Lester et al., 2010). Sharp and colleagues (2008) reported significant decreases in  $VO_{2peak}$ , and upper body power, but no change in lifting strength and vertical jump performance among infantry soldiers deployed for nine months to Afghanistan. Lester and colleagues (2010) performed similar investigation on soldiers deployed for thirteen months to Iraq and reported increases in upper and lower body strength and upper body power, but decreases in aerobic performance.

The current investigation sought to evaluate the changes in physical fitness of CAF members deployed for six months to Afghanistan.

### Methods

The investigation was conducted on 59 members (body weight  $86,22 \pm 12,19$  kg; body height  $178,99 \pm 6,39$  cm) of the CAF deployed to ISAF mission in Afghanistan. The subject sample was measured before and after a 6 months deployment

\* This research was conducted within the framework of the investigation project "Research of Human Resources and Potentials" sponsored by the Croatian Ministry of Defence and the Institute for Research and Development of Defence Systems.

This research was supported, in part, by grant no. 034-0342610-2609 (Programming of transformational procedures for physical conditioning) from Croatian Ministry of science, education and sport.

with 7 tests used for motor ability assessment and 3 tests used for functional ability assessment. Scarping and skipping test was used for assessment of co-ordination, running with turns test for assessment of agility, standing long jump for assessment of jumping power, 20 metres sprint for assessment of sprinting power and sit and reach test for assessment of flexibility. For evaluation of repetitive strength two standard tests from the Army Physical Fitness Test (APFT) battery were used: 2 minutes push ups and 2 minutes sit ups. The third component of the APFT battery (3200 metres running) was used for assessment of aerobic endurance and the 300 yards shuttle run test was used for assessment of anaerobic endurance. For the  $VO_{2max}$  assessment the ramp treadmill test (Run Race 900, Technogym, Italy) was used. Physical fitness changes from predeployment to postdeployment were analysed using ANOVA.

## Results

Pre- to postdeployment changes are presented in table 1. The soldiers showed increases in flexibility and  $VO_{2max}$ , but those changes were not statistically significant. Decreases were recorded in scarping and skipping, standing log jump, and 20 metres sprint while significant decreases were recorded in running with turns, 2 minutes push ups, 2 minutes sit ups, 3200 metres running and 300 yards shuttle run test.

Table 1. Predeployment to postdeployment changes in physical fitness

	Pre-deployment	Post-deployment	Difference	F-value	p-level
SAS	15,92	16,22	0,30	0,90	0,34
RWT	<b>9,41</b>	<b>9,70</b>	<b>0,28</b>	<b>16,70</b>	<b>0,00</b>
SLJ	207,20	205,67	-1,53	0,75	0,38
R20	4,08	4,11	0,03	1,73	0,19
SAR	3,61	4,04	0,43	0,26	0,61
PUSH2	<b>49,67</b>	<b>35,67</b>	<b>-14,01</b>	<b>69,36</b>	<b>0,00</b>
SIT2	<b>50,83</b>	<b>47,54</b>	<b>-3,28</b>	<b>5,42</b>	<b>0,02</b>
300Y	<b>70,15</b>	<b>72,83</b>	<b>2,67</b>	<b>21,15</b>	<b>0,00</b>
R3200	<b>14,94</b>	<b>16,16</b>	<b>1,22</b>	<b>37,35</b>	<b>0,00</b>
RVO <sub>2max</sub>	45,60	46,98	1,38	2,47	0,12

Legend: SAS-scraping and skipping, RWT-running with turns, SLJ-standing long jump, R20-20 metres sprint, SAR-sit and reach, PUSH2-2 minutes push ups, SIT2-2 minutes sit ups, 300y-300 yards shuttle run, R3200-3200 metres run, RVO<sub>2max</sub>-relative maximal oxygen uptake

## Discussion and conclusions

This investigation indicated changes in physical fitness of CAF members after a six months deployment to Afghanistan. Minor improvements were documented only in  $VO_{2max}$  and flexibility, while decreases were obtained in all other measured variables. These results are not entirely in accordance with the results of previous investigations as Sharp et al. (2008) and Lester et al. (2010) found decreases in aerobic endurance only while strength and power were not affected (Sharp et al., 2008) or were even increased (Lester et al., 2010).

Aerobic and anaerobic endurance were both negatively affected by six months deployment to Afghanistan. These results are in accordance with the results of Sharp et al. (2008) who found decreases in  $VO_{2max}$  assessed through continuous uphill treadmill running protocol and Lester et al. (2010) who documented significant decreases in time to complete 2 mile run test. Decreases in both aerobic and anaerobic endurance are probably related to the reduced daily physical activities and the absence of the organized endurance training sessions. Limited access to training equipment, extended sedentary or guarding activities which demand less movement, combined with high temperature during the day, all contributed to decreasing of endurance capacities. As the predeployment physical preparations were mostly focused on enhancing endurance capacities, the soldiers reached their near maximal values at time of the first testing. The soldiers were, therefore, aerobically highly fit predeployment, so the absence of the organized endurance training as well as reduced physical activity during the day for the period of six months could definitely produce significant decrements in aerobic and anaerobic capacities in recently trained individuals (Mujika and Padilla, 2000).

Interestingly, although aerobic endurance, assessed with 3200 metre run, significantly decreased, the  $VO_{2max}$  increased. This is in contrast to the results of Sharp et al. (2008) who reported significant 4,5% decrement in  $VO_{2max}$ . Increase in  $VO_{2max}$  would be expected if the soldiers had been exposed to high altitude (above 2400 metres) and maintained their aerobic training during deployment which would result in residual increase in haemoglobin (Brothers et al., 2007) and, subsequently, increase in  $VO_{2max}$ . However, the CAF members were not exposed to high altitude. The slight increase in the postdeployment  $VO_{2max}$  was probably due to the latter ramp treadmill test which was scheduled one week after the soldier's return to Croatia while all other tests were performed within 2 days of their return. It is possible that the soldiers were tired and not motivated enough when tested with 3200 metres run and that could be the reason of such discrepancies between these two measures.

Coordination was also negatively affected by deployment to Afghanistan, but these changes were not statistically significant. Significant decrement was found in agility which was assessed with the running with turns test. Decrements in co-ordination and agility were probably due to the reduced physical activity in which complex and explosive type movements in various directions would be performed. These types of movements had also been frequently performed during the predeployment preparations, so the absence of such activities probably led to impairment of these abilities.

The same mechanisms are probably responsible for decrements in jumping and sprinting power. However, these decrements were not significant and the results of this study are in accordance with the results of Sharp et al. (2008) who also documented unchanged performance in vertical jump and with the results of Lester et al. (2010) who found unchanged performance in squat jump. Both authors also documented greater decrements in power and strength in physically fitter soldiers and, therefore, concluded that individuals with higher predeployment fitness would be affected in much greater extent by deployment than those with lower predeployment fitness. As highly fit individuals cannot improve their physical fitness during the military training programme to the same extent as their lower fit counterparts, because they are closed to their maximum (Knapik et al., 2006), it can also be concluded that lower fit individuals do not decrease their physical fitness as much as highly fit individuals when detraining occurs. Based on the predeployment results in power tests, the soldiers monitored in this investigation can be considered as lower fit individuals, so the six month deployment to Afghanistan did not cause major decrements in their sprint and jump performance, even though no organized training was conducted during deployment.

Significant decrements were also found in 2 minutes push ups and 2 minutes sit ups tests used for repetitive strength assessment. These two tests, along with the 3200 metres run test, are generally used in most Armed Forces around the world for evaluation of soldier's physical fitness and this test battery is commonly known as Army Physical Fitness Test (APFT). As Armed Forces in Croatia use APFT battery for evaluation of physical fitness, the predeployment physical preparation programme is often dominantly focused on enhancing exactly these abilities evaluated by the APFT. Therefore, the repetitive strength of Croatian special unit members (Jukić, 2009) and soldiers selected for abroad deployments (Jukić, 2010) is often on a high level. This relatively high level of repetitive strength is difficult to maintain during deployment period when organized training programme no longer continues. Although strength declines slowly during period of first 8-12 weeks of detraining, without adequate strength training stimuli during prolonged period, force production can continue to decrease to the base level in recently trained individuals (Mujika & Padilla, 2000).

Lower back flexibility was unchanged significantly probably due to the very low initial level and unchanged stretching routine during deployment. Low initial level of flexibility indicates poor contribution of stretching exercises in the basic military training programmes and predeployment preparation programmes. Long detraining period, therefore, could not produce major decrements in this ability.

The six month deployment to Afghanistan resulted in significant negative effects on aerobic and anaerobic performance, agility, and upper body and abdominal repetitive strength. However, jumping and sprinting power and coordination were slightly decreased while flexibility and  $VO_{2max}$  slightly increased. The results of this investigation are somewhat different than the previously published ones, indicating that CAF members are more negatively influenced by deployment than US Infantry soldiers (Sharp et al., 2008) and US combat arm soldiers (Lester et al., 2010). Absence of the organized physical training during deployment seems to be the major cause of greater decrements in physical fitness of CAF members. To maintain the predeployment level of physical fitness organized training programmes should be provided to soldiers. Longer and more systematic predeployment physical preparations should also be introduced to CAF.

## References

1. Brothers, M.D., Wilber, R.L., & Byrnes W.C. (2007). Physical fitness and hematological changes during acclimatization to moderate altitude: A retrospective study. *High Altitude Medicine & Biology*, 8(3), 213-224.
2. Jukić, I. (2009). Cjelovito evaluacijsko izvješće za 2008. i 2009. godinu. [The integral evaluation report for 2008 and 2009. In Croatian.] Zagreb: Kineziološki fakultet Sveučilišta u Zagrebu
3. Jukić, I. (2010). Završno evaluacijsko izvješće za 2010. godinu. [The final evaluation report for 2010. In Croatian.] Zagreb: Kineziološki fakultet Sveučilišta u Zagrebu
4. Knapik, J.J., Scott, S.J., Sharp, M.A., Hauret, K.G., Darakjy, S., Rieger, W.R., Palkoska, F.A., VanCamp, S.E., & Jones, B.H. (2006). The basis for prescribed ability group run speeds and distances in U.S. Army basic combat training. *Military Medicine*, 171, 669-677.
5. Lester, M.E., Knapik, J.J., Catrambone, D., Antczak, A., Sharp, M.A., Burrell, L., & Darakjy, S. (2010). Effect of a 13-month deployment to Iraq on physical fitness and body composition. *Military Medicine*, 175(6), 417-423.
6. Mujika, I., & Padilla, S. (2000). Detraining: Loss of training-induced physiological and performance adaptations. Part II. *Sports Medicine*, 30(3), 145-154.
7. Sharp, M.A., Knapik, J.J., Walker, L.A., Burrell, L., Frykman, P.N., Darakjy, S.S., Lester, M.E., & Marin, R.E. (2008). Physical fitness and body composition after 9-month deployment to Afghanistan. *Medicine & Science in Sports & Exercise*, 40(9), 1687-1692.

## EFFECTS OF TWO DIFFERENT 5 WEEKS TRAINING PROGRAMS ON THE PHYSICAL FITNESS OF MILITARY RECRUITS\*

Dražen Harasin<sup>1</sup> and Josip Šopar<sup>2</sup>

<sup>1</sup>Faculty of Kinesiology, University of Zagreb, Croatia

<sup>2</sup>Croatian Armed Forces, Zagreb, Croatia

### Abstract

The purpose of this study was to compare the effects of programmed continuous endurance and relative strength training (CERS) with the basic military physical readiness training (BMPR) on the physical readiness. Croatian military recruits (21.3±1.9 years) were divided in the CERS (N=48) and BMPR (N=76) groups. Training sessions were conducted three times a week for a total of 5 weeks. The t-test determined positive training effects for both training programs. Significant positive changes in BMPR group were measured in almost all measured variables. In CERS group, besides the 20 m dash run, statistically significant positive changes were not determined in standing horizontal jump, pull-ups and sit and reach test. The positive training effects in both training groups were achieved because of the low initial physical readiness level of the recruits and a short training period in which the statistically significant differences between programs could not be achieved.

**Key words:** strength training, military, impact, endurance

### Introduction

The Armed Forces of the Republic of Croatia adopted a long term development plan for the period between the years 2006 and 2015. One of the main components of that plan is to improve the morphological, fitness and psychological profile as well as basic and specific military skills of the Armed Forces' recruits. One of the most important objectives of the military is to achieve and maintain a high fitness level while minimizing injury risk (Knapik, Rieger, Palkoska, Van Camp & Darakjy, 2009).

The critical element of success for new recruits who enter basic combat training has been identified as the physical fitness (Knapik et al., 2006). Physical fitness can be defined in number of ways, but it can be described as one's state which allows the completion of most demanding physical task set in various situations. Improvements of the physical fitness are specifically related to the type of training performed (Santilla, Hakkinen, Karavirta, & Kyrolainen, 2008; Kraemer et al., 2004). In order to achieve high fitness level and to reduce injury risks the development and application of an optimal physical training program is required. The physical training program is designed to prepare a soldier for the physically demanding tasks performed in various military operations according to the requirements of the deployment (Sharp et al., 2008).

The physical fitness consists of several components which include endurance, strength and mobility (Knapik et al., 2009). Each component of physical fitness can be identified through the application of various tests. The physical fitness of the military personnel including recruits is mainly assessed by muscle endurance tests and distance coverage tests in which mainly the aerobic power is assessed through the calculation of the  $VO_{2max}$ , the maximum rate of oxygen consumption expressed per unit of body mass (Vanderburgh, 2007; Mello, Murphy & Vogel, 1988). There is a wide spectre of tests used to assess the endurance of military personnel which can be divided in two different categories. The first category consists of tests which include running tasks with load and the second category consists of tests which do not (Harman et al., 2008). A strong preference exists towards the tests without load since such tests do not require transport, storage, securing and maintaining of the equipment (Harman et al., 2008).

The main purpose of this study was to determine if the five week Continuous Endurance and Relative Strength (CERS) training modality has a significantly greater impact than the Basic Military Physical Readiness program (BMPR) on the physical fitness of the recruits.

\* This research was conducted within the framework of the investigation project "Research of Human Resources and Potentials" sponsored by the Croatian Ministry of Defence and the Institute for Research and Development of Defence Systems.

This research was supported, in part, by grant no. 034-0342610-2609 (Programming of transformational procedures for physical conditioning) from Croatian Ministry of science, education and sport.

## Methods

The population from which the sample of this study was selected is the third generation of Croatian Armed Forces military recruits. A number of 124 male and female military recruits with an average age of 21.3±1.9 years, participated in this study. Recruits voluntarily participated in the study, were carefully informed about the study and signed a written consent before the experiment. All experimental procedures were approved by the Ethics Committee of the Faculty of Kinesiology, University of Zagreb.

The participants were divided in two groups, the Basic Military Physical Readiness group (N=76) and the Continuous Endurance and Relative Strength group (N=48). Participants which did not take part in every test either initial or final testing, were excluded from the study. The participants which did not complete the planed training program were also excluded from the study.

Table 1. Training protocol overview for the BMPR and CERS groups

Mesocycle	1	2	3	4	5	Σ
Calendar duration	21.09 – 26.09	28.09 – 2.10	5.10 – 10.10	12.10 – 17.10	19.10 – 23.10	/
Number of days	5	5	5	5	5	25
Days of training	3	3	3	3	3	15
Number of training	3	3	2	2	3	13
Hours of training	6	6	4	4	6	26
Testing days	Initial testing			14.09 – 19.09		
	Final testing			2.11 – 6.11		

The BMPR group followed a standardized training program which is defined in the Basic program of Military Recruits. Such program was conducted with the first two generations of Croatian Armed Forces military recruits. The standardized training program was conducted by the leaders of each individual unit. The trainings conducted in the units were mainly oriented to the development of muscular repetitive strength and aerobic endurance. The running sessions consisted of both interval and continuous running modalities.

The trainings in the CERS group were conducted by P.E. teachers from the Faculty of Kinesiology University of Zagreb. The training program in the CERS groups was mainly oriented towards the development of the aerobic endurance and relative repetitive strength by inducing the participants to running sessions of continuous type, calisthenics and exercises in pairs.

## Physical fitness tests

The scraping and skipping (SAS) test for assessment of co-ordination was performed indoors in a minimum of 9x2 m surface dimensions. The *running eights with bending* (REB) test for co-ordination assessment was performed indoors on a minimum of 6x3 m dimensions hard surface. The *20 yard shuttle run* (20YSR) was conducted to determine the agility of military recruits. The *medicine ball throw* (1 kg) from sitting position (MBTIKG) was performed to test the throwing power. For the assessment of jumping power four tests were used. The *countermovement jump* (CMJ), the *maximal countermovement jump* (MCMJ) test and the *continuous jumps with straight legs* (CJSL) were performed on a force platform on which vertical jump height and power were measured (Quattro Jump, Kistler Switzerland, Paren Co.). The *standing horizontal jump* (SHJ) was also conducted. For the assessment of sprinting performance the *20 meters dash* (S20M) test was performed indoors using photocells (Photo-cell system by RS, Croatia). Muscular endurance tests included *push-ups in 2 minutes* (PU2), *sit-ups in 2 minutes* (SU2), *pull-ups* (PULL) and *squats in 1 minute* (SQ1). To determine the maximal muscular strength the *maximal bench press* (BP) was conducted. Flexibility was assessed with the *sit and reach test* (S&R) with the standard measuring method. Anaerobic power was assessed indirectly through the *300 yards shuttle run test* (300Y) and aerobic power was tested through the *3200 m run* (3200M) which is a commonly used test by Military Forces for testing physical fitness as it is included in the Army Physical Fitness Test (APFT) battery.

## Statistical analyses

The results are presented as MEAN±SD. After the initial states have been determined and after the participants have been divided in the BMPR and CERS groups, a t-test was used to determine initial differences. The t-test was also used to determine the differences between the groups in the final testing and differences within groups after the conducted training programs. Statistical significance was set at p<.05. Effect sizes (ES) were calculated by Cohen's suggested method for the magnitude of treatment effects within groups. The Statistica 7.0 for Windows statistical package (Statsoft Inc., Tulsa, Oklahoma) was used to process and report the data.

## Results

The training program applied in the BMPR group made significant improvements to Military recruits physical fitness. If coordination is observed after the final testing, participants have made a progress of -7.6% (ES=-0.48,  $p<0.05$ ) in the SAS test, -2.2% (ES=-0.32,  $p<0.05$ ) in the REB test, -8.8% (ES=-1.35,  $p<0.05$ ) in the 20YSR test. In terms of power, the participants showed significant progress in almost all tests. A 6.7% (ES=0.39,  $p<0.05$ ) increase was determined in the MBT1KG test, a 9.2% (ES=0.59,  $p<0.05$ ) increase in the CMJ test, a 7.4% (ES=0.54,  $p<0.05$ ) increase in the MCMJ test, a 5.7% (ES=0.35,  $p<0.05$ ) increase in the CJSL test, a 4.1% (ES=0.35,  $p<0.05$ ) increase in the SHJ test and no significant increase was determined in the S20M test.

In muscular repetitive strength participants showed significant improvements in all tests. A significant increase of 67.5% (ES=1.51,  $p<0.05$ ) was noted in the PU2 test, a significant increase of 43.4% (ES=1.4,  $p<0.05$ ) in the SU2 test, a 10% increase in the PULL test and 14% (ES=0.70,  $p<0.05$ ) increase was noted in the SQ1 test. In terms of flexibility, the participants of the BMPR group achieved a significant improvement of 26.5% (ES=0.37,  $p<0.05$ ) in the S&R test. Anaerobic endurance which was measured by the 300Y test was improved by -2.2%, and aerobic endurance, assessed through the 3200M test, was significantly improved by -9.82% (ES=-0.42,  $p<0.05$ ).

The training program applied in the CERS group also made significant improvements to military recruits physical fitness. In coordination, participants have made significant progress of -8.1% (ES=-0.37,  $p<0.05$ ) in the SAS test, -2.7% (ES=-0.37,  $p<0.05$ ) in the REB test and -1.9% (ES=0.33,  $p<0.05$ ) in the 20YSR test. In terms of power, the participants showed significant progress in four of the six tests. A 9.9% (ES=0.55,  $p<0.05$ ) increase was determined in the MBT1KG test, a 10.2% (ES=0.81,  $p<0.05$ ) increase in the CMJ test, a 6.0% (ES=0.43,  $p<0.05$ ) increase in the MCMJ, a 13.9% (ES=0.96,  $p<0.05$ ) increase in the CJSL test, and no significant increase in the results of SHJ test and in the 20 meter dash test. In repetitive strength participants showed significant improvements in all four tests. A 80.8% (ES=1.78,  $p<0.05$ ) increase was noted in the PU2 test, a 39.1% (ES=1.24,  $p<0.05$ ) increase in the SU2 test and 11.6% (ES=0.60,  $p<0.05$ ) increase was noted in the SQ1 test. No significant increase was noted in the PULL test. In the S&R test the participants of the CERS group did not achieve a statistically significant improvement. Anaerobic endurance, measured by the 300Y test, was improved by 4.89% (ES=-0.49,  $p<0.05$ ), and aerobic endurance, assessed through the 2 mile run test, was improved by 13.46% (ES=-0.89,  $p<0.05$ ).

The t-test showed no significant difference between the participant's initial states in the two groups except in the 20YSR test. After analyzing the final state of the participants, the t-test showed no statistically significant difference between the groups in any test.

Table 2. Physical fitness before the training program (Mean±SD)

	Before Training		After training	
	BMPR	CERS	BMPR	CERS
SAS (sec)	14.4±2.3	14.8±3.2	13.3±2.0	13.6±1.9
REB (sec)	18.1±1.3	18.2±1.4	17.7±1.0	17.7±1.1
20YSR (sec)	5.7±0.4*	5.3±0.3*	5.2±0.3	5.2±0.2
MBT1KG (cm)	79.7±13.4	76.7±13.8	85.0±14.2	84.3±11.9
CMJ (cm)	38.0±5.9	38.1±4.8	41.5±5.1	42.0±4.9
MCMJ (cm)	47.5±6.5	48.1±6.8	51.0±7.1	51.0±5.5
CJSL (cm)	33.5±5.4	32.4±4.7	35.4±4.7	36.9±5.5
SHJ (cm)	209.3±24.8	211.2±24.0	217.8±23.5	215.7±16.5
S20M (sec)	3.8±0.3	3.9±0.3	3.8±0.3	3.8±0.3
PU2	31.7±14.1	30.2±13.7	53.1±15.0	54.6±16.1
SU2	48.4±15.0	49.4±15.6	69.4±11.7	68.7±15.1
PULL	5.0±8.9	4.3±3.1	5.5±3.7	4.8±3.7
SQ1	44.3±8.9	45.1±8.6	50.5±7.2	50.3±6.3
BP (kg)	62.4±18.3	63.9±13.2	76.8±18.9	73.7±15.2
S&R (cm)	9.8±7.1	9.2±6.4	12.4±6.5	10.3±6.2
300Y (sec)	66.9±5.4	68.1±6.8	65.4±4.2	64.8±4.8
3200M (sec)	944.3±211.2	± 148.5	856.2±84.6	851.0±73.5

\*  $p<0.05$  for BMPR vs CERS. Scraping and Skipping (SAS), Running eights with bending (REB), 20 yard shuttle run (20YSR), Medicine ball throw (1 kg) from sitting position (MBT1KG), Squat jump (SJ), Maximal countermovement jump (MCMJ), Continuous jumps with straight legs (CJSL), Standing horizontal jump (SHJ), Push-ups in 2 minutes (PU2), Sit-ups in 2 minutes (SU2), Pull-ups (PULL), Squats in 1 minute (SQ1), Maximal bench press (BP), Sit and reach test (S&R), 300 yards shuttle run test (300Y), 3200 m run (3200M)



## Discussion and conclusion

Both training programs provided positively effective training stimuli in terms of co-ordination, but either the low initial level of coordinative abilities in both groups or the short training period did not allow statistically significant differences between groups in the final measurement. Previous researches revealed very little information regarding the changes of the co-ordination as most of the physical readiness evaluations were made using Army Physical Fitness Test (APFT) battery. However, a few investigators evaluated physical readiness training programs through recording times of completing more or less demanding military obstacle courses. Therefore, the results obtained in this research can only be compared with the results of the previous investigations containing obstacle course times. In a study (Harman et al., 2008) improvements were obtained in obstacle course times both in army standardized physical training (16%) and weight-based training group (10%). The authors conclude that the improvements in obstacle course time depend on improvements in aerobic endurance and strength. However the structure of the coordination tests used in this research could not propose improvements based on the enhancement of the other abilities such as aerobic endurance and repetitive strength.

Muscular endurance is of key value to any member of the military. By inspecting both applied training programs it can be concluded that they were oriented towards the development of muscular endurance, which was proven successful. Significant achievements have been noted in all tests of both groups, except for the CERS group in the pull-ups test. The participants of the BMPR group showed higher improvements in the four conducted tests. This can be explained with higher volume of endurance training conducted in the CERS group and the execution sequence of two concurrent training segments. The most consistent finding to emerge from the concurrent training literature is that increases in strength and power during concurrent training are reduced when compared with strength training alone (Leveritt, Abernethy, Barry & Logan, 1999). As the CERS training program was consisted of continuous distance running and relative strength training only, the total volume of endurance training was definitely higher than in the BMPR training program. The higher amount of total endurance training probably limited the development of strength in CERS group more than it was the case for the BMPR group. Furthermore, the modality of endurance training was also emphasized as a limiting factor of strength gains in concurrent trainings (Leveritt, et al., 1999).

The flexibility is the ability which allows one or multiple joint systems in the body to achieve maximum amplitude of movements. A statistically significant improvement in lower back flexibility has been registered for the examinees in the BMPR training group whereas in the CERS training group improvements were not statistically significant. The CERS training program did not include specific stretching exercises and major flexibility improvements were not expected upon conclusion of the program. Nonetheless, 10-15 minutes stretching was implemented in the warm-up section of each training session and prescribed exercises were completed before the endurance training sequence. Warm-up program included all major body joints stretching through the dynamic stretching exercises. On the other hand, besides stretching during the warm-up, the BMPR training program included 2 separate training sessions oriented specifically towards improvements in flexibility. One of the main goals of the BMPR training program was actually improvement in flexibility as it is known from the literature that flexibility deters injuries during physical activities (Woods, Bishop, & Jones, 2007). The statistically significant improvements in flexibility for the BMPR group were, therefore, probably due to the larger total volume of the stretching executed and more flexibility oriented training program.

The applied 5-week training programs were used to determine significant improvements on the physical fitness of military recruits which could eventually be called up for deployment. It was of extreme importance to prove whether such short lasting programs can cause advancements in the physical fitness of the observed military personnel. The participants of this study have shown statistically significant progress in almost all tests after the applied training programs. The training program of the BMPR group established greater advances in some motor abilities comparing to the CERS group. However, the training program of the CERS group achieved greater advances in both endurance tests. There were no practical differences between the effects of the two training programs at the final testing. Such occurrence can be explained with the fact that both training programs targeted the majority of physical fitness components at the same time. One of the limitations of this study is also that it lasted only 5 weeks, which is relatively short to prove any significant differences between conducted training programs. It is especially emphasized when the programs are conducted on low physically prepared examinees as was the case in this research. The number of trainings performed during the training program can also be lined as a limitation to differentiate the transformational effects between the two groups. The participants had shown a poor physical fitness profile in the initial testing which point out to the fact that their pretesting physical activity was poor. Applying a targeted conditioning training program on any population which is physically inactive will show improvements, but will trigger only the first physiological responses and adaptation processes to physical activity.

## References

1. Harman, E.A., Gutekunst, D.J., Frykman, P.N., Nindl, B.C., Alemany, J.A., Mello, R.P., & Sharp, M.A. (2008). Effects of two different eight-week training programs on military physical performance. *Journal of Strength and Conditioning Research*, 22, 524-34.
2. Knapik, J.J., Darakjy, S., Kieth, G.H., Canada, S., Scott, S., Rieger, W., Marin, R., & Jones, B.H. (2006). Increasing the Physical Fitness of Low-Fit Recruits before Basic Combat Training: An Evaluation of Fitness, Injuries and Training Outcomes. *Military Medicine*, 171, 45-53.
3. Knapik, J.J., Rieger, W., Palkoska, F., Van Camp, S., & Darakjy, S. (2009). United States Army Physical readiness training, Rationale and evaluation of the physical training doctrine. *Journal of Strength and Conditioning Research*, 23, 1353-62.
4. Kraemer, W.J., Vescovi, J.D., Volek, J.S., Nindl, B.C. Newton, R.U., Patton, J.F., Dziados, J.E., French, D.N., & Hakkinen, K. (2004). Effects of concurrent resistance and aerobic training on load-bearing performance and the Army physical fitness test. *Military Medicine*, 169, 994-9.
5. Leveritt, M., Abernethy, P.J., Barry, B.K., & Logan, P.A. (1999). Concurrent strength and endurance training: A review. *Sports Medicine*, 28, 413-27.
6. Mello, R.P., Murphy, M.M., Vogel, J.A. (1988). Relationship Between a Two Mile run for Time and Maximal Oxygen uptake. *Journal of Applied Sports Science Research*, 2, 9-12.
7. Santilla, M., Hakkinen, K., Karavirta, L., & Kyrolainen, H. (2008). Changes in Cardiovascular Performance during an 8-Week Military Basic Training Period Combined with Added Endurance or Strength Training. *Military Medicine*, 173, 1173-9.
8. Sharp, A.M., Knapik, J., Walker, L., Burrell, L., Frykman, P.N., Darakjy, S.S., Lester, M.E., & Marin, R.E. (2008). Physical Fitness and Body Composition after a 9-Month Deployment to Afghanistan. *Medicine and Science in Sports and Exercise*, 40, 1687-92.
9. Vanderburgh, P.M. (2007). Correction Factors for Body Mass Bias in Military Physical Fitness Tests. *Military Medicine*, 172, 738-42.
10. Woods, K., Bishop, P., & Jones, E. (2007). Warm-up and stretching in the prevention of muscular injury. *Sports Medicine*, 37, 1089-99.

## DIFFERENCES IN MOTOR STATUS OF ACTIVE AND SEDENTARY SOLDIERS\*

Vladimir Manojlović, Mario Jovanović and Dražen Harasin

Faculty of Kinesiology, University of Zagreb, Croatia

### Abstract

The aim of this research was to investigate the differences between active and sedentary members of the special units in the Croatian Armed Forces. Such research until now was not conducted in the Croatian Armed Forces. Participants were active members of the special units ( $n = 60$ ; mass =  $82,49 \pm 7,36$  kg, height =  $178,56 \pm 6,32$  cm, age =  $32 \pm 5,6$  yrs) and sedentary members of the special units ( $n = 60$ ; mass =  $84,71 \pm 11,39$  kg, height =  $177,84 \pm 5,79$  cm, age =  $34 \pm 7,1$  yrs). Applied tests included measurements of flexibility, co-ordination and agility, jumping and sprinting power, repetitive strength and aerobic endurance. Independent samples *t-test* revealed a significant difference for most tests in favor of active members of the special units, except for the tests *cross running with bending*, *lying leg spread* and *stick overflip*, where no significant differences were found.

**Key words:** *physical fitness, military, Armed Forces, special units*

### Introduction

The Croatian Armed Forces (CAF) accepted the long-term development plan for the period of 6 years. Since CAF joined the NATO, it has transformed into a small and professional army and is now structured alike many other military systems and associations in the world. Soldiers are selected into army branches, and each army branch has its own specialty, which is characterized and differentiated by specific operational tasks. Those specific requirements are manifested through differences in health status, psychological characteristics, physical fitness level and sociological characteristics of the specific branch members.

Fitness training is an important component in the preparation for the army (Ricciardi et al., 2008). Maybe the most important ability in the performance of soldiers is endurance (Jette et al., 1989, Beckett et al., 1989, Thomas et al., 1994, Pemrick, 1999) and this physical component is mostly influenced by military training programs. Some authors also emphasize power as a very important ability which helps soldiers to perform high-intensity tasks dominantly comprised of sprinting and jumping (Prusaczyk et al., 1992, Hyde et al., 1997). However, co-ordination, speed and flexibility are not considered to be of great importance for the soldiers (Pemrick, 1999).

In the recent years there has been a growing interest for the scientific evaluation of military training programs on various populations and in various conditions. Harman et al. (2008) showed that respondents significantly improved their speed, agility and flexibility after treatment. The subjects tested were military recruits and members of the military reserve, and those populations are not characterized with high level of physical fitness.

Even though a great number of studies have been conducted on military populations, there was no study which defined the difference between active and sedentary soldiers in the special units of the CAF. The aim of this study was to determine differences in physical fitness of active and sedentary professional soldiers. The study hypothesis was that the active soldiers are in better physical shape than their sedentary counterparts in all physical tests measured.

### Methods

Participants were active members of the special units ( $n = 60$ ) engaged in military operations on the field (mass =  $82,49 \pm 7,36$  kg, height =  $178,56 \pm 6,32$  cm, age =  $32 \pm 5,6$  yrs) and sedentary members of the special units ( $n = 60$ ) engaged in logistics (mass =  $84,71 \pm 11,39$  kg, height =  $177,84 \pm 5,79$  cm, age =  $34 \pm 7,1$  yrs) with full employment in the same affiliation. Selection of soldiers into special units was based on their above-average fitness level and adequate psychological capabilities as well as greater military knowledge and better skill performance.

\* This research was conducted within the framework of the investigation project "Research of Human Resources and Potentials" sponsored by the Croatian Ministry of Defence and the Institute for Research and Development of Defence Systems.

This research was supported, in part, by grant no. 034-0342610-2609 (Programming of transformational procedures for physical conditioning) from Croatian Ministry of science, education and sport.

Motor abilities measurement protocol was standardized and each subject underwent the protocol under same conditions.

*Scraping and skipping (MSAS)*, *ascending and descending a Swedish ladder (MA&D)*, *polygon backwards (MPB)* and *cross running with bending (MCRB)* were used for the assessment of co-ordination.

For the assessment of flexibility the *Spread legs sit and reach (MSLS&R)*, *lying leg spread (MLLS)* and *stick overflip (MSO)*. *Medicine ball throw (MEPT)*, *standing long jump (MSLJ)*, *relative sargent (MRS)* and *20 m dash sprint (MS20)* were used for the assessment of the throwing, jumping and sprinting power, while *2-minute push-up (M2PU)*, *2-minute sit-ups (M2SU)*, *pull-ups (MPU)* and *1-minute squats (MSQ1)* were used for the repetitive strength assessment. To evaluate the aerobic endurance the *3200 m running (MR3200)* test was used.

Data was analyzed using the STATISTICA 8.0. Numerical data is expressed through a mean ( $\pm$ SD). Normal distribution of the variables was tested using *Kolmogorov-Smirnov test*. An independent samples *t*-test was used to determine the difference between active and sedentary members of the special units. The level of significance was set at  $p \leq 0.05$ .

## Results

An independent samples *t*-test revealed significant differences for each test in favor of active members of the special units, except for MCRB, MLLS, MSO, where no significant differences were found.

Table 1. Results in tests assessing motor capacities between active and sedentary members of the special units

	Mean ( $\pm$ SD)		Statistical significance
	Active	Sedentary	p-value (* $p \leq 0.05$ )
MSAS	13.36 $\pm$ 1.96	15.02 $\pm$ 2.72	0.0002*
MA&D	18.33 $\pm$ 3.27	19.97 $\pm$ 4.04	0.0160*
MPB	9.72 $\pm$ 1.39	11.59 $\pm$ 2.67	0.0008*
MCRB	12.43 $\pm$ 0.66	12.67 $\pm$ 0.79	0.0735
MSLS&R	62.76 $\pm$ 12.92	53.48 $\pm$ 16.79	0.0009*
MLLS	100.67 $\pm$ 14.73	101.79 $\pm$ 15.41	0.6848
MSO	91.29 $\pm$ 15.32	92.19 $\pm$ 19.68	0.7803
MEPT	87.91 $\pm$ 10.06	81.48 $\pm$ 11.49	0.0020*
MSLJ	231.01 $\pm$ 19.74	218.57 $\pm$ 22.23	0.0015*
MRS	45.24 $\pm$ 5.53	42.83 $\pm$ 7.28	0.0434*
MS20	3.85 $\pm$ 0.15	4.18 $\pm$ 0.44	0.0000*
M2PU	49.49 $\pm$ 16.55	32.00 $\pm$ 14.18	0.0000*
M2SU	67.28 $\pm$ 17.05	45.46 $\pm$ 17.06	0.0000*
MPU	7.83 $\pm$ 4.07	2.39 $\pm$ 2.35	0.0000*
MSQ1	47.56 $\pm$ 8.46	44.18 $\pm$ 9.62	0.0432*
MR3200	947.60 $\pm$ 112.90	1034.04 $\pm$ 97.79	0.0000*

## Discussion and conclusions

The aim of this study was to determine the differences between active and sedentary soldiers in special units of the Croatian Armed Forces. The assumption was that the active soldiers, in comparison to sedentary soldiers, will show higher level of their physical fitness due to the higher amount of physical activity performed daily as a job requirement. The results obtained in this research confirm the set up hypothesis with an exception of one coordination test, and a couple of flexibility tests.

As endurance and repetitive strength are emphasized as the most important physical requirement for professional soldiers (Jette et al., 1989) and since Bovill et al. (2003) stated that conditioning training of the special units is similar to the elite sport training, the results obtained in this research are not surprising.

It is logical to conclude that the active soldiers are physically superior to their sedentary counterparts as their physical requirements are much more demanding and, thus, their physical fitness is constantly improved. Pemrick, (1999) showed that the abilities such as flexibility and co-ordination are not of essential importance for implementation into conditioning program to the U.S. Special Forces rangers. Although the selection procedures, as well as the process of fitness training of U.S. Special Forces rangers differ from the one of the Croatian Armed Forces, the results of Pemrick's research might be a reason for not finding a significant difference in MCRB, MLLS, and MSO in this research, as it is possible that

these abilities in active-duty soldiers were not exercised more than in sedentary soldiers. Although previously conducted researches suggests such conclusions, further researches should include analyses of daily activities as well as training regimes for both groups of subjects in order to get more valuable information

The confirmed hypothesis is important because it revealed the fundamental differences in physical fitness status between active and sedentary soldiers of the special units of the CAF. While similar investigations have already been documented for soldiers in the Army across the world, in the CAF this is the first of such kind. The results obtained support the importance of physical fitness training in the Army. It also showed that the conditioning was carefully planned and implemented, since significant differences were found in favor of active soldiers, but also sedentary soldiers are appeal to improve their physical status, even though their job requirements are not physical.

## References

1. Beckett, M.B., Goforth, H.W., Hodgdon, J.A. (1989). Physical Fitness of US Navy Special Forces Team Members and Trainees. *Naval Health Research Center, San Diego, CA*. Technical Report 89-29, Report number A960312.
2. Bovill, M.E., Tharion, W.J., Lieberman, H.R. (2003). Nutrition Knowledge and Supplement Use among Elite U.S. Army Soldiers. *Military Medicine*, 168(12), 997-1000.
3. Harman, E.A., Gutekunst, D.J., Frykman, P.N., Nindl, B.C., Alemany, J.A., Mello, R.P., Sharp, M.A. (2008). Effects of two different eight-week training programs on military physical performance. *Journal of Strength and Conditioning Research*, 22(2), 524-534.
4. Hyde, D., Thomas, J.R., Schrot, J., Taylor, W.F. (1997). Quantification of Special Operations Mission-Related Performance: Operational Evaluation of Physical Measures. *Naval Medical Research Institute, Bethesda, MD.*, Technical report 97-01, Report number A112183.
5. Jette, M., Kimick, A., Sidney, K. (1989). Evaluating the occupational physical fitness of Canadian Forces infantry personnel. *Military Medicine*, 154(6), 318-322.
6. Pemrick, M.D. (1999). Physical Fitness and the 75<sup>th</sup> Ranger Regiment: The Component of Physical Fitness and the Ranger Mission. *Army Command and general Staff College, Fort Leavenworth, KS.*, Report Number A267763.
7. Prusaczyk, W.K., Goforth, H.W., Nelson, M.L. (1992). Characteristics of Physical Training Activities of West Coast U.S. Navy Sea-Air-Land Personnel (SEALS). *Naval Health Research Center, San Diego, CA.*, Report number A524162.
8. Ricciardi, R., Deuster, P.A., Taibot, L.A. (2008). Metabolic Demands of Body Armor on Physical Performance in Simulated Conditions. *Military Medicine*, 173(9), 817-824.
9. Thomas, J.R., Schrot, J., Butler, F.K., Curley, M.D. (1994). Quantification of Special Operations Mission-related Performance: Performance Database. *Naval Medical Research Institute, Bethesda, MD.*, Report Number NMRI 94-66.

## DAILY LOAD OF CROATIAN SOLDIERS DURING THE PEACEKEEPING MISSION IN AFGHANISTAN

Tomislav Pisačić<sup>1</sup> and Vedran Naglić<sup>2</sup>

<sup>1</sup>Faculty of Kinesiology, University of Zagreb, Croatia

<sup>2</sup>FC Zagreb, Croatia

### Purpose

The purpose of this investigation was to define the level of daily load in Croatian soldiers who served in peacekeeping mission in Afghanistan.

### Methods

A total of 67 subjects, members of the Croatian Armed Forces (CAF) deployed to Afghanistan, participated in the investigation. During the 194 days long mission, all soldiers were requested to fulfil their Daily Load Journal on a daily basis. Those journals contained the list of 21 questions which served to provide insight into the daily working load of soldiers. Variables in this analysis were: number of infantry marches (NIM), overall distance covered with infantry march (DCIM), total marching time (TMT), average equipment weight (AEQ), average air temperature (AAT), number of physically active days (NPAD), average time spent in physical activity (ATSPA), average grade of total daily loading (AGTDL) and body weight range (BWR). Descriptive statistical methods were used for data analysis.

### Results

Table 1. Standard descriptive parameters

	NIM	DCIM (km)	TMT (hours)	AEQ (kg)	AAT (C°)	NPAD	ATSPA (hours)	AGTDL	BWR (kg)
AS	2,4	13,2	5,3	11,8	35,1	50,1	16,8	2,8	4,7
SD	4,51	31,03	13,15	14,74	3,80	102,19	24,43	0,60	3,62
MIN	0,00	0,00	0,00	0,00	24,59	0,00	0,00	1,44	0,00
MAX	23,00	139,00	57,50	62,14	45,54	117	183,44	3,95	16,00
RANGE	23,00	139,00	57,50	62,14	20,95	117	183,44	2,51	16,00

### Conclusions

Peacekeeping military missions in Afghanistan represent a great challenge for the soldiers. The soldier's daily load, considering physical effort in performing all-day actions, is very low on average. Great difference in individual results between soldiers suggest large professional differentiation in terms of daily and overall physical activity and, therefore, in the required fitness level. These are the result of different task organization defined in accordance with the soldiers' professional speciality. Great deviation of the body weight can be ascribed to stressful situations the soldiers were involved in. Very low average of free-time activities is noticeable, and this can contribute to physical fitness deterioration post-deployment.

**Key words:** *infantry march, physical activity, military*

This research was conducted within the framework of the investigation project "Research of Human Resources and Potentials" sponsored by the Croatian Ministry of Defence and the Institute for Research and Development of Defence Systems.

## WORKING LOAD PARAMETERS OF SOME ACTIVITIES DURING SPECIAL FORCES TRAINING

Josip Šopar

Croatian Armed Forces, Zagreb, Croatia

### Purpose

Purpose of this investigation is to determine and compare the intensity of the basic and specific conditioning activities during Special Forces (SF) basic training.

### Methods

Thirteen attendees of the SF basic training (age 26,36±4,68; body height 178,79±6,67; body mass 80,05±8,69) were engaged in the investigation. Intensity assessment was conducted with heart rate monitor (Polar, RS800). Specific activities measured were 18km march with load defined for 24 hours lasting military operations and 60km march with load defined for 48 hours lasting military operations. Both marches included carrying personal weapon. Basic conditioning activities occurred every day in the form of physical training and were consisted of 50 minutes cross country running, relative muscular endurance exercising (pull ups, push-ups, sit-ups, squats, etc.) and basic combative elements practicing.

### Results

The intensity during both marches was dominantly between 60-69% of maximal intensity. During 60km march more than 70% of overall time was spent in zones of low and very low intensity. In contrary to the load marches, everyday physical training showed that the highest percentage of training time is spent in sub maximal zone, but also significant amount of time was spent in maximal intensity zone.

Table 1. Intensity of specific and basic activities in Special Forces training

ACTIVITIES	N	DURATION (hours: minutes)	MIN HR (bpm)	MEAN HR (bpm)	MAX HR (bpm)	90-100% (%)	80 – 89% (%)	70 – 79% (%)	60 – 69% (%)	50 – 59% (%)	0 – 49% (%)
March18km	13	03:40	81	119	152	0	4	26	49	20	1
March 60km	12	11:18	59	109	152	0	5	16	32	31	16
PT	10	02:00	82	136	186	13	32	18	24	12	1

HR – heart rate; PT – physical training

### Conclusions

Military marches with load are performed with low intensity as their goal is not only to overcome certain distance in a short period of time, but also to assure that the soldier is able to execute designated missions after marched distance. The longer the march the bigger the distribution of time in low intensity zones is. Information on intensity of performed activities will enable quality management of physical preparation strategies.

This research was conducted within the framework of the investigation project “Research of Human Resources and Potentials” sponsored by the Croatian Ministry of Defence and the Institute for Research and Development of Defence Systems.

## THE RELATIONS OF MORPHOLOGICAL DIMENSIONS AND PHYSICAL FITNESS AMONG CROATIAN ARMED FORCES MEMBERS

Vedran Naglič<sup>1</sup> and Tomislav Pisačić<sup>2</sup>

<sup>1</sup>FC Zagreb, Croatia

<sup>2</sup>Faculty of Kinesiology, University of Zagreb, Croatia

### Purpose

The purpose of this study was to examine the impact of morphological dimensions (MD) on physical fitness (PF) tests performance among professional members of the Croatian Armed Forces (CAF).

### Methods

The subject sample was consisted of 579 members of the CAF. Morphological characteristics were assessed with 25 anthropometric measures, while for assessment of PF a total of 25 motor and functional tests were used. Pearson correlation coefficient was used for determining the relations between MD and PF among the members of the CAF.

### Results

All PF components are negatively correlated with the body fat dimension and positively correlated with dimension of body mass. The dimension of skeletal dimensionality is negatively correlated with repetitive strength, flexibility, coordination, agility and  $VO_{2max}$  and positively correlated with power and anaerobic and aerobic endurance.

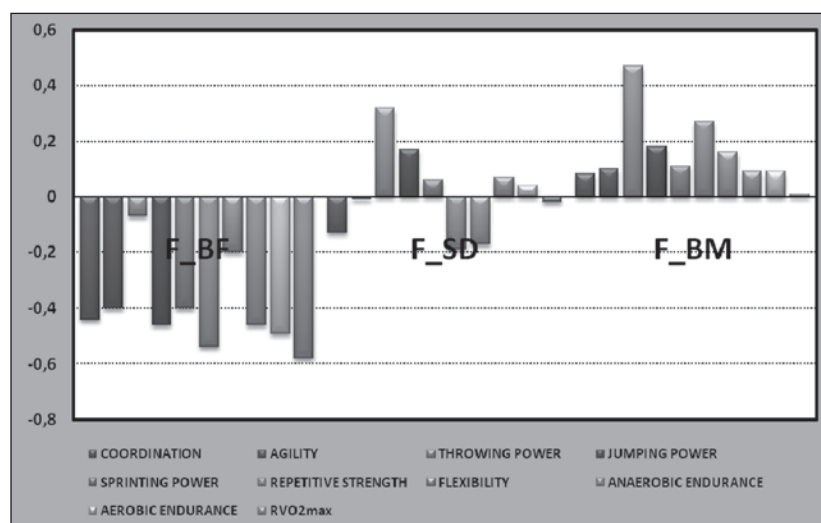

### Conclusions

The results show that body fat has a large negative influence on PF tests performance in this population. Therefore, by reducing the body fat, CAF members would greatly improve their PF level. Additionally, lean body mass increment would also result with enhancement of PF level, especially in power and repetitive strength. The basic military PF programmes in CAF should be dominantly focused on body fat decrement and, secondly, on lean body mass increment.

This research was conducted within the framework of the investigation project "Research of Human Resources and Potentials" sponsored by the Croatian Ministry of Defence and the Institute for Research and Development of Defence Systems.







# Kinesiology of Top-level Sport

**6<sup>th</sup> INTERNATIONAL  
SCIENTIFIC  
CONFERENCE ON  
KINESIOLOGY**

**Editor:**

**Prof. Dragan Milanović, PhD**

**“INTEGRATIVE POWER OF  
KINESIOLOGY”**

**Peer Reviewers:**

**Prof. Ljubomir Antekolović, PhD**

**Prof. Dragan Milanović, PhD**

**Prof. Igor Jukić, PhD**

**Prof. Munir Talović, PhD**

**Prof. Milan Čoh, PhD**

**Prof. Bojan Jošt, PhD**

**Prof. Anita Hökelmann, PhD**

**Prof. Hrvoje Sertić, PhD**

**Vlatko Vučetić, PhD**

**Prof. Marko Zadražnik, PhD**



**Secretary:**

**Sanja Šalaj, PhD**

**Dario Škegro, MagKin**

## SPORTS CAREER TERMINATION AND ADAPTATION TO POST-SPORTS LIFE: A REVIEW OF DEVELOPMENTAL-SPORT PSYCHOLOGICAL PERSPECTIVES

Saša Cecić Erpič

*Faculty of Sport, University of Ljubljana, Slovenia*

### Abstract

Elite sports career requires of athletes and their significant others immense investment at different levels (e.g., psychological, physical, financial, social) during a long period of time. Sports career termination as the last transition in sports career has its own distinctive characteristics, demanding of athletes to cope with changes. Factors, influencing satisfactory as well as traumatic retirement of out of competitive sport will be presented and discussed by using perspectives from both: sport and developmental psychology.

**Key words:** *sports (athletic) career, termination, transition, elite athlete, non-athletic transitions, post-sports life*

### Introduction

During the past four decades research into the career development of talented and elite athletes has evolved into a growing topic of study among the sport psychology community (Wylleman, Lavallee, & Theeboom, 2004). As before majority of both theoretical and applied sport psychology literature concentrated on elite competitive sport and means to help athletes achieve top level goals, nowadays transition among sport career phases, its termination (or retirement) and adaptation to post-sport life are being thoroughly researched. *Special Interest Group – Career Transitions in Sport* formed under the umbrella of European Federation for Sport Psychology (FEPSAC) is significantly accountable for broadening the interest to research the career related topics. According to FEPSAC (European Federation of Sport Psychology, 2000) sports career is defined as “*the multiyear sports activities of the individual aimed at high level sports achievements and self-improvement in sport*”. It is not a homogenous entity but is composed of several stages. Each stage, including sports career transition and adaptation to post-sports life, is characterized by a set of specific demands requiring adjustment by athletes and has therefore been comprehended as a transition.

### The review of different perspectives on the career development and its termination of elite athletes

Focus of the studies published until 1980s was the career end, comprehended as a singular event, followed by traumatic and variously difficult consequences. These studies (e.g., Haerle, 1975; Mihovilović, 1968) were mostly anecdotal in nature, focused on the description of retirement from high level sport. Later, researchers shifted their perspective to the transitional process-oriented approach (Lavallee, 2000) and *Conceptual model of adaptation to career transition* (Taylor & Ogilvie, 1998) was one of the first complex models that comprehended individual's response to a career transition as the result of the interaction between emotional, social, financial, and occupational factors (Cecić Erpič, 2002). According to Ogilvie and Taylor (1993a, 1993b) the model should derive from specificity of sports career termination and should include sport specific factors. The quality of sports career transition is affected by causes of sports career termination, factors related to the adaptation to retirement, and available resources. The model emphasizes that two set of factors, namely antecedent factors and mediating factors influence the quality of career termination process.

Researches of sports career development and ending have later taken a lifespan perspective, studying it from a transitional aspect. Employing Schlossberg's *Model of human adaptation to transition* (Schlossberg, Waters & Goodman, 1995) in the sport setting, sport career termination and adaptation to post-sport life can be seen as a transition, which is defined as “an event or non-event which results in a change in assumptions about oneself and the world and thus requires a corresponding change in one's behavior and relationships” (Schlossberg, 1981; p. 5). The result of sport career transition (SCT), which is an important life event and therefore has to be coped with, is either successful adjustment or adjustment that is accompanied with variously intensive difficulties. Results of different empirical studies show that retiring athletes cope with difficulties on psychological (e.g. identity crisis, loss of self-worth, low self-esteem, alcohol and drug abuse), physical (e.g. injuries, health problems, difficulties with detraining), psychosocial (e.g. social loneliness, problems to engage in new sport non-related relationships), and socio-economic or financial (e.g. absence of a professional career, lack of professional qualification, unsuitable professional career, drop in financial income) level (Cecić Erpič, Wylleman, & Zupančič, 2004; Wylleman, Lavallee & Alfermann, 1999).

Based on the several empirical research and applied sport psychological support with a wide variety of athletes, Wylleman and Lavallee (2004) proposed a *Developmental perspective on transitions faced by athletes*. It is a lifespan model that reflects the concurrent, interactive, and reciprocal nature of athletes' development in four domains, i.e., athletic, psychological, psychosocial, academic and vocational domain (Wylleman & Reints, 2010). Each of four domains of development are marked by normative transitions. It uses a "whole career" approach, describing sports career from the initiation phase through post-sports career phase as well as a "holistic approach", i.e. describing all four domains of athlete's development (for details see Wylleman & Lavallee, 2004). The model describes four distinctive phases of sports career, namely initiation, developmental, mastery and discontinuation phase. Although these phases are normative in nature, major differences may occur in-between sports, taking into the account the characteristics of sport disciplines (e.g.; peak of the career in gymnastics happens much earlier than in rowing or long distance running).

### **Sport related factors influencing career termination and adaptation to post-sports life**

The degree of voluntariness (i.e., perception of control) of sports career termination significantly contributes to the quality of adaptation to post-sports life (Taylor & Ogilvie, 1994) and is comprehended as both an antecedent factor (e.g., Taylor & Ogilvie, 1994; Ogilvie & Taylor, 1993a, 1993b) and mediating factor (e.g., Alfermann, 2000; Wylleman et al., 1993). Research shows congruence in association of voluntary termination with a less difficult adaptation to post-sports life (e.g., Alfermann, 2000; Alfermann & Gross, 1997; Cecić Erpič, 1999, 2000; Cecić Erpič, Wylleman, & Zupančič, 2004; Werthner & Orlick, 1986). Study on former Slovene elite athletes that terminated their careers on average 3 years prior to the study showed that the degree of voluntary retirement from active sports involvement has a significant effect on all but psychosocial difficulties experienced during sports career termination process (Cecić Erpič, Wylleman, & Zupančič, 2004). Former athletes who terminated their career involuntarily experienced more frequent and more severe difficulties than those who retired voluntarily (Cecić Erpič, 1999). They coped with more frequent and severe psychological difficulties, (i.e., feelings of incompetence in sport non-related activities, lack of self-confidence, low self-respect and self-esteem), more frequent and severe occupational difficulties (e.g., lack of professional knowledge, difficulties with finding work), and difficulties at organizing their post-sports life. Athletes who retired involuntarily, evaluate their adaptation to post-sports life as more negative than athletes, whose decision was predominantly voluntary. Involuntary retirement can lead to psychological difficulties such as lower self-control (Werthner & Orlick, 1986), lower self-respect, and more frequent feelings of anger, anxiety, and depression (Alfermann & Gross, 1997). However, distinction between voluntary (freely chosen) and involuntary (forces) retirement is not always clear because of the diversity and the nature of the potential factors, which determine why athletes retire (Fernandez, Stephan, & Fouquereau, 2005). Kerr and Dacyshyn (2000) demonstrated that certain factors identified as distinct seem to refer to a common dimension (i.e., consequences of injury and deselection are generally considered as two independent factors (Taylor & Ogilvie, 1994) are part of a single "negative causes" factor). The quality of adaptation to post-sports life is also influenced by the gradualness of the process of athletic retirement (Ogilvie & Taylor, 1993b).

The second factor that significantly influences athlete's quality of adaptation to post-sport life is athletic identity (Brewer, Van Raalte, & Linder, 1993; Cecić Erpič, 2001, 2002). An athlete's commitment to sports can have positive influence on sports achievements (Danish, Petitpas, & Hale, 1993; Werthner & Orlick, 1986), exercise adherence, and athletic performance (Brewer et al., 1993) but at the other hand, strong athletic identity may lead to experiencing difficulties after sports career termination (e.g., Cecić Erpič, 2002; Cecić Erpič, Wylleman, & Zupančič, 2004; Pearson & Petitpas, 1990; Werthner & Orlick, 1986). A strong identification with the athlete identity was related to more severe and frequent psychological difficulties, as well as with more difficulties in organizing their post-sports career life (Cecić Erpič, Wylleman, & Zupančič, 2004; Lavallee, Gordon, & Grove, 1997). Athletic identity was also shown to be related to dysfunctional beliefs regarding sports career and post-sports life (Mateos, Torregrosa, & Cruz, 2010).

The evaluation of achieved athletic goals, which is subjective in its nature, is one of the less studied mediator factors associated with sports career termination. The findings (e.g., Cecić Erpič, Wylleman, & Zupančič, 2004) suggest that athletes who perceived to have achieved fewer goals than expected, also dealt with more difficulties at organizing their post-sports career life (e.g., more negative evaluation of adaptation process, longer adjustment period to post-sports life, fixation on active sports career).

Pre-retirement planning of post-sports life broadly influences the quality of adaptation to life following competitive sports career (Coakley, 1983; Pearson & Petitpas, 1990). Although a relation between post-sports life planning and a less difficult adaptation to post-sports life has been empirically supported (e.g., Stambulova, 1994), approximately 26% of athletes (Cecić Erpič, Wylleman, & Zupančič, 2004) do not think about their life after active sports involvement. On the other hand, results showed that 39% of former elite Slovene athletes had actually planned their future life after sports career termination quite accurately. Torregrosa and colleagues (Torregrosa, Boixadós, Valiente, & Cruz, 2004) report that younger athletes and those viewing retirement as distant tend to avoid planning prior to their retirement and that job choice gained importance as the sporting career progressed.

## The effect of non-athletic factors on sports career termination process

Prior research has showed that sports career termination is not influenced only by sports-related factors. The importance of antecedent and mediating factors which are not directly sports-related but which influence the process of athletic retirement, including chronological age, educational status, and the occurrence of non-athletic transitions. The athlete's age and the possible consecutive decline in sports performance is often stated as one of the most important causes for sports career termination. It has physiological, psychological, and social implications for retiring athletes (Taylor & Ogilvie, 1994). Psychological implications of ageing in sports are related to a decrease in motivation for training and competing (Werthner & Orlick, 1986), and in a change of values and priorities (Cecić Erpič, 1998, 2000). Athletes' current educational status has a significant effect on the occurrence of occupational difficulties, which refer to problems with finding a job, financial difficulties, difficulties with adaptation to the requirements of occupation, and lack of professional knowledge (Cecić Erpič, Wylleman, & Zupančič, 2004). It has also a significant positive influence on the quality of retirement from sports (Werthner & Orlick, 1986; Wylleman et al., 1993). Highly educated former athletes (students and those who attained university degree) experienced least occupation related difficulties.

Main presumption of a holistic, lifespan approach to the sport career transitions (e.g., Wylleman, De Knop, Verdet, & Cecić Erpič, 2006) is that athletes' careers are not influenced solely by sports-related factors but also by those unrelated to sports. Non-athletic transitions impact the sports career transitions (Wylleman, Lavalley & Alfermann, 1999; Wylleman, De Knop, Ewing, & Cumming, 2000) as well as the termination and the adaptation to life after retirement (Cecić Erpič, 2000, 2001b; Cecić Erpič, Wylleman, & Zupančič, 2004). Non-athletic transitions include the events that occur in the athlete's psychosocial life and are in essence not related to sports (e.g., the educational/academic or occupational career, social network development) but which may influence the quality and development of athletes' sports career and post-sports lives (Wylleman & Lavalley, in press). The conception of non-athletic transitions includes normative and non-normative events in adulthood as understood by Neugarten (Turner & Helms, 1993), who presumes that development in adulthood is primarily socially determined and indicated by life-events that require reorganization of one's expectations and/or lifestyle. The influence that life-events have on the individual's life and how one reacts to their occurrence depend on individual's subjective perception of these life-events (Turner & Helms, 1993). An athlete's development is therefore influenced by important life-events (i.e. non-athletic transitions) including starting a job, marriage, birth of a child, or occupational retirement. Since former elite athletes comprehend athletic retirement as an important life-event (Cecić Erpič, 1998) it can be presumed that it influences their development.

Extensive study of former Slovene elite athletes showed that while having experienced positive non-athletic transitions had no significant effect on the sports career termination process, the process was significantly influenced by negative non-athletic transitions (Cecić Erpič, Wylleman, & Zupančič, 2004). Athletes who experienced the most frequent and the most intense negative life events had, in comparison to those athletes who had experienced less negative non-athletic transitions, a more difficult termination process. They experienced more severe and more frequent psychological and occupational difficulties. The results obtained related to non-athletic factors reveal that athletic and non-athletic aspects of life seem to be closely connected and mutually interdependent. These findings have also practical implication as they underline the need for sport psychology practitioners to comprehend an athlete in a more complex and developmental perspective by considering his/her sports unrelated aspects of life as well.

## The quality of sports career termination and adaptation to post-sport life

The quality of the sports career transition and the adaptation to post-sports life thus depend upon athletic and non-athletic factors. Their influence can result in a successful, relatively smooth transition, or in variously intensive difficulties at psychological, physical, psychosocial, and/or occupational level. Regardless of the immense adaptation to the post-sport life that is required, sports career termination is not a traumatic life event. Results show that 85% of former elite athletes perceive the retirement from sport as a positive life event, followed by positive life changes (Cecić Erpič, 2002). Review of the sports career termination literature from 2000 (Lavalley, Wylleman, & Sinclair, 2000) that analyzed 13 empirical studies with 2564 participants all together showed that only a minor percentage of athletes experience severe and highly intensive difficulties when facing retirement from competitive sports. Different authors report that there is between 7% (Cecić Erpič, 2002; Cecić Erpič & Wylleman, 2005) and 15% (Lavalley, Wylleman, & Sinclair, 2000) of athletes who experience traumatic transition out of sport.

After retirement from sports, athletes may experience difficulties at psychological level, including identity crisis (e.g., Baillie & Danish, 1992; Cecić Erpič, 2001; Pearson & Petitpas, 1990), loss of self-worth (e.g., Cecić Erpič, 2002; Cecić Erpič, Wylleman, & Zupančič, 2004; Wylleman et al., 1993), decrease of self-esteem (Brewer, Van Raalte, & Petitpas, 2000), decline of life satisfaction (Cecić Erpič, 2002; Wylleman et al., 2006), emotional problems (e.g., Alfermann & Gross, 1997; Cecić Erpič, 2002; Wylleman et al., 2006), and feelings of unaccomplished athletic goals (Cecić Erpič, 2002; Werthner & Orlick, 1986). Physical difficulties include injuries and health problems (e.g., Stephan, Torregrosa, & Sanchez, 2007), problems with detraining (e.g., Cecić Erpič, 2002; Wylleman et al., 1993), and dietary problems (e.g., Cecić Erpič, 2002; Stephan, Torregrosa, & Sanchez, 2007). After elite sports career, difficulties experienced with the

body were negatively related to global self-esteem, physical self-worth, perceived physical condition, sports competence, and bodily attractiveness (Stephan, Torregrosa, & Sanchez, 2007). Study of Stephan and colleagues (Stephan, Torregrosa, & Sanchez, 2007) showed that physical self-worth has the mediating role between the difficulties experienced with the body and global self-esteem.

Retirement from sports and adaptation to post-sports career life may be accompanied by difficulties at psychosocial level, including social and cultural loneliness (Cecić Erpič, 2002; Cecić Erpič, Wylleman, & Zupančič, 2004), deficiency of social contacts (Cecić Erpič, 1998; Cecić Erpič, Wylleman, & Zupančič, 2004; Danish et al., 1993), and problems concerning engagement in new relationships outside of sports (Cecić Erpič, 1998; Cecić Erpič, Wylleman, & Zupančič, 2004). End of competitive sports involvement may also be accompanied with difficulties on occupational level, such as lack of an occupational career (Cecić Erpič, 1998), lack of professional qualification (e.g. Cecić Erpič, 1998; Wylleman et al., 1993), less suitable professional career choices (Wylleman et al., 1993), and the decline in financial income (e.g. Cecić Erpič, 2002; Cecić Erpič, Wylleman, & Zupančič, 2004; Wylleman et al., 1993).

### The role of socio-emotional support in traumatic sports career termination

As stated above, there is only a minor percentage of athletes who experience traumatic and severely difficult transition out of competitive sports. Social support and interpersonal relationships play significant role in athlete's adaptation to SCT and post-sports life (Cecić Erpič, Wylleman, & Zupančič, 2004). There are several empirical evidence on the significance of socio-emotional support system during adaptation to retirement from sports (for review see Wylleman et al., 2006). Athletes who have more support from significant others adapt to post-sports life more smoothly and with less difficulties (for overview see Wylleman & Lavallee, 2004; Wylleman et al., 2006). Although majority of studies examined socio-emotional support from significant others, institutional support also has to be emphasized. It is of a great importance, that sport association, club, National Olympic Committees or other sport-related institutions provide retiring athlete with support (Lavallee, 2000).

The role of socio-emotional support and interpersonal relationships in the process of severely difficult retirement from elite competitive sports were studied from a qualitative aspect (Cecić Erpič & Wylleman, 2005) as there is only a small number of athletes suffer severely traumatic sports career termination. Three former elite athletes (two females and one male) who participated in the study were among the athletes who scored the highest results on the Total scale of sports career transition difficulty of The Sports Career Termination Questionnaire (SCTQ; Cecić Erpič, 2002). The content analysis of in-depth interviews showed that socio-emotional support and other social-relationship issues significantly influence the characteristics of sport career termination (Cecić Erpič & Wylleman, 2005). Social-relationship aspects affect all stages of sports career transition further analysis showed that two patterns of each career transition stages were found. Since the results were obtained in a case-study they may not be generalized.

Respondents' subjective interpretations showed that traumatic career termination results from a combination of risk factors (Cecić Erpič & Wylleman, 2005). Socio-emotional support and interpersonal relationship with significant others play an important role in the quality of adaptation to post-sports life. During the retirement process, all three respondents had little support from their families and friends. Although received support does not guaranty the smooth transition, it plays an important role in athlete's adaptation to changes that occur during the retirement process (Schlossberg, Waters, & Goodman, 1995). However, it has to be emphasized that none of three respondents have had any support from their long-time coaches and sport-related institutions (Cecić Erpič, 2002; Cecić Erpič & Wylleman, 2005). The other significant risk factor for difficult transition is strong athletic identity during and after active competitive career. Explicit identification with one role is the risk factor for difficulties in adaptation to new social roles (Brewer, Van Raalte, & Petitpas, 2000). The risk factors that have to be emphasized are the lack of post-sports life planning and dissatisfaction with current post-sports life. Analysis of their answers shows that dissatisfaction derives from lateness in establishing developmental tasks of early adulthood (Cecić Erpič, 2002).

### Conclusions

Sports career transitions and termination from active competitive career, followed by adaptation to post-sport life is becoming one of the important subjects in the contemporary sport psychology. Traditional sport psychology was merely focused on providing mental support to athletes, using different mental techniques and sport psychology interventions. Newer empirical studies, together with applied sport psychology work show the need for more holistic and lifespan approach with the emphasis both on athletic and non-athletic aspects. Developmental lifespan perspective on transitions faced by athletes proposed by Wylleman and associates presents such a tool for understanding the complexity of contemporary sport, ensuring sport psychologists to have a broader image of what is influencing not only sport results but also the well-being of athletes.

The aim of the article was to review different perspectives of sports career termination and adaptation to post-sports life of elite athletes. Using both sport psychological and developmental psychological aspects, the goal of the article was

to present sports career termination from a holistic perspective using lifespan approach and emphasizing the influence of athletic and non-athletic factors. Deriving from a developmental perspective, characteristics of emerging and early adulthood are actually foundations for understanding career transitions more thoroughly than just from a sport-related aspects. Due to the space limitation, only sports career termination of elite athletes was presented. Dropout from sport prior to the phase of elite career (i.e., premature sports career termination) is one of the topics that current studies should be focusing on. Dropout presents a serious problem in certain sport disciplines especially in countries with smaller populations (e.g., Slovenia), with only selected few athletes on an elite level. Notion of career development characteristics actually presents the foundation for the talent development, meaning that by knowing the factors influencing various career transitions, sport society could and should influence those unfavorable in order to assure better climate for athletes' development and well-being.

## References

- Alfermann, D. (2000). Causes and consequences of sport career termination. In D. Lavallee, & P. Wylleman (Eds.) *Career transitions in sport: International perspective* (pp. 45-58). Morgantown: Fitness Information Technology.
- Alfermann, D., & Gross, A. (1997). Coping with career termination: It all depends on freedom of choice. In R. Lidor, & M. Bar-Eli (Eds.) *Proceedings of the IX World Congress on Sport Psychology* (pp. 65-67). Netanya: Wingate Institute for Physical Education and Sport.
- Baillie, P. H. F., & Danish, S. J. (1992). Understanding the career transition of athletes. *The Sport Psychologist*, 6, 77-98.
- Brewer, B. W., Van Raalte, J. L., & Linder, D. E. (1993). Athletic identity: Hercules' muscles or Achilles heel? *International Journal of Sport Psychology*, 24, 237-254.
- Brewer, B. W., Van Raalte, J. L., & Petitpas, A. J. (2000). Self-identity issues in sport career transitions. In D. Lavallee, & P. Wylleman (Eds.) *Career transitions in sport: International perspective* (pp. 29-43). Morgantown: Fitness Information Technology.
- Cecić Erpič, S. (1999). Differences between voluntary and involuntary sport career termination. In V. Hošek, P. Tilingier, & L. Bilek (Eds.), *Psychology of sport and exercise: Enhancing the quality of life. Proceedings of the 10<sup>th</sup> European congress of sport psychology – FEPSAC* (pp. 147-149). Praga: Charles University.
- Cecić Erpič, S. (2001). Athletic identity and adjustment to sport career termination and to post-sport life among Slovenian athletes. In A. Papaioannou, M. Goudas, & Y. Theodorakis (Eds.), *In the dawn of the new millennium. Proceedings of 10<sup>th</sup> World Congress of Sport Psychology - Vol. 4* (pp. 32-34). Skiathos: Christodoulidi Publications.
- Cecić Erpič, S. (2002). *Konec športne kariere: Razvojno psihološki in športno psihološki vidiki [Sports career termination: Developmental- and sport-psychological aspects]*. Ljubljana: Faculty of Sports.
- Cecić Erpič, S., & Wylleman, P. (2005). Socio-psychological perspective on traumatic retirement from sports. In D. Milanović in F. Prot (Eds.), *4<sup>th</sup> International Scientific Conference on Kinesiology: Proceedings book* (pp. 654-657). Zagreb: Faculty of Kinesiology, University of Zagreb.
- Cecić Erpič, S., Wylleman, P., & Zupančič, M. (2004). The effect of athletic and non-athletic factors on the sports career termination process. *Psychology of Sport and Exercise*, 5 (1), 45-59.
- Coakley, J. J. (1983). Leaving competitive sport: Retirement or rebirth?. *Quest*, 35, 1-11.
- Danish, S. J., Petitpas, A. J., & Hale, B. D. (1993). Life development intervention for athletes: Life skills through sports. *The Counseling Psychologist*, 21 (3), 352-385.
- European Federation of Sport Psychology (2000). Position statement 3: Sports career transitions. In D. Lavallee, & P. Wylleman (Eds.) *Career transitions in sport: International perspective* (pp. 259-261). Morgantown: Fitness Information Technology.
- Fernandez, A., Stephan, Y., & Fouquereau, E. (2006). Assessing reasons for sports career termination: Development of the Athletes' Retirement Decision Inventory (ARDI). *Psychology of Sport and Exercise*, 7, 407-421.
- Haerle, R.K. (1975). Career patterns and career contingencies of professional baseball players: An occupational analysis. In D.W. Ball, & J.W. Loy (Eds.), *Sport and social order* (pp. 461-519). Reading, MA: Addison-Wesley.
- Kerr, G., & Dacyshyn, A. (2000). The retirement experiences of female elite gymnasts. *Journal of Applied Sport Psychology*, 12, 115-133.
- Lavallee, D. (2000). Theoretical perspectives on career transitions in sport. In D. Lavallee & P. Wylleman (Eds.), *Career transitions in sport: International perspective* (pp. 1-27). Morgantown: Fitness Information Technology.
- Lavallee, D., Gordon, S., & Grove, J.R. (1997). Retirement from sport and the loss of athletic identity. *Journal of Loss and Interpersonal Loss*, 2, 129-147.
- Lavallee, M., Wylleman, P., & Sinclair, D.A. (2000). Career transitions in sport. An annotated bibliography. In D. Lavallee, & P. Wylleman (Eds.), *Career transitions in sport: International perspective* (pp.207-258).
- Mateos, M., Torregrosa, M., & Cruz, J. (2010). Evaluation of a career assistance programme for elite athletes: satisfaction levels and exploration of career decision making and athletic-identity. *Kinesiologia Slovenica*, 16, 1-2, 30-43.
- Mihovilović, M. (1968). The status of former sportsmen. *International Review of Sport Sociology*, 3, 73-93.
- Ogilvie, B. C., & Taylor, J. (1993a). Career termination in sports: When the dream dies. In J. M. Williams (Ed.) *Applied sport psychology: Personal growth to peak performance* (pp. 356-365). Mountain View: Mayfield Publishing Company.

23. Ogilvie, B. C., & Taylor, J. (1993b). Career termination issues among elite athletes. In R. N. Singer, M. Murphey, & L. K. Tennant (Eds.) *Handbook of research on sport psychology* (pp. 761-779). New York: Macmillan.
24. Pearson, R., & Petitpas, A. (1990). Transition of athletes: Pitfalls and prevention. *Journal of Counseling and Development*, 69, 7-10.
25. Schlossberg, N. K. (1981). A model for analyzing human adaptation to transition. *The Counseling psychologist*, 9 (2), 2-18.
26. Schlossberg, N. K., Waters, E. B., & Goodman, J. (1995). *Counseling adults in transition: Linking practice with theory*. New York: Springer.
27. Stambulova, N. B. (1994). Developmental sports career investigations in Russia. A post-perestroika analysis. *The Sport Psychologist*, 8, 221-237.
28. Stephan, Y., Torregrosa, M., & Sanchez, X. (2007). The body matters: Psychophysical impact of retiring from elite sport. *Psychology of Sport and Exercise*, 8, 73-83.
29. Taylor, J., & Ogilvie, B. C. (1998). Career transition among elite athletes: Is there life after sports. In J. M. Williams (Ed.) *Applied sport psychology: Personal growth to peak performance* (pp. 429-444). Mountain View: Mayfield.
30. Torregrosa, M., Boixadós, M., Valiente, L., & Cruz, J. (2004). Elite athletes' image of retirement: the way to relocation in sport. *Psychology of Sport and Exercise*, 5, 35-43.
31. Turner, J. S., & Helms, D. B. (1993). *Contemporary adulthood*. Fort Worth: Harcourt Brace College Publishers.
32. Werthner, P., & Orlick, T. (1986). Retirement experiences of successful Olympic athletes. *International Journal of Sport Psychology*, 17, 337-363.
33. Wylleman, P., De Knop, P., Ewing, M., & Cumming, S. P. (2000). Transitions in youth sport: A developmental perspective on parental involvement. In D. Lavallee, & P. Wylleman (Eds.) *Career transitions in sport: International perspective* (pp. 143-160). Morgantown: Fitness Information Technology.
34. Wylleman, P., De Knop, P., Menkehorst, H., Theeboom, M., & Annerel, J. (1993). Career termination and social integration among elite athletes. In S. Serpa, J. Alves, V. Ferreira, & A. Paula-Brito (Eds.), *Proceedings of the 8<sup>th</sup> World Congress Sport Psychology* (pp. 902-905). Lisbon: Universidade Tecnica de Lisboa.
35. Wylleman, P., De Knop, P., Verdet, M-C., & Cecić Erpič, S. (2006). Parenting and career transitions of elite athletes. In S. Jowett, & D. Lavallee (Eds.), *Social psychology of sport* (pp. 233-247). Champaign: Human Kinetics.
36. Wylleman, P., & Lavallee, D. (2004). A developmental perspective on transitions faced by athletes. In M. Weiss (Ed.), *Developmental sport and exercise psychology: A lifespan perspective* (pp. 507-527). Morgantown, WV: FIT.
37. Wylleman, P., Lavallee, D. & Alfermann, D. (1999). *Career transitions in competitive sports*. Biel, Switzerland: FEPSAC.
38. Wylleman, P., Lavallee, D., & Theeboom, M. (2004). Successful athletic careers. In C. Spielberger (Ed.), *Encyclopedia of Applied Psychology* (pp. 511-518). San Diego, CA: Elsevier Ltd.
39. Wylleman, P., & Reints, A. (2010). A lifespan perspective on the career of talented and elite athletes: Perspectives on high-intensity sports. *Scandinavian Journal of Medicine and Science in Sports*, 20 (Suppl. 2), 1-7.



## JUSTIFYING ANTIDOPING: FAIR OPPORTUNITY AND THE BIOLOGY OF PERFORMANCE ENHANCEMENT

**Sigmund Loland**

*Norwegian School of Sport Sciences, Oslo, Norway*

Doping is a complex moral and scientific dilemma and its prevention has led to a costly but less than perfect control system implemented worldwide by the World Anti-doping Agency (WADA). For a substance or method to be considered for the WADA Prohibited List three criteria are considered: (1) the substance or method has the potential to enhance, or enhances, sport performance (2) use of the substance or method represents an actual or potential health risk to the athlete, and (3) use of the substance or method violates the 'spirit of sport'.

The 'spirit of sport' is defined as '...the celebration of the human spirit, body and mind' and explained with reference to a series of ideal values: ethics, fair play and honesty; health; excellence in performance; character and education; fun and joy; teamwork; dedication and commitment; respect for rules and laws; respect for self and other participants; courage; community and solidarity. These values do not lend themselves to clear-cut interpretation and are of little help in drawing unambiguous lines in concrete cases. A proposal is made of how to interpret 'the spirit of sport' in more precise ways in terms of a combination of the fair opportunity principle and a biological and evolutionary understanding of athletic performance as a result of the systematic utilization of the phenotypic plasticity of the human organism.

The argument is that such understanding improves significantly the possibilities for line drawing when it comes to doping issues.

### References

1. Loland, S. and Hoppeler, H. (2011): Justifying antidoping: fair opportunity and the biology of performance enhancement.
2. Manuscript under publication in *European Journal of Sport Science*.

## FORMATION MAPS OF 5 MINUTE S BEFORE AND AFTER SCORING IN SOCCER

Nic James<sup>1</sup>, Gethin Rees<sup>1</sup>, Joe Taylor<sup>2</sup>, Ian Grant<sup>1</sup> and Phil Barter<sup>1</sup>

<sup>1</sup>Middlesex University, London, UK

<sup>2</sup>English Institute of Sport, Manchester, UK

### Purpose

Redwood-Brown (2008) found that the frequency and accuracy of passing was significantly different to the team's average for the half during the 5 minutes preceding and following a goal being scored. This study will investigate whether the average location of each player in a team, for the 5 minutes preceding and following a goal, can discriminate tactical differences.

### Methods

Formation maps were constructed using a multiple camera match analysis system (Amisco Viewer®, version 3.3.4.2, Nice, France) for the home team for the 5 minutes preceding and following goals scored by both the home and away teams. These maps were calculated on the average x y coordinate position of each player over the chosen time frame (Fig 1). Thirty eligible goals (19 home, 11 away) at one English Championship team's venue in 15 matches during the 2010/11 season were analysed using Chi square tests of independence.

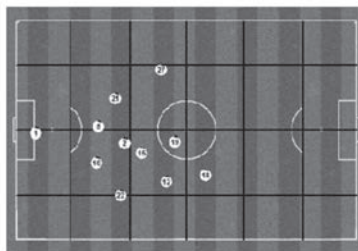

Figure 1. Example Formation map

### Results

Players' average positions were significantly different for the 5 minutes prior to a goal being scored (7.37% defensive 1/3, 11.05% attacking 1/3) compared to a goal being conceded (16.36% defensive 1/3, 6.36% attacking 1/3;  $p < .05$ ).

### Conclusion

These results suggest that formation maps can be a useful technique for analysis of strategy. Future research should consider using more detail than just pitch thirds and other time periods.

### References

1. Redwood-Brown, A. (2008). Passing patterns before and after goal scoring in FA Premier League soccer. *International Journal of Performance Analysis in Sport*, 8(3), 172-182.

## PHYSICAL FITNESS LEVEL IN FREE STYLE JUNIOR WRESTLERS OF THREE DIFFERENT WEIGHT CATEGORIES

Mario Baić<sup>1</sup> and Włodzimierz Starosta<sup>2</sup>

<sup>1</sup>*Faculty of Kinesiology, University of Zagreb, Croatia*

<sup>2</sup>*Institut of Sport, Warsaw and University School of Physical Education and Tourism in Białystok, Poland*

### Abstract

The importance of certain physical fitness abilities for success in a wrestling bout varies in wrestlers of various wrestling styles, weight categories and age. The goal of the research was to determine any differences between three different weight categories (“light-weight”, “mid-weight” and “heavy-weight”) of top-level junior free style wrestlers. The research was conducted on the sample of 46 wrestlers. The set of 19 tests was used to assess general and specific fitness preparedness for advanced wrestlers. Two discriminant variables were determined and defined as: absolute maximal strength and speed of simple and complex movement execution. They discriminate significantly among the three weight groups of top-level junior wrestlers. The findings highlight the necessity to individualize physical conditioning for top-level junior free style wrestlers with respect to weight categories.

**Key words:** *national team, motor abilities, functional capacities*

### Introduction

Increasing the physical fitness level is the basic goal of all types of sport preparation. Adequate physical fitness level is the key stone of all training programmes and a prerequisite of an adequate preparation for top-level sport achievements. Inadequate development of physical abilities at the earlier stages of an athletes’ career greatly reduces their sport achievements at an advanced stage of their sport development (Starosta & Tracewski, 1998). The importance of particular physical abilities for success in a bout varies between wrestling styles, weight categories and age groups. Unfortunately, the number of previous research dealing with physical conditioning of free style wrestlers of different ages and weight categories is quite small (Starosta & Glaz, 1993; Glaz, 1998; Baić, 2006). In spite of that, a positive trend in physical fitness preparation of wrestlers has been noted in the past twenty years. To date, however, certain dilemmas regarding application of physical conditioning in wrestlers of different styles, weight categories and ages still remain.

The aim of this study was to determine differences between three different weight categories (“light-weight”, “mid-weight” and “heavy-weight”) of top-level free style junior wrestlers using physical conditioning assessment variables.

### Methods

The total number of subjects was 46 top-level free style wrestlers, aged between 17 and 20 years (juniors). They were divided in three different weight categories (“light-weight”, “mid-weight” and “heavy-weight”). The first group of subjects was comprised of 13 “light-weight” wrestlers, up to 65 kg (mean±SD; age 18.00±1.08 years; years of sport participation 5.23±1.96 years; body weight 59.65±3.35 kg; body high 167.95±3.27 cm). The second group of subjects was comprised of 23 “mid-weight” wrestlers, from 65 kg to 85 kg (age 18.70±1.15 years; years of sport participation 7.30±1.61 years; body weight 73.22±5.34 kg; body high 175.49±5.77 cm). The third group of subjects was comprised of 10 “heavy-weight” wrestlers, above 85 kg (age 18.50±0.97 years; years of sport participation 5.70±2.11 years; body weight 96.74±5.67 kg; body high 186.51±5.94 cm). All subjects were of the same quality class - they were members of the Polish national team.

The set of tests used was described to a detail and illustrated with drawings within the set of general and specific preparedness tests for advanced wrestlers by Starosta and Tracewski (1981). Coordination was assessed using maximal turn in the jump measured in degrees (more degrees – higher level of coordination). Agility was assessed using zigzag running (envelope) and by run with a turnover. Absolute maximum strength was assessed using one repetition maximum (1RM) for: bench press, maximal load snatch, lifting maximum load onto the chest and back squat. Strength endurance of a dynamic type was assessed using the number of pull-ups, parallel bars dips and sit-ups with side twists and load. Vertical jump was used to assess power; trunk bending (decline bench) assessed flexibility, 1000 m run assessed endurance, whereas 20m run from the flying start assessed speed.

To assess specific (coordination) abilities of wrestlers the following set of variables was used: backward handsprings, the catch (snatch) from the neck, pirouettes, strive (merry-go-round) and bridge from above upper stance. Metric characteristics

of those tests were described as very good in several studies. However, we did not use the whole set in this research (forward handspring, squatted forward somersault, squatted backward somersault and mannequin throwing belly-to-back souplé).

All the measurements were done in the same preparatory period, during the Polish national team training camp in 1998 and 2000, under the supervision of the same chief researcher Włodzimierz Starosta. The standardization of testing conditions, detailed by Starosta and Tracewski (1981), was crucial for a proper execution of this longitudinal experiment.

Data were analysed using the software package Statistica 5. All variables assessing physical fitness were expressed via arithmetic means and standard deviations. Distribution normality of the results was tested using the Kolmogorov–Smirnov test. Statistical significance of the differences in physical fitness variables between three different weight categories of junior free style wrestlers was assessed using the discriminant analysis. The significance level was set at  $p < 0.05$ .

## Results

In Table 1 differences between the variables assessing physical fitness capabilities are presented.

Table 1. Differences between three various weight categories (light-, mid- and heavy-weight) of the researched free style junior wrestlers in the variables assessing physical fitness (mean±SD)

Variables	Light-weight wrestlers (n=13)	Mid-weight wrestlers (n=23)	Heavy-weight wrestlers (n=10)
	Mean ± SD	Mean±SD	Mean±SD
Maximal turn in the jump (degrees)	720.69±70.47	754.96± 136.97	699.60±116.54
Zig-zag running, the so-called envelope (s)	23.69±0.06	24.37± 1.10	26.04±0.27
Run with a turnover (s)	11.90±0.43	11.65±0.51	12.70±4.94
Pull-ups (repetitions)	24.62±6.75	25.52±6.25	11.80±4.94
Parallel bars dips (repetitions)	37.46±9.39	40.61±11.26	27.20±7.60
Bench press (kg)	85.00±14.00	108.85±10.12	134.70±23.28
Sit-ups with side twists and load (repetitions)	36.68±10.91	26.86±10.03	39.00±12.57
Maximal load snatch (kg)	51.77±6.65	63.11±8.88	78.00±9.49
Lifting maximum load onto the chest (kg)	71.46±10.82	86.1±13.71	104.00±13.29
Back squat (kg)	93.09±11.83	117.75±25.98	148.50±26.46
Vertical jump test (cm)	52.89±5.73	59.78±7.76	57.85±7.76
20 m run from the flying start (s)	2.76±0.11	2.59±0.11	2.68±0.16
1000 m run (s)	173.96±12.79	178.30±22.20	194.89±29.16
Trunk bending (decline bench) (cm)	50.66±9.26	52.37±7.06	61.91±4.66
Backward handsprings (s)	2.73±0.61	2.61±0.44	2.59±0.43
Strive, the so-called merry-go-round (s)	11.17±1.42	11.80±1.63	13.97±1.78
Bridge from above upper stance (s)	1.86±0.24	1.87±0.20	2.07±0.23
The catch (snatch) from the neck (s)	6.35±0.94	6.43±0.70	7.00±0.91
Pirouettes (s)	5.29±0.63	5.38±0.88	5.71±0.67

Kolmogorov–Smirnov test was used to investigate the normality of distribution for all the listed variables. None of the variables was found to deviate significantly from normal distribution, therefore, all the variables were further processed.

Discriminant analysis was used to ascertain whether there were any discriminant functions in the space of the variables assessing physical fitness which statistically significantly differentiated among three various weight categories (“light-weight”, “mid-weight” and “heavy-weight”) of the top-level junior free style wrestlers.

Table 2. Result of discriminant analysis for the three different weight categories of free style junior wrestlers – test of significance and power of the discriminant functions (n=46)

Discriminant function	Eigenvalue	Canonical R	Wilks' Lambda	Targ %	Chi-square	df	p-level
I	8.42	0.95	0.04	84.55	107.94	38	0.00
II	1.54	0.78	0.39	15.45	31.68	18	0.02

Legend: Eigenvalue – the variance of the discriminant function; Canonical R – canonical discrimination coefficient; Wilks' Lambda – reverse measure of intergroup variability; Targ % – the percentage of the explained variance; Chi-square – value of Chi-square test; df – degrees of freedom; p-level – probability error.

Upon confirming that the two obtained discriminant functions statistically significantly discriminated among the three different weight categories of the top level junior free style wrestlers in the space of the variables assessing physical fitness, the structure of the discriminant functions was established (Table 3).

Table 3. Results of the discriminant analysis for the free style wrestlers according to the three different weight categories – correlation of the variables assessing physical fitness with the discriminant functions (n=46)

Variables	Discriminant function	Discriminant function
	I	II
Maximal turn in the jump	0.03	-0.15
Zig-zag running, the so-called envelope	-0.19	0.43
Run with a turnover	-0.22	0.41
Pull-ups	0.29	-0.33
Parallel bars dips	0.15	-0.27
Bench press	-0.42	-0.20
Sit-ups with side twists and load	0.07	0.27
Maximal load snatch	-0.41	-0.14
Lifting maximum load onto the chest	-0.33	-0.13
Back squat	-0.31	-0.12
Vertical jump test	-0.07	-0.30
20 m run from the flying start	0.05	0.44
1000 m run	-0.12	0.05
Trunk bending (decline bench)	-0.20	0.11
Backward handsprings	0.03	0.08
Strive, the so-called merry-go-round	-0.22	0.08
Bridge from above upper stance	-0.13	0.12
The catch (snatch) from the neck	-0.09	0.04
Pirouettes	-0.07	0.02

Centroids (arithmetic means of the all applied variables) of three different weight categories of the measured wrestles were also computed on the discriminant functions in order to obtain clear insight into and more comprehensive interpretation of the obtained results (Table 4).

Table 4. Centroids of three different weight categories on the discriminant

Freestyle junior wrestlers	Discriminant function I	Discriminant function II
Light-weight	3,04	1,40
Mid-weight	0,41	-1,19
Heavy-weight	-4,88	0,91

## Discussion and conclusion

The findings corroborate existence of the statistically significant differences between the three different weight categories (“light-weight”, “mid-weight” and “heavy-weight”) of the top-level junior free style wrestlers in the variables assessing their physical fitness. It was determined that two discriminant functions (Table 2) differentiated statistically significantly among the three different weight categories of the investigated wrestlers in the space of the variables which assessed their physical fitness. The highest correlations were found between the first discriminant function and the following variables (Table 3) assessing absolute maximal strength: bench press, maximum load snatch, lifting maximum load onto the chest and back squat. Therefore, this discriminant function was defined as the factor of absolute maximal strength. The highest correlations were found between the second discriminant function and the following variables (Table 3) assessing physical fitness: speed of running by the variable 20m run from the flying start, agility by the variable the

variables zig-zag running (envelope) and run with a turnover. Therefore, that discriminant variable was defined as the factor of speed of simple and complex movement execution.

Based on the values of the centroids' projections of the different top-level junior wrestling weight categories (Table 4), it was feasible to conclude the following:

- "Light-weight" top-level junior free style wrestlers manifested the smallest absolute maximal strength, as well as the lowest speed of simple and complex movement execution.
- The "mid-weight" top-level junior free style wrestlers scored better in the absolute maximal strength tests than the "light-weight" wrestlers and poorer than the "heavy-weight" wrestlers. The category of "mid-weight" top-level junior free style wrestlers achieved the highest speed of simple and complex movement execution.
- The group of "heavy-weight" top-level junior free style wrestlers had the greatest absolute maximal strength; their speed of simple and complex movement execution was higher than the speed of the "light-weight" category and somewhat lower than that of the "mid-weight" category.

Numerical higher results of absolute maximal strength tests obtained for "heavier-weight" categories can be explained with an almost linear comparable increase of absolute maximal strength and body weight. The highest numerical test scores for speed of simple and complex movement execution in the "mid-weight" category wrestlers (Table 1) is explained by their (on average) optimal ratio between longitudinal skeletal size and muscles, which enables them to perform a great number of technical-tactical elements repetitions per practice, and in doing so, to improve their speed of simple and complex movement execution. Apart from the favourable skeletal dimension, that is the ratio muscle to mass, easier coupling of weight-adequate training-bout-partners at wrestling practices could have an important influence on developing speed of simple and complex movement execution. The aforementioned concurs with previous findings that state how "mid-weight" category wrestlers have the best dynamic balance (Martirosov & Vartanjanov, 1968, according to Chatzilelekas, 1999), which can also be explained by quality and weight adequate bout-partner coupling that facilitates the development of this motor ability. Unlike them, the "light-weight" and "heavy-weight" category wrestlers often have difficulties in finding weight adequate bout-partners. Weight inadequate bout-partners condition poorer mastering and execution of technical-tactical elements, consequently the poorer development of all motor and functional capabilities, not only of the previously mentioned ones but also, other motor and functional. Still, these conclusions about the significance of execution speed of simple and complex movements, as well as about adequate bout-partner coupling effect on the development of this ability must not be taken at its face value since the predetermined level of statistical significance was set at  $p > 0.05$ .

The obtained results highlight the necessity to individualize physical conditioning for top-level junior free style wrestlers with respect to the specificities of different weight categories. This concurs with previous research (Starosta & Glaz, 1993; Glaz, 1998). Also, correlations between different weight categories and certain situation-related efficiency parameters are well documented (Chatzilelekas, 1999) and should be taken into account when planning, programming and executing basic and specific physical conditioning with free style wrestlers (Chatzilelekas, 1999).

## References

1. Baić, M. (2003). Razlike između vrhunskih poljskih i hrvatskih hrvača različitih stilova, dobi i težinskih skupina u prostoru varijabli za procjenu kondicijske pripremljenosti. (Neobjavljena doktorska disertacija). Zagreb: Kineziološki fakultet.
2. Chatzilelekas, E. (1999). Situacijska efikasnost hrvača na Olimpijskim igrama u Atlanti. (Neobjavljeni magistarski rad). Zagreb: Fakultet za fizičku kulturu.
3. Glaz, A. (1998). Struktura sprawności motorycznej zapasników różnych kategorii wagowych. In M. Oldakovski (Ed.), *Kwartalnik Polskiego Związku Zapasniczego nr 2*, Warszawa, "Zapasy" (pp. 12-14). Warszawa: Polski Związek Zapasniczy.
4. Starosta, W., & Tracewski, J. (1981). Zestaw prob sprawności ogólnej i specjalnej dla zaawansowanych zawodników zapasow. [Set of tests assessing basic and specific preparedness of advanced wrestlers.] Warszawa: Instytut Sportu – Zakład Selekcji Sportowej, Polski Związek Zapasniczy – Wydział Szkolenia.
5. Starosta, W., & Glaz, A. (1993). Struktura sprawności motorycznej zapasników różnych kategorii wagowych. [Structure of motor fitness of wrestlers different weight categories.] *Wychowanie Fizyczne i Sport*, 3, 31-38.
6. Starosta, W., & Tracewski, J. (1998). An objective method of assessing the level of motor abilities in advanced wrestlers. In J. Sadowski & W. Starosta (Eds.), *Proceedings Book of International Scientific Conference, Biala Podlaska "Movement Coordination in Team Sport Games and Martial Arts"*, (pp. 249-254). Warsaw: Academy of Physical Education, & Biala Podlaska: The Institute of Sport and Physical Education.

## LATENT STRUCTURE OF THE ANTHROPOMETRIC DIMENSIONS IN ELITE CROATIAN VOLLEYBALL PLAYERS

Tomislav Đurković, Nenad Marelić and Tomica Rešetar

Faculty of Kinesiology, University of Zagreb, Croatia

### Abstract

Using the sample of 74 premier league volleyball players, all senior ages and adequate health status, we intended to determine the structure of the latent dimensions underlying the measured anthropometric characteristics. The sample of variables consisted of 27 anthropometric measures all taken following the guidance of the IBP (Mišigoj et al., 1995). The results confirm the hypothesis of the existence of four morphological latent dimensions further confirmed by a significant number of previous studies that were conducted on samples of volleyball players (Momirović et al. 1966; Strahonja and Matković, 1983) and other samples (Momirović et al. 1969; Hošek and Jeričević, 1982; Medved, 1987 and Marković, 2004).

**Key words:** volleyball, anthropometry, factor analyses

### Introduction

Just like any other sport, volleyball sets the specific requirements for its participants. Volleyball players differ from the other athletes in anthropometric, functional, motor, technical, tactical, cognitive and conative characteristics. In the selection process, it is necessary to know the “winning” combination of those characteristics. The final score of the game depends on many factors that have a different impact on a performance. The factors themselves have a definite impact, but associated with other factors constitute the so-called specific equation. Given the structure and demands of volleyball, it is logical that some anthropometric characteristics have a significant impact on the success of the game. Considerable number of previous studies confirmed the hypothesis of the existence of significant differences in the area of anthropometry among groups of volleyball players of different quality (Spence et al. 1980; Gualdi – Russo and Zaccagni, 2001; Batista et al. 2008; Malousaris et al. 2008).

Figure 1 shows the values of body height of male national teams (the maximum value and the value of the winning team) at all the Olympics since 1968 until 2004, including the World League 2005 and the 2006 World Championship. There has been a constant increase in the maximum values of body height in the period from 1968 to 1996, followed by a slight decrease. It is interesting that the winners of all the major competitions since 2004 – the Brazilian team, are in average 7-10 centimeters shorter than the highest teams in the same competitions, which leads to the conclusion that the body height is only one of the important criteria for selection of elite volleyball players.

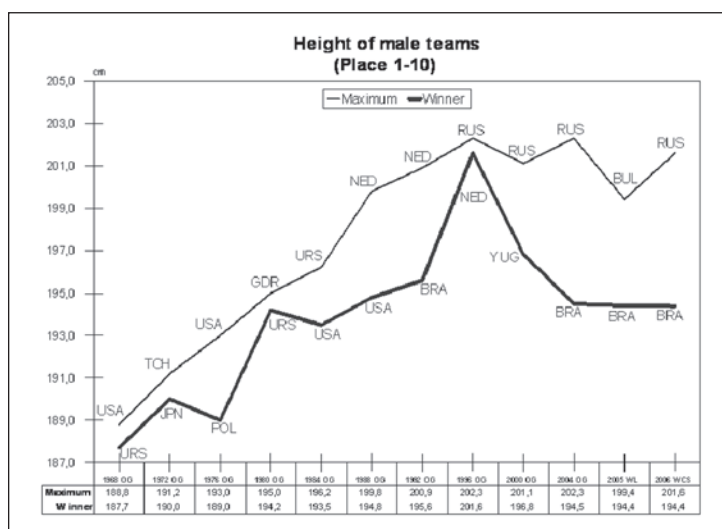

Figure 1. The height of male teams in all Olympic Games since 1968 till 2004 including World League 2005 and World championship 2006.

The trend of increasing average values of body height was registered in the toughest National Volleyball League (Italy). The results of the study of Benedetti et al. 2001 show that in a 20-year period the average body height of six initial players (starters) increased by 7.8 cm.

Previous studies on the latent structure of the anthropometric characteristics of volleyball players were conducted based on high quality and large samples. In a sample of 60 first league volleyball players (Momirović et al., 1966) the factor analysis was used and 4 dimensions were extracted: the longitudinal dimensionality, voluminous and body mass, transversal skeleton dimensionality and subcutaneous fat tissue.

In a sample of 126 junior volleyball players Strahonja (1974) used factor analysis and extracted 3 factors: longitudinal dimensionality, subcutaneous fat tissue and the circular skeleton dimensionality corresponding to the factor of voluminous and body mass. The regression analysis determined that anthropometric measures of longitudinal and circular dimensions contribute significantly to the prediction of the maximum jump height and reach in volleyball. Strahonja (1978) finds that measures of longitudinal and circular dimensions contribute significantly to the prediction of situational accuracy while adipose tissue acts as a disturbing factor in situations when one needs to achieve specific volleyball accuracy. Strahonja and Matković (1983) in the research based on a study constructed by Hošek and Jeričević (1982) establish a significant relation between latent anthropometric dimensions and situational - motor factors in volleyball.

## Methods

The study included a sample of the 74 premier league volleyball players, all senior ages and adequate health status. The sample of variables consisted of 27 anthropometric measures, all taken following the guidance of the IBP (Mišigoj et al., 1995). Sample of variables are presented in Table 1.

Table 1. Sample of variables

1. Body height /BH/	15. Chest circumference /CC/
2. Body weight/BW/	16. Thigh circumference /TC/
3. Arm span /AS/	17. Lower leg circumference /LLC/
4. Leg length /LL/	18. Abdomen circumference /AVOT/
5. Arm length /AL/	19. Upper arm skin fold /UAS/
6. Foot length /FL/	20. Subscapular skin fold /SS/
7. Biacromial range /BR/	21. Chest skin fold /CS/
8. Foot diameter /FD/	22. Abdominal skin fold /AS/
9. Elbow diameter /ED/	23. Suprailiacristal skin fold /SIS/
10. Knee diameter /KD/	24. Thigh skin fold /TS/
11. Ankle diameter /AD/	25. Lower leg skin fold /LLS/
12. Upper arm circumference - extended /UACE/	26. Biceps skin fold /BS/
13. Upper arm circumference – flexed and contracted /UACF/	27. Axilla skin fold /AS/
14. Forearm circumference /FAC/	

The results obtained in this way were then fed into the computer and analyzed with the statistical program Statistica for Windows ver. 5.0. Minimal and maximal values, arithmetic mean, and standard deviation are calculated using standard descriptive analysis. Further, the normality of distribution is calculated with K-S test. The factorization of the variables was conducted using the factor analysis with Varimax normalized rotation.

## Results

Descriptive statistic parameters, presented in table 2 include means, minimal and maximal results and standard deviations.



Table 2. Descriptive statistic for anthropometric variables

	$\bar{x}$	Min	Max	s
Body height /BH/	191,2	170,1	206,4	7,25
Body weight/BW/	86,3	57,5	111,8	10,55
Arm span /AS/	193,8	177,0	210,0	7,55
Leg length /LL/	109,5	96,3	124,8	5,24
Arm length /AL/	83,8	76,2	90,6	3,37
Foot length /FL/	28,4	24,2	31,2	1,40
Biacromial range /BR/	43,0	36,6	47,2	2,30
Foot diameter /FD/	10,4	8,7	11,8	0,67
Elbow diameter /ED/	7,2	6,1	10,3	0,49
Knee diameter /KD/	10,1	8,5	11,9	0,58
Ankle diameter /AD/	7,8	4,0	8,7	0,61
Upper arm circumference - extended /UACE/	31,3	19,1	37,0	2,80
Upper arm circumference – flexed and contracted /UACF/	33,9	28,0	40,4	2,40
Forearm circumference /FAC/	27,5	24,5	30,7	1,54
Chest circumference /CC/	99,12	84,20	112,9	6,27
Thigh circumference /TC/	59,23	47,60	68,9	3,82
Lower leg circumference /LLC/	38,39	33,30	44,0	2,32
Abdomen circumference /AVOT/	85,69	64,00	101,5	6,61
Upper arm skin fold /UAS/	10,13	4,53	21,0	3,43
Subscapular skin fold /SS/	11,06	6,87	20,3	3,14
Chest skin fold /CS/	7,20	3,50	17,3	2,63
Abdominal skin fold /AS/	14,63	5,93	33,5	6,38
Suprailiocrystal skin fold /SIS/	9,54	4,20	25,0	4,75
Thigh skin fold /TS/	13,48	5,93	26,7	5,06
Lower leg skin fold /LLS/	7,91	3,87	17,7	2,95
Biceps skin fold /BS/	4,47	2,67	8,8	1,29
Axilla skin fold /AS/	8,34	4,80	21,2	3,41

Using *Varimax normalized* rotation initial coordinative system were transformed to obtain simple structure of the factors (Table 3). Using the Guttman Kaiser criterion, four significant factors are extracted explaining 73.7% of the common variance of the manifest variables.

Table 3. Factor analysis of the anthropometric variables

Variables	F1	F2	F3	F4
Body height /BH/	0,08	<b>0,93</b>	0,08	0,16
Body weight/BW/	0,41	<b>0,58</b>	<b>0,61</b>	0,28
Arm span /AS/	0,08	<b>0,90</b>	0,21	0,23
Leg length /LL/	0,08	<b>0,92</b>	0,09	-0,01
Arm length /AL/	0,03	<b>0,90</b>	0,04	0,18
Foot length /FL/	0,03	<b>0,76</b>	0,32	0,27
Biacromial range /BR/	-0,10	0,46	0,38	0,06
Foot diameter /FD/	-0,04	0,40	0,24	0,47
Elbow diameter /ED/	0,15	0,15	0,31	<b>0,62</b>
Knee diameter /KD/	0,22	0,39	0,24	<b>0,70</b>
Ankle diameter /AD/	-0,05	0,12	0,12	<b>0,79</b>
Upper arm circumference - extended /UACE/	0,33	-0,01	<b>0,80</b>	0,23
Upper arm circumference – flexed and contracted /UACF/	0,20	0,15	<b>0,87</b>	0,15
Forearm circumference /FAC/	0,08	0,18	<b>0,76</b>	0,39
Chest circumference /CC/	0,41	0,40	<b>0,69</b>	0,02
Thigh circumference /TC/	<b>0,56</b>	0,20	<b>0,63</b>	0,21
Lower leg circumference /LLC/	0,24	0,34	<b>0,64</b>	0,27
Abdomen circumference /AVOT/	<b>0,63</b>	0,34	0,48	-0,03
Upper arm skin fold /UAS/	<b>0,82</b>	0,01	0,11	0,14
Subscapular skin fold /SS/	<b>0,81</b>	0,06	0,18	-0,03
Chest skin fold /CS/	<b>0,75</b>	0,09	0,21	0,25
Abdominal skin fold /AS/	<b>0,78</b>	0,00	0,28	0,00
Suprailiocrystal skin fold /SIS/	<b>0,89</b>	0,09	0,14	0,00
Thigh skin fold /TS/	<b>0,86</b>	0,03	0,06	-0,03
Lower leg skin fold /LLS/	<b>0,83</b>	0,01	0,16	-0,01
Biceps skin fold /BS/	<b>0,85</b>	-0,01	-0,06	0,06
Axilla skin fold /AS/	<b>0,81</b>	0,03	0,25	0,12
Expl Var	11.41	5.12	2.16	1.21
Prp Totl	42.25	18.96	8.00	4.50
<b>Cumul. %</b>	<b>42.25</b>	<b>61.21</b>	<b>69.21</b>	<b>73.7</b>

F1, F2, F3 – factor structure, Expl Var – factors variance, Prp totl – proportion of the variance explained, Cumul.% - cumulative percentage

Inter-correlations between factors are presented in the Table 4.

Table 4. Factors intercorrelations

	SF	LSD	VBM	TSD
SF	1,00			
LSD	0,17	1,00		
VBM	<b>0,57</b>	<b>0,48</b>	1,00	
TSD	<b>0,24</b>	<b>0,57</b>	<b>0,61</b>	1,00

## Discussion and conclusion

The average body height of the tested sample (Table 2) was somewhat shorter (191.22 cm) from the results obtained by the previous studies, which are based on a sample of Croatian (193.94 cm - Grgantov, 2002) and Italian club players (195.9 cm - Ciccarone et al. 2008) or the national teams players (Puhl, 1982. – 193.0 cm, Viitasalo, 1982. – 192.0 and 193.0 cm, Viitasalo, 1987. – 195.0 cm, Marelič et al., 2008 – 192.5 and 194.4 cm). The results of body weight (86.3 kg) and other measured variables are very similar or slightly lower compared to the results of previous studies conducted on the samples of Croatian league players (Grgantov, 2002, Marelič et al., 2008) with the exception of skin folds results.

Due to the maximum projection of all the skin folds and the variables of abdomen and thighs circumference, the **first factor** can be identified as a factor of **subcutaneous fat**. This factor was confirmed in all the previous studies of the latent structure of morphological variables (Momirović et al., 1960, Viskiće, 1963, Strahonja, 1974 and 1978). The highest projection on the **second factor** has variables of longitudinal dimension of the skeleton. Due to the structure it can be considered as a factor of **longitudinal skeleton dimensionality** (Harman, 1960; Momirović et al., 1966; Strahonja, 1974 and 1978; Kurelič et al., 1975; Stojanović et al., 1975 and Medved, 1987). Considering the height of the projection of variables that measure the circumferences and body weight the **third factor** can be interpreted as a factor of **volume and body mass** (Eysenck 1958, Viskiće 1972, Momirović et al., 1966; Kurelič et al., 1975; Strahonja, 1974 and Stojanović et al., 1975). On the **fourth factor** projections of the diameter measures are evident. Projections of other variables are low. Based on projections of variables and results of previous research it can be concluded that the fourth latent dimension is defined with variables for bone growth in width. Thus, the fourth morphological factor can be defined as **transversal skeleton dimensionality** (Hošek and Jeričević, 1982; Momirović et al., 1969). Except for a very low correlation between subcutaneous fat and longitudinal skeleton dimensionality, all of the other correlations between morphological factors are positive and in range from 0.48 (LSD and VBM), 0.57 (SF and VBM) to 0.61 (between TSD and VBM). The resulting structure of morphological space confirms the hypothesis of the existence of four morphological latent dimensions and was confirmed by a significant number of previous studies that were conducted on samples of volleyball players (Momirović et al., 1966; Strahonja and Matković, 1983) or other samples of young and active persons or athletes (Momirović et al., 1969; Hošek and Jeričević, 1982; Medved, 1987 and Marković, 2004). The results of previous studies when authors obtained three factors on the sample of volleyball players (Strahonja, 1974. and 1978.) were probably caused by a significantly smaller number of variables (16 variables in both studies).

## References

- Batista, G.R., De Araújo, R.F., Guerra, R.O. (2008). Comparison between vertical jumps of high performance athletes on the Brazilian men's beach volleyball team. *Journal of Sports Medicine and Physical Fitness*, 48(2), 172-176.
- Benedetti, V., Pasini, G., Salvini, M. (2001). Statura e volley. "La Gazzetta dello Sport".
- Ciccarone, G., Croisier, J.I., Fontani, G., Martelli, G., Albert, A., Zhang, L., Cloes, M. (2008). Comparison between player specialization, anthropometric characteristics and jumping ability in top-level volleyball players. *Medicina dello Sport*, 61(1), 29-43.
- Eysenck, H.J. (1958). The structure of human personality (Methuen, & Co., London).
- FIVB. (2011). Height of male teams in all Olympic Games since 1968 till 2004 including World League 2005 and World championship 2006. Retrieved January 22, 2011; from: [www.fivb.org/EN/Technical/World/Championship/Men/2006/](http://www.fivb.org/EN/Technical/World/Championship/Men/2006/).
- Grgantov, Z. (2002). Anthropometric characteristics of elite Croatian male volleyball players. U: Milanović, D. Prot, F. (ur.), *Zbornih radova međunarodne znanstvene konferencije "Kinesiology new perspectives"*, Zagreb, 2002 (str. 283-286). Zagreb: Kineziološki fakultet sveučilišta u Zagrebu.
- Gualdi-Russo, E., Zaccagni, L. (2001). Somatotype, role and performance in elite volleyball players. *J Sports Med Phys Fitness*. 41 (2), 256-262.
- Harman, H. (1960). Modern factor analysis. The university of Chicago press. Chicago, 1960.

9. Hošek, A., Jeričević, D. (1982). Latentna struktura morfološkog statusa studenata Fakulteta za fizičku kulturu. *Kineziologija*, 14(5), 9-20.
10. Kurelić, N. et al. (1975). Struktura i razvoj morfoloških i motoričkih dimenzija omladine, RRV, Beograd.
11. Puhl, J., Case, S., Fleck, S., Handel, V.P. (1982). Physical and Physiological Characteristics of Elite Volleyball Players. *Research Quarterly for Exercise and Sport*, 53(3), 257-262.
12. Viskiđ, N. (1972). Faktorska struktura tjelesne težine. *Kineziologija*, 2(2), 45-49.
13. Viitasalo, J. (1982). Anthropometric and physical performance characteristics of male volleyball players. *Canadian Journal of Applied Sport Science*, 7(3), 182-188.
14. Viitasalo, J., Rusko, H., Pajalo, O., Rahkila, P., Ahila, M., Montonen, H. (1987). Endurance requirements in volleyball. *Canadian Journal of Sports Sciences*, 12(4), 194-201.
15. Malousaris, G., Bergeles, N., Barzouka, K., Bayios, I., Nassis, G., Koskolou, M. (2008). Somatotype, size and body composition of competitive female volleyball players. *Journal of Science and Medicine in Sport*, 11(3), 337-344.
16. Marelić, N., Đurković, T., Rešetar, T. (2008). Differences in the conditioning and morphological characteristics between junior and senior volleyball players. In: Milanovic, D., Prot, F., (Eds.), *Proceedings Book of the 5<sup>th</sup> International Scientific Conference on Kinesiology: "Kinesiology research trends and applications"*, Zagreb, 2008 (str. 958-961). Zagreb: Kineziološki fakultet.
17. Marković, G. (2004). *Utjecaj skakačkog i sprinterskog treninga na kvantitativne i kvalitativne promjene u nekim motoričkim i morfološkim obilježjima*. (Doktorska disertacija, Sveučilište u Zagrebu). Zagreb: Kineziološki fakultet Sveučilišta u Zagrebu.
18. Maver, H., Momirović, K., Pađen, R. (1960). Contribution to understanding the importance of testing the subcutaneous fat tissue. *Statistička revija (Statistics Review)*, 10, 1-2: 44-53.
19. Medved, R. (1987). *Sportska medicina*. JUMENA, Zagreb.
20. Momirović, K. et al. (1966). Utjecaj latentnih antropometrijskih varijabli na orijentaciju i selekciju vrhunskih sportaša. Visoka škola za fizičku kulturu, Zagreb.
21. Momirović, K. et al. (1969). Faktorska struktura antropometrijskih varijabli. Visoka škola za fizičku kulturu, Institut za kineziologiju, Zagreb.
22. Spence, D.W., Disch, J.G., Fred, H.L., Coleman, A.E. (1980). Descriptive profiles of highly skilled women volleyball players. *Medicine and Science in Sports and Exercise*, 12(4), 299-302.
23. Stojanović, M., K. Momirović, R. Vukosavljević, S. Solarić (1975). Struktura antropometrijskih dimenzija. *Kineziologija* 5 (1 - 2): 193 - 207.
24. Strahonja, A. (1974). The influence of manifest and latent anthropometric characteristics on the jump height and maximal hand reach in jump of junior volleyball players. *Kinesiology*, 4 (1).6-15.
25. Strahonja, A. (1978). The influence of manifest and latent anthropometric variables on the accuracy in volleyball situations. *Kinesiology*, 8 (1-2).103-25.
26. Strahonja, A., Matković, B. (1983). The relationship between anthropometric dimensions and performance in volleyball. *Kinesiology*, 15(2), 103-11.

## DEVELOPMENT ANALYSIS OF SOCCER PLAYERS FUNCTIONAL CHARACTERISTICS

Marko Erceg, Igor Jelaska and Boris Maleš

*Faculty of Kinesiology, University of Split, Croatia*

### Abstract

The purpose of this paper was to identify functional abilities of soccer players, as well as to determine differences in spiroergometric parameters among soccer players in the U-15, U-17 and U-19 category. The research included the following variables: absolute maximal oxygen uptake, relative maximal oxygen uptake, maximum minute ventilation, maximum heart rate, and before mentioned variables at the anaerobic threshold, resting lactate concentration and lactate concentration at the end of the test, body height and weight, and body mass index. Analysis of variance show that soccer training has a major influence on the development of functional abilities, and the results are progressively better with age. Therefore, it is to be expected that soccer players in the U-15 and U-17 category will achieve similar values once they reach the age of U-19 players.

**Key words:** *soccer, functional abilities, anaerobic threshold*

### Introduction

Interpreting functional abilities of soccer players is more difficult than in individual sports, where it is easier to predict the results more accurately on the basis of functional abilities. Nonetheless, by determining functional abilities of soccer players useful information may be obtained, both on the team and on individual players. Functional diagnosis ensures a detailed overview of the current state of an individual player and the entire team; the training process may be observed and controlled, and it is possible to make comparisons with other teams. The development of individual capacities requires in-depth knowledge of specific training operators and specific exertion and resting intervals, which are determined on the basis of data on the current state of functional parameters. For achieving optimum state of fitness it is necessary to observe and apply accomplishments of modern sports science, and specific diagnosis of athlete fitness. As the basis for functional characteristics analysis in sports disciplines in which success is determined in terms of oxygen transport system capacity, maximum progressive exercise tests (Wasserman et al. 1999) are mostly used. The most frequently used controlled exercise machines are cycle ergometer and treadmill, even though lately specific ergometers for individual sports (rowing, kayaking, cross-country skiing...). Those devices truly reproduce the dynamic movement stereotype specific for each sport and they are increasingly used in various scientific research. Continuous and progressive exercise tests on treadmills are mostly used today. Here the load is increased either by increasing the speed of the treadmill or by increasing the incline of the treadmill or by progressively increasing both the speed and the incline. The test is generally performed until the subject is exhausted, unless there are contraindications or limiting factors (Rowland, 1996). Therefore, the main objective of this research was to identify functional abilities of soccer players, and determine differences in variables for assessing spiroergometric parameters among soccer players in the U-15, U-17 and U-19 category.

### Methods

The research was carried out on a sample of 66 soccer players competing in the First Croatian Soccer League. The subjects were divided into three age groups: U-15 (N=22), U-17 (N=22) and U-19 (N=22). The sample of variables used to assess functional abilities is made up of spiroergometric parameters obtained in a progressive exercise test on a spiroergometric system and Quark pft4 (COSMED, Italy) software package. The heart rate value was monitored on the Polar RS800CX monitor (Polar Electro, Finland), while the blood lactate concentration at the beginning and end of the progressive exercise test was measured with a Accutrend lactate analyser (Roche, Germany). The research included the following variables: absolute maximal oxygen uptake ( $VO_{2max}$ ), relative maximal oxygen uptake ( $RVO_{2max}$ ), maximum minute ventilation ( $VE_{max}$ ), maximum heart rate ( $HR^{max}$ ), absolute oxygen uptake at the anaerobic threshold ( $VO_{2max}/AT$ ), relative oxygen uptake at the anaerobic threshold ( $RVO_{2max}/AT$ ), minute ventilation at the anaerobic threshold ( $VE/AT$ ), heart rate at the anaerobic threshold ( $HR/AT$ ), resting lactate concentration ( $LAC_{res}$ ) and lactate concentration at the end of the test ( $LAC_{max}$ ). In addition to these parameters, body height and weight, as well as body mass index were measured. All the variables were subjected to test of normal distribution by using the Kolmogorov-Smirnov test and descriptive statistical parameters were calculated: arithmetic mean, standard deviation, minimum result, maximum result and K-S value. For comparative analysis among different groups of subjects Factorial ANOVA with Fisher LSD post-hoc test was used.

## Results

Table 1 shows the basic statistical parameters of applied variables for the U-15 category of soccer players: arithmetic mean (AM), standard deviation (SD), minimum (Min) and maximum results (Max), distribution skewness (Skew) and kurtosis (Kurt), and the K-S (Kolmogorov-Smirnov) test of normal distribution. As can be gathered from table 1, neither value of the K-S test exceeds the limit value of the Kolmogorov-Smirnov procedure for the sample of subjects observed. Therefore, we can conclude that all variables have distribution for which it can be said it does not deviate significantly from the normal distribution.

Table 1. Basic descriptive parameters of applicable variables for U-15 soccer players (AM – arithmetic mean; SD - standard deviation; Min – minimum measured results; Max – maximum results; Skew - skewness; Kurt - kurtosis; maxD - Kolmogorov-Smirnov test)

U-15 (N = 22)							
Morphological variables	AM	Min	Max	SD	Skew	Kurt	maxD
H (cm)	176.40	163.00	184.00	5.60	-0.83	0.11	0.18
W (kg)	63.52	41.00	74.00	7.41	-1.62	3.45	0.18
BMI (kg/m <sup>2</sup> )	20.35	15.43	22.18	1.63	-1.48	3.08	0.15
Functional variables							
<i>L<sub>res</sub></i> (mmol/L)	1.96	1.50	2.60	0.34	0.52	-0.95	0.27
<i>L<sub>max</sub></i> (mmol/L)	9.81	5.70	13.80	2.84	0.13	-1.41	0.16
HR <sub>max</sub> (1/min)	189.70	176.00	202.00	9.47	-0.31	-1.08	0.17
VE <sub>max</sub> (L/min)	142.28	104.50	171.40	21.99	-0.87	-0.59	0.28
VO <sub>2max</sub> (L/min)	4.10	3.89	4.78	0.37	0.54	-0.10	0.18
RVO <sub>2max</sub> (mL/min/kg)	58.76	52.00	65.00	3.52	-0.93	0.59	0.17
HR <sub>VP</sub> (1/min)	158.00	151.00	178.00	7.95	1.83	2.66	0.29
VE <sub>VP</sub> (L/min)	88.07	66.90	114.30	19.31	0.36	-1.62	0.17
VO <sub>2maxVP</sub> (L/min)	3.02	2.71	3.73	0.41	-0.09	-1.08	0.20
RVO <sub>2maxVP</sub> (mL/min/kg)	43.04	36.00	52.00	5.77	-1.05	-0.49	0.30

Limit value maxD for N=22 totals 0.30

By inspecting the basic statistical parameters of applied variables for the U-15 category of soccer players: arithmetic mean (AM), standard deviation (SD), minimum (Min) and maximum results (Max), distribution skewness (Skew) and kurtosis (Kurt), and the K-S (Kolmogorov-Smirnov) test of normal distribution (Table 2), it can be gathered that neither value of the K-S test exceeds the limit value of the Kolmogorov-Smirnov procedure for the sample of subjects observed. Therefore, we can conclude that all variables have distribution for which it can be said it does not deviate significantly from the normal Gauss distribution.

Table 2. Basic descriptive parameters of applicable variables for U-17 soccer players (AM – arithmetic mean; SD - standard deviation; Min – minimum measured results; Max – maximum results; Skew - skewness; Kurt - kurtosis; maxD - Kolmogorov-Smirnov test)

U-17 (N = 22)							
Morphological variables	AM	Min	Max	SD	Skew	Kurt	maxD
H (cm)	178.04	170.00	187.00	4.98	0.30	-1.02	0.12
W (kg)	69.00	60.00	80.00	6.53	0.07	-1.29	0.12
BMI (kg/m <sup>2</sup> )	21.72	18.93	23.45	1.24	-0.49	-0.51	0.11
Functional variables							
<i>L<sub>res</sub></i> (mmol/L)	2.54	1.50	3.50	0.52	-0.10	0.08	0.13
<i>L<sub>max</sub></i> (mmol/L)	12.06	7.10	17.60	2.98	-0.21	-0.89	0.15
HR <sub>max</sub> (1/min)	188.33	161.00	202.00	9.84	-0.80	1.53	0.10
VE <sub>max</sub> (L/min)	141.83	106.60	164.10	16.72	-0.35	-0.80	0.11
VO <sub>2max</sub> (L/min)	4.22	3.45	4.78	0.26	0.30	-0.67	0.19
RVO <sub>2max</sub> (mL/min/kg)	60.40	52.00	65.00	3.80	-0.00	0.06	0.13
HR <sub>VP</sub> (1/min)	162.71	147.00	181.00	10.94	0.13	-1.27	0.14
VE <sub>VP</sub> (L/min)	83.95	54.70	106.00	12.01	-0.31	0.67	0.13
VO <sub>2maxVP</sub> (L/min)	3.23	2.27	3.73	0.32	-0.24	-0.96	0.15
RVO <sub>2maxVP</sub> (mL/min/kg)	46.30	35.00	53.00	5.48	0.21	-1.24	0.13

Limit value maxD for N=22 totals 0.30

Table 3 shows basic statistical parameters of the variables applied to the U-19 category of soccer players: arithmetic mean (AM), standard deviation (SD), minimum (Min) and maximum (Max) results, distribution skewness (Skew) and kurtosis (Kurt), and the K-S (Kolmogorov-Smirnov) test of normal distribution. As can be gathered from Table 3, neither value of the K-S test exceeds the limit value of the Kolmogorov-Smirnov procedure for the sample of subjects observed. Therefore, we can conclude that all variables have distribution for which it can be said it does not deviate significantly from the normal distribution.

Table 3. Basic descriptive parameters of applicable variables for U-19 soccer players (AM - arithmetic mean; SD - standard deviation; Min – minimum measured results; Max – maximum results; Skew - skewness; Kurt - kurtosis; maxD - Kolmogorov-Smirnov test)

U-19 (N = 22)							
Morphological variables	AM	Min	Max	SD	Skew	Kurt	maxD
H (cm)	181.88	175.00	192.00	4.72	0.56	-0.05	0.10
W (kg)	75.05	63.00	89.00	6.07	0.26	0.89	0.17
BMI (kg/m <sup>2</sup> )	22.67	19.46	25.94	1.49	-0.02	0.76	0.15
Functional variables							
L <sub>res</sub> (mmol/L)	3.12	1.90	4.70	0.78	0.38	0.03	0.12
L <sub>max</sub> (mmol/L)	11.79	6.70	17.80	2.46	0.27	0.94	0.13
HR <sub>max</sub> (1/min)	183.53	171.00	197.00	7.01	0.23	-0.71	0.14
VE <sub>max</sub> (L/min)	149.29	106.10	186.10	21.70	-0.39	0.26	0.15
VO <sub>2max</sub> (L/min)	4.61	3.62	5.66	0.56	-0.25	-0.54	0.13
RVO <sub>2max</sub> (mL/min/kg)	62.30	52.00	71.00	5.06	0.10	-0.29	0.14
HR <sub>vp</sub> (1/min)	162.25	147.00	173.00	6.96	-0.53	0.07	0.15
VE <sub>vp</sub> (L/min)	102.66	77.80	136.50	16.53	0.57	-0.16	0.12
VO <sub>2maxvp</sub> (L/min)	3.77	2.67	5.06	0.55	0.16	0.32	0.08
RVO <sub>2maxvp</sub> (mL/min/kg)	50.65	41.00	58.00	5.35	-0.51	-0.95	0.16

Limit value maxD for N=22 totals 0.30

Table 4 shows that there is a rising trend of morphological variables toward the older age group of the soccer players. The U-17 soccer players are slightly taller than the U-15 players, but these differences are not statistically significant. The U-19 soccer players are statistically significantly taller than the U-15 and U-17 players. With regard to the weight and BMI it is apparent that there are statistically significant differences between all studied groups of soccer players.

Observing the differences of functional variables between the U-15 and U-17 players, it is noticeable that the U-17 players achieved on average higher values in almost all parameters. These differences are statistically significant only in the L<sub>res</sub>, and L<sub>max</sub> variables. Analysing the differences between the U-17 and U-19 players it can also be said that the U-19 players have on average achieved higher values in the majority of parameters. These differences are statistically significant in the majority of the anaerobic threshold variables, as well as in the VO<sub>2max</sub> and L<sub>res</sub> values. There are statistically significant differences in nearly all functional variables when comparing the U-15 and U-19 players.

Table 4. Comparative analysis of the variables applied to the soccer players of various age groups

Morphological variables	U-15 (N = 22)	U-17 (N = 22)	U-19 (N = 22)
	AM (SD)	AM (SD)	AM (SD)
H (cm)	176.40 (5.60)	178.04 (4.98)†	181.88 (4.72) <sup>2</sup>
W (kg)	63.52 (7.41)*	69.00 (6.53)††	75.05 (6.07) <sup>3</sup>
BMI (kg/m <sup>2</sup> )	20.35 (1.63)**	21.72 (1.24)†	22.67 (1.49) <sup>3</sup>
Functional variables			
L <sub>res</sub> (mmol/L)	1.96 (0.34)**	2.54 (0.52)††	3.12 (0.78) <sup>3</sup>
L <sub>max</sub> (mmol/L)	9.81 (2.84)*	12.06 (2.98)	11.79 (2.46) <sup>1</sup>
HR <sub>max</sub> (1/min)	189.70 (9.47)	188.33 (9.84)	183.53 (7.01) <sup>1</sup>
VE <sub>max</sub> (L/min)	142.28 (21.99)	141.83 (16.72)	149.29 (21.70)
VO <sub>2max</sub> (L/min)	4.10 (0.37)	4.22 (0.26)††	4.61 (0.56) <sup>2</sup>
RVO <sub>2max</sub> (mL/min/kg)	58.76 (3.52)	60.40 (3.80)	62.30 (5.06) <sup>2</sup>
HR <sub>vp</sub> (1/min)	158.00 (7.95)	162.71 (10.94)	162.25 (6.96)
VE <sub>vp</sub> (L/min)	88.07 (19.31)	83.95 (12.01)†††	102.66 (16.53) <sup>2</sup>
VO <sub>2maxvp</sub> (L/min)	3.02 (0.41)	3.23 (0.32)†††	3.77 (0.55) <sup>3</sup>
RVO <sub>2maxvp</sub> (mL/min/kg)	43.04 (5.77)	46.30 (5.77)††	50.65 (5.35) <sup>3</sup>

Key: analysis of variance - Factorial ANOVA with Fisher LSD post-hoc test; (AM – arithmetic mean; SD - standard deviation); \*p<0.05; \*\*p<0.01; \*\*\*p<0.001 – significance of differences between the U-15 and U-17 group of soccer players  
 †p<0.05; ††p<0.01; †††p<0.001 – significance of differences between the U-17 and U-19 group of soccer players  
<sup>1</sup>p<0.05; <sup>2</sup>p<0.01; <sup>3</sup>p<0.001 – significance of differences between the U-15 and U-19 group of soccer players

## Discussion and conclusion

Table 4 shows a visible rising trend of the morphological variables toward the older age group of soccer players. The U-17 players are taller than the U-15 players, and the U-19 players are statistically significantly taller than both the U-15 and the U-17 players. The analysis of the weight and BMI shows that there are statistically significant differences between all studied groups of soccer players. The average height and weight values of the U-15 soccer players are considerably higher in relation to the reference values, and they are located above the 75 % in comparison with the results of previous studies. The reason for this should be sought in the fact that among the studied U-15 soccer players there is a number of players who experienced accelerated growth, i.e. who matured earlier. The changes in the size and composition of the body and functional capacities occur and increase with puberty and maturation. The variations among boys of different maturity (the same biological, but different chronological age) are most evident between 13 and 16 years of age (Malina et al., 2003). The growth and maturation of young soccer players may affect the selection process, which is probably the case with the U-15 players from this research. The soccer players are selected according to their growth and maturity. At the selection time they were probably the best players due to their size, strength and power, which is connected with earlier maturation of the U-15 soccer players. With all three age groups of soccer players, resting lactate levels are somewhat above the physiological limits. Such results are probably the consequence of differences in activities of soccer players of different categories before the sampling, which is consistent with the findings of previous studies (Bangsbo et al., 1991). The registered differences are statistically significant among all studied age groups of soccer players. The maximum registered lactate values are significantly higher in the U-17 group in relation to the U-15 group. The maximum lactate values in the U-17 and the U-19 group do not statistically significantly differ while there is statistical significance in the differences between the U-15 and the U-19 players. It is interesting to note that the U-19 players, although "more acidic" before testing, had lower lactate values in blood after exertion in relation to the U-17 players. It is obvious that the U-19 players have a capacity to better adapt their organism to exertion because they have been in soccer training longer, and it has a strong influence on the development of functional abilities. The assumption is that longer soccer engagement of the U-19 players in relation to the U-17 and U-15 players results in increased number of capillaries around the muscle fibres, as well as in increased number of mitochondria in muscle cells, and thus in the improvement of aerobic metabolism activities. A better technique of movement performance may change the ratio of inactive and active muscle fibres so that less muscle fibres are used for the same activity due to the better technique. In that case there are more inactive muscle fibres that "attract" lactic acid from the active fibres and oxidise it. Further analysis of data in Table 4 shows a trend of decreasing heart rate value at  $VO_{2max}$  toward the older age group, which is physiological and is consistent with previous statements (Wilmore and Costill, 1999). The heart rate values at the anaerobic threshold are similar in all studied age groups of soccer players and there are no statistically significant differences among them. Nevertheless, these values rise with age of the soccer players, which points to a higher level of fitness in the U-17 and U-19 group in relation to the U-15 group. The U-17 and U-19 players cross the anaerobic threshold later, i.e. they enter the anaerobic mode at higher heart rates so they can perform sports activities longer and more effectively than the U-15 players.

As aforementioned, the heart rate may be decreased as a result of endurance training, and since the U-17 and the U-19 players have on average been in soccer training longer in relation to the U-15 players, the differences in maximum heart rate are logical. Furthermore, the overview of Table 4 shows visible increase in the minute ventilation at  $VO_{2max}$  toward the older age group. The U-15 and U-17 players achieve similar values, while ventilation values of the U-19 players are somewhat higher. There are differences among the studied groups of soccer players, but they are not statistically significant. In addition, a similar increase trend can be noticed in the ventilation values at the anaerobic threshold. The U-19 players have statistically higher values from both the U-15 and the U-17 players. The lung function changes considerably with age. The minute ventilation increases with age up to the physical maturity, and then decreases with age. These changes are connected to the growth of the entire lung system. As the size of the body increases with growth and development, so does the size and function of lungs increases, which explains the obtained differences of minute ventilation in the soccer players studied. Table 4 also shows a rising trend of maximal oxygen uptake values toward the older age group. The rising trend is also visible in the  $VO_{2max}$  values at the anaerobic threshold. The U-15 and U-17 players achieve similar results, while the U-17 and U-19 players, as well as the U-15 and U-19 players statistically significantly differ in the achieved  $VO_{2max}$  values. The increase of the absolute and relative  $VO_{2max}$  in the older age group of the soccer players is to a great extent the consequence of increased height reflected on the muscle mass. The relative maximal oxygen uptake rises around 1 mL/min/kg per year. This means that the aerobic working capacity follows the body development or is even faster, which is consistent with the results obtained in this research. As aforementioned, the majority of researchers agree that  $VO_{2max}$  is the best indicator of cardiorespiratory endurance, i.e. capacity. The  $VO_{2max}$  considerably increases in response to the endurance training. Soccer training has a great influence on the development of functional abilities, and the results are progressively better with age, and it is therefore expected that the U-15 and U-17 players will achieve similar results in the U-19 age group.

The preadolescence is crucial for the development of physical, technical and tactical abilities of young soccer players. Furthermore, the development of intellectual and motor abilities leads to the improvement of technical, tactical and psychological abilities. Adequate development of body and motor abilities during this period is crucial for the progress

of young soccer players because after that age the process of sport selection is very difficult. Success in soccer depends on various factors, including physical characteristics and physiological capacities of a player, on their level of skills and the degree of their motivation, as well as on technical and tactical preparations. Some factors are not easy to measure, but others can be tested using standardized methods and can provide useful information to the trainer and the team of experts. Differences in physiological indicators of various age groups are evident, and they should be integrated in the planning and programming of the training process. The results obtained point to high efficacy of the cardiopulmonary system of the subjects tested. This research definitely did not cover all the factors and dimensions on which success in soccer depends, but it can be a useful basis for the creation and implementation of new programmes in the field of planning, programming and implementation, and control of training for young soccer players.

## References

1. Bangsbo, J., Nørregaard, L., Thørso, F. (1991). Activity profile of competition soccer. *Canadian Journal of Sports Sciences* 16(2), 110-116.
2. Malina, R.M., Bouchard, C., Bar-Or, O. (2003). *Growth, Maturation and Physical Activity* (2<sup>nd</sup> edn). Human Kinetics, Champaign, IL.
3. Rowland, T.W. (1996). *Developmental exercise physiology*. Human Kinetics. Champaign, IL.
4. Wasserman, K., Hansen, J.E., Sue, D.Y., Casaburi, R., Whipp, B.J. (1999). *Principles of exercise testing and interpretation* (3<sup>rd</sup> edn). Baltimore: Lippincott Williams & Wilkins.
5. Wilmore, J.H., Costill, D.L. (1999). *Physiology of Sport and Exercise*. Human Kinetics, Champaign, IL.

The article was written within the scientific project no. 315-1773397-3332 (Laboratory Measuring Instruments in Kinesiology), supported by the Ministry of Science, Education and Sports of the Republic of Croatia.



## REACTION TIME, RANGE AND VELOCITY OF THE REVERSE HANDPUNCH IN ELITE KARATE ATHLETES

Borut Fonda<sup>1</sup>, Andrej Panjan<sup>2</sup> and Nejc Šarabon<sup>1,3</sup>

<sup>1</sup>Laboratory for Motor Control and Motor Behaviour, S2P, Science to Practice, Ltd., Bled, Slovenia

<sup>2</sup>Wise Technologies, Ltd., Laboratory for Advanced Measurement Technologies, Ljubljana, Slovenia

<sup>3</sup>Institute for Kinesiology Research, Science and Research Centre Koper, University of Primorska, Koper, Slovenia

### Abstract

The aim of this study was to examine simple and choice reaction time (RT) in elite karate athletes by performing karate-specific offensive action to visual stimuli (LED light) and to compare punch velocities and ranges to the punches in which additional leg action is involved. Fourteen elite karate athletes participated in this study. They had to react with different offensive action on a LED light stimuli. They performed three simple RT tasks: (i) reverse hand punch from a normal stance, (ii) reverse hand punch with simple entry without a step and (iii) reverse hand punch with entry with a step. One choice RT task was performed where the participant had to accurately execute a reverse hand punch or lead hand punch with the opposite hand. In the choice RT task, two different colors of the LED light appeared and the participant had to react for each color with a different. Additionally, ten reverse hand punches with self-initiated start were performed prior to RT tasks to get a data on maximal velocity and range of the punches. Though the longest RTs were observed when whole body had to move, they were performed faster and longer. These offensive actions are one of the most common in karate and therefore their efficiency many times represents a decisive part to determine the winner.

**Key words:** motor control, martial arts, information processing

### Introduction

Karate is a good example of a competitive sport where fast reactions are required to offend and defend against the opponents. That should lead karate athletes to develop their sensory and motor functions to make fast reactions. Karate athlete's ability to quickly and accurately perceive relevant information will facilitate decision making and allow more time for preparation and organization for the motor behavior (Mori, Ohtani, & Imanaka, 2002). Information processing for the reaction comprises the following four stages: (i) stimulus detection, (ii) differentiation, (iii) recognition and (iv) identification (Tanaka, Hasegawa, Kataoka, & Katz, 2010). Mori et al., (2002) considered two main types of perceptual abilities relevant to the karate athlete's performance. First is a basic sensory function which is not specific to particular types of sport expertise and therefore is not showing systematic difference between expert and novice athletes. Second is a sport-specific perceptual skill which is much better developed in expert athletes and has been typically investigated by sport-specific realistic stimuli and tasks.

In some studies (Scott, Williams, & Davids, 1993; Williams & Elliott, 1999) where they examined the role of anticipation in karate, realistic stimuli were used. They reported faster reaction times (RT) for expert athletes in both verbal and action responses. In latter studies (Mori et al., 2002) similar results were presented, which indicated differences in simple and choice RT between novice and expert karate athletes. Although the response was made by pressing the button and not by more realistic action such as presented in Scott et al., (1993), they have found significant differences between choice and simple RT tasks. Tanaka et al., (2010) focused on the self-position and posture perception skill of karate athletes in both offensive and defensive situation by using virtual opponent. They found that expert athletes were much faster in all RT tasks than novice athletes but the information about self-position had a positive effect on RT only for novices and not for experts. Although aforementioned studies reported differences in simple and choice RTs between martial arts beginners and experts, results of some studies, observing RT and movement time (MT), indicate otherwise (O'Donovan, Cheung, Catley, McGregor, & Strutton, 2006). They reported that the total RTs of the martial artists to an auditory stimulus were significantly faster than the control participants, however when analyzed further, it was revealed that the decrease in RT was due to the MT and not the RT itself.

In our study we examined simple and choice RT by making karate-specific action to a visual stimulus. Additionally, we used different involvements of leg action when performing a punch to examine how much they contribute to the average velocity and range of the reverse hand punch. We also examined if velocity and range of the punch differ between the situation when athletes perform a reverse hand punch in the simple or in the choice RT measurement paradigm.

## Methods

### Participants

Fourteen elite karate athletes (9 male and 5 female, all right handed; [mean  $\pm$  SD] age  $19.7 \pm 6.6$ , body height  $173.7 \pm 7.5$  and body weight  $69.2 \pm 12.4$ ) participated in this study. All participants were injury free, had at least 4 years of training experience and were regularly involved in the competition process and were members of the Slovene national team at the time of the study. Prior to the study they got familiarized with the procedure and their informed consents were obtained. The study was approved by the National Medical Ethics Committee of the Republic of Slovenia.

### Procedure and equipment

After the standardized 10-minute warm up participants got familiarized with the testing protocol. RTs were measured with the linear position sensor (S2P, Science to Practice, Ltd, Bled, Slovenia). The linear position sensor was mounted on the wall at the same height as the punch was performed (Figure 1). The wire from the linear position sensor was fixed to the glove on the participant's dominant hand. Another linear position sensor was attached to the torso at the waist height to measure the range and the velocity of the torso movement. In front of the participant LED lights were mounted which presented the stimuli. They performed three simple RT tasks: (i) reverse hand punch (gyakutsuki) from a normal stance (no leg movement), (ii) reverse hand punch with simple entry without a step and (iii) reverse hand punch with entry with a step. Entry means, that the participant had to jump forward with both feet simultaneously to increase the length of the punch. In a task with a step, additional step was performed with the rear leg before the forward jump. One choice RT task was performed where the participant had to accurately execute a reverse hand punch or lead hand punch (kizamitsuki) with the opposite hand. In the choice RT task, two different colors of the LED light appeared and the participant had to react for each color with a different punch (green for lead hand punch and red for reverse hand punch). Additionally, ten reverse hand punches with self-initiated start were performed prior to RT tasks to get a data on maximal velocity and range of the punches. All RT tasks were performed in random order to exclude possible fatigue effects. The goal of the participants was to execute offensive actions as fast as possible after the stimuli and with maximal effort. Simple RT tasks were performed ten times while the choice RT task was performed 20 times, all in random order with a random time difference (10 – 20 s) between them.



Figure 1. Measurement setup example. 1 = linear position sensor (LPS) and 2 = four LED lights on the LPS. The participant had to react on the light stimulus and make an offensive action (reverse hand punch) against the LPS. Picture is symbolic.

### Data analysis

Data from the linear position sensor was acquired with software for RT measurement (S2P, Science to Practice, Ltd, Bled, Slovenia). RT was defined as the period between the start of the stimuli and the beginning of the offensive action. Average RT of the ten repetitions was taken for further analysis and was compared among the different RT tasks. Relative range and relative velocity represents the range and the velocity of the punch made by a hand, while the contributions of the torso movement are subtracted from the data. On the other hand, absolute range and absolute velocity represents the total range and velocity of the hand movement (considering also the torso movement). Repeated measure analysis of variance (ANOVA for repeated measures) and *post-hoc* tests with Bonferroni correction for pairwise comparison were used to evaluate statistical difference ( $p < 0.05$ ) in RT, absolute range, absolute velocity, relative range and relative velocity.

## Results

Results of the RTs are presented in Figure 2. ANOVA for repeated measures was statistically significant ( $p = 0.000$ ;  $F = 193.6$ ) when comparing RTs among the tasks. Pairwise comparison showed statistically significant differences among all the tasks with  $p = 0.000$ . However, when comparing choice RT task with simple RT task with entry without a step,  $p$ -value was higher, but still statistically significant ( $p = 0.048$ ).

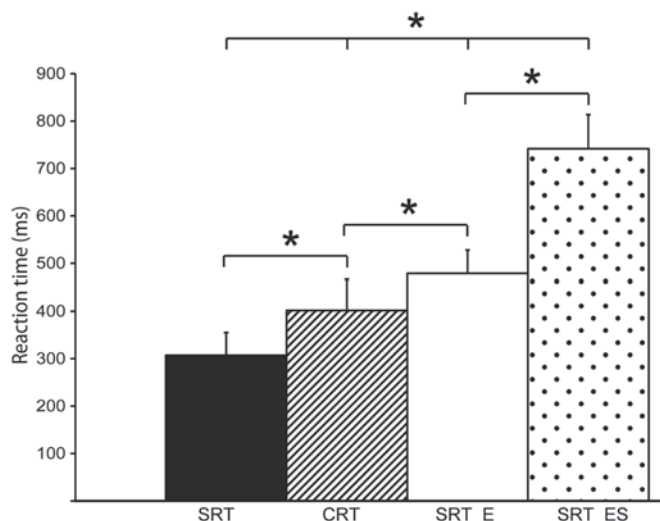

Figure 2. Average RTs for all reverse hand punch tasks (error bars represent standard deviations). SRT (black graph) = simple RT task; CRT (striped graph) = choice RT task; SRT\_E (white graph) = simple RT task with entry; SRT\_ES (dotted graph) = simple RT with entry and with step. Statistical significance ( $p < 0.05$ ) is marked with \*.

Average relative velocities and ranges of the punches were not statistically different among the tasks (ANOVA for repeated measures;  $p = 0.455$ ;  $F = 0.757$  and  $p = 0.294$ ;  $F = 1.896$ , respectively). Statistical differences were observed in absolute range and absolute velocity (ANOVA for repeated measures;  $p = 0.000$ ;  $F = 25.940$  and  $p = 0.000$ ;  $F = 14.091$ , respectively). Absolute range of the reverse hand punch with entry and step ( $94.1 \pm 16.2$  cm) and entry without a step ( $84.3 \pm 15.1$  cm) were statistically significant longer ( $p = 0.009$  and  $p = 0.001$ , respectively) compared to normal reverse hand punch ( $63 \pm 8.3$  cm). Absolute velocity of the reverse hand punch with entry and step ( $5.3 \pm 0.7$  m/s) was statistically significant faster ( $p = 0.001$ ) compared to normal reverse hand punch ( $3.8 \pm 0.6$  m/s). The reverse hand punch with entry but without a step ( $4.7 \pm 0.7$  m/s) the difference in absolute velocity was not statistically significant ( $p = 0.086$ ) compared to normal reverse hand punch.

## Discussion and conclusion

The aim of this study was to examine simple and choice RT in elite karate athletes by making karate-specific offensive action to visual stimuli (LED light). Additionally, different karate punches were used to see if there are any differences in RT, velocity or range of the punch when leg movements are involved.

In some studies (Scott et al., 1993; Williams & Elliott, 1999) the researchers examined the role of anticipation in karate by using realistic stimuli. The participant's tasks were to react to the stimuli with a response which had to be made by making a defensive action. In study by Mori et al., (2002) similar experimental designs were used to evaluate differences in simple and choice RT between novice and expert karate athletes but the response was made by pushing the button in a hand. Stimuli were made either by presenting the opponent on a big screen (video-stimuli) in front of the participant or by presenting dots (dot-stimuli) in the different parts of the screen (upper or lower part of the screen). In our study participants had to react on a LED light stimuli with realistic offensive action, i.e. with a punch. By using a novel biomechanical tool, we were able to measure RT, range and velocity of a punch. We have used relative velocity and range to examine if the participants have made all RT tasks with comparable dynamics to that when punches were self-initiated and we found that all tasks were performed with very similar effort and therefore relative range and velocity did not differ among the tasks. In general, we were surprised by a relatively small gain in the effective range of the punch when the leg action was added into the reverse hand punch action (25 and 32 % for entry without and entry with a step, respectively).

When comparing simple and choice RT we found that our results go in line with the study by Mori et al., (2002) who observed differences around 100 ms. Longer RTs were observed in both tasks where leg movement was required, especially when a movement was started with a step. However we have to be aware that the measured RT in that task

does not represent actual RT, but the start of the forward movement with a hand. In the task with a step and entry, the action has started with a step which was performed with the rear leg and that was not detected. In that case the actual RT was a start of the leg movement.

Absolute range and velocity which are more important than relative values were significantly different when using reverse hand punch with entry and especially when adding a step. The latter action was the fastest and longest, though the RT was the longest. Higher velocities in the tasks with body movements are probably the consequence of the more body parts moving forward (step and entry). The faster the punch is, more options to hit the opponent exist. That could be in a particular interest to karate coaches when considering which the best attack action is.

Our study gives good insight into the RT of the action modes which are sport-specific. Although some studies have already examined RTs in some defensive actions (Scott et al., 1993), none of them examined the effect of offensive actions. We have showed that RTs for standard reverse hand punch were short and comparable with more simple actions (Mori et al., 2002). Longer RTs were observed for choice RT tasks, while the longest RTs were observed when whole body had to move (with entry). However, the latter are one of the most common offensive actions in karate and therefore many times represents decisive part to determine the winner. We confirmed that with absolute range and absolute velocity of both punches with entry.

## References

1. Mori, S., Ohtani, Y., & Imanaka, K. (2002). Reaction times and anticipatory skills of karate athletes. *Human Movement Science*, 21(2), 213-230.
2. O'Donovan, O., Cheung, J., Catley, M., McGregor, A. H., & Strutton, P. H. (2006). An investigation of leg and trunk strength and reaction times of hard-style martial arts practitioners. *Journal of Sports Science and Medicine*, 5, 5-12.
3. Scott, M., Williams, A., & Davids, K. (1993). Perception-action coupling in karate kumite. S. S. Valanti, & J. B. Pittenger (Eds.), *Studies in perception and action II* (pp. 217-221).
4. Tanaka, K., Hasegawa, M., Kataoka, T., & Katz, L. (2010). The Effect of Self-Position and Posture Information on Reaction Time. *International Journal of Computer Science in Sport*, 9(3), 4-14.
5. Williams, A.M., & Elliott, D. (1999). Anxiety, expertise, and visual search strategy in karate. *Journal of Sport & Exercise Psychology*, 21(4), 362-375.

## CORRELATION BETWEEN EFFICIENCY IN PERFORMING BODY ELEMENTS AND ELEMENTS WITH A ROPE AND RIBBON IN RHYTHMIC GYMNASTICS

Gordana Furjan-Mandić<sup>1</sup>, Lejla Šebić<sup>2</sup> and Josipa Radaš<sup>1</sup>

<sup>1</sup>Faculty of Kinesiology, University of Zagreb, Croatia

<sup>2</sup>Faculty of Sports and Physical Education, University of Sarajevo, Bosnia and Herzegovina

### Abstract

Basic elements of rhythmic gymnastics are divided into: body elements (elements with no apparatus) and elements with apparatus. The distinction is that rhythmic gymnastics has to combine two motor tasks simultaneously. The research has been conducted on the basis of the abovementioned fact in order to establish the connection between performances of elements without apparatus (body elements with successful performing of technique elements) and elements with a rope and ribbon in rhythmic gymnastics.

The sample of subjects in this study consisted of 122 female students. All the subjects have successfully mastered the given elements and were given a passing grade on the final exam in Rhythmic gymnastics.

All subjects were tested with a series of 8 specific gymnastic skills (Furjan-Mandić, 2007). Fourteen specific gymnastic skills were based on body elements that were, in this specific gymnastic skill, used as independent (predictor) variables.

Correlations between performances of the body elements without apparatus and performances of the elements with a rope and ribbon were determined by the multiple regression analysis.

The research has indicated that there was a significant correlation between the performance of some elements without apparatus and effectiveness in carrying out selected tasks with the rope and ribbon in rhythmic gymnastics.

**Key words:** *students, body elements, rope, ribbon, performance, correlation*

### Introduction

It is well known that rhythmic gymnastics is a complex sport because, in order to be successful in this sport, the coordination is at the top of the specification equation. A specific quality is that a rhythmic gymnast must combine two motor tasks simultaneously. The gymnast has to manipulate an apparatus at the same time with a correct performance of body elements. Judges evaluate every element in accordance with the following characteristics: difficulty, artistry, execution (Jastrjemskaia, N. and Titov, Y. 1999).

There are some studies carried out with the objective to identify predictors of efficiency in rhythmic gymnastics, and the prevailing views are that the most important motor abilities (Miletić et al., 2004, Miletić, Furjan-Mandić., 2005).

The objective of this study is to establish the correlation between efficiency in performing elements without apparatus, and elements with a rope and ribbon in rhythmic gymnastics. Thereby, the intent would be to establish whether there is any justification for learning elements without apparatus separately from learning the apparatus handling, as well as the justification for an educational program of rhythmic gymnastics in elementary and high schools, as well as at universities, where elements without apparatus are mastered first, while learning elements with apparatus continues only after that.

### Methodology

#### Sample of subjects

The sample of subjects in this research consisted of 122 female students in the 2<sup>nd</sup> year of the Faculty of Kinesiology in the period from 2000 to 2002. All subjects had successfully mastered the given elements as a part of a preliminary exam and were given a passing grade for the final exam in rhythmic gymnastics.

#### Description of the experimental procedure

All subjects were tested with a series of 8 specific gymnastic skills (Furjan-Mandić, 2007). Fourteen specific gymnastic skills consisted of elements without apparatus that were used in this testing as independent (predictor) variables.

- **BKV** – waltz step,
- **BSDV** – split leap,

- **BSK** – fouetté leap,
- **BVB** – body wave sideways,
- **BVC** – body wave forward,
- **BOZ** – two pirouettes *en dedans* (turning inwards toward the front leg),
- **BOO** – pirouette *en dehors* (turning outwards toward the back leg),
- **BRV** – front scale.

Other 5 specific gymnastic skills consist of specific elements with the rope (3 specific gymnastic skills) and the ribbon (2 specific gymnastic skills), constituting five dependent (criterion) variables:

- **VG** – gallop forward – leaps through the rope,
- **VGS** – gallop sideways through the rope,
- **VSDVS** – two jumps through the rope (gallop, split leap, scissors forward),
- **TSDV** – snake with the ribbon connected with split leap,
- **TSK** – figure-eight shape with the ribbon in fouetté leap

The abovementioned evaluated elements were taken from the Code of Points for rhythmic gymnastics, in which one can find difficulty values for each element, as well as their performance methods.

Rhythmic gymnastics elements were evaluated in accordance with preset criteria.

When evaluating, the tested female students firstly performed elements without apparatus and then elements with apparatus. Efficiency in performing the given elements was evaluated by three female experts in rhythmic gymnastics, who also meet given criteria for participating in such evaluation, with grades from 2 to 5, (Šebić-Zuhrić et al., 2007).

### Data processing methods

For the purpose of this research, the data have been processed by the statistics software package Statistic for Windows 5.0. Correlations between performances of body elements and performances of elements with a rope and ribbon were determined by the multiple regression analysis.

### Results and discussion

Table 1. Correlations (Rope, Ribbon)

	<b>VG</b>	<b>VGS</b>	<b>VSDVS</b>	<b>TSK</b>	<b>TSDV</b>
<b>BKV</b>	0,58	0,53	0,43	0,43	0,44
<b>BSDV</b>	0,55	0,51	0,48	0,52	0,57
<b>BSK</b>	0,47	0,54	0,45	0,56	0,55
<b>BVB</b>	0,50	0,51	0,38	0,55	0,52
<b>BVC</b>	0,57	0,59	0,45	0,52	0,58
<b>BOZ</b>	0,49	0,53	0,47	0,48	0,53
<b>BOO</b>	0,58	0,55	0,47	0,53	0,56
<b>BRV</b>	0,49	0,49	0,48	0,49	0,54

Marked correlations are significant at  $p < 0,05$ ;  $N=122$

Based on the results in Table 1, one can conclude that predictor and criterion variables have made relatively low correlations between themselves, and that each of them separately has a certain specificity regarding movement structures which specify them as individual elements in rhythmic gymnastics.

Tables 2, 3 and 4 contain results of the multiple regression analysis for every single criterion variable.

Table 2. Results of the multiple regression analysis for the criterion variable "gallop sideways through the rope" (VGS)

	Beta	Std.Err.	B	Std.Err.	t(107)	p-level
<b>Intercept</b>			1,39	0,36	3,83	0,00
<b>BKV</b>	0,18	0,12	0,18	0,12	1,49	0,14
<b>BSDV</b>	-0,04	0,15	-0,04	0,16	-0,27	0,78
<b>BSK</b>	0,26	0,11	0,25	0,11	2,36	0,02
<b>BVB</b>	0,15	0,12	0,14	0,10	1,43	0,15
<b>BVC</b>	0,30	0,14	0,28	0,12	2,21	0,03
<b>BOZ</b>	0,07	0,13	0,06	0,12	0,50	0,62
<b>BOO</b>	0,10	0,14	0,09	0,12	0,76	0,45
<b>BRV</b>	0,12	0,11	0,13	0,12	1,10	0,27

Regression Summary for Dependent Variable: VGS  $p < 0,0$  Std.Error of estimate: 0,71

From the results in Table 2, one can notice that the highest and significant correlations were made between grades in the two elements without apparatus (fouetté leap – BSK, and body wave forward - BVC) and the performance of gallop sideways through the rope. Since the motor structure of the task gallop sideways through the rope is very similar to the structure of fouetté leap and body wave forward, such obtained results should not be surprising. That is to say, the gymnast starts fouetté leap from gallop sideways, while in body wave forward she alternately transfers the body weight from one leg to another with simultaneous bent position, which is a similar structure as in gallop sideways through the rope.

Table 3. Results of the multiple regression analysis for the criterion variable "gallop forward, leaps through the rope" (VG)

	Beta	Std.Err.	B	Std.Err.	t(107)	p-level
<b>Intercept</b>			1,21	0,37	3,26	0,00
<b>BKV</b>	0,25	0,12	0,25	0,12	2,02	0,05
<b>BSDV</b>	0,05	0,15	0,05	0,16	0,34	0,74
<b>BSK</b>	0,00	0,11	0,00	0,11	0,00	1,00
<b>BVB</b>	0,08	0,11	0,08	0,10	0,75	0,46
<b>BVC</b>	0,11	0,14	0,10	0,13	0,77	0,44
<b>BOZ</b>	-0,15	0,13	-0,14	0,12	-1,11	0,27
<b>BOO</b>	0,27	0,14	0,23	0,12	1,89	0,06
<b>BRV</b>	0,02	0,11	0,03	0,13	0,20	0,84

Regression Summary for Dependent Variable: VG  $p < 0,00$  Std.Error of estimate: 0,72

In Table 3 one can see that the variable BKV – waltz step, has the highest correlation with the variable VG – gallop forward, leaps through the rope. Those two elements demonstrated to be very demanding coordination-wise when female students were mastering them; therefore they require bigger efforts in learning and training. Regardless of the fact that they are seemingly simple and make a part of the physical education plan and program in elementary schools, evidently they represent a more complex coordination task even in a selected group, as are the female students of the Faculty of Kinesiology.

Based on the results from Table 4, one can conclude that the variable VG – gallop forward, split leap and scissors through the rope – did not produce even one significant correlation with predictor variables, moreover in the variables BVB – body wave sideways, and BVC - body wave forward, the negative correlation values were obtained. According to the movement structure, but also according to the association to the groups of technical elements in rhythmic gymnastics, body wave forward and sideways are completely different from jumps/leaps, and as such are evidently not significant in the methodology of mastering leaps and jumps through the rope. Regardless of the fact that in all tested elements of rhythmic gymnastics one of the criteria is an esthetic execution component of each and every one of them, it is important that rhythmic gymnasts are overall prepared for a good performance.

Table 4. Results of the multiple regression analysis for the criterion variable “gallop, split leap and scissors through the rope” (VSDVS)

	Beta	Std.Err.	B	Std.Err.	t(107)	p-level
<b>Intercept</b>			1,21	0,40	3,02	0,00
<b>BKV</b>	0,07	0,14	0,06	0,13	0,49	0,63
<b>BSDV</b>	0,11	0,17	0,12	0,17	0,68	0,50
<b>BSK</b>	0,14	0,12	0,13	0,12	1,12	0,27
<b>BVB</b>	0,00	0,12	0,00	0,11	-0,03	0,98
<b>BVC</b>	0,00	0,15	0,00	0,14	-0,01	0,99
<b>BOZ</b>	0,12	0,15	0,10	0,13	0,79	0,43
<b>BOO</b>	0,04	0,16	0,03	0,13	0,27	0,79
<b>BRV</b>	0,22	0,12	0,24	0,13	1,78	0,08

Regression Summary for Dependent Variable: VSDVS  $p < 0,00$  Std.Error of estimate: 0,78

Table 5. Results of the multiple regression analysis for the criterion variable “figure-eight shape with the ribbon in fouetté leap” (TSK)

	Beta	Std.Err.	B	Std.Err.	t(107)	p-level
<b>Intercept</b>			0,89	0,39	2,27	0,02
<b>BKV</b>	-0,05	0,13	-0,06	0,13	-0,44	0,66
<b>BSDV</b>	0,06	0,16	0,06	0,17	0,37	0,71
<b>BSK</b>	0,30	0,12	0,30	0,11	2,57	0,01
<b>BVB</b>	0,29	0,11	0,28	0,11	2,63	0,01
<b>BVC</b>	0,12	0,14	0,11	0,14	0,83	0,41
<b>BOZ</b>	-0,04	0,14	-0,04	0,13	-0,31	0,76
<b>BOO</b>	0,08	0,14	0,07	0,13	0,57	0,57
<b>BRV</b>	0,16	0,11	0,19	0,13	1,43	0,16

Regression Summary for Dependent Variable: TSK  $p < 0,00$  Std.Error of estimate: 0,76

Table 5 shows correlations between the criterion variable TSK - figure-eight shape with the ribbon in fouetté leap – and predictor variables. From the results, one can notice that fouetté leap without apparatus is mostly correlated with fouetté leap with the ribbon (BSK) and body wave sideways (BVB). The movement structure in both leaps is identical, except that the rhythmic gymnast makes a figure-eight shape with the ribbon during the leap, i.e. she additionally “manipulates” the ribbon, which can represent a coordination problem in the non-selected population. It is possible that there is a significant correlation between the variable body wave sideways (BVB) and the performance of elements with the ribbon just due to the good practice of body elements and figure-eight shape with the ribbon. That is to say, when executing body wave sideways and figure-eight shape with the ribbon in fouetté leap, the body moves in waves sideways, even though this is not as much pronounced in figure-eight shape with the ribbon in fouetté leap.

Table 6. Results of the multiple regression analysis for the criterion variable “snake with the ribbon connected with split leap” (TSDV)

	Beta	Std.Err.	B	Std.Err.	t(107)	p-level
<b>Intercept</b>			1,10	0,32	3,45	0,00
<b>BKV</b>	0,22	0,12	0,19	0,11	1,81	0,07
<b>BSDV</b>	0,05	0,15	0,05	0,14	0,33	0,74
<b>BSK</b>	0,13	0,11	0,11	0,09	1,22	0,23
<b>BVB</b>	0,09	0,11	0,07	0,09	0,84	0,40
<b>BVC</b>	0,18	0,13	0,14	0,11	1,31	0,19
<b>BOZ</b>	0,03	0,13	0,03	0,11	0,26	0,80
<b>BOO</b>	0,06	0,14	0,04	0,10	0,42	0,67
<b>BRV</b>	0,11	0,11	0,11	0,11	0,99	0,32

Regression Summary for Dependent Variable: TSDV  $R = ,69703937$   $R^2 = ,48586389$  Adjusted  $R^2 = ,41859374$   $F(14,107) = 7,2226$   $p < ,00000$  Std.Error of estimate: ,62254



Finally, as shown in Table 6, all variables are equally important for the execution of snake with the ribbon above head connected with split leap, although the variable BKV - waltz step - made the highest, however not significant correlation with that criterion variable. This data draws attention to the fact that evidently the rhythmic structure in which female students perform split leap connected with the ribbon manipulation is similar to the rhythmic structure of waltz step, even though this is not the case with rhythmic gymnasts.

## Conclusion

The carried out research showed that there is a significant correlation between performing some rhythmic gymnastics elements without apparatus and efficiency in performing selected tasks with a rope and ribbon. Such results lead to a conclusion that there is an objective justification that body elements are to be learned prior to starting mastering basic tasks with apparatus in rhythmic gymnastics. That is to say, the biggest correlations between body elements and simultaneous apparatus handling were made in those tasks in which the body and the apparatus do not move on the same level, which is very often the case in rhythmic gymnastics. A gymnast successfully performing such combinations shows virtuosity in her performance. That is why it is important to begin as early as possible with learning body elements and basic elements with apparatus in order to automatize their execution, which in the subsequent phase of learning more complicated combinations facilitates their execution.

## References

1. Furjan-Mandić, G. (2007). *Rhythmic gymnastics*. Textbook, Zagreb: Faculty of Kinesiology.
2. Jastrjemskaia, N., Titov, Y. (1999). *Rhythmic gymnastics*. United States of America: Human Kinetics.
3. Miletić, Đ., Sekulić, D., Wolf-Cvitak, J. (2004). *Leaping performance of a 7-year novice rhythmic gymnast is highly influenced by condition of motor abilities*. *Kinesiology*, 36(1): 35-43.
4. Miletić, Đ., Furjan-Mandić, G. (2005). *Motor conditions of mastering basic techniques with the ribbon in rhythmic gymnastics*. In: Sekulić D. (Ed.), *Proceedings Book of the First International Scientific Expert Symposium "Sport-Recreation-Fitness"*, Split, 93-96.
5. Šebić-Zuhrić, L., Rađo, I., Bonacin, D. (2007). *Effects of proprioceptive training on results in specific movements in rhythmic gymnastics*. *Acta Kinesiologica* 1: 30-37.
6. Wolf-Cvitak, J. (2004). *Rhythmic gymnastics*. Zagreb: Kugler, textbooks of the University of Zagreb.

## COMPARISON OF SELF-PERCEIVED FATIGUE AND CHANGES IN SURFACE EMG PARAMETERS DURING AN ALL-OUT SIX-MINUTE ROWING EXERCISE

Mitja Geržević

*University of Primorska, Science and Research Centre of Koper, Institute of Kinesiology Research, Koper, Slovenia*

### Abstract

This study aimed to identify whether fatigue order (FO) and/or fatigue level (FL), estimated by subjective perception matched with changes of surface electromyogram parameters of ten muscles during maximum effort 6-min ergometer rowing in 11 male rowers. Average rectified values (ARV) of the medial gastrocnemius decreased, while that of the rectus femoris (RF), vastus lateralis (VL) and gluteus maximus (GM) increased. Median power frequencies (MDF) of the RF, erector spinae (ES), lower and upper latissimus dorsi (LD\_lo and LD\_up, respectively) decreased ( $P < 0.05$ ), suggesting that only RF showed neuro-muscular fatigue, while VL and GM compensated for fatigue by recruitment of new motor units (MU), and ES and LD\_lo most likely compensated by MU rotation. FO was more consistent among participants than FL. Based on rowers' subjective estimates the most fatigued muscle was the quadriceps femoris, while the fatigue perception of the biceps femoris was greater than that of ES ( $P < 0.05$ ). The results showed that the changes of ARV and MDF did not completely match the self-perceived estimates of fatigue.

**Key words:** *muscle fatigue, rowing ergometer, electromyography, questionnaire*

### Introduction

Amplitude and power spectrum of the surface electromyography (EMG) signal are known to be influenced by both force and fatigue during maximal and sub-maximal isometric (Masuda et al., 1999; Moritani et al., 1982) and dynamic (Gerdl et al., 1989; Masuda et al., 1999; Wretling et al., 1997) muscle contractions. Motor unit (MU) recruitment, modulation of discharge rate, MU synchronization, muscle fibre conduction velocity and shape of intramuscular action potentials (AP) are the neuro-muscular mechanisms that are responsible for these changes (Dimitrova & Dimitrov, 2003; Masuda et al., 1999; Moritani et al., 1982).

Simultaneous consideration of EMG amplitude and power spectrum parameters can provide information on whether EMG changes are force-related or fatigue-induced. According to Luttmann et al. (2000) four different cases can be distinguished: (1) If the EMG amplitude increases and EMG spectrum shifts to higher frequencies, muscle force increase is the probable cause. (2) If the EMG amplitude decreases and EMG spectrum shifts to lower frequencies, muscle force decrease is the probable cause. (3) If the EMG amplitude increases and EMG spectrum shifts to lower frequencies, this is considered to be a result of muscle fatigue. (4) If the EMG amplitude decreases and the EMG spectrum shifts to higher frequencies, this is considered to be recovery from previous muscle fatigue. Even though dependencies of spectral variables on force are neither fully explained nor clear (Farina et al., 2002), it is possible to reach rather precise conclusions based on this simple and easy to implement four-case algorithm (Cifrek et al., 2009). However, two more assumptions could be made according to the findings of Tucker et al. (2009): (5) if the EMG amplitude increases and no changes in the EMG spectrum are seen, compensation for fatigue with MU recruitment and/or MU synchronization could be the probable cause and (6) if the EMG amplitude does not change and the EMG spectrum decrease, the probable cause could be fatigue compensation by MU rotation, which was recently demonstrated by Bawa & Murnaghan (2009).

Knowing which muscle fatigue first and/or the most is important for successfulness, planning of trainings and choosing the right/optimal training method in endurance sports like running, swimming, cycling or rowing. However, many other factors can also affect EMG amplitude and power spectrum. Some of them are: thickness of subcutaneous tissue, shape, size and orientation of electrodes, inter-electrode distance, distance from the source of the signal, crosstalk, number of activated MU during contraction, muscle fibre type, blood flow through the muscle etc. (DeLuca, 1997; Merletti et al., 2004). This is why the aim of this study was to identify whether subjective perception of fatigue matches the objective indexes extracted from surface EMG signal.

## Methods

### Subjects

Eleven healthy, well-trained male rowers (age:  $20.2 \pm 3.1$  years, height:  $188.7 \pm 5.8$  cm, mass:  $88.0 \pm 8.1$  kg, internship:  $8.0 \pm 3.9$  years), members of three Slovenian rowing teams, with regular rowing training over at least four years volunteered to participate in the study. Each subject was informed of the potential risks and discomforts associated with the investigation, and all subjects gave their written, informed consent to participate. The study was part of a larger project funded by grants from the Slovenian Research Agency, the Foundation for Financing Sports Organizations in Slovenia and the Government of the Republic of Slovenia, Ministry of Higher Education, Science and Technology. It was conducted according to the Helsinki-Tokyo Declaration and had been approved by the National Medical Ethics Committee.

### Measurement procedure

After a standardized warm-up protocol (10-minute rowing, constant speed, 0.11 m/s lower than the speed at lactate threshold) on a Concept IIC ergometer (Concept Inc., Morrisville, VT, USA), all subjects had to perform a 6-minute all-out rowing exercise. The aim was to achieve the best result possible at the time. The rowing power, frequency and strategy were not predetermined.

During 6-minute rowing EMG signals from 11 muscles (*medial gastrocnemius* – GC, *rectus femoris* – RF, *vastus lateralis* – VL, *biceps femoris* – BF, *gluteus maximus* – GM, *erector spinae* – ES, *lower latissimus dorsi* – LD\_lo, *upper latissimus dorsi* – LD\_up, *biceps brachii* – BR and *brachioradialis* – BB) were recorded on the right side of the body. Pairs of reusable Ag-AgCl electrodes (HELLIGE, Freiburg, Germany) with a 9-mm diameter were positioned according to the SENIAM recommendation (Hermens & Freriks, 1999). The distance between the electrodes in a pair was 2 cm and the resistance was kept below 5 k $\Omega$ . EMG signals were sampled using the BIOVISION EMG system (Wehrheim, Germany) and DASY LAB 7.0 software (2002, National Instruments, Austin, Texas, USA) with the sampling frequency of 2 kHz. The raw signal was processed using MATLAB 7.0.0 (R14) software (2004, The MathWorks, Inc., Natick MA); it was first filtered using a 5th-order band-pass Butterworth filter with the lower and upper cut-off frequencies set to 5 Hz and 500 Hz, respectively. It was then processed in the time and frequency domain.

Within the 6-minute rowing exercise EMG signals were analyzed only during the drive phase of each rowing stroke. During this phase only the active segments of the signal (Figure 1) of each muscle were taken into consideration for further analysis. For this reason the power envelope of the signal was first calculated according to Equation 1 (Geržević, et al., in press; Štirn et al., 2007) and then the active phases were set to >1% and >50% of the local maximum of the power envelope for calculating the average rectified value (ARV – Figure 1a) in the time domain and median power frequency (MDF – Figure 1b) in the frequency domain, respectively. The standard periodogram method based on the short time Fourier transform (STFT) was used to estimate the EMG power spectrum of each stroke.

$$P\left(k + \frac{n}{2}\right) = \sum_k^{k+n-1} x^2(i) \quad \text{Equation 1}$$

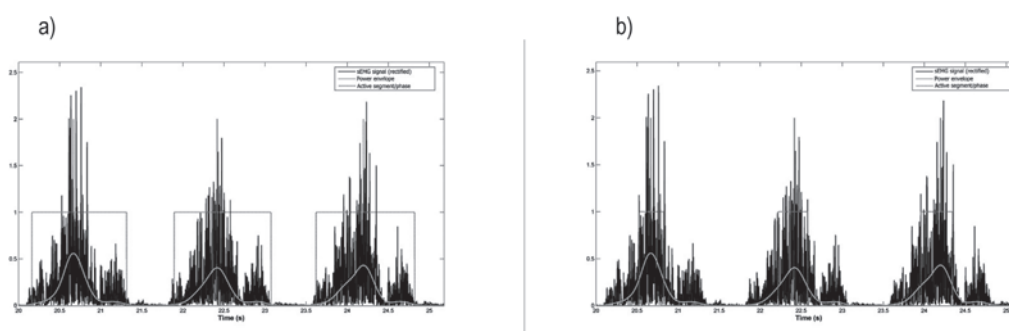

Figure 1. Rectified EMG signals (black line), power envelope of the EMG signal (gray line), and active segments/phases (dark gray dash line) of the vastus lateralis muscle for three consecutive rowing strokes. The active segments/phases for calculating a) ARVs were set on 1% and for b) MDFs were set on 50% of the power envelope's local maximums.

For every 30 seconds of the all-out rowing exercise, the average ARV and MDF values of ten consecutive strokes were calculated. Thus the following three parameters were determined for the ARV and the MDF:  $ARV_{10}$  and  $MDF_{10}$  as the average of ten strokes after the 10<sup>th</sup> second of rowing,  $ARV_{300}$  and  $MDF_{300}$  as the average of five strokes before and five strokes after the 300<sup>th</sup> second of rowing, and  $ARV_{360}$  and  $MDF_{360}$  as the average of the last ten strokes, with the last three strokes being excluded from the analysis. The ARV and MDF values of each muscle at each time point were normalized ( $nARV$ ,  $nMDF$ ) with respect to their values during maximum voluntary contraction (MVC) as shown in Equation 2 and 3, where  $T$  is an index of the selected time point. Three MVCs (2 s rising, 3 s maintaining the maximum, 30 s rest) for each muscle were elicited before the all-out rowing exercise in the positions for manual muscle testing according to Jakovljević and Hlebš (1998).

$$nARV_T(\%) = \left( \frac{ARV_T}{ARV_{10}} \cdot 100\% \right) \quad \text{Equation 2}$$

$$nMDF_T(\%) = \left( \frac{MDF_T}{MDF_{10}} \cdot 100\% \right) \quad \text{Equation 3}$$

Immediately after rowing all subjects had to fill in a specific, for this purpose composed questionnaire, where they had to define the order of 7 muscle groups (calf – m. triceps surae (TS), knee extensors – m. quadriceps femoris (QF), hamstrings muscles – m. biceps femoris (BF), hip extensors – m. gluteus maximus (GM), trunk extensors – m. erector spinae (ES), shoulder extensors – m. latissimus dorsi (LD) and elbow flexors – m. brachioradialis and biceps brachii (BR+BB)), based on their perception of fatigue – fatigue order (FO) – from 1 (the most fatigued) to 7 (the least fatigued). For further analysis and results presentation, the FO was inverted (1 – the least fatigued, 7 – the most fatigued). Six out of eleven subjects had to define also the level of self-perceived fatigue – fatigue level (FL) – of the same 7 muscles on a scale line from 0 (not fatigued) to 10 (completely exhausted). From these FL estimations we derived another fatigue order parameter – derived fatigue order (dFO) – to see whether it gives the same results as the FO, mentioned before.

## Data analysis

The data were processed by the SPSS 13.0 for Windows statistical package (SPSS Inc., Chicago, USA). Standard statistical methods were used for the calculation of means, standard deviations (SD) and to test variables' normality of the distribution (Shapiro-Wilk's test). Pearson's and Spearman's correlation coefficients were used to see whether fatigue orders and derived fatigue orders correlate. The repeated measures analysis of variance (RM ANOVA) was used to test the changes/differences in EMG parameters over time (among time points 10 s, 300 s, and 360 s) and to test the differences in the fatigue order and fatigue level among muscles. If statistically significant differences were found, additional post-hoc analysis was performed for RM ANOVA using the Bonferroni correction. If variables' distribution deviated from normal, the Friedman's and Wilcoxon's non-parametric tests for two related samples were used for testing the differences (with the Bonferroni's post-hoc correction). The  $P < 0.05$  criterion (two-tailed test) was used for establishing statistical significance.

## Results

The distributions of some parameters deviated significantly from normal ( $P < 0.05$ ). These were:  $nARV_{10}$  of RF, VL and ES muscles,  $nARV_{300}$  of RF,  $nARV_{360}$  of LD\_up,  $nMDF_{10}$ ,  $nMDF_{300}$  and  $nMDF_{360}$  of BF and LD\_lo, and FO and dFO of QF and BR+BB muscles.

The correlation between FO and dFO of the ES muscle was significant ( $r = 0.978$ ,  $P = 0.001$ ). However, no other significant correlations between FO and dFO were seen.

The results of RM ANOVA are shown in Figures 2 and 3. Figure 2 shows the results of subjective perceptions of the FO and FL after the all-out rowing exercise. From the FO parameter it could be seen that the QF muscle was significantly more fatigued ( $P < 0.05$ ) than most of the other muscles (except of TS) and the BF significantly more than ES muscle ( $P < 0.05$ ). However, the FL parameter did not show any significant difference among muscles ( $P > 0.05$ ). In Figure 2 the changes in  $nARV$  and  $nMDF$  during rowing are presented. The  $nARV$  of the RF, VL, GM and LD\_up muscles increased significantly and that of the GC decreased. On the other hand, the  $nMDF$  decreased in the RF, ES, LD\_lo and LD\_up muscles.

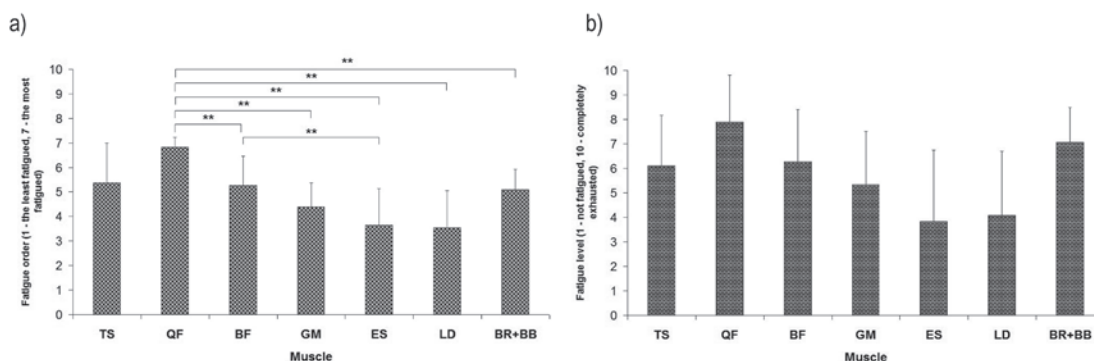

Figure 2. Average values and standard deviations of self-perceived a) fatigue order (FO) and b) fatigue level (FL) immediately after the all-out rowing exercise (\* -  $P < 0.05$ , \*\* -  $P \leq 0.01$ , \*\*\* -  $P \leq 0.001$ ).

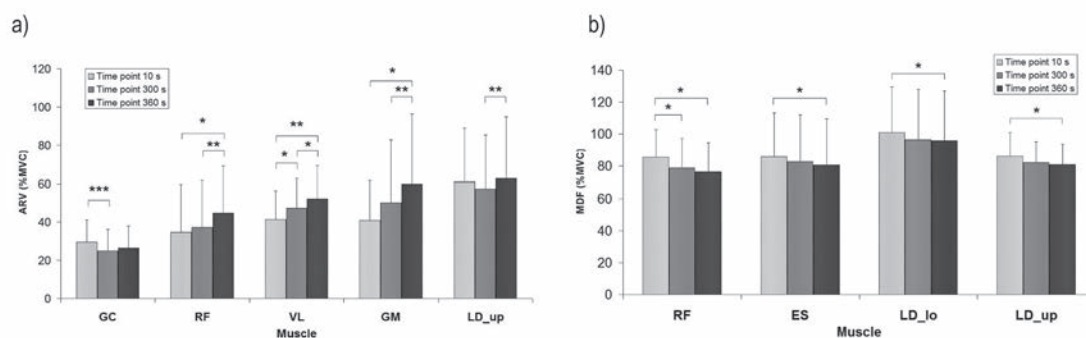

Figure 3. Average values and standard deviations of normalized EMG a) average rectified values (nARV) and b) median power frequencies (nMDF) in time points 10 s, 300 s and 360 s during the all-out rowing exercise (\* -  $P < 0.05$ , \*\* -  $P \leq 0.01$ , \*\*\* -  $P \leq 0.001$ ).

## Discussion and conclusions

The aimed of the present study was to identify whether FO and/or FL, estimated by subjective perception matched with changes of objective parameters extracted from the surface EMG signal of ten muscles during maximum effort 6-minute ergometer rowing. Even though many factors affect the EMG signal (DeLuca, 1997; Merletti et al., 2004) its amplitude and spectral variables are often used as an objective measure of neuro-muscular fatigue during isometric and dynamic contractions (Gerdle et al., 1989; Masuda et al., 1999; Moritani et al., 1982; Wretling et al., 1997). Troiano et al. (2008) found that during isometric contractions both subjective (based on Borg scale CR10) and objective (muscle fibre conduction velocity, amplitude and spectral EMG variables, fractal dimensions, entropy) indications of force and fatigue can provide information on (a) exerted force at different force levels from 10–80% MVC and (b) on endurance time during constant force level at 50% MVC until exhaustion of the upper trapezius muscle. However, Strimpakos et al. (2005) showed low repeatability and large between-day error for the slope of the normalized median frequency and root mean square of neck muscles and that the Borg assessment was more reliable than the EMG estimate. No correlation was found between the EMG and Borg assessment of neck muscle fatigue.

In this study the self-perceived fatigue and changes in normalized ARVs and MDFs of the EMG signal during dynamic muscle contractions were compared. The results showed there was no significant correlation between the FO and the FO derived (dFO) from the estimates of the FL, suggesting that the FO should not be extracted from FL estimates. The FO showed to be more consistent among participants than the FL because significant differences among muscles were detected with the FO, but not also with the FL estimates. These differences between the two estimates could be due to a greater standard deviations and/or lower number of subjects estimating the FL. However, the latter was still doubtful since also a lower number of subjects for the FO estimates preserved all the differences among muscles (results not shown). Thus the FO appeared to be more appropriate for estimating the differences in self-perceived fatigue among muscles. Based on these results, it could be concluded that the most fatigued muscle after the all-out rowing exercise was the QF, while the fatigue perception of the BF was significantly greater than that of the ES.

According to several studies (Luttmann et al., 1998; Luttmann et al., 2000; Tucker et al., 2009) and from the simultaneous consideration of the changes in nARV and nMDF it could be supposed that neuro-muscular fatigue occurred only in the RF muscle (nARV increased and nMDF decreased), while the VL and GM compensated for fatigue by recruitment of new MUs (nARV increased and no change of nMDF), and the ES and LD\_lo most likely compensated for fatigue by MU rotation (no change of nARV and nMDF decreased).

If the QF was the most fatigued muscle (based on FO) then it could be expected that the nARV would increase and nMDF would decrease significantly in one or more of its heads during maximum effort rowing. This situation was noticed just for the RF, but not also for the VL muscle (vastus medialis was not measured). However, VL compensated for fatigue as well as the GM, LD\_lo and ES muscles. The perception of fatigue of the ES and LD was the lowest among all muscles, but the FO of the ES differed significantly just from that of the BF muscle, which on the other hand did not show any change in nARV and/or nMDF. The results of this study showed that the changes of nARV and nMDF did not match the self-perceived estimates of fatigue, suggesting that caution is still needed when changes in EMG parameters are being linked to fatigue.

## References

1. Bawa, P., & Murnaghan, C. (2009). *Motor unit rotation in a variety of human muscles*. *Journal of Neurophysiology*, 102 (4), pp. 2265-2272.
2. Cifrek, M., Medved, V., Tonković, S., & Ostojić, S. (2009). *Surface EMG based muscle fatigue evaluation in biomechanics*. *Clinical Biomechanics*, 24, pp. 327-340.
3. De Luca, C., J., (1997). *The use of surface electromyography in biomechanics*. *Journal of Applied biomechanics*, 13, pp. 135-163.
4. Dimitrova, N., A., & Dimitrov, G., V. (2003). *Interpretation of EMG changes with fatigue: facts, pitfalls, and fallacies*. *Journal of Electromyography and Kinesiology*, 13 (1), pp. 13-36.
5. Farina, D., Fosci, M., & Merletti, R., (2002). *Motor unit recruitment strategies investigated by surface EMG variables*. *Journal of Applied Physiology* 92 (1), pp. 235-247.
6. Gerdle, B., Elert, J., & Henriksson-Larsén, K. (1989). *Muscular fatigue during repeated isokinetic shoulder forward flexion in young females*. *European Journal of Applied Physiology*, 58 (6), pp. 666-673.
7. Geržević, M., Strojnik, V., & Jarm, T. (in press). *Differences in muscle activation between submaximal and maximal six-minute rowing tests*. *Journal of Strength and Conditioning Research*.
8. Hermens, H., J., & Freriks, B. (1999). *European Recommendations for Surface ElectroMyoGraphy*. The SENIAM CD-ROM (SENIAM 9). Enschede: Roessingh Research and Development.
9. Jakovljević, M., & Hlebš, S. (1998). *Manualno testiranje mišic* [Manual muscle testing]. Ljubljana: Visoka šola za zdravstvo.
10. Luttmann, A., Jäger, M., Witscher, K., Vorgerd, M., & Tegenthoff, M. (1998). *Fatigue induced EMG changes during low-level isometric contractions*. SENIAM, Proceedings of the third general SENIAM workshop, Aachen, Germany, pp. 141-150.
11. Luttmann, A., Jäger, M., & Laurig, W. (2000). *Electromyographical indication of muscular fatigue in occupational field studies*. *International Journal of Industrial Ergonomics*, 25 (6), pp. 645-660.
12. Masuda, K., Masuda, T., Sadoyama, T., Inaki, M. & Katsuta, S. (1999). *Changes in surface EMG parameters during static and dynamic fatiguing contractions*. *Journal of Electromyography and Kinesiology*, 9, pp. 39-46.
13. Merletti, R., Rainoldi, A., & Farina, D. (2004). Myoelectric manifestations of muscle fatigue. In: Merletti, R., & Parker, P., A., (eds.), *Electromyography: physiology, engineering, and noninvasive applications* (pp. 233-258). Piscataway: IEEE Press.
14. Moritani, T., Nagata, A., & Muro, M. (1982). *Electromyographic manifestation of muscular fatigue*. *Medicine & Science in Sport & Exercise*, 14 (3), pp. 198-202.
15. Strimpakos, N., Georgios, G., Eleni, K., Vasilios, K., & Jacqueline, O. (2005). *Issues in relation to the repeatability of and correlation between EMG and Borg scale assessments of neck muscle fatigue*. *Journal of Electromyography and Kinesiology*, 15 (5), 452-465.
16. Štirn, I., Vižintin, T., Kapus, V., Jarm, T., & Strojnik, V. (2007). Change of mean frequency of EMG-signal during 100 meter maximal freestyle swimming. In: Jarm, T., Kramar, P., & Županič A. (eds.), IFMBE Proceedings 16: 11<sup>th</sup> Mediterranean Conference on Medical and Biomedical Engineering and Computing – Medicon 2007 (pp. 1002-1005). Ljubljana, Faculty of Electrical Engineering.
17. Troiano, A., Naddeo, F., Sosso, E., Camarota, G., Merletti, R., & Mesin, L. (2008). *Assessment of force and fatigue in isometric contractions of the upper trapezius muscle by surface EMG signal and perceived exertion scale*. *Gait and Posture*, 28 (2), pp. 179-186.
18. Tucker, K., Falla, D., Graven-Nielsen, T. & Farina D. (2009). *Electromyographic mapping of the erector spinae muscle with varying load and during sustained contraction*. *Journal of Electromyography and Kinesiology*, 19 (3), pp. 373-379.
19. Wretling, M.-L., Henriksson-Larsén, K. & Gerdle, B. (1997). *Inter-relationship between muscle morphology, mechanical output and electromyographic activity during fatiguing dynamic knee-extensions in untrained females*. *European Journal of Applied Physiology*, 76, pp. 483-490.

## Acknowledgement

This study was funded by grants from the Slovenian Research Agency (grant no. L5-6570 and L5-7112), the Foundation for Financing Sports Organizations in Slovenia and the Government of the Republic of Slovenia, Ministry of Higher Education, Science and Technology. The author would like to thank his mentor prof. dr. Vojko Strojnik for all the devoted enthusiasm for scientific and research work as well as for excellent management and guidance through the period as a young researcher. Big thanks go also to doc. dr. Tomaž Jarm for developing the routine for processing the EMG signals and to Rowing Federation of Slovenia, specifically to the selector Miloš Janša and all other coaches who supported this study.

## SITUATIONAL EFFICIENCY OF TEAMS IN FEMALE PART OF TOURNAMENT IN THE WORLD BEACH HANDBALL CHAMPIONSHIP IN CADIZ\*

**Igor Gruić, Dinko Vuleta, Marina Bazzo and Katarina Ohnjec**

*Faculty of Kinesiology, University of Zagreb, Croatia*

### Abstract

The aim of this paper was to determine the difference in situational efficacy in female part of Tournament in the World beach handball championship in Cadiz in 2008. The analysis contains parameters of situational efficacy obtained in beach handball matches at the World beach handball championship in Cadiz in 2008, in the first part of the competition played by the league system in groups. Applying the median test for each variable referring to criterion victory/defeat, it was found that a statistically significant difference between winning and defeated teams is in the following variables: *flight successfully (INF-U)*, *spin shot successfully (SPS)*, *blocking (BLO)*, and *technical errors (TEC)*.

**Key words:** *beach handball, descriptive statistics, world championship, extended median*

### Introduction

In comparison to classical indoor handball, beach handball is played on smaller size playground (27X13) on sandy underground, with fewer players (3 players and goalkeeper player marker). Game rules are in line with efforts to make the game as attractive as possible, uncertain and interesting for players and spectators (Belančić, 2005). Specific technical and tactical elements which give an extra dimension to beach handball are reflected in : 1) specific evaluation of certain parts of the game (2 sets, shot out), 2) evaluation of scored goals (attractive goals are worth 2 points-inflight, spin shot), 3) the fact that attack takes place almost always with the advantage of extra player 4:3 attack/defence 4) the role of goalkeeper-player (marker) that contributes to number superiority, scored goals worth two points and was the initiator of most attack actions (making "surplus" player for shooting positions from wide positions in spin shots, passing the ball in time for shot from inflight shot (zeppelin)).

Expert analysis for beach handball in previous studies, covering various aspects of beach handball development (Belančić, 2005; Agulla, 2009), followed by comparative analysis of indoor handball and beach handball (Neukum, 2007), effects of fitness training programmed micro circles in preparation for major competitions (Dechechi et al., 2009), injuries in beach handball (Manavis et al., 2008). Success analyses in competitions in beach handball are based largely on interpretation of descriptive indicators of registered situational effectiveness parameters (e.g. Gehr, 2007).

In 2008 in Cadiz Croatian men and women beach handball teams won the first place (gold medal). The aim of this paper was to determine the difference between winning and defeated teams of female part of the tournament referring to variable which describes situational effectiveness of beach handball.

### Methods

The sample contains 60 sets in 30 matches, played by 12 teams in the preliminary part of the competition of female beach handball tournament at the World Championship in Cadiz in 2008. The preliminary part of the tournament played by league system in two groups, and then the teams "crossed" with one another by 1A-2B, 1B-2A "key", i.e. the first and the second team from each group qualified for the semi-finals, the winners played in the finals, and the defeated teams played for the third place.

The sample of variables to assess situational efficiency in beach handball is described with frequencies of successful and unsuccessful shooting from the inflight, the spin shots, the specialist shooting, shooting from goal to goal, shooting for one point, penalty strokes and frequency of blocking, technical errors and goalkeeper saves. Success in criterion variable is defined by victory/defeat. In Table 1 certain variables are shown with their detailed explanation.

---

\* This research was supported, in part, by grant no. 034-0342610-2609 (Programming of transformational procedures for physical conditioning) from Croatian Ministry of science, education and sport.

Table 1. Sample of variables (names and explanations of technical-tactical elements of beach handball)

	Name	Variable description	Counting
1.	INF – inflight	Catching the ball and shooting on goal while the player is in the air	2
2.	SPS – spin shot	Shot on goal after a body rotation through 360 ° about the longitudinal axis of air	2
3.	SPE – specialist	Player marker is specially marked with T-shirt or a scarf in different colour; he participates in the game in the attack phase, usually after a change with the goalkeeper. He brings numerical superiority, but also a risk of scoring a «normal» goal, worth two points.	2
4.	DIG – directive gol	Goalkeeper is a player specially marked with a T-shirt or scarf in different colour, and is able, after the opponents' team scores a goal, to take the ball out of his space and throw it to the opponent's goal, which is worth two points	2
5.	ONP – one pointer	Goal achieved in normal, non spectacular way	1
6.	6 M – 6 meters throw	Six meter throw is the strictest penalty (penalty throw) in beach handball	2
7.	TEC – technical errors	The technical errors include: steps, irregular changes, players enter the goalkeeper area, incorrect throwing and catching the ball, offensive foul.	
8.	BLO – blocks	Blocking shots on goal in accordance with the rules: 1) blocking of back court players, 2) blocking jumping in the goal area while performing spin shots	
9.	GKS – goalkeeper saves	Goalkeeper saves	

For the first time in the short history of World Championships in Beach Handball statistical programme was applied to monitor the matches. Patterns with defined variables registered for each match, were designed. With the help of volunteers all 84 matches of the third World Championship in Beach Handball were monitored with the help of video recording, and statistics for matches were released on IHF's site immediately after the end of the match (according www.ihf).

### Data processing methods

Applying descriptive statistics measures of central tendency and dispersion for the observed set of variables were established. Results in the observed variables are distributed according to Poisson distribution and for analysis of difference non parametric statistical methods were used (median test).

## Results

### Descriptive analysis of indicators of situational efficiency in attack

In Table 2 results of descriptive statistics of monitored indicators of situational efficiency in preliminary part of World beach Handball Championship in Cadiz in 2008, were shown.

Table 2. Descriptive statistic of the performance parameters of the teams playing at the 2008 WC in Cadiz

	TOTAL					VICTORY			DEFEAT		
	N	Mean	Sum	S.D	Max d	Mean	Sum	S.D	Mean	Sum	S.D
SPS-S	120	3,05	366	1,92	0,13	3,8	228	1,74	2,3	138	1,81
SPS-M	120	2,97	356	2,11	0,20	2,7	162	1,66	3,23	194	2,46
SPE-S	120	1,56	187	1,44	0,21	1,83	110	1,66	1,28	77	1,14
SPE-M	120	1,53	183	1,3	0,23	1,4	84	1,21	1,65	99	1,39
IMF-S	120	0,85	102	1,2	0,25	1,02	61	1,3	1,1	66	1,47
IMF-M	120	0,82	98	1,07	0,37	0,82	49	1,08	0,65	39	0,86
OMP-S	120	1,08	129	1,5	0,25	1,05	63	1,55	0,68	41	1,08
OMP-M	120	0,58	69	0,87	0,29	0,5	30	0,87	0,82	49	1,07
6M-S	120	0,65	78	0,76	0,30	0,75	45	0,82	0,55	33	0,7
6M-M	120	0,15	18	0,38	0,51	0,12	7	0,32	0,18	11	0,43
DIG-S	120	0,33	39	0,64	0,45	0,4	24	0,74	0,25	15	0,51
DIG-M	120	0,41	49	0,63	0,41	0,38	23	0,58	0,43	26	0,67
TOTAL S	120	7,51	901	2,44	0,11	1,48	531	1,3	1,03	370	1,12
TOTAL M	120	6,44	773	2,98	0,08	0,99	355	0,95	1,16	418	1,15
BLO	120	0,56	67	0,89	0,34	0,73	44	0,88	0,38	23	0,87
GKS	120	2,88	346	1,88	0,15	2,97	178	2,02	2,8	168	1,74
TEC	120	4,3	516	3,33	0,15	3,23	194	2,48	5,13	322	3,72

KS-test=0.134

N - number of cases; MEAN - arithmetic mean; SD - standard deviation; SSM - sum; Max d - maximal difference between relative cumulative theoretical frequency (normal) and relative cumulative empirical frequency (obtained by measuring); SPS - spin shot; SPE - specialist goal; INF - inflight; ONP - one pointer; 6M - 6-meters throw; DIG - directive goal; BLO - blocks; GKS - goalkeeper save; TEC - technical errors;



In 60 sets there were 901 successful final actions in the attack, out of which 40% were shots on goal after rotation of body for 360 degrees around the longitudinal axis of air pirouettes (SPS), 20% shooting of specially marked players-markers (SPE), 14% of shots for one point (ONP), 11% shooting on goal while the player is in air-zepplin (INF), 8% of shots from 6m (6m) and 4% of shots from goal on goal (DIG). The total number of blocks was 67, around 1 per game, the total number of registered goalkeeper saves were 346, i.e. around three per game.

Applying median test for each variable in relation to victory/defeat criterion, a statistically significant difference between the teams in the following variables was established: inflight shots scored (*INF-S*,  $\chi^2=4,09$ ,  $df=1$ ,  $p=0,04$ ), spin shots scored (*SPS-S*,  $\chi^2=9,97$ ,  $df=1$ ,  $p=0,00$ ), blocks (*BLO*,  $\chi^2=10,11$ ,  $df=1$ ,  $p=0,00$ ), and technical errors (*TEC*,  $\chi^2=17,88$ ,  $df=1$ ,  $p=0,00$ ).

Table 3. Results of median test - the difference between winning and defeated teams

	Median Test, Overall Median = 1,00			Median Test, Overall Median = 3,00			Median Test, Overall Median = 0,00			Median Test, Overall Median = 4,00		
	Chi-Square = 4,09, df = 1, p = ,04			Chi-Square = 9,97, df = 1, p = ,00			Chi-Square = 10,11, df = 1, p = ,00			Chi-Square = 17,88, df = 1, p = ,00		
	<b>INF S</b>			<b>SPS S</b>			<b>BLO</b>			<b>TEC</b>		
	victory	defeat	all	victory	defeat	all	victory	defeat	all	victory	defeat	all
<= Median: observed	52	43	95	44	27	71	45	28	73	22	45	67
expected	47,5	47,5		35,5	35,5		36,5	36,5		33,5	33,5	
observed expected	4,5	-4,5		8,5	-8,5		8,5	-8,5		-11,5	11,5	
> Median: observed	8	17	25	16	33	49	15	32	47	38	15	53
expected	12,5	12,5		24,5	24,5		23,5	23,5		26,5	26,5	
observed expected	-4,5	4,5		-8,5	8,5		-8,5	8,5		11,5	-11,5	
Total observed	60	60	120	60	60	120	60	60	120	60	60	120

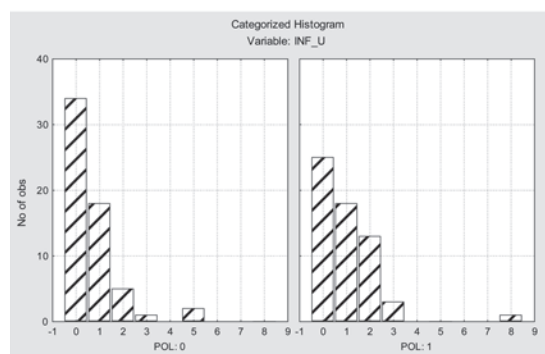

Figure 1. Histogram frequency inflight *INF-S*

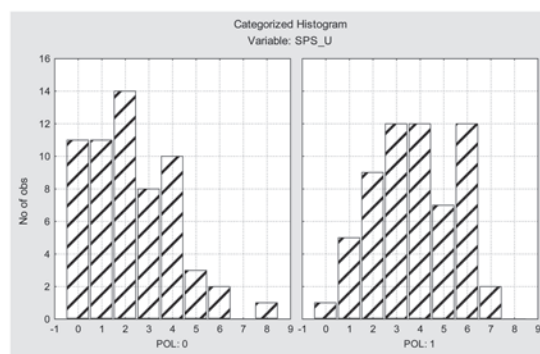

Figure 2. Histogram frequency spin shot *SPS-S*

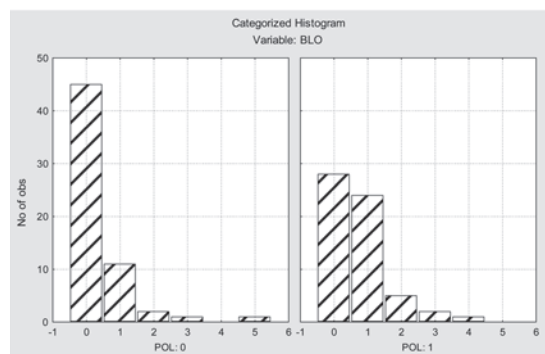

Figure 3. Histogram frequency blocks *BLO*

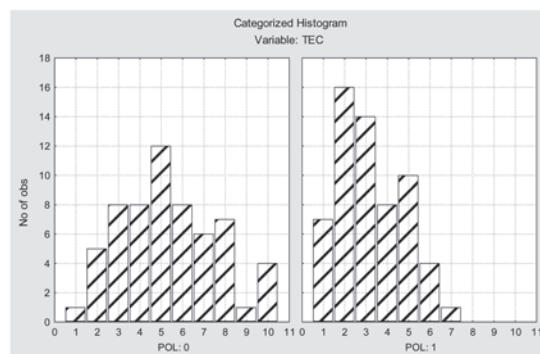

Figure 4. Histogram frequency technical errors *TEC*

## Discussion and conclusions

According to results of median test, there is a statistically significant difference between winning and defeated teams in the following variables *inflight shots scored (INF-S)*, *spin shots scored (SPS-S)*, *blocks (BLO)*, and *technical errors (TEC)* (Table 3).

Players from winner groups have more (52) than expected (47.5) number of *successful shots scored from inflights (INF-U)*, whereas players from losing groups proved less successful (43) than expected (47.5) (Table 3). Defeated teams have not performed any successful inflight shot in 35 sets, they have performed one successful inflight shot in each of 18 sets, two in each of 5 sets, three in one set and the highest, 5 successful inflight shots performed in two sets. Winning teams have not scored any successful inflight shot in 25 sets, they have scored one successful inflight shot in 18 sets, in 12 sets they were successful at two inflight shots, they have performed three successful inflight shots in 4 sets, and highest 8 successfully performed inflight shots scored in one set (Figure 1). Inflight shot is a technical-tactical element which requires cooperation between two players in the form of accurate and timely passing and catching the ball as well as shooting at goal on the fly, which is in the case of successful realization worth two points. Therefore, teams which were successful in cooperation and performance have achieved a higher score at the end of sets, which also means they won. According to results in Table 3, it is possible to conclude that the winning teams had players who due to their skills and cooperation and their practice, could meet the necessary level of successful shooting performance from spin shots.

Players from the defeated groups differ significantly (27) from expected number (35.5) of *successful shots from spin shots (SPS)*, as opposed to the players from the winning groups, i.e. they have more (44) than expected (35.5) number of successful spin shots (Table 3). The defeated teams have not successfully performed a single spin shot in 11 sets, whereas in the same number of sets they have successfully performed one spinshot per set, two successfully performed spin shots in 14 sets, in 8 sets they performed three successful spin shots per set, with 6 spin shots in two sets and maximum of 8 successful spin shots were performed only in one set. In the winning team in only one set there were no successful spin shots, one successful spin shot was performed in 5 sets, in 9 sets two successful spin shots, in 12 sets three successful spin shots were performed, the same number of sets was with 4 and 6 successful spin shots, in seven sets there were five successful spin shots, six successful spin shots were performed in 12 sets, and seven successful spin shots were performed in each of two sets (Figure 2). Derived from this, it is possible to conclude that the quality of individual action in terms of successful performance of technical elements of spin, which are worth two points, is a feature of winning teams. Winning teams probably had players whose individual levels of physical fitness and knowledge was optimal for successful shooting performance from spins. Capabilities such as explosiveness in jumps-take off in height and in space, connected to speed of turns, coordination in form of orientation skills in performing 360 degrees turn in air, are essential elements for successful performance of spin shots. Also, the very rule of attacking teams to play with an extra player, gives opportunities (space) for back players to perform shots from spins

In Table 3 effectiveness of defensive players indicated in *block variable (BLO)* is shown. Defensive players from winning groups have blocked more (45) than expected number (36.5) of shots from attack players, whereas defensive players from the defeated groups again showed a smaller (28) performance than expected (36.5). Players in defeated groups have not blocked any of 45 sets, they have blocked once in 10 sets, in two sets they have blocked twice, and in one set they have blocked three shots and a maximum, namely 5 blocks in one set. In the winner groups situation is different, namely, the winners in 29 sets have not blocked any shots, they have blocked once in 25 sets, twice in 5 sets, three times in two sets and they have blocked four times only in one set (Figure 3). Blocking shots is also an element in beach handball, and if carried out in accordance with the rules it becomes a feature of the winning team. Teams that have blocked more, won. It is possible to conclude that trained individual activities of defensive players, such as timely take offs, blocking balls after emesis and avoiding contact with attack players are the features of winning team players.

Players from defeated groups have more (45) technical errors (TEC) than the expected number (33.5), whereas the winning team had fewer (22) (Table 3). Defeated teams made one technical error only in one set, 12 sets had 5 technical errors, and there were 10 technical errors in 4 sets. Winning teams made one technical error in 7 sets, in 16 sets they have made two technical errors, and the most technical errors-7 was made only in one set (Figure 4). Activity of defence players apparently forced players in defeated teams to make technical errors such as steps, incorrect throwing and catching, offensive foul, entry of players in goalkeeper's space. The assumption is that insufficient levels of technical and tactical knowledge of attack players from defeated teams, as well as efficient performance of situational defence activities of winning teams caused a greater number of technical errors than expected.

This research opens space for further research directions in this sport referring either to tactical situational efficiency or specific tactical activities.

## References

1. Agulló, E. & Julio, J. (2009). *1993 – 2008 The Evolution Of Beach Handball, Its contribution To Indoor Handball And the Advantages Of Its Practice*. /on line/. Retrieved May 15, 2010 from [http://home.eSrohandball.com/ehf\\_files/pSblikation/wp\\_espina\\_evolStionbeachhb.pdf](http://home.eSrohandball.com/ehf_files/pSblikation/wp_espina_evolStionbeachhb.pdf)
2. Belančić, Z. (2005). *Rukomet na pijesku*. [Beach handball. In Croatian.]. /on line/. Retrieved May 15, 2010 from web portal rukometnih trenera
3. Dechechi, C.J., Monteiro Nascimento, C., Coeli Nunes, R., Gomes Almeida, A. & Vaz de Macedo, D. (2009). *Effects of 12 Physical Training Sessions on a Female Beach Handball Team Performance*. /on line/. Retrieved May 15, 2010. [http://home.eSrohandball.com/ehf\\_files/PSblikation/WP\\_De chir-WP\\_De chir\\_BHPhysTraining.pdf](http://home.eSrohandball.com/ehf_files/PSblikation/WP_De chir-WP_De chir_BHPhysTraining.pdf)
4. Gehrer, A. & Trespidi, M. (2007). *2007 European Beach Handball Chs / ITA - Qualitative Analysis* /on line/. Retrieved May 15, 2010 from [http://home.eSrohandball.com/ehf\\_files/PSblikation/WP-GereTrepidi\\_07BeachQSalitative%20Analysis%20Misano.pdf](http://home.eSrohandball.com/ehf_files/PSblikation/WP-GereTrepidi_07BeachQSalitative%20Analysis%20Misano.pdf)
5. Gruić, I., Vuleta, D., & Milanović, D. (2007). *Performance indicators of teams at the 2003 Men's World Handball Championship in Portugal*. *Kinesiology*, 38(2), 164-175
6. Kostas Manavis, Dimitris Hatzimanouil, Eleftherios Stefas, George S. Bebetos (2008). Injuries in beach handball. Beč/Austria EHF Web Periodical
7. Neukum, T. (2008). *Beach Handball vs. Indoor Handball* /on line/. Retrieved April 20, 2010 from [http://home.eSrohandball.com/ehf\\_files/PSblikation/WP\\_NeSkSm\\_Beach%20Handball%20vs%20Indoor%20Handball\\_E.pdf](http://home.eSrohandball.com/ehf_files/PSblikation/WP_NeSkSm_Beach%20Handball%20vs%20Indoor%20Handball_E.pdf)
8. Ohnjec, K., D. Vuleta, I. Gruić (2008). *Rukomet na pijesku kao sadržaj programa kineziološke rekreacije za djecu srednje i starije školske dobi*. [Beach handball as a part of recreational activities programme for primary and secondary school children. In Croatian.]. In Mirna Andrijašević (Ed.), *Zbornik radova Međunarodno znanstveno-stručne konferencije "Kineziološka rekreacija i kvaliteta života"*, Zagreb, 23. i 24. veljače 2008. (str. 87-95). Zagreb: Kineziološki fakultet Sveučilišta u Zagrebu.
9. Viskić-Štalec, N. (2010). *Statistika i kineziometrija u sportu* (str.279-293). Zagreb: Kineziološki fakultet Sveučilišta u Zagrebu.
10. Vuleta, D., Gruić, I., Ohnjec, K. i Bedić, D. (2004). *Rukometni sadržaji u funkciji promocije i razvoja rukometa u hrvatskom turizmu*. [Handball activities as a means of promoting and developing in Croatian tourism. In Croatian.]. In Mato Bartoluci (Ed.), *Zbornik radova Međunarodnog znanstvenog skupa "Menedžment u sportu i turizmu"*, Zagreb, 20. i 21. veljače 2004. (str. 169-176). Zagreb: Kineziološki fakultet Sveučilišta u Zagrebu.
11. Vuleta, D., Milanović, D., i Sertić, H. (2003). *Povezanost varijabli šutiranja na gol s konačnim rezultatom rukometnih utakmica Europskog prvenstva 2000. godine za muškarce*. [Relation among variables of shooting fo a goal and outcome of the 2000 men's European Championship matches. In Croatian.]. *Kinesiology*, 35(2), 168-183.

## FULLY TETHERED SWIMMING VS. SPRINT SWIMMING

Goran Leko, Klara Šiljeg and Dajana Zoretić

Faculty of Kinesiology, University of Zagreb, Croatia

### Abstract

This research attempted to establish a link between the dynamometric pulling force in tethered swimming and in 25 meter freestyle sprint swimming. For that purpose, 67 swimmers were tested, aged between 12 and 16, being subjected to a measurement of 18 anthropometric characteristics and undergoing 12 tests for the assessment of motor abilities. The criteria considered were the peak value of pulling force in freestyle tethered swimming and the time necessary to swim, freestyle, a 25 meter section including start. The results indicated that the connection between swimming speed and pulling force in tethered swimming show statistical significance (.62), but said relationship is relatively insufficiently high enough to enable us to predict the swimming result at 25 meters based on dynamometric force. The fact that speaks in favour of this supposition is that the prediction of said criteria is based on different parameters in different relationships.

**Key words:** *fully tethered swimming, free swimming, anthropometric characteristic, motor abilities*

### Introduction

Scientists and coaches in the area of swimming aim to define tests for the assessment of specific swimming abilities. Those tests should define the current abilities of an individual swimmer as reliably and precisely as possible. In the scope of a swimmer's training, an important place pertains to the development of strength of individual muscle groups that are involved in the creation of propulsive force. Very often coaches check the transfer of strength developed on dry land in comparison to stroke strength in the water, by measuring pulling force in the water. Tethered swimming training positively affects the development of strength in the upper and lower extremities (Arellano & Pardillo, 1990). Regularities of growth and development of boys are indicative of the fact that boys can be subjected to a significantly more intense training on dry land and in the water after their biological maturation (Taylor, MacLaren, Stratton, & Less, 2002).

This research primarily aims to determine whether swimming speed in the water can be predicted based on pulling force measurements taken in the water during tethered swimming. Its secondary goal is to verify the structure of influences that measured morphological characteristics have on results of the 25 meter swimming speed test and the pulling force measured in the water during tethered swimming.

In order to measure pulling force in the water, a dynamometric probe is used which will register swimmer-produced force value in the water. Peak force value in fully tethered swimming was measured in this research (Winter, et al., 2008).

Fully tethered swimming is a manner of swimming when the swimmer is anchored by an elastic tether to the wall of one lane of the swimming pool. A part of the elastic cord has a damper part to provide the shock-decrement. The dynamometer was connected to a PC. Having entered the pool, the swimmer did a 10-second trial of tethered swimming at medium intensity in order to get familiar with the equipment and the testing procedure. After a 1-minute rest the measuring commenced. The swimmers started tethered swimming (full technique – arms and legs stroke) at medium intensity and after two to three strokes, at the whistle of the timekeeper, they swam at maximal intensity for 10 seconds. The subjects were verbally encouraged throughout the test, instructed to avoid pacing and to maintain maximal effort for the duration of the test.

### Methods

The sample consisted of 67 male swimmers, aged between 12 and 16. All of them are participants of training programs at swimming clubs, with at least 6 years of experience. Testing was conducted at the Human Performance Laboratory of the Faculty of Kinesiology at the University of Zagreb during October and November of 2008. The testing procedure was standardized for all swimmers.

According to the recommendation of the International Biological program (Weiner & Lourue, 1969), we took the following measurements:

In order to assess the longitudinal dimensionality of the skeleton, body height (VT), arm length (DR), leg length (DN), hand length (DŠ) and foot length (DS) were measured. For the assessment of transversal skeleton dimensionality, hand diameter (ŠŠ) and foot diameter (SS) were measured. Body volume and mass were estimated based on measures

of body weight (TT), upper arm circumference in extension (ONADE), upper leg circumference (ONAT) and abdomen circumference (OTR). Skinfold was measured on the triceps (KNT) and the abdomen (KNTR).

In order to assess motor abilities, explosive leg strength was measured by the MESTSSJ, MESTSCM and MESTSBM test. Repetitive leg strength was measured by the MFRPCAT, MRRSPT60, MRRSEL, MRRUC60 and MRRSBP50 test. Flexibility was assessed based on the seat and reach (MFLSAR), (MFLPR), bar circumduction (MFLISP), plantar flexion (MFLES) and plantar extension (MFLFS) test.

The result of the pulling force in tethered crawl swimming was displayed on the monitor of the device registering peak force value for N. The tethered swimming device which was used is Fahnenmann's equipment for force testing.

The 25 meter test was used in the assessment of swimming speed applying the crawl technique. The task was performed from a starting block at the starter's signal, and the result was measured with one hundredth of a second accuracy.

## Results

Statistica for Windows 7.0, statistical software package was used to compute and report the data. The normality of distribution for each variable was tested. Also, minimal, maximal and mean values were calculated for all variables.

Table 1. Correlation of criterion variables ( $p < .05$ )

Variable	MSDINKK	MSPEC25
MSDINKK	1,00	-0,62
MSPEC25	-0,62	1,00

Legend: MSDINKK—tethered swimming peak force, MSPEC 25 – 25m freestyle swimming result.

Intercorrelation (Table 1.) between criterion variables is statistically significant, but much lower than expected (.62). There in accordance, the possibility of applying pulling force, as an indicator of swimming speed, in the water is rather limited. Regression analyses will determine whether the result of those two tests was caused by the same factors, as well as their relations.

Due to relatively high correlation links within the predictor set, data will be analyzed by a stepwise (forward) method in order to avoid the suppressor influence.

Table 2. The results of the regression analysis of the predictor set for the variable MSDINKK

R= ,90 R<sup>2</sup>=,82 Adjusted R<sup>2</sup>= ,79

F(10,56)=25,30 p<,05

N=67	BETA	SD.ERR.OF BETA	B	STD.ERR. OF B	T(51)	P-LEVEL
MFRPCAT	0,13	0,06	2,43	1,15	2,11	0,03
DS	-0,15	0,07	-5,61	2,71	-2,07	0,04
VT	0,42	0,14	2,66	0,91	2,93	0,00
MFLES	-0,13	0,06	-4,14	-2,10	0,04	0,04

Legend: MFRPCAT—foot catting, DS—foot length, VT—body height, MFLES – plantar flexion

Results of regression analyses, for tethered swimming pulling force in the water (Table 2.), show that the influence of the predictor set is statistically significant for the prediction of results. With statistical significance at the level of .05, the determination coefficient was .81. From a predictor set of variables, body height (VT), plantar flexion (MFLES), foot catting (footwork frequency) (MFRPCAT) and foot length (DS) stood out as the most significant ones. The most important role was played by body height. Although the predictive power of the aforementioned predictor set is significant, the structure of individual factors' shares is completely unclear. Particularly undefined is the negative impact of foot length and plantar flexion. By analyzing results, one is able to come to a conclusion on that in the observed criteria variable, a dominant influence pertains to body height and thereto proportionally the length of all levers performing strokes and kicks. The positive influence of alternate foot movement frequency is counteracted, in a negative sense, by large surfaces of the feet themselves which could be indicative of insufficient strength in the lower extremities for limbs of such length.

Table 3. The results of the regression analysis of the predictor set for the variable MSPEC25

R= ,85 R<sup>2</sup>=,72 Adjusted R<sup>2</sup>= ,64

F(15,51)=8,72 p&lt;,05

N=67	BETA	SD.ERR.OF BETA	B	STD.ERR. OF B	T(51)	P-LEVEL
<b>MRRSCU60</b>	-0,39	0,09	-0,06	0,01	-4,37	0,00
<b>ŠS</b>	0,22	0,10	0,39	0,18	2,13	0,03
<b>VT</b>	-0,84	0,27	-0,11	0,04	-3,14	0,00
<b>ONAT</b>	0,26	0,11	0,07	0,03	2,22	0,03
<b>ONADE</b>	-0,55	0,19	-0,25	0,09	-2,87	0,00
<b>MFLFS</b>	-0,19	0,08	-0,15	0,07	-2,27	0,02
<b>OGK</b>	0,49	0,23	0,08	0,04	2,15	0,03

Legend: MRRSCU60–squats in 60 seconds, ŠS–foot diameter, VT–body height, ONAT–upper leg circumference, ONADE–upper arm (extension) circumference, MFLFS–plantar flexion, OGK–chest circumference

Research results show that the predictor set can be used to predict results in 25 meter swimming (R<sup>2</sup>=,71). The possibility of prediction is statistically significant at a level of .05. Body height (VT), squats in 60 seconds (MRRSCU60), foot diameter (ŠS), upper leg circumference (ONAT), upper arm circumference in extension (ONADE), chest circumference (OGK) and plantar extension (MFLFS) stood out as the most significant variables. Body height and circumference measures played the most important roles. Isolated predictors are indicative of a dominant role of the upper extremities in swimming, while the lower extremities show a positive effect of repetitive leg strength, but also a negative influence of their excessive mass. The fact is that swimmers having large foot diameters and high transversal measures of the lower extremities will consume a large quantity of oxygen for their work, without significantly contributing to propulsive force.

By analyzing the structure of contributions each of the observed variables have had in the prediction of criteria, one may conclude that the observed criterion variables are somewhat different. Their intercorrelation is .62, which under practical conditions may be applicable up to a point, for the purpose of defining swimming speed based on pulling force in the water. The structure of predictors in the evaluation of the criterion variable says much more than that. While a dominant influence of the upper extremities and body height is clearly manifested in swimming speed at 25 meters, structure of the influence observed parameters have is defined unclearly in dynamometric pulling force.

## Discussion and conclusion

The analysis of measured parameters allows for a determination on that the correlation of maximum force produced in tethered swimming and the time required to swim 25 meters crawl is relatively low (.62). Possible reason of relatively low correlation might be measurement of maximum force value, and not the average one. Some former researches have shown that the average force value is a better indicator of swimming speed (Dopsaj et al., 2000). Furthermore, former researches have indicated that the correlation of tethered swimming and free swimming speed depends upon the swimmer's age (Vorontsov, et al., 1999), swimmer's level of quality (Sidney et al., 1996), and the course being swam (Yeater et al., 1981).

However, the structure and quantity of influences certain variables have, lead us to conclude that the results in these two criterion variables are not contributed to by the same factors, and particularly not in the same relations. Besides, size of the correlation link also doesn't speak in favour of the assertion that swimming speed can be predicted based on pulling force in the water.

By comparing regression analysis' results, we may conclude that based on the observed predictive set it is possible to better predict pulling force in the water than swimming speed at 25 meters crawl.

A conclusion is to be drawn on that measuring maximum pulling force in the water in tethered swimming can not be used to replace swimming speed at 25 meters. A possible explanation may lie in the very movement of the body through water during sprints, contrary to in-place swimming during which pulling force in the water is measured. Although in some researches the relative pulling force in the water shows a higher level of correlation (Dopsaj et al., 2000, Yeater et al., 1981), the structure of shares certain variables have in the results speaks in favour of the fact that those two tests are affected by different parameters, in different relationships.

What remains is the possibility to apply tethered swimming as a method to develop arm or leg strength, but in no way as an indicator of swimming speed since it is evident that other mechanisms are taking part in the execution of said tests.

## References

1. Dopsaj, M., Matković, I., Zdravković, I. (2000). The relationship between 50m- freestyle results and characteristics of tethered forces in male sprint swimmers: A new approach to tethered swimming test. *Facta Universitatis. Physical Education and Sport*. 1(7). 15-22.
2. Yeater, A.T., Martin , R.B., White, M.K. Gilson, H.K. (1981). Tethered swimming forces in crawl, breast and back strokes and their relationship to competition performance. *Journal of Biomechanics*. 14 (8). 527-537.
3. Morouco, P., Soares, S., Vilas-Boas, J.P., Fernandes, R. (2008). Association between 30sec maximal tethered swimming and swimming performance in front crawl. 2008 Annual Meeting. American Society of Biomechanics. Ann-Arbour. MI.
4. Sidney, M., Pelayo, P. & Robert, A. (1996). Tethered force in crawl stroke and their relationship to anthropometric characteristic and sprint swimming performance. *Journal of Human Movement Studies*, (31), 1-12.
5. Taylor, S., MacLaren, D., Stratton, G. & Less. A. (2002). The Effect of Age, Maturation and Growth on Tethered Swimming Performance. *Proceedings of the IX<sup>th</sup> World Symposium on Biomechanics and medicine in Swimming IX*. p.p. 185-90. Saint-Étienne, France.

## DEFENSIVE PROCESS OF WORLD CUP 2006 AND EURO CHAMPIONS 2008: T-PATTERN ANALYSIS

Nuno M. Martins<sup>1</sup>, Hugo M. Sarmento<sup>1,2</sup> and José C. Leitão<sup>1</sup>

<sup>1</sup>University of Trás-os-Montes e Alto Douro, Vila Real, Portugal

<sup>2</sup>University of Barcelona, Barcelona, Spain

### Abstract

Despite the old adage “the attack wins games but the defence wins trophies” the study of the defensive process (DP) in football has been somewhat neglected by the scientific literature. The observation of sports performances has focused on the frequency of occurrence as its performance index, still is debatable whether the frequency data alone allow to successfully distinguish effective performances and less effective performances, therefore observational studies should expand their indices of performance further than the frequency (Borrie et al, 2002). The authors state that their data show the need for observational studies to expand indices of performance further than frequencies of occurrence in order to accurately represent the observed performance. The behaviour was coded through an “*ad hoc*” observational instrument combining field formats and categorical systems called ObsPD. Values above 0.9 for all criteria were achieved in this instrument reliability analysis, calculated through inter and intra-observer agreement. Three games of the Italian national team winner of the World Cup 2006 and 3 of the Spanish national team winner of the EURO 2008 were registered using Thème Coder software. For t- patterns detection we used THEME 5.0 ( $p < .005$ ). We conclude that the scoreline and the game time influenced the characteristics of the detected t-patterns, while the numerical relationship between teams did not influence the characteristics of the detected t-patterns.

**Key words:** football, patterns of plays, successful teams

### Introduction

It is acknowledged that the defensive process (DP) has an important role in a football team success; however, there is a discrepancy in the scientific literature on defensive process when compared with the offensive process.

Historically, the observation of sports performance has focused on the frequency of occurrence as its performance index, however, is debatable whether the frequency data alone can successfully differentiate between effective and less effective performances (Borrie et al., 2002).

The detection of play patterns is one tendency to be followed, being emphasized the potential in detecting temporal patterns of behaviour (James, 2006).

The analysis approach applied here is based on a type of time pattern called a T-pattern. A T-pattern is fundamentally a combination of events in which the events occur in the same order with the real-time differences between consecutive pattern components remaining relatively invariant (i.e. the time difference between A and B will be  $x \pm y$ ) with respect to an expectation assuming, as a null hypothesis, that each component is independently and randomly dispersed over time. As stated by Magnusson (2000), “*that is, if A is an earlier and B a later component of the same recurring T-pattern then after an occurrence of A at t, there is an interval [t+d1, t+d2] (d2\_d1\_d0) that tends to contain at least one occurrence of B more often than would be expected by chance*” (p. 94). The temporal relationship between A and B is defined as a critical interval and this concept lies at the centre of the pattern detection algorithms (Magnusson, 2000).

Therefore, to analyse and characterise the defensive process of successful teams were the main purposes of this study.

### Methods

The study observational design was multidimensional, nomothetic and sequential (Anguera, 2003). The behaviour was coded through an “*ad hoc*” observational instrument combining field formats and categorical systems. The methodology of instrument conception consisted in deductive-inductive procedures with special reference to the literature review, the consulting of a panel of experts consisting of coaches (UEFA level IV) and researchers to find out what performance indicators should be included in the instrument and content validation. The “*ad hoc*” observational instrument (ObsPD) was created combining field formats and categorical systems, formed by five vertebrate criteria and the respective observed behaviours for each of these criteria (Martins, 2010). The instrument reliability was calculated by the intra and inter observer accordance, calculated through *Cohen's K* (using SDIS-GSEG software) and showed reliability levels higher than 0.9 for all criteria (Martins, 2010) and a *K* value greater than 0.75 is considered excellent. The following



criteria were used in this study: Criterion 1: Game characteristics. Constituted by three sub-criteria: game time, scoreline and numerical relationship between teams; C2: Spatial characteristics. Constituted by two sub-criteria: field area and interaction context; C3: Start of the DP. Constituted by two sub-criteria: last offensive action and adversary ball recovery action; C4: Development of DP. Constituted by three sub-criteria: first defender position, pressing relation and passing lines; C5: End of the DP. Constituted by one sub-criterion: ball recovery action.

Three games of the Italian national team winner of the World Cup 2006 and 3 of the Spanish national team winner of the EURO 2008 were registered using Thème Coder software, which allowed to obtain 459 DP and a total of 3620 code lines.

A generic software package called Theme has been developed specifically for the detection and analysis of T-pattern (Magnusson, 2000). The corresponding detection algorithm for a T-pattern allows detection of repeated temporal and sequential structures in real-time behaviour records. The pattern type and algorithm were developed and tested extensively (Magnusson, 2000). For t-patterns detection we used THEME 5.0, ( $p < .005$ ).

## Results

The results show that top-level teams have made a total of 459 defensive processes during the six observed games, making an average of 76.5 in each game. 11080 t-patterns were detected, corresponding to 3419 different t-patterns, ranging from a minimum of two events to a maximum of 16 events (figure 1) and one level to a maximum of nine levels (figure 2).

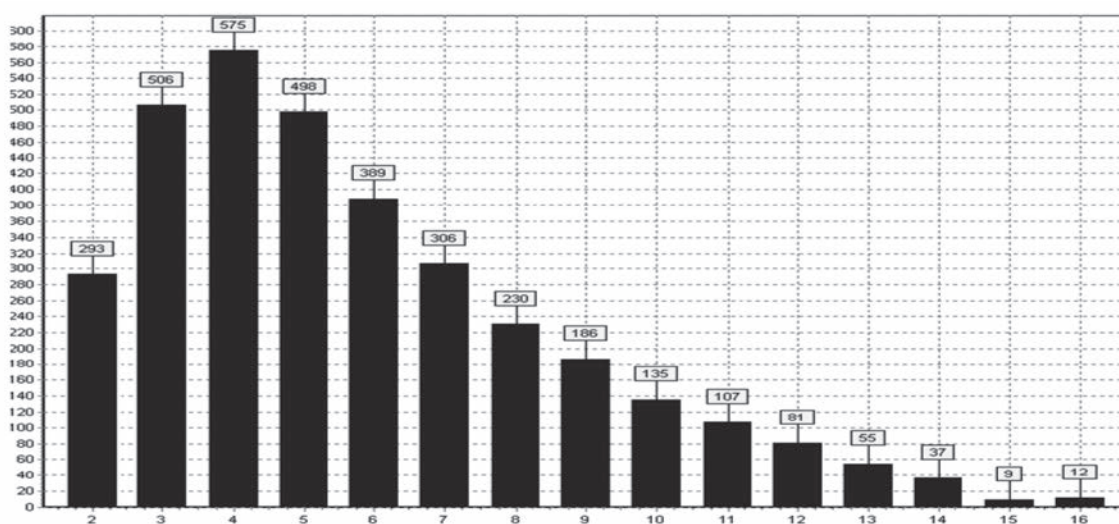

Figure 1. Distribution of T-patterns on the number of events.

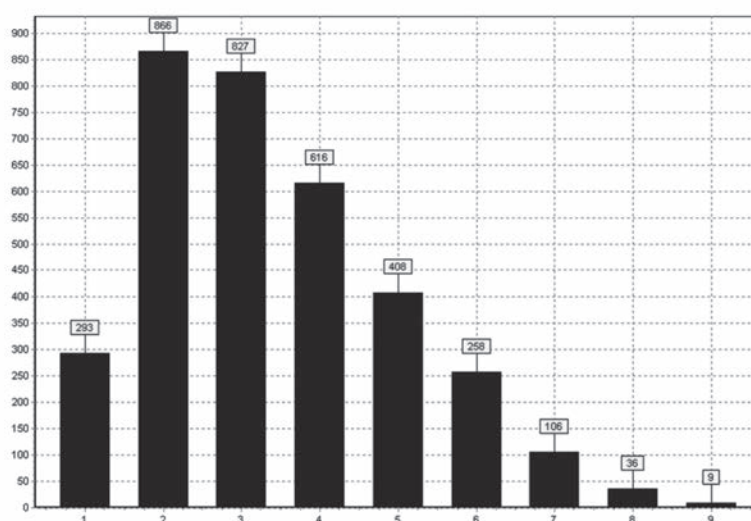
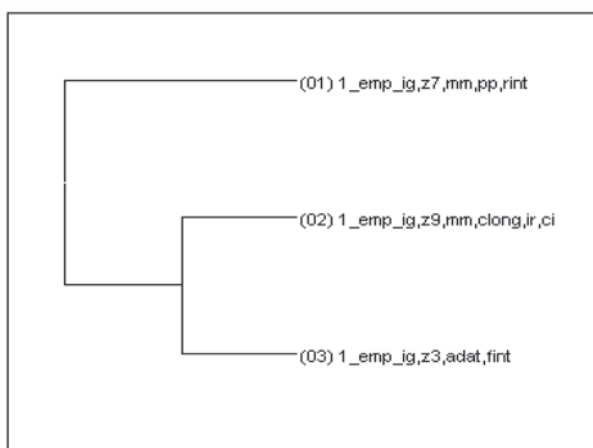

Figure 2. Distribution of T-patterns on level.

Next we proceed to the presentation of some detected t-pattern.



T-pattern n° 1 (of 49 selected)

The T-pattern n° 1 shows a temporal relationship between start, development and end of DP, this pattern has registered four occurrences.

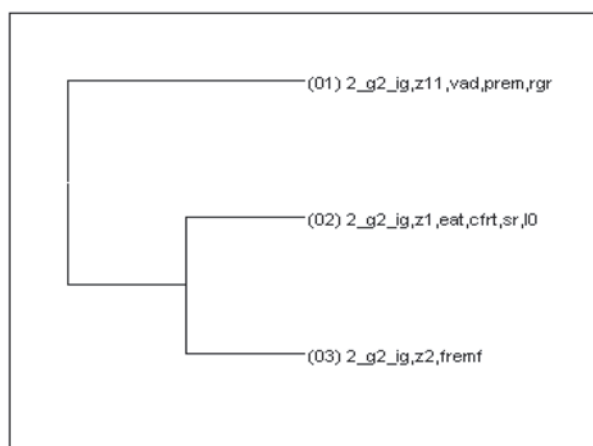

T-pattern n° 24 (of 49 selected)

The T-pattern n° 24 shows a temporal relationship between start, development and end of DP, this pattern has registered five occurrences.

## Discussion and conclusion

The T-patterns reveal that:

- i) In the start of DP the observed teams are preparing for their DP during the anterior offensive process;
- ii) After loss of possession, it is not a priority to immediately recover the ball, but to restore defensive organization;
- iii) In the development of DP the observed teams use a defensive game method that does not assign equal importance to all field areas or to all opponent players, performing in function of space and not players;
- iv) In the end of DP the teams attempt the recovery of possession, preferably in areas which are particularly favorable to this recovery;
- v) The observed teams showed a good performance in DP, resulting in not conceding goals and not allowing score attempts, exception being a T-pattern finished with shooting out.

We conclude that the scoreline and the game time influenced the characteristics of the detected t-patterns because we found t-patterns with different categories of these sub-criteria, while the numerical relationship between teams did not influence the characteristics of the detected t-patterns, for the reason that the detected T-patterns were in numerical

equality. We also conclude that the observed teams used a zone defensive game method, with zone pressing in defensive and middle-defensive sectors and in the sides of the field.

## References

1. Anguera, M. T. (2003). Observational Methods (General). In R. Fernández-Ballesteros (Ed.), *Encyclopedia of Psychological Assessment*, 2, 632-637. London: Sage.
2. Borrie, A., Jonsson, G.K., & Magnusson, M.S. (2002). Temporal pattern analysis and its applicability in sport: an explanation and exemplar data. *Journal of Sports Sciences*, 20, 845-852.
3. James, N. (2006). Notational analysis in soccer: past, present and future. *International Journal of Performance Analysis in Sport*, 6(2), 67-81.
4. Magnusson, M.S. (2000). Discovering hidden time patterns in behavior: T-patterns and their detection. *Behavior Research Methods*, 32(1), 93-110.
5. Martins, N. (2010). *Metodologia Observacional em Futebol: Detecção de padrões de comportamento no processo defensivo*. Master Thesis. UTAD, Vila Real.

## HOW DOES THE PERFORMANCE OF ACROBATIC ELEMENTS AFFECT FINAL BEAM RESULTS IN ARTISTIC GYMNASTS

Durdica Miletić, Sunčica Delaš Kalinski and Ana Božanić

*Faculty of Kinesiology, University of Split, Croatia*

### Abstract

The new gymnastics' Code of points introduced in 2006 prescribes that the difficulty value on the balance beam is determined by the sum of 8 most difficult elements including the dismount. The main aim of current research was to establish whether the choice of acrobatic elements influences the final score on the balance beam in top junior artistic gymnastics. The sample consisted of 109 female junior gymnasts, who participated in balance beam qualifications of the European Championships in Birmingham in 2010. The results showed that gymnasts in average perform 5.39 acrobatic elements on the beam. The highest prevalence of acrobatic elements was observed among the elements with B difficulty ("round-off" and "flic-flac with step-out"), different one legged dismount forward somersaults and backward somersaults (tucked or stretched). Strong linear connections between the predictor variables (types of elements) and the criterion variable (difficulty value and final score) were found. Statistically significant influence of different acrobatic elements on the execution value was not found probably because gymnasts perform less acrobatic elements with more accurate technique which leads to fewer mistakes. It can be concluded that only a few gymnasts choose greater number of acrobatic elements in their routines to achieve higher number of elements' associations and secure higher final value.

**Key words:** *balance beam, code of points, juniors, execution value, difficulty value*

### Introduction

Drastic changes occurred in artistic gymnastics' Code of points (COP) in 2006. Fédération Internationale de gymnastique (FIG), the oldest of international sport federations, introduced a new points system in which scores are no longer limited to 10 points. With a D score being the difficulty score, and E score being the score for execution, the points now go up to 20. The D score is based on the top 8 high scoring elements in a routine, and E score is given for how well the skills are performed (Fédération Internationale de Gymnastique, 2006). If gymnast performs minimum 8 elements, E score has an initial value of 10.00 points from which judges deduct errors that occur during the performance of a routine. Summing up D and E values judges define the final score for the performance. According to Cuk et al. (2010) with D scores only we can predict 84% of all-round final score.

The new rules apply on all gymnastics apparatus in Men's (MAG) and Woman's (WAG) Artistic Gymnastics except for the vault. Among all apparatus in WAG balance beam is the most exciting and the most difficult one. The routine on the balance beam is an artistic fusion of gymnastic leaps, acrobatics and balance elements in standing, sitting and lying positions. Along with the floor exercise, the balance beam is an apparatus that has the most injury incidence, especially in top athletes (Kirialanis et al., 2002; Caine et al., 2003). The reason for high incidence of injuries is in special composition requirements prescribed by the COP that demand a certain number of difficult acrobatic elements. The element requirements differ between categories of juniors and seniors although juniors and seniors, by the author experience, are usually different only in terms of age while the differences in quality and quantity of performing gymnastics elements are less obvious.

In order to fulfill special requirements on the balance beam junior gymnast must perform: (1) one connection of at least 2 different dance elements, 1 being a leap, jump or hop with 180° split (cross position only); (2) turn; (3) one acrobatic series, minimum of 2 flight elements, 1 being a somersault (elements may be the same); (4) acrobatic elements in different directions (forward/sideways and backward); and (5) dismount C difficulty. Adding up values that result from fulfilling composition requirements, as well as regulations about maximum 8 highest difficulty value elements (including the dismount), it is possible to determine that D value of the exercise is made from difficulty value of minimum 3 dance elements and 5 acrobatic elements (including dismount). The question is how many elements gymnasts usually perform in order to achieve the highest possible D value. Also, it is not clear if the choice of acrobatic and dance elements should lean towards the difficult ones as their performance increases the chance of falling.

The main aim of current research was to establish whether the choice of acrobatic elements influences the final score on the balance beam in junior artistic gymnastics. For that purpose we analyzed: (1) the number of acrobatic elements; (2) the type of the acrobatic elements; (3) relations between the type of the acrobatic elements and the difficulty score; (4) relations between the type of the acrobatic elements and the execution score; and (5) relations between the type of the acrobatic elements and the final score.

## Methods

A total sample of 109 top junior female gymnasts (age 15 and 16 years old), competing at the qualifications of the European championships in Birmingham in 2009 was investigated. From the official beam results we made 6 variables: difficulty value (DV), execution value (EV), final score (FS), total number of acrobatic elements (AE) and total number of beam elements (TBE).

Data were analyzed using the Statistica for Windows 7.0 package. Statistical significance was set at  $p < 0.05$ . Graphic presentation was used to demonstrate the prevalence of certain acrobatic elements on the balance beam. Basic descriptive statistics were calculated for all variables: mean values (Mean), standard deviations (SD), minimum (Min) and maximum (Max) results, skewness (Skew) and kurtosis (Kurt). The Kolmogorov- Smirnov test (K-S) was used to confirm the normality of distributions. Finally, three multiple regression analyses investigated relationships between unique acrobatic elements and (1) D value, (2) E value and (3) final score.

## Results

Table 1. Basic descriptive statistics for all variables; the results of the Kolmogorov- Smirnov test for normality of distributions

	Mean	SD	Min	Max	Skew	Kurt	K-S
DV	4.82	0.52	3.50	6.30	0.03	0.29	0.10
EV	7.08	0.88	4.55	8.83	-0.62	0.12	0.08
FS	11.90	1.19	8.65	14.75	-0.11	0.07	0.04
AE	5.39	1.12	3.00	9.00	0.20	0.06	0.18
TBE	11.67	1.63	7.00	16.00	0.41	0.52	0.15

d value for K-S test (N=109) is 0.15 with  $p < 0.05$

Basic descriptive statistics (Table 1) revealed a DV mean value of 4.82 while the EV mean value was 7.08. The mean final score was 11.90 points. According to K-S test and values of skewness and kurtosis, those variables had normal distributions. Among the total number of beam elements (mean 11.67), the gymnasts performed in average 5.39 acrobatic elements. According to Kolmogorov-Smirnov test differences were found between the observed and expected distributions ( $p < 0.05$ ), since the boundary for the d values was 0.15. Values of skewness and curtosis coefficients revealed minor positive leptokurtic distributions.

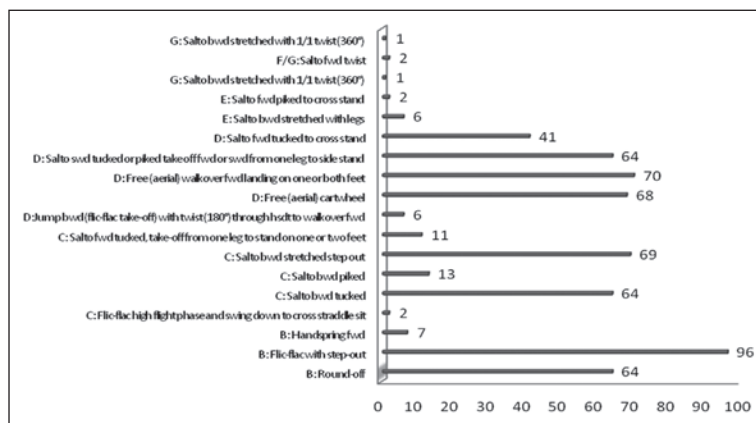

Graph 1. The prevalence of certain acrobatic elements on the balance beam

The highest prevalence of acrobatic elements was observed among the elements with B difficulty (“round-off” and “flic-flac with step-out”), different one legged dismount forward somersaults and backward somersaults (tucked or stretched) (Graph 1).

Table 2. Regression analysis of difficulty value; execution value; final score and total number of beam elements; and types of beam elements (difficulty from B to G)

	DV		EV		FS	
	Beta	p	Beta	p	Beta	p
B: round-off	0.16	0.05	0.04	0.69	0.10	0.30
B: flic-flac with step-out	0.09	0.37	0.08	0.55	0.09	0.42
B: handspring fwd	-0.04	0.64	-0.02	0.81	-0.04	0.70
C: flic-flac high flight phase and swing down to cross straddle sit	-0.02	0.82	0.08	0.43	0.05	0.58
C: salto bwd tucked	<b>0.17</b>	<b>0.04</b>	-0.02	0.89	0.06	0.51
C: salto bwd piked	0.10	0.19	0.11	0.27	0.13	0.18
C: salto bwd stretched step out	<b>0.35</b>	<b>0.00</b>	-0.02	0.88	0.14	0.23
C: salto fwd tucked, take-off from one leg to stand on one or two feet	0.10	0.23	0.12	0.27	0.13	0.18
D: jump bwd (flic-flac take-off) with ~ twist (180°) through hsd to walkover fwd	0.14	0.15	0.14	0.26	0.17	0.15
D: free (aerial) cartwheel	0.07	0.44	-0.02	0.84	0.01	0.90
D: free (aerial) walkover fwd landing on one or both feet	<b>0.32</b>	<b>0.00</b>	0.11	0.29	<b>0.22</b>	<b>0.02</b>
D: salto swd tucked or piked take off fwd or swd from one leg to side stand	<b>0.24</b>	<b>0.00</b>	0.16	0.12	<b>0.23</b>	<b>0.02</b>
D: salto fwd tucked to cross stand	<b>0.25</b>	<b>0.00</b>	-0.02	0.86	0.09	0.33
E: salto bwd stretched with legs	<b>0.43</b>	<b>0.00</b>	0.25	0.02	<b>0.37</b>	<b>0.00</b>
E: salto fwd piked to cross stand	<b>0.18</b>	<b>0.02</b>	0.13	0.19	<b>0.17</b>	<b>0.05</b>
F/G: arabian salto tucked (takeoff bwd with ~ twist [180°], salto fwd twist	<b>0.24</b>	<b>0.00</b>	0.07	0.47	0.16	0.08
G: Salto bwd stretched with 1/1 twist (360°)	-0.04	0.64	-0.27	0.01	<b>-0.22</b>	<b>0.03</b>
<b>R</b>	0.73		0.47		0.60	
<b>R<sup>2</sup></b>	0.54		0.22		0.35	
<b>p</b>	<b>0.00</b>		0.15		<b>0.00</b>	

Finally, for the three multiple regression analyses with different types of acrobatic elements as the predictors, criterions were DV in the first analysis; EV in the second; and FS in the third (Table 2). The first analysis showed high values of multiple correlation coefficients (0.73) that indicate strong linear connections between the predictor variables and the criterion variable. Also, predictor variables explain 54% of the total variance. All statistically significant predictors (acrobatic elements) have a positive influence on the criterion. The second regression analysis revealed that acrobatic elements are not good predictors of EV (0.47), while the third analysis shows medium linear connections between the predictor variables and the criterion variable and the predictors explain 35% of the total variance.

## Discussion and conclusions

It is obvious that the junior gymnasts performed a minimum of 3, and a maximum of 9 acrobatic elements in their beam routines. However, the K-S test revealed the existence of a larger group of gymnasts performing less than 5.39 acrobatic elements and less than 11.67 total beam elements. In accordance with the COP in which the DV is defined by top 8 high scoring elements (5 acrobatic and 3 dance elements), this result is logical. In fact, due to puberty period characteristics and the effort of maximally reducing the injury prevalence in younger gymnasts, which are the most common outcome of poor technique, it is possible to deduct that junior gymnasts mostly perform the exact amount of elements as prescribed by the COP for DV calculation. Every unnecessary element could cause a needless fall possibly followed by an injury.

The analysis from the Graph1 confirmed the high variety of the elements in today's gymnastics. It is possible to conclude that the 2006 COP led to changes in the routine composition, with a use of a more varied number of elements on the apparatuses in WAG, as well as in the MAG (Carrara, 2009).

The first regression analysis confirmed the assumption of acrobatic elements' high impact on the DV. All significant Beta coefficients have a positive influence on the mentioned value. The elements of the highest values proved to be the best predictors of DV: two C elements (*somersault backward tucked and somersault backward stretched step out*), three D elements (*free aerial walkover forward landing on one or both feet, somersault sideways tucked or piked take off forward or sideways from one leg to side stand and somersault forward tucked to cross stand*), two E elements (*somersault backward stretched with legs and somersault forward piked to cross stand*) and one F/G element (*arabian somersault tucked takeoff backward with twist 180°*). We can say that this outcome was expected since DV is consisted of 4 highest scoring elements (not including the dismount).

When performing acrobatic elements mistakes can occur in every phase of the element. These phases are interdependent. Mistakes that occur in later phases can be linked with earlier phases (Marinšek, 2009). EV is set to recognize and evaluate those mistakes. The absence of significant influence of types of acrobatic elements on the EV of the score is possible to explain by summarizing the basic statistic results. The majority of the gymnasts perform less acrobatic elements with more accurate technique which led to fewer mistakes, therefore, fewer deductions, so no relations with the EV were found.

Analyzing the third regression analysis it is clear that the highest scoring elements are the best predictors of success in junior gymnastics competition. However, the *somersault backward stretched with 1/1 twist* turned out to have a negative influence on the FV of the routine. That later can be explained by the fact that the mentioned element was the most difficult. It is possible to conclude that its performance was followed by a fall in majority of cases which negatively influenced the EV and, therefore, the final score.

It can be concluded that only a few gymnasts choose greater number of acrobatic elements in their routines to achieve higher number of elements' associations and secure higher FV accordingly. However, different situation occurs when entering the senior category where a much higher number of acrobatic elements than required are performed and greater requirements are put in front of the gymnasts (Han et al., 2005). The question is whether there is need for a higher number of those elements since their performance increases the chance of falling and injuries.

## References

1. Caine, D., Knutzen, K., Howe, W., Keeler, L., Sheppard, L et al. (2003). A three-year epidemiological study of injuries affecting young female gymnasts. *Physical Therapy in Sport*, 4(1), 10-23.
2. Carrara, P. (2009). Influence of code of points in training systematization of men's artistic gymnastics. *Brazilian Journal of Kinanthropometry and Human Performance*, 11(1), 120.
3. Ćuk, I. and Forbes, W. (2010). How apparatus difficulty scores effect all around results in men's artistic gymnastics. *Science of gymnastics*, 2(3), 57-63.
4. Fédération Internationale De Gymnastique (2009). Code of Points. Woman's Technical Committee.
5. Han, H, Dai, R. and Zhu, Z. (2005). On the New Trend of Women's Balance Beam Displayed at the Three World Gymnastic Tournaments and the 28th Olympic Games. *Journal of Beijing Teachers College of Physical Education*, 6.
6. Kirialanis, P., Malliou, P., Beneka, A., Gourgoulis, V., Gifostidou, A. et al. (2002). Injuries in artistic gymnastics elite adolescent male and female athletes. *Journal of Back and Musculoskeletal Rehabilitation*, 16(4), 145-151.
7. Marinšek, M. (2009). Landing characteristics in men's floor exercise on European championships 2004. *Science of Gymnastics*, 1(1), 31-39.

## RELATIONS BETWEEN BASIC AND SPECIFIC AGILITY OF YOUNGER AGE HANDBALL PLAYERS

Saša Rodić<sup>1</sup>, Igor Gruić<sup>2</sup> and Katarina Ohnjec<sup>2</sup>

<sup>1</sup>High school Jastrebarsko, Croatia

<sup>2</sup>Faculty of Kinesiology, University of Zagreb, Croatia

### Abstract

The aim of the research was to determine the contribution of basic agility to specific manifestations of agility in handball, on a representative sample of respondents from three best teams of Croatian championship for younger cadets, born on 1996. or later. For this purpose three tests for assessing basic motor abilities were used (*MAGKUS*, *MAGSLAL*, *MAG20Y*) and 3 tests for assessing specific motor abilities (*CHALF2*, *KN2*, *MAGKV4*). It was found that the greatest contribution in all team results in specific agility has basic lateral agility (*MAGKUS*), but if only team leaders are isolated in all three teams then frontal agility (*MAG20Y*) is more expressed for back center movement and pivot, while in half left and half right movement largest transfer to the manifestations of specific movements has lateral mobility.

**Key words:** handball, youth, agility

### Introduction

Reliable and valid measurement instruments for assessing physical fitness of athletes are an integral part of basic diagnostic procedures in practice. Given that sports differ in structure, complexity of biomechanical parameters, the dominance of the energy process and the dominance of motor skills, it is important to know capabilities on which depends premium sports score, but also which tests should be applied to obtain the best information on the degree of trainings certain specific motor skills in athletes.

In the area of the agility it is necessary to develop sport-specific tests that assess cognitive and motor component of agility, as preliminary results of some studies suggest that the difference of top athletes from those less successful differ significantly in cognitive, but not in the motor components of agility (Markovic, 2010).

Studies of time-motion characteristics of handball (Ziv and Lidor, 2008), showed that a significant proportion of high-activity and maximum intensity fall of on sprints and planned and random rapid changes of direction (Markovic, 2010). A very important feature of sports (football, basketball, handball) is need for repetitive manifestations of activities of high intensity (sprint and rapid changes of direction) during the competition (Markovic, 2010).

The need for rapid establishment of movement, stopping, changing course and movement direction (towards Rogulj, Kordi 2004) in the specific conditions of handball game encourages to change/ improve the condition and level of basic and specific trainings especially agility, speed and explosiveness of handball players. (Gruić, Vuleta, Ohnjec, 2010).

Due to characteristics of handball, a variety of agility manifestations are common in modern handball. In previous pilot studies about relation of basic and specific manifestations of agility (Rodic, Gruić, Ohnjec, 2011.) contributions of basic agility to specific agility were determined, however, differences in contributions were determined by gender and age of examinee. For this reason, the influence of basic agility to specific manifestations of agility was analysed in the same age group as in previous studies, but on a representative sample consisted of top three teams in their age group.

The aim of this study was to determine the effect of different manifestations of basic agility to some specific manifestations of agility in the handball game in younger age groups.

### Methods

The sample represents 40 handball players, younger cadets of HC Moslavina, HC Zagreb CO and HC Medveščak aged between 14 and 15 years. Respondents are members of the three best teams at Croatian Championship for boys of class 1996. held in Biograd from 27. - 30. may 2010. All subjects were good health condition, without morphological, pathological or other damage to the musculoskeletal system, and with fully passed basic trainings in handball.

Basic motor skills were tested using the battery of measuring instruments shown in Table 1, and specific motor abilities were tested using the battery of measuring instruments shown in Table 2.



Table 1. Predictor set of variables for assessing basic motor abilities

	VARIABLE	NAME	INTENTIONAL MEASUREMENT OBJECT
1	MAGKUS	Side steps	Lateral agility
2	MAGSLA	Slalom run 20m	Frontal agility in changes of direction to 90°
3	20Y	20 Yard shuttle	Frontal agility with turns, deceleration and acceleration

Table 2. Criterion set of variables for assessing specific motor abilities

	VARIABLE	NAME	INTENTIONAL MEASUREMENT OBJECT
1	CHALF2	Centerhalf movements	Specific agility - imitation of centerhalf movements with lateral and deep component
2	KN2	Circle runner movements	Specific agility - imitation of moving and positioning of circle runner
3	MAGKV4	Moving between goalposts	Specific agility - agility in frontal and lateral moving with changing course and movement direction to 90°

Parameters of central tendency and dispersion parameters of the predictor variables (arithmetic mean, minimum and maximum values, standard deviations, and the curvature distribution) were defined by descriptive statistics. Regression analysis defined the association between indicators of basic motor abilities and individual manifestations of specific agility, while analysis of variance showed differences between teams, and post hoc Scheffé test for determining differences between teams.

## Results

Measurement results of basic and specific motor abilities for all three teams, only for team leaders, and the other players on the team are shown in tables 3 and 4.

Table 3. Descriptive statistics of variables for the assessment of motor abilities in all subjects

	N	AS	Min	Max	Range	Std.dev.
MAGKUS	40	8,12	6,93	9,53	2,60	0,64
MAGSLA	40	7,15	5,06	8,08	3,02	0,59
MAG20Y	40	5,39	4,66	6,78	2,12	0,44
CHALF	40	7,66	6,97	8,50	1,53	0,45
KN	40	7,29	6,57	8,09	1,52	0,45
MAGKV4	40	15,16	13,37	17,04	3,67	1,01

Table 4. Descriptive statistics of variables for assessment of motor abilities at team leaders and other players in the team

	TEAM LEADERS						OTHER PLAYERS					
	N	AS	Min	Max	Range	Std.dev.	N	AS	Min	Max	Range	Std.dev.
MAGKUS	21	7,99	7,19	9,01	1,82	0,60	19	8,27	6,93	9,53	2,60	0,66
MAGSLA	21	7,16	5,26	7,97	2,71	0,55	19	7,13	5,06	8,08	3,02	0,64
MAG20Y	21	5,30	4,83	6,77	1,94	0,42	19	5,49	4,66	6,78	2,12	0,45
CHALF	21	7,57	6,97	8,49	1,52	0,45	19	7,75	7,12	8,50	1,38	0,44
KN	21	7,33	6,75	8,09	1,35	0,48	19	7,25	6,57	7,92	1,35	0,42
MAGKV4	21	15,09	13,37	17,04	3,67	1,12	19	15,24	13,57	16,89	3,32	0,89

Inspection of descriptive parameters (Tables 3 and 4) shows that players who are carriers of the game in their teams generally achieve better results than the other players (*MAGKUS* - an average of 0.28 seconds faster, *MAG20Y* - an average of 0.19 seconds faster, *CHALF* - average 0.18 seconds faster, *MAGKV4* - an average of 0.15 seconds faster). Also a smaller dispersion of results in team leaders than other players is evident, which indicates that this group of players is more homogeneous in their results.

Tables 5 and 6 display the contributions of predictor set of variables to criteria for assessing manifestations of specific agility in handball at general and partial level.

Table 5. Multivariate regression parameters of influence/contribution of the predictor variables on the performance criteria for all three teams, team leaders and other players

CRITERION	TEAM			TEAM LEADERS			OTHER PLAYERS		
	CHALF2	KN2	MAGKV4	CHALF2	KN2	MAGKV4	CHALF2	KN2	MAGKV4
MULTIPLE R	0,58	0,50	0,81	0,74	0,69	0,89	0,52	0,62	0,77
MULTIPLE R <sup>2</sup>	0,34	0,25	0,66	0,55	0,47	0,80	0,27	0,39	0,59
F(3,36 M; 3,17N; 3,15 O)	6,41	4,16	24,32	6,99	5,21	22,73	1,88	3,15	3,15
P	<b>&lt;0,001</b>	<b>&lt;0,01</b>	<b>&lt;0,000</b>	<b>&lt;0,002</b>	<b>&lt;0,01</b>	<b>&lt;0,000</b>	<b>&lt;0,17</b>	<b>&lt;0,05</b>	<b>&lt;0,01</b>
std. err. of estimate	0,37	0,39	0,60	0,32	0,37	0,54	0,40	0,35	0,62

Table 6. Partial regression coefficients of influence/contribution for predictor variables on the criteria of success for the team, team leaders and other players

CRITERION	TEAM					
	CHALF2		KN2		MAGKV4	
	BETA	p	BETA	p	BETA	p
Intercept		0,00		0,00		0,19
MAGKUS	0,53	<b>0,02*</b>	0,47	<b>0,05*</b>	0,63	<b>0,00*</b>
MAGSLA	0,00	0,98	0,02	0,94	0,22	0,16
MAG20Y	0,18	0,27	0,10	0,58	0,14	0,23

\* statistically significant contribution

CRITERIONNN	TEAM LEADERS						OTHER PLAYERS					
	CHALF2		KN2		MAGKV4		CHALF2		KN2		MAGKV4	
	BETA	p	BETA	p	BETA	p	BETA	p	BETA	p	BETA	p
Intercept		0,68		0,85		0,69		0,00		0,01		0,08
MAGKUS	0,27	0,27	0,20	0,44	0,73	<b>0,00*</b>	0,81	<b>0,05*</b>	1,02	<b>0,01*</b>	0,45	0,13
MAGSLA	0,43	0,10	0,42	0,14	0,20	0,25	-0,44	0,28	-0,59	0,11	0,34	0,25
MAG20Y	0,50	<b>0,02*</b>	0,52	<b>0,03*</b>	0,18	0,20	-0,11	0,70	-0,29	0,22	0,15	0,43

\* statistically significant contribution

Differences between individual teams (Medveščak, Zagreb, Moslavina) in the area of basic and specific motor abilities are shown in the table below.

Table 7. Post hoc Scheffe test of differences between teams at the individual level

	SS	df	MS	SS	df	MS		
	Effect	Effect	Effect	Error	Error	Error	F	p
MAGKUS	3,79	2	1,89	12,20	37	0,33	5,75	0,01
MAGSLA	2,18	2	1,09	11,33	37	0,31	3,56	0,04
MAG20Y	0,20	2	0,10	7,33	37	0,20	0,50	0,61
CHALF	0,27	2	0,14	7,48	37	0,20	0,68	0,51
KN	0,42	2	0,21	7,31	37	0,20	1,06	0,36
MAGKV4	10,99	2	5,50	28,79	37	0,78	7,07	0,01

Table 8. Post hoc Scheffe test of differences between teams

	MAGKUS			MAGSLA			20Y		
	Medveščak	Zagreb	Moslavina	Medveščak	Zagreb	Moslavina	Medveščak	Zagreb	Moslavina
	M=8,44	M=7,69	M=8,08	M=7,36	M=6,79	M=7,18	M=5,44	M=5,42	M=5,28
Medveščak		<b>0,01</b>	0,25		<b>0,04</b>	0,70		0,99	0,64
Zagreb	<b>0,01</b>		0,26	<b>0,04</b>		0,23	0,99		0,75
Moslavina	0,25	0,26		0,70	0,23		0,64	0,75	
	CHALF			KN2			MAGKV4		
	Medveščak	Zagreb	Moslavina	Medveščak	Zagreb	Moslavina	Medveščak	Zagreb	Moslavina
	M=7,64	M=7,77	M=7,56	M=7,25	M=7,45	M=7,19	M=15,76	M=14,50	M=14,97
Medveščak		0,74	0,90		0,54	0,93		<b>0,00</b>	0,07
Zagreb	0,74		0,52	0,54		0,38	<b>0,00</b>		0,44
Moslavina	0,90	0,52		0,93	0,38		0,07	0,44	

## Discussion and conclusions

In "teams" interconnection between predictor set of variables to the criteria for assessing specific manifestations of agility in handball (*MAGKV4*, *CHALF2*, *KN2*) is described by multiple correlation coefficients (Table 5) whose values are - 0.58 (*CHALF2*), 0.50 (*KN2*) and 0.81 (*MAGKV4*) tested using the F-distribution for degrees of freedom  $df_1=3$  i  $df_2=36$  is statistically significant on levels - $p(CHALF2) = 0.001$ ,  $p(KN2) = 0.01$  and  $p(MAGKV4) = 0.000$ . Common variance of the predictor and criterion variables for the whole team was slightly lower *CHALF2* (34%) and *KN2* (25%) compared to *MAGKV4* (66%). Unexplained parts of the variance of criterion variables can be attributed to the influence of factors that are not quantitatively defined, which relate to different contributions and impact of singlefactor and multifactor motor abilities - coordination, explosive power, balance, etc.

A higher correlation was found between the predictor set of variables with criteria for assessing specific agility at team leaders, which represent best players of each team, than at the whole team. Multiple correlation coefficients amount to -0.74 (*CHALF2*), 0.69 (*KN2*), 0.89 (*MAGKV4*) tested using the F-distribution for degrees of freedom  $df_1 = 3$ ,  $DF_2 = 17$  proved to be statistically significant at levels -  $p(CHALF2) = 0.002$ ,  $p(KN2) = 0.01$  and  $p(MAGKV4) = 0.000$ . A greater common variance of the predictor and criterion variables is apparent *CHALF2* (55%), *KN2* (47%) and *MAGKV4* (80%). Unexplained variability can be attributed to the influence of other motor abilities.

With other players who make the team, ie. those who are not team leaders a slightly less amount of transfer basic motor abilities to the manifestations of specific motor abilities was found. Amount of multiple correlation coefficients are - 0.52 (*CHALF2*), 0.62 (*KN2*) and 0.77 (*MAGKV4*) tested using the F-distribution for degrees of freedom  $df_1 = 3$  and  $DF_2 = 15$  is proved to be statistically significant at levels - $p(KN2)=0.05$  and  $p(MAGKV4)=0.01$  while at the imitation of center half movement was not determined any statistically significant correlation - $p(CHALF2)=0.17$ .

After examining the results of partial regression analysis, we can talk about the various contributions of basic motor abilities to specific motor abilities in relation to time spent in the game. The greatest contribution to the specific agility of back center movement and pivot with team leaders has frontal agility of movement, while at other players largest contribution gives lateral agility. For the whole team the largest contribution to the transfer of basic motor abilities to specific motor abilities is lateral agility. Similar results were obtained in a previous pilot study (Rodic, Gruić, Ohnjec, 2011) where largest contribution to the agility at male players had frontal agility, while at girls it was lateral agility.

In trying to avoid error in statistical reasoning in interpreting the contribution of basic manifestation of agility to various manifestations of specific agility results were analyzed at multiple levels (team, team leaders and other players). At the level between teams statistically significant differences in some manifestations of agility appear. Analysis of variance showed that there are statistically significant differences in *MAGKUS* ( $p = 0.01$ ), *MAGSLA* ( $p = 0.03$ ) and *MAGKV4* ( $p = 0.01$ ). Mainly second (HC Zagreb CO) and third ranked team (HC Medveščak) from Croatian championship differ, which arise the most difference between the best three teams, but as no runner-up, or third place teams do not differ significantly from the best team (HC Moslavina), no team was isolated, the team leaders were observed as a group - the best players, because the variability is contained in all three teams.

Transfer of basic agility to specific agility manifests itself differently on team leaders, and various on other players or teams as a whole. The reason is that team leaders due to more minutes on the game and their age, presuming that they are mostly older players (every two years pair of classes combine), had a lot more opportunities to convert basic agility to specific manifestations of agility. Team leaders have spent much more time in situational conditions and have acquire more experience, they have had much more moments where they could convert basic agility into various manifestations of specific agility.

## References

1. Gruić, I., Vuleta, D., Ohnjec, K. (2010). Analiza promjena u različitim manifestacijama eksplozivne snage, skočnosti, agilnosti i brzine rukometaša. U Igor Jukić i sur. (ur.) Zbornik radova 8. godišnje međunarodne konferencije Kondicijska priprema sportaša "Trening brzine, agilnosti i eksplozivnosti". Zagreb: Kineziološki fakultet Sveučilišta u Zagrebu, Udruga kondicijskih trenera. str. 420-424.
2. Jukić, I., Nakić, J., Milanović, L., Marković, G. (2003.), Metodika treninga agilnosti. U D. Milanović i I. Jukić (ur.), Zbornik radova Međunarodno znanstveno-stručnog skupa "Kondicijska priprema sportaša" (str. 271-277). Zagreb: Kineziološki fakultet.
3. Pearson, A. (2001.), Speed, agility and quickness for soccer. London: A&C Black.
4. Rodić, S., Gruić, I., Ohnjec, K., (2011.), Relacije između bazične i specifičnih manifestacija agilnosti u rukometu, Federation Internationale d'Education Physique 2011.
5. Rodić, S., Gruić, I., Ohnjec, K., (2011.), Validacija mjernog instrumenta za procjenu agilnosti rukometaša kadeta, Zbornik radova 20. ljetne škole kineziologa, Poreč, 21.-25.lipanj 2011.
6. Marković, G. (2010). Testiranje i treniranje brzine i agilnosti: drugačija perspektiva. U Igor Jukić i sur. (ur.) Zbornik radova 8. godišnje međunarodne konferencije Kondicijska priprema sportaša "Trening brzine, agilnosti i eksplozivnosti". Zagreb: Kineziološki fakultet Sveučilišta u Zagrebu, Udruga kondicijskih trenera. str. 19-26.
7. Metikoš, D., Marković, G., Prot, F., Jukić, I. (2003). Latentna struktura testova agilnosti [Latent structure of agility obtained by a battery tests]. *Kineziologija* 35(1), 14-29.
8. Rogulj, N., Kordi, Z. (2004). Agilnost. U Zbornik radova XXVIII. seminara rukometnih trenera, Pula, 3.-6. siječnja 2004. Udruga trenera Hrvatskog rukometnog saveza, str.85-90.
9. Vuleta, D., Gruić, I., (2009.) Changes in physical conditioning status of male students of the first year of Faculty of Kinesiology influenced by educational process). *Acta Kinesiologica* 3, 34-37.
10. Vuleta, D., Milanović, D., Gruić, I., Jukić, I., Pašić, Z. (2006). Relations between indicators of basic motor abilities and results of goal throwing accuracy tests. U (glavni redaktor: Šestakov A. L.) redakcijski savjet "Vestnika južno-uralskoga gospodarstvenog univerziteta". Serija obrazovanie, zdravoozhanenie, fizičeskaja kuljtura, vbilusk 7, tom 2, No 3(58), pp. 93-96 (106-108), Rusija, Chelyabinsk.
11. Ziv, G. & Lidor, R. (2008). Physical characteristic, physiological attributes, and on-court performances of handball players: A review, *European Journal of Sport Science*, 9, 375-386.

## A COMPARISON OF PLAYING TACTICS IN THE ENGLISH PREMIER LEAGUE, SPAIN'S LA LIGA AND ITALY'S SERIE A

Hugo M. Sarmiento<sup>1,2</sup>, Jorge M. Campaniço<sup>1</sup>, Maria T. Anguera<sup>2</sup> and José C. Leitão<sup>1</sup>

<sup>1</sup>University of Trás-os-Montes e Alto Douro, Vila Real, Portugal

<sup>2</sup>University of Barcelona, Barcelona, Spain

### Abstract

The purpose of this study was to analyze and to characterize the different styles of play (counterattack, fast attack and positional attack) by accessing the interaction contexts in three teams from different European Leagues. The sample consisted of 32 football games of domestic competitions that were analyzed by systematic observation. The type of attack most often used by the Manchester United team is the counterattack, while the teams of Inter Milano and FC Barcelona used more often the positional attack. Interesting results were found related to the behaviors, the zones of the field and the interaction contexts in which the recovery of ball possession is performed, the last pass, and the finalization in the different teams, which allows us to better understand the differences between them.

**Key words:** *Offensive play, interactions, match-performance analysis*

### Introduction

The expression "playing style" is now commonly used by the fans, coaches and in academic settings. However, this is a complex concept that is influenced by many factors, like the strategy or philosophy of the playing style (i.e., a plan of how a team should play), the tradition, identity and history of the club, as well as the specific environment that characterizes the game (e.g., quality of opposition, match status).

While it has been recognized that the three major football leagues in Europe are the English Premier League, Spain's La Liga and Italy's Serie A (due to the number of European trophies won by teams in these leagues), to date, little football research has been conducted that attempts to determine what differentiates these Leagues especially regarding the different styles of offensive play. It also appears that the studies that analyze the football game do not take into account the interaction context (the behavior of the other players) where the action is performed.

Thus, the main aim of this study was to analyze and to characterize the different styles of play (counterattack, fast attack and positional attack) by accessing the interaction context in one team from each league.

### Methods

The sample included 36 games (12 per team) from the sporting season 2009/2010 of Manchester United (MU), F.C. Internazionale Milano (IM) and FC Barcelona (BA) that won the respective Leagues in the previous sporting season (2008/2009). The design used in the present study was descriptive and was based on an observational methodology applied to the acquisition of data (Anguera et al., 2000). The matches were analyzed through systematic observation by using a specific instrument to observe the offensive process (Sarmiento et al. 2010). The study of the data reliability was calculated by the intra and inter observer agreement, and values above 0.90 for all criteria were achieved.

The following criteria were used in this study: 1 - *Type of attack* - counter-attack, fast attack and positional attack; 2 - *Start of the Offensive Process (OP)* - recovery of the ball possession by: interception (IPi); disarm (IPd); goalkeeper action (Ipg), opponents goal (Ipga); due to the rules of the game (Ipera); 3 - *End of the OP* - Shot with score goal, shot, free kick, corner kick, penalty, pass inside the penalty area, recovery of the ball by the opponent without reaching the penalty area, pass to the outside of the field, violation of the rules of the game by the observed team; 4 - *Area where the action was made* - 12 zones and four sectors were differentiated on the field (figure 1); 5 - *Interactions contexts in the center of the game (CG)*.

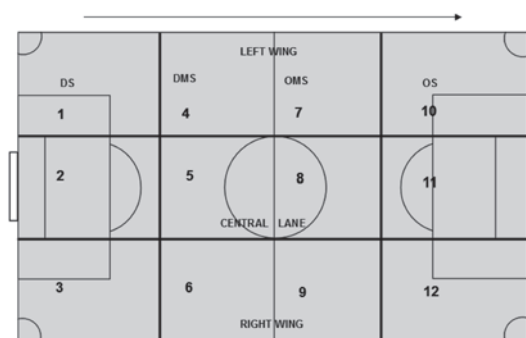

Figure 1. Field of the game

To analyze the interaction context, we used the concept of the *center of the game* (Castelo, 1992), that is defined as the zone of the field where the ball moves at a certain instant, through a context of cooperation and opposition of the influential players in the game, in the specific zone where is the player has possession of the ball. We consider 5 categories for this criteria: 1 - *Relative numeric inferiority* (Pir): the observed team has less 1 or 2 players in the CG (e.g., 1vs2, 3vs5); 2 - *Absolute numeric inferiority* (Pia): the observed team has less 3 or more players in the CG (e.g., 1vs4, 2vs5); 3 - *Absolute numeric superiority* (SPsa): the observed team has 3 or more players in the CG (e.g., 4vs1, 5vs2); 4 - *Relative numeric superiority* (SPsr): the observed team has more 1 or 2 players in the center of the game (e.g., 2vs1, 2vs0); 5 - *Equality numeric under pressure* (Pip): i) the observed team has the same number of the players in the defensive midfielder; ii) in the offensive midfielder sector, the player in possession of the ball is standing with his back to the goal with an opponent in contention and doesn't have pass lines to areas of greater offensiveness; 6 - *Equality numeric unpressured* (SPinp): the observed team has the same number of players in the offensive sector, or, when in the offensive midfielder sector, the player in possession of the ball is standing with his back to the goal with free pass lines to areas of greater offensiveness, or the player in possession of the ball is facing the goal.

Chi-square test to compare the differences between the team relatively to the styles of play and descriptive analyses for all variables was done with the statistics software SPSS.19.0.

## Results

In total, 660 attacks were analyzed. The team of BA performed 192 attacks, with a mean of 10,1 passes ( $s=12.6$ ; minimum =0, maximum =38) per possession, while the team of IM attacked 199 times, with a mean of 9.2 passes ( $s=6.5$ ; minimum =0, maximum =38), and the team of MU performed 269 attacks, with a mean of 7.4 passes ( $s=5.3$ ; minimum =0, maximum =24).

The type of attack most often used by the teams of BA and IM is the Positional Attack (38,5% and 39,2% respectively), while for the team of MU this is the least attack used (26.4%). On the other hand, the counterattack is the most often used by the MU team (46.8%), while it is the least used for the IM (27.1%), and the second most often used by the BA (33.9%). The fast attack is the second most often used by the IM (33.7) and MU (26.8%) teams, and the least used for the BA (27.6%) team. The Chi-square test ( $X^2(2)=36.8$ ;  $p=0.000$ ;  $n=245$ ) reveals that the MU team performed significantly more counterattacks than the other two teams.

With regard to the sector where the possession of the ball is recovered, the three teams have similar results for the different offensive styles of play (Table 1), however, when counterattacks were performed, the teams present higher percentages of ball possession recovery in the DMS, when compared with the other styles. In general, the zones more often used to recover the ball, are zones 4 and 6 (lateral midfielder zones), for all the teams and styles of play. On the other hand, there is a clear predominance of the balls recovered in zone 5 (central) when the teams performed counterattacks, when compared with the other styles of play.

In general, the interception of the ball is the behavior most often used to recover the ball in all teams and styles of play, the only exception refers to the counterattacks of the IM that starts by more balls recovered by interruptions due to the rules of the game. This team also used more often the “disarm” to recover the ball in the fast attack and positional attack when compared with the other two teams.

The recovery of ball possession generally occurs in interaction contexts of relative numeric superiority (SPsr) that means the observed team has one or two more players in the center of the game.

Table 1. Sector of the field, behavior and interaction context in the recovery of ball possession (percentage)

	Team	Sector				Behavior				Interaction context				
		DS	DMS	OMS	OS	lpd	lpera	lpgr	lpi	Pir	Pip	SPinp	Spsr	Spsa
Counter-attack	BA	9.2	90.8	--	--	20.0	27.7	3.1	49.2	15.4	7.7	20.0	56.9	--
	IM	16.7	83.3	--	--	12.8	41.0	7.7	38.5	5.6	14.8	11.1	68.5	--
	MU	16.7	83.3	--	--	18.3	28.2	8.5	45.0	11.9	8.7	15.1	64.3	--
Fast attack	BA	22.7	50.9	26.4	--	18.9	22.6	5.7	52.8	7.5	7.5	11.3	73.6	--
	IM	20.9	44.8	29.8	4.5	23.9	26.9	3.0	46.2	4.5	13.4	7.5	73.1	1.5
	MU	18.1	51.4	30.5	--	12.5	25.0	2.8	59.7	11.1	16.7	8.3	63.9	--
Positional attack	BA	21.6	50.0	27.1	1.4	12.2	35.1	9.5	43.2	9.5	13.5	13.5	63.5	--
	IM	21.8	51.3	25.6	1.3	20.4	16.7	5.6	57.3	6.4	9.0	5.1	79.5	--
	MU	26.7	50.8	21.1	1.4	16.7	13.5	3.2	66.6	5.6	11.3	5.6	77.5	--

Relatively to the counterattacks and fast attacks, in terms of orientation, the zones more often used for the last pass are: the two left-hand (7,10) for the BA team (33.3% and 47%, respectively); the two central (8,11) for the IM (27% and 32.9%, respectively); and the two right-hand (9,12) for the MU (33,4% and 33,2%, respectively). The farthest zones, namely, the zones of the defensive midfielder (DM) were used less frequently; however, the IM presents a higher percentage for the last pass performed in the DM, when compared with the other teams, for the counterattack (Table 2).

Regarding the zone where the behavior that characterizes the end of the counterattacks and fast attacks is performed, the more often used are: the two left-hand for the BA team (42.7% and 39,7%, respectively) and the two central for the MU (47.6% and 41.7%, respectively); and the two right-hand for the IM (46,2% and 38.8%, respectively).

In the positional attack, the zones more often used in the end of the offensive process are the central zones for all the teams: BA (44.6%); IM (38.4%) and BA (38.1%). The zones more often used to perform the last pass are: the two left-hand for the MU (43.7%); the two central for the IM (35.8%); and the two right-hand for the BA (36,5%).

The most part of the actions happen in a context of relative numeric inferiority (less one or two players) in the center of the game, or in a interaction context of unpressured numeric equality.

Table 2. Zones of the field and interaction context for the actions of "Last Pass" and "End of the Offensive Process (OP)" (percentage)

	Team	Zones of the field							Interaction Contexts					
		Z7	Z8	Z9	Z10	Z11	Z12	DM	Pia	Pir	Pip	SPinp	Spsr	SPsa
<b>Counterattack</b>														
End of the OP	BA	--	4.9	--	42.7	16.4	34.4	1.6	--	68.9	1.6	26.2	3.3	--
	IM	3.8	7.7	11.5	13.5	26.9	34.7	1.9	--	63.4	--	30.8	5.8	--
	MU	3.3	10.8	0.8	20.0	36.8	27.5	0,8	--	70.0	--	26.7	3.3	--
Last Pass	BA	25.1	19.7	23.0	8.2	3.3	6.6	13.1	--	49.2	4.9	26.2	19.7	--
	IM	17.3	21.2	11.5	3.8	5.8	3.8	36.6	--	42.3	11.5	25.0	21.2	--
	MU	16.8	20.0	19.2	6.7	5.0	14.2	18.3	--	40.8	5.0	31.7	21.7	0.8
<b>Fast Attack</b>														
End of the OP	BA	5.7	3.8	1.9	34.0	30.2	24.5	--	--	86.8	--	--	13.2	--
	IM	3.0	9.0	4.5	20.9	26.8	34.3	1.5	--	67.1	--	29.8	3.0	--
	MU	6.9	8.3	4.2	25.0	33.4	22.2	--	--	66.6	--	27.8	4.2	1.4
Last Pass	BA	20.8	17.0	18.9	26.2	5.7	5.7	5.7	--	64.1	--	18.9	15.1	1.9
	IM	11.9	25.4	20.9	10.4	7.5	10.4	13.5	1.5	49.3	3.0	31.3	14.9	--
	MU	19.4	23.6	9.6	5.6	5.6	23.6	12.6	--	36.1	5.6	40.2	16.7	1.4
<b>Positional Attack</b>														
End of the OP	BA	2.7	12.2	5.4	18.9	32.4	28.4	--	--	78.4	--	20.3	1.4	--
	IM	6.4	12.8	10.3	23.1	25.6	21.8	--	--	74.4	1.3	15.4	9.0	--
	MU	7.0	4.2	2.8	28.2	33.9	23.9	--	--	71.8	--	26.8	1.4	--
Last Pass	BA	17.6	24.2	18.9	10.8	2.7	17.6	8.2	--	54.1	--	32.4	13.5	--
	IM	20.5	32.0	14.1	6.4	3.8	16.7	6.5	--	43.6	1.3	35.9	19.2	--
	MU	28.2	14.1	15.5	15.5	2.8	16.9	7.0	--	36.6	1.4	47.9	14.1	--

Regarding the behaviors performed in the end of the offensive process, we can conclude that the most frequent behaviors are the shot and the pass inside the penalty area (Table 3). These results are related to the methodology used in this study, since we observed only the offensive sequences that ended in the offensive sector.

Concerning the goals scored, the BA and the IM team scored more goals ( $n=12$  and  $n=7$ , respectively) through the positional attacks when compared with the goals scored by counterattack ( $n=6$  and  $n=5$ , respectively) or by the fast attack ( $n=6$  and  $n=5$ , respectively). In turn, the MU team scored more goals through the counterattacks ( $n=12$ ), when comparing with the fast attack ( $n=5$ ) and the positional attack ( $n=3$ ).

The more frequent behaviors in the end of the offensive process are the shot (against the opponent, goalkeeper defender, etc.) and the pass to the inside of the penalty area in all teams and in all styles of play.

Table 3. Behavior performed at the “End of the Offensive Process” (percentage)

	Counterattack			Fast Attack			Positional Attack		
	BA	MU	IM	BA	MU	IM	BA	MU	IM
Shot with score goal	9.8	10.0	9.6	11.3	6.9	7.5	16.2	4.2	9.0
Shot	26.3	33.3	30.9	26.5	30.6	41.7	37.8	32.4	26.9
Free kick	--	3.3	1.9	--	--	--	--	2.8	2.6
Corner kick	16.4	10.0	1.9	7.5	11.1	6.0	8.1	14.1	11.5
Penalty	1.6	1.7	1.9	--	--	--	--	--	--
Pass to the inside of the penalty area	31.1	24.2	25.0	39.6	25.0	19.4	20.3	25.4	32.1
Recovery of the ball by the opponent	6.6	12.5	17.3	7.5	18.1	16.4	6.8	1.4	9.0
Pass to the outside of the field	6.6	3.3	9.6	1.9	6.9	4.5	5.4	5.6	5.1
Violation of the rules	1.6	1.7	1.9	5.7	1.4	4.5	5.4	--	3.8

## Discussion and conclusion

The analysis of the results showed that the teams of IM and BA tended to more often adopt the positional attack to perform their offensive action, while the MU played more often in counterattack. This is in accordance with Hughes and Franks (2005) when they claim that the tactics of “direct play” still permeate the manner in which most clubs play in Britain. However, determining which style of play is more effective has long been disputed in the soccer performance analysts including match-performance researchers.

The zones more often used to recover the ball possession are those that belong to the midfielder defensive sector, like in the previous studies (e.g., Garganta, 1997). However, when the teams performed counterattacks, they tended to recover more balls in zone 5 (central) of the field, when compared to other styles of play. Some studies have investigated the link between the zones of recovery of the ball possession and the number of passes per sequence (Hughes & Franks, 2005), and the effectiveness of the offensive sequences, although, inconsistencies have been found. In our opinion, this may be due to the different methodologies employed.

The dynamic behaviors of ball recovery (interception and disarm) are the more often used by the teams in the different styles of play. This type of behavior allows the offensive game to continue, taking time away from the defensive organization of the opponent teams. More than the two other teams, the IM starts their counterattacks by situations originated from the game rules (e.g., fouls, off-side), and starts the offensive sequence more often from the defensive midfield, through quick transitions from the defensive midfielder zones to the offensive zones, trying to take advantage of the disorganization of the opponent.

In all the offensive styles, the IM is the only team that performed more frequently the last pass and the end action in the same zones (central zones). Curiously, the teams of BA e MU present regular tendencies in the zones more often used to perform the last pass (left hand zones and right hand zones, respectively) and the last action (central zones) in the positional attack and in the fast attack, but present different tendencies in relation to the counterattack. This result may be an indicator of strategic choice by teams when performing counterattacks.

An interesting result is that related to the goals scored by the teams through the different offensive methods of play. The MU team scored more goals through the counterattack, and the IM and BA scored more goals through the positional attack. So, the discussion about which style of play is more effective continues. However, we believe that the important thing is to know the skills of the players who form the team, and adapt the style of play according to their strengths.

In relation to the interaction contexts, the situations of relative superiority (SPsr) and inferiority (Pir), are the more frequent, which means the teams constantly seek to create situations of numerical superiority in relation to the opponent, both in defense and in attack. In turn, situations of absolute superiority and inferiority rarely happen, which seems to



suggest that there is always a balance between the number of players in the center of the game. Although, when a team progresses in the field for areas closer to the goal, the interaction contexts are less favorable (relative numeric inferiority), but the relationship between the number of players of the two teams is balanced (generally, the same number, or, one or two less). As such, the teams tended to attack with safety, i.e., attack with the sufficient number of players, but maintained the necessary footballers ready to defend.

Although some studies tended to prove which is the most efficient style of play, we think that the important thing is not the duration of the offensive sequences, the number of passes, the weight of the passes, or the velocity of the ball, but the obstacles that a team finds whilst attacking in its way. Further, we can only understand this aspect, if we analyze the interactions between the players and their typical behaviors. With the latter in mind, this study is the first step of a series of analysis, which will be carried out with the techniques of sequential analysis and t-pattern detection.

## References

1. Anguera, T., Villaseñor, Á., Lopes, L., & Mendo, H. (2000). La metodología observacional en el deporte: conceptos básicos. *Lecturas: Educación Física y Deportes*, (24). Retrieved from <http://www.efdeportes.com/efd24b/obs.htm>
2. Castelo, J. (1992). *Conceptualização de um modelo técnico/tactico do jogo de futebol*. (Unpublished doctoral dissertation). Technical University of Lisbon, Lisbon.
3. Garganta, J. (1997). *Modelação táctica do jogo de Futebol*. (Unpublished doctoral dissertation). University of Porto, Porto.
4. Hughes, M. & Franks, I. (2005). Possession length and goal-scoring in soccer. *Journal of Sport Sciences*, 23, 509-514.
5. Sarmiento, H., Anguera, T., Campaniço, J. & Leitão, J. (2010). Development and Validation of a Notational System to Study the Offensive Process in Football. *Medicina (Kaunas)*, 46(6), 401-407.

## Acknowledgements

We gratefully acknowledge the support of the Portuguese Foundation for the Science and Technology (SFRH/BD/45736/2008).

## KITESURFING FREESTYLE PERFORMANCE ANALYSIS

Gabriele Semprini<sup>1,2</sup> and Gianluca Caimmi<sup>2</sup>

<sup>1</sup>*Dept. of Histology, Embryology and Applied Biology, University of Bologna, Italy*

<sup>2</sup>*Faculty of Exercise and Sport Science, University of Bologna, Italy*

### Abstract

Aim of this study was to evaluate the athletes' heart rate (HR) profile in competitive kitesurf freestyle.

Two top level athletes were involved in the study, during the Italian National Championship 2010. HR profiles and synchronized video data were collected (24 complete heats, 66.7% of the whole National Championship; 144 minutes and 148 maneuvers analyzed).

High values of mean HR (94.0 of HR<sub>max</sub>) were observed during the competitions and peaks closed to HR<sub>max</sub> (95.1-90.2% of HR<sub>max</sub>) just after each jump. Aerial maneuvers, divided according to the difficulty, did not point out significant HR differences after the jumps.

The repetition of high intensity efforts, spaced by active pauses with a moderate to high intensity level, characterizes freestyle kitesurfing. The difficulty of aerial maneuvers increases throughout the course of the competition, but it is not related with the HR profiles.

**Key words:** kiteboarding, board sports, heart rate

### Introduction

Kitesurfing or kiteboarding, recently appeared among water sports, in few years has become a popular recreational and competitive sport. As windsurf, snowboard, wakeboard and surf, kitesurfing has to be considered a "board sport". The particular aspect that makes it unique is the use of the kite traction as propulsion.

Five disciplines are currently represented inside the International Kitesurf Association (IKA): wave riding, speed, course racing, kite cross and freestyle. Freestyle was the first one to be established and still today is the most well known event in the international survey, catalyzing in addition the majority of the interests of manufacturers.

Kitesurf freestyle is a technical-compository discipline and the performances of two athletes racing at the same time in a single elimination heat, composed by jumps and aerial evolutions, are evaluated by a jury.

Despite the diffusion and growing interest in it, there is lacking scientific literature about this discipline. Apart from research concerning injuries (Nickel et al., 2004) few studies have investigated this sport, particularly the performance aspects and the effort intensity of athletes related to it.

To date, only one study investigated the relationship between physiological indices and kitesurfing. Vercruyssen et al. (2008) evaluated the physiological demands of kitesurfing in the crossing trial, characterized by continuous sailing for more than 30 min. Ten elite subjects performed a running test, in order to establish the individual Heart Rate (HR)-Oxygen uptake (VO<sub>2</sub>) relationship, and two days later an on-water crossing trial for 30 min during a light crosswind (12–15 knots).

During the on-water trial the mean HR was reported to be  $80.6 \pm 7.5\%$  of the maximal rather the VO<sub>2</sub> was  $69.8 \pm 11.7\%$  of VO<sub>2</sub> max, and those authors suggested that the energy demand, in that trial during a low wind condition, is mainly sustained by aerobic metabolism.

In contrast to the crossing discipline, mostly consisting in isometric efforts both in the lower- and upper-limb muscles, freestyle techniques require not only isometric, but also dynamic and often fast muscle contractions. Furthermore, while pumping is usually practiced in windsurfing (Vogiatzis et al., 2002), and from 5 to 16 knots the performances are affected by it (Chamari et al., 2003), in freestyle kitesurfing this technique is used in a less vigorous way and anyway it is less practiced.

Then, despite pumping is less utilized in freestyle kitesurfing than in windsurfing, and competitions last few minutes, we can argue that freestyle kitesurfing trials, compared to racing, require an additional energy cost. Taking into account all these elements, as well as emotional factors linked to them, in this study it was hypothesized that athletes' HR profiles, during a freestyle kitesurfing competition, show different and higher values in comparison to a crossing competition.

Therefore the aim of this study was to evaluate the athletes' HR profile in competitive kitesurf freestyle.

## Methods

Two kitesurfers competing in the Kitesurf Freestyle National Championships 2009 and 2010 were recruited in this study and provided written informed consent to participate. Both the athletes, ranked in the top 5 kitesurfers in Italy, had more than 7 years of practice and participated to National level competitions during the last years (from 2 to 6 years). One of them participated also in some International competitions.

The subjects, aged 20 (athlete 1) and 19 (athlete 2) years, presented height and body mass of 177 and 165 cm, and 69.5-57.5 kg, respectively. The resting HR were 58 bpm (Athlete 1) and 55 (Athlete 2).

Both the athletes were acquainted with the use of heart monitors and they affirmed to not feel any impediment caused by that equipment during the competitions.

Data were collected during (i) one competition of the Kitesurf Freestyle National Championship, Riccione 2009, (ii) two competitions of the same Championship, Garda Lake and Riccione 2010 and (iii) one competition out of the National Circuit called "Champion's cup" at Garda Lake, with the participation of some international level athletes.

Each of the four events included 16 athletes competing in a single elimination heat until the final. The heats, according with the IKA rules, lasted for 6 minutes. The total number of analyzed heats was 24.

Concerning weather and water condition, in the competition performed at Garda Lake (ii) there was a quite constant wind with a speed of 16 - 20 knots (30-37 km/h), and the water conditions didn't affect the performance of the athletes (degree two in the Douglas sea scale), while the (iii) competition in Riccione (2010) was characterized by many gusts (14-25 knots/26-46 km/h) and waves (degree four in the Douglas sea scale).

HR were assessed using Polar HR monitors S610 and S810 with thoracic belt sensors, wore under a 3-4 mm thick neoprene suit in order to let the belts in position even during the jumps and, eventually, crashes.

The detection frequency was 5 sec. The HR data were analyzed using the Polar Pro Trainer 5 software and Microsoft Excel 2007. The percentage of the individual HRmax (considered as the maximum value recorded in all the matches for each athlete) was used in order to quantify the effort intensity during the competition.

In order to synchronize the HR profiles with the techniques performed by the athletes a video recording of the competitions was executed (Sony Handycam DCR-HC44 digital movie camera with a recording frequency of 25fps and resolution of 690.000 pixels), starting the devices at the same time.

The video analysis was performed with the Windows Movie Maker 6.0 and the Fast Movie Processor 1.44 software.

Descriptive statistical analysis about HR data were reported. In addition, using a qualitative analysis of the maneuvers difficulty, the relation between the difficulty of the maneuvers and HR (peaks) were carried out, in order to collect an indicator of physiological performance. According to the IKA rules, maneuvers were classified in two categories: on-average/easy and difficult. Then HR peaks after the jumps were considered, except the first and the last two for each heat, avoiding to collect data in the initial and final phases of the match.

## Results

Table 1 shows the individual data concerning the minimum, maximum and mean HR during the competition for the two subjects. Values are presented as average minimum, maximum, mean value and standard deviation. Athlete 1 presents all the values higher than Athlete 2. Subject 2 shows mean values lower but higher SD and a range from 148 to 182 bpm.

Table 1. Minimum, maximum and mean HR during the competition for the two subjects

	HR (bpm – SD)		
	min	max	mean
<b>Athlete 1</b>	160 (7.2)	199 (3.3)	187 (4.1)
<b>Athlete 2</b>	148 (9.4)	182 (3.7)	171 (5.1)

The mean HR were 94.0% of the maximal (athlete 1 and 2).

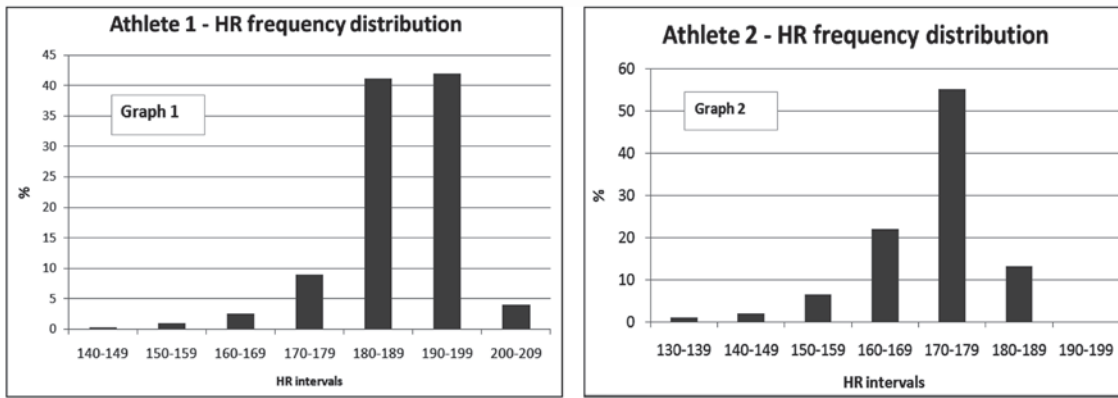

Graph 1 and 2. HR frequency distribution of the athletes collected in the competitions.

Graphs 1-2 show the HR frequency distribution of the athletes collected in the competitions, highlighting the differences between the two subjects. Subject 2 showed lower mean values, but higher SD and a range from 148 to 182 bpm. Frequency distribution of HR, with class intervals of ten beats, are presented. Athlete 1 spent 83% of the race time between 180 and 200 bpm; athlete 2, on the contrary, presented a modal class between 170 and 180 bpm, spending 55% of the time at that intensity. Furthermore frequency distributions presented an asymmetry towards the lower values.

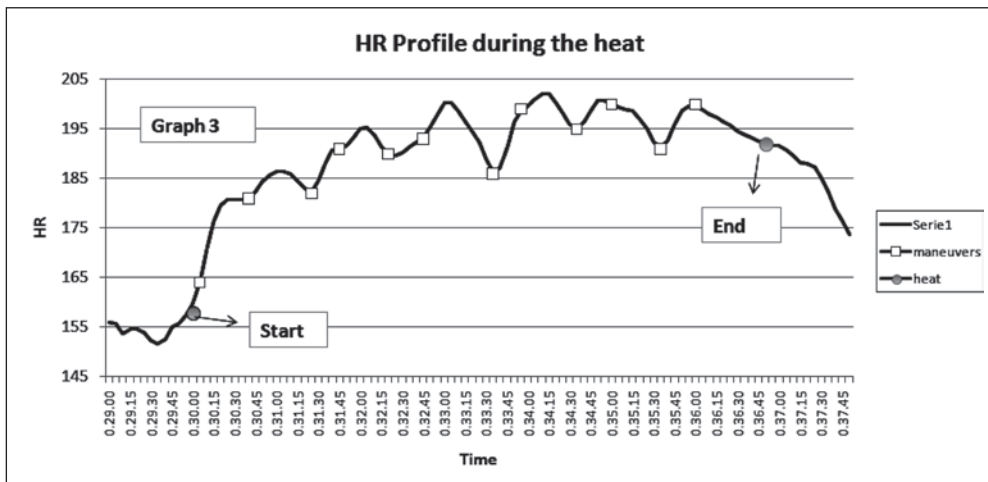

Graph 3. HR profile recorded in athlete 1.

Graph 3 shows a representative HR profile, recorded in athlete 1. HR increased in the first part of the race, after the start, and HR peaks were subsequent to the jumps (indicated with squares). After the first two minutes HR were high, reaching values between 185 and 200 bpm. The start and the end of the competition are indicated.

Table 2. HR peaks, registered after the aerial maneuvers executed by the athletes, and analyzed in the central part of the 24 heats collected

		HR (peaks) – maneuvers difficulty	
		on aver/easy	difficult
Athlete 1	bpm- SD	194 (4.3)	194 (3.6)
	Num	10	15
Athlete 2	bpm- SD	174 (8.0)	177 (5.2)
	Num	13	6

Table 2 shows the data concerning HR peaks, registered after the aerial maneuvers executed by the athletes, and analyzed in the central part of the 24 heats collected. Both the athletes reached peaks closed to  $HR_{max}$  (93-100% of  $HR_{max}$ ) and despite the differences in the difficulty of the maneuvers, HR differences between on-avg/easy and difficult techniques did not result significant (Test t:  $p>0.05$ ). Athlete 1, anyway, showed HR peaks higher than his colleague (table 1 and graphs 1-2).

## Discussion and conclusions

The aim of this study was to analyze the athletes' HR profile in competitive kitesurfing freestyle. Previous studies in sailing, including Laser sailing, windsurfing, and kitesurfing during a crosswind trials in low-wind conditions (12–15 knots), as reported from Verduyssen et al. (2008), showed mean HR ranging from 132 to 167 bpm in athletes with similar aerobic fitness. Despite the difficulty of comparing studies with different experimental designs, sailing techniques and wind or sea conditions, this study confirm the hypothesis that freestyle trials, compared to crossing, requires an additional energy cost.

The HR profiles of the athletes involved in this study, in fact, showed higher mean values compared to the mentioned previous results. On the contrary minimum values are often similar to the mean ones reported in literature in the other cited sailing sports.

The asymmetric tails observed in HR frequency distribution graphs, oriented to the lower values, can be explained with the starting phases of the match races, that gradually induce increased HR values, until the typical standard of the competition is reached (Graph 3).

In comparison to the cited research on kitesurf (Verduyssen et al., 2008), this study analyze the athletes' performance directly during official competitions, at the moment of maximum engagement. This consideration, linked to the execution of high difficult and acrobatic techniques, with a certain injuries risk, can probably explain the higher HR values shown by the athletes, and the higher stress and psychological involvement, with respect to the crossing trials.

The comparison of aerial maneuvers requiring different technical difficulties, however, did not point out significant HR differences after the jumps. Therefore it can be supposed that the physiological demand in freestyle kitesurf is not affected by the difficulty of the performed techniques.

## References

1. Castagna, O., Brisswalter, J., Assessment of energy demand in laser sailing. *Eur J Appl Physiol* 2007; 99(2): 95-101
2. Chamari, K., Moussa-Chamari, I., Galy, O., Chaouachi, M., Koubaa, D., Hassen, C.B. et al., Correlation between heart rate and performance during Olympic windsurfing competition. *Eur J Appl Physiol* 2003; 89: 387-392.
3. Nickel, C., Zernial, O., Musahl, V., Hansen, U., Zantop, T., Petersen, W. A prospective study of kitesurfing injuries. *Am J Sports Med* 2004; 32: 921-927.
4. Verduyssen, F., Blin, N., L'Huillier, D., Brisswalter, J. Assessment of physiological demand in Kitesurfing. *European Journal of Appl Physiol* 2008; 105(1): p. 103-109.
5. Vogiatzis, I., De Vito, G., Rodio, A., Madaffari, A., Marchetti, M. The physiological demands of sail pumping in Olympic level windsurfers. *Eur J Appl Physiol* 2002; 86: 450-454.

## EVALUATION OF IMPORTANCE OF DIFFERENT ELEMENTS IN PREPARATION, COMPETITION AND TRANSITION PERIOD AMONG TOP LEVEL ATHLETES, TOP LEVEL COACHES AND COACHES FROM AVERAGE POPULATION IN SHOOTING SPORT

**Hrvoje Šašek<sup>1</sup>, Tamara Glad<sup>2</sup> and Boris Balent<sup>3</sup>**

*Croatian Olympic Academy*

<sup>1</sup>*Croatian Shooting Federation, Croatia*

<sup>2</sup>*Figure Skating Club Elite, Croatia*

<sup>3</sup>*Elementary School Davorin Trstenjak, Croatia*

### Abstract

The aim of this research was to evaluate importance of different elements in preparation, competition and transition period among top level athletes, top level coaches and coaches from average population in shooting sport.

Top level shooters from 30 countries (5 continents) answered questionnaire during the 49<sup>th</sup> ISSF World Shooting Championships (Zagreb, Croatia, 2006) and all of them were national team members at that time. Top level coaches from 21 countries (5 continents) answered questionnaire during the the 49<sup>th</sup> ISSF World Shooting Championships (Zagreb, Croatia, 2006), ISSF Academy 'B' Coaches Course (Kuortane, Finland, 2006) and IOC Project for National Team Development (Kuortane, Finland, 2010). Coaches from average population from 3 countries answered questionnaire during the 1st International seminar for shooting coaches (Zagreb, Croatia, 2009).

Variables on the positive pole of the first discriminant function (K1) are defined with the tactical element in competition period (CPta) and physical element in transition period (TPf). Variables on the negative pole of the first discriminant function (K1) are defined with physical element in competition period (CPf), tactical element in preparation period (PPta) and technical element in competition period (CPte).

Variables on the positive pole of the second discriminant function (K2) are defined with the tactical element in competition period (CPta), mental element in transition period (TPme) and physical element in preparation period (PPf). Variables on the negative pole of the second discriminant function (K2) are defined with mental element in competition period (CPme) and tactical element in preparation period (TPta).

**Key words:** *shooting sport, top level athletes, top level coaches, evaluation*

### Introduction

Training program is composed of preparation, competition and transition period (Blumenstein et al., 2005; Bompa, 1999). Each period includes technical, physical, mental and tactical elements (e.g. Bompa, 2006; Milanović, 2009; Issurin, 2008 & 2009). All four elements are linked and influence each other (Blumenstein, 2010), and should be carefully planned and taken into consideration in different parts of season. It is very important for athletes and coaches to carefully plan athletes' preparation in order to achieve their peak performances and top results at the most important competitions of the season.

In the preparation period of the season physical and technical trainings prevails. Emphasis in the competition period should be on tactical and mental preparation for optimization of overall performance at the target competition. The competition period is followed by the transition period in which athletes are recovered for beginning of the new cycle. (Bompa, 2006; Milanović, 2009; Issurin, 2008 & 2009)

The aim of this research was to evaluate importance of different elements in preparation, competition and transition period among top level athletes, top level coaches and coaches from average population in shooting sport.

### Methods

The sample included 112 participants (57 top level shooters, 26 top level coaches and 29 coaches from average population). They completed questionnaires with questions that covered more topics from different fields important for preparation of shooters and achieving of high level performances and top results. Shooters completed questionnaire for shooters and coaches completed questionnaire for coaches.

For this research we analysed 16 questions concerning participants' evaluation of importance of particular elements (technical, physical, mental and tactical) in different parts of season (preparation, competition and transition) on scale ranging from 1 to 10 (1 = low, 10 = high).

The participants answered questionnaires in different occasions. Top level shooters from 30 countries (5 continents) answered questionnaire during the 49<sup>th</sup> ISSF World Shooting Championships (Zagreb, Croatia, 2006) and all of them were national team members at that time. Top level coaches from 21 countries (5 continents) answered questionnaire during the the 49<sup>th</sup> ISSF World Shooting Championships (Zagreb, Croatia, 2006), ISSF Academy 'B' Coaches Course (Kuortane, Finland, 2006) and IOC Project for National Team Development (Kuortane, Finland, 2010). Coaches from average population from 3 countries answered questionnaire during the 1st International seminar for shooting coaches (Zagreb, Croatia, 2009).

## Results

Discriminant analysis has been chosen to examine the difference in evaluation of importance of different elements (technical, te; physical, f; mental, me; tactical, ta) in preparation (PP), competition (CP) and transition (TP) period between top level shooters, top level coaches and average population of coaches. Obtained results are shown in the following tables and figure.

Table 1. Descriptive statistics (*N* = number of participants, *M* = mean value of importance assessment on the 1 – 10 scale, *SD* = standard deviation of importance assessment on the 1 – 10 scale)

	N	Preparation period technical element		Preparation period physical element		Preparation period mental element		Preparation period tactical element	
		M	SD	M	SD	M	SD	M	SD
Top level shooters	57	8.82	1.58	7.56	2.16	7.47	2.68	5.88	2.69
Top level coaches	26	8.77	1.58	7.96	2.07	6.69	1.93	5.73	2.13
Average population of coaches	29	8.48	1.38	8.38	1.47	7.72	1.58	7.14	2.07
Total	112	8.72	1.53	7.87	2.00	7.36	2.29	6.17	2.46

	N	Competition period technical element		Competition period physical element		Competition period mental element		Competition period tactical element	
		M	SD	M	SD	M	SD	M	SD
Top level shooters	57	8.51	1.93	6.74	2.18	8.86	2.00	7.56	2.46
Top level coaches	26	7.46	2.47	5.85	2.38	8.54	1.70	8.65	1.35
Average population of coaches	29	9.24	0.83	8.24	1.81	9.24	0.87	9.03	1.18
Total	112	8.46	1.95	6.92	2.29	8.88	1.71	8.20	2.07

	N	Transition period technical element		Transition period physical element		Transition period mental element		Transition period tactical element	
		M	SD	M	SD	M	SD	M	SD
Top level shooters	57	6.49	2.37	7.61	2.15	6.18	2.54	5.02	2.47
Top level coaches	26	6.12	2.42	7.81	1.92	5.96	2.07	4.77	2.32
Average population of coaches	29	7.34	1.65	7.34	1.72	6.97	1.68	6.59	1.72
Total	112	6.62	2.25	7.59	1.98	6.33	2.25	5.37	2.36

Table 2. Correlations matrix of importance assessment on the 1 – 10 scale (PP = preparation period, CP = competition period, TP = transition period, te = technical element, f = physical element, me = mental element, ta = tactical element)

	PPte	PPf	PPme	PPta	CPte	CPf	CPme	CPta	TPte	TPf	TPme	TPta
PPte	1.00											
PPf	.16	1.00										
PPme	.16	.13	1.00									
PPta	.25	.17	.49	1.00								
CPte	-.02	-.04	.37	.21	1.00							
CPf	.09	.38	.35	.39	.44	1.00						
CPme	.03	.22	.55	.21	.24	.37	1.00					
CPta	-.01	.28	.08	.55	.04	.28	.36	1.00				
TPte	-.00	.30	.21	.17	.31	.38	.22	-.00	1.00			
TPf	.16	.40	.10	.06	-.09	.19	.08	-.05	.28	1.00		
TPme	.03	.06	.46	.15	.32	.40	.38	-.17	.60	.30	1.00	
TPta	-.02	.28	.21	.49	.34	.55	.30	.38	.60	.17	.57	1.00

Table 3. Discriminant analysis chi-square tests with successive roots removed

Extracted dimensions	Eigen-value	Canonical - R	Wilks' – Lambda	c <sup>2</sup>	df	p-value
K1	0.2719	0.462	0.623	48.96	24	0.0019
K2	0.2618	0.456	0.792	24,07	11	0.0124

Table 4. Standardized discriminant coefficients (K) and correlation of canonical variables with discriminantive function (F) (PP = preparation period, CP = competition period, TP = transition period, te = technical element, f = physical element, me = mental element, ta = tactical element)

	K 1	K 2	F 1	F 2
PPte	.264	-.146	.131	-.130
PPf	-.097	.444	-.152	.305
PPme	.216	-.274	-.305	-.112
PPta	-.478	-.070	-.403	.232
CPte	-.350	-.024	-.646	-.077
CPf	-.634	-.082	-.765	.150
CPme	-.226	-.644	-.280	.020
CPta	.487	1.340	-.150	.644
TPte	-.080	-.071	-.380	.110
TPf	.344	-.268	.158	-.020
TPme	.201	1.279	-.309	.130
TPta	-.180	-.590	-.554	.294

Table 5. Group centroids on discriminant functions

	C 1	C 2
Top level shooters (G1)	.015	-.496
Top level coaches (G2)	.760	.536
Coaches from average population (G3)	-.710	.494



Discriminant analysis has shown that it is possible to differ top level shooters (G1), top level coaches (G2) and coaches from average population (G3) on evaluation of importance of particular elements in different periods of season.

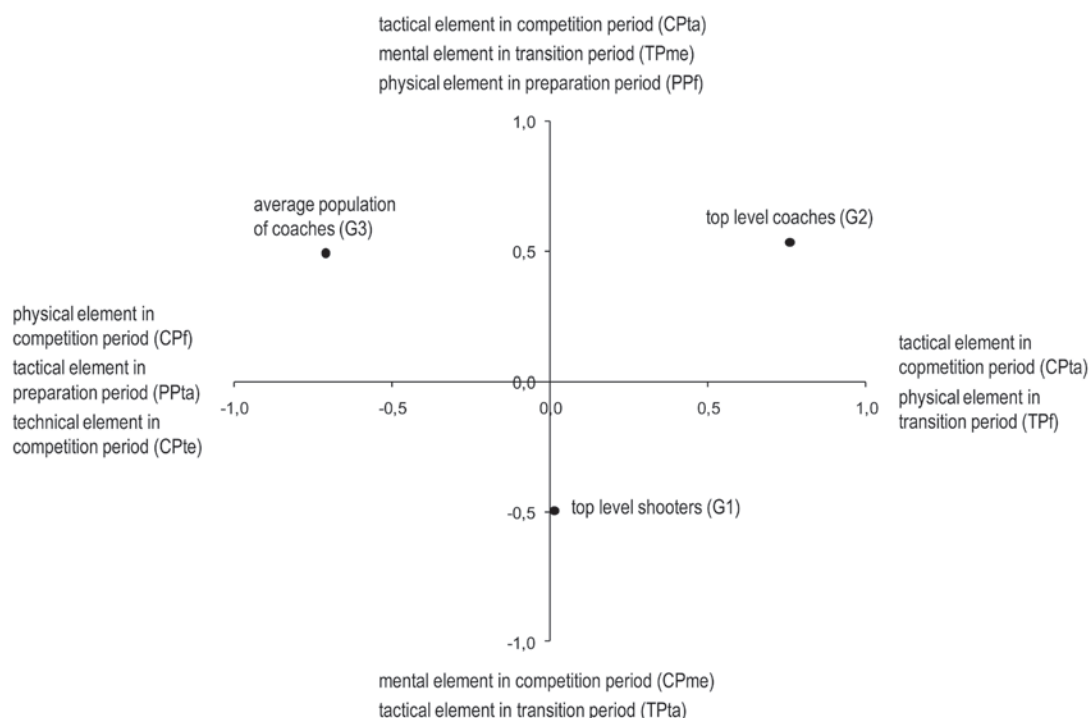

Figure 1. Group centroids on discriminant functions.

Variables on the positive pole of the first discriminant function (K1) are defined with the tactical element in competition period (CPTa) and physical element in transition period (TPf). Variables on the negative pole of the first discriminant function (K1) are defined with physical element in competition period (CPf), tactical element in preparation period (PPta) and technical element in competition period (CPte).

Variables on the positive pole of the second discriminant function (K2) are defined with the tactical element in competition period (CPTa), mental element in transition period (TPme) and physical element in preparation period (PPf). Variables on the negative pole of the second discriminant function (K2) are defined with mental element in competition period (CPme) and tactical element in preparation period (TPta).

## Discussion and conclusions

Aim of this research was to examine the difference in evaluation of importance of different elements in three major parts of periodization between top level shooters, top level coaches and average population of coaches. From the results (Figure 1) we can see differences between three groups of participants.

Top level shooters compared to coaches give more importance to mental element in the competition period. The researchers believe that shooters are less successful in recognition of their own readiness and they tend to attribute difference in their performances at competitions mainly to mental factors. Athletes state that from 40 % to 90 % of sport success can be attributed to mental factor (Williams, 2006).

Top level shooters compared to coaches give more importance to tactical element in the transition period. We assume that athletes tend to over analyse their performances at past competitions and could be impatient concerning necessary tactical issues. Coaches are conscious how rest and recovery are important for overall performance after they have already done all relevant analysis, while athletes often don't dare to take a break without thinking about tactical decisions at past competitions.

Coaches compared to top level shooters give more importance to tactical element in the competition period. The main role of coaches is to guide and give tactical advices to their athletes.

Coaches compared to top level shooters give more importance to mental element in the transition period. In the transition period it is important to use mental tools to maintain athletes' motivation, especially when the goal competition

has past (Bosnar & Balent, 2009). According to Bompa (2006) after successfully completed transition period athlete should feel strong will to practice.

Coaches compared to top level shooters give more importance to physical element in the preparation period. Such results can be explained by the fact that athletes often consider physical preparation as boring and are less motivated for it, and coaches are conscious of its importance for overall athletes' performance (Bompa, 2006).

Top level coaches compared to coaches from average population give more importance to tactical element in the competition period. This in accordance to recommendation of different authors (e.g. Bompa, 2006; Milanović, 2009; Issurin, 2008 & 2009).

Although both groups of coaches give low values to physical element in the transition period, top level coaches compared to coaches from average population give more importance to it. We can assume that top level coaches are more conscious of possible neglect of the particular element. Some coaches make mistakes allowing their athletes to have passive rest in longer transition periods. Passive rest leads to degradation of their form and can be harmful for them (Bompa, 2006).

Coaches from average population compared to top level coaches give more importance to physical and technical elements in the competition period. Coaches from average population compared to top level coaches give more importance to tactical element in the preparation period. This is not in accordance to recommendations of different authors (e.g. Bompa, 2006; Milanović, 2009; Issurin, 2008 & 2009). In the preparation period emphasis should be on physical and technical elements, while emphasis in the competition period should be on tactical element rather than on development of basic physical and technical skills.

We can conclude that top level coaches are working more with the athletes according to recommendations from sport and scientific literature. Considering this fact they have more refined knowledge which enables to neglect the importance of non-dominant elements of the particular periods less than the average population of coaches. We can assume that this attitude of coaches reflects on athletes' performance, even though athletes don't necessarily have to be aware of this fact because of lack of professional knowledge considering theory of training in general.

## References

1. Blumenstein, B., & Lidor, R. (2007). The road to the olympic games: A four-year psychological preparation program. *Athletic Insight*, 4, 15-28.
2. Blumenstein, B., & Weinstein, Y. (2010). *Psychological skills training: Application to elite sport performance*. Michigan: Ultimate Athletic Concepts.
3. Bompa, T.O. (2006). *Periodizacija: Teorija i metodologija treninga*. Zagreb: Gopal.
4. Bosnar, K. & Balent, B. (2009). *Uvod u psihologiju sporta: Priručnik za sportske trenere*. Zagreb: Odjel za izobrazbu trenera Društvenog veleučilišta u Zagrebu & Kineziološki fakultet Sveučilišta u Zagrebu.
5. Issurin, V. (2009). *Blok periodizacija: Prekretnica u sportskom treningu*. Beograd: Data Status.
6. Issurin, V. (2008). *Block Periodization 2: Fundamental concepts and training design*. Michigan: Ultimate Athletic Concepts.
7. Milanović, D. (2009). *Teorija i metodika treninga*. Zagreb: Odjel za izobrazbu trenera Društvenog veleučilišta u Zagrebu & Kineziološki fakultet Sveučilišta u Zagrebu.
8. Williams, J. M. (2006). *Applied sport psychology: Personal growth to peak performance*. New York: McGraw Hill.

## SKELETAL MUSCLE CONTRACTION TIME IN PROFESSIONAL FOOTBALL PLAYERS

**Boštjan Šimunič**

*University of Primorska, Science and Research Centre, Institute for Kinesiology Research, Koper, Slovenia  
TMG-BMC Ltd., Ljubljana, Slovenia*

### Abstract

Epidemiology research in football injuries is extensive and encourages preventive work in football. Therefore, the motivation of our work was to analyse Tensiomyographic contraction time in players of elite professional football teams. We analysed contraction time: (i) through development of young players in Slovenian national teams from 13-year olds to seniors; (ii) in teams of various eliteness; and (iii) during whole season macro cycle of one Italian football team. We found different developmental trends in different muscles; we found shorter contraction time in more elite teams; and we showed longitudinal adaptation of muscles contraction time during whole season macro cycle in selected team. Results of this study confirm longitudinal adaptation of selected muscles in football players. Furthermore, sensibility of Tensiomyographic method was found to be high to assure non-invasive and selective screenings of football players.

**Key words:** *tensiomyography, mechanomyography, electromyography, soccer, adaptation*

### Introduction

Football (soccer) is one of the most popular sports in the world. Currently FIFA unifies 207 national associations and represents about 265 million active players, of which about 26 million are women. The growth in football is striking, particularly in women. Furthermore, there are already over 1 million futsal players and the number of occasional soccer players is constantly increasing. In 2009 Croatia had 118316 registered football players (650 of them professionals) in 1732 football and futsal clubs.

Epidemiology of football research has been regularly conducted by World and European Football Associations, FIFA and UEFA, respectively. The incidence of football injuries is estimated to be 24 to 30 per 1000 matchhours in top 17 UEFA teams (Ekstrand, 2008). One athlete plays on average 100 hours of football per year: from 50 hours per player of a local team, up to 500 hours per player for a professional team, (Ekstrand, 2008). Author concluded that every player will have minimum one performance-limiting injury per year (Adamczyk, 2002). Furthermore, as a mean, a team of 25 players can expect 40 to 50 injuries per season, half of them causing absence less than a week but 6 of them causing absence more than a month (Ekstrand, 2008). However, some of the lighter injuries were not reported nor included in these epidemiology reports, like ones that limit athletic participation for less than one day after the day of injury onset.

It has been demonstrated that the overall risk of injury to professional football players is approximately 1000 times higher than for industrial occupations generally regarded as high risk (Hawkins & Fuller, 1999). However, the risk of injury has not increased during the last 5-year period (Ekstrand, 2008). High-velocity trauma and direct contact between players are the most common injury causes. Ekstrand (2008) reported that the most common types of injuries are: overuse (31%), strain (24%), sprain (22%), contusion (15%), and others. Furthermore, thigh muscle injury is the most common injury (23 %) at top level with an injury incidence of 1.6/1000 hours of exposure, which means that a team can expect 10 such injuries each season. Follows knee (20%), ankle (13%), hip/groin (12%), lower leg (11%), and others. However, mostly due to complex, high sample size, long term research designs, there is no relevant injury prevention research available at the moment.

On the grounds of exhaustive and productive professional work in football, using Tensiomyographic method, we have available data of top football teams and national teams. Tensiomyography offers a non-invasive and selective insight in skeletal muscle mechanical output (Valenčič & Knez, 1997; Šimunič et al., 2011) and could be used for evaluation and interpretation of skeletal muscle adaptability amongst football players.

Therefore, the aims of our study were to analyse (in selected muscles) tensiomyographic contraction time: (i) developmental adaptability trends in Slovenian national football teams, (ii) comparison between different quality football teams, and (iii) adaptability during one macro cycle in elite football team.

## Methods

**Participants:** Measurements were performed in accordance to all three aims of the study. Basic morphological data are presented in Table 1. For the first aim we measured seven male national football teams of Slovenia (U13, U15, U16, U17, U18, U21, seniors) with minimum of 18 and maximum of 26 players per national team. For the second aim we measured two elite teams from Slovenia, one elite team from Spain and five elite teams from Italy with minimum of 21 and maximum of 30 players per team. For the third aim we measured one elite Italian team of 22 players on four occasions during one season. Altogether 408 football players (aged from 12 to 38 years) were measured. All measurements were performed in the time period from 2007 and 2010. All team headquarters signed a written consent to participate in the measurements.

Table 1. Basic morphological data of football players

	SLO <sub>U13</sub>	SLO <sub>U15</sub>	SLO <sub>U16</sub>	SLO <sub>U17</sub>	SLO <sub>U18</sub>	SLO <sub>U21</sub>	SLO <sub>SEN</sub>	SLO <sub>2</sub>	ITA <sub>5</sub>	SPA <sub>1</sub>
N	18	21	26	18	23	21	24	51	118	22
AGE (yrs)	13 ± 0	15 ± 0	16 ± 0	17 ± 0	18 ± 0	21 ± 0	N.A.	23 ± 5	25 ± 4	N.A.
BM (kg)	55 ± 6	67 ± 8	71 ± 7	72 ± 6	73 ± 7	75 ± 6	N.A.	79 ± 7	78 ± 7	N.A.
BH (cm)	162 ± 6	177 ± 8	178 ± 7	180 ± 7	179 ± 6	182 ± 6	N.A.	181 ± 7	183 ± 6	N.A.

BM – body mass; BH – body height; N.A. – data not available; SLO<sub>UXX</sub> – Slovenian national team “Under XX years”; SLO<sub>SEN</sub> – Slovenian senior national team “Above 21 years”; SLO<sub>2</sub> – two Slovenian senior teams; ITA<sub>5</sub> – five Italian senior teams; SPA<sub>1</sub> – one Spanish senior team.

**Measuring method:** Tensiomyographic measurements were performed at least 24 hours after high intensity exercise to avoid muscle fatigue. Measured muscles were: vastus lateralis (VL), vastus medialis (VM), rectus femoris (RF), biceps femoris (BF), semitendinosus (ST), gastrocnemius lateralis (GL), gastrocnemius medialis (GM), tibialis anterior (TA), erector spinae (ES), and adductor longus (AL). Participants rested in supine position and maximal amplitude electrical stimulation (rectangular monophasic impulse, width 1 millisecond) was used to elicit maximal twitch muscle response that was measured using displacement sensor (TMG-ZD1, Figure 1). From the displacement-time curve of the twitch response a contraction time was calculated (Figure 2, time between 10% and 90% of maximal displacement, Valenčič & Knez, 1997).



Figure 1. Tensiomyographic measurement of biceps femoris muscle in elite football player.

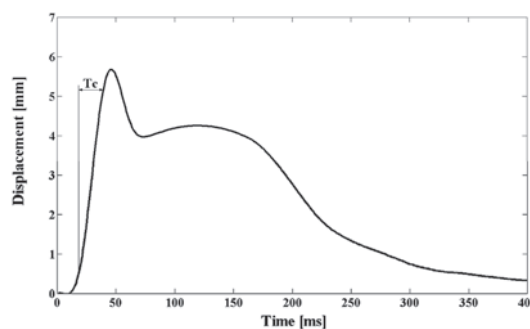

Figure 2. Contraction time ( $T_c$ ) estimated from maximal displacement-time twitch response.

**Data processing:** From two maximal twitch responses an average was taken to further analysis. All results are presented as averages ± standard deviation for selected group. Standard deviations were sometimes omitted from the graphs for clearer graphics. All statistical comparisons between groups were performed with analysis of variance with team nationality (SLO, ITA, SPA) as between-variance factor. Level of significance was set at  $P < 0.05$ .

## Results

None of the players complained on any kind of uncomfortable sensations during measurements. Therefore, all measurements planned were obtained and analysed. The results are presented in following three sections.

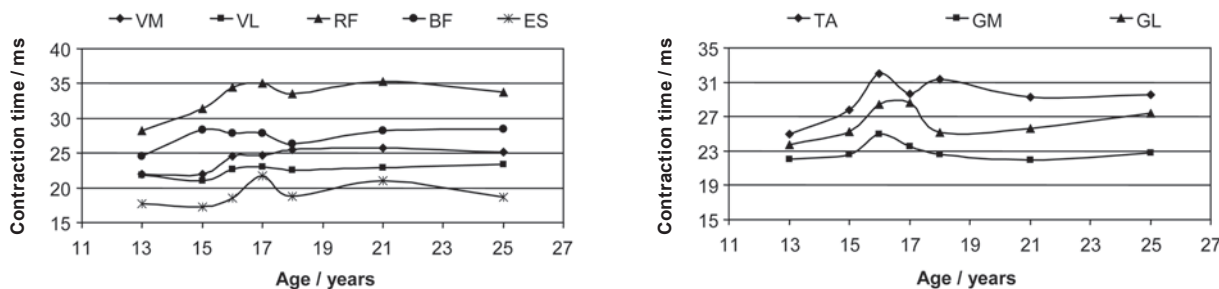

Figure 3. Developmental trends of contraction time in selected muscles from young to adult football national teams.

*Developmental trend:* From Figure 2 we could observe the shortest contraction time in ES and longest in RF. Furthermore, we could see in all measured muscles “high-frequency” changes in ages from 15 to 18 years, when puberty period take place. We could also observe “low-frequency” changes in some muscles (e.g. RF, BF, VM, TA, GL) towards longer contraction times. This analysis could confirm skeletal muscle response to puberty period and some assumptions of specific adaptations to football sport/training.

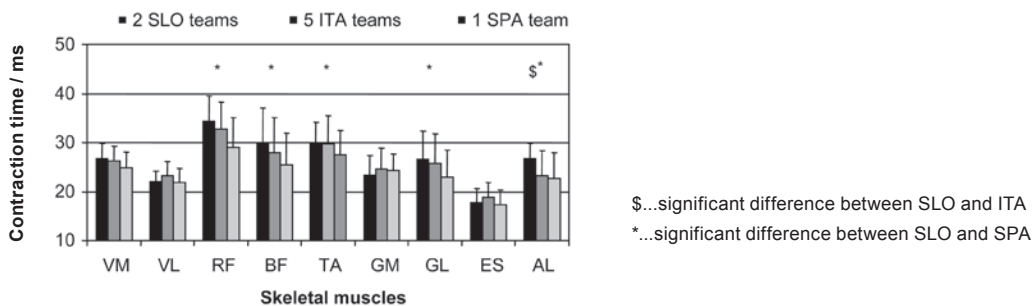

Figure 4. Comparison between selected skeletal muscles' contraction time averages between football teams of different eliteness.

*Eliteness comparison:* In Figure 4 comparison between averages of two Slovenian teams, five elite Italian teams, and elite Spanish team is presented. We could see shorter contraction times in almost all muscles in Italian and Spanish players, except in GM. Statistical significance revealed shorter contraction time (from Slovenian teams) in AL for Italian teams; and in RF, BF, TA, GL, and AL for Spanish team.

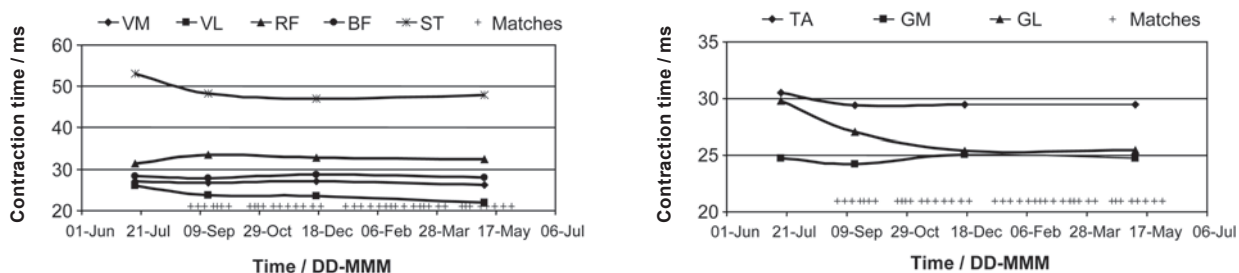

Figure 5. Contraction time adaptability during one football season – macro cycle of one elite Italian football team.

*Macro cycle analysis:* In Figure 5 a contraction time of eight skeletal muscles is presented for one elite Italian football team. Measurements were performed four times during one football season – macro cycle. We observed rapid adaptation toward shorter contraction times in ST and GL. Lower amplitude, however, still rapid adaptations towards shorter contraction time were observed also in TA, and VL. On the other hand, in RF an adaptation towards longer contraction time was observed.

## Discussion

To summarize, we observed adaptability of selected contraction times in three sub-studies. Firstly, contraction time trends in children are strongly dependent from their age and tend to become longer in RF, BF, and VM. Secondly, there are significant differences between teams of different eliteness, mostly in RF, BF, GL, TA, and AL. Thirdly, during one macro cycle skeletal muscles adapt to football movement specifics, where the most changes are evident in ST, TA, and GL.

Tanner (1978) reported a longitudinal growth charts for boys and concluded the most intense body height increments in years from 14 to 16 years, peaking about 10 cm in a year. This timing is in accordance with the timing of high-frequency contraction time adaptation (Figure 3). In growing boys sarcomeres are added (in series) at the ends of the muscle fibril. Muscle power, which is resultant of muscle force and velocity, will depend upon the total number of sarcomeres both in parallel and in series. Recently it was confirmed that muscle force increase does not drive bone growth during puberty, however it seem that in parallel muscle growth is in line with skeletal growth (Xu et al., 2009). However, it was reported that children lose their muscle flexibility during rapid growth sprout (Millar et al., 2001). Therefore, we could anticipate it by slower in series muscle fibrils elongations than bone elongations that could further affect less optimal actin-myosin overlap in sarcomeres. Higher contraction times could be logical consequence of less sarcomeres in series, together with lower actin-myosin overlap within sarcomeres. However, we must not forget also to other factors affecting contraction time, like muscle fibre distribution, calcium release kinetics and concentration.

Our finding that players in more elite clubs have shorter contraction time could be understood also with the fact that more elite football clubs employs more physically prepared players. Contraction time do differ amongst athletes: Djordjević et al. (2000) demonstrated shorter contraction times in track and field sprinters than in cyclists, while Praprotnik et al., (2001) found significant negative correlation between the maximal velocity of running and biceps femoris contraction time. In interpretation of our results we could confirm best football performance of Spanish football team, followed by average of five Italian football teams and than average of two Slovenian football teams. This could be also confirmed by their actual performance in UEFA Champions League. In the year of the measurement Spanish football team played in semi-final in UEFA Champions League, one Italian football team won Serie B National League, while four Italian football teams played in Serie A National League (three in the first nine at the final league table), and both Slovenian football teams were amongst top five in Slovenian national league.

The goal of the preseason conditioning program in all sports is usually to maximize muscular fitness before the competitive season. The in-season program is usually intended to maintain the preseason gains, but it is less clear at what amplitude or time dynamics skeletal muscle adopt in in-season period due to carefully designed game-rest-training intervals where little or even zero effort could be spared for tests. Tensiomyography (due to its non-invasiveness and low complexity) could be used for monitoring contraction time of selected muscles objectively with no player's effort and in very short time (typically in 15 minutes). The information about skeletal muscle adaptation could serve as a strong indicator of muscle adaptation (e.g. potentiation, fatigue, tonus; Šimunič, 2003) and potentially indirect indicator of body movement technique. In order to optimise players effectiveness on the field coaches find these information useful. From our results we could observe large declines of contraction time in ST, GL and TA muscles after preseason conditioning. This could be explained with high intensity training and matches being played during the season. Contraction time measured with Tensiomyography correlates significantly with muscle composition (Dahmane et al., 2000). Hyperplasia is not observed in humans and therefore we could not expect muscle fibre splitting. However, there is substantial evidence supporting muscle volume increase after high intensity exercise. The myosin and actin filaments are added to the myofibrils, resulting in enlargement of existing myofibrils. After myofibrils reach critical size it splits, yielding two or more myofibrils (Kraemer et al. 1995). Furthermore, it is well known that fast twitch fibres are more susceptible to high intensity adaptations. Those facts could explain decrement in contraction time of specific muscles involved in high intensity workout during the season.

In conclusion we could confirm Tensiomyography as a valid research tool for assessing skeletal muscle contraction time. The method was previously validated (Šimunič et al., 2011) and tested for high reliability (Tous et al., 2010). We could confirm that football game adopts muscles in specific manner, where most stress is put on medial muscles (VM and GM), back extensors (ES), while biarticular quadriceps muscle RF, calf synergistic muscle GL, and lateral hamstring muscle BF are being somewhat neglected. However, many injury incidences of those "neglected" muscles are present in football players.

## References

1. Adamczyk, G. (2002). Epidemiology of football related injuries. *Acta Clinica*, 3, 236-250.
2. Dahmane, R., Valenčič, V., Knez, N. & Eržen, I. (2000). Evaluation of the ability to make non-invasive estimation of muscle contractile properties on the basis of the muscle belly response. *Medical and Biological Engineering and Computing*, 39(1), 51-55.
3. Djordjević, S., Valenčič, V., Knez, N., Dahmane, R., Jurčič-Zlobec, B., Bednarik, J., Šimunič, B., Kerševan, K. & Godina, N. (2000). Contractile properties of skeletal muscles of two groups of sportsmen-sprinters and cyclists measured by tensiomyography. *In: 2000 pre-olympic congress* (p. 220), Brisbane, Australia.
4. Ekstrand, J. (2008). Epidemiology of football injuries. *Science and Sports*, 23(2), 73-77.

5. Kraemer, W.J., Patton, J.F., Gordon, S.E., et al. (1995). Computability of high-intensity strength and endurance training on hormonal and skeletal muscle adaptation. *Journal of Applied Physiology*, 78, 976-989.
6. Hawkins, R.D. & Fuller, C.W. (1999). A prospective epidemiological study of injuries in four English professional football clubs. *British Journal of Sports Medicine*, 33(3). 196-203.
7. Millar, A.L., Raasch, P., Robinson, Y., StJean, G., Wolff, C.F. & Perry, W.L. (2001). Hamstring flexibility of pre pubertal through post pubertal individuals. *Medicine & Science in Sports & Exercise*, 33(5), S10.
8. Praprotnik, U., Valenčič, V., Čoh, M., Šimunič, B. & Djordjević, S. (2001). Povezanost maksimalne hitrosti teka s kontraktilnimi lastnostmi mišic. In: M. Čoh (edt.). *Biomehanika atletike* (p. 68-75). Fakulteta za šport, Univerza v Ljubljani, Slovenia.
9. Šimunič, B., Križaj, D., Narici, M. & Pišot, R. (2011). Twitch parameters in transversal and longitudinal biceps brachii response. *Annales Kinesiologiae*, 1, 61-80.
10. Šimunič, B. (2003). Model of longitudinal contractions and transverse deformations in skeletal muscles. *Doctoral Thesis*. Faculty of Electrical Engineering, University of Ljubljana, Slovenia.
11. Tanner, J.M. (1978). *Foetus into Man: physical growth from conception to maturity*. Open Books, London, UK.
12. Tous-Fajardo, J., Moras, G., Rodríguez-Jiménez, S., Usach, R. & Doutres, D.M., Maffiuletti N.A. (2010). Inter-rater reliability of muscle contractile property measurements using non-invasive tensiomyography. *Journal of Electromyography and Kinesiology*, 20(4), 761-766.
13. Xu, L., Nicholson, P., Wang, Q., Alén, M. & Cheng, S. (2009). Bone and Muscle Development During Puberty in Girls: A Seven-Year Longitudinal Study. *Journal of Bone and Mineral Research*, 24(10), 1693-1698.
14. Valenčič, V. & Knez, N. (1997). Measuring of skeletal muscles dynamic properties. *Artificial Organs*, 21, 240-242.

## EVALUATION OF BASIC TYPES OF OFFENSE IN BASKETBALL ACCORDING TO ITS BEGINNING AND OUTCOME AND THE FINAL OUTCOME OF THE GAME\*

Dario Škegro<sup>1</sup>, Dražan Dizdar<sup>1</sup>, Dragan Milanović<sup>1</sup> and Asim Bradić<sup>2</sup>

<sup>1</sup>Faculty of Kinesiology, University of Zagreb, Croatia

<sup>2</sup>Sports Coach Training and Educational Department, Social Sciences Polytechnics in Zagreb, Croatia

### Abstract

Notational analysis in sport is very common and popular assessing method which facilitates getting answers to certain issues in kinesiology of top-level sport. In this investigation the offensive phase of basketball game is analyzed. Offensive phase is an integral part of basketball game and together with the defensive phase makes a complex of basketball game. Notational system *Match Analysis System* was used to analyze 1,785 different phases in 10 basketball games of the Beijing 2008 Olympics tournament. It was found that the distribution of the basic types of offense is not statistically uniform (Chi-square=1190.45,  $p=.000$ ). Statistically significant differences were found between the basic types of offense according to the beginning of offense (Chi-square=712.41,  $p=.000$ ), and the outcome of offense (Chi-square= 1.32;  $p=.000$ ). The differences according to the final outcome of the game were also tested, and statistically significant differences were confirmed (Chi-square=12.43;  $p<.002$ ).

**Key words:** differences, notational analysis, game of basketball, Chi-square, set offense, transition offense

### Introduction

There are numerous scientific investigations on basketball in the world and in Croatia. These investigations are conducted with the purpose to scientifically explain basketball game as it is one of the most popular team sports games in the world (Alvarez, et al., 2009; Han, et al., 2009; Ortega, et al., 2009; Tsamourtzis, Karypidis, & Athanasiou, 2005; Mavridis, et al., 2004; Remmert, 2003; Tavares & Gomez, 2003; Trninić, Dizdar, & Lukšić, 2002; Trninić & Dizdar, 2000; Trninić, Perica, & Dizdar, 1999, Trninić, Milanović i Dizdar, 1997, Trninić et al., 1994). Despite this fact, there are plenty of reserves for new investigations. In the current work, considering previous research studies on basketball, the basic types of offense will be defined and evaluated. The model of basketball game is a coherent, unique system structured from two constituent parts: **offensive phase** and **defensive phase** (Trninić, Perica, & Pavičić, 1994). The maximum duration of offense is 24 seconds and during that time one team may have the possession of the ball and the other, defenders, may not. Apart the ball possession as the main criterion to define offensive and defensive phase (which are existing simultaneously on the court – with one team in offense and the opposing team in defense, and vice versa alternately till the end of the game), it is possible to notice that every basketball game has situations that are repeating. Those situations are states of the game. There are two basic types of game states – the positional and transitional one. Basic difference between these two states is that the translation of the system (players and the ball) in the direction defense-offense in the positional state is negligible comparing to the transitional state (Trninić, Perica, & Pavičić, 1994). To define particular types of offense it is possible, besides the states of the game, to consider the time of the transitional or positional state and speed of the system moving from offense to defense. According to these criteria it is possible to distinguish among three different basic types of offense:

- Set offense can consists of both the transitional and set phase, or just of the set phase. The duration of set phase is considerably longer than the duration of the transitional phase ( $t_{sp} \gg t_{tp}$ ) and the velocity of the system “players and the ball” is lower than the velocity in the transitional phase of transition offense ( $v_{T-SP} < v_{T-TP}$ ). Based on the previously mentioned there are three basic types of set offense: set offense against man-to-man defense, set offense against zone defense and set offense against combined defense.
- Transition offense consists of only the transitional phase (the primary and secondary) or the transition phase and the set phase (the so called early offense). If the transition offense consists of two phases, then the set phase’s duration is, in general, shorter ( $t_{sp} < t_{tp}$ ).
- Other offenses are all offenses that cannot be recognized as either set or transition offenses (for example, offenses that ends quickly by losing the ball possession, offenses that ends quickly by a shot after winning the ball, either after a successful offensive rebound or a throw in).

\* This research was supported, in part, by grant no. 034-0342610-2609 (Programming of transformational procedures for physical conditioning) from Croatian Ministry of science, education and sport.



We assumed there was dependence between the basic types of offense and the opening of the offense, the outcome of offense and the final outcome of the game. The main goal of this paper was to verify these assumptions. According to the goal the following hypotheses were tested with the statistical significance set at  $p=0.01$ :

- Distribution of the basic types of offense is statistically significantly different from the uniform distribution.
- Differences between the basic types of offense are statistically significant with regard to the opening and outcome of offense.
- Differences between basic types of offense are statistically significant with regard to the final outcome of the game.

## Methods

This research was conducted on 1,785 offensive phases in 10 games of the Beijing 2008 Olympics tournament. The number of the points scored was 1,618, being the average of 0.91 point per offense (offense benefit value). The average number of passes per offense was 3.1, whereas offense on average lasted 11.5 seconds (Table 1).

Table 1. Descriptive parameters

Number of games	10
Number of offenses	1,785
Number of points	1,618
Offense benefit value	0.91
Average number of passes	3.1
Average duration of offense (second)	11.5

All entities (offenses) were classified as either: set offense, transition offense and other offense. Additionally, every offense was described in the following way:

1. Opening of an offense was divided in two main types of opening (observed variables are listed in the legend of Table 3):
  - Opening of an offense by a throw in (dead time),
  - Opening of an offense without time stoppage (the ball possession won).
2. Outcome of offense had following modalities:
  - Positive outcome – an offense gained at least 1 point,
  - Negative outcome – an offense closed by the possession lost with no scoring,
  - Neutral outcome – offense with no score but with the possession retained.
3. Number of passes – number of all (successful and unsuccessful) passes during an offense.
4. Duration of an offense – time (in seconds) one team is in the possession of the ball during one offensive phase as defined by the basketball rules.

Web application the *Match Analysis System* was used, as a computerized hand notational system to notate 10 games in this research. The games were taped in HDD/DVD format. In the collected data the following parameters were computed: absolute and relative frequencies, number of points, offense benefit value, average number of passes, and average duration of either set, transition, or other offenses. Hypotheses were tested with Chi-square test at the 0.01 significance level.

## Results and discussion

According to Table 2 it is obvious that the distribution of basic types of offense in basketball were statistically significantly different from the uniform distribution. Relative frequencies were as follows: the set offenses made 72% of all the registered offenses, the transition offenses 13% and the other offenses 15%. Although fewer in total, the transition offenses had considerably bigger *offense benefit value* (1.32 points per game) than the set offenses (0.89 points per offense) and the other offenses (0.63 points per game). Also, fewer passes and shorter duration were notated in the transition phase than in the set offenses. The set offenses lasted on average 14.5 seconds during which an average 3.8 passes were made, whereas the transition offenses lasted on average 4.9 seconds and 1.7 passes were made. During other offenses the smallest number of passes (0.9) was made and they lasted only 2.9 seconds on average. These results were expected because the *other offenses* were quickly finished by either the possession lost (turnover or rule violation), or by a quick shot after the possession had been won with the successful offensive rebound or throw in. When the *offense benefit value* is considered, it can be concluded that the transition offense is the most important regarding the final outcome in basketball game.

Table 2. Descriptive data of the structure of offense in basketball

Type of offense	NO	%	NP	OBV	AV-NP	AV-DO
SO	1,282	72%	1,137	0.89	3.8	14.5
TO	238	13%	314	1.32	1.7	4.9
OO	265	15%	167	0.63	0.9	2.9
ALL	1,785	100.00%	1,618	0.91	3.1	11,5

Chi-Square = 1,190.45; df=2; p=0.000

Legend: **SO** – set offense, **TO** – transition offense, **OO** – other offenses, **NO** – number of offenses, **OBV** – offense benefit value, **AV-NP** – average number of passes, **AV-DO** – average duration of offense

In table 3 absolute and relative frequencies of the basic types of offenses are presented regarding the opening of offenses. Statistically significant differences are confirmed between the basic types of offense according to the opening of offenses. It is possible to conclude that the basic types of offense are highly related to the way in which an offense is opened. Among 11 modalities of offense opening four have a dominant role (about 82%). These are: *throw in behind the endline in the backcourt* or defensive zone (44%), stolen balls (12.7%), and rebounds after the missed field shots – defensive and offensive with 17.8% and 7.3%, respectively. Those are modalities that differentiate most among the basic types of offense. The *set offenses* were predominantly opened (about 72% of them) by a throw in, other 28% were opened without stopping the game time (most frequently after a defensive rebound – about 17%, and fewer after a steal – 7%). The *transition offenses* had opposite openings' rates than the set offenses. About 83% of offenses were opened without stopping the game time (a steal – 43% and a defensive rebound – 40%). The *other offenses* were mostly opened by an offensive rebound (about 33%). Out of 130 offenses opened by offensive rebounds, 88 of them (about 66%) were other offenses, and 46 (about 34%) were set offenses.

Table 3. Absolute and relative frequencies of the set, transition and other offenses according to the opening of offense

Opening of offense	SO		TO		OO		ALL	
	F	%	f	%	f	%	F	%
TI-SL-MC	41	3.2%	0	0.0%	2	0.8%	43	2.4%
TI-EL-BC	676	52.7%	38	16.0%	72	27.2%	786	44.0%
TI-SL-BC	65	5.1%	1	0.4%	2	0.8%	68	3.8%
TI-EL-FC	68	5.3%	0	0.0%	18	6.8%	86	4.8%
TI-SL-FC	76	5.9%	0	0.0%	9	3.4%	85	4.8%
WB-JB	8	0.6%	1	0.4%	1	0.4%	10	0.6%
WB-S	86	6.7%	103	43.3%	37	14.0%	226	12.7%
WB-DR-MS	189	14.7%	94	39.5%	34	12.8%	317	17.8%
WB-DR-MFT	27	2.1%	1	0.4%	2	0.8%	30	1.7%
WB-OR-MS	44	3.4%	0	0.0%	86	32.5%	130	7.3%
WB-OR-MFT	2	0.2%	0	0.0%	2	0.8%	4	0.2%
ALL	1,282	100%	238	100%	265	100%	1,785	100%

Chi-square=712.41; p=0.000

Legend: **SO** – set offense, **TO** – transition offense, **OO** – other offense, **TI-SL-MC** – throw in behind sidelines in the middle of the court, **TI-EL-BC** – throw in behind the endline in the backcourt, **TI-SL-BC** – throw in behind sidelines in the backcourt, **TI-EL-FC** – throw in behind the endline in the frontcourt, **TI-SL-FC** – throw in behind sidelines in the frontcourt, **WB-JB** – winning the jump ball, **WB-S** – winning the ball by a steal, block, etc., **WB-DR-MS** – winning the ball by a defensive rebound after a shot missed, **WB-DR-MFT** – winning the ball by a defensive rebound after a free throw missed, **WB-OR-MS** – winning the ball by an offensive rebound after a shot missed, **WB-OR-MFT** – winning the ball by an offensive rebound after a free throw missed.

Statistically significant difference occurred between the basic types of offenses according to the outcome of offenses (Table 4). About 39% of the *set offenses* and 61% the *transition offenses* had the positive outcome. Relative proportion of neutral outcome in the transition offenses and set offenses is about 11% and 18%, respectively. This means that there are fewer *transition offenses* with the negative outcome (about 29%) than the *set offenses* (about 42%). The *other offenses* had about 31% of the positive, about 48% of negative and about 20% of neutral outcome.

Table 4. Absolute and relative frequencies of the set, transition and other types of offense according to the outcome of offense

Outcome of offense	SO		TO		OO		ALL	
	f	%	F	%	f	%	f	%
POS	503	39.2%	145	60.9%	83	31.3%	731	41.0%
NEG	543	42.4%	68	28.6%	128	48.3%	739	41.4%
NEU	236	18.4%	25	10.5%	54	20.4%	315	17.6%
ALL	1,282	100.0%	238	100.0%	265	100.0%	1,785	100.0%

Chi-square=51.32; p=0.000

Legend: **SO** – set offenses, **TO** – transition offenses, **OO** – other types of offense, **POS** – positive outcome of offense, **NEG** –negative outcome of offense, **NEU** – neutral outcome of offense

Relationship between the basic types of offenses and the final outcome of the game are presented in Table 5. Statistically significant differences occurred again. The basic types of offense are significantly different as regards either winning or defeated teams. The defeated teams had slightly more offenses (50.3) than the winning teams (49.7). The differences between the winning and losing teams in the number of the *set offenses* and *other offenses* are not so big, but the differences teams in the *transition offenses* are considerably larger. The winners had 20.2% transition offenses more than the defeated. Out of the total of 238 transition offenses, 143 (60.1%) was executed by the winning teams and 95 (39.9%) by the losing teams. Therefore, it is possible to conclude that the transition offense in basketball is a key performance indicator that leads to win.

Table 5. Absolute and relative frequencies of the set, transition and other types of offense according to the final outcome of the game

Outcome of the game	SO		TO		OO		ALL	
	F	%	f	%	f	%	f	%
WIN	611	47.7%	143	60.1%	133	50.2%	887	49.7%
LOS	671	52.3%	95	39.9%	132	49.8%	898	50.3%
All	1282	100%	238	100%	265	100%	1785	100%

Chi-square=12.43; p=0.002

Legend: **SO** – set offenses, **TO** – transition offenses, **OO** – other types of offense, **WIN** – winning teams, **LOS** – losing teams

## Conclusion

Aim of this research was to describe offensive phase in basketball game. Several important findings were obtained. The results of the analyses showed that the relations between the basic types of offenses in basketball are to a large extent conditioned by certain game states. This study confirmed the statistically significant difference between the types of offense in accord with the offense variables and the outcome of the attack. Statistically significant difference between winning and losing teams according to the variable type of offense is one of the most important findings of this paper. Regarding the winning and losing teams, one of the most important findings is that the transition offenses have the largest influence on the differentiation between the winning and losing games. This study also shows benefits of the computerized hand notation analysis which provides specific information through descriptive and statistical analysis. This information is very helpful and useful to kinesiology, sport scientists, coaches, athletes and other sportspersons.

## References

1. Álvarez, A., Ortega, E., Gómez, M.Á., & Salado, J. (2009). Study of the defensive performance indicators in peak performance basketball. *Journal Revista de Psicología del Deporte*, 18(SUPPL.), 379-384.
2. Han, X., Wu, L., Liu, X., Cheng, Z., & Gong, Y. (2009). Offense-defense semantic analysis of basketball game based on motion vector. In *Proceedings of 2009 International Conference on Image Analysis and Signal Processing*, Taizhou, 2009 (pp. 146-149). New York: Institute of Electrical and Electronics Engineers.
3. Mavridis, G., Laios, A., Taxildaris, K., & Tsiskaris, G. (2004). Developing offense in basketball after a return pass outside as crucial factor of winning. *Inquiries in Sport & Physical Education*, 2(1), 81-86.
4. Ortega, E., Palao, J.M., Gómez, M.Á., Lorenzo, A., & Cárdenas, D. (2009). Analysis of the efficacy of possessions in boys' 16-and-under basketball teams: Differences between winning and losing teams. *Perceptual and Motor Skills*, 104(3), 961-964.
5. Remmert, H. (2003). Analysis of group-tactical offensive behavior in elite basketball on the basis of a Process Orientated Model. *European Journal of Sport Science*, 3(3), 1-12.

6. Tavares, F., & Gomes, N. (2003). The offensive process in basketball – a study in high performance junior teams. *International Journal of Performance Analysis in Sport*, 3(1), 34-39.
7. Trninić, S., & Dizdar, D. (2000). System of the performance evaluation criteria weighted per positions in the basketball game. *Collegium Antropologicum*, 24(1), 217-234.
8. Trninić, S., Dizdar, D., & Lukšić, E. (2002). Differences between winning and defeated top quality basketball teams in final tournaments of European club championship. *Collegium Antropologicum*, 26(2), 521-531.
9. Trninić, S., Milanović, D., & Dizdar, D. (1997). Worin unterscheiden sich Sieger von Verlierern im Basketball. *Leistungssport*, 2, 29-38.
10. Trninić, S., A. Perica, & L. Pavičić (1994). Analiza stanja u košarkaškoj utakmici. *Kineziologija*, 26(1-2), 27-32.
11. Trninić, S., Perica, A., & Dizdar, D. (1999). Set of criteria for the actual quality evaluation of the elite basketball players. *Collegium Antropologicum*, 23(2), 707-721.
12. Trninić, S., Viskić-Štalec, N., Štalec, J., Dizdar, D., & Birkić, Ž. (1994). Latentna struktura standardnih pokazatelja situacijske efikasnosti u košarkaškoj igri. *Kineziologija*, 27(1), 27-37.
13. Tsamourtzis, E., Karypidis, A. and Athanasiou, N. (2005). Analysis of fast breaks in basketball. *International Journal of Performance Analysis in Sport*, 4(2), 17-22.

## DIFFERENCES IN COGNITIVE AND CONATIVE FUNCTIONING OF JUDOISTS, SHOOTERS AND VOLLEYBALL PLAYERS

Patrik Drid<sup>1</sup>, Nebojša Majstorović<sup>2</sup>, Gustav Bala<sup>1</sup>, Milena Mikalacki<sup>1</sup> and Miodrag Drapšin<sup>3</sup>

<sup>1</sup>Faculty of Sport and Physical Education, University of Novi Sad, Serbia

<sup>2</sup>Department of Psychology, Faculty of Philosophy, University of Novi Sad, Serbia

<sup>3</sup>Medical Faculty, Novi Sad, Serbia

### Abstract

#### Purpose

Bearing in mind that the construction of forecasting models for sporting success requires prior understanding of the specific psycho-motor profiles of athletes, the main objective of this study was to determine and compare the abilities of cognitive and conative functioning between judokas, volleyball players and shooters.

#### Methods

Study sample included 11 judokas, 21 shooters, 12 volleyball players and 22 students (control group). Characteristics of subjects were tested with battery of 3 cognitive (KOG-3) and 6 conative variables (KON-6). Multivariate and univariate differences between groups of examined sample of variables were calculated and tested. Differences between groups were also analyzed by the canonic discriminative analysis..

#### Results

Results showed that there were statistically significant differences between groups. The statistically significant difference between the groups emerged in variables *Serial processor efficiency* ( $AL_4$ ), *Parallel processor efficiency* ( $S-1$ ) and *Integration of regulatory functions* ( $\eta$ ) at the level of significance  $p < 0.01$ , whereas the variable *Coordination and control of regulatory functions* ( $\delta$ ) was found significant at the level  $p < 0.05$ .

#### Conclusion

Results of this research can be used for selection of new athletes as well as their diversion and recommendation to other sports.

## DIFFERENCES IN THE JUMP CAPACITY DEPENDING ON THE DEGREE OF OPPOSITION IN THE HANDBALL JUMP THROW

Jesus Rivilla, Jorge Lorenzo and Javier Sampedro

*Faculty of Physical Activity and Sport Sciences - INEF / Polytechnic University of Madrid, Spain*

### Abstract

#### Purpose

In handball, the most common shot at the goal is the jump throw made from 9m to the goal (Wagner et al., 2008). This throw is realized by opposition of the goalkeeper and, frequently with a defensive player between the thrower and the goal. The present study had for aim to analyze the influence of different degrees of opposition in the duration of the time of flight in the jump (jump capacity) in jump throw in professional team handball players.

#### Methods

To obtain it, forty five top level handball players were evaluated in three jump throw test with different degrees of opposition in which a maximum jump was requested: 1) without opposition (T1), 2) with the opposition of the goalkeeper (T2) and 3) with the opposition of the goalkeeper and a defensive player (T3).

The jump capacity was estimated from the time that the player was remaining in the air during the jump shot and was measured by a high speed video camera. A one-way ANOVA with repeated measures was used to analyze eventual differences in the duration of the time of flight for each round of throws.

#### Results

The analysis of differences between averages stated that the T3 was lower than T1 (8%;  $p < 0.01$ ) and T2 (7%;  $p < 0.01$ ). Significant differences were not found between T2 and T1. On the other hand, the analysis of correlations revealed average values of correlation between the T3 and T1 ( $r = 0.645$ ;  $p < 0.01$ ) and between T3 and T2 ( $r = 0.554$ ;  $p < 0.01$ ), whereas the correlation between T1 and T2 was raised ( $r = 0.869$ ;  $p < 0.01$ ).

#### Conclusions

The results state a marked influence of the defensive opposition in the jump capacity during the jump throw. Nevertheless, the presence of the goalkeeper does not seem to influence negatively the same one. On the other hand, the relation between test is significant and positive, diminishing major all that is the degree of opposition.

## THE EFFECT OF RULE CHANGES IN JUDO ON SITUATIONAL EFFICIENCY IN FEMALE JUDO BOUT

Husnija Kajmović, Izet Rado and Amel Mekić

*Faculty of Sport and Physical Education, Sarajevo, Bosnia and Herzegovina*

### Purpose

The purpose of the present study was to analyze effect of rule changes in judo on situational efficiency between two Balkans championship for female competitors. International Judo Federation changed refereeing judo rules in 2010. year. The lowest (3 points) „koka“ was dismissed, fight for “golden score”, time after fight draw of 5 minutes, was shortened from 5 to 3 minutes and grasp below the belt were banned with disqualification penalty – *hansokumake*.

### Methods

The research was conducted on the basis on DVD recordings 48 combat from Balkans championship (2006.) year and 52 combat from Balkans championship (2010.) year held in Bosnia and Herzegovina for female senior competitors of judo team: Bosnia and Herzegovina, Romania, Bulgaria, Greece, Albania, Serbia, Macedonia and Turkey. The groups of variables studied were: main group of judo techniques, subgroup of judo techniques, points and penalties, individual judo techniques, time duration of judo fights. All data were calculated frequencies and percentage values for all included variables.

### Results

The study found that effect of rule changes in judo on situational efficiency between two Balkans championship have led to increased significantly in efficiency of throwing techniques, increased efficiency of leg, side and sacrifice techniques, Waza-ari (7 points), penalty Shido 1-Free warning, Shido 2, Shido 3 and direct disqualification – *hansokumake*. Increased the efficiency of individual techniques: Uchi-mata, Ippon Seoi Nage, Tani-otoshi, Tai-otoshi. Number of ended fight before the end time of five minutes is increased as a result of changes in the rules of judo in 2010. year.

### Conclusions

This study presents references value of situational efficiency statistics and demonstrates in which aspects of judo combat there are differences between two Balkans championship for female competitors as results of effect rule changes in judo 2010. year. The presented data could be used to desing training sessions for competition in peak performance for female judo competitors.

**Key words:** judo, rule changes, effect, female, situational efficiency

## TRENDS IN THE IMPORTANCE OF APPLYING HYPOTHETICAL PERSONALITY DIMENSIONS DURING TOP LEVEL HEAVYWEIGHT K-1 FIGHTS

Safet Kapo<sup>1</sup>, Izet Rađo<sup>1</sup>, Branko Cikatić<sup>1</sup> and Erduan Kafedžić<sup>2</sup>

<sup>1</sup>Faculty of Sports and Physical Education, Sarajevo, Bosnia and Herzegovina

<sup>2</sup>The Fourth Grammar School - Ilidža, Sarajevo, Bosnia and Herzegovina

### Abstract

#### Purpose

Since the psychological process indicators and psychological state manifestations among top level K-1 fighters are heavily influenced by personality traits and characteristics manifested in those fighters' activities and formed under the influence of different factors during their year-long engagement in K-1, the purpose of research is the analysis of indicators of assessment of hypothetical personality dimensions with K-1 fighters.

#### Methods

This research has been carried out on a sample of 96 top level super heavyweight male fighters in final K-1 tournaments from 1993 to 2004 (in 84 matches). The final tournament was described with 13 variables of hypothetical personality dimensions: concentration, self-control, anxiety, aggressiveness, motivation, persistence, coldness, discipline, moral, positive attitude towards the weaker opponent, positive attitude towards the stronger opponent, behaviour after the knockout, tactful cunning. The collected data were processed by descriptive statistics. Frequencies and trends of hypothetical personality dimensions are based on the expert estimates of top K-1 fighters' fights and classified by Likert scale.

#### Results

Total average of three reversely oriented, abstracted variables (anxiety, aggressiveness, behaviour after the knockout) was (1.37), which indicates that negative aspects of personality exerted a very low level of influence on the fight outcome, or the fact that they fought in final tournament. The average value of the other ten variables was (3.99), most certainly a high value, which again suggests that positive aspects of personality exerted strong influence on the fight outcome in the final K-1 tournament in Japan. Trend analysis shows that the application of following variables increased: anxiety, behaviour after the knockout, moral, whereas the discipline variable has an almost identical level throughout all these tournaments. The variable of aggressiveness showed a decrease.

#### Conclusions

These results clearly indicate that a fighter needs to possess certain personality traits if he wishes to achieve his maximum in K-1.

**Key words:** K-1, top level fighters, super heavyweight, frequency, trend



## THE EFFECT OF HYPOTHETICAL PREDICTORS ON THE REPRESENTATION OF CHARACTERISTICAL MODALITY SERVICES IN VOLLEYBALL

Ifet Mahmutović<sup>1</sup>, Nedžad Osmankač<sup>2</sup>, Tine Sattler<sup>3</sup> and Joško Milenkoski<sup>4</sup>

<sup>1</sup>Faculty of sports and physical education, Sarajevo, Bosnia and Herzegovina

<sup>2</sup>Faculty of sports and tourism, Novi Sad, Serbia

<sup>3</sup>Faculty of sports, Ljubljana, Slovenia

<sup>4</sup>Faculty of physical education, Skopje, Macedonia

### Aim

The aim of this research presents the analysis of the transversal study of certain legalities of services as elements of volleyball game based on the example of the Russian volleyball team that played 28 games against 14 different national teams during the World League and World Championship in Japan in 2006.

### Methods

In the paper we operated by the pattern of matches, and not as it is usual, by the pattern of respondents. Data collection was carried out by the method of observation. Program called "DATA-volley", has been used. Each of the 6 modalities is firstly discussed descriptively, and then we examined the impact of the hypothetical predictors on the representation of specific modality services in the 102 analyzed sets.

### Results

The results of this research, generally when considered in relation to the course and ultimate outcome of the set of all six studied modalities, we may say that the Russian national team had more modalities that were closer to the negative side of the assessment scale and that the positive modes were closely associated with the result in the set. As the victory in the set is convincing the number of the positive services is increasing and vice versa, as the defeat is convincing, the number of successful service is thereby decreased. Low value of the coefficient variation indicates high homogeneity of the statistical series.

### Conclusion

In the two examined competitions, the Russian national team did not show the highest technical level in the area of service. Obtained data clearly show, that certain reserves for improving the game of the Russian national team lies in the area of services. The average representation of service modalities, depended on all three applied criteria.

**Key words:** volleyball, data – volley, serve, situational efficiency, national team

## ZONE 14 AS A STRATEGIC ATTACKING AREA IN CHAMPIONSHIP SOCCER

Gethin Rees<sup>1</sup>, Joe Taylor<sup>2</sup>, Phil Barter<sup>1</sup> and Ian Grant<sup>1</sup>

<sup>1</sup>Middlesex University, London, UK

<sup>2</sup>English Institute of Sport, Manchester, UK

### Purpose

Relatively little research has been devoted to the so called 'zone 14' (located centrally, directly in front of the 18 yard box) which seems popular within coaching. Research suggests that successful teams play more passes into this attacking area than unsuccessful teams (Grant et al., 1998) and made more forward passes from this area.

### Methods

Fifteen matches were analysed from the 2010/11 season involving five English Championship teams. Three successful teams (top 6 league positions throughout data collection) were compared with two unsuccessful (occupied the bottom six) using Chi square tests of independence. Only possessions that included at least one ball possession for the analysed team in the attacking third of the pitch were analysed.

### Results

Successful teams had a similar number of possessions in zone 14 (24.6 per game) as unsuccessful teams (24.4) which represented 45.2% of all attacks. Successful teams did not convert significantly more (36.9% vs. 28.8%) into shots compared to unsuccessful teams ( $p = .11$ ). Successful teams preferred to use a pass to feet (54.1%) rather than an aerial pass or run to get the ball into the zone 14, unsuccessful teams used each method similarly ( $p < .01$ ).

### Conclusion

Successful and unsuccessful teams in the Championship differed in their use of zone 14 only in the method of ball entry but possession quality needs to be investigated in the future.

### References

1. Grant, A., Williams, A.M., Reilly, T. and Borrie, A. (1998). Analysis of the successful and unsuccessful teams in the 1998 World Cup. *Insight*. 2, 1, 21-24.

## EVALUATION OF GAMES PERFORMANCE IN BEACH VOLLEYBALL DEPENDENCY LEVELS ATTACK FROM LEVEL OF QUALITY RECORDINGS

Marian Uvaček and Alena Cepkova

*Slovak University of Technology, Faculty of Mechanical Engineering, Slovakia*

### Purpose

Volleyball is in the objective analysis of games currently in predominant method of evaluating game performance. This method is based on observation and analysis activities player during the match. Evaluate the quality of implementation of individual gaming action. The aim of this paper was to examine how influences of quality levels attack hit the level of quality recordings.

### Methods

The task was to explain causal chain of consequential relations of the individual gaming action. Studied group consisted of 19 representative teams, couples in beach volleyball, which was attended by European Championship 18 years players.

### Results

We based on empirical experience that the quality of previous gaming activities of the individual significantly affects the quality of not only immediately following, but also in order for further gaming activities of the individual. At the level of the whole file, we found no significant relationship  $\chi^2 = 68.173$ ,  $p < 0.01$ . Thus, the level of quality offensive impact significantly depended on the level of quality pass. The objectively-logical point of view, it follows that a higher force attacks hit after acceptance submissions is dependent on exact pass, after which the young players have erred significantly less or ineffective attack. With decreasing levels of quality pass, decreasing the level and quality of attacking hit.

### Conclusions

For the sporting success of teams in that game and the match is important that every beach volleyball player completely handled game all the activities of individuals, regardless of how often in that game and the game frequently, and what role players in the match are met. Is optimal when both players in the team are universal.

## ANALYSIS OF DANCE POSTURES IN LATIN-AMERICAN DANCES USING ANNOTATION AND SAGIT TRACKING

Petra Zaletel<sup>1</sup>, Goran Vučković<sup>1</sup>, Lygeri Dimitriou<sup>2</sup>, Nic James<sup>2</sup>, Andrej Rebula<sup>1</sup> and Meta Zagorc<sup>1</sup>

<sup>1</sup>University of Ljubljana, Ljubljana, Slovenia

<sup>2</sup>Middlesex University, London, UK

### Purpose

Dancer's performance is not just the execution of steps but includes "intention" as a means to create a meaningful "whole" (Vermey, 1994). Aesthetic performances for the five Latin-American (LA) dances demand different approaches in movement structures exhibited by the male/female relationship. The study analysed the relationship postures in the LA dances.

### Methods

The Sagit system (Vučković et al., 2010) was used to determine the path of the dancers' movements whilst a second camera angle enabled the annotation of the dancers' posture relationships defined as: (1) open, touching, focused, (2) open, touching, without focus, (3) closed, (4) open, without touching, focused and (5) open, without touching, without focus.

### Results

In Samba dancers spent most of the time (38%) in open relationship touching each other, without focus on partner. Time spent in open position relationship holding or not holding each other was the same (45%) in Cha-cha, while in Rumba (70%) and Jive (60%) dancers spent far more time touching each other regardless of the focus in open relation. Passodoble was an exception, where half of the time dancers spent without holding each other and 13% of time they danced in a closed position relationship.

### Discussion

Latin American dancers express, with their movement, the content of each dance which seems to be defined by the relationship between the female and male dancer. Each of the five dances required very different positional relationships. It would be useful to analyze the importance of these relationships in respect of the eventual dance result.

### References

1. Vermey, R. (1994). *Latin. Thinking, sensing and doing in Latin-American dances*. Munich: Kastell Verlag.
2. Vučković, G., Perš, J., James, N., Hughes, M. (2010). *Measurement error associated with the SAGIT/Squash computer tracking software*. *European Journal of Sport Science*, 10 (2), 129-140.

## MAGNETIC STIMULATION IN THE DEVELOPMENT OF THE FORCE COMPONENT OF MUSCLE CONTRACTILITY

Grigory Popov, Eduard Malkhasyan and Vartanush Markaryan

*Russian State University of Physical Education, Sport, Youth and Tourism, Moscow, Russian Federation*

### Purpose

The purpose of this study is to research the impact of magnetic stimulation on the power component of muscle activity of a high qualification sportsmen.

### Methods

Used equipment: magnetic stimulator Magstim Rapid (Magstim, UK), Inertial dynamometer "Biodex", telemetry16-channel EMG ME-6000 (MegaWin, Finland), dinamografical platform ANTI.

The choice of the frequency of the influence of magnetic stimulation was defined from a spectrum of the electromyograms, which have been written down at examinees in background attempts. Muscular fibers of type IIa (FOG) were stimulated. The coil of the magnetic stimulator was established on the quadriceps muscle of thigh. Muscle tension was performed in the isometric mode on the "Biodex". Duration of impact was 10 seconds. The subject performed 10 trials with breaks. During the ten-day period, magnetic stimulation was carried out daily.

Biomechanical testing of athletes was performed in a test "jump upwards from a place, hands on the waist" from dynamographical platform with the angle of the knee 90°.

### Results

There is a pronounced significant increase in the moments of forces for all subjects after stimulation cycle (20 - 90%). The rate of growth of the curve dynamometer increases to maximum power. Interaction time increases with the support in a jump upwards, time of a flight phase after pushing away decreases.

The augmentation of the rate of increase has occurred only at the expense of a power component of muscular work. As the data of biomechanical testing testifies that the time of maximization of the dinamogramm increases. These facts are quite explainable as there was a targeting task to develop only a power component of muscular activity.

### Conclusions

1. The principal possibility of increasing the force component of muscle activity under the influence of magnetic stimulation in a small duration of a training cycle is shown.
2. The stimulation by an alternate magnetic field of muscles possesses targeting action allowing to solve problems of development of concrete physical qualities.



# Management of Sport

## 6<sup>th</sup> INTERNATIONAL SCIENTIFIC CONFERENCE ON KINESIOLOGY

“INTEGRATIVE POWER OF  
KINESIOLOGY”

**Editor:**  
**Prof. Mato Bartoluci, PhD**

**Peer Reviewers:**  
**Prof. Helga Maškarin Ribarić, PhD**  
**Prof. Jakob Bednarik, PhD**  
**Prof. Rajko Šugman, PhD**



**Secretary:**  
**Sanela Škorić, PhD**

## PART ONE: MANAGEMENT OF SPORT

### QUO VADIS, SLOVENIAN SPORT?

Gregor Jurak<sup>1</sup>, Marjeta Kovač<sup>1</sup>, Jakob Bednarik<sup>1</sup> and Edvard Kolar<sup>2</sup>

<sup>1</sup>University of Ljubljana, Faculty of sport, Slovenia

<sup>2</sup>University of Primorska, Science and research center Koper, Slovenia

#### Abstract

Purpose of this study was to get proper picture about realisation of the National programme of sport in Republic of Slovenia (NPS) in past decade to design new one. On the basis of strategic management's methodology the extensive review of different statistic and research data about different parts of Slovenian sport in period 2000–2008 was analysed. General conclusion is that Slovenian sport has risen in the past decade. The number of sports organisations increased by 91%, the number of elite athletes has increased by 14.7%, investment in sports facilities provides 0.33m<sup>2</sup> of indoor sports facilities and 3.15m<sup>2</sup> of outdoor sports facilities per capita, Slovenes are one of the most sportingly active nations of European Union, expenditure for sport increased by 37%, successful national sports programmes for children were set etc. Findings of analyse gave solid foundations for designing the proposal of NPS 2011–2020.

**Key words:** strategic management, national programme of sport, sports policy, indicators of sport successfulness

#### Introduction

Sport has the potential to improve people's quality of life therefore every society is committed to widening access to and encouraging people to take part in sporting activities at all levels. Measures which are well organized could benefit in good overall performance. In year 2000, Slovenian Parliament adopted National programme of sport in Republic of Slovenia (NPS) to set down strategic development guidelines for Slovenian sport for 2000 – 2010 period. In expiration of programme questions about realisation of NPS 2000 and basis for new strategy had aroused. On the basis of recommendations from the Ministry of education and sport, Slovenian Olympic Committee – Association of Sports Unions (SOC) and the Faculty of sport, the Minister has named a project team for answering to those questions.

#### Methods

The methodology of strategic management (Colin & Ackermann, 1998; Pučko, 2008) was adopted for preparation of the new NPS. Such methodology recommends a series of steps in preparation of strategic documents. The model of preparation of new NPS2011–2020 can be seen in Figure 1.

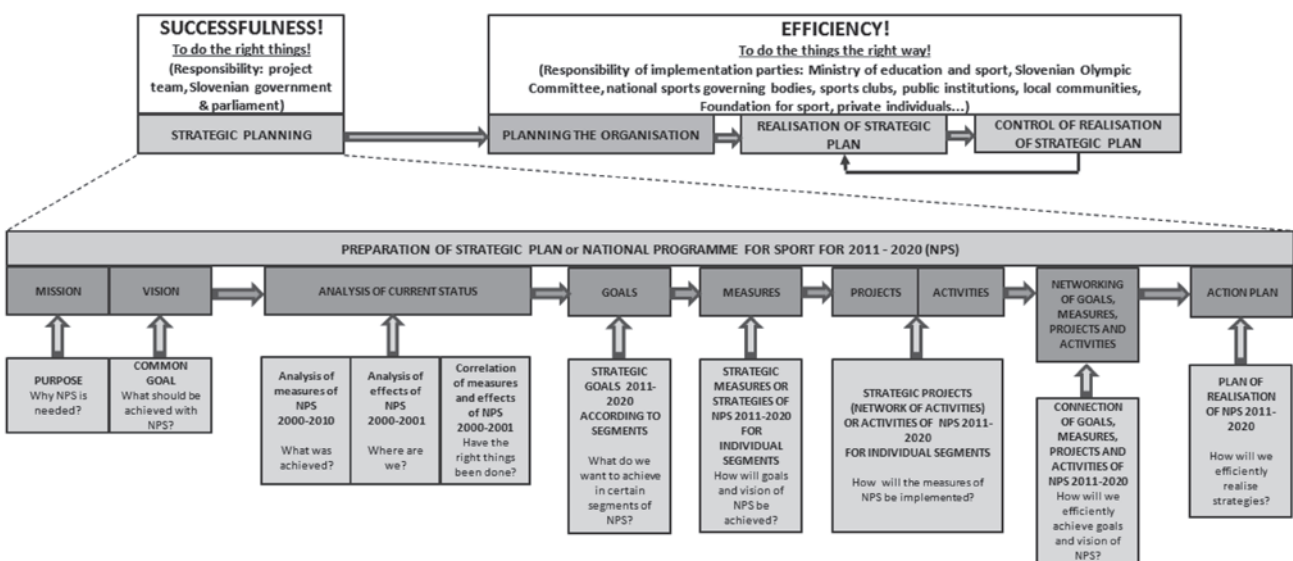

Figure 1. Model of preparation of the National programme for sport in Slovenia 2011 – 2020

Four strategic documents will need to be prepared in order to deal with the entire future development of Slovenian sport in the following order:

1. Analysis of the National programme for sport in Slovenia for 2000-2010,
2. National programme for sport in Slovenia for 2011 – 2020,
3. Action plan for the implementation of the National programme for sport in Slovenia for 2011 – 2020,
4. The novelty on the Law on sport or a new Law on sport (on the basis of passed NPS).

In this paper we will focus on first document. Following an extensive review of different statistic and research data about different parts of Slovenian sport, physical education, public and private finance in sport performance of Slovenian sport in period 2000-2010 was analysed. The analysis consisted of a review of the entire internal setting of sport, which included those segments of sport that formed a part of NPS 2000. Complete field of sport has been divided into substructures (organisational, financial, research & development, programme and infrastructure) and each of the substructures of sport has been evaluated analytically. Within the entire analysis, in total 20 areas of sport have been reviewed and evaluated; also three areas of external setting of sport (economic effects, taxation aspects and sport in educational system). In the segment of analysis of infrastructure, environmental as well as some other topics, related to construction of sports facilities, have been considered. On such basis a proposal of the NPS for the next decade has been prepared.

## Results and discussion

Main findings of the analysis are presented in Table 1; details can be found in an extensive monograph (Kolar, Jurak & Kovač, 2010).

Table 1. Slovenian sport in numbers

Total expenditure for sport	597.521.712 € (1,93% of BDP)
Average annual expenditure of household for sport	<b>496 €</b>
Number of sports organisations	<b>7,439</b>
Number of sports clubs	<b>6,115</b>
Annual averages income of sports club	<b>32,764 €</b>
Resources from Yearly sport programme per person	<b>49.28 €</b>
Indoor sports facility (m <sup>2</sup> per person)	<b>0.33</b>
Outdoor sports facilities (m <sup>2</sup> per person)	<b>3.15</b>
Number of compulsory physical education lessons in education system	<b>3 academic hours (45 minutes) in primary school and 1 to 3 in secondary school, 0 in higher education</b>
Proportion of sportingly active adult population	<b>64%</b>
Number of children in sports programmes Golden Sun and Krpan	<b>94.953 (approx. 70% of 6- to 9-year-old children and approx. 50% of 9- do 12-year-old children)</b>
Proportion of swimmers among 12-year-old children	<b>85.60%</b>
Number of registered athletes in competitive systems of national sports governing bodies, competing for the title of national champion	<b>87,520</b>
Number of categorised athletes	<b>4,520</b>
Number of world-class athletes	<b>52</b>
Number of sports with categorised athletes	<b>110</b>
Number of local communities with categorised athletes	<b>133</b>
Number of children and youth, included in the project of National sports schools	<b>7,016</b>
Number of young athletes with scholarship	<b>145</b>
Number of suppliers of coaching education programmes and number of programmes	<b>60 suppliers, 282 programmes</b>
Number of researchers in sport	<b>85</b>
Average number of organised World and European championships per year	<b>8</b>

Note: Slovenia covers an area of 20,273 km<sup>2</sup>, has a population of 2.05 million and \$23,009 GDP per capita.



The number of sports organisations (private and public) has throughout the entire observed period increased by 91% (3,544). Particular expansion has been noticed in private sector, both in the number of organisations and the income made. Despite this fact, the model of extra-curricular sport is still based on sports clubs. Clubs are main protagonists of Slovenian competitive sport. 87,520 athletes were registered (SOC, 2009) as participants in competitive systems of national sports governing bodies up to the level of national champion in 2009 (an estimate for 2000 was 15.000 athletes). In last decade, the number of elite athletes has increased by 14.7%. The number of medals won at major international competitions (Olympic Games, World and European championships) has been during the years 2000 and 2008 increasing by 8% per year. With five medals won at the 2008 Summer Olympic Games in Beijing, Slovenia placed second on the ranking list of medals won per capita; with three medals won Slovenia ranked third at the 2010 Winter Olympic Games in Vancouver. Slovenia is one of the five European countries and by far the smallest country (France, Germany, Serbia and Spain), which in 2010 had teams qualified for Football World Cup as well as World Championships in basketball and handball.

Such results were achieved with the help of various systemic measures. The level of expertise of working with children and youth has increased, particularly due to financial support for educated sports professionals, working with this sensitive part of population within the project of national sports schools (Jurak et. al., 2005). Various national sports programmes for children (Golden Sun; Krpan; Learn to swim; Hoorah, free time) in the last ten years contributed to improvement of contents, workforce and infrastructure for physical activity of pre-school and primary school children. Nevertheless, positive trends in organised free time sports activities of children did not manage to neutralise negative changes in lifestyle of children and youth (Strel, Kovač, & Jurak, 2007). Negative trends are still significantly smaller in comparison to other European countries.

Ensuring the infrastructure conditions for carrying out sports activity has been accomplished through intensive investments of local communities into a network of sports facilities, thus providing 0.33m<sup>2</sup> of indoor sports facilities and 3.15m<sup>2</sup> of outdoor sports facilities per capita. The network of sports facilities ensures access to sport for the majority of population; the fact has been confirmed also with international comparisons. Slovenes are in first place according to the use of natural sports facilities and one of the most sportingly active nations of European Union (Eurobarometer, 2010), as 64% of population is sportingly active and 33% of population practice sport on a regular basis (Sila et. al., 2010).

In the last decade a second developmental sports infrastructure has been set up. In the studied period, 1,130 professional people finished university or further education sports degree. In the same period, 9,679 professional people were trained in sport. Supporting the transfer of knowledge are sports and other organisations, which on an annual basis publish 70 scientific and professional items of literature from sport. Supporting the athletes with monitoring of their preparation are 9 laboratories of the Institute of sport at the Faculty of sport in Ljubljana and one laboratory at the University of Primorska.

An analysis of financing of Slovenian sport (Bednarik, Kolar, & Jurak, 2010) revealed that the entire expenditure for sport in the last decade has been increasing on an absolute level. In 2001, expenditure for sport amounted to 433.9 million EUR, whereas in 2007 it was 597.5 million EUR (1.93% GDP). Proportion of public expenditure for sport (16%) is lower than in most EU countries (Montel & Weelbroeck-Rocha, 2010). Expenditure of households represents almost half of total expenditure for sport. The income of sports organisations has in the last decade risen from 158.9 million EUR to 300.3 million EUR.

In 2008, 100.1 million EUR of public finances went to sport (see Figure 2) in comparison to 63.4 million EUR in 2001. Local communities contributed 75.2% and the state government 24.8% of total public expenditure for sport, signifying decentralised model of financing in sport, which can be compared to western European countries.

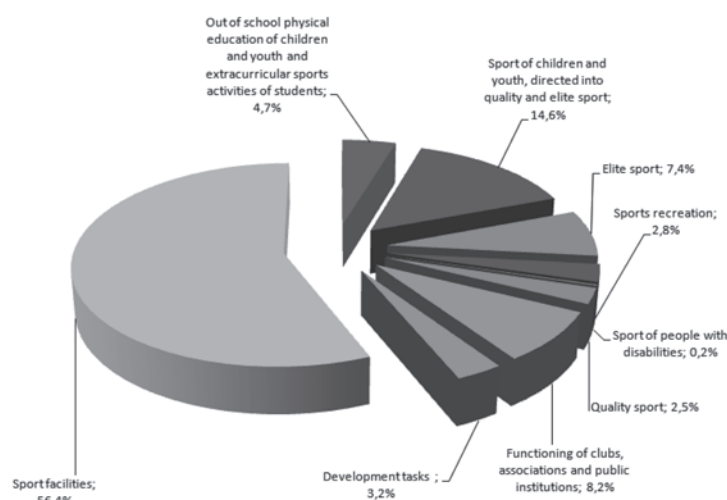

Figure 2. A structure of public finances in 2008 according to the categories of National programme for sport in Slovenia

## Conclusion

We found that scientific approach gave proper foundations for discussion about new NPS since there were too many subjective opinions in Slovenian sport. Ministry and SOC accepted report. On this base and with the line of strategic planning methodology we designed proposal of NPS 2011-2020 (Jurak et al., 2010). Main mission of the NPS 2011-2020 is creation of conditions for development of sport; in turn, sport to become an important factor of improvement of every individual and the entire society. NPS defines public interest, which is carried out by acting parties and creators of Slovenian sport. A vision states that in the coming decade “*Sport will become more important part of culture of our nation and should become a necessary part of a healthy lifestyle and positive attitude towards life for every individual.*” To reach vision strategic goals and measures on different structures (sports programmes; sports facilities and natural facilities for sport; developmental activities in sport; functioning of sports organisations; tax benefits of sport; support for humanity in sport) were set. Every segment includes: set strategic goals, which will support accomplishment of basic goals from NPS proposal, indicators, which can objectively measure reaching the strategic goals of the segment and measures, which should be realised in order to fulfil strategic goals of the individual segment. In addition, for each segment a proposal of action plan has been prepared, stating activities (or projects) needed to be realised for each measure, deadline and the amount of financial resources and the creators (both financial and organisational) for each activity.

NPS proposal defines sport as a basic human right. It is intended for all permanent and temporarily residents of Slovenia. It grants non-governmental part of society an important role in the field of sport and suggests that it should become an important decision-maker in the managing process of the NPS.

The significance of social roles of sport requires intertwining of sport with various social areas: health, education, business, environment, tourism, culture, finances, transportation etc. Therefore, the proposal has been set wider than previous one and defines the role and responsibility of individual creators for providing the conditions for development of sport in the entire social sphere. It defines guidelines for appropriate placement of sport into strategies and policies of these areas and mutual work for common public good.

## References

1. Bednarik, J., Kolar, E., Jurak, G. (2010). Analysis of the sports services market in Slovenia. *Kinesiology*, 42(2), 142-152.
2. Colin, E. & Ackermann, F. (1998). *Making Strategy: The Journey of Strategic Management*. London: Sage Publications Ltd
3. *Eurobarometer* (2010). Retrived April 15, 2010, from [http://ec.europa.eu/public\\_opinion/archives/ebs/ebs\\_334\\_en.pdf](http://ec.europa.eu/public_opinion/archives/ebs/ebs_334_en.pdf)
4. Jurak, G., Kolar, E., Kovač, M., Bednarik, J., Štrumbelj, B., & Kolenc, J. (2010). Predlog Nacionalnega programa športa v Republiki Sloveniji 2011 - 2020 [A proposal of National programme for sport in Slovenia for 2011 - 2020]. *Šport*, 58, (1/2), 135-172.
5. Jurak, G., Kovač, M., Strel, J., Starc, G., Žagar, D., Ceci Erpič, S. Paulič, O. et al. (2005). *Športno nadarjeni otroci in mladina v slovenskem šolskem sistemu* [Sportingly talented children and youth in Slovenian education]. Ljubljana: Fakulteta za šport.
6. Kolar, E., Jurak, G., Kovač, M. (2010). *Analiza nacionalnega programa športa v Republiki Sloveniji 2000-2010* [Analyses of national programme of sport in Republic of Slovenia 2000-2010]. Ljubljana: Faculty of Sport, 2010. Retrieved April 15, 2010, from [http://www.fsp.uni-lj.si/COBISS/Monografije/Analiza.nac.prog.sporta2010\\_1.pdf](http://www.fsp.uni-lj.si/COBISS/Monografije/Analiza.nac.prog.sporta2010_1.pdf).
7. *National programme for sport in Slovenia* (2000). Ljubljana: Ministry for education and sport & Agency for sport Slovenia.
8. Pučko, D. (2008). *Strateški management* [Strategic management]. Ljubljana: Ekonomska fakulteta.
9. Sila, B. et al. (2010). Športno rekreativna dejavnost Slovencev [Sports-recreational habits of Slovenian people]. *Šport*, 67(1-2), anex.
10. Slovenian Olympic Committee – Association of Sports Unions (2009). *Pregled registriranih športnikov - 01.decembra 2009* [A review of registered athletes – December 1 2009]. No of document: 30303-4-4/9, Ljubljana: SOC.
11. Strel, J., Kovač, M., & Jurak, G. (2007). Physical and motor development, sport activities and lifestyles of Slovenian children and youth – changes in the last few decades. Chapter 13. In: W. D. Brettschneider & R. Naul (eds.), *Obesity in Europe: young people's physical activity and sedentary lifestyles* (p. 243-264). Sport sciences international, No. 4. Frankfurt am Main: Peter Lang.
12. *The law on sport* (1998). Ljubljana: Ministry for education and sport.

## APPLICATION OF STRATEGIC MANAGEMENT ACTIVITIES IN CROATIAN NATIONAL SPORT FEDERATIONS

Sanela Škorić

*Faculty of Kinesiology, University of Zagreb, Croatia*

### Abstract

The paper deals with strategic management issues. It emphasizes the need to implement strategic management activities in non-profit sport organizations as well as in for-profit organizations due to an ever changing environment and its importance for decision-making. Since this is a process that is just starting to develop in Croatian sport federations, the question of who can conduct these activities is also addressed. The results of a research conducted with Croatian national sport federations show that the majority of these organizations do not apply strategic management activities. At the same time, executive board members are identified as the ones that should be a part of or in charge of the strategic management process. The grades concerning the competencies and motivation of executive board members to manage sport federations were above average which is significant for the future. Croatian national sport federations should make an effort to implement strategic management activities in their everyday business activities, because it will definitely help them achieve their goals and objectives easily.

**Key words:** *mission, vision, executive board members*

### Introduction

Every organization, as well as sport organization, conducts its business in a very complex and dynamic environment. This environment cannot be ignored in the decision-making process, especially when long-term objectives are being set. Organizations can no longer take into account only their internal capabilities. While making strategic decisions, it has become necessary to anticipate, control, evaluate and include the ever-changing external environment as well (Pearce and Robinskon, 2000., in Buble, 2005:1). Therefore, organizations were practically forced to apply different approach to their business, later called strategic management. This approach implied orientation to, until then relatively ignored, external environment of an organization because it became clear that it is constantly changing and therefore influencing their business. Strategic management can be defined as “the process of monitoring and analyzing key changes in the environment and developing strategies to increase the organization’s effectiveness in response to those changes” (Covell et al., 2003:139). It is conducted through several phases known as: environmental analysis, guiding the way, strategy formulation, strategy implementation, and the control and strategy evaluation (Buble, 2005:8). **Environmental analysis** implies screening the environment to identify external and internal strategic factors that will shape the future of organizations. There are numerous ways in which this type of analysis can be conducted (Parker, 2004). However, one of the most commonly used and the most simple way is to conduct a SWOT analysis (identify strengths, weaknesses, opportunities and threats). To **guide the way** means to define a vision, mission and long-term objectives of an organization. Vision is a future picture of an organization; it gives an answer to a question what organization wishes to achieve. The prerequisite for defining a vision is knowing the key competencies of one’s organization, and to analyse the environment so as to understand the current situation, but also to be aware of the most plausible future for the organization. Mission, on the other hand, explains what the purpose of the existence of an organization is. Defining a mission should be the first step towards defining a strategy of an organization (Bartoluci, Škorić, 2009:68), and it should answer the following questions: why the company exists, what it does, whose interests and demands it fulfils, and what the key values in organization are. Finally, the objectives and goals show us what the organization should accomplish, in what volume and when. Whenever possible, these objectives and goals have to be quantified. “Defining a mission, vision and company goals is the foundation upon which management can find ways as to how, by which methods and resources this can be achieved” (Buble, 2005:10). The next step is to **define a strategy**, i.e. a “course of action an organization selects to minimize threats and maximize opportunities that emerge in the environment” (Covell et al., 2003:160). Strategies that can be defined are corporate-level, business-level and functional-level strategies (more in Covell et al., 2003:160-164; Buble, 2005:11). All previously mentioned steps are useless if the defined strategy is not properly implemented. And finally, it is necessary to control the strategic management process in order to ensure its functionality and improve it.

However, this need for applying strategic management principles in sport organizations has not been identified until the early 1990s, when researchers started to consider strategy in the context of sport organizations. Of the few studies

that have been undertaken, researchers have concentrated on investigating strategy and policy development in terms of identifying the situational features of the sport environment (see Ferkins, Shilbury & McDonald, 2005:203). One of the reasons for this is connected with the fact that sport organizations appear not only as private or profit, but more often as public or non-profit organizations. This means that strategy development in a public (non-profit) organization is characterized by the following (see more in Gedvilaite-Moan and Laskiene, 2010:90-91):

- most public organizations do not have the same strategic freedom as private companies since some of their strategic goals are decided by politicians;
- public organizations do not always have the resources needed to meet the demand and have to prioritize which customers / users to serve;
- public organizations have a very limited operating room in some aspects of human resources management.

Therefore, it seemed unnecessary to apply strategic management activities in non-profit organizations. However, it was as far as in the 1988 that Bryson pointed to the fact that “leaders and managers of these types of organizations must be effective strategists if their organizations are to fulfil their missions and satisfy their constituents in the years ahead” (cited in Thibault and Slack, 1994:218-219). Since sport organizations exist to meet the needs of the market in ways that differentiate them from their competitors, and as these needs, or the ways in which they can be satisfied, change, so too must the organization’s strategy (Parker, 2004:215). As expected, in their efforts to provide increased value for money and to genuinely improve their outputs, public sector organizations (therefore, sport organizations as well) have been increasingly turning to strategic planning systems and models (Wilkinson and Monkhouse, 1994, cited in Gedvilaite-Moan and Laskiene, 2010:90).

Various reasons can appear as motives for developing a strategic plan, i.e. begin with a strategy development process (see Bayle et al. 2007:63-63; Gedvilaite-Moan and Laskiene, 2010:92). If nothing else, the fact that non-profit organizations should seek to increase the proportion of funding that they generate from non-government sources will push them towards corporation sponsorship. “In order for these organizations to meet this challenge successfully, their staff members and volunteers will not only have to develop their own strategies in this area, but they will also need to gain a greater understanding of the reasons why corporations become involved in sponsorship” (Berrett and Slack, 2001:22). Strategic management process, that incorporates environmental analysis, will certainly help in achieving this goal.

Also, although limited research has been conducted concerning strategic management and organizational effectiveness, in their research on organizational and board effectiveness Herman and Renz (1998, cited in Ferkins, Shilbury & McDonald, 2005:200) found five propositions directly applicable for the sport organization context. One of those propositions was that more effective non-profit organizations are more likely to use correct management practices (including strategic planning and strategy development) than are less effective non-profit organizations. Although the programme outcome indicators, as measures of non-profit organizational effectiveness, are limited and can be dangerous, this can certainly imply the need for applying strategic management principles in non-profit sport organizations as well.

Having in mind everything that has been mentioned previously, the following question appears as logical: Who makes strategic decisions in sport organizations, i.e. who is involved or should be in charge of strategic management process? Although organizations can employ an outside agency or an expert to implement strategic management activities, as expected, the executive board must be a part of the strategic planning process, but it “should also be part of the roles and responsibilities of any salaried professional” (Bayle et al. 2007:64) in any sport organization. Logically, executive board and the general assembly will be required to approve the strategic objectives, but the process should be coordinated and supervised by a senior board member or a strategic committee. However, according to Stiles (2001, cited in Ferkins, Shilbury & McDonald, 2005:198) boards fail to realise their potential in the strategic decision-making process. As an explanation, “the board’s role in strategic development may be impeded by tensions between, and a lack of clarity in, the relationship between the agent (paid staff) and the board” (Ferkins, Shilbury & McDonald, 2005:198-199). According to Bradshaw et al. (1992, cited in Ferkins, Shilbury & McDonald, 2005:200), “board members act mostly as trustees rather than entrepreneurs, and are largely risk averse.” Therefore, it is quite understandable that this task falls into the hands of one or two people in the organization. If those individuals are not well motivated and competent to enforce strategic management principles as a part of their everyday activities, one cannot expect to find these activities in majority of sport organizations, at least in Croatia.

Therefore, two basic aims of this research can be emphasized. The first one is to research into the existence of some basic strategic management activities in Croatian sport federations, and to evaluate the various aspects of sport federations concerning strategic management process (commitment and competency of executive board members). The starting hypotheses were:

- H1 - the majority (more than 50%) of national sport organizations do not apply strategic management activities (defining mission and vision statement);
- H2 - the commitment and competency of executive board members is low (below the average grade of 3).

## Methodology and results

A questionnaire developed by *Association Management, Consulting & Evaluation Services* for checking how well an organization engages in strategic management (AMCES, 2011) was adopted to suit the needs of this research. The questionnaire was sent to national sport federations as organizations in charge of the development of various sports. The population consisted of 80 sport federations which are members of the Croatian Olympic Committee (see HOO, 2011) and it encompassed 38 organizations from Olympic sports, 32 organizations of non-Olympic sports, as well as 10 organizations with a status of temporary or associated members. In total, 76 questionnaires were sent (4 organizations could not be reached either because of the wrong contact information, or because of the legal issues concerning the representation of sport in question), and 32 answers were received (42.1% response rate). On average, federations employ 2.5 paid professionals, but 5 of them do not employ any professionals, only volunteers. As discussed previously, determining the mission, vision and environmental analysis are one of the main activities of strategic management. As can be seen from Table 1, 75% of federations did not develop their mission statement, and about 69% have not formulated their vision for the future. Only one organization uses the SWOT analysis, and 8 are not even familiar with this term.

Table 1. Strategic management activities

	rf(%) <sup>*</sup>	95% CI <sup>†</sup>	P <sup>‡</sup>
<b>Mission statement</b>	75.0	57.9 – 86.8	0.005
<b>Vision statement</b>	68.8	51.4 – 82.1	0.033
<b>SWOT analysis</b>	96.9	84.3 – 99.5	<0.001

\* The percentage of the sample that do not have mission statement, vision statements and do not use SWOT analysis

† 95% confidence interval

‡ p-value of the chi-square test

The analyses based on confidence intervals, as well as the p-value of the chi-square test, lead to a conclusion that the hypothesis stating that the majority of national sport federations do not apply strategic management principles, cannot be rejected. We are 95% confident that out of all federations in Croatia, those that do not have mission statement will account to almost 58%, those that do not have vision statement will account to more than 51%, and finally, those not using SWOT analysis will account to more than 84%. Therefore we can say that the first hypothesis cannot be rejected.

Interviewees were also asked to grade some aspects of doing business in their federations. Here only the results concerned with the competencies and dedication of the executive board members are analysed (Table 2).

Table 2. Competencies and dedication of executive board members

	Valid N	$\bar{X} \pm s$	95% CI <sup>*</sup>	p <sup>†</sup>
<b>Dedication of the members of executive board</b>	32	3.4375 ± 0.8776	3.12 – 3.75	0.004
<b>Competencies of the members of the executive board</b>	31	3.5806 ± 1.0255	3.20 – 3.96	0.002

\* 95% confidence interval

† p-value for the significance of the difference between the observed mean of the sample and the hypothetical mean of the population from which the sample has been randomly drawn

The starting hypothesis was that the average grade concerning competencies and dedication of the executive board members will be lower than average, i.e. below 3. Therefore, the p-value as well as the analysis of the confidence intervals was conducted. As can be seen from Table 2, the hypothesis is rejected since it can be concluded that we are 95% confident that the average grade concerning dedication of the board members will be at least 3.12 and the grade concerning competencies will be at least 3.20.

## Conclusion

The paper shows that strategic management, although a process primarily developed for the needs of profit organizations, is more widely used in non-profit organizations as well. This implies the need to implement these activities in sport federations as well. However, since this is a process just starting to develop in Croatian sport federations, the question of who can conduct these activities arise. Although organizations can use outside companies to implement these activities for them, executive board members have to be the ones to at least monitor the process. For that purpose a research in

Croatian national sport federations was conducted. The results state that the majority of these organizations do not apply strategic management activities, but the grades concerning the competencies and motivation of executive board members to manage sport federations were above average. Since strategic management is becoming an essential part of activities of every organization, including non-profit sport organizations, Croatian national sport federations should make an effort to implement them into their everyday activities, if for no other reason, than at least because of the need for private funding. Acting in a strategic way will give a different picture of a federation for the potential sponsor, and therefore help achieve the federation's desired goals.

## References

1. AMCES (Association Management, Consulting & Evaluation Services) (2011). *Tools /online/*. <http://www.amces.com/resources.htm>, retrieved in January 2011.
2. Bartoluci, M. and Škorić, S. (2009). *Menadžment u sportu*. Zagreb: Odjel za izobrazbu trenera Društvenog veleučilišta u Zagrebu, Kineziološki fakultet.
3. Bayle, E., Duncan, J., Chappellet, J. and Kartakoullis, N. (2007). Managing Strategically. In: J. Camy and L. Robinson (eds.), *Managing Olympic Sport Organizations* (pp. 61-106). Human Kinetics.
4. Berrett, T. and Slack, T. (2001). A Framework for the Analysis of Strategic Approaches Employed by Non-profit Sport Organizations in Seeking Corporate Sponsorship. *Sport Management Review*, 2001, 4, pp. 21-45.
5. Buble, M. (2005). Uvod u strateški menadžment. U: M. Buble (ed.), *Strateški menadžment* (pp. 1-14). Zagreb: Sinergija nakladništvo.
6. Ferkins, L., Shilbury, D. & McDonald, G. (2005). The Role of the Board in Building Strategic Capability: Towards an Integrated Model of Sport Governance Research. *Sport Management Review*, 2005, 8, pp. 195-225.
7. Gedvilaitė-Moan, A. and Laskiene, S. (2010). Organizational Management Peculiarities of the Public Sector Referring to Sports as a Public Sector Example. *Inžinerine Ekonomika-Engineering Economics*, 21(1), pp. 90-98.
8. HOO (Hrvatski olimpijski odbor) (2011). *Nacionalni sportski savezi /online/*. <http://www.hoo.hr/1340-v-nacionalni-sportski-savezi.aspx>, retrieved in February 2011.
9. Parker, C. (2004). Strategy and environmental analysis in sport. In: J. Beech & S. Chadwick (eds.), *The Business of Sport Management* (pp. 213-239). Essex: Pearson Education Limited.
10. Thibault, L. and Slack, T. (1994). Strategic Planning for Nonprofit Sport Organizations: Empirical Verification of a Framework. *Journal of Sport Management*, 1994, 8, pp. 218-233.

## CHARACTERISTICS OF MANAGERS IN SPORT ORGANISATIONS IN CROATIA

Zlatko Hodak<sup>1</sup> and Marina Hodak<sup>2</sup>

<sup>1</sup>*TVT d.o.o., Zagreb, Croatia*

<sup>2</sup>*Ministry of Economy, Labour and Entrepreneurship, Zagreb, Croatia*

### Abstract

In defining sport management and management in general similar concepts appear. However, what makes sport management distinct are the unique features of sport. This consequently requires managers who possess specific knowledge in the field of sport necessary for ensuring the survival and development of sport organisations. Another necessary element is the coordination and synchronisation of business activities between all levels of management in a sport organisation. Since quality human resources are crucial for the success of sport organisations, this function of management should be given special attention. The formation of successful sport teams is a long-term process that requires precise planning on the part of the manager where a particularly important role is given to strategic management. The success of management in sport organisations depends on its ability to implement the functions of management: planning, organising, managing human resources (staffing), directing and controlling.

**Key words:** *sport management, sport organisations, managers in sport*

### Introduction

The aim of this research is to **analyse characteristics of managers in sport organisations in Croatia**. To reach this aim the following hypotheses were formulated: **(H1) Managerial positions in sport organisations are held by people who have significant experience in sporting activities; (H2) The amount of time that managers spend on a particular function of management in sport organisations does not differ significantly from that spent by managers in business organisations**. The methodology consisted of primary and secondary researches and included the following mechanisms: descriptions, analyses and syntheses. Moreover, descriptive statistics were used to determine the relevant data of the research. Furthermore, a survey by questionnaire intended for sport clubs was employed in the primary research.

**In the development of sport a special role is held by sport organisations** out of which the dominant are sport clubs that gather people in order for them to play sports, participate at sport competitions and promote certain types of sport. According to a November 2004 Eurobarometer survey in the most developed EU countries “approximately 60% of European citizens participate in sporting activities on a regular basis within or outside some 700,000 clubs, which are themselves members of a plethora of associations and federations” (EU Commission, 2007:3). Data from the 2006 Statistical Yearbook of the Republic of Croatia show that in Croatia there are 3,543 sport organisations with 277,165 active members which equals to 6% of the total population of Croatia. The main model of management in sport organisations in Croatia is management of non-profit organisations. This means that the primary business goal of sport organisations is not profit. Article 5 of the Associations Act (NN.nb.88; 2001) states that an organisation can conduct activities by which it achieves goals determined by its statute, **but not for gaining profit for its members or third persons**. If an association in conducting its activities makes a profit, this **profit must be used exclusively for conducting and improving its activities**. Although the Sports Act allows it, potential investors did not have any interest in investing capital into sport organisations in order to become their owners and receive return on invested capital through dividends. One of the possible reasons is that investors do not see the market and financial potential of sport organisations. Another reason could be that the existing management structure and stakeholders in sport organisations do not want such changes because they consider the existing model satisfactory.

### Characteristics of managers in sport organisations in Croatia

The emergence of management in sport is closely related to the development of sport and sport industry. A major role in the development of sport is played by the development of sport clubs, different tournaments and leagues in which clubs compete. The increase in the number of clubs and competitors as well as the organisation of sport tournaments required appropriate management that would adequately organise sport and sport competitions. The difference between sport management and management in general can be found in the unique features of sport where sport management is seen as a phenomenon of the modern society. Stewart and Smith list the following unique features of sport (Stewart, Smith, 1999:87-89):

- Sport as a phenomenon stimulates **irrational passions** for sport clubs, athletes or competitions.
- Unlike business companies **sport favours other demands and goals such as winning a league, providing services to interest groups or club members.**
- **Competitive balance is different for sport organisations** as opposed to business organisations. In sport, clubs and sport teams need competition to stay in business, in other words they have to cooperate in the division of income and playing talent.
- **A sport product realized as a game or competition is of variable quality.** This means that, as opposed to business organisations that have to offer constant product quality on the market, in sport the quality of a sport product is unpredictable and variable.
- Sport also enjoys a high degree of **product or brand loyalty** with its fans.

It is these **unique features of sport that affect the specificity of sport management.** In order for a sport organisation to plan its activities with more quality it is necessary to determine both sport and business goals which are intertwined. Therefore, their realisation requires a quality coordination of all functions of management. Sport management is a process in which the organisation's goals are achieved with the help of coordination of other people's activities. Good management of an organisation has to ensure that the board of directors and the management try to achieve the results favourable for the organisation and its members. It also has to ensure that the means of achieving these results are efficiently monitored.

A **survey by questionnaire** was conducted as a method for gathering data on the specificities of management in sport organisations in Croatia. **Surveying** was conducted through mail. Furthermore, a statistical software package IBM SPSS 17.0 (Statistical Package for the Social Sciences) as well as descriptive statistics was used for analysing research data. The sample used for the empirical research is a convenient sample. In the research were included **sport clubs in Croatia and their male sport teams at the highest competition level.** The following types of sport clubs were part of the research: **football, handball, basketball, water polo and volleyball clubs.** The research involved 61 sport organisations: 18 were football organisations, 15 basketball organisations, 12 handball organisations, 9 volleyball organisations and 7 water polo organisations. The questionnaire was addressed to 61 **presidents and directors of clubs.** The return rate was 42%, namely 26 sport organisations answered and returned the questionnaire.

Table 1. The number of surveyed sport organisation according to sport type and return rate

Sport	Number of surveyed sport organisations	Number of returns	Return rate (%)
Football	18	9	50
Basketball	15	5	33
Handball	12	2	17
Volleyball	9	6	67
Water polo	7	4	57
Total	61	26	43

The realisation of the primary research was obstructed by certain phenomena that posed **limitations in the research:** the unwillingness of managers in sport organisations to participate in research of this type (insufficient number of returns) which highly affects the representativeness of the sample; the opinion of a certain number of managers that the information required for the questionnaire is a business secret; costs and time invested in the research. Furthermore, there were some **methodological limitations:** the impossibility to examine the bias in the obtained sample (the term bias refers to the real differences between those who responded and those who did not); the impossibility to determine the representativeness of the sample despite the fact that the return rate achieved is high for this type of research approach and that the sample of 42% was obtained with respect to the number of clubs contacted (61). This limits the possibility of a generalisation of the results. The research results that refer to the **professional qualifications and experience in sporting activities** of the respondents are listed below.



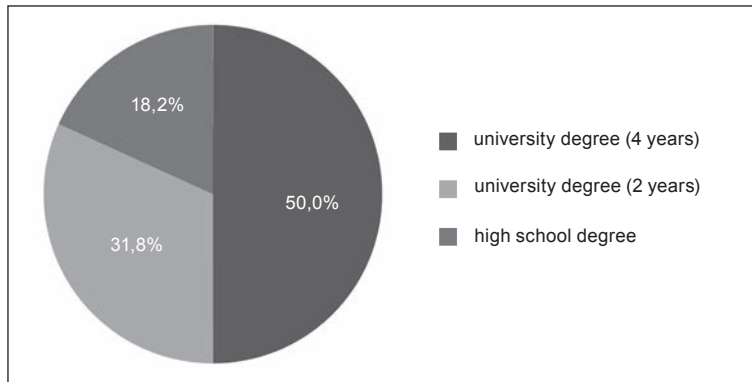

Source: Survey conducted on a sample of sport organisations, February, 2011; data processed by author

*Graph 1. Respondents' professional qualifications*

Data about professional qualifications show a high percentage of highly educated managers in sport organisations. As much as 50% have a 4-year university degree, 31.8% have a 2-year university degree and 18.2% have a high school degree. These data change the often present public perception that sport organisations are managed by people who are not adequately educated.

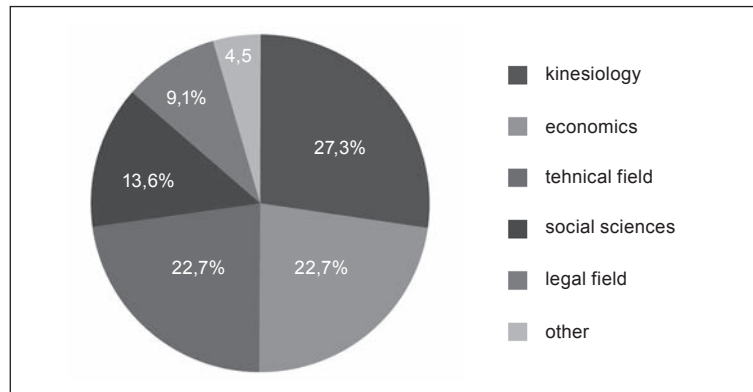

Source: Survey conducted on a sample of sport organisations, February, 2011; data processed by author

*Graph 2. Respondents' educational structure*

Graph 2 shows the educational structure of managers in sport organisations. The most represented educational fields are kinesiology (27.33%), economics (22.72%) and the technical field (22.72%). This leads to the conclusion that the highest percentage of managers in sport organisations does not have any formal education in the field of management and that they have acquired their knowledge in other fields.

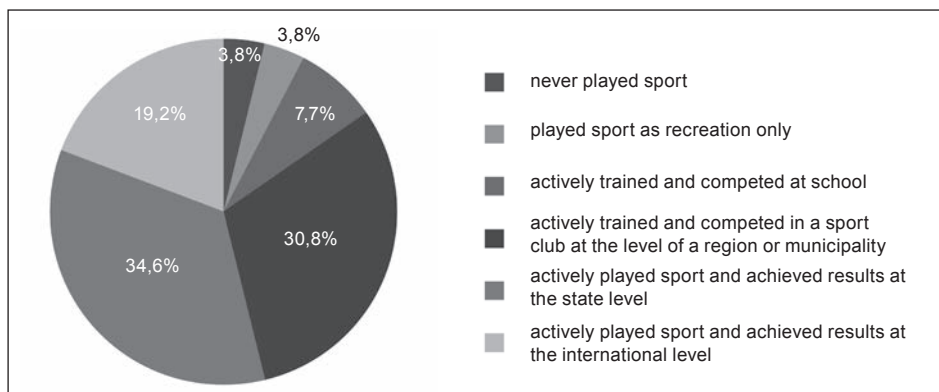

Source: Survey conducted on a sample of sport organisations, February, 2011; data processed by author

*Graph 3. The respondents' experience in sporting activities*

Graph 3 shows that 96.2% of respondents, out of which 92.39% actively, played sport. There is a fairly high percentage of respondents that played sport and achieved results at state or international level (53.85%). Based on these indicators it can be concluded that a high percentage of managers in sport organisations have expertise in the field of sport which is their advantage in performing managerial activities. **These indicators validate the first hypothesis of this research.** The research results shown below demonstrate the amount of time managers spend on particular functions of management during their work in sport organisations.

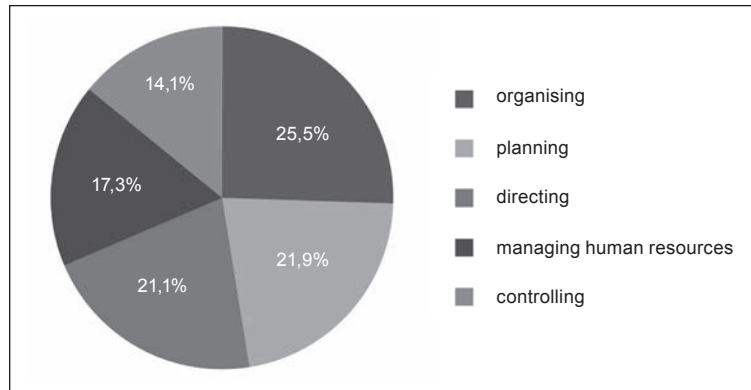

Source: Survey conducted on a sample of sport organisations, February, 2011; data processed by author

Graph 4. The amount of time general managers spend on particular functions of management

From Graph 4 it is evident that managers in sport organisations spend the largest amount of time on the functions of organising and planning, while they spend the smallest amount of time on the functions of managing human resources and controlling. With regard to organising and planning the obtained data do not differ from the present theoretical insights about the amount of time spent on particular managerial functions. Present scientific insights shows that executive directors and general managers spend more time planning long-term goals, organising the total formal organisational structure and controlling the performance of the organisation. **The presented results validate the second hypothesis of this research.**

When asked whether they completed some form of education or training in the field of management during their career outside of the field of sport, as much as 80.80% of the respondents said no. When asked whether they completed some form of education or training in the field of management during their career in the field of sport, the respondents depicted an even graver situation since only 7.7% of managers attended education in sport management.

## Conclusion

Managers have a **key role in the work and business activity of sport organisations.** The research shows that sport organisations in Croatia have managers with **significant experience in sporting activities** and that general managers in sport clubs spend approximately the same amount of time on the functions of management as do those in business organisations. The research also shows a low level of additional training in the field of management. However, to increase the success of sport organisations it is essential to ensure a constant training of managers in order to improve sport and business processes. Trained managers will be able to create an optimal model of management in sport organisations with the goal of achieving quality sport and business results.

## References

1. European Commission. *White paper on sport*. COM (2007) 391 final. Bruxelles.
2. Stewart, R. and Smith, A. "The special features of sport." *Annals of Leisure Research*. 2 (1999): 87-89.
3. "Zakon o udrugama." *Narodne novine*. 88 (2001).

## INTEGRATIVE MARKETING MANAGEMENT AND ITS POSSIBILITY TO APPLY IN SPORT

**Ivan Novak**

*University of Zagreb, Faculty of textile technology, Zagreb, Croatia*

### Abstract

This paper explores the possible conceptual consolidation between concept of integrated management and marketing concept. It provides an overview of fundamental marketing concept principles as well as integrated management principles. Leaning on BSI definition of integrated management implementation of marketing approach into management processes is natural. So, the new concept, determined as “integrative marketing management” should be, in short, marketing concept with integrated management implemented in all process of some organization. Such concept can be very efficient because of characteristics of integrated management and marketing approach, all in one. Implementing this kind of concept into sport can improve sport enterprise as well.

**Key words:** *integrated management, marketing concept, integrative marketing management, sport*

### Introduction

Business enterprises on contemporary markets are exposed to numerous threats and various conditions. So, it is obvious that all kinds of businesses and companies including the ones in sport field of activity operate in the inconsistent market. The conceptual approach has become more necessary than ever for all businesses. All enterprise units take care of the product, price, promotion of companies or products and services, distribution, market analysis, as well as other significant marketing and management factors. Since sport industry is a very specific business area with certain sensitivity, especially to population buying power, demand and price elasticity, enterprise units within sport industry are forced to take into consideration all marketing and management factors. Thus, companies in sport field of activity should act according to economic situation (not only national but global as well) and market conditions. For these reasons, modern companies should approach the systematic planning of operations by implementing different techniques and methods such as marketing concept and/or integrated management.

### Objective and purpose

The main objective of this paper is to explore possible conceptual consolidation between concept of marketing and integrated management. The main purpose of this paper is to interpolate *integrated management* (IM) within *marketing concept* (MC) which makes *integrative marketing management* (IMM) with a new approach and different definition of IMM. According to the objective and purpose of this paper the hypothesis was set.

**Hypothesis 0:** Concept of IM is not incompatible with the concept of marketing, and conceptual consolidation of concepts IM and MC can make *integrative marketing management* (IMM) with a new approach, and possible application in sport field of activity.

### Methodology

In this paper some *methods of scientific research* are used as follows: *systematic observation, descriptive and causal method, inductive and deductive method, methods of analysis and synthesis* (Mužić, 1979; Mill, 1885; Zelenika, 2000) and *desk research* in order to *analyze, describe and conclude*.

### Marketing concept vs integrated management

The paper faces two concepts - marketing concept and integrated management concept (by BSI, CQI and KQMC), not because to be confronted but to consolidate them.

## Marketing concept

There are many understandings of marketing and what marketing concept includes. “Marketing is the activity, set of institutions, and processes for *creating, communicating, delivering, and exchanging offerings* that have value for customers, clients, partners, and society at large.” (AMA, 2007) Similarly, after Ph. Kotler (2001) definition implies marketing as “the social process by which individuals and groups obtain what they need and want through creating and exchanging products and value with others”. In fact, marketing concept (MC) includes *conceptual and strategic planning, analytic marketing system, market research, product planning, market analysis, merchandising, sales and distribution, after-sales service to consumers, price planning, various promotional activities* (Kotler & Keller 2006) and much more. “Marketing, in addition to being a business orientation, is a concept and business philosophy, group of activities and business process management. The process of marketing means a connected series that integrates company objectives and resources in accordance with the conditions and opportunities in the environment.” (Previšić, J. & Ozretić Đ, 1999) Through the presented approaches it is possible to identify some basic features and views of marketing as *business concept, business functions and economic processes*. (Novak, 1996) Marketing is a *business concept, because it rests on the concept of demand, the concept of its satisfaction, product concept and concept of exchange, concept of markets and concept of a marketer* (participants). Marketing has a systematic approach to the function of the set goal, which is based on business function: *identification, anticipation (prediction) and anticipative expectations, defining and meeting the demand*. Also, marketing is a business concept that is universal, because you can “apply it in all enterprises regardless of size, industry or country of origin”. (Previšić, J. & Ozretić Đ, 1999) Of course marketing has its application in both – profit and nonprofit organizations which connect marketing conception (MC) with sport, not only as business activity. However, as public sector organizations and not-for-profit organizations adopt the concept of marketing, this need is not always the case (MarketingTeacher, 2011). The modality of establishment of a logical connection between the key concepts of IM and MC is that MC creates plans that affect the future of the company and also puts significant emphasis on possible business effects. Therefore, the current terms and conditions set in accordance with the MC may serve as a starting point from which further concepts of IMM planning can be established.

## Integrated management

Modern business and its environment put many challenges in front of organizations. So, it is necessary to have a well laid down system which company resources can effectively and efficiently aligned and applied in line with organization objectives. “Integrated Management is the *understanding and effective direction* of every aspect of an organization so that the *needs and expectations of all stakeholders are equitably satisfied* by the best use of all resources.” (Dalling, 2007) “An integrated management system is a management system that integrates all of an organization’s systems and processes into one complete framework... Instead of “silos”, you have a *genuinely co-ordinated system*: one that is greater than the sum of its parts. An integrated system provides a *holistic picture of all aspects of some organization...* An IMS allows to create one structure that can help to effectively and efficiently deliver an organization’s objectives. From *managing employees’ needs to monitoring competitors’ activities, from encouraging best practice to minimizing risks and maximizing resources*, an integrated approach can help an organization to achieve their objectives.” IM also helps organizations to *improve business focus, set a more holistic approach to managing business risks, has less conflict between systems and reduces duplication and bureaucracy*. Integrated management takes account of six common requirements for management systems – *Policy, Planning, Implementation & Operation, Performance Assessment, Improvement, and Management Review* (BSI, 2006). Also, it is important to point out that integrated management system is connected with *ISO set of generic management system standards*. These affect organizations to set and achieve their objectives and operating structure. Namely, some companies recognized the important role of ISO standard, which contributed to company success as part of IMS (See Figure 1) .

Shown IMS has three main success factors – quality management system, some set of generic management system standards and effective environmental management system. Integrated management system structured in this way can address many challenges associated with business operation and maximizes business performance.

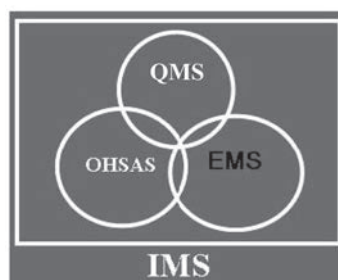

Figure 1. KQMC Integrated Management System (IMS)

## Integrated marketing management (IMM) – research

The results in Table 1 show that the term “Integrated marketing management” was displayed 59 times out of 1497 pages, but only 7 times there was a real connection with the specific term. All other displays were or wrong (in manner and purpose of this paper) or duplicate of those 7. This is important because of the definition of IMM and its practical market use. It is very important that on 17 web providers (Google scholar, Hrčak, amazon.com, bookdepository, bookfinder, buybook, barnes&noble, bookbrain, flipcart, books-a-million, alibris, quirksmode, buy, halfbyebay, ebay, ecampus and mhprofessional) search was not matched not even one real match with the term IMM, neither for articles nor for books or any other kind of connection with IMM. These results direct us on efforts to define the term Integrative marketing management (IMM). According to circumstances, it would be practical to use the meanings and approaches found on web.

Table 1. Search results

Search provider	Term	No. of displayed pages	No. of displayed match addresses	No. of IMM	Real No. of IMM
Google	IMM	100	31	35	7
Google	Definition of IMM	100	1	1	0
Google scholar	IMM	100	0	0	0
Google scholar	Definition of IMM	100	0	0	0
Yahoo	IMM	100	17	22	0
Yahoo	Definition of IMM	100	1	1	0
Other (17) providers	IMM	897	0	0	0
<b>TOTAL</b>		<b>1.497</b>	<b>50</b>	<b>59</b>	<b>7</b>

Source: Original research

The firm “MarketingPilot software” developed softwares for firms that want or need advanced marketing management tools. It contains “management tool for mid-size direct marketers, with features *for project management, list and media buying, source code tracking, expense capture, and vendor management*. This integrated marketing management software *coordinates marketing activities across any number of channels, enables B-B and B-C marketing and improve the ROI of multi-channel campaigns*. The firm “Aprimo” also developed software based on Integrated Marketing Management. Their promotion for that software lean on two recent reports from Gartner Inc. which “discuss the important evolution toward IMM and focus on how *to develop an integrated marketing strategy*, which components to integrate in marketing, *key success factors for achieving ROI*, and *how to successfully align processes*.” Also, “by 2014, companies that develop an IMM strategy will deliver a 50% higher Return on Marketing Investment (ROMI) than those who do not.” (Aprimo, 2011) The firm “Teradata” through their analysis points out what they understand under the term integrated marketing management – it is a solution that *includes campaign management, marketing resource management (MRM) and analytics*, with a wide range of business-to-consumer and business-to-business companies.

The final example shows the approach of IMM in sport through International Speedway Corporation (ISC). As predicted by Arthur, L. (2011) “integrated marketing management is rapidly gaining steam as one of the year’s hottest marketing topics – and for good reason. An IMM strategy can *increase ROI by improving performance across multiple business functions*, and companies that use an integrated approach are beginning to report impressive results. If you are interested in a case study, take a look at how International Speedway Corporation (ISC), the world leader in motorsports entertainment, used IMM to transition from old-school mass marketing to targeted, innovative and compelling fan experiences both on and off the racetrack.”

All these rare examples show that integrated marketing management is not a clearly defined term even though they (companies) use IMM in their business on daily basis and for their software products. So, integrated marketing management is not often in wide common use, as a concept.

## Comparative table instead of discussion

It is possible to establish a logical connection between key concepts of IM and marketing concept through IMM. Following the phrase that “picture speaks more than 1000 words” a comparative table was set up.

Table 2. Comparative table of MC, IM and IMM

Marketing Concept	Integrated Management	Integrative Marketing Management
conceptual and strategic planning	holistic picture of all aspects of some organization	develop an integrated marketing management strategy
analytic marketing system	understanding and effective direction	
business philosophy	less conflict between systems, reduced duplication and bureaucracy	improving performance across multiple business functions, "speed your company"
business concept, business functions and economic processes	system that integrates all of an organization's systems and processes in to one complete framework; ISO set of generic management system standards	successful align of processes
concept of demand, satisfaction, exchange, markets and marketer and product concept	quality management system, effective environmental management system	project management, coordinates marketing management activities across complete business operation, marketing resource management (MRM) and analytics
identification, anticipation (prediction) and anticipative expectations, defining and meeting the demand	Planning, Implementation & Operation, Performance Assessment, Improvement, and Management Review	
market research & analysis, procurement, funding	encouraging best practice to minimizing risks and maximizing resources	improve the ROMI of multi-channel campaigns & success factors for achieving ROMI,
creating, communicating, delivering, and exchanging offerings	effectively and efficiently deliver an organization's objectives	
merchandising, sales and distribution, research to sales	improving business focus & managing business risks	development of qualified sales opportunities enables B-B and B-C marketing, expense capture, vendor management, campaign management
product & price planning, promotional activities	genuinely co-ordinate system	
after-sales service to consumers	needs and expectations of all stakeholders are equitably satisfy	corporate identity within their target market & stakeholders
internal marketing, personnel	managing employees' needs	internal marketing management

Source: Original research

## Conclusion

From the above mentioned arguments it follows that the concepts of marketing and integrated management are mutually dependent. While IM deals primarily with the effects of an advanced business event by creating procedures to maintain functionality, the concept of marketing serves to provide a proper context for the optimal design and implementation of those procedures. Analyzing the presented arguments, there is no doubt that it is possible to establish a logical connection between IM and marketing concept, creating a new approach of integrated marketing management (IMM).

Also, through very rare examples of using the term, approach and concept of IMM (even though it is not precisely defined and the steps and methodology are unknown) inside sport field of activity, it is a great surprise. The presented example shows the implementation of integrated marketing management in sport through International Speedway Corporation (ISC). IMM strategy *increased ROI by improving performance across multiple business functions*, and companies that use an integrated approach are beginning to report impressive results. Under these conditions the meaningful difference between the terms "integrative" and "integrated" (refers to search results and usage of the term by companies) lose any significant influence. This is the reason why the term "integrative" has been chosen.

Finally, according to relevant arguments that match the main objective and purpose of this paper, and also match the set hypothesis, it is possible to conclude that the set hypothesis is proved.

**Hypothesis 0:** Concept of IM is not incompatible with the concept of marketing, and conceptual consolidation of concepts IM and MC can make *integrative marketing management* (IMM) with a new approach, and possible application in sport field of activity is proved.

## References

1. American Marketing Association (AMA). (2007). *AMA Definition of Marketing* /on-line/. Retrieved May 20, 2011 from: <http://www.marketingpower.com/Community/ARC/Pages/Additional/Definition>
2. Aprimo.com. (2011). *Integrated marketing management* /on-line/. Retrieved May 22, 2011 from: <http://sites.aprimo.com/IMM/Landing/ashx>
3. Arthur, L. (2011). *International Speedway Corporation Races Ahead With Integrated Marketing Management* /on-line/. Retrieved May 23, 2011 from: <http://blogs.forbes.com/lisaarthur/2011/04/13/international-speedway-corporation-races-ahead-with-integrated-marketing-management/>

4. Dalling, I. & Chartered Quality Institute (CQI). (2007). *Integrated Management Definition* /on-line/. Retrieved May 15, 2011 from: <http://www.thecqi.org/Documents/community/IM.SIG/CQI.IMSIG.Integrated.management.definition-Issue2.1.pdf>
5. Kaizen Quality Management and Engineering Consultant (KQMC). (2011). *Integrated Management System (IMS)* /on-line/. Retrieved May 22, 2011 from: [http://www.kqmc.net/Files/services\\_IMS.html](http://www.kqmc.net/Files/services_IMS.html)
6. Kotler, Ph. & Keller K.L. (2006). *Marketing Management*. 12<sup>th</sup> ed. New Jersey: Pearson Education.
7. Kotler, Ph. (2001). *Upravljanje marketingom*. 9<sup>th</sup> ed. Zagreb: Mate.
8. MarketingPilot.com. (2011). *Integrated marketing management* /on-line/. Retrieved May 22, 2011 from: [http://www.marketingpilot.com/products/product\\_intro.shtml](http://www.marketingpilot.com/products/product_intro.shtml)
9. MarketingTeacher.com. (2011). *What is Marketing?* /on-line/. Retrieved May 22, 2011 from: <http://marketingteacher.com/lesson-store/lesson-what-is-marketing.html>
10. Mužić, V. (1979). *Metodologija pedagoškog istraživanja*. 2<sup>nd</sup> revised ed. Sarajevo: Svjetlost.; Mill, J.S. (1885). *System der deduktiven und induktiven logic*. 2<sup>nd</sup> ed. Leipzig: Fues.; Zelenika, R. (2000). *Metodologija i tehnologija izrade znanstvenog i stručnog djela*. 4<sup>th</sup> ed. Rijeka: Ekonomski Fakultet.
11. Novak, I. (1996). *Primjena marketinga u razvoju hrvatskog sporta*. Master thesis. Zagreb: Faculty of Economics & Business.; Novak, I. (2006). *Sportski marketing*, Zagreb: Maling.
12. Previšić, J. & Ozretić-Došen, Đ. (1999). *Međunarodni marketing*, 1<sup>st</sup> ed. Zagreb: Masmedia.
13. The British Standards Institution (BSI). (2006). *Specification of common management system requirements* /on-line/. Retrieved May 17, 2011 from: <http://www.bsigroup.com/en/Assessment-and-certification-services/management-systems/our-services/Integrated-management/>
14. The British Standards Institution (BSI). (2006). *What is Integrated Management System?* /on-line/. Retrieved May 17, 2011 from: <http://www.bsi-emea.com/Integrated+Management/Overview/index>.

## PROMOTION AS A TYPE OF COMMUNICATION IN SPORTS MARKETING

Darija Omrčen<sup>1</sup> and Mato Bartoluci<sup>2</sup>

<sup>1</sup>*Faculty of Kinesiology, University of Zagreb, Croatia*

<sup>2</sup>*School of Economics and Business, University of Zagreb, Croatia*

### Abstract

The aim of the analysis was to identify how well the subjects, 80 third-year students with the Faculty of Kinesiology (University of Zagreb, Croatia) understood the messages of four advertisements. Their guesses about who the athletes in advertisements were as well as their understanding of the messages of advertisements can be regarded as satisfactory. Gender showed to have some impact both on recognising the athlete and on understanding the messages of advertisements only in the case of two advertisements. The students who actively participated in individual sports were better in recognising the athlete in one advertisement (the athlete whose image was in this advertisement also participated in an individual sporting activity) than those who actively participated in team sports. The number of years of learning English did not have any relevance for understanding the text of the messages written in the English language. Neither gender nor sport category participation proved to be relevant as regards whether the subjects did or did not surf the Internet or as regards the language in which the web sites that they visited were written.

**Key words:** *language, advertisement, message, athlete, text, sports marketing*

### Introduction

Promotion is a type of communication. Hence, it follows the principles of all types of communication in that it subsumes the existence of a sender of a message, channels through which this message is sent, a receiver of this message, the message itself and the code in which it is formed. In this sense, promotional advertisements are considered as the means of communication between a sender, i.e. a service renderer or a product manufacturer, and a recipient, i.e. a prospective buyer or a user of services. Promotion of sports products and sport-related services in Croatian sport and sports tourism has already been analysed (Bartoluci & Omrčen, 2003, 2005) together with communication in management in sports tourism (Omrčen, 2008a, 2008b). Advertising has many forms, and printed advertisements in newspapers, magazines and various brochures are only one of the ways in which either a product or a service can be presented in the market. Several elements are important when designing an advertisement – the visual aspect, the verbal aspect, connection between a product or a service advertised and the actual message sent, etc. In other words, any promotional material must have a satisfactory level of quality (Weber, Vrdoljak-Šalamon, & Boranić, 1994; Weber, Vrdoljak-Šalamon, Tarlow, & Boranić, 1996) to be able to achieve the desired effect.

Advertisements are designed with regard to the group of prospective customers that they are aimed for. Advertisements differ as regards their style, contents, etc. However, they all possess one common aim and that is to persuade a prospective consumer to buy an advertised product. To be able to do that, the message sent must be understood by its recipients. Marketing experts operating within any management structure use various ways of designing promotional messages that will attract as many prospective buyers of a product as possible. Famous athletes are recognised to have a higher market value, so that their image is connected with success. Consequently, images of well known athletes are put in advertisements, advertising either a sports product or service or advertising some other product or service that need not necessarily have anything to do with sport, in order to relate the image of this particular successful athlete with the image of a potentially successful product or service.

Any natural language can be regarded as a communication system and can be used as the object language by promotional messages. The message of the whole promotional advertisement can also be regarded as a means of communication; however, it is double-coded (Omrčen, 2009). Naturally, if any text is used in an advertisement, then the understanding of this text depends on understanding the language in which this text is written. The textual part of an advertisement should, as any promotional message, leave an imprint in the consciousness of a consumer, this imprint being necessary for making a decision to buy a particular product (Omrčen, 1998). In other words, each promotional message contains a *Theme*, i.e. it involves the reference to a message's point of departure (Halliday & Matthiessen, 2004), and a *Rheme*, i.e. the environment of the remainder of the message (Halliday, 2005, p. 62). The text must be clear and easy to remember, and it should express, either directly or indirectly, the basic idea of the whole promotional message. The messages should therefore possess "a catalyst effect in boosting sales volume" (Cheung, 2011).



The aim of the analysis in this paper was to analyse whether the athletes whose images were used in three analysed advertisement were recognised by the subjects and whether the subjects understood the messages intended to be sent by each of the four advertisements. Another aim was to determine whether the number of years of learning the English language, the fact whether the subjects surfed the Internet and the language of the web sites that they visit when surfing the Internet affected the understanding of the message as a whole.

## Methods

The analysis has been done on a sample consisting of 80 third-year kinesiology students (41 male and 39 female) with the Faculty of Kinesiology University of Zagreb. They were all native speakers of Croatian and learned English as a foreign language. The subjects were first asked to guess who the athletes in the advertisements AD1, AD2 and AD4 were. Correct guesses were scored 2 and incorrect 1. AD3 was not considered in this respect since it did not contain the image of an athlete. After that they were asked to say what the advertisements advertised (correct – 2; incorrect – 1). One of these advertisements was published in a weekly sports magazine (AD1) and the text of the advertisement was written in English. The second one (AD2) was printed in a brochure published on the occasion of a world-level competition held in Croatia. It contained no text except for the name of the company it advertised. The third advertisement (AD3) was published in a monthly tourist magazine published in the Croatian language; however, the text of the advertisement was written in English. The fourth (AD4) was published in a Croatian daily newspaper. This last advertisement had no text except for the name of the product advertised. The advertisements AD1, AD2 and AD4 used the images of well known athletes, whereas AD3 used the image of sea coast viewed from a cliff and bike-riding tourists visiting this area. In other words, each advertisement used a sport-related image (either an image of an athlete or the image showing a sporting activity). AD1 and AD4 were originally printed in black and white, whereas the other two were printed in colour. Since the questionnaires filled in by the subjects were printed in black and white, the advertisements were shown to the subjects on a PowerPoint slide, so that the subjects could observe them in their original form (black and white or colour).

The number of correct and incorrect guesses regarding what each of the four advertisements advertised was expressed in percentages. *Gender and sport category participation* were regarded as variables in the chi-square test ( $p \leq 0.05$ ) that served to observe the differences between two segments in each of them: *male – female* (51.3 and 48.7%, respectively) and *team – individual sport* (65 and 35%, respectively), with respect to the following two dependent variables: 1) *correct and incorrect guesses of who the athlete in the advertisement was* (for AD1, AD2 and AD4), and 2) *correct and incorrect guesses of what the advertisement advertised* (for all four advertisements). Since the text in two of the analysed four advertisements was in English, the number of years of learning the English language served as a dependent variable in the Mann-Whitney U test ( $p \leq 0.05$ ) which was used to identify any differences between correct and incorrect guesses of what the advertisements AD1 and AD3 advertised. This was done in order to find out whether the length of learning the English language affected the understanding of the message of advertisements. For these two advertisements, i.e. AD1 and AD3, the chi-square test was also performed ( $p \leq 0.05$ ) for two further dependent variables – *surfing the Internet* (*yes – 91.3%; no – 8.7%*) and *the language in which the web sites visited were written* (*English – 51.3%; Croatian – 21.3%; English and Croatian – 16.2%; English, Croatian and German – 2.5%; none – 8.7%*). *Gender and sport category participation* (*team/individual*) were again used as independent variables.

## Results

The percentage of subjects who did not recognise the athletes whose images were in the advertisements ranged from 3.8 for the athlete in AD2 to 30.0% for the athlete in AD1 (Table 1). As already said, AD3 was not considered in this respect since it did not contain the image of an athlete.

Table 1. Percentage of correct and incorrect guesses regarding who the athletes in advertisements were

AD1		AD2		AD4	
C %	I %	C %	I %	C %	I %
70.0	30.0	96.2	3.8	83.8	16.2

Legend: C – correct; I - incorrect

The percentage of subjects who did not recognise what each of the four advertisements – AD1, AD2, AD3 and AD4 – was supposed to advertise was 26.2, 3.8, 38.8 and 15% (Table 2), respectively.

Table 2. Percentage of correct and incorrect guesses regarding what the advertisement advertises

AD1		AD2		AD3		AD4	
C %	I %	C %	I %	C %	I %	C %	I %
73.8	26.2	96.2	3.8	61.2	38.8	85.0	15.0

Legend: C – correct; I - incorrect

Regarding the first dependent variable, the difference between the male and female subjects and their correct guesses of who the athlete in AD1 was showed to be significant –  $\chi^2(1, N=80)=9.46, p=.002$ , i.e. men more frequently recognised the athlete in AD1. However, no statistically significant difference between genders was found to exist for AD2. The difference did exist for AD4 –  $\chi^2(1, N=80)=4.09, p=.043$ , i.e. female students were better in recognising who the athlete in AD4 was.

As for the sport category participation, the subjects who actively participated in individual sports were better in recognising the athlete in AD1 than those who actively participated in team sports –  $\chi^2(1, N=80)=11.40, p=.001$ . Such a difference was not found to exist either for AD2 or for AD4.

Regarding the dependent variable *correct and incorrect guesses of what the advertisement advertised*, female subjects were better in understanding the message of AD1 and AD4 than their male peers –  $\chi^2(1, N=80)=4.64, p=.031$  and  $\chi^2(1, N=80)=5.82, p=.016$ . *Sport category participation* was not found to be a discriminating factor between its segments.

As for AD1 and AD3 whose texts were written in the English language, Mann-Whitney U test showed that the number of years of learning English did not have any relevance for understanding the messages of the advertisements written in the English language. The chi-square test, performed for AD1 and AD3, showed no differences between the two genders and between the two sport categories either as regards the fact whether the subjects did or did not surf the Internet, or as regards the language in which the web sites that they visited were written in.

## Discussion and conclusions

The analysis in this paper has shown several important facts. First there is the fact that using the images of well known athletes is to be considered rather successful as regards the actual recognising of an athlete and understanding of the message intended to be sent by an advertisement. Connecting the name of an athlete and the product advertised may help remember the basic message of e.g. a commercial (Omrčen, 1995). Shank says (2002, p. 367) that athletes' persuasive power to persuade the target audience and move them toward purchase "stems from their credibility and, in some cases, attractiveness". Attractiveness implies not only physical beauty, but it seems to operate within another dimension which is nonphysical and which is based on personality of an athlete, on his/her lifestyle and intellect (Shank, 2002, p. 367). This is in compliance with the analysis which have shown that a promotional message persuades using peripheral paths, namely, it uses eristic argumentation in that it addresses the emotions of target audience and the sender of such a message tries to use everyday speech to shorten the distance between himself and the recipient (Maslač, 2007).

Secondly, men recognised the athlete in AD1 more frequently than women, whereas women recognised the athlete in AD4 more frequently than their male peers. Could these results be attributed to the fact that the athlete recognised more frequently by men than by women was a male athlete who participated in a sporting activity dominated exclusively by men, whereas the athlete recognised more frequently by women than by men was a female athlete who, however, participated in a so called *gender-neutral* sporting activity? It seems unlikely that the intention of people who designed the advertisements was to address either the population of men or the population of women, because both products advertised were not and are not used exclusively by one of the genders.

Additionally, the subjects who actively participated in individual sports were more successful in guessing who the athlete in AD1 was. This finding is interesting due to the fact that the athlete whose image was in the advertisement actually participated in an individual sporting activity. However, whether this was just a coincidental result cannot be justified with certainty since no other supplementary factors were used in this analysis that could substantiate it.

Regarding the understanding of the whole advertisement, the female subjects were better than men when it came to understanding the message of AD1 and AD4. The reason why they understood the message of AD4 better may be said to be connected with the fact that they also recognised the athlete in the advertisement more frequently than their male peers. However, the better understanding of the message of AD1 obviously depended on the comprehension of the text of the message which is in compliance with research results that substantiate the opinion that women are better in verbal skills than men (Sabbatini, 1997/2000; Du, Weymouth, & Dragseth, 2003; Kiefer & Shih, 2006). Although this opinion has been strongly challenged by other researchers (e.g. Cameron, 2007), it seems that superiority in understanding the verbal message was decisive in understanding the message of the whole advertisement.

The number of years of learning the English language had no impact on understanding the messages of two advertisements – AD1 and AD3 – which contained a text written in English. This could mean two things – either that

the text was not difficult to understand or that the time span of learning a foreign language is not always decisive in this respect. This may be the consequence of many factors, some of them being that the knowledge of English from elementary and/or secondary school or both was poor, that it is the interest in a particular topic that is a decisive factor in understanding a text in a foreign language and not the duration of learning of a foreign language, that the duration of being exposed to a systematic learning process does not always result in the actual acquisition of the matter being learned, etc. Additionally, as for AD1, since an idiom was used in the text of the advertisement, it is likely that the subjects did not actually understand the idiom. Neither surfing the Internet nor the fact that the web sites visited were most frequently written in the English language had any relevance either with regard to gender or with regard to sport category (team or individual) participation. Thus the understanding of the overall message does not depend exclusively on the verbal part of an advertisement, but also on some other aspects. In other words, although language is one of the ways of communicating ideas, it is not the only means in which they can be transmitted from a sender to a recipient.

The results of this analysis point to the fact that designing an advertisement is a very difficult task and that many parameters have to be taken into account. Some presumptions regarding their design may prove to be wrong and result in only a partially successful product, i.e. advertisement. Still, incorporating the images of top-level athletes in advertisements has proven to be a successful way of persuading prospective consumers to buy a certain product. Although the image of an athlete need not always be recognised by the whole target audience, as shown in this analysis, it still helps to understand the message sent by an advertisement.

The analysis in this paper has certain limitations as regards its generalizability. The selected population as well as the size of the sample do not enable drawing broader conclusions since the analyses made on other populations could yield results different from the ones presented here. However, the popularity of some athletes would probably prove to guarantee a satisfactory effect as regards advertising goals. Therefore, research into various factors regarding the population for which an advertisement is intended seems to be necessary in order to achieve a broader insight into the matter in question.

## References

1. Bartoluci, M., & Omrčen, D. (2003). Promotion as an element of marketing mix in sport and sport tourism: The Croatian experience. *Kinesiology*, 35(1), 72-84.
2. Bartoluci, M., & Omrčen, D. (2005). Sport tourism promotion – some examples from Croatia. In D. Milanović & F. Prot (Eds.) *Proceeding book of the 4<sup>th</sup> international scientific conference on kinesiology 'Science and Profession – Challenge for the Future', Opatija, 7-11 September 2005*, (pp. 210-214). Zagreb: Faculty of Kinesiology, University of Zagreb.
3. Cameron, D. (2007). Unanswered questions and unquestioned assumptions in the study of language and gender: Female verbal superiority". *Gender and Language*, 1, 15-25.
4. Cheung, M. (2011). Sales promotion communication in Chinese and English: A thematic analysis. *Journal of Pragmatics*, 43, 1061-1079.
5. Du, Y., Weymouth, Ch.M., & Dragseth, K. (2003). Gender differences and student learning. Paper presented at the Annual Meeting of the American Educational Research Association, Chicago, IL, April 21-25, 2003, pp. 46-53.
6. Halliday, M.A.K., & Matthiessen, Ch. (2004). *An introduction to functional grammar*. 3<sup>rd</sup> edition. London: Arnold.
7. Halliday, M.A.K. (2005). *Studies in English language*. London/New York: Continuum.
8. Kiefer, A., & Shih, M. (2006). Gender differences in persistence and attributions in stereotype relevant contexts". *Sex Roles*, 54, 859-868.
9. Maslač, I. (2007). Periferna persvazija na primjerima poljskih reklama. *Strani jezici*, 36, 245-256.
10. Omrčen, D. (1995). Jezik sporta. *Kineziologija*, 27(1): 77-84.
11. Omrčen, D. (1998). Characteristics of language in sports commercials. *Kinesiology*, 30(2): 77-89.
12. Omrčen, D. (2008a). The importance of communication in management: The case of sport tourism. In L. Galetić & N. Čavlek (Eds.) *Proceedings CD of the 4<sup>th</sup> International Conference 'An Enterprise Odyssey: Tourism – Governance and Entrepreneurship', Cavtat, 11-14 June 2008*, (pp. 1863-1873). Zagreb: University of Zagreb Faculty of Economics and Business.
13. Omrčen, D. (2008b). Communication skills in sport tourism management. In Z. Ivanović (Ed.) *Proceedings CD of the 19<sup>th</sup> Biennial International Congress 'TOURISM & HOSPITALITY INDUSTRY 2008 – New Trends in Tourism and Hospitality Management, May 7-9, 2008, Opatija, Croatia*. (pp. 821-832). Opatija: Faculty of Tourism and Hospitality Management.
14. Sabbatini, R.M. E. (1997/2000). Are there differences between the brains of males and females? *Brain and Mind Magazine* [On-Line Science Papers], <http://www.sabbatini.com/renato/online.htm>; accessed: 20.5.2009.
15. Shank, M.D. (2002). *Sports marketing. A strategic perspective*. Upper Saddle River: Prentice Hall.
16. Weber, S., Vrdoljak-Šalamon, B., & Boranić, S. (1994). Evaluacija kvalitete tiskanih promocijskih materijala. *Turizam*, 42(7-8): 112-122.
17. Weber, S., Vrdoljak-Šalamon, B., Tarlow, P. E., & Boranić, S. (1996). Ocjena kvalitete turističkih brošura. *Turizam*, 44(9-10): 247-254.

## THE SALARY OF A PROFESSIONAL FOOTBALLER: THE DETERMINING FACTORS

Hajer Naouali<sup>1</sup> and Abdessatar Ati<sup>2</sup>

<sup>1</sup>University of Lille, France, University of Tunis El Manar – Tunisia

<sup>2</sup>University of Tunis El Manar, Tunisia

### Abstract

This article will focus on the different factors determining the wage of professional football players, based on the 20 footballers with the biggest salaries in the world during the season 2010-11. It presents an estimate of the remuneration equation after taking different factors into account regarding the players and their clubs. This approach is different from the previous ones by its attempt to put the function for the remuneration of a football player into shape. It highlights the fact that if one of the reasons for the gaps between salaries can be due to the players' abilities, the biggest part is still due to unaccountable characteristics, such as the strengthening of the image of the club towards media.

The salary equation is tested via a simple linear regression which shows that the clubs tend to pay more a football stars embodying a "brand", one of the keys to the success of sports as a show business that generates marketing potential. The clubs give more consideration to the capacity of the superstars to increase their earnings (sponsoring, merchandising, TV broadcasting rights, ticket sales, etc.).

**Key words:** labour market, sports practise, remuneration mechanism, labour econometrics, the establishment of econometric patterns

### Data and pattern: description

A paid athlete is a worker who agrees to get prepared, for a sum of money, to take part in a sport-related event or competition while supervised by his employer (Primault, 2010:31). His employer can give him orders and instructions, check his work and take disciplinary measures if he fails in his obligations -all defined in a particular working contract and taking into account the specific features of the activity (Sobry, 2003:280).

The main characteristics of the sports labour market is the appraisal of an athlete's wage, tightly linked to his relative sports performance defined by Platonov as "the maximum possibilities of an individual in a given discipline at a given stage of their development" (Poli, 2010). This definition is interesting as it introduces the notion of performance as a measurable factor of production.

There are various factors measuring the performance of a footballer. In this study we will group the different indicators in a single measurement: the ranking of each player of our sample in the FIFA Ballon d'Or. The Ballon d'Or is indeed an honour awarded to the best football player of the year (FIFA Ballon d'Or regulations, Article 2), following the sports performance of a player<sup>1</sup> as well as his behaviour on and off the pitch (Article 3). The winners are elected by an international panel of judges made up of an even number of coaches, national teams' captains and journalists specialised in football. Each of the 3 categories has the same electoral power and the results of the individual votes of the judges have to be published on both websites of the FIFA and the Amaury Group<sup>2</sup> (Article 4).

On top of the sports performance, other factors determine the salary function which we can evaluate straight away by using the income function. It consists in the regression of a player's salary including a set of variables characterising him and thought to have an impact on determining and setting his wage, such as: the budget of the club he plays for, his football performance and his ability to enter the market of Ultimate earnings<sup>3</sup>.

<sup>1</sup> These are the factors having an influence on the performance of a footballer such as his physical condition (strength, speed, stamina, and flexibility), technical factors (goals scored, assists, tackles, etc.), his tactical, psychic and cognitive capacities...

<sup>2</sup> Amaury Group is the French press group editing France Football magazine that created the "Ballon d'Or" award in 1956. In July 2010, this trophy was merged with the title of "FIFA World Player of the Year" to become the "FIFA Ballon d'Or".

<sup>3</sup> For Jean-Paul Louis Minquet (Revue française de gestion 2004/3, n°150:141-160), "the "Ultimate earnings" include sponsoring, TV broadcasting rights, external funding and other marketing products (catering and merchandising but also memberships, etc.)". For the purpose of this study, the individual Ultimate earnings of the footballers will include the "income from advertisement and other various operations".

We can express the general specification of our regression pattern as follows:

$$w_i = \beta X_i + \varepsilon_i$$

- $w_i$ : the annual pay rate for player  $i$
- $X_i$ : a vector gathering statistics from the explanatory variables for the salary of player  $i$
- $\beta$  et  $\alpha$ : the parameters of the pattern allowing to define, for each player  $i$ , the direct link between his salary and the explanatory variables that are used.
- $\varepsilon_i$ : the random term summing up any information that would not be taken into account in the relation between the salary and the club's budget (problems of specification, approximate linearity, summing up the absent variables, etc.).

This regression pattern is a function for earnings for which a parametric functional pattern can be deduced, if we refer to the Human-capital theory (Becker, 1964) and make a few hypotheses.

We have personally gathered the data used for the following estimate from the official websites of the targeted leagues and sports publications like France Football 2011.

A rather detailed extension to our model could be expressed as follows:

$$w_i = \beta_0 + \beta_1 B_i + \beta_2 \text{FIFA } B_{oi} + \beta_3 \text{RF}_i + \varepsilon_i$$

We have a sample of 20 players, for who we have established the different variables included in the following table:

Table 1. A dictionary of the variables used in this pattern

variable	Signification
$w_i$	The player's yearly wage (salary and bonus)
$B_i$	The budget of the club employing player $i$
FIFA $B_{oi}$	The position of player $i$ in the "FIFA Ballon d'Or 2010" ranking (expressed as the proportion of votes in his favour)
$\text{RF}_i$	The Ultimate Earnings generated by player $i$ during the season 2010-11

Table 2. The 20 footballers with the biggest salaries in the world in 2010-11 following their age, the budget of their club, their position in the 2010 FIFA Ballon d'Or ranking and their Ultimate Earnings.

Observation	player	Club	$W_i$ (in M€)	$B_i$ (in M€)	Share of earnings in the club budget (in %)	FIFA $B_{oi}$ (% of votes obtained)	$\text{RF}_i$ (in M€)
1	Cristiano Ronaldo	Real Madrid	13,5	438,6	3,08	3,92	14
2	Kaka	Real Madrid	10,3	438,6	2,35	0	9
3	Lionel Messi	FC Barcelone	11	398,1	2,76	22,65	20
4	Carles Puyol	FC Barcelone	9,9	398,1	2,49	1,43	1,5
5	Wayne Rooney	Manchester United	13,7	349,8	3,92	0	7
6	Bastian Schweinsteiger	Bayern Munich	9,2	323	2,85	0,75	4
7	Phillip Lahm	Bayern Munich	11,1	323	3,44	0,05	1,8
8	Franck Ribéry	Bayern Munich	10,8	323	3,34	0	1,1
9	Franck Lampard	Chelsea	9,2	255,9	3,59	0	5
10	Fernando Torres	Chelsea	8,8	255,9	3,44	0	5,2
11	Didier Drogba	Chelsea	8,3	255,9	3,24	1,68	4,5
12	Zlatan Ibrahimovic	Milan AC	10	235,8	4,24	0	2,5
13	Steven Gerrard	FC Liverpool	7,7	225,3	3,42	0	4
14	Samuel Eto'o	Inter Milan	11	224,8	4,89	1,37	2
15	Gigi Buffon	Juventus Turin	6,1	205	2,48	0	5,2
16	Carlos Tevez	Manchester City	13	152,8	8,51	0	2,4
17	Yaya Touré	Manchester City	11,6	152,8	7,59	0	2,2
18	Ronaldinho	Flamengo	10,8	83,6	12,92	0	7,5
19	David Beckham	Los Angeles Galaxy	4,5	(*)	-	0	14,5
20	Thierry Henry	New York Red Bulls	7,6	(*)	-	0	6

Sources: France Football 11 March 2011 and other sports publications

(\*) We were unable to find the budgets of these 2 clubs for 2011

## The econometric approach and results

To define what makes the salary of a professional footballer, our model can be divided into 3 sub-models.

### 1 - A descriptive analysis of the link between the budget of a club and the wages allocated

To start characterising the factors determining the wage of a top athlete, we will have a look at the link between him and the budget of the club he plays for so as to establish how important this budget is when coming to take a decision regarding his salary.

If we first focus on the salaries of these 20 football players and the budgets of the clubs they belong to, we can notice a strong link between these 2 variables. Indeed, the 20 biggest salaries in the world of football come from some of the richest clubs on the planet.

Analysing the data gathered in Table 2 (taking the amount of money allocated to the player's wage compared to the entire budget of the club) would show that on average, a club will spend nearly 4% of its budget to remunerate a single top player "so as to escape from the glorious uncertainty of sport" (Garets, Nicholson and Paché, 2007:173). Such an important investment in a player could seem obvious in the way that "the stars are the core of the production for sports performance" (Minquet, 2004:159).

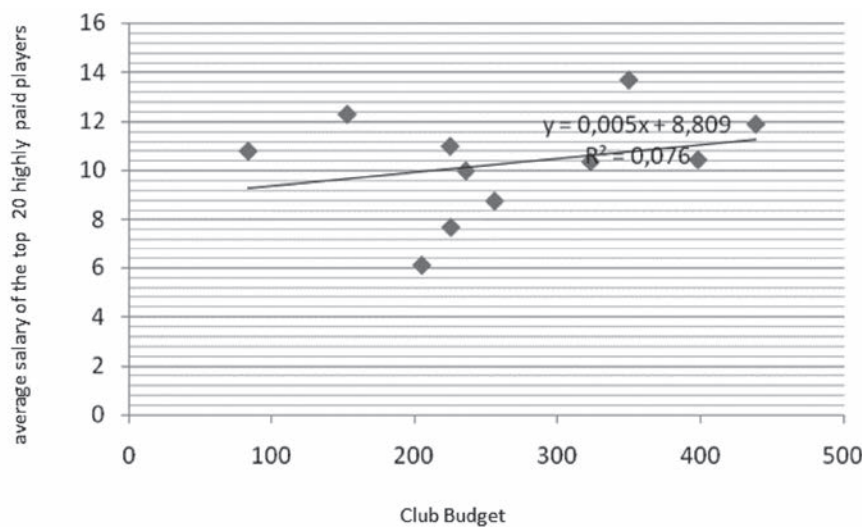

Chart 1. A scatter plot associated with the average salary allocated to the world's 20 highest-paid footballers according to the budget of their club (Falissard, 2005)

There are some cases where the combination salary/budget is absurd and far from the usual ratio. They correspond to the high-paid footballers who play for clubs that are not among the richest, but still allocate them a high wage. It is the case for Carlos Tevez who gets the 3rd highest salary (13 million Euro a year) while playing for Manchester City, in 11th position budget-wise (152,8 million Euro), whereas Carles Puyol gets the 12th highest salary when playing for the 2nd richest club in the world, FC Barcelona -with a budget of 398,1 million Euro, 2,605 (more than two and a half) times the one of Manchester City. The most significant case is the one of Ronaldinho, whose salary (10.8 million Euros) represents 12.92% of the budget of his club R.J. Flamengo.

### 2 - The intensity of the link between remuneration and sports value

In order to define the factors determining the salary of a professional footballer, we can establish a first regression of the salary equation according to the performance recognised by the 2010 FIFA Ballon d'Or ranking.

We can establish this first model as follows:

$$w_i = \beta_0 + \beta_1 B_i + \beta_2 FIFA B_{oi} + \epsilon_i$$

Among the world's 20 highest-paid players in 2010-11, only 7 reach the top of the worldwide scale if we refer to the indicator "2010 FIFA Ballon d'Or". From this we can deduce that only 35% of the players nominated for the Ballon d'Or award get a high pay.

The statistic indicators measuring how strong the connection is between the salary of a football player and what he's worth on the sports market show there is a positive -even though its weak- link between these two variables. In fact, a

linear correlation coefficient of 0,1324 along with a determination coefficient R<sup>2</sup> of 0,02218 highlight the significance of this regression. However, such a regression is not enough to justify these figures nor to cover the entirety of the relationship between the salary and the sports' indicators.

### 3 - The impact the economical value of a player has on determining his remuneration (the Ultimate earnings)

The above regression shows that the wage of a professional footballer is not really influenced by his football performance as established by the FIFA Ballon d'Or ranking.

This situation leads us to take into account a new variable -the "Ultimate earnings", that is to say the earnings due to the fact that sport is a multi-faceted product: it is a communication support, an image conveyor and a public service (Lansdale, 2004:387). It is all the income that is not directly issued from the competition. For the players, these earnings come from advertisement, copyrights and various other operations. As for the clubs, it is thanks to their top players and their image that they can generate economical potentials even if these players cost them a lot of money. By considering this new variable, we obtain a more accurate regression. The determination coefficient goes up to 0,8849, for 0,02218 before. The variable "Ultimate earnings" represents 86,27% of the explanation for the salary, and thus it is the most significant variable and the most correlated to the salary<sup>4</sup>.

## Conclusion

The determination of top stars' wages is a random variable that takes several determining factors into account (Grundy, 2004:411), of which the most significant seems to be the "Ultimate earnings" -that is to say the income earned by other means than the practice of a sport.

Exploiting the image of top players thus represents a major strategic axis for development for the clubs, aiming at diversifying their resources and minimising the element of uncertainty inherent to the sphere of sports. The clubs generate more earnings thanks to these top players and their image even though they cost a lot of money.

In other words, the economical value of a talented professional footballer often goes beyond his mere value on the sports market (Gouguet and Primault, 2002:151) in a way that he will strengthen the image of his club towards media, help getting new sponsors and generate important sales of merchandising thanks to his name.

Ultimately, football doesn't go by the rules of an ordinary labour market where the remuneration is proportional to the productivity and profitability of the workers. It is an unusual market where the performance on the pitch might be the least influential variable.

In this context, David Beckham is the most significant example of this phenomenon (Mirallès, 2005:654). The value of this player on the sports market would not be enough to make him one of the highest-paid footballer in the world, but his marketing weight (as a look and fashion icon) made of him one of the famous "Galactics" -with one of the biggest incomes in the world.

## References

1. Falissard, B. (2005). *Comprendre et utiliser les statistiques dans les sciences de la vie*, 3<sup>ème</sup> édition, Masson, Paris, 2005.
2. Garets, V. Nicholson, P. and Paché, G. (2007). *D'un attachement aux joueurs à un attachement au club : quelles stratégies de fidélisation des supporters-clients dans le secteur du football professionnel?*, 12<sup>èmes</sup> Journées de recherche en marketing de Bourgogne, 8 et 9 novembre.
3. Gouguet, J.J. and Primault, D. (2002). *Economic analysis of the transfer market in European professional soccer*, Fourth annual Conference International Association of Sports Economists, Université de Columbia, New York City, 11-12 juillet.
4. Grundy, T. (2004). Strategy and financial management in the football industry, *Strategic Change*, Vol. 13, n°8, pp. 405-422.
5. Lonsdale, C. (2004). *Player power: capturing value in the English football supply network*, *Supply chain Management: An International Journal*, Vol. 9, n°5, pp 383-391.
6. Minquiet, J.P.L. (2004). *Sport, football et finance*, *Revue française de Gestion*, 2004/3, n° 150, pages 141 à 160.
7. Mirallès, P. (2005). *Les nouvelles stratégies des clubs de football professionnel face à la guerre des talents*, *revue Internationale sur le travail et la Société*, Vol.3, n°2, pp. 639-668.
8. Poli, R. (2010). *Le marché des footballeurs : réseau et circuits dans l'économie globale*, Editions scientifiques Internationales, Berne.
9. Primault, D. (2010). *Quel impact sur le marché des joueurs*, *la Revue juridique et économique du sport, JuriSPORT*, n°98 - mai 2010, pp 31-33.
10. Sobry, C. (2003). *Socioéconomie du sport : Structures sportives et libéralisme économique*, Edition De Boeck Université.

<sup>4</sup> The probability for the coefficient for this variable to be null (P-value) is 0,0000285.

## THE ROLE OF YOUTH ACADEMY IN CREATING NEW VALUES FOR THE PROFESSIONAL FOOTBALL CLUB

Alen Jerkunica, Stipe Smoljanović and Denis Kosor

*University College of Sports Management Aspira*

### Abstract

The aim of this paper is to highlight the importance of youth academy as a kind of an incubator for the most important resources of a sport organization – athletes. Athletes are the ones who create new value with their individual qualities and ability to fit into a team that results in successful athletic performances. However, the purpose of youth academy should certainly be much larger and more complex than the production and export of talented players. Such approach is the reason why clubs do not develop, and do not achieve desired levels of actual athletic performances, so they fall into “vicious circle” in which they are doomed to mediocrity and pure survival. Also we should not ignore the scouting process that is, finding talented athletes from other regions as an important factor in sport organizations. Investing in youth academy, in its infrastructure, coaches, scouts and other professional staff represents an investment in the creation of top athletes in order to achieve the best possible sports performance, and increase the value of the club.

**Key words:** *sports organization, human resources, management, athletes*

### Introduction

There are many concerns that arise when talking about the role of a youth academy in the creation of new values of professional clubs. In fact, many professional clubs pay great attention to younger generations, while others are more likely to buy already established players. If we divide the human resources in professional sports organization to the most important factors: management and administrative staff, technical staff, trainers and other professional staff, athletes and volunteers, we will come to conclusion that the nucleus of every sports organization are athletes. Athletes are the ones that in profitable, professional sports organizations create new values with their individual qualities, and their ability to fit into a team. This results in successful athletic performance, and it leads to increased public and media interest in sports games and so it has a direct impact on the increasing revenue from the club tickets, sponsors, marketing and TV rights.

If the main sporting activities are training and competition then the coaches, that is the operational managers, and athletes are a “group of people who represent the reason why sports organizations exist and who are expected to show the effectiveness of execution of organizational tasks directed towards the realization of goals, as well as innovations, creativity and inspiration in achieving the highest master ship of sporting achievement.” (Tomić, 2007).

### The importance of youth academies as a part of the sports organizations

The fact is that smaller clubs are often left with no other choice than to invest in youth academies and try to pick from their own backyard to select, direct, train, and develop the most promising young talents. The purpose of youth academy should certainly be much larger and more complex than just the production and export of talented players. Many clubs have fallen into this trap, simply because they could not compensate the quality of their players which they have sold, and they have no money for more expensive first class players. This results in inconsistent performance and imbalance in quality between juniors from youth academy and seniors, that is, the first team. Such approach is the reason why clubs do not develop, and do not achieve desired levels of actual athletic performances, so they fall into “vicious circle” in which they are doomed to mediocrity and pure survival (Relvas et al., 2010). Consequently, we can say that the goals of youth academy should be: recognizing young players with real potential, creating the partnership web with surrounding clubs, constant investing in staff members, assuring quality infrastructure, creating efficient learning environment (Bilton, 1999).

Also, young players who leave early from their own clubs to the richer (foreign or domestic) ones often wither away, or do not realize their athletic careers as expected, due to impatience, bad administration, coaches, or the fans. They simply have no room for errors because they can be replaced at any moment by another player, and are certainly under even more pressure when put in a new environment that expects their contribution in achieving sport results, usually in the shortest possible time, ignoring the time required for a person to adapt to the new environment.

A very important prerequisite for the functioning of each youth academy is a high quality infrastructure, a camp which should enable a smooth operation, completely undisturbed training for players. Numerous examples of successful



football clubs show that they owe their success to planned approach by investing in their own potentials, in their own youth academy, in a way that ensures all the prerequisites for the development of players from the youngest age to seniors. All these clubs have built camps, not intended just for the first team, but particularly for younger generations, which is actually a good investment in their own future. Besides their own youth camps and schools, a large part of successful clubs have their own club partners who serve for transferring players who need some time to adjust, to mature, or to try out certain acquisitions selected by their scout service.

The specificity of sports organizations is that “management of human resources in this kind of organizations is directed towards two different kinds of employees: athletes and other employees” (Covell, Walker, Siciliano, and Hess, 2003:309-311 from Bartoluci and Škorić, 2009:122).

The importance of coaches and experts in every club can be seen from the fact that human resources in sports organizations are also the object and the subject of transformation. Athletes are present as a resource of transformation, which transforms the input into the output and a new value generated through the sports scores, while the coaches and other employees may be viewed as a resource by which this transformation is done. In this sense youth academies are the most sensitive areas in clubs because their professional staff has a complex task of educating and creating a player, and that education will eventually influence the value of a player, as well as the value of clubs in general. Coach, as a direct participant in the process of creating a player is immensely valuable resource, because he is the one who directly or indirectly may affect the creation of new values for the club, and recognition of young players (Harwood, 2008). Of course, finding a quality coach is not easy. Often coaches appear as former players who undergo specific training and after their playing career remain associated with the sport through work at the club in different functions, or through work in schools where the youth can use their experience from their sporting careers. Another way to get good staff is recruiting people outside the club, who gained the needed specific education or have already achieved results through work in a proven quality staff.

“Basic strategic human resources decision making in sports organizations includes nine elements: natural resources – human capital, sports associations, market needs, special technology and training, manufacturing ability, sales method, distribution method, organization size/growth, refund/profit – cash and in nature” (Beech and Chadwick, 2010).

All staff in the professional football club, must be well coordinated to achieve the set of goals and achieve results through sports with systematic and planned work. This applies to youth academies, particularly to the staff that takes care of selecting athletes from the earliest ages, their training and transformation to the future professional players, because that is a long-lasting process which is exposed to various risks, which may be annulled only by a professional approach based on planning and analysis.

The way of recruiting young athletes in professional sports in the United States is certainly very interesting. They recruit only from schools or university systems, which means that the youth academy as a part of a professional sport organization does not exist. Of course, a prerequisite for this is a highly developed school sports system with an excellent infrastructure, and investments in sports staff.

Good example of functioning of youth academy and exchanging experiences is also the interconnection between NK Zagreb and Inter from Milan. The project is started to improve the work of youth academies through transferring the most up-to-date methods of development of young footballers and exchanging experiences with Inter's coaches. Contemporary football is starting to appreciate more and more planning and methodology, and it is less and less concentrated on improvisation. The fact that Inter invests five million euros a year in development of academy and scouting for players proves this.

If we take into consideration the costs such as coaches salaries, accommodation and food, scholarships, travels, equipment, health checks, infrastructure (water, electricity, cleaning), supporting professional personnel (teachers, doctors, physical therapists) this can lead to numbers as high as 800 000-1 000 000 € for the functioning of the youth academy in only one season of the club which is located at the top of the first Croatian football league. It is obvious that these funds are not negligible, but it is certain that the benefits significantly outweigh the investment costs. There is a possibility to utter the added value of “created” professional athletes through money equivalent as the difference between all investment and profit through the current market value of players in their professional facility - the first team or as the price achieved when selling a player.

### **Scouting and proper selection of young athletes**

All processes in organized sports, as well as in professional football clubs, are dependent on proper selection of athletes, which directly reflects in the achievement of the objectives, results in sports as a primary goal of any sports organization. The potential of the athlete and the selection of the right people at the right place within coaching and other professional personnel is ultimately measurable in competitive advantage that is reflected precisely in the sports results achieved by each club. Sources for selection of athletes can be different: from organization's own selections through regular sporting events and competitions, to the selection through scouting, i.e. finding the athletes in the external environment and other clubs.

Choosing and selecting the athletes takes place at several levels. From the earliest age it is necessary to make a selection based on the analysis on the first, primary level which is mostly done by sports professionals and coaches. The most talented athletes are chosen and directed to further development that takes place through training and competitions. After the systematic monitoring, analysis of individual abilities and characteristics a selection is made and it includes and affects the structure of the whole sport organization because of the implications that the selection of players for the first team has for the entire club, and the whole sports organization. In any case, only on the basis of good selection, the database is properly formed, there may be further upgrades and shape transformation process, because without quality input it can be difficult to form a high-quality output and create new added value. Staff that works in youth academies with young people should be aware that the aspects of action and transformation process of young athletes have wider social significance because they include not only the creation of professional athletes, but also the formation of a complete person who, through sports, meet with the process of socialization in the early stages of life.

There are many positive effects that are reflections of quality of work in youth academies, and that may be difficult to measure, as it is often the case when talking about human resources and determining their value. Such effects are reflected through the development of human qualities, the promotion of authentic human values and education of athletes as people who can easily carry out their work and social tasks. Through a systematic process of training and competition athletes are used to difficulties and challenges, thus developing their personality and ability to react allowing them, perhaps, to take away the problems and difficulties of life more successfully than other individuals.

However, for long-term prosperity of the club scouting or finding talented athletes from other people's professional schools or youth facilities must not be neglected. The wider the general basis for finding talent, the greater the ability to bring quality players to the club is. Scouting for players, i.e. talents, is finding and assessment of promising players in order to bring them to the club for reinforcement. It is well known that some clubs have hundreds of scouts all over the world. The advantage of scouting is that it enables the club to choose the players who otherwise would not be found in their own youth academies. Also, these players are mostly cheap because they are still unrecognized, and later, the club has an opportunity to sell them for higher price. We should not neglect another kind of scouting – tactical scouting – which enables the club to find out the important information about opponent's game and players. To add a new value to the team and the club as a whole, it is necessary to invest in extra classes, that is, the promising players that are not in their own youth academy. Investing in extra class will inevitably lead to increase in value of other players in the team just because the club will ensure better results, specifically the possible placement in euro-competitions when these players become seniors. Great sports results lead, as we have already said, to better sponsorship deals, higher ticket sales, souvenirs, higher revenues from marketing, etc.

Because of the large potential impact on the success of the sport clubs, scouting and monitoring the players outside the club as well as the final choice whether it is a talent from another youth academy or from already formed professional athlete, the professionals (coaches educators, nutritionists and doctors), and the economic structure of the clubs organization must be included.

Specifically, professional structures must give their views on athletes selected range while the economic structure must deal with the financial part of assessment of the impact of individual selection on the planned sports score. It is necessary to analyze the investments in bringing the players “from outside” and expected investment return through better sports results, increasing the value of entire team and expected total additional income. Only on the basis of such a comprehensive analysis should the investment decision be made.

## Conclusion

Only selection of quality, solid infrastructure, systematic and planned work, which includes analysis of all steps in the process of transformation of athletes as inputs in the action process of sport organizations including football clubs, can create new values or added value to the required investment. This is particularly evident in schools where the youngest children through the long process of training and competitions in various age categories come to be the final product, the first-team players. The value of such player according to the current market conditions shows just the value of output in such complex process, whether a player plays for a club from which he originated, or if he made a transfer to another club and therefore the direct inflow of money into “cash register” of his “mother” club. The basic prerequisites for any serious work in the sporting environment are: developed infrastructure, primarily camps with all the necessary amenities, as well as professional sporting staff, which can assess the potential of an athlete, and form a sports team that is the initial base for the transformation process. Due to the complexity of the process which results in the formation of primarily a person, and then a professional athlete – a football player, it is necessary that the other functions in the club are covered with high quality and educated staff.

In addition to “creating” their own players clubs may choose to import or buy foreign players according to the recommendations of the “Scout office”. At a certain stages of making decisions about employment and investment in foreign players it is necessary that all club organization structures participate; sports section must be processed by professional sports personnel and financial management should be a matter of professional management personalities of

the club, so that such investments would be incorporated into previously established objectives in accordance with the sporting and financial plans.

Our recommendation for Croatian football clubs is to try finding partner clubs from abroad, if it is possible, and through tournaments and exchanging experiences and coaches to improve the work of their own youth academies. Anyway, the steps that each club should incorporate in their own sports and business strategy are: linking the work of youth academy and the first team, introducing and applying modern technology in supervising and monitoring of all processes of player s development, educating coaches, youth camps affirmation, increasing individual work, creating scouting database, dedicate more to pedagogic work and education, developing infrastructure: courts, closed sports halls with courts, hotels with accommodation for younger categories, medical centres, etc.

Investing in youth academy, in its infrastructure, coaches, scouts and other professional staff represents an investment in the creation of top athletes in order to achieve the best possible sport performance and increase the value of the club. Such investment is regained many times, regardless of longevity and complexity of the process. For some clubs it is the only formula of existence, the investment in their academies is investing in the future that will give a good final product, not only for their own club, but for the wider community, which is of great importance.

## References

1. Bartoluci, M.; Škorić, S. (2009). Menadžment u sportu (Management in sport), *Odjel za izobrazbu trenera Društvenog veleučilišta u Zagrebu, Kineziološki fakultet Sveučilišta u Zagrebu*.
2. Beech, J.; Chadwick, S. (2010). Sportski menadžment (Sports Management), *Mate Zagreb*.
3. Bilton, J. (1999). Developing players for the modern game football academies: the start - the Leeds United experience. *Coaching*, 2(3), 33-36
4. Harwood, C. (2008). Developmental consulting in a professional football academy: the 5Cs coaching efficacy program. *Sport Psychologist*, 22 (1), 109-133.
5. Relvas, H.; Littlewood, M.; Nesti, M.; Gilbourne, D.; Richardson, D. (2010). Organizational structures and working practices in elite european professional football clubs: understanding the relationship between youth and professional domains. *European Sport Management Quarterly*, 10 (2), 165-187.
6. Tomić, M. (2007). Sportski menadžment (Sports management), *Data status Beograd*.

## SMALL AND MEDIUM SPORTS ENTERPRISES

Teo Bratinčević and Stipe Smoljanović

*University College of Sports Management Aspira*

### Abstract

The paper analyzes the concept of entrepreneurship and its application in small and medium sport companies. Attention was focused on the development of modern entrepreneurship in the global environment at the level of the world economy and its impact on small and medium sport companies. Briefly describes the small and medium sport companies and their great potential and the most common problems that they encounter. The final section of the paper introduces some suggestions for growth and development of these companies in order to contribute to the development of the economy as a whole.

**Key words:** *sport, small businesses, sport companies*

### Introduction

Research shows that by the end of the last decades of the twentieth century, sport became the world's economic activity number five (after petroleum, pharmaceutical, military industry and information technology). In year 2007, the annual turnover of funds in the sport has crossed the \$ 900 billion. Entrepreneurship is in fact a subject of interest of many sciences, most social, and in particular: economics, psychology, sociology, law, and anthropology, each from their specific discourse. In a wide range of possible meanings of entrepreneurship, it can be seen as: special economic function of combining the production factors and increasing existing resources, the creative process and the transformation of inventions into innovation, self-employment and starting their own businesses, the emergence and development of small enterprises, visionary activity and creative input changes that have a crucial role in the transformation and renewal of society, specific occupation, a way materializing creative products, taking business risks, find and use new features, one of the roles of management and specific behaviors. It should be noted that the sport as a significant industry need to open the door to entrepreneurship in all spheres of interest, particularly within small and medium enterprises because sport must be in function of economy.

### Modern entrepreneurship

Modern approaches to entrepreneurship are based on the observation of entrepreneurial activities on the basis of analyzing the factors that determine the level of entrepreneurship and synthesize the determinants of entrepreneurship at the macro level. Deeply aware of the multidimensionality of the entrepreneurial process (whose definition often depends on the focus of the research was carried out) and the starting point at which there is no universally accepted definition of entrepreneurship, Ingrid Verheul and colleagues suggest significantly altered social and economic context of modern entrepreneurship.

After 70 years of last century, a noticeable trend of rediscovery of entrepreneurship and to encourage its development - leaving the concept of exploiting economies of scale as the main driving forces in economic development, the emergence of a period of increasing uncertainty at the global level, the entry of a large number of states in the process of social and economic transition, reduction of business activities and the restructuring of the world's great companies - entrepreneurs are again recognized as an accelerator of development, primarily that realized by many small businesses.

Recognizing the importance of entrepreneurship in the national economy, many countries have adopted entrepreneurship as a vital component in the process of economic growth and development. The world economy globalization process has progressively lost its local, regional and national characteristics, which is significantly contributed with new technologies, new innovative processes and the integration of many different local, regional, international institutions. In this process, the contribution of the entrepreneurial spirit is unquestionable - becoming one of the key factors of progress, entrepreneurs develop and implement new technologies, generate new products and services, contribute to the educational process and increase the general welfare of the countries where they operate.

“Exhaustion of most forms of economic and social welfare that provided the economy (state) welfare, more than ever, shows that period of seeking new solutions to micro and macro level is coming, mostly focusing on entrepreneurship, its role in the development of societies and, above all, encouraging private initiatives and risks” (Kružić, 2007). Under the influence of turbulent global changes entrepreneurship position drastically changes – it is, every day more, experienced

as a generator of social and economic development throughout the world. We are witnessing, as emphasized by Vojmir Franičević, a renaissance of entrepreneurship, not only at the media presentation level of new or renewed ideological worldview that see entrepreneurship at the center of discourse, but also at the level of current economic theory and economic policy.

### Small and medium sports enterprises

Small and medium sports enterprises may be different types of sports organizations: such as shops with sporting goods (clothing, footwear, sporting equipment ...), sports information service, the service provider of commercial sports medicine, sports science, tourism and recreation or events manager. SMEs are defined as a key contributor to the growth of industries associated with leisure as well as in branches of sport. The changing nature of participation and consumption in sport reflects on the types of business functions that arise, and therefore on the existing types of sports SMEs. Trends in sports participation move from formal clubs and memberships in associations according to the services without the structure and which are paid for its use. Changes in social and cultural levels are associated with the development of new commercially driven sport and recreational activities such as sport in the workplace, leisure centers, sports halls and swimming pools. "Sports SMEs are linked with other sporting activities, particularly those engaged in nonprofit activities and those that are actively participating and involving sports and recreational clubs" (Beech and Chadwick, 2010). There is considerable overlap with regard to the fact that many non-profit sports organizations are trying to develop a commercial branch of its activities.

On the other hand, the state must encourage the growth and development of small and medium enterprises that are driving the socio - economic development, but also due to the direct benefits of such a group brings.

Not looking at the differences in types of sports activities they are engaged with, small and medium-sized companies have some characteristics: the supply of market with goods and services, focusing on income generation, small administrative structure, small number of employees, private property, etc. "With these characteristics provides the greatest possibility for private property. Private capital can engage in sports other than the attractive sports and through investment and establishment of small and medium enterprises which sports are realized in practice already. Today in Croatia there are about 500 different companies to provide various recreational services" (Bartoluci and Škorić, 2009). In the next section the basic problems that generally face small and medium sports enterprises will be provided.

### The problems of small and medium sports enterprises

Like all other small and medium enterprises and sports SMEs are faced with numerous problems affecting the sustainability and ultimately jobs profitability. There are four key issues of sport SMEs:

- Development of business strategy focused on client
- Creating competitive advantage
- Operational planning
- Managing cash flow.

As far as business strategy, we can say that it is a key element to success in any business as well as in sports where they are often ignored. Strategy arranges to maximize results and reduce wasted effort. Creating a strategy can start with simple analysis using the SWOT method which helps to identify clear divisions and identification of internal and external environmental factors. Also a key part of development strategy is to understand customers.

The main question that an entrepreneur should ask is what motivates customers to buy a product or service. The answer may be that consumers largely do not buy products or services, but they buy benefits. Thus, on fitness club example, some of the customers are buying a way of life, some social interaction, and some fitness. Creating competitive advantage in each activity as well is also crucial. Sports SMEs must continuously work to have a certain advantage or superiority in comparison with other similar activities and competition. Competitive enterprise advantage will differ from its competitors and the company will help customers choosing products or services to purchase. Certainly, the competitive advantage can be successfully achieved through a combination of marketing mix elements.

To overcome the everyday problems in the sports business small and medium enterprises it would be important to draw up operational plan. Plan to deal with everyday activities, procedures, workflow and efficiency. His main goal was to help owners of businesses to do smarter, not more. Also it should allow the owner to determine commitment needed to make business successful. Planning always significantly increases the chances for survival and prosperity by giving special attention to areas where small businesses are sometimes lost.

Planning cash flow for small and medium enterprises in general is also a big problem. It often happens that due to improper management of the money, businesses lose their liquid assets and fall into problems. In determining cash flow, several steps should be performed to ensure a successful business for small and medium sports enterprises. This is a sales forecast, recognition of cash receipts, cash payments identifying, determination of net cash flow and future cash balance.

## Conclusion

Based on the foregoing we can draw some conclusions and briefly state the following. The global economy is developing within the social structures that are happening on the world economic scene, such as the competitive environment, increased use of technology, decreasing product life cycle, ever more demanding needs for trained manpower, increasing degree of sophistication of consumers, increasing demand for efficiency. Small and medium enterprises in the sporting activities also need to move in line with trends in the global economy. Certainly all the problems that we noted above in this paper can be solved by increased training of entrepreneurs especially those smaller ones.

We are witnessing in the Republic of Croatia the deterioration for a large number of small and medium enterprises related to the sport and it is almost the conventional wisdom that sport is only a function of leisure, not business.

It is known that entrepreneurship is a rare resource and talents that are typical for entrepreneurs have a limited number of people. In this connection the question arises: Is the enterprise, as an essential component of the entrepreneurial economy, science or art? The answer to this question is ambiguous: entrepreneurship is both – science and the arts. In the highest entrepreneurial activities, entrepreneurship is often a gift of nature and is resulting with assessment of entrepreneurship as an art. But except with a natural gift, a good and successful entrepreneurs can be, as experience shows, “created” with high quality teaching, training and scientific education, so that, eventually, we can speak for entrepreneurship as a science and profession.

The above facts indicate the need for small businesses or persons related to sports SMEs to be directed towards the acquisition of appropriate entrepreneurial skills, competencies and attitudes. Certainly, there is lack of professional personnel in the enterprises - managers who will fulfill the needs of sports and the economy.

## References

1. Bartoluci, M.; Škorić, S. (2009). *Menadžment u sportu*, Kineziološki fakultet Sveučilišta u Zagrebu.
2. Beech, J.; Chadwick, S. (2010). *Sportski menadžment*, Mate Zagreb.
3. Kružić, D. (2007). *Poduzetništvo i ekonomski rast*, Ekonomski fakultet Sveučilišta u Splitu.
4. Kotler, P. (2001). *Upravljanje marketingom*, Mate Zagreb.

## COMPARISON OF ATTITUDES TOWARD ADVERTISING THROUGH SPORT BETWEEN MONTENEGRIN AND TURKISH STAKEHOLDERS

Stevo Popović<sup>1</sup>, Duško Bjelica<sup>1</sup>, Georgi Georgiev<sup>2</sup> and Selcuk Akpinar<sup>3</sup>

<sup>1</sup>Faculty for Sport and Physical Education, University of Montenegro, Niksic, Montenegro

<sup>2</sup>Faculty of Physical Education, University "Ss. Cyril and Methodius", Skopje, Macedonia

<sup>3</sup>School of Physical Education and Sport, Abant Izzet Baysal University, Bolu, Turkey

### Purpose

Advertising through sport has become an important medium for many companies because of more flexibility, broader reach, and higher levels of brand that sport platforms afford (Kropp, Lavack, Holden, & Dalakas, 1999). When attending amateur or professional sporting events, or watching it, people are exposed to a variety of advertising. Unlike other advertising mediums such as television commercials or internet advertising, people involuntarily receive these advertisements because they watch the game for the sporting action rather than the advertisements. As the spending on advertising through sport as part of corporate marketing strategies has continued to increase, a growing need for research has emerged. Therefore, the aim of the current study was to compare attitudes toward advertising through sport between Montenegrin and Turkish stakeholders to support prospective Turkish companies who are going to grow their business in Montenegro.

### Methods

The sample included 560 respondents divided into two subsamples. The first subsample included 433 respondents who permanently lived in Montenegro, while the other subsample included 127 respondents who lived in Turkey at that time. The measurement was conducted by a valid and reliable method for measuring the attitudes toward advertising through sport (Pyun, 2006). The questionnaire was modeled by seven-point Likert scale and composed of three sections: attitude items, belief items, and demographic items. The system of variables consist 36 items of global attitudes (3 items) and four personal dimensions: product information (5 items), social role and image (8 items), hedonism/pleasure (4 items), and annoyance/irritation (4 items) and three societal dimensions of beliefs: good for the economy (4 items), materialism (4 items), falsity/no sense (4 items). Hotelling T2 Test was applied for determining significant difference between global attitudes and each dimension of beliefs among the subsamples. Statistical significance was set at  $p < 0.05$ .

### Results

In comparison of attitudes toward advertising through sport between Montenegrin and Turkish stakeholders, as it wasn't expected there were significant differences in almost all tested variables, almost all in favor Turkish respondents. Montenegrins have just showed more positive global attitudes, while one personal dimension (product information) wasn't noticeable.

### Conclusions

The current findings clearly demonstrated that Turkish respondents have much stable approach to advertising through sport and it means that Turkish investors should be so careful when they run corporate marketing strategies in Montenegro.

**Key words:** *corporate, marketing, strategies*

### References

1. Kropp, F., Lavack, A.M., Holden, S., & Dalakas, V. (1999). Attitude toward beer and tobacco sports sponsorships. *Sport Marketing Quarterly*, 8(3), 49-58.
2. Pyun, D.Y. (2006). *The proposed model of attitude toward advertising through sport*. Unpublished Doctoral Dissertation. Tallahassee, FL: The Florida State University.

## WRESTLING AS A CASUALTY OF OLYMPIC PROFIT AND MEDIA

**Tibor Barna**

*Semmelweis University Faculty of Physical Education and Sport Sciences (TF) Budapest, Hungary*

### Introduction

Having become a business factor, sports have become a show for mass needs. Public communication /media has annexed sports, in such a degree, that great part of sports rules had to be transformed according to the needs of media. The power of the media is doubtless. But the wrestling has to pay a heavy price for these frequent changes in the rules lacking any scientific demanding. The number of falls, and technical points for a time unit has decreased, which unambiguously means the devaluation of the contextual value of wrestling, although the length of the bouts shows the same tendency. The negative trends having formed during the past decade in the content values of wrestling is continuing.

*Key words: media, wrestling, falls, roubles*

### Methods

The followings were applied during **2025** bouts (Olympics, World Championships: WCh'85, Atlanta '96, Athen '04, WCh. '05, WCh '07, Beijing '08)

Direct recorded information from the minutes of the bouts

- number of bouts
- duration of bouts
- number of falls
- number of technical points

Indirect observation methods

- simple attack
- complex attack
- attempted attack and completed attacks are registered on a special survey sheet.

### Results

1. As a result of the changing rules of the past years, wrestlers have minimised their actions initiated from standing, have decreased the number of their complex, but spectacular actions, have set themselves for holds worth one or two points. The number of falls and technical falls dramatically decreased in the past years, so - although suitable to TV broadcasting - wrestling has gradually lost its spectacle and spirit.
2. The number of technical points for a time unit decreased, which unambiguously means the devaluation of the contextual value of wrestling, although the length of the bouts shows a tendency to before changes 1985.

### Discussion

- Spectacular throws executed from standing and falls should be valued in a way, that it should mean end of the bout.
- The first action should have a double value and of decisive importance in case of a tie.

### References

1. Barna, T. (1993): Nemzetközi szabadfogású élversenyzők teljesítményének többszemponútú elemzése. TF. Budapest. 1993. Doktori értekezés, Könyvtár.
2. Barna, T. (2002): Cselekvéshatékonyság vizsgálata küzdősportban. TF. Budapest. 2002. Ph.D értekezés, Könyvtár.
3. Földi, L. (2002): Földi. Pécs, Minaret Kiadó 186old.
4. Leni Riefenstahl (1938) OLIMPIA Turul Video Melbourne 2004.



## PART TWO: SPORTS TOURISM

### SPORT AND TOURISM AS COMPLEMENTARY SOCIOECONOMIC PHENOMENA

Zlatko Verunica, Daniela Gračan and Ivana Ivančić

*University of Rijeka, Faculty of Tourism and hospitality management, Opatija, Croatia*

#### Abstract

The paper points out the connection existing between sport and tourism as well as the significance of sport in the tourist offer of certain destinations. Sport facilities, sport activities and professional staff acting within the sphere of sport are deemed the integral elements of the offer in tourism. They contribute to the enrichment of tourist offer and its better positioning on the world tourist market. The paper describes the factors of sport tourism development and analyzes financial effects achieved by sport tourism development, by means of consumption realized by sportsmen during their stay in a destination or tourists pursuing sports activities on a holiday.

**Key words:** *sport and tourist offer, financial effects, consumption, sport tourism*

#### Introduction

Tourism and sport belong to the most important socioeconomic phenomena of the contemporary society. Tradition of tourism and sport is exceptionally long and goes back to the Ancient Rome and Greece, where sport was the main initiator of people's travelling for the purpose of visiting and participating in huge sport events. In modern tourism sport has gained a new, expanded role. Sport in tourism nowadays has not only an observant role, but is considered to be an integral part of the total offer of tourist destinations. Numerous sport programs and forms therefore enable tourists to be actively included in sport and recreational activities during their stay in a tourist destination. In such a way sport represents an additional element in the tourist offer enriching it and making it more attractive for potential tourists.

#### Connection of sport and tourism

The fact that sport and tourism are complementary socioeconomic phenomena is best explained by the fact that the holders of these two phenomena are mostly the same entities. They are both phenomena initiated on the basis of non-economic motives, but with a purpose of satisfying health, entertainment and cultural needs. Ever more prominent connection of tourism and sport has led to the development of a special type of tourism: sport and recreational tourism that represents travelling on holiday for the purpose of pursuing sport or watching sports events (Higham, Hinch, 2009). Various types of sport have caused new forms of sport and tourism infusion. Therefore in contemporary tourism particular forms of sport stand out pointing to the fact that sport stimulates people to travel. They participate in it as spectators of various sport events and manifestations or actively pursue sport during their temporary stay in a tourist destination. To some tourists sport is an entertainment factor to leave their permanent residence due to other motives, for them sport serves as entertainment or recreation by watching or as a means of active holiday (Relac, Bartoluci, 1987). The notion recreation is wider than the notion tourism itself. Recreation includes all types of activities in people's free time contributing to the development of creational potential, health, satisfaction and quality of people's lives ([www.hrks.hr](http://www.hrks.hr)). Recreation's contents need to compensate the needs lacking in people's daily obligations, so the way of life is reflected on free time and contents types within it. Sport recreation uses sport and physical activity for the purpose of satisfying the need for movement and physical activity. However, dynamic and active recreation is identical to tourist recreation. Therefore tourism is only a part of recreation, where the following rule applies: "*Every tourism is recreation, but every recreation is not tourism*". Some authors point out that tourism is an aspect of sport, as many sports are actually a tourist movement. Nowadays the pursuit of sport and recreational activities during travel has become a feature of modern tourists and is an essential part of tourist offer of every destination. Today in modern tourism sport has become not only the contents of stay, but often also the main motive for travel to specific tourist destinations. Such relation of sport and tourism leads to the development of a special type of tourists: sport and recreational tourists (Bartoluci, Čavlek, 1998). Sport in modern tourism has not only a receptive role, but is also an important contents of stay in which tourists become active participants of various sports. In addition to being important contents of stay, sport often also becomes the main motive for travel to specific tourist destinations. Sport and tourism represent the widest and fastest growing industry of global industry today (Higham, Hinch, 2001).

## Factors of sport tourism development

Based on numerous performed researches, the basic factors leading to sport activities in tourism are the following (Relac, Bartoluci, 1987): increase of sport and recreational needs, which occur as the consequence of the modern way of work and living; increase of free time fund, as well as the increase of population's income. Speedy rhythm of life requests an occasional escape from the stressful and busy everyday life. People need relaxation, rest, pursuit of those activities that fulfil them and make them happy, which is why the demand for sport and recreational activities on holiday increases. Free time represents one of the main tourism development factors in general, of sport tourism as well. In tourist pastime the free time fund is the greatest and the possibilities of pursuing various sports activities are better. Regardless of the type of sport and recreational activities, they require consumption of financial resources (whether it is rental of sports grounds, equipment or similar). Sport and recreational needs fall under the order of secondary needs, and as the income increases, also the possibilities of satisfying the secondary needs grow. In addition, one of a very frequently used classification of sport tourism development factors is the following (Bartoluci, 2004): tourist demand factors of sport and recreational services, intermediary factors and factors of sport and recreational offer.

What follows is a scheme that systematically presents the mentioned groups of sport tourism development factors, explained in more detail in the paper's continuation.

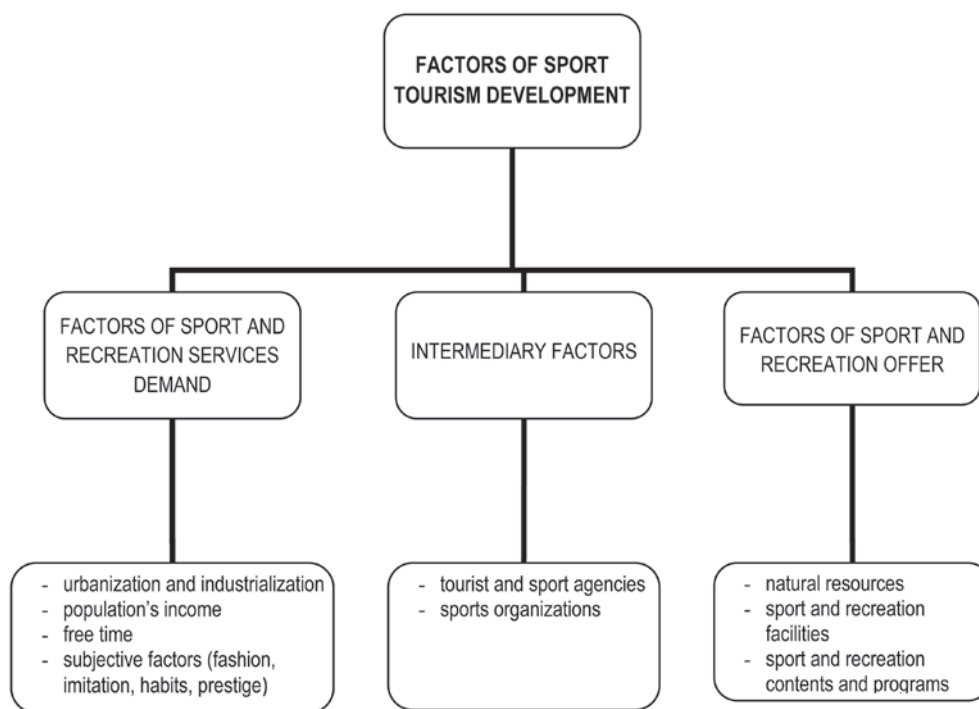

Source: Author's individual elaboration according to Bartoluci, M. (2004). *Sport u turizmu*. Zagreb: Faculty of Kinesiology Zagreb, p. 12.

Scheme 1. Sports tourism development factors

Urbanization and industrialization are found in factors of sport and recreation services demand. They generate sport and recreation needs as the compensation of a modern way of life and work. The development of technology and its increased application in practice have facilitated people's work and reduced their physical activity to the lowest possible degree. Therefore in many cases people do not move enough, by which biological and motor rhythm of human activity is disturbed. In compliance with the obtained imbalance, people feel the need to pursue sport activities. Since sport and recreation activities are mostly financed from personal consumption and fall under the order of secondary needs, so the higher income causes the higher degree of sport and recreation needs satisfaction. Previously mentioned time is an important and fundamental factor in generation of sport and recreation needs of tourists. Due to tourists' need to play, pursue sport and recreate, it is necessary to create appropriate conditions in a tourist destination in order to make the tourists' stay complete and more eventful. Subjective factors influencing the development of sport and recreation in tourism include fashion, imitation, habits, prestige and similar. Tourist and sport agencies, as well as sport organizations of various types, which are the mediators between the offer and demand in sport tourism occur as intermediary factors of sport tourism. The mentioned sport organizations are mostly non-profitable and operate as citizen's associations. Their operation is realized in the way that they realize economic effects from which they settle their operating expenses,

while they invest their realized profit into their own development. Factors of sport and recreation offer in tourism consist of natural and material resources that include sport facilities, battlegrounds, sports props, equipment and similar. The connection between tourism and sport is also realized via various functions generated by these two phenomena, of which more is said in the paper's continuation.

## Functions of sport in tourism

The closeness and affinity of tourism and recreation is also reflected in their polyfunctionality. Regardless of the place and forms in which it is pursued, sport recreation carries out many functions in a contemporary society. Many authors point out that sport, i.e. sport recreation, has primarily non-economic functions of tourism. They refer to health function, entertainment function and similar. However, by detailed analysis of functions that sport has in tourism, a division is found that emphasizes their non-economic and economic character. The functions of sport in tourism are divided to social and economic, while social include various sub-functions. What follows is a scheme that clearly presents mentioned functions and their sub-functions.

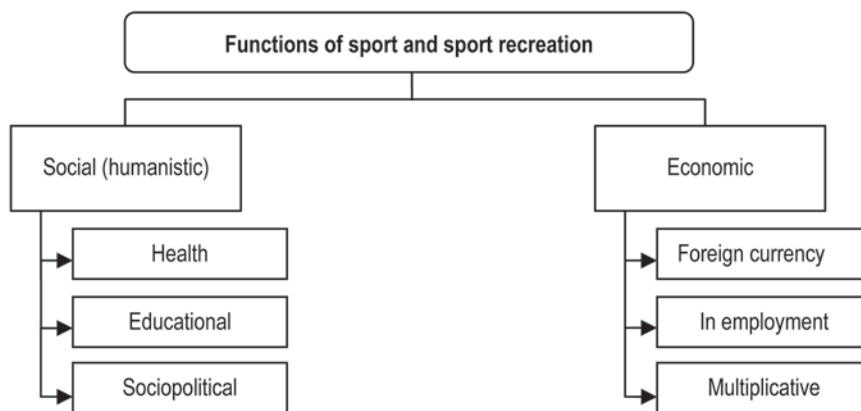

Source: Author's individual elaboration according to Bartoluci, Čavlek (1998). *Turizam i sport*. Zagreb: Faculty for Physical Culture University of Zagreb, Faculty of Economics and Business University of Zagreb, p. 74.

Scheme 2. Functions of sport and sport recreation in tourism

Health function is one of the most important social (humanistic) functions in sport. It is well known that pursuing sport positively influences people's state of health (mental and physical). In modern conditions of living and work, sport recreation becomes an important corrective and compensatory factor (Relac, Bartoluci, 1987). Due to their effects to people's state of organism, sport and sport recreation have lately spread more and more and become the most important form of active holiday. Health function becomes one of the main motives of sport tourism and a strong impulse of its development. That sport has an educational function is reflected in the fact that by pursuing sport activities people learn and overcome specific sport skills. In addition to increasing educational level of tourists, this function shows educational effect that is manifested via creation of habits of pursuing specific sport activities. Pursuit of sport activities during holiday increases the possibility of meeting new people, making friendships and enables people to escape the state of alienation for a certain period. Success in specific sport spheres enables individuals and sport teams to promote their country in a certain way.

As it can be seen in the shown scheme, sport in tourism has also specific economic functions. They are implied by non-economic functions and are realized via additional economic effects on a tourist market. Certain economic effects result from the production of sport facilities and equipment as elements of offer in sport tourism as well as demand settling its needs from them. One of the most important economic functions of tourism in general, as well as of sport tourism, is the foreign currency function. It is well known that foreign tourists, who leave a part of their income in a tourist destination, make the foreign currency influx. This is how the phenomenon of "invisible export" arises, i.e. on-the-spot export, a specific characteristic of tourism that makes positive effects on the host country's balance of payments (Weed, Bull, 2009). The next economic function is the employment function. Development and enrichment of the offer in tourism, and development of sport tourism, request construction of appropriate infra and superstructure, development of various activities and employment of more people. Sport tourism also reflects the multiplicative function since its development requests initiation of directly or indirectly related activities (trade, construction of sport centres, sales and rental of sport equipment, opening of establishments and development of programs for education of professional staff in sport tourism). Economic effects of sport recreation are especially important in tourism since sport is nowadays an important and essential

element of a certain destination's total tourist offer. It needs to be pointed out that economic effects of sport tourism are not only realized in tourist organizations, but also occur outside tourism. Since sport tourism is now included in a wide range of selective forms of tourism, an additional market for a series of products and services is created. Tourism and sport act together and satisfy not only tourist and sport and recreational needs, but also become a generator of additional economic values. Economic effects of sport tourism can be divided to direct and indirect economic effects (Relac, Bartoluci, 1987). Direct economic effects of sport tourism result from immediate provision of sport and recreational services. They are presented in both income and expenses of the following sport and recreation services: services of renting sport facilities and equipment, services of coaching sport activities, programmed active holidays and similar.

Indirect economic effects are economic values of sport recreation contained in total tourist business, arising from the use of sport recreation contents. These effects have as bigger significance as more attention is paid to them within the total tourist offer. They are manifested by means of several factors (Bartoluci, 2004): motivation for tourist destination selection, tourist season prolongation, overcoming of tourism's seasonality, increase of secondary consumption, improvement of diversification and quality of tourist offer, increase of satisfaction and emotional state as well as wish to return to the same tourist spot. Due to their complexity, it is not possible to determine the value of indirect economic effects of sport tourism. Nevertheless, they must be valorised together with direct economic effects in order to obtain a more complete basis to make business decisions.

The increase of "sport overnights" number is very important for operation of tourist organizations that have a developed sport and recreation offer. Thereby the possibilities of season's prolongation are created, but also of greater economic effects. Namely, in off-season the majority of tourists visit tourist places because they wish to pursue sport, and due to the possibility of organizing sport recreation in closed facilities as well, there is no great dependability on weather conditions, which is not the case in swimming tourism.

## Conclusion

Global tourist market changes its preferences from passive to active holidays. Tourists increasingly wish something new, they want to escape from stressful and busy city life and enjoy in nature. However, they also want to spend an active holiday completed by sport and recreational contents and programs. Sport, i.e. sport recreation, has a big role in the enrichment of a tourist destination's total tourist offer. Since modern tourists know more, are more sophisticated and well informed on the destination in which they intend to spend their holidays, this is why it is necessary to offer them "value for money" and meet their expectations. In modern conditions of life, people live fast and consider their free time on holidays very valuable and they want to use it as best as they can. Guest's satisfaction with the offer is the key factor of organizing a successful tourism industry. Guests go and return to a destination in case of a pleasant experience. This is why a room for defined sport and recreational offer is created, which must be presented far more intensively and which will generate new employments from the aspect of macro and micro economics, and will also provide a better financial result in the end.

## References

1. Bartoluci, M. (2004). *Sport u turizmu*. Zagreb: Faculty of Kinesiology.
2. Bartoluci, M., Čavlek, N. (1998). *Turizam i sport*. Zagreb: Faculty of Physical Culture University of Zagreb, Faculty of Economics and Business University of Zagreb, Zagreb Fair.
3. Higham, J., Hinch, T. (2001). Tourism, Sport and Seasons: The Challenges and Potential of Overcoming Seasonality in the Sport and Tourism Sectors, *Tourism Management*.
4. Higham, J., Hinch, T. (2009). *Sport and Tourism - Globalization, Mobilization and Identity*. BH-Elsevier.
5. Relac, M., Bartoluci, M. (1987). *Turizam i sportska rekreacija-organizacija i ekonomika sportsko-rekreacijskih sadržaja u turizmu*. Zagreb: Informator.
6. Weed, M., Bull, C. (2009). *Sports Tourism-Participants, Policy and Providers*. BH-Elsevier. www.hrks.hr, March 2011

## THE ROLE OF SPORT IN PROMOTION OF CROATIAN TOURISM

**Daniela Gračan, Zrinka Zadel and Andreja Rudančić-Lugarić**

*University of Rijeka, Faculty of Tourism and Hospitality Management, Opatija, Croatia*

### Abstract

Thanks to Croatia's beauty of nature and good climate, which are its main comparative advantages, the opportunity to pursue different sport activities makes the stay in Croatia more complete. This is why Croatia needs to expand and enrich the offer of sport and recreational facilities in its tourism supply, to be differentiated from mass tourism and create new forms of products of tourism supply. Based on the analysis of existing sport and tourism supply, the paper points out the necessity of qualitative improvement of sport tourism product. The aim of this paper is to present the proposal of a vision and strategic goals that would help Croatia to become a sport tourism destination, and thus attract increasing demand, yield financial gain and strengthen its image on the world tourism market.

**Key words:** *sport and tourism supply, strategic development, sport tourism, quality*

### Introduction

Croatia's natural resources provide numerous possibilities for the formation of sport and recreational offer. Sport tourism has been developing in all segments of Croatian tourism – in coastal area, in mountains and in continental centres (Bartoluci, et.al., 2006). Adriatic area, mountainous Croatia and the continental part of Croatia offer numerous sport possibilities in water, sport in mountains and individual and team sports in closed and open air spaces. A well designed sport and recreation offer makes the improvement of the possible offer's quality, as well as the prolongation of the tourist season, which also implies other necessary production activities, and yields financial results. Speaking of sport and sport tourism, Croatia does not fall behind the majority of modern tourist countries. In addition to other usual sports, such as football, handball, beach volleyball and tennis, the offer also includes various forms of extreme sports, such as parachuting, paragliding, bungee jumping, rafting, climbing and many others. In compliance with the tourist demand trends abroad, Croatian tourist product should develop by respecting the specificities of individual regions, by means of various special forms of tourism.

### The relation of sport and modern tourism

Sport in modern tourism has not only a receptive role, but is also an important part of the stay in which tourists become active participants of various sports, and it also becomes the main motive for the travel to specific tourist destinations. Sport and tourism today represent the widest and fastest growing industries of global economies (Higham & Hinch, 2001). Sport tourism is a special form, selective type of tourism which is prevailed by sports motives for the trip and stay in specific tourist resorts and centres (Bartoluci & Čavlek, 1998). There are three different types of behaviour linked to sport tourism (Gibson, 1998): active participation (active sport tourism); spectators (event sport tourism), i.e. watching sports events; visiting, providing their contribution (nostalgia sport tourism). Tourist travels motivated by sport and recreation have significantly increased in the last twenty years, and some theoreticians call the recreation the "industry of changes", which has the annual income over 300 billion USD (Bartoluci, et.al., 2004). One of the reasons for such a fast development are the changes of the population's value system in the leading emissive markets, which are becoming increasingly closer to the nature, inclusion in events, and increased quality of life in general. There are many examples of mutually useful impacts of sport and tourism on socioeconomic development and human values promotion. Tourist statistics still records the data on sport-oriented trips in total international tourist flows since the statistics on this type of tourists are not sophisticated enough to support such analyses. The majority of data are based on various forms of estimations. According to the WTO's study from 2001, averagely 32 million trips on German market are motivated more or less by sport, which makes 55% of all Germans' trips abroad. The situation is similar on the Dutch market: 52% or 7 million of all Dutch trips include the sport component. The situation on French market differs from the one on German and Dutch market – only 23% or 2.5 million trips include certain sport component. A study conducted on Belgian market showed the increase of sport holidays and participation in sport activities on vacation, for as much as 1300% within the period between 1967 and 1989 (Bartoluci, et.al., 2004). The link between sport and tourism is especially visible in the organization of major sport events, such as the Olympic Games, world football championships, tennis tournaments and other international championships. Such major and important sport events attract numerous tourists that spend much in a relatively short period. Such major sport manifestations help creating an image and awareness about a tourist destination.

## Sport tourism in Croatia

Sport tourism in Croatia is not given the significance it deserves since Croatia has satisfying preconditions for its development. Namely, in the Development Strategy of Croatian Tourism, which lists the possibilities of developing specific forms of tourism, sport tourism is not presented at all, although Croatian sportsmen are nowadays successful in numerous contests and promote Croatia in this way. An increasing number of people pursue a specific sport activity in their spare time, and sport activities of Croatian tourists occupy a prominent position on the scale of motives stimulating them to visit Croatia. At the strategic level of planning and developing sport tourism, more attention needs to be paid to this segment of tourism. This paper therefore reviews the significance that various sports have, and these are primarily football, tennis and golf, from the aspect of their interaction with tourism.

The partnership of tourism and *football* definitely exists and although it is very positive, it is still insufficiently used in Croatia. The role of football in tourism could be observed within the following areas: (Bartoluci, 2004) football matches and tourism, preparations of teams, camps and tourism, rest, footballers' recovery and tourism, footballers' rehabilitation and tourism. Many tourist entities profit during football matches with a huge number of spectators. Unfortunately, football stadiums are problematic since they are not constructed as multi-purpose facilities in which various performances could be organized, as is the case with modern European stadiums. In case of a part of footballers' preparations, it needs to be pointed out that autumn preparations of Croatian footballers mostly take place in mountains, due to favourable climatic conditions. Mountain centres lack accommodation facilities, adequate sports grounds for training and similar. One aspect of bringing football and tourism together is the establishment of football centres in Croatia, which would organize football schools and camps for children of various ages. *Tennis* should also be mentioned here since it, as an aspect of sports recreation in tourism, has become more and more prominent exactly by means of ever more diversified and frequent offer within the framework of tourist centres. The connection of tourism and tennis as a sport is manifested by the offer of tennis in sport and recreational, but also in a professional form. The situation is quite satisfying in Croatia as far as the number of tennis centres and courts is concerned. However, it is necessary to arrange tennis infrastructure uniformly, tennis offer needs to be raised on a higher level and tourist employees should become aware that the offer of sport programs within and outside the season can have a great impact on decision of tourists to visit certain tourist destinations. More closed tennis halls should be constructed, arranged uniformly along the coast and provided with professional and educated staff that would manage organized tennis programs. *Golf* is one of the most developed and most popular sports in the world today. Within the sphere of tourism, golf represents one of the most profitable activities. In Croatia golf started to be played between the two world wars and at the beginning of 1922 (Bartoluci & Čavlek, 1998), when one of the most beautiful golf courses in Europe at that time was constructed in Brijuni. Golf needs to be a new concept of Croatian tourism since it is a sport attracting the segment of demand that rapidly grows and belongs to a medium and upper financially potent segment of society. The Ministry of Tourism made the Golf Development Program in 1999 as a development policy of Croatian tourism (<http://www.crogolf.com/turizam/index.htm>), which represents the initiative to present Croatia as a quality Mediterranean and European golf destination. Although 19 potential sites for the construction of golf courses were selected in the stated Program, the targeted goal has still not been realized. According to the data for 2007 (Crogolf, 2011), the European golfer market has increased to about 6.5 million of potential tourists that pursue golf and their average daily consumption is approximately €150. Considering the characteristics of today's tourists, it is evident that the offer of sport and recreational elements significantly influences the destination's selection and the prolongation of tourist season. The quality level of offer in sport and recreation activities and facilities needs to be increased and more attention needs to be paid to the creation of competitive tourist product of Croatia.

## Analysis of the current state of Croatia's sport tourism

The analysis of the current condition of Croatia's sport tourism presents qualitative and quantitative features of tourism development in Croatia. There are no statistics monitoring the arrivals and overnights of sport tourism participants, nor there are precise data on the characteristics of tourists whose main motive to visit Croatia is sport. However, the starting presumption is that the majority of tourists that visit Croatia pursue specific sports and recreational activities during their temporary stay, so sport tourism is tackled in that way.

Table 1. Age of Tourists who visit Croatia

Age of Tourists who visit Croatia	(%)
do 27	14
28-47	58
48-64	23
65 and more than	5

Source: Institute for Tourism (2008). *Stavovi i potrošnja turista u Hrvatskoj-TOMAS ljeta 2007*. Zagreb: Institute for Tourism, p. 7

According to the data in the table, it can be noted that the biggest portion of tourists that visit Croatia falls under the age group of 28-47 years (58%), which is followed by tourists of the age group of 48-64 years (23%). The lowest number of tourists visiting Croatia (5%) belongs to the age group of 65 years and more. Viewed from the aspect of pursuing sport and recreational activities, Croatia is visited by the age group that is exceptionally prone to pursuit of various sport activities. If the motives stimulating the tourists to visit and stay in Croatia are observed, it can be noted that sport and recreation are in the seventh place, with as little as 10% share. Passive vacation and relaxation as the main motive of arrival are still mostly represented by the share of 62% (Institute for Tourism, 2008). Out of activities pursued by tourists while on vacation, only those referring to sport and recreational activities are singled out in the following table for the needs of this paper.

Table 2. Sport and recreational tourist activities during their holidays in Croatia

Activities of tourists	(%)
Swimming	More than 70
Walking in nature-hiking	50-70
Diving	30-50
Cycling	
Tennis	
Fishing	

Source: Author's individual elaboration according to Institute for Tourism (2008). *Stavovi i potrošnja turista u Hrvatskoj-TOMAS ljeta 2007*. Zagreb: Institute for Tourism, p. 23

According to the data from the table, the range of sport activities pursued by tourists is not so diversified. The question is whether the reason for it lays in the fact that tourists are not in the "sporty" mood, are not willing to take recreation actively or the offer of sport and recreational programs is monotonous, poor and on an unsatisfying quality level. Since the trends indicate that tourists are more and more active and that in addition to the standard offer they have increasingly used various other programs that also include sport, then it is clear that something needs to be changed in the offer of sport and recreational programs. The structure of average tourist's consumption in Croatia also needs to be analyzed. Average daily tourist's consumption is €55.48. If this is compared to the average daily consumption in other forms of tourism, this is significantly lower (in nautical tourism it is €100 on average, while the participants of golf tourism averagely spend about €150 per day) (Institute for Tourism, 2008). As far as the structure of consumption is concerned, only € 2.94 is averagely spent on sport and entertainment per day, which is only 5.3% of the total consumption. Since the trend is such that tourists are more and more active, the programs of sport and recreation offer need to be enriched and in this way influence the higher consumption of this segment of tourists alone. It is necessary to stimulate the awareness on the importance of pursuing sport on all levels, as well as to attract foreign visitors by an interesting offer and organization of various contests. According to the data of the Ministry of the Sea, Tourism, Transport and Development of the Republic of Croatia, sport manifestations in Croatia were visited by 91,555 visitors in 2002, 32.3% of whom were foreign tourists. Such sport manifestations need to be encouraged since in addition to the economic impact, it is the best way to promote Croatia in the world. It can be concluded that Croatia has not only huge comparative advantages, but exceptionally valuable human potentials (many successful Croatian sportsmen, professional staff), who need to become aware that tourists during their arrival to a destination look for an active vacation by means of sport and recreational activities.

### System of development objectives of Croatia's sport tourism

The vision of Croatia's sport tourism development, which is mentioned in the proposal of the Sport Tourism Strategy, states that Croatia could become an "intelligent green zone in Europe" (Ministry of Science, Education and Sports of the Republic of Croatia). The aspiration is to, among other things, develop and expand the habit of sport pursuit to all population's age groups, whereby Croatia would become a "sport nation". It is also stated that sport is one of the most favourable and most appropriate activities for the affirmation of a healthy lifestyle in Croatia. In this way people would be more dedicated to the protection of non-renewable and unspoiled natural resources that Croatia can fortunately be proud of. However, the proposal of the Development Strategy of Croatian Tourism brings no concrete guidelines on the future development of sport and tourism, their interaction is not pointed out, nor the results that Croatia would gain by a stronger inclusion of sport in tourism. Therefore as the vision of Croatian sport tourism development the aspiration could be stated that Croatia should become one of the most famous tourist destinations with a developed sport and recreational programs offer, i.e. that it should become famous as a destination of "sporting spirit and true sporting talents". In the follow up there is a scheme presenting strengths, weaknesses, as well as opportunities and threats in the sport tourism development in the total tourist offer of Croatia.

Scheme 1. SWOT matrix of development of Croatian sport tourism

STRENGTHS	WEAKNESSES
<ul style="list-style-type: none"> <li>• favourable geographical position</li> <li>• preserved resources basis and favourable climatic conditions</li> <li>• rich cultural and historical heritage</li> <li>• rich and quality gastronomic offer</li> <li>• professional staff in the area of sport, i.e. sports recreation</li> <li>• traffic availability</li> <li>• closeness of emissive markets</li> <li>• years-long tourist tradition</li> <li>• safety in the country</li> <li>• natural potentials for the development of various forms of sport (golf, skiing)</li> <li>• Croatian sport legends</li> <li>• organization of sports contents</li> </ul>	<ul style="list-style-type: none"> <li>• insufficient number of educated staff</li> <li>• insufficient awareness level on the need to improve sports and recreational offer</li> <li>• unsatisfying number and equipment level of sports facilities</li> <li>• financing of sport centres from the budget (neglect of sport)</li> <li>• administrative impediments in the development of specific types of sport (golf tourism)</li> <li>• unsatisfying quality level of services in facilities for guests accommodation</li> <li>• exceptionally pronounced seasonality of tourism</li> <li>• inadequate marketing activity</li> <li>• there is no development strategy of sport tourism</li> </ul>
OPPORTUNITIES	THREATS
<ul style="list-style-type: none"> <li>• prolongation of tourist season</li> <li>• improvement of tourist product quality, enrichment of total offer</li> <li>• realization of major financial effects</li> <li>• reduction of seasonality</li> <li>• increase of employment</li> <li>• improvement of tourist destination image</li> <li>• development of sport tourism offer</li> <li>• entry to new markets</li> <li>• increase of foreign investments</li> </ul>	<ul style="list-style-type: none"> <li>• development of specific types of sport or construction of sports facilities, which would lead to environmental pollution or impairment of fragile ecological balance</li> <li>• competition enhancing in the development of specific types of sport (golf)</li> <li>• political situation in the world</li> <li>• recession</li> <li>• falling behind in tourist development</li> <li>• disorders on emission markets</li> </ul>

Source: Author's individual elaboration

Croatia needs to pay more attention to the development of this aspect of tourism. It is necessary to enrich and modernize the existing facilities and equipment. As the range of sports is so diversified and each season emphasizes the pursuit of a specific type of sport, certain sports can be pursued throughout the entire year, so the enrichment of the offer and development of sport tourism can prolong the tourist season, whereby also realizing numerous positive effects.

## Conclusion

There is a great potential in sport and sport recreation that can and has to be used for tourist purposes. Modern tourist offer cannot be imagined without sport and recreation contents. The most requested tourist destinations today are the ones enabling tourists to pursue various activities. A well designed sport and recreation offer may improve the quality of service and extend the tourist season. Despite Croatian natural resources that represent a specific tourist competitive advantage, it is necessary to develop new elements and contents of the tourist offer, which are requested by tourists during their stay in a tourist destination. Croatia has exceptional comparative advantages for the development of various forms of sport and recreation in tourism. Croatia needs to expand and enrich the offer of sport and recreational programs in its offer. The objective of awareness raising on the importance of sport, i.e. sport and recreational activity in the total tourist offer of Croatia, by using the media and propaganda messages, is important in the future of Croatian sport tourism development. The revitalization of derelict and insufficiently equipped sports centres is needed, as well as the construction of new sports and recreational grounds, in places where their offer is insufficient (e.g. construction of covered tennis courts in the coastal area). Croatia's image as a sport tourist destination should be built by marketing. Education should be carried out by organizing schools and seminars for advanced training of experts who would work in the business line of sport recreation and as sport animators, and by organizing sports events and contests in order to increase efficiency of newly built halls.

## References

1. Bartoluci, M., (2004). *Sport u turizmu*. Zagreb: Kineziološki fakultet.
2. Bartoluci, M., et.al. (2004). *Menedžment u sportu i turizmu*, Zagreb: Sveučilište u Zagrebu
3. Bartoluci, M., Čavlek, N. (1998). *Turizam i sport*. Zagreb: Fakultet za fizičku kulturu Sveučilišta u Zagrebu, Ekonomski fakultet Sveučilišta u Zagrebu, Zagrebački velesajam.
4. Bartoluci, M., Omrčen, D., Andrijašević, M. (2006). Ekonomska osnova razvoja sportskog turizma na primjeru modela poduzetništva, *ACTA TURISTICA*, vol. 18.
5. Gibson, H. (1998). Sport Tourism: A Critical Analysis of Research, *Sport Management Review*.
6. Higham, J., Hinch, T. (2001). Tourism, Sport and Seasons: The Challenges and Potential of Overcoming Seasonality in the Sport and Tourism Sectors, *Tourism Management*.
7. Crogolf (2011). *Golf i turizam /online/*. <http://www.crogolf.com/turizam/index.htm>, retrieved in May, 2011.
8. Institute for Tourism (2008). *TOMAS 2007. - Stavovi i potrošnja turista u Hrvatskoj*. Zagreb.
9. Ministry of science, education and sport (2000). *Prijedlog strategije razvoja hrvatskog sporta*, Zagreb.



## MANAGING WELLNESS DEVELOPMENT IN CROATIAN TOURISM

Mato Bartoluci<sup>1</sup> and Sanela Škorić<sup>2</sup>

<sup>1</sup>University of Zagreb, Faculty of Economics and Business, Croatia

<sup>2</sup>Faculty of Kinesiology, University of Zagreb, Croatia

### Abstract

The development of wellness tourism can create numerous economic benefits for a tourism destination. However, in order to generate the best possible gains, wellness tourism development has to be well managed, and various experts have to be involved in this process – from managers to kinesiology experts. This is mostly due to the fact that wellness tourism implies development of a very versatile offer, and a constantly changing tourism demand. This type of tourism can be especially beneficial for Croatian tourism in general since it is usually developed in destinations that already have the health tourism infrastructure, i.e. spas.

**Key words:** *wellness offer, wellness experts, managing wellness centres*

### Introduction

The term wellness appeared in the literature in 1654 and represented health and comfort (Stemper, 2004:371). However, wellness as we know it nowadays, developed in 1970s as fit wellness and a part of medical treatments (Andrijašević, 2010:374). Wellness actually appeared as an answer to demands of modern way of working and living. In today's society being active is not only a practical need. For many people it is the life philosophy cultivating both the spirit and the body (Andrijašević, Bartoluci, 2007:439). Therefore, it encompasses not only exercise and movement, but a series of programmes that help modern people in solving their problems and improving their health. Examples from the most developed tourism countries of the European Union (EU), as well as the Far East, USA and Australia, show that wellness gains a special role if developed as a part of health tourism, but also as a part of sports, congress, cultural and nautical tourism. Croatia is a receptive tourism country that increasingly turns towards the development of wellness. The aim of this paper is to analyse the role of wellness as a part of health tourism, and to give certain guidelines for effective management of wellness centres in Croatian tourism. The main hypothesis is that a wellness centre can be efficient only if managed by experts of various profiles: medical doctors, kinesiology experts, and wellness managers.

### Wellness as a part of health tourism

Rest and relaxation in favourable climate conditions affect the health of the people in a very positive way. Although it might be debatable “as to how far a transitory phenomenon can make a significant difference to long-term health” (Smith, Puczkó, 2009:9), tourism can contribute to many dimensions of health. Actually, according to Alfier (1994:209), health is one of the oldest, most durable and strongest motives of tourism movements, and tourism always fulfils its health function. This non-economic function of tourism (Vukonić, Čavlek, 2001:454) is conducted in various ways and through specific medical treatments, rehabilitation and health preservation programmes. Therefore, tourists are motivated to travel to tourist and health centres that can satisfy their health needs (Bartoluci in Čavlek et al., 2011:356), so that special interest type of tourism called health tourism develops. **Health tourism** develops in destinations that have a favourable climate, destinations near hot springs and other natural agents that can affect the health of people in a positive way. One part of health tourism is concerned with people who are ill, but another part is oriented towards the customers that are actually healthy (Mueller, Kaufmann, 2001:4). A subset of health tourism that deals mostly with healthy people is wellness. Wellness is a holistic concept, and most forms of wellness tourism do not include the medical or curative dimension as opposed to medical tourism (Smith, Puczkó, 2009:8) which deals with people who are ill. Although one can encounter some difficulties when defining the term wellness (see more in Corbin, Pangrazi, 2001), all authors agree that “wellness no longer constitutes the mere physical nature of the body” (Smith, Kelly, 2006:1). Metz's explanation is appropriate for the explanation of the term wellness. He defines it as (1999:26) “a state of health featuring the harmony of body, mind and spirit, with self-responsibility, physical fitness/beauty care, healthy nutrition/diet, relaxation, mental activity/education and environmental sensitivity/social contacts as its fundamental elements.” Therefore, wellness tourism “describes a phenomenon to enhance personal wellbeing for those travelling to destinations which deliver services and experiences to rejuvenate the body, mind, and spirit of the participants” (Chen, Prebensen, Huan, 2008:110). The exact numbers concerning the quantity of this market are not available, but some estimates do exist. For example, there were approximately 47.9 million spa trips in Europe in 2007, with the expenditure being US\$ 48.4 billions (Biging, 2009).

Although estimations for the region of Asia-Pacific concerning trips were higher (53.3 million), the estimated expenditure was lower (US\$ 26.9 billions).

According to Smith and Puczkó (2009:9-10), wellness tourists “need to be in good enough physical health to embark on a journey, as well as being materially affluent”, i.e. wellness is “time consuming and expensive”. Also, majority of wellness tourists are already active at home in some form of a wellness-enhancing activity (e.g. training for fitness, yoga, meditation, massage, healthy dieting), and seek locations and activities that are transcendent. So, it is no wonder that wellness today develops more and more as a specific subtype of high quality health tourism in various destinations: in urban (city) destinations, in rural areas tied to rivers, lakes, and hot springs, in mountains, and especially at the seacoast. At destinations and hotels at the seacoast, wellness can be a leading tourist product, especially outside the main tourism season. This is particularly favourable for Croatian tourism destinations since the main season lasts about 4 to 6 months, so that the sports and wellness offer can develop during the rest of the year. This kind of tourism development is already present in the most developed Mediterranean countries, such as France, Spain, Italy, Greece, Turkey, Slovenia, but lately also in Croatia. A similar thing happens in **winter sports destinations** where wellness is such an important part of tourism offer that it is even being called Alpine wellness (Weiermair, Steinhauser, 2003) which can be seen in skiing centres of Austria, Italy, France, Switzerland, Slovenia and some other countries. Wellness creates new challenges and development possibilities in the continental part of Croatia since the majority of spas are located in this area. These are Bizovac, Daruvar, Krapina, Stubica, Tuhelj, Varaždin, Naftalan Ivanić Grad, Lipik, Topusko and Sveti Martin spas. At the same time research has shown that wellness packages in the continental part of Croatia have the greatest annual number of participants, and generate the highest annual income from these services (HC, 2009). However, only some of them have developed wellness as a special segment of the health-tourism offer. High quality of natural resources, as well as high expertise of medical staff, point to additional development possibilities of wellness and its contribution to gaining the competitive edge. The accession of Croatia to EU will benefit this process since it will open new markets. However, every project concerning wellness development requires precise studies about market possibilities as well as economic efficiency investment studies in order to determine profitability and risks of investment.

### Managing wellness programmes in tourism

Regardless of the type of tourism destination wellness is developed in, there are numerous advantages and economic benefits of its development (more in Sheldon and Park, 2008:153-154). It is exactly these economic gains that make this type of entrepreneurial projects attractive for development in various tourism destinations. But, what does it mean to develop wellness tourism, or wellness offer? Research conducted by Chen, Prebensen and Huan (2008:114) suggests that customers motivated to wellness facilities are apt to seek an environment that relaxes their body, mind and spirit while they are able to engage various programmes and access to nature. Therefore, various wellness modalities can be identified at the market, such as (Sheldon, Park, 2008:156-158): fitness and sport; complementary treatments (acupuncture, chiropractic, kinesiology, naturopathy, energy work, herbal remedies, homeopathy, traditional Chinese medicine, Ayurveda, and intuitive healing sessions); indigenous cultures (intrinsic spiritual and healing qualities of a land, knowledge and aspects of local history and culture); healing accommodations (with healthy food options, ecologically-sensitive environments, etc.); lifestyle modification (life coaches, holistic health practitioners, diagnostic systems, counsellors, nutritionists, etc.); nature experience (meaningful encounters with the natural environment through hiking, swimming, etc., as well as the use of natural and organic materials such as herbs, seaweed, mud, and flowers); relaxation and rejuvenation (yoga, Tai Chi, Pilates, massage, skin care); inner pilgrimage (self-actualisation, personal development); etc. However, the sole existence of an offer is not a guarantee of comprehensive and quality wellness tourism. According to research conducted in Switzerland wellness hotels, a prerequisite for comprehensive wellness quality is a minimum wellness infrastructure, the corresponding services and qualified staff (Mueller, Kaufmann, 2001:11). Since the question of wellness programmes is rather complicated and, as shown previously, consists of many different programmes, it is clear that professional personnel developing this offer is needed. Also, the demand side of the market constantly changes and wellness programmes become more diverse, which creates a need for additional professionals. For example, according to *SpaFinder's 2011 Spa Trend Report* (SpaFinder, 2011), due to various trends detected in the spa and wellness market, we shall see more spas featuring exercise physiologists, sports medicine professionals, chiropractors, orthopaedics, naturopaths and physical therapists on staff (or on call). It seems that market has recognised this need since more and more schools for training professional personnel in wellness appears even in Croatia. They educate experts like wellness therapists, wellness managers, wellness receptionists, wellness masseurs, etc. (see Edukacija.hr, 2011). Although this diversity and quality of services offered in wellness can be its strength, the fact that there is a lack of qualified personnel represents a threat (Nemec Rudež, 2011:256-257). Therefore, managing wellness tourism is a complex process for a destination as a whole, and not only for a hotel. Regardless of the type of wellness offer developed in a certain destination, the best effects will be created only if a destination incorporates its specific characteristics with the necessary infrastructure. In other words, when planning for wellness tourism development, it is necessary to identify core wellness resources and attractors that make the destination unique (more on the model of wellness destination see in Sheldon, Park, 2008). The development and management of wellness centres cannot be successful and sustainable without a clear vision, setting of the specific

goals and positioning in the market. It would be even more efficient if a partnership would unite the necessary resources and set the standards of quality, valorisation and control (Sheldon, Park, 2008:166-168). It is exactly on these foundations that wellness should develop in Croatia as well. The project Wellness Istria, which encompasses “the integration of high quality typical agricultural products, culinary tradition, natural and cultural heritage and spa centres in tourism offer of sustainable wellness destination called Istria” (Jurinčić, et al., 2011:340) supports this thesis.

In order to present in more detail the management of wellness centres in Croatia, it is necessary to identify their number, structure, type of ownership and current management. From the brief analysis conducted for the purpose of this paper, several remarks concerning wellness offer in Croatia can be made:

- the majority of wellness centres develop in hotels (in spas, at the seaside, in mountain tourism and larger cities);
- wellness is usually a part of health tourism offer;
- wellness programmes are mostly based on nature experiences, such as hot springs, seawater, climate benefits of the sea, mountains, etc.;
- in larger cities wellness is a part of a luxury hotel offer (4 or 5 star hotels), and a part of fitness centres offer.

The analysis shows that not every wellness is “real” wellness, and that not every wellness is a part of health tourism. Namely, Croatia has not yet developed the criteria for using the term *wellness*. Therefore, it is clear that there is no possibility to categorise wellness centres. However, certain steps to improve this situation have been made since, according to the *Association of wellness tourism*, which is a part of Croatian Chamber of Economy (CCE, 2011), guidelines for the development of strategy and standards of Croatian wellness have begun to develop. We find the fact that it is not possible to say how many or what kind of wellness centres exist in Croatia to be the biggest problem. The Association currently holds 44 members (not an exact number), and has started to establish a brand called “Croatian wellness”. The membership in this brand will be conditioned by quality standards that are yet to be developed. Since it is not possible to find accurate data on wellness centres in Croatia, the problem of ownership and management will be addressed by looking into the examples of centres that are a part of broader health centres (Bartoluci, 2010). These types of health centres are mostly owned by counties, i.e. Ministries of health and tourism. They have 6,338 beds, out of which 46% is under the contract with the Croatian Institute for Health Insurance. These spas and special hospitals act as non-profit organisations that do not have greater investment possibilities, which disables them in their attempts to become competitive in the market. Therefore, it is necessary to include other types of ownership, such as public-private partnerships or even solely private partnership. At national level they are managed by Ministries (of health and tourism) and *Association of health tourism* established by CCE, and at regional level by counties, cities, or **health centre management**. Top-level management is represented by directors, medical experts, etc., middle-level management by heads of departments, medical and other staff, and the first-level management again by medical staff as well as by technical and clerks. It can be said that ***wellness centres management conducts following functions***: pursues the accomplishments in wellness tourism management; manages the total quality of wellness; applies quality standards; uses certification schemes as a prerequisite for achieving competitiveness; manages various wellness programmes; manages the whole business system (investments, buyers, suppliers, income, expenses, employees, etc.).

Regardless of the management model used in a wellness centre, a number of qualified professionals of various profiles, such as medical doctors, kinesiology experts, managers, and other expert personnel, is needed. The overall quality of a wellness offer depends on a quality and synergy of every service provider in a centre, i.e. the quality of human resources. Good quality management in wellness centres is a necessity for achieving competitiveness in the market, as well as profitable business. Profitability can be achieved directly on the basis of wellness services sale. This is the case with wellness centres organised as independent organisations. However, more often, as was seen in the case of Croatia, wellness centres act as a part of a larger business unit such as a hotel or a health centre. In this case, wellness is a part of the overall offer and its profitability depends on economic efficiency of all services provided by a business unit. However, even in this case wellness can have an important role in overall success of an organisation provided that it is managed by wellness experts.

## Conclusion

Wellness integrates various programmes and treatments intended for overall health improvement of modern society. It does not encompass only exercise aimed at improving physical health, but various programmes for the betterment of the mind and soul as well. By developing this type of tourism offer destinations can generate numerous advantages and economic gains, but only if managed correctly which requires professional specialised personnel. This requirement for professional personnel is even more emphasised when the fact that it is not precisely identified what this offer consists of, so the system of wellness centres categorisation is impossible to conduct, is taken into account. Special possibilities for the development of wellness offer can be found in the continental part of Croatia where the majority of spas already exist. These destinations already have numerous natural resources, as well as necessary medical experts which gives them an opportunity for the development of health and wellness tourism.

## References

1. Alfier, D. (1994). *Turizam*. Zagreb: Institut za turizam.
2. Andrijašević, M. (2010). *Kineziološka rekreacija*. Zagreb: Kineziološki fakultet.
3. Andrijašević, M., Bartoluci, M. (2007). Razvoj wellnesa u turizmu. U: M. Bartoluci, N. Čavlek i sur., *Turizam i sport-razvojni aspekti* (str. 196-204). Zagreb: Školska knjiga.
4. Biging, A. (2009). *Wellness Travel – An International Perspective* /online/. <http://www.slideshare.net/whatidiscover/wellness-travel> (27.4.2011.)
5. CCE (Croatian Chamber of Economy) (2011). *Grupacija wellness turizma* /online/. [http://www.hgk.hr/wps/portal/lut/p/\\_s.7\\_0\\_A/7\\_0\\_P8?legacyWcmClippingUrl=http%3A%2F%2Fhgk.biznet.hr%2Fhgk%2Ftekst3.php%3Fa%3Db%26page%3Dtekst%26id%3D1931%26kid%3D1026%26skid%3D2099](http://www.hgk.hr/wps/portal/lut/p/_s.7_0_A/7_0_P8?legacyWcmClippingUrl=http%3A%2F%2Fhgk.biznet.hr%2Fhgk%2Ftekst3.php%3Fa%3Db%26page%3Dtekst%26id%3D1931%26kid%3D1026%26skid%3D2099) (21.1.2011.)
6. Chen, J.S., Prebensen, N., Huan, T.C. (2008). Determining the Motivation of Wellness Travelers, *Anatolia: An International Journal of Tourism and Hospitality Research*, 19(1), pp. 103-115
7. Corbin, C.B., Pangrazi, R.P. (2001). Toward a Uniform Definition of Wellness: A Commentary. *Predident's Council on Physical Fitness and Sports Research Digest*, 3(15), str. 1-8
8. Čavlek, N., Bartoluci, M., Prebežac, D., Kesar, O. i sur. (2011). *Turizam: Ekonomske osnove i organizacijski sustav*. Zagreb: Školska knjiga. (u tisku)
9. Edukacija.hr (2011). *Verificirani programi* /online/. <http://www.edukacija.hr/neformalno-obrazovanje/verificirani-programi/kategorija/zdravstvo-i-ljepota/stranica/7> (28.4.2011.)
10. HC (Horwath Consulting) (2009). *Prodaja paket aranžmana wellness/medicinskog turizma u hotelima* /online/. <http://www.hgk.hr> (21.1.2011)
11. Jurinčić, I., Nemeč Rudež, H., Sedmak, G., Vodeb, K. (2011). Slovenski dio Istre kao turistička destinacija. In: I. Jurinčić and assoc., *Istra – autentična destinacija dobrog ugođaja* (pp. 337-358). Portorož, Poreč: Univerza na Primorskom Fakulteta za turistične študije Portorož-Turistica, Institut za poljoprivredu i turizam Poreč.
12. Kušen, E., Mezak, V. (2005). Hrvatski wellness hoteli, *Turizam*, 53(4), pp. 397-405.
13. Metz, C. (1999). *Wellness-Tourism*. Bern: Berner Studien zu Freizeit und Tourismus.
14. Mueller, H., Kaufmann, E.L. (2001). Wellness Tourism: Market analysis of a special health tourism segment and implications for the hotel industr, *Journal of Vocational Marketing*, 7(1), pp. 5-17.
15. Nemeč Rudež, H. (2011). Wellness. In: I. Jurinčić and assoc., *Istra – autentična destinacija dobrog ugođaja* (pp. 253-260). Portorož, Poreč: Univerza na Primorskom Fakulteta za turistične študije Portorož-Turistica, Institut za poljoprivredu i turizam Poreč.
16. Sheldon, P.J., Park, S.Y. (2008). Održivi wellness turizam: Upravljanje i problemi poduzetništva / Sustainable wellness tourism: governance and entrepreneurship issues, *Acta Turistica*, 20(2), 151-172
17. Smith, M., Puczko, L. (2009). *Health and wellness tourism*. Oxford: Elsevier Linacre House.
18. Smith, M., Kelly, C. (2006). Wellness Tourism, *Tourism Recreation Research*, 31(1), pp. 1-4.
19. SpaFinder (2011). *SpaFinder's 2011 Spa Trend Report: Top 10 Global Spa Trends to Watch in 2011* /online/. [http://www.spafinder.com/about/press\\_release.jsp?relId=205](http://www.spafinder.com/about/press_release.jsp?relId=205) (28.4.2011)
20. Stemper, T. (2004). Wellness-definicija, sadržaj i primjena. U: M. Bartoluci (ur.), *Sport u turizmu* (str. 371-377). Zagreb: Kineziološki fakultet.
21. Vukonić, B., Čavlek, N. (ur.) (2001). *Rječnik turizma*. Zagreb: Massmedia.
22. Weiermair, K., Steinhäuser, C. (2003). New Tourism Clusters in the Field of Sports and Health; The Case of Alpine Wellness, *12<sup>th</sup> International Tourism and Leisure Symposium, Barcelona, 2003* /online/. [http://www.growourregion.ca/images/file/Clusters\\_value\\_chains/NEWTOURISM\\_CLUSTERS\\_TOURISM\\_SPORTS\\_ALPS\\_WELLNESS.pdf](http://www.growourregion.ca/images/file/Clusters_value_chains/NEWTOURISM_CLUSTERS_TOURISM_SPORTS_ALPS_WELLNESS.pdf) (28.4.2011)

## MANAGING WELLNESS OFFER BASED ON TOURIST ANALYSIS IN COASTAL CROATIA

Zvezdana Hendija<sup>1</sup> and Snježana Boranić-Živoder<sup>2</sup>

<sup>1</sup>Department of Tourism, Faculty of Economics/ Business University of Zagreb, Croatia

<sup>2</sup>Institute for Tourism, Zagreb, Croatia

### Abstract

As a part of European Mediterranean, Croatia is traditionally considered to be a 'sun and sea' destination, which is confirmed by the fact that the majority of tourism flow is generated in coastal destinations and during the summer season. This is a consequence of the main reasons to choose Croatia as a tourism destination. Rest and relaxation are the main motives for tourists to come to Croatia (to more than 75% of guests during the last decade), while only 4 to 6% guests are motivated by wellness and health (WH) reasons. In spite of that, involvement of tourists in health-recreational and wellness (HRW) programs is continuously pointing a growth trend. Every third guest today is involved in those activities. The goal of this paper is to analyze the number and structure of tourists involved in HRW programs during their summer vacations in Croatia, as a function of improving management of wellness offer. The main hypothesis of the paper is that there is a disproportion between tourists' motivation with WH activities and their involvement in HRW programs, which is the assumption of successful management of wellness offer. In proving this hypothesis a quantitative analysis of tourism demand was conducted based on primary research data. The scientific methods used in the paper are desk research and SWOT analysis.

**Key words:** *wellness, tourism demand for wellness programs, managing wellness offer in Croatia*

### Introduction

The concept of health tourism is still not entirely explained, despite constant efforts of numerous domestic and international authors. Often there is a mix up between the concept of health tourism and spa, and during the last several years also between the wellness and each day more popular medical tourism (which includes various forms of medical treatments). Health is the oldest and strongest motive for travel, later also for tourism movements (Alfier, 1977:199; Hitrec, 1998:2; Smith, Puczkó, 2009:10). Based on the motive for preserving health special interest tourism was developed (from 18th century) as one of the oldest specific form of tourism (Bartoluci, Škorić, 2011:20). Health tourism is a special interest tourism within which natural salutary factors are used in a professional and controlled way and treatments of physical therapy with a goal to preserve and improve health and to enhance the quality of life (Kušen, 2006:177). It is related to places and areas with favourable climate, to thermal springs of salutary waters and to other natural agenses that can have a positive influence on health (Bartoluci in Čavlek et al., 2011:297). People's physical, mental and spiritual health can be improved by using climate, spa and natural salutary factors. In theoretical debates on health tourism, the greatest confusion is made between the terms of health prevention, cure treatment and medical tourism. While cure treatment and medicine are dealing with curing degraded health, the aim of health prevention is to block the occurrence of various forms of illness (Bartoluci, Hendija, 2011:287). Health prevention tourism is often combined with health-recreational activities, which create the elemental component of active holiday called health preventive tourism. It is based on medical and other health-recreational programs whose goal is to prevent illness and to preserve health. Such programs have appeared during the 1980s under the term medically programmed active vacations and they represent the forerunner of wellness (Bartoluci in Čavlek et al., 2011:297). Wellness can be defined as overall concept of health, and it includes all areas of healthy movements, physical exercises, nutrition, relaxation and managing stress (Bartoluci in Čavlek et al., 2011:297). The essential difference between the medical tourism and wellness lies in the fact that the users of medical tourism services are reactive, since the illness has made them travel to get the treatment, while the users of wellness are proactive, as they completely voluntary undertake various activities with the goal to improve their health (Pilzer, 2007:27). Wellness is getting more important place within contemporary tourism. It is not used only within health tourism, but is also intensively used in all other forms of tourism. The concept of unified mass 'sun and sea' tourism has long ago been changed under the influence of wider social and economic changes, as well as under technical and technological improvement of mankind. Today, tourists are characterized by their extremely diverse forms of interests and activities. People have higher expectations of their vacations, while at the same time travelling has become a part of lifestyle and human culture. It is more important to tourists the way of spending unforgettable vacation, than where to spend it (Čavlek, Matečić, Ferjanić Hodak, 2010:209).

Service providers in tourism destinations have realized two decades ago the necessity of enriching the offer with wellness services (Bartoluci, Čavlek, 2007:196). Wellness can improve health-tourism offer and can create additional economic effects (Bartoluci in Čavlek et al., 2011:298). As a part of the hotel offer, wellness tourism is, as an international tourism supply and demand trend, recognized also in Croatia, through the growing wellness services offer. This kind of offer in Croatia is provided (today) in more than 80 hotels (CNTB Brochure, 2009) and in Switzerland in 300 hotels (2001) (Mueller, Kaufmann, 2001:1). This information stresses our backwardness after competition. In the literature dealing with wellness, the most researched areas are the structure of programs (Sheldon, Park, 2008:156; Kušen, Mezak, 2005:402), the issue of human resources (Bartoluci, Birkić, 2011:53), but very few domestic, even international papers are dealing with analysis of wellness services users (Mueller, Kaufmann, 2001:1). The goal of this paper is to expand knowledge about the users of wellness services in Croatian tourism.

### Characteristics of tourists as the users of wellness services in coastal Croatia

Croatia is traditionally 'sun and sea' destination, which is confirmed by the fact that the majority of tourism flow is generated in coastal destinations (94% of 51 mil. overnight stays in 2010) and during the summer months (87% of overnight stays from June till September in 2010), all of which is a consequence of the main reasons why tourists choose Croatia as a tourism destination (BIST, 2011). The Tomas market researches that are conducted in our coastal destinations during the summer season show that 'rest and relaxation' are dominant motive for over 2/3 of guests that come to Croatia, while 'WH reasons' are less important motives of arrival (for about 4-6% of guests from 2001 to 2010) (Tomas trends, 2009:26; Tomas summer, 2011:40). However, due to the socio-demographic and other social changes and the changes of European populations' lifestyle, there is a growing need for various activities within the destination. Among those activities health-recreational and wellness (HRW) programs are increasingly enhanced. Every third guest in Croatia is involved in one of those programs (Table 1).

Table 1. Tourists' motivation and activities in Croatia's coastal destinations during the last decade – chosen results of wellness and health research (in %)

	2001	2004	2007	2010***
Guests' motivation* with health and wellness	4.2	5.1	5.0	6.4
Involvement in health-recreational and wellness programs**	10.8	23.6	24.8	32.5

\*Examinees could give more than one response to the question about the motive of arrival.

\*\*Percentage of examinees that undertake the activities in tourism destination sometimes or often

\*\*\*Wellness is included into research since 2010

Source: Tomas trends (2009), Tomas summer (2011)

During the last decade, the number of tourism arrivals motivated by health reasons and wellness in Croatia doubled, growing from 330 thousands (2001) to 680 thousands (2010). Out of the given number (2010), every fourth guest (180 thousands) was motivated only with wellness. The number of participants involved in HRW programs is even larger and is expanding faster. Their number was enlarged four times, from 850 thousands (2001) to 3.4 mil. (estimated data). There is a noticeable trend of growing number of HRW programs' users in coastal tourism destinations, which assigns the need of enriching and better managing that offer. In the structure of Croatia's visitors foreign tourists (90% share in overnight stays), mostly coming from European countries predominate. According to Eurobarometer research on travel attributes of Europeans (European Commission, May, 2001:5), in 2010 even 78% of Europeans have travelled for personal purposes, mostly because of 'rest and recreation' (36%) and because of 'sun and beaches' (18%). Among the other reasons to travel (visiting cities, events, nature etc.), 3% of Europeans have travelled for health treatments and wellness. This is a basis to estimate that they have generated about 19 mil. of vacations motivated with wellness activities and the care about the health. Sociodemographic characteristics of those tourists have confirmed the usual structure of wellness users which shows that the women population is more motivated (3.4% compared to average 3%), as are the Europeans older than 55 years of life (5.4%), while there is a smaller share of youth between 15 and 24 years of life (1.3%). Smith and Puczkó (2009:134) similarly describe a typical wellness user. Women are using wellness programs more often because of the fashion, beauty, society attitude and media pressure, as well and the older population primarily because of preventive-health programs. The set out data match with the structure of guests that visit Croatia and participate in HRW programs, since guests older than 50 years of life are more involved in those activities (41% by comparison with average 32.5%), unlike younger than 29 years of life (25%) (Tomas 2011:57). Pilzer claims that the users of wellness programs are mostly members of co-called "baby-boom" generation, between 40 and 60 years of life. Also, he points out that this is the first generation in the history of mankind that struggles to slow down the ageing process with positive attitude toward life (Pilzer, 2007:27). Adjusting the offer of wellness program has also contributed to inclusion of larger number of users of those services, with regard to economic possibilities of contemporary tourists. While during the previous time periods

wellness was accessible only to chosen smaller number of elite guests of higher income, today it is offered more to customers of average purchasing power and the number of wellness users is enlarged (Pilzer, 2007:27).

### National structure of wellness users in Croatia

Tomas research is used for analysis of various characteristics of travel and tourists' stays in Croatia. Although the main goal of Tomas research is to determine the market profile of typical Croatia's guest, his/her expenditure, as well as the main advantage and weaknesses of tourism offer in coastal destinations, some of its results can be used for more detailed analysis of the users of WH tourism in Croatia. This refers to questions related to tourists' motivation for arriving to the destinations where they spend their vacations in Croatia and activities they undertake while in destination. Besides the age structure, tourists can be segmented by their countries of origin. Listed hereafter is more thorough overview of characteristics of international tourists' stays that are related to health activities and to Croatia's 14 leading tourism generating markets including domestic tourists (Table 2).

Table 2. Tourists' motivation and activities according to the countries of origin in Croatia in 2010 – chosen results of wellness and health research

	Guests' motivation with health and wellness (in %)	Involvement in HRW programs (in %)	Estimated number of participants in HRW programs	Share of tourists involved in HRW programs (in%)
AVERAGE	6.4	32.5	3.445.873	100.0
Croatia	7.8	32.1	479.387	13.9
Germany	7.4	33.8	515.080	14.9
Slovenia	6.2	31.9	324.359	9.4
Italy	6.5	37.2	378.354	11.0
Czech Republic	5.8	27.2	164.849	4.8
Austria	7.9	34.6	280.584	8.1
Poland	0.9	17.5	79.328	2.3
Slovakia	12.0	35.0	108.599	3.2
Netherlands	4.7	36.1	102.973	3.0
Hungary	6.5	29.3	87.157	2.5
Russia	3.1	36.0	59.401	1.7
France	4.2	34.0	131.860	3.8
Great Britain	4.1	42.1	101.509	2.9
Bosnia & Herz.	14.2	20.1	43.575	1.3
Serbia	2.6	34.3	29.805	0.9

HRW- health-recreational and wellness

Source: Tomas summer (2011)

WH are more important motives of arrival for tourists coming from Bosnia and Herzegovina, Slovakia and Austria, while with tourists coming from Poland, Serbia and Russia those motives are expressed the least. Since all tourists can get involved in those contents of the offer within destination irrespective of their motivation, far more important information for tourism offer carriers within tourism destination is the one related to tourists' involvement in HRW programs. Consequently, it is important to emphasise significant disproportion between motivation for WH and guests' involvement in HRW programs. It is quite indicative that guests to whom wellness as a motive is highly ranked are not involved in such activities with the same percentage. For example, Polish tourists are slightly motivated, but are relatively significantly involved in HRW program. On the other hand, guests coming from Bosnia and Herzegovina have an above average motivation with these programs, but their involvement is below average. It is presumed that this is a consequence of their orientation to health motives more than to wellness. If one analyses all tourists by their country of origin, Britons are involved the most in HRW programs that are offered in Croatia's coastal destinations (42%). Furthermore, Italians (37%), Dutchmen (36%), Russians (36%), Slovaks (35%) and Austrians (35%) are following Britons. Since the average is 32.5%, it is necessary to step up promotional activities on mentioned tourism generating markets, with intention to better inform guests and to attract larger number of visitors. It is important to emphasize that this would lead to higher expenditure and achieving better economic effects in destinations. Namely, pilot research conducted in 2009 estimated that average expenditure of wellness service user is higher than 9 € (Horwath, 2009). Estimation of number of tourists that used wellness services in 2010 was conducted by analyzing relative importance of particular market in Croatia and

the number of tourist arrivals in analysed year, as well as their involvement in HRW program (Table 2). There were 3.4 mil. tourists involved, most of them being Germans, domestic guests and Italians. Service providers perceive total number of users form a particular market as the most significant information. As shown in Table 2, tourists coming from countries that are significantly involved in total number are not that much numerous when it comes to wellness services users. Therefore, additional activities are needed to encourage their greater involvement. Unlike them, guests with smaller number of arrivals (compared to the main countries) are significant as wellness services users.

### Managing wellness offer

There are many factors influencing the overall health tourism quality. Košuta et al. (2005:10) provide key factors important for success of health tourism (applicable also to wellness tourism): expertise of personnel (it's important to have educated resources in all areas of providing services and to continuously educate and improve them), continuously innovating products (follow the competition and trends, innovate products and services), continuously modernizing equipment (hydrotherapy, wellness facilities etc.), knowing target groups (needs and interests of particular market segments), constant quality (consistency in the quality of provided services) etc.

In Croatia, supports to health tourism and development of wellness are weak and insufficient. Since 2000, all documents and developmental plans of Croatia's tourism declaratively advocate encouragement for developing health tourism. At the same time, there is a lack of specific measures that would enable achieving development of health tourism. There are several institutions that should try to commonly point out the problems and suggest their solutions: state institutions, ministries in charge of health, tourism and economy, chambers of economy, local and regional self-governments and system of tourist boards. For successful management a new strategy of developing health tourism is needed at both national and destination level. This strategy would include all of its sub-forms, such as wellness, and all potential products. In order to anticipate possible future development of wellness tourism in Croatia, SWOT analysis was conducted. It points out advantages and possibilities, but also critically reviews weaknesses and threats to future development of wellness tourism in Croatia (Figure 1).

ADVANTAGES (STRENGTHS)	WEAKNESSES
Climate preferences Health tourism tradition in coastal destinations (Opatija, Crikvenica, Mali Lošinj, etc.) Natural predispositions for development of health tourism (thalassotherapy, balneotherapy, etc.) Favourable geographic position of Croatia to generating markets Ecologically preserved destinations Hospitality of inhabitants	Absence of developmental strategy of wellness offer in tourism Low motivation of human resources (expert personnel) Not familiar with guest structure (needs) Lack of information about the wellness offer leading tourism generating markets Absence of joint activities between hotel industry and destinations with the goal to develop wellness offer
POSSIBILITIES	THREATS (RISKS)
Constant growth of demand for wellness on tourism generating markets New segments and markets ("healthy living and care about the health" trend) Integrating wellness offer with all forms of tourism, especially with congress and sun&beach tourism Repositioning Croatian tourism, recognizable image Improving service quality Trends in gastronomy (healthy food)	Sharp competition of already developed wellness tourism destinations (Austria, Switzerland and Germany) High prices of wellness services, low diversity of offer Inability to quickly adjust to volatile tourists' needs Lack of financial resources Insufficiently educated human resources (poor offer, low service quality)

Source: authors

Figure 1. SWOT analysis of wellness offer in coastal Croatia

SWOT analysis points out that there are numerous insufficiently used possibilities of developing wellness tourism. Some authors estimate that wellness tourism today generates about \$ 500 billion of income (Pilzer, 2007:27). Taking this into account, Croatia should take certain measures with the goal to improve wellness offer.

### Conclusion about the possibilities of wellness tourism development in Croatia

In accordance with trends that stress the need to innovate traditional 'sun and sea' vacations and the growth of demand for additional activities within destination, improvement of wellness offer is one of the possibilities which Croatia should start to use. Croatia's preserved natural resources and numerous natural salutary factors (aerosol, water and air quality etc.) are contributing to creation of attractive and competitive health-tourism and wellness offer. Besides that, Croatia has numerous accommodation facilities that can be enriched with wellness offer. For example, many hotels that upgrade



their quality form 4 to 5 stars inevitably include wellness facilities as a part of their offer (a good example is Opatija Riviera). The same trend is present with small family hotels that are partially specialized for this kind of offer, aiming at the guests of higher purchasing power. However, for Croatia to be able to use the advantages that wellness has (longer average guests' stay, higher level of tourism expenditure, using capacities beyond the summer season), it is necessary to ensure numerous additional assumptions. The most important is to stress the significance of quality management, educated personnel and development of programs with high quality services. All wellness products that are being offered should be of highest European standards in order for them to be recognized and competitive on the market. Additionally, it is important to emphasize that destinations, as well as accommodation facilities, should be 'tracing the wellness story' in order to ensure quality experience for tourists. Care about the environment, administration of environment, orientation toward the ecology, the quality of air and water, quality waste disposal etc., are also an important part of the overall wellness offer. Better awareness of guests about the potentials of tourism offer is also extremely important. Analysis provided in this paper stresses the possibilities, advantages, but also the weaknesses and risks of wellness tourism in Croatia. Undoubtedly, wellness offer in Croatia is in its initial phase, its competitiveness and recognition on tourism market are yet to be developed. Recognition could definitely be improved with better awareness and above all, investing into development, alongside defined strategy. It would generally be useful to bring out a form of wellness standard or codex that would include elements needed to develop quality tourism destinations (equipment, services, resources). That would allow defining and ensuring recognizable Croatian quality of wellness services and, consequently, enriching the overall tourism offer, increasing tourism incomes as well as steady utilization of the existing tourism capacities in Croatia. This paper confirms the hypothesis that there is a disproportion between motivation of tourists with WH activities and the number of tourists involved in HRW programs, in favour of the latter. This means that there are large reserves to develop wellness that could be achieved with a special concept of managing within wellness tourism.

## References

1. Alfier, D. (1977). Uloga turizma u resocijalizaciji i desocijalizaciji suvremenog čovjeka, u zborniku Turizam – izbor radova (1994) Institut za turizam, Zagreb, pp. 189-201.
2. Bartoluci, M. (2011). u Čavlek et al.: Turizam: ekonomske osnove i organizacijski sustav, Školska knjiga, Zagreb.
3. Bartoluci, M., Birkić, D. (2011). Upravljanje kvalitetom ljudskih resursa u zdravstvenom turizmu, Acta Turistica Nova, Vol. 5, No.1, Zagreb, pp. 53-73.
4. Bartoluci, M., Čavlek, N. et al. (2007). Turizam i sport – razvojni aspekti, Školska knjiga, Zagreb.
5. Bartoluci, M., Škorić, S. (2011). Upravljanje razvojem wellnessa u hrvatskom turizmu, Zbornik radova „Sportska rekreacija u funkciji unapređenja zdravlja“, KIF, Zagreb, pp. 20-27.
6. BIST (2011). Online informacijski sustav Instituta za turizam koji koristi podatke DZS o turističkom prometu i kapacitetima u Republici Hrvatskoj. Zagreb. Internet: [www.iztg.hr/bist](http://www.iztg.hr/bist) [10.4.2011.].
7. CNTB Brochure (2009). Wellness Hrvatska, HTZ u suradnji s Sektorom za turizam HGK, Zagreb. <http://business.croatia.hr/hr-HR/Hrvatska-turisticka-zajednica/Promo-materijali/Brosure>. [11.4.2011.].
8. Čavlek, N., Matečić, I., Ferjanić Hodak, D. (2010). Pokretači inovacija u turizmu: neki teoretski i praktični aspekti, Acta Turistica, Vol. 22 (No. 2), pp. 201-220.
9. European Commission (May 2011). Survey on the attitudes of Europeans towards tourism. Analytical report. Wave 3, Flash Eurobarometer. EB No. 328. conducted by Gallup Organisation for Directorate General for Enterprise and Industry, [http://ec.europa.eu/public\\_opinion/flash/fl\\_328\\_en.pdf](http://ec.europa.eu/public_opinion/flash/fl_328_en.pdf) [28.6.2011].
10. Hitrec, T (1998). Zdravlje kao trajna odrednica i razvojna šansa hrvatskog turizma, Znanstveni skup, Zdravlje i turizam, Hvar, pp. 24-25.
11. Horwath Consulting (2009). Prodaja paket aranžmana wellness/ medicinskog turizma u hotelima, Dani hrvatskog turizma, Bol.
12. Kušen, E. (2006). Zdravstveni turizam u Hrvatskoj, u knjizi Plavo, bijelo, zeleno, Institut za turizam, Zagreb, pp. 167-190.
13. Kušen, E., Mezak, V. (2005). Hrvatski wellness hoteli, Turizam, Vol. 53 (No. 4), pp. 397-405.
14. Mueller, H., Kaufmann, E. L. (2001). Wellness Tourism: Market analysis of a special health tourism segment and implications for the hotel industry, Journal of Vacation Marketing, Vol.7, No.1, pp. 5-17.
15. Pilzer, P. Z. (2007). The wellness revolution, Your business, Vol.3, Issue 3, [http://www.paulzanepilzer.com/YB\\_V3N3.pdf](http://www.paulzanepilzer.com/YB_V3N3.pdf). [10.4.2011].
16. Sheldon, P. J., Park S.Y. (2008). Održivi wellness turizam: upravljanje i problemi poduzetništva, Acta Turistica, Vol. 10 (No. 2), pp. 151-172.
17. Smith, M., Puczko, L. (2009). Health and wellness tourism, Elsevier, Hungary.
18. Telišman, N. et al. (2005). Konkurentna pozicija zdravstvenog turizma, Institut za turizam i HGK, Zagreb.
19. Tomas summer 2010 (2011). Stavovi i potrošnja turista u Hrvatskoj, Marušić et al., Institut za turizam, Zagreb.
20. Tomas trends 1987-2008 (2009). Stavovi i potrošnja turista u Hrvatskoj, Čorak, S., Marušić, Z., Ivandić, N.: Trendovi Tomas ljeta 1987.-2007, Institut za turizam, knjiga br. 4, Zagreb. pp. 11-43.

## GOLF TOURISM AND SUSTAINABLE DEVELOPMENT: FRANCE AND CROATIA, TWO EUROPEAN EXAMPLES

**Kristina Bučar<sup>1</sup> and Claude Sobry<sup>2</sup>**

<sup>1</sup>*Faculty of Economics and Business, Zagreb, University of Zagreb, IRNIST*

<sup>2</sup>*University Lille North of France, ER3S – IRNIST*

### Abstract

A tourism industry wishing to be viable and successful on the long term must respect the basic postulate of sustainable development in the planning and development. The development of golf tourism requires the provision of several golf courses and many other infrastructures and facilities which have influences on environment. The popularity of golf worldwide has increased for the last 20 years and continues to grow, and the number of golf courses around the world now exceeds 31,000 for 50 millions of players. Today in France are 668 and in Croatia only 4 golf courses. The paper compares development of golf tourism in France and Croatia and shows present state.

**Key words:** *tourism, sustainable development, golf, France, Croatia*

### Introduction

The popularity of golf worldwide has increased for the last 20 years and continues to grow, and the number of golf courses around the world now exceeds 31,000 for 50 millions of players. From the beginning of the '90s, the number of golf courses in Western Europe has doubled while the number of players has tripled (Golf Benchmark:2007). In 2010, 4,4 millions of golf players and 6763 golf courses were registered in Europe. Nowadays golf cannot be considered simply as a sport as highly important economic interests are also involved (Tapias & Sagot:2006). The development of golf tourism requires the provision of several golf courses (minimum three) and many other infrastructures and facilities, obviously including hotels with restaurants, spa facilities, fitness centers, turning them into resorts. We must bear in mind that even if golf comes from water-abundant regions, the most attractive golf destinations are those that have warm, dry and sunny climates. In sharp conflict with the vast amount of water necessary to the maintenance of the fairways, tees and greens on golf courses. This situation is even more complex as the concentration of various courses in close juxtaposition greatly enhances the product, but obviously increases the impact on the environment at the same time. This way, veritable “golf tourism regions” has been developed. The most famous golf regions in the south of Europe are the Spanish Andalusia coast from Malaga to the Portuguese border, and its continuation along the Algarve coast. In North America, the entire state of Florida could be considered a golf region with over 1,600 golf courses, followed by North and South Carolina coasts. There is a lot to say about the development of golf in the Arabian countries. The main problem is the consumption of water required to maintain and operate these structures. To supply enough water for the courses fossil or desalted water can be used, with the consequences we can imagine. Golf courses are generally accused to be sumptuary, consuming too much water resources and space and being dedicated to only a privileged category of people (G.K. Priestley:2006). The situation is probably not the same worldwide and the purpose of this communication is not to examine the environmental impact of golf courses everywhere in the world but to compare what is being done in 2 countries, Croatia and France, just to see if the prejudices concerning the unreasonable use of water and chemical agents for the maintenance of golf courses are still righteous.

### The situation of golf in France

In France, golf has for a long time been considered as an upper-class activity that could only be practiced in clubs reserved to the elites. It is only from the 1980s that golf started to be more open to the public under the influence of C. Cartier, Président for the Fédération Française de Golf (FFG-French Golf Federation), who led the way to the creation of public courses to be followed by privately-owned ones. Today there are 668 golf courses in France against 180 in the mid-80s; this figure corresponds to 11 infrastructures (including golf, compact golf, pitch&putt and practice) for 1 million people, which puts France below the average of 17 infrastructures for 1 million people found in the 15 main European countries. There were 100.00 club members in the 80s compared to 420.000 today, making the FFG the 6th biggest federation by the number of its members behind the football, tennis, judo, horse-riding and basketball federations. As not all players have a membership, we can evaluate the total number of players to 600.000 (of which 30% are women). Even if the average age of the club members is 47, 46% of the new members are under 35. Commercial golf clubs, in other words, courses where there is not entrance fee or yearly membership but where the players only have to pay for a “green fee” to start playing.

Generally going along with an estate development program, have rapidly developed with the creation of 9-holes courses and urban compact golf courses. The turnover for golf on a national scale is thought to be of 1.5 billion Euro before tax, or 17.500 Euro per hectare -7085 Euro per acre. 13.000 local jobs on a permanent contract have been directly or indirectly created by the golf industry, 4 jobs for 10 hectares (25 acres) regardless of the unpaid workers, when agriculture only creates 3 jobs per 100 hectares. 7.650 of these jobs come directly from running the golf courses. It is also an important factor for the non-qualified workforce, as 41% of these workers do not have the Baccalauréat. The turnover for the golf courses linked with tourism represents about 20% of the total turnover for all the golf clubs. The geographical distribution of these facilities is uneven as out of the 22 official regions in France, 42% of these facilities are concentrated in only 4 regions (Île-De-France 14%, Rhône-Alpes 10%, Provence-Alpes-Côte d'Azur 10%, Aquitaine 8%). 60% of the facilities are private, 40% are public, 1/3 are non-profit organizations and 2/3 are commercial. But these facilities are much more than mere sports infrastructures as they offer many more services: 88% of them include a restaurant, 24% a hotel, 21% have tennis courts and 18% provide a swimming-pool. Golf infrastructures spread over about 220 km<sup>2</sup> (137 sq. mi.) of the territory for an average of 0.5 km<sup>2</sup> (0.3 sq. mi.) per facility, which corresponds to the estimations realized for an 18-hole course on an international level. Thus, there are countless debates on the effects these areas have on the environment, the plant and the animal world, and the use of water and several substances such as pesticides and fertilizers. Moreover, golf courses are not only being criticized for the environmental consequences they generate; golf tourism is also accused of causing urban areas to spread, and of being the cause for speculation on land property and the increase of the prices in real estate. We will not go further into this debate, but we can still highlight the fact that these last two phenomenons are rather global, especially in the touristic field. It is true however that property is more expensive than anywhere else when next to a golf course. On the other hand, we can notice that golf courses sometimes contribute to release the pressure that is put on the coastal areas by developing inland areas otherwise unattractive for tourism development. On an environmental level, the French federation has entered an approach based on ecology and sustainable development. On February 2<sup>nd</sup>, 2006, the FFG signed with the authorities the Charte sur l'Eau (the Order for the Use of Water), aiming at reducing the amount of water used coming from the public services by 30% in 3 years, as well as reducing the amount of weedkillers and chemical fertilizers. This implies to develop a policy of recycling rain and waste water, a controlled watering, more economical water-spraying techniques, etc. At the same time, the FFG and the Musée d'Histoire Naturelle (National Museum for Natural History) signed an agreement running from 2007 to 2009 aiming at observing the effects of a golf course on the plant and the animal worlds. A survey realized on the National Golf shows that if managed the right way, a golf course can help to protect the biodiversity. A new agreement called the Charte Nationale "Golf et Environnement" (National Order for Golf and Environment) was signed in September 2010, going further ahead into the ideas developed in 2006 and adding some more restrictive elements such as a yearly survey analyzing the quality of water, the recycling of waste water, the classification of golf as a "nature sport" and so on and so forth. It was also underlined that it is the responsibility of the owners and the architects to respect this agreement when building a golf course. This completes the order issued on August 2<sup>nd</sup> 2010 about recycled water, that is to say the water coming from a wastewater treatment plant. Respecting these agreements implies some necessary specific investments and sometimes renovation works as well as staff training. It seems that golf courses following these rules have seen a positive effect on their profitability. Regarding the use of the different products employed to maintain the greenswards, we need to spot the difference between the objectives fixed by the aforementioned agreements, which are figures, and can therefore be verified, and the arguments coming from the FFG. The French golfing sphere denies any environmental disturbance. The emphasis is put on the fact that the surface that requires to be maintained only corresponds to a small percentage of the total surface of the course. These surfaces are the greens and the starting points, 2 hectares (5 acres) per course, or in total 11km<sup>2</sup> (6.8 sq. mi.) all golf courses combined, and the pesticides employed represent less than 0.1% of the pesticides used on the whole territory. Based on French as much as on international surveys, the FFG argues that above all golf courses would produce vast quantities of oxygen. According to the FFG, an 18-hole course could provide enough oxygen for an average population of 4.000. Moreover, the areas kept absolutely undisturbed would serve as a shelter for a great number of species. On the whole we can observe that on the environmental level, the FFG and the facilities' executives follow the instructions coming from international institutions or programs aiming at reducing the negative effects of golf on the environment -such as the Golf Course Superintendents Association of America (GCSAA), or the most famous of these programs, the Audubon Cooperative Sanctuary Program for Golf Course. In 2009, 783 golf courses across the globe were approved by this program. Even though the other effects, like the economic consequences, still need to be studied.

## Golf tourism in Croatia

Croatia is located in the southeast of Europe and covers 56 536km<sup>2</sup> (35,335 sq. ml.). This small space covers 3 different regions regarding geography and climate: inland (continental climate), mountain (mountain climate) and coastal regions (Mediterranean climate) with 1,244 islands. The modern (organized) tourism in Croatia started in 1868 with the forming of the "Hygiene society" on the island of Hvar with the intent of improving the conditions for tourism. Tourism was mainly developing on the coast and on the islands. There was a constant increase of visits to Croatia, until 1990 when, due to the Homeland war, a period of stagnation took place up until 1995. There has been a constant increase in the

number of tourists in the last 15 years. In 2008 there were 11,2 million tourist visits recorded with 57,1 million overnight stays. Tourism in Croatia has 3 main characteristics: 83,9% is made by foreign tourists with 88,6% overnight stays; seasonality – from June to the end of August, Croatia records 73,73% tourist visits and 84,93% overnight stays; geographical density - 85% of all visits are recorded in the coastal region. The main problems about tourism in Croatia are a high seasonality and a geographical concentration of tourists (DZS). Golf tourism could be one of the ways to solve those problems. There is an old tradition for golf tourism in Croatia. The first course was created in 1922 on the Brijuni Islands, which are today a national park. 3 other courses were created in the following 10 years. But a long period empty of any kind of golf activity was to follow from the 1930's to the 80's, essentially for political reasons. Some projects started to appear again during the '90s and in 1995 the Ministry for Tourism gave its approval to a new strategy, golf being considered in this case as a "favorable element for the development of tourism". 60 course locations were presented for this program but only 23 were chosen by the government, 21 on the coast and 2 inland. In spite of this program today in Croatia there are only 4 golf courses ( 18-holes), 2 on the coastal part (both in region Istra and one of them is located in the National Park Brijuni) and 2 inland (in the neighborhood of city Zagreb). In 2009, 550 players registered in more than 30 golf clubs. How could we describe the gap between the initial project and what's actually been realized 15 years later? This discrepancy comes mainly from the multiplicity of political and administrative decision-making organs. The process of getting a planning permission for a new golf course can last for several years. This combined to the complexity of the administrations sends the investors away and brings the projects to a dead-end. There are in Croatia three different Ministries which are in charge of different sections of golf tourism: the Ministry for Science, Education and Sport for the sports side, the Ministry of tourism for the tourism section and physical planning, the protection of the environment and the building of golf courses are administered by the Ministry for Environmental Protection, Physical Planning and Construction. There are about 20 different laws and rules to regulate the building of golf courses. In the jurisdiction of the Ministry for Environmental Protection, Physical Planning and Construction only exist 6 different laws and regulations. The Law about Physical Planning and Construction (NN 76/2007., 38/2009) declares that golf courses should be located at a minimum of 25 meters from the coastline. Also, accommodation can be built up to a maximum of 120 beds per hectare (2.5 acres), when a minimum of 40% of all land should be used as a park or natural green area. The final location of the golf course is the choice of the local authority, on a county scale (there are 21 counties in Croatia). On that level, each project of building a golf course should take into account the different impacts on the environment (on ground water, flora and fauna, traditional agricultural production, cultural heritages). That process should guarantee to protect the environment. In the same way the government, who owns the land, only allows 40 years concessions (MZOPU, 2010, 66). In 2010 the Ministry for Environmental Protection, Physical Planning and Construction issued a document called "Criteria and guidelines for the planning of golf courses" ((MZOPU, 2010). That document shows that the chosen locations are not equally spread over Croatia and some changes had to be made in the strategy accepted by the Government of Croatia in 2009. This new strategy for developing golf tourism and locations for golf courses contains a plan to create altogether 89 golf courses in Croatia. 55 should be on the coastal part and 34 inland. From the 55 on the coast, 23 are to be built in only one region, Istra, which is already the most touristic region as it is the destination of 25% of the tourists visiting Croatia. We can easily understand why Croatia meets the new golf players' expectations: the Mediterranean climate allows them to practice their favorite sport and enjoy the sun and the sea at the same time. Even if there are a few inconveniences (like a strong wind in winter) these courses could attract tourists virtually all year round, and thus get Croatian tourism out of it's seasonal rhythm with all the positive economical effects it would have. The problem is that the coastal part is very fragile. First of all it is very narrow as it is located between the sea on one side and mountains on the other. What's more, the coast is made of crags. But one of the main issues is that these courses need watering, in a region that already has difficulties (and sometimes fails) to satisfy it's own needs because of the pressure put on on the water supplies generated by tourism over summer. This is why we could come to think that using golf as a way to attract tourists is maybe not the best solution to develop a sustainable tourism in all its definitions, that is to say taking into account, on top of the economic development, the social development and the preservation of the natural environment. A tourism industry wishing to be viable and successful on the long term must respect the basic postulate of sustainable development in the planning and development (Steele, 1995:33). This however, can very often lead to a conflict between the economical and social prospects of tourism development (e.g. increasing the number of tourists, nights, revenue, capacity, employment, involvement of local population) and the development of tourism from an environmental perspective (e.g. protection of natural, cultural, historical backgrounds and other resources) (Gunn, 2002:15). The development of economy and tourism hand-in-hand may not go unplanned and unorganized, at any price and without considering the consequences in the long run. It is possible that a project may generate temporarily and in the short term a fast economic growth and development, but later it may turn out that the environment and the resources, that have been the basis for such development, have been destroyed. In this case, the damage is double: on the one hand, the economic development is stopped and the economic activity in question goes downwards, while at the same time the basis, i.e. the resources the economic activity was based upon, is destroyed and therefore there are no new development possibilities (Inskip, 1991:461). As for golf and the tourism it could attract, we can fear that in the case of Croatia two negative effects come hand-in-hand. First, it seems that everything shows that the golf detractors were right: water-supplies and the quality of the ground have become problems, as well as the changes in flora having negative effects on the animals, etc. Then, even if the practice of golf has increased vigorously

it is still far from becoming a sport for the masses. The players are wealthy tourists who spend more than others during their trip, a lot of them being aware of the environmental and sociological questions raised by their passion. As soon as a destination for golf takes one step too far away from their ethics, part of these customers will turn to other locations. Moreover, a large part of the tourists in Croatia come from Germany, where there is a real awareness of the environment. This risk has to be considered very seriously as a strategy based on the development of golf courses means high-standard tourism with fares that would not compete with the ones from neighboring countries, essentially Mediterranean countries. It would not here be question of replacing customers with a high-purchasing power by customers of a more popular background if they were to leave the destination. A political decision for the choice of an economic pattern for tourism development has then become necessary. So, could golf be a vector for development in Croatia? Maybe, but under certain conditions.

## Conclusion

The comparison between the different roles played by golf in France and in Croatia leads us to a conclusion full of contrasts. If there are fewer golf courses in France than the European average, it seems that the critics of this sport back up when they see the efforts made by the international associations, aware of today's economical impact of golf on many regions of the world, and of how precarious it is for the same reason. The French Golf Federation helped by the supervising authorities sets the elements that will minimize the impact of golf courses and it has been proved that it could even turn it into a positive effect under certain conditions. Even if we shouldn't draw conclusions too hastily, we can say that it looks pretty positive. On the other hand, it is easy to see that in Croatia the economic aspect of golf is much more considered than sustainable development. It looks like a whole range of criteria hasn't been taken into account. However we can highlight the fact that some measures are being taken, which shows that if the decision-makers in the government don't forget completely about the problems they are probably under the pressure of economical interests, always in a rush. It is in that kind of context that neutral and independent structures could enter the game, with a good international knowledge of these questions. No doubt the universities have a role to play by setting up networks of researchers and professionals who thanks to their works carried by international structures and the ERRIN for Europe, or even the UN or the international sports federations, could help the decision-makers to make the right choice that would fulfill their expectations the best.

## References

1. Gunn, A.C. (2002). *Tourism Planning, Basics, concepts, Cases*. London: Routledge.
2. Inskip, E. (1991). *Tourism planning*. New York: Van Nostrand Reinhold.
3. MZOPU (2010). *Kriteriji i smjernice za planiranje golfskih igrališta*. Velika Gorica: MTG-Topograf.
4. Priestley, G.K. (2006). Planning implications of golf tourism, *Tourism and Hospitality Research* 6(3), pp. 170-178.
5. Steele, P. (1995). Ecotourism: An Economic Analysis, *Journal of Sustainable Tourism*, 3(1), pp. 29-34.
6. Tapias & Sagot (2006). Management of soil-water resources in golf courses, *Tourism and hospitality research*, 6(3), pp. 197-203.
7. www.dzs; 2011; Priopćenje 4.4.2/11.

## SIGNIFICANCE OF GOLF FOR REPOSITIONING OF ISTRIA ON THE TOURIST MARKET

Slobodan Ivanović, Romina Alkier Radnić and Tonći Jerak

*Faculty of Tourism and Hospitality management Opatija, University of Rijeka, Croatia*

### Abstract

The main characteristic of Istrian tourism offer was based on the product ‘sun and sea’, with an emphasized seasonal character of the concentration of tourist movements in the three summer months. In the last ten years there is an effort to shape a new segment of tourism (rural or bike tourism, rural tourism, etc. ), and emphasis is placed on tourist valorization of central Istria. Nevertheless, Istria is still perceived in the minds of tourists as a destination of the product of average quality. Previous experience in Istria shows that investment in the development of sports tourism contributes to improving the overall quality of tourism. To golf is given a priority task for improving the quality of tourism services. In Regional Plan of Istria 23 locations are planned to build a golf course. This study examines the status and prospects of golf and its importance in improving the quality of tourist product of Istria.

**Key words:** *emphasized seasonal character, tourist movements, summer months*

### Introduction

The results of the efforts of the holder of the Istrian tourist attractions in the shift from products “sun and sea”, are considerably smaller than expected. “Passive rest and relaxation” is still the main motive of tourists’ coming in the County of Istria, and “swimming and bathing” presents the main activity at the destination. The implementation of new segments of tourism (rural or bike tourism, rural tourism, etc. ), With an emphasis on the tourist valorization of central Istria create the conditions to prolong the tourist season and the creation of an integrated tourism product where its place are finding all parts of the Istrian peninsula. Bearing in mind the seaworthiness of Istria, the possibilities for developing various forms of sports tourism, as well as experience in developing sports tourism, coming to the realization of the importance of greater integration of sport offers the tourist offer of Istria with a view to improving the overall quality of tourism. Emphasis is given to the diversification of tourist sport offer of Istrian tourist destinations and the development of golf as a competitive tourism product. It also means opening up new markets, the arrival of new guests and ultimately creation of an entirely new image of Istria as a tourist destination.

### Features of Istrian tourism product

Offer based on a “sun and sea” and the highly seasonal nature of business concerning accommodation in three to four month during summer season, no adaptation of the tourist offer of new trends in tourism demand in the market and finally the low level of profitability of the holder of tourism and tourism in general, the reason for the new systematic reflection of the need for diversification of Istrian tourist destination for natural and acquired developmental predispositions and hence the development of new products that the market will look for its target client group.

Defining tourism cluster was a key starting point for activities aimed at determining the tourism products for which there are real possibilities of development in a certain area, and to avoid internal competition within the tourist destinations of the Istrian peninsula. Givens of individual units form the new products, mutually complementary, which can achieve competitiveness in the market. Special emphasis is given to evaluation of the interior of Istria and its inclusion in tourist flows, through activities aimed at developing rural tourism. In addition to the existing tourism products to gain a new dimension in accordance with the requirements of the tourist market (leisure tourism, sports tourism, nautical tourism, etc. ), the new segments of the tourism product are developing (culinary tourism, wine trails, roads, olive oil, lavender road, villas, rural tourism, bicycle tourism, golf, wellness, cultural tourism, short tours, bird watching, tours of special interest, etc. ) as a standalone product or supplements to existing tourism. Efforts of the holder of tourist destination at all levels, are resulting in the increase of tourist satisfaction elements of tourism. In comparison to 2004, in 2007 guests were satisfied with most elements of the offer (Tomas 2007 - Attitudes and consumption of tourists in Croatia, 2007). Very high degree of satisfaction of guests in 2004 was expressed by only two elements (“the beauty of nature and landscape” and “suitability for implementing a family vacation”); and in 2007 for them 26. Very high level of guest satisfaction expressed for the obtained “value for money” of total stay and “value for money” of gastronomy offer. The high degree

of satisfaction they expressed for 24 elements out of a possible 30 which includes the total stay, accommodation offers, all the elements (value for money, comfort, friendly staff, and quality of food), places to eat, sports, entertainment and cultural activities and the cleanliness and orderliness beach. Medium are satisfied only with the four elements of the offer - with the picturesque and tidiness of the places, environmental preservation, peace and tranquility and quality of local transportation. The increase in tourist satisfaction with elements of tourism results, moreover, with the positive tourism results, expressed in tourist arrivals and tourist nights (Chart 1).

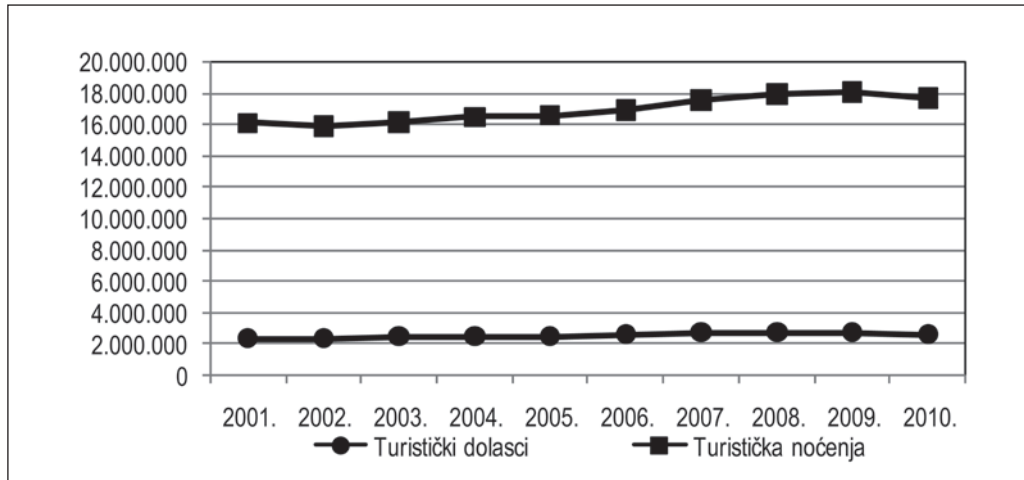

Source: Central Bureau of Statistics

Chart 1. Changes in the number of tourist arrivals and overnight stays in the County of Istria, 2001-2010

The growth of tourist traffic did not, however, change significantly low level of utilization of accommodation and seasonality, as one of the biggest problems that follows the development of tourism in Istria. The average occupancy rate of accommodation in 2002 amounted to 71 days, in 2005 was 66.1 days, and in 2008 was 72.3 days, which means that the number of accommodations rose only slightly to a lower rate than the rate of growth in the number of tourist nights. The level of occupancy of accommodation is higher, however, from other coastal counties; occupancy of accommodations in Primorje-Gorski Kotar County in 2006 amounted to 63.2 days. The share of tourist overnight stays in July and August during the five-year period (2005 -2009) remained almost on the same level (60%). There are no major changes in the extension of the tourist season and the postseason, and in winter (from November till February) share of a number of tourist nights amounted to only about 1.5% (Chart 2).

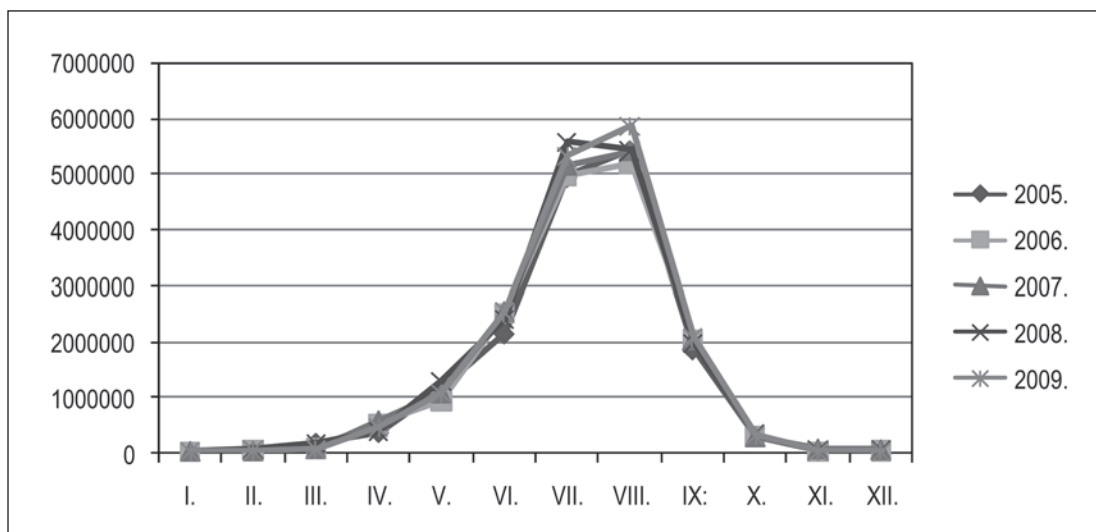

Source: County Chamber Pula

Chart 2. Number of overnight stays in the Istrian County, 2005-2009, by month

This situation indicates the necessity of implementation of new tourism products that will enable the improvement of quality of tourism products, a departure from the destination image intended to the lower layer of consumers and orientation towards the higher middle class. The aim should be to strengthen its market position in the postseason and with a tendency to create conditions for year-round business.

Previous experiences in Istria show that investment in the development of sports tourism contributes to improving the overall quality of tourism. Given the resources that Istria has for the development of sports tourism, the output can be seen in the diversification of sport offer in Istrian tourist destinations. In the tourist resorts in Istria, which will continue to develop mass tourism, it is necessary to innovate and update new content and the existing sports facilities and amenities, while in tourist destinations designated for exclusive tourism is needed to build sports facilities and amenities such complementary forms of tourism offer. Research shows that investments in sports facilities and programs are profitable; it can be a challenge to entrepreneurs for the development of sports tourism in Istria (the relation Bartoluci, 1987; Bartoluci, 2004). The emphasis is, in fact, to the construction of a golf course.

### State of golf tourism in Istria

With the natural features of the development of sports tourism (climatic conditions, maritime, etc.), sports and recreation facilities occupy an important place in the tourist offer of Istria. Istria, parallelly with the construction of accommodation facilities, developed sports and recreational offer, which, in the period to 1990, ensured it the good image on the markets. Special attention was given to the construction and maintenance of sports and recreational facilities, enriching and designing of the content; the large number of tennis courts, football, mini golf, volleyball, bowling alleys, trim cabinets, pools are built. There are evaluated various water sports, and special emphasis is placed on the development of tennis as most popular sport. The strongest tennis tourist destination in Istria is Porec which has about 130 tennis courts, follows Umag with about 50 and Rovinj with about 40 (Kušen, 1996). Development of tennis is especially favorable for the construction of the international tennis center Stella Maris Umag, which scored his reputation by organizing tournaments of World Series ATP tournament. The share of sports nights in Istria in the postseason is estimated at 15 - 20% (Boskovic, 1998). "The wealth of recreational facilities" tourists in Istria evaluate with a high degree of satisfaction (Thomas 2007 - Attitudes and consumption of tourists in Croatia, 2007).

At the beginning of the 21<sup>st</sup> century, golf has become one of the most developed and most popular sports in the world. Once it was a sport designed for the wealthiest stratum of society, has become one of the most popular sports in the world with a dynamic growth in the number of players and golf courses. It is estimated that a more than 65-70000000 professional players are practicing golf on more than 31.500 courts (European Golf Association, 2011).

It can't be still discussed about golf tourism in Istria despite the fact that golf in Istria started to be played between the two world wars. In early 1920-ies on Brijuni is opened the first golf resort (court in connection with a hotel) in the world. As the number of players increased, in the period from 1923 until 1933, this court has been redesigned four times. By the beginning of the World War II it was a gathering place of European and world golf elite and aristocracy. After the World War II, development of golf goes out and comes back again only in early 1990-ies when nine holes are updated. In 2006 all 18 holes were reconstructed. In 2009 in Istria is opened the first professional Championship golf course with 18 holes - course Kempinski (Kempinski Adriatic Golf).

Construction of golf courses in Istria is only at its beginning, and availability of courts (the number of golfers on a golf course) is significantly below average, which is understandable given the fact that golf in Croatia is not "sport of common people". Golf in Croatia is played by just about 1 000 people, which makes the total population share of 0.02%. For comparison, the share of the total population of golfers on the European level is about 1.6%. Golf and educating the population about golf is given, however, in recent years in the Istria region, great importance. Besides the two mentioned golf courses in Istria and several golf driving ranges, to the spread of golf contributes Istrian golf association and golf clubs in Medulin, Pula, Porec, Rovinj, Tar, Umag, Labin et al, and golf schools. In addition to private investors, in golf courses in Istria invest also the cities, such as Poreč that opened the golf course Molindrio (Molindrio in the bay, the entrance to the Green Lagoon), launching the first public golf course "Green Lagoon". With this golf as the sport seeks to get closer to the local population, but is also used to promote golf tourism in Istria.

### The importance of golf in improving the quality of Istrian tourist product

In the framework of international travel 1.1 million passengers, mostly Europeans, yearly as the main reason for their travel are naming golf, 75% of them come from interesting tourist markets: Great Britain, Sweden, Germany and France, and a golf is a motive to about 49% of American golfers in Europe. Tourist Mediterranean countries realized the importance of building a golf course to improve the competitive position of the tourist market, and during the last years it is recorded their dynamic growth (France, in 2009, had 559 golf courses, Italy 258, Spain 318, Portugal 78, Turkey 17, Greece 6). Croatia and Istria should not be behind competitors in this sector of tourism, particularly if one bears in mind the size of this market niche, as well as consumption of golfers to travel (it is estimated that golf tourists spend a day at least 150 euros).



On the example of Portugal, where 26 of the 78 Portuguese courts are located on 100 km long coast through 3 national parks, can be seen the benefits of golf tourism. Golf in Algarve region rendered the improving utilization of accommodation out of season (September - May) and extend the season or the abolition of the concepts season, pre-season and post-season. In Algarve, as well as in other Mediterranean golf regions, golf is played mostly during the spring (March - May) and autumn (September - November), while in summer the number of rounds played decreased significantly. Climatic conditions of Istria allow similar use of golf courses throughout the year. With the integration of golf into the tourist offer of Istria would improve the out seasonal capacity utilization.

Master Plan identified a scenario of restructuring and repositioning of tourism as the most desirable scenarios for the future development of tourism. In doing so, they identified the following elements (Master Plan of Tourism development in Istria, 2003): 1) the restructuring and improvement of current housing, 2) the creation of products with added value, 3) reduce the importance of "sun and sea": Istrian system of experience, 4) the target structure of guests: medium high class and 5) length of season extension to 8-9 months. With its potential, golf can contribute significantly to the achievement of all five elements, and thus occupy an important place in the realization of the most desirable scenario for the development of tourism in Istria. In addition, golf has been identified as a factor in the attractiveness of destinations and in improving the competitiveness of Istria on the tourist market. Golf is one of the kind of future tourism products of Istria, which have great potential for development, and this importance is especially reflected in the fact that golf brings to Istria a new offer, and puts a new destination on the tourist market segments (golf market).

In accordance with the strategic guidelines and priorities of capacity building in the tourism industry, the importance for the Republic of Croatia, in the Regional Plan of Istria to golf is given an important place, as a special segment of offer with the purpose of shaping better and richer tourist attractions. Provided a total of 23 locations for golf courses with 18 (or 27) holes, with a total area of 2 406 ha. The net grounds would cover about 500 hectares, and the rest is the natural landscapes that are usually integrated into the golf course. Minimum size of each field is 85 ha; buildings can occupy as much as 25% of the total.

Offering golf packages and programs and related content is achieved the basic tenets of the development of tourism in Istria defined by Master plan, which is the realization of the sustainability strategy based on the growing tourism spending and financial return while simultaneously offers raising the quality of guest experience and quality of life of local residents. It is indisputable that golf raises the quality of supply and service of tourist destinations, so be on the basis of foreign experience, especially the tourist competing countries. In the discussion about development of golf destinations and golf can be stated that the integration of golf projects is crucial for the development of tourism in Istria and for the profiling of Istria on the tourist market as a destination which offers new forms of tourism aimed at the modern tourist clientele.

## Conclusion

With diversified tourist product Istria achieves the tourist results that (together with Kvarner region) place it among the most important Croatian tourist regions. Such tourist product, however, is not final; it requires continuous improvement and enrichment with new content. The modern tourist is an active participant in the events of some destination, and sports activities are an integral part of their tourist journeys. Accordingly, in the promotion of tourist product of Istria, the emphasis is placed on the implementation of new sports facilities, with special emphasis on the development of golf as a competitive tourism product. The fact is that destinations that do not have a golf course cannot achieve competitiveness in the tourist market. Therefore, this segment of sports and recreational significance should be given priority in order to enhance the tourist product of Istria in line with trends on the tourist market.

## References

1. Bartoluci, M. (2004). *Menedžment u sportu i turizmu / Management in Sport and Tourism*. Zagreb: Kineziološki fakultet, Ekonomski fakultet.
2. Bartoluci, M. et al. (2007). *Turizam i sport – Razvojni aspekt*. Zagreb: Školska knjiga.
3. Bošković, D. (1998). *Mogućnosti razvoja selektivnih oblika turizma u Istri*. Hotelijerski fakultet Sveučilišta u Rijeci: Hotelska kuća '98.
4. European Golf Association, <http://www.ega-golf.ch> (6.05.2011.)
5. Kušen, E. (1996). *Aktivan odmor – značajan dio kvalitetne ponude*. *Ugostiteljstvo i turizam*, br. 4.
6. Relac, M. i Bartoluci, M. (1987). *Turizam i sportska rekreacija*. Zagreb: Informator.
7. Sošić, L. et al. (2007). *Golf i okoliš – stanje i razvojne mogućnosti*. Rovinj.
8. THR i Horwath Consulting Zagreb (2003). *Master plan razvoja turizma Istre*. Zagreb: THR i Horwath Consulting.
9. *Turizam – kumulativni podaci, 2001.-2010.*, Državni zavod za statistiku Republike Hrvatske, <http://www.dzs.hr> (03.05.2011.)
10. *Turizam, Županijska komora Pula*, <http://hgk.biznet.hr/hgk/tekst.php?a=b&page=tekst&id=1611> (19.04.2011.)

## SAILBOAT REGATTA MANAGEMENT AS A FACTOR OF THE TOURIST DESTINATION PROMOTION

**Zdenko Cerović and Sanda Grudić Kvasić**

*Faculty of Tourism and Hospitality Management, Opatija, Croatia*

### Abstract

This topic is by its contents and expected results highly interesting and until now little explored. The initial question is how much can a regatta, as a segmented and specific tourist content, increase the promotion of a tourist destination. Case studies are based on regattas on the Croatian coast. This paper researches fourteen regattas in fourteen tourist destinations in three counties, i.e. tourist destinations that form a representative sample, because they make a total of 20% of tourist overnight stays and tourist trade on the Croatian part of the Adriatic. We have surveyed the regatta competitors and participants as sporting events that are mainly organized and supported by local tourist boards. Regattas are challenging events in all aspects of management and these special aspects require by their extent and model special methods of planning, organizing, leading and controlling the organization of a regatta.

**Key words:** *management of regattas, promotion of tourist destination, tourist motives*

### Introduction

Regattas as tourist attractions represent have two main goals: to increase the number of facilities in a tourist destination and to increase the total tourist consumption. Management of regattas is a burning topic because there has not been much research in this field and there is no collection of processed data regarding their influence on the promotion of a tourist destination on the Adriatic coast.

The aim of the topic is to analyse to which extent a regatta influences an increase of the promotion of a tourist destination on the Adriatic coast. The authors have collected relevant sources such as available statistical data, available data from the TOMAS survey, statistical data from HJS (Croatian Adriatic Union), data from individual research such as surveys, interviews and other sources that were available in sailing clubs and local tourist boards. Personal experience and participation in numerous regattas were the starting point for formulating the hypothesis that regattas increase competitiveness, affect all relevant forms of promotion of a tourist destination and influence the tourist's perception of a destination. By employing deductive, inductive, historical, statistical and correlational methods, the authors have reached relevant conclusions and managed to prove the previously established goal of the requested model.

The introductory remarks are followed by the possible motives for tourist arrivals in Croatia, then the importance of sporting events in the promotion of a tourist destination is shown and the influence of the regatta as a sporting event on the overall perception of the tourist destination is explained.

### Tourist motives for visiting tourist destinations in Croatia

A tourist destination is a reason for travelling and it is defined as an optimal combination of fixed and variable factors and the possibility of acting in accordance with market preferences, regardless of administrative constraints (Magaš, 2003). In such cases fixed factors are those that are not altered at all or they are altered in the long term, for example the landscape, sights and tourist infrastructure, while variable factors include the goods and the investments that connect these goods and its placement on the market. Destinations are not static; they are developed and modified in accordance with changes in the tourist offer and demand. In this respect, destination management has to consider today's most relevant changes in tourist demand, such as: the need for shorter trips, returning to nature, the need for safety and physical and mental retreat. In other words, bathing and sunbathing are not as popular as they were since tourists want to experience something new and completely different. Despite the abovementioned facts, Croatia is still a traditional seaside and holiday destination, which was confirmed by the last survey about basic tourist motives to choose Croatia as a holiday destination (Marušić et. al., 2011).

The survey shows that the main reason for choosing a tourist destination in Croatia remains vacation and relaxation. Other reasons, which attract one fourth or fifth of tourists are natural beauty, new experiences and adventures and a rich gastronomic offer. Even though sightseeing and local culture as reasons for choosing a holiday destination are increasing slightly, the fact that 1 out of 10 guests listed sports and recreation as a reason to choose a holiday destination is concerning.

Croatia should adjust its tourist offer according to the demands of the increasing tourist market, such as the sports market, nature, culture and “quality living” market. The main motive when choosing a vacation destination is passive relaxation on or by the sea, which implies the well-known fact that such motives include lower consumption.

Motives such as sports, recreation, culture, shopping and other more complex tourist attractions involve higher tourist consumption. It is the opinion of the authors that we have to focus on those motives that bring higher levels of pleasure for tourists like, for example, recreation in a holiday destination. In the following chapter we want to explain how organizing sporting events such as sailing regattas can provoke an increase in the consumption and promotion of a holiday destination.

### **The importance of sports in the promotion of a tourist destination**

Sports and contemporary tourism are two connected phenomena, whereby sports is not only a factor in improving a tourist attraction, but also a basic motive for travelling to a certain destination. Based on the travelling motivation today the term sports tourism was coined, in order to describe one of many aspects of tourism. It occurs in different forms: competitive sports tourism, summer and winter recreational tourism.

Development of sports and recreation in a destination can have multiple effects. Apart from social effects, it is possible to distinguish the direct and indirect economic effects of sports in tourism (Bartoluci, 2003). Direct economic effects are calculated for companies that sell sporting goods, while indirect effects can be subdivided into the following factors:

- Motivation for choosing a destination,
- Prolongation of the tourist season,
- Overcoming the seasonal character of tourism,
- Increasing the consumption that is not connected to accommodation,
- Improving the diversity and quality of the tourist offer.

Sporting events are a particularly popular way of attracting tourists. Because of this, the local management organizes such events as a strategy of tourist product differentiation, creation of a brand and improvement of destination image. The biggest attention is drawn because of mega events such as the Olympic Games or the World Cup. Tourism results were accomplished through the following events (CTO, 2011):

- The FIFA Football World Cup held in France in 1998 attracted 900 000 tourists and generated \$12, 3 billion.
- The 2000 Olympics in Sydney attracted additional 110 000 international tourists.
- Euro 2004 held in Portugal in 2004 attracted 500 000 tourists and generated \$320 billion.
- Monaco Grand Prix attracts around 200 00 visitors each year.

Sports tourism is one of the special selective forms of tourism that attracts tourists who are seeking new adventures, an active vacation and the contact with nature. Even though today, 68.5% of tourist motives when choosing a holiday destination in Croatia are bathing and staying by the sea, the fact that 10.5% of tourists are motivated by sports and recreation has to be considered (Marušić et. al., 2011).

Proving the importance of sports tourism, studies have shown that in some countries, sport can account for as much as 25% of all tourism receipts (Tourism Review, 2010). But in order for sports tourism to provide such results, some basic needs of its development, such as modern tourist and sports infrastructure, innovated contents, objects and programs, have to be fulfilled.

It is important to encourage the existing and develop new sporting events in Croatia, which give us the advantage on the global tourist market, and promote our tourism in the best possible way. It can be concluded that sporting events and recreation are an important factor for attracting tourists and for increasing the tourist consumption.

### **Croatian Adria Cup – sailing regattas, promoters of tourist’s experience**

Based on the model of sailing regattas that take place in 14 tourist destinations and that are joined in the unique competition under the name “Croatian Adria Cup – Sailing Cup”, the following chapter wants to reveal how a regatta affects the promotion of a tourist destination. The mentioned destinations had 889.000 tourist visits or 7.469.000 overnight stays in the total tourist visits in Croatia last year, which is 12.5% of all visits or 10.8% of all overnight stays compared to all overnight stays in Croatia (Marušić et. al., 2011). The conclusions are representative with characteristics that are valid for other destinations on the Adria, whose number amounts to 85 tourist townships or cities - arranged in 7 coastal counties (Marušić et. al., 2011). The mentioned area has 86 active sailing clubs (HJS, 2011). The question is how these regattas have affected the promotion of a destination and the experience of tourists that were staying there during the regatta. Questions that commonly confront organizers and local authorities who support the regattas from their budgets, and are important for representatives of tourist agencies and managers, and which were asked in four different tourist destinations in the competitive season in 2010 are:

1. "How much do regattas affect the promotion and experience of a holiday destination"?
2. "To which extent do tourists passively participate in regattas – taking pictures, watching etc.?"
3. "To which extent do accompanying events affect tourist's perception of a destination – dancing, folklore, fisherman's evenings...?"
4. "To which extent do regattas affect the mobilization and perception of the port, berths, cities etc.?"

A survey that has been conducted in the season 2010 in the tourist destinations Malinska, Krk, Cres and Punat revealed the following answers:

Table 1. Grading the importance of the asked questions (respondents: tourist guides and representatives of travel agencies). Grade 1 means bad, 5 highly positive.

Question number	Punat	Cres	Krk	Malinska	Estimation
1.	4	4	5	4	4,3
2.	4	3	4	4	3,7
3.	4	3	5	5	4,3
4.	3	3	4	3	3,3
Total	3,8	3,2	4,5	4,0	3,88

Source: Survey conducted in four destinations; respondents: 65 tourist guides and representatives of travel agencies, the survey was conducted at the time when regattas took place in Malinska, Krk, Cres and Punat, in May 2010.

Based on the survey described in Table 1, we can conclude that respondents consider regattas as an important part of a destination promotion. They think that tourists enjoy regattas as a part of tourist attraction and also as an event in which they passively participate and which indirectly includes some other events that make a destination more attractive and broaden the general experience of a destination. The financing and revenue structure of sailing regattas is a question that gives additional answers when it comes to the role of regattas in the tourist destinations promotion on the Adria. The further research shows how much pressure the regatta organization puts on the local authorities. Table 2 shows the budget structure, budget elements and financing sources of sailing regattas. The research was conducted based on the budget, revenues and expenditures of 13 local authorities of the cities where the Croatian Adria Cup takes place. The study data was presented as the arithmetic means of the above mentioned thirteen local authorities units: Rabac, Opatija, Rijeka, Kostrena, Kraljevica, Crikvenica, Čavle, Novi Vinodolski, Malinska, Omišalj, Krk, Punat and Senj.

Table 2. Average amounts of budget elements in local units, tourist board and sailing clubs in KN (000)

Description of the items	Total budget of all 13 units	Expenses in budgets for events in 13 units	Expenses for regattas according to the plan of tourist board	Total expenditures for 13 regattas	Expenses per overnight stay	Expenses for one regatta
Number	1	2	3	4	5	6
absolute	21.560	7.539	21	585	0,04 kuna	45
in %	100,00	31,7	1,32	2,81		

Source: Interpretation of authors based on 13 local authorities budgets and 13 sailing clubs that participated in their own regattas in the Croatian Adria Cup, Opatija, May 2011.

Based on Table 2 and all the given data, we can conclude that regattas are partly financed by local authorities and partly through personal income and sponsors, regattas also represent a light financial burden to the local authorities. The percentage of the local budgets burden amounts 1.32%, which can be considered a minimal expense when we compare it to the fact how much it positively affects the size of promotion and possible stimulation of tourists to perceive the destination as a desirable and attractive holiday destination and motivates them to come back the following year.

Participants in sailing regattas, skippers and crew members are an important part of the sailing regattas that are scored in the "Croatian Adria Cup" and the question is whether they can influence the promotion increase of a certain tourist destination. The possible answers will be presented by the SWOT analysis, for whose purpose a survey has been conducted among 20 teams. Respondents are skippers and two crew members from five teams and the survey has been conducted in four destinations: Malinska, Krk, Punat and Crikvenica. The question was: "Please name the strengths,

weaknesses, opportunities and threats of sailing regattas in increasing the promotion of a tourist destination where the regattas are taking place”. The given answers are arranged in the following SWOT matrix:

Table 3. SWOT matrix: “The promotion increase of a tourist destination thanks to the sailing regatta”

Strengths	Weaknesses
<ul style="list-style-type: none"> <li>- Attractive event</li> <li>- Encouragement for new events</li> <li>- The destination experience</li> <li>- Pleasant atmosphere</li> </ul>	<ul style="list-style-type: none"> <li>- Few accompanying events</li> <li>- Poorly informed tourists</li> <li>- Unclear sailing area</li> <li>- Tourists can not participate</li> </ul>
Opportunities	Threats
<ul style="list-style-type: none"> <li>- Consumption increase</li> <li>- More attractive destination</li> <li>- Taking photographs and other adventures</li> <li>- Creation of an attractive picture base</li> </ul>	<ul style="list-style-type: none"> <li>- Poor interest</li> <li>- Climate and unpredictable weather</li> <li>- Non participation of tourists</li> <li>- Increase of the crowd in the peak of the season</li> </ul>

Source: Interpretation of authors

The SWOT matrix shows basic conclusions of sailing regattas:

- Strengths and weaknesses according to the inner environment of the sailing regatta: attractiveness, positive atmosphere, experience and increased possibility of the promotion of a certain destination. There are also inner weaknesses that come from discrepancies and misunderstandings in the tourist destination itself, such as the low interest of local authorities, low utilization of potentials and possibilities that the regatta provides and tourists expect to see.
- Opportunities and threats that come from the external environment of a sailing regatta: the possibility of an increased tourist consumption, increase of the attractiveness of a destination and creation of a positive image of a destination. There are also threats that come from the external environment of the regatta such as: low interest of tourists, traffic jams and crowded streets in the peak of the tourist season.

Based on the SWOT matrix and the well known facts we can conclude that the participants in regattas: skippers, boat owners, crew members, management of sailing clubs, local authorities members, judges and delegates of the Croatian Sailing Association make a total human potential that moves, organizes, leads and controls all functions of sailing regattas that have the following goals:

- Development of sailing and recreation in tourist destinations
- Promotion of a destination as a unique and integrated event
- Expansion of tourist attraction and tourist experiences, locals and excursionists
- Linking more events in one unique manifestation (regatta, dinner, concerts, exhibitions etc.)
- Increase of tourist consumption ( restaurants, souvenir shops)
- Linking a larger number of economic interests (sponsors)
- Development of general social interests (sports associations, cultural associations etc)

From all the presented facts it can be concluded that sailing regattas enhance the overall experience and encourage tourists to spend more. They are not a big financial burden to local authorities and tourist boards, and they have many advantages. It is hard to measure the level of promotion of the destination but it surely enhances the experience and the atmosphere that encourages the tourists to return and to consider a certain destination as a desirable one. Participants, contestants and organizers of regattas invest a lot of work and personal funds (they are always boat owners) when organizing sailing, by which they directly encourage tourists to perceive a destination as a desirable one, and sends them a clear message “come again – you have experienced our destination in a special way”.

## Conclusion

The main reasons for choosing Croatia as a holiday destination are still mostly connected with motives as relaxation and passive vacation by the sea. The Croatian tourist offer has to encourage and develop sporting events that will ensure an advantage over the competition on the global tourist market and to promote Croatia as a tourist destination in the best possible way. Sailing regattas that with its attractive programmes, number of participants and motives for organization of other events encourage a higher level of interest with a certain amount of tourists, who passively or actively participate in events connected to the sailing regattas in Croatia. The organization of sailing regattas presents a minimal financial burden to local authorities, but their effect is multiple and it provides both economic and noneconomic effects. The sailing regatta increases the tourists’ experience and the perception that encourages them to return and choose a certain destination as a desirable one. Sailing regattas are an important factor as the tourist destination promotion on the Adriatic coast.

## References

1. Bartoluci, M. (2003). *Ekonomika i menadžment sporta*. Zagreb: Informator.
2. Cerović, Z. (2009). *Animacija u turizmu*. Opatija: Fakultet za menadžment u turizmu i ugostiteljstvu.
3. CTO (Caribbean Tourism Organization) (2011). *Sports Tourism* /online/. <http://www.onecaribbean.org/content/files/SportsTourism.pdf>, Retrieved on 15.05.2011.
4. HJS (2011). Hrvatski jedriličarski savez /online/. <http://www.hjs.hr> Retrieved on 26.04.2011.
5. Magaš, M. (2003). *Management turističke organizacije i destinacije*. Opatija: Fakultet za turistički i hotelski menadžment.
6. Marušić, Z., et al. (2011). Stavovi i potrošnja turista u Hrvatskoj – TOMAS Ljeto 2010. Zagreb. Institute for Tourism.
7. Tourism Review (2010). *The Evolution of Modern Sports Tourism* /online/. <http://www.tourism-review.com/fm1385/profi.pdf>, Retrieved on 13.04.2011.

## PROFILES, SPORT HABITS AND TOURISM MOTIVES OF FITNESS CENTERS' VISITORS

Marko Perić

*Faculty for tourism and hospitality management, Opatija, Croatia*

### Abstract

Sport in the modern time is not only an important content of our daily lives but it is also important content of stay in a tourist destination. Tourists seek a wide range of experiences and wish to feel enriched by engaging in new and specific sports activities. Therefore, the types of sports and sports services directly affect the tourists when choosing a destination they will visit and sport is frequently the main motive for travelling to a certain tourist destination. The aim of this paper is to analyze the profiles, tourism motives and sport habits of fitness centers' visitors during the holidays. The research was conducted through a questionnaire with specific target groups of sports participant in two fitness centers in Rijeka. Results were analysed during June 2010 and could be of great importance to both managers in tourism and sport.

**Key words:** *sports participants, sports activities, holidays*

### Introduction

Tourism and sport are two cognate and closely interrelated social phenomena. The interrelationship between tourism and sport was analysed by many authors (Hunziker & Krapf, 1942; Anthony, 1966; Glyptis, 1982; Standeven & De Knop, 1999; De Knop & Van Hoecke, 2003; Bartoluci, 2003), and as well as the similarity of their functions, it originates from the fact that the bearers of these two occurrences are as a rule the same subjects, i.e. tourists. Tourism, as an experience-oriented activity, and sport, as a performance-oriented activity, are very much like Siamese twins (Keller, 2002). Connection between travel motivators and sports participation is not new too. Motives for participating in sports involve the individual characteristics – interests, needs, goals and personality (Weinberg & Gould, 2008) and are also linked to similar work on the social-psychology of leisure (Mannel & Kleiber, 1997). There are clearly motives which are more specifically identified with sport (rather than tourism) such as competitiveness, a desire to win, the testing of one's abilities and the development of skills and competencies but many other motives might also be claimed by tourism. Complemented McIntosh and Goeldner (1986) classification system of the various travel motivators include physical (refreshment of body and mind and "recharging batteries" (Cohen 1988), health purposes – fitness and general wellbeing (Astrand, 1978; Long, 1990), weight control, physical appearance (Reeves, 2000)), interpersonal (sense of affiliation, visit friends and relatives – emotional warmth (Elias & Dunning, 1986), to expect unexpected, need to escape from routine experiences – "quest for excitement" (Elias & Dunning, 1986), and "ritual inversion" (Graburn, 1983) and status and prestige motivators (personal development, goal achievement, ego enhancement) that have relevance to sport. In each of these areas it is clear that the motives of the sports participants and the tourists can be remarkably similar. Considering sport as motivation for travelling, sport in the modern tourism has not only a perceptual role, but becomes ever more important contents of stay, with tourists who become active participants in various sports activities (Bartoluci, 2003). Furthermore, not only sport does become one of the contents of stay, but it is frequently the main motive for travelling to a certain tourist destination what makes a good foundation for development of selective form of tourism – *sports tourism*. It was back in 1997 that it was first suggested that sports tourism could be better categorised by a consumer motivation approach (Gammon & Robinson 1997). They make a distinction in two forms of sport-tourism using the term *sport tourism* if sport is the primary reason to travel and *tourism sport* if participation is seen as a secondary activity. Regarding sports tourists in general, Reeves (2000) identified six different visitor types, which are divided into: incidental, sporadic, occasional, regular, dedicated and driven. Weed and Bull (2004) structured the profiles of a variety of sports tourists under the three headings – primary sports tourists, associated sports tourists and tourists interested in sport, modified the supply side of the market for sports tourism from Glyptis's work (1982) and updated sports tourism types as tourism with sports content, sports participation tourism, sports training, sports events, and luxury sports tourism. As far as Croatia is concerned, the survey "Attitudes and Expenditures of Tourists in Croatia TOMAS" have been conducted by the Institute for Tourism since 1987 with the goal to obtain a profile on the attitudes and behaviour of tourists in Croatia. Although with the share of 10% in 2007, *sport and recreation* was only the seventh-ranking motive for visiting Croatia, that motive demonstrated a decline in importance and in 2010 had a share of only 8% among all motives (Institut za turizam, 2010). Researches that focus on specific profiles and motives of fitness centers' visitors usually do not analyse their tourism motives and it is still quite unexplored field of research. Although it is difficult task, defining a profile and motives for travelling of fitness centers'

visitors can ease the examination of the nature and extent of sports tourism provision and can assist in examining the range of strategies used by sports tourism managers and providers.

## Methods

Author tried, based on long term experience working with top and amateur athletes as well as numerous interviews with the concerned, to analyze the profiles, sport habits and motives of fitness centers' visitors when tourism is concerned, more precisely during their holidays. The empirical research was conducted by questionnaire distributed within specific target groups of sports participant in two fitness centers in Rijeka. There were 100 questionnaires in total, 50 in each fitness center. Data were collected during one week period in May 2010. The targeted groups were individuals in the gym, and participants in group trainings, both males and females. The questionnaire was prepared in Croatian language only and it is divided in two parts. First, the general demographic profiles of the respondents were examined. The second part (14 questions in total) examined the respondents' habits and motives when tourism and participation in sports activities during holidays are concerned. The response rate was very good and data analysis is based on 96 valid questionnaires. Data were analysed in June 2010 using simple descriptive statistical analysis.

## Results

Descriptive statistical analysis was run on respondents' demographic variables. The results are shown in Table 1. The sample contained more females (55.2 per cent) than males (44.8 per cent). The average age of the respondents was 29 years of age and more than 53 per cent of them were between 25 and 35 years old. Among 96 respondents, 9 of them (9.4 per cent) were professional and 87 (90.6 per cent) were amateur athletes. The average frequency of sports participation is 3.5 times per a week and 49 per cent have 2 or 3 trainings per a week and 32.3 per cent have 4 to 6 trainings per a week. Moreover, more than 81 per cent have between 2 and 6 trainings per a week, and 16.6 per cent train once or more per a day.

Table 1. Profile of survey respondents

Items	Percentage	Items	Percentage
<i>Gender</i>		<i>Sports participation</i>	
Male	44.8	Professional	9.4
Female	55.2	Amateur	90.6
		<i>Frequency of sports participation</i>	
<i>Age</i>		Several time per a day	6.2
Under 18	0.0	Daily – once a day	10.4
18-25	27.1	4-6 time per a week	32.3
25-35	53.1	2-3 times per a week	49.0
35 and above	19.8	1 time per a week	2.1
		Do not participate in sports activities	0.0

Regarding the respondents' habits and motives when tourism and participation in sports activities during holidays are concerned, the most interesting results are shown in Table 2. The majority of the respondents (63.1 per cent) go more often on summer holidays than winter (only 7.4 per cent) while 29.5 per cent go on both summer and winter holidays. Also, the majority (84.4 per cent) travel on holidays outside their place of residence. For more than 60 per cent the length of staying abroad is between one and two weeks. The main motive for travel is *entertainment* (72.6 per cent), the second is visiting *family, relatives and friends* (21.1 per cent) and on the third place is *sport and recreation as competitor and/or observer* (20.0 per cent). Sport is the main and the most important motive for only 15.8 per cent, while for 33.7 per cent of respondents sport is not the motive for travelling at all. On average, one-quarter (25.3 per cent) of respondents mentioned some other motives for travel such as "rest", "relaxation" etc. While on holidays, all the respondents participate in some type of sport activities. Altogether 47 respondents (49.5 per cent) are mostly active on holidays, 29 respondents (30.5 per cent) are dominantly active and 3 respondents (3.3 per cent) are extremely active on holidays. Only 16 respondents (16.8 per cent) are mostly passive and there is no completely passive persons while on holidays. Moreover, 34 respondents (35.8 per cent) are engaged in sports activities on regular basis – once a day, followed by the respondents that are engaged in sports activities one to three times during their holidays (22.1 per cent), respondents that are engaged in sports activities more than once per a day (20.0 per cent), and the respondents that are engaged in sports activities four to six times during their holidays (17.9 per cent).



Table 2. Habits and motives of survey respondents (selection from questionnaire)

Items/question	Answers	Percentage
Do you travel on holidays (outside of your residence)?	a) Yes	84.4%
	b) No	15.6%
Do you travel to the summer and/or winter holidays? (1 answer)	a) Summer only	28.4%
	b) More often summer	34.7%
	c) Summer and winter	29.5%
	d) More often winter	5.3%
	e) Winter only	2.1%
What are your main motives for going on holidays? (max 2 answers)	a) Entertainment/fun	72.6%
	b) Health	10.5%
	c) Sport&Recreation (as competitor and/or observer)	20.0%
	d) Cultural events	7.4%
	e) Visit to family, relatives and friends	21.1%
	f) Shopping	2.1%
	g) Other (please add)	25.3%
During holidays, you are (1 answer):	a) Completely passive	0.0%
	b) Mostly passive	16.8%
	c) Mostly active	49.5%
	d) Dominantly active	30.5%
	e) Extremely active	3.2%
What are your main motives for participating in sport activities while on holidays? (max 3 answers)	a) Medical reasons (doctor recommendation)	23.2%
	b) Aesthetic and health reasons (wellbeing, physical appearance)	55.8%
	c) Quest for excitement	18.9%
	d) Socializing with people	58.9%
	e) Status and prestige	2.1%
	f) Other (please add)	12.6%
	g) I do not participate in sports activities	1.1%

By far the most popular sport/activity on summer holidays is *swimming* (83.2 per cent), followed by running (22.1 per cent), bicycling (21.1 per cent), beach volley (20.0 per cent), diving (16.8 per cent) and fitness/gym (15.8 per cent). On the other hand, when winter holidays are concerned, the most popular sport/activity is *skiing* (40.0 per cent), followed by fitness/gym (26.3 per cent), running (17.9 per cent), various types of aerobics (15.8 per cent) and mountaineering (12.2 per cent). It is interesting to notice that the main motives for participating in sports activities during holidays are *socializing with people* (58.9 per cent) and *aesthetic and health reasons meaning wellbeing and physical appearance* (55.8 per cent). Doctor's recommendation is the main motive for 23.2 per cent, quest for excitement for 18.9 per cent, while status and prestige is the main motive for only 2.1 per cent of respondents. Altogether 12.6 per cent of respondents mentioned some other motive for participating in sports activities during holidays as "enjoying in the nature", "fun/entertainment", "to be fit" or "just habit". On the question whether they visit sports events (games) during the holidays, the majority of respondents (66.7 per cent) answered they do not visit or very rarely visit sports events and only 33.3 per cent visit sports events on regular basis. The most popular sports events, both at home and during holidays, are football matches (45.8 per cent), sailing regatta (29.2 per cent), handball matches (28.1 per cent), tennis match (22.9 per cent) and basketball matches (19.8 per cent). Also, football matches are the most popular among men (60.5 per cent visited football match) but also among women (33.9 per cent). As far as mega events are concerned, 18.8 per cent of respondents have visited World Cup in football, 9.4 per cent visited World Handball Championship (also hosted by Croatia in 2009), 7.3 per cent visited Mediterranean Games, 7.3 per cent visited Winter Olympics and 6.2 per cent visited Summer Olympics. If having an opportunity, significant share of respondents would like to visit the world championships in team sports – football, handball, basketball (43.8 per cent) and Summer Olympics (40.6 per cent). It is interesting to notice that although only two women have visited Formula 1 Grand Prix event, eleven of them (20.7 per cent) would like to visit it in the future.

## Discussion and conclusions

Contemporary tourist destinations offer to its visitors the opportunity to develop their personal potential through active involvement in various sports and sports events. In such a way, destinations create set of experiences in sport which tourist can “take home” and share with the friends and families. In order to develop an adequate system of experiences destination and sports managers need to know and understand the motives and profile of participants in sports tourism. The research has shown the typical profile of sport participant in fitness centers – she or he is 29 years old amateur and trains three times per a week. When it comes to tourism, she/he goes more often on summer rather than winter holidays, between a week and two of stay, and usually outside her/his place of residence. The main motive for her/his travel is entertainment while sport and recreation as competitor and/or observer is on the third place and the most important motive for only 15.8 per cent of them. While on holidays, she/he is mostly active enjoying regularly in single-sport activities, before all swimming in summer and skiing in winter. The main motives for her/his participation in sports activities during holidays are socializing with people and aesthetic and medical reasons meaning wellbeing and physical appearance. She/he is not so interested in visiting other sports events during the holidays, but the most popular sports events are football matches, both for men and women. When she/he would have an opportunity, she/he would like to spend their holidays visiting one of the world championships in team sports (football, handball, basketball) and Summer Olympics. It could be concluded that sport habits of typical fitness centers’ visitors to some extent affect their travel and tourism motives. Typical fitness center’ visitor is occasional sports tourist (tourist interested in sport) for whom sport is not the primary trip purpose but is enjoying regularly in sport activities during holidays. Understanding, implementing and managing the profile of sports participants and their habits, motives and attitudes not only to sports but also to tourism and holidays may be crucial task for both destination and sports managers in attracting sports tourists and convincing them to stay in the destination.

## References

1. Anthony, D. (1966). *Sport and Tourism*. London: CCPR.
2. Astrand, P.-O. (1978). *Health and Fitness*. New York: Skandia Insurance Company.
3. Bartoluci, M. (2003). *Ekonomika i menadžment sporta*. [Economics and management of sport. In Croatian.] 2<sup>nd</sup> revised ed. Zagreb: Informator, Kineziološki fakultet Sveučilišta u Zagrebu.
4. Cohen, E. (1988). Traditions in the qualitative sociology of tourism. *Annals of Tourism Research*, 15 (1), 29-46.
5. De Knop, P. & Van Hoecke, J. (2003). The Place of Sport in the Battle for the Tourist: A Figurational Perspective of the Development of Sport Tourism. *Kinesiology*, 35(1), 59-69.
6. Elias, N. & Dunning, E. (1986). *Quest for excitement, Sport and Leisure in the Civilising Process*. Oxford: Basil Blackwell.
7. Gammon, S. & Robinson, T. (1997). Sport and tourism: A conceptual framework, *Journal of Sport Tourism*, 4(3), 8-24.
8. Glyptis, S. A. (1982). *Sport and Tourism in Western Europe*. London: British Travel Education Trust.
9. Graburn, N. H. H. (1983). The anthropology of tourism. *Annals of Tourism Research*, 10 (1), 9-33.
10. Hunziker, W. & Krapf, K. (1942). *Grundriss der Allgemeinen Fremdenverkehrslehre*. Zurich: Polygraphischer Verlag.
11. Institut za turizam. (2010). *Stavovi i potrošnja turista u Hrvatskoj TOMAS 2010*. [Attitudes and expenditures of tourists in Croatia TOMAS 2010. In Croatian.] Zagreb: Institut za turizam.
12. Keller, P. (2002). *Sport & tourism: Introductory Report*. World Conference on Sport and Tourism, Barcelona, 22 and 23 February 2001. Madrid: WTO.
13. Long, J. (1990). Leisure, health and wellbeing: editor’s introduction. In J. Long (Ed.), *Leisure, Health and Wellbeing, Conference Papers, No. 44*, Eastbourne: Leisure Studies Association.
14. Mannel, R.C. & Kleiber, D.A. (1997). *A Social Psychology of Leisure*. State College, PA: Venture Publishing.
15. McIntosh, R.W. & Goeldner, C.R., (1986). *Tourism Principles, Practices, Philosophies (5<sup>th</sup> edition)*. Columbus OH: Grid Publishing.
16. Reeves, M.R. (2000). *Evidencing the sport-tourism interrelationship*. Unpublished PhD thesis, Loughborough University.
17. Standeven, J. & De Knop, P. (1999). *Sport Tourism*. Champaign IL: Human Kinetics.
18. Weed, M. & Bull, C. (2004). *Sport Tourism: Participants, policy and providers*. Oxford: Elsevier Butterworth Heinemann.
- Weinberg, R.S. & Gould, D. (2008). *Foundations of Sport and Exercise Psychology (Fourth edition)*. Champaign IL: Human Kinetics.





# Research Methodology

**6<sup>th</sup> INTERNATIONAL  
SCIENTIFIC  
CONFERENCE ON  
KINESIOLOGY**

**“INTEGRATIVE POWER OF  
KINESIOLOGY”**

**Editor:  
Prof. Franjo Prot, PhD**

**Peer Reviewers:  
Prof. Weimo Zhu, PhD  
Prof. Franjo Prot, PhD  
Prof. Rado Pišot, PhD  
Prof. Ksenija Bosnar, PhD  
Prof. Mike Hughes, PhD  
Prof. Nic James, PhD**



**Secretary:  
Prof. Goran Sporiš, PhD**

## CONTEMPORARY APPROACH IN MEASURING AND ANALYSING FUNDAMENTAL MOTOR PATTERNS

Rado Pišot<sup>1</sup>, Peter Kokol<sup>2</sup> and Franjo Prot<sup>3</sup>

<sup>1</sup>University of Primorska, Science and Research Centre of Koper, Institute for Kinesiology Research, Slovenia

<sup>2</sup>University of Maribor, Faculty of Health Sciences, Slovenia

<sup>3</sup>Faculty of Kinesiology, University of Zagreb, Croatia

### Purpose

Fundamental Motor Patterns (FMP) are the foundation movements or precursor patterns to more specialized, complex motor stereotypes – used in everyday activities, work, sports and recreational activities. The reasons for examining, measuring and analysing FMP and consequently the manners have changed with the aim to seek for solutions that would offer every individual and the society all the answers for resolving problems, improving efficiency and increasing the quality of life. Searching for solutions based on clinical cases, deformations or rehabilitation procedures is still submitted to the necessity to understand the elementary movement as the consequence of adapting to various work requirements, the environment and inappropriate lifestyle of an increasing share of world population. Since the formation of FMP is most intensive in the early developmental phase, it is as the area of basic research interest, which despite intensive impacts of developmental processes that additionally aggravate the analysis needs to be focused on the pattern of children. Motor development consists of dynamic and continuous development in interaction with inheritative and environmental factors and is reflected in motor competencies formed by motor abilities and motor knowledge.

### Methods

Those latent variables cannot be measured directly and are usually assessed by measuring related behaviours, defined by sets of standardised items. On the basis of the chosen battery of testing with the aid of modern instruments we performed the complete kinematic evaluation of FMP; analysis of peculiarities of measured FMP; adaptation and interdependencies among different FMP; analysis of the impact of morphological characteristics on FMP adaptation; and comparison between analysed FMP and life styles of measured subjects. Following the power design analysis, in the framework of the basic research project “Analysis of fundamental motor patterns - skeletal and muscular adaptation to specific sedentary lifestyle factors in children aged 4 – 7 years”, conducted by the Institute for Kinesiology Research, Science and Research Centre of University of Primorska, the sample of children was and will be longitudinally monitored throughout three tests between the years of 2009 to 2012, beginning at the age of 4. FMP were analysed qualitatively and quantitatively with kinematics and biomechanics. The statistical and heuristic data analysis was performed with SPSS, Weka and SAS Analytics software. Among others we used multi-regression analysis, discriminant analysis, multidimensional scaling, non-classification and classification decision trees and neural networks.

### Results

The aim of this paper was to present different possibilities for a new, contemporary approach in process of measuring and defining FMP. Research interest was also to analyse studied FMP and to determine their compliance, phenomenological, anatomical and physiological basis of occurrence. Data are still under evaluation.

### Conclusions

There are several different ways to measure children's FMP performance. The approach it depends from what information is needed and why. We suppose that inadequately developed FMP can have a negative effect on the upgrade of motor stereotypes and consequently also on inadequate and irregular physical activity in adulthood. Incorrect functioning and adaptation of the skeleton-muscular system in locomotion can have numerous negative consequences reflected in individuals' work and lives, but predominantly in their health. We believe that study of FMP must be as possible holistic that we could following findings obtained predict performance, identify exposure to risks and plan interventions, rehabilitation or educational programs.

### Acknowledgments

The authors are grateful to the entire group of researchers of the Institute for Kinesiology Research, Science and Research Centre of University of Primorska for the excellent work done in the framework of the study. We are grateful also to our research partners, kindergartens personnel, teachers, parents and children - study participants for their willingness to participate in a study of such magnitude. This study was financially supported by the Slovenian Research Agency.

## EVALUATION OF A METHOD FOR OBJECTIVE ASSESSMENT OF SITUATIONAL EFFECT IN KARATEKAS THROUGH TECHNICAL -TACTICAL INDEKS FOR SITUATIONAL EFFICIENCY

Hrvoje Sertić, Tihomir Vidranski and Ivan Segedi

*Faculty of Kinesiology, University of Zagreb, Croatia*

### Abstract

Situational efficiency and success in karate fight depends precisely on the performance of different motion structures, different ways and different distances. A review of multiple studies indicates that a structural analysis of karate is largely theoretically analyzed and explained. Range of technical and tactical analysis of karate fights, based on the identification and registration of standard and derived parameters of situational efficiency is not well researched. The aim of this work is an empirical evaluation of a method for objective assessment of situational effects of karate athletes, through technical and tactical situational efficiency indicators (statistical record of the fight), with a tendency to create new solutions, that will be more objective and explicit.

The data are based on DVD recording and analyzing video camera records of 274 combats performed on 19<sup>th</sup> World Karate Championship 2008<sup>th</sup>. Analysis and comparison in variables structure of technical indicators, derived scored and non-scored variables and variables structure of tactical indicators presented in the attack or counterattack on situational performance, provide useful information to the coach about the level and structure of karate athlete resources and also about utilization of this potential and affirmation (manifestation) in fighting and even the possibilities for his development.

**Key words:** *Attack, Counterattack, Score, Situational efficiency*

### Introduction

Situational efficiency and success in karate fight depends precisely on the performance of different motion structures, different ways and different distances. Karate practice must therefore dispose of the exact information about the utilities of different structures of movement in relation to effectiveness in combat. Accordingly, there is a need for identification of technical and tactical indicators (Oliva, et al. 2002).

A review of multiple studies indicates that a structural analysis of karate is largely theoretically analyzed and explained. Range of technical and tactical analysis of karate fights, based on the identification and registration of standard and derived parameters of situational efficiency is not well researched. This fact can be explained by the structural complexity of karate fights, the complexity of identifying the technical and tactical elements that are reflected in the justification, rationality and effectiveness of time for such methodological procedures.

The question is, which activities in the fight and how much their influence contributes to the final outcome of to the fight? If importance of the impact of each of these activities in the fight could be determine, each fighter's performance could be measured through the level of implementation, of each activity or set of activities.

It is therefore possible to conclude that the concept of combat achieved successful conduct of activities, and objectively by indicators of situational efficiency (combat statistics). Thus, activity in the sports combat becomes measurable through situational (competitive) efficiency with technical and tactical indicators of situational efficiency in karate fight.

Recently, a group of authors (Koropanovski, Dopsaj, Jovanović, 2008) searched for the situational indicators of technical-tactical efficiency in elite, male karate athletes, based on scored techniques. In addition to these indicators, karate fight involves a large number of technical-tactical activities, such as movement (*tai no ido*) and derived non-scored techniques, which together with a scored techniques constitute and define karate fight in the final (Vidranski, 2010).

Exactly these parameters define the maximum energy efficiency (Iide, et al. (2008), Beneke, et al. (2004), Imamura, et al. (2002)) and technical-tactical fighter efficiency (Vidranski, 2010). Therefore, the activity of a fighter, consisting of a large number of derivative, non-scored techniques, inevitably affects the defining characteristics of the model of situational efficiency in the fight. While a number of researches include data on the structure of scored karate techniques that make the karate combat, reviewing the available literature, almost no research contain information about the structure of the derivative, non-scored techniques, as well as the ubiquitous indicator of technical and tactical combat structure. Based on this, as in the generalization of results in these studies, it is necessary to observe all performed techniques in combat through the ratio of point system or values 1 point (*ipon*), 2 points (*nihon*) and 3 points (*sanbon*) - (WKF Rules

Regulations and commissions, 2011) so would not have got the impression of the hand-techniques dominance in relation to the overall efficiency of the fight. With regard to reviewing a number of studies, there are no available objective methods for assessing the *situational efficiency karate athletes*, so there is a need for the development of criterion system, which would be constantly evaluated and adapted.

Regarding, that a considerable amount of information, that a competitor in transmitting in combat, is contained in the aggregate registration of events (frequency) of technical-tactical indicators, it is to assume that is possible to estimate analyzed situational efficiency of karate athletes by estimating the method of derived condensation (compression) of specific technical and tactical situational efficiency indicators fighters. Therefore, this scientific work will use the procedure (method) for assessing of analyzed situational efficiency karate athletes on derived data for assessment of situational efficiency karate athletes, and whose pragmatic (predictive) validity will be subject of this work.

## Aim

The aim of this work is an empirical evaluation of a method for objective assessment of situational effects of karate athletes, through technical and tactical situational efficiency indicators (statistical record of the fight), with a tendency to create new solutions, that will be more objective and explicit.

## Methods

### Population and sample entity

Population of entities comprises the total of 274 competitors in 137 fights, seniors, older than 18 years, who participated at the World Karate Championship 2008<sup>th</sup> in Tokyo, Japan. The contestants were participants of the competition from 97 countries, from five continents (Europe, Asia, Africa, Australia, America).

### Sample variables

The sample variables in this study were:

- *12 descriptive variables technique and tactics*: individual techniques *non-scored-attack* ("TEH"nn), individual techniques *scored-attack* ("TEH"bn), individual techniques *non-scored-counterattack* ("TEH"nk), individual techniques *scored-counterattack* ("TEH"bk)
  1. Kizame tsuki (KT\_nn, KT\_bn, KT\_nk, KT\_bk)
  2. Gyaku tsuki jodan (GYJ\_nn, GYJ\_bn, GYJ\_nk, GYJ\_bk,)
  3. Gyaku tsuki chudan (GYC\_nn, GYC\_bn, GYC\_nk, GYC\_bk)
  4. Mawashi geri chudan (MWC\_nn, MWC\_bn, MWC\_nk, MWC\_bk)
  5. Ashi mawashi geri chudan (AMWC\_nn, AMWC\_bn, AMWC\_nk, AMWC\_bk)
  6. Mawashi geri jodan (MWJ\_nn, MWJ\_bn, MWJ\_nk, MWJ\_bk)
  7. Ashi mawashi geri jodan (AMWJ\_nn, AMWJ\_bn, AMWJ\_nk, AMWJ\_bk)
  8. Ura mawashi geri jodan (UMWJ\_nn, UMWJ\_bn, UMWJ\_nk, UMWJ\_bk)
  9. Ashi ura mawashi geri jodan (AUMWJ\_nn, AUMWJ\_bn, AUMWJ\_nk, AUMWJ\_bk)
  10. Ushiro mawashi geri jodan (UMWJ -nn, UMWJ\_bn, UMWJ\_nk ,UMWJ\_bk)
  11. Nage waza-tsuki (NWT\_nn, NWT\_bn, NWT\_nk, NWT\_bk)
  12. Other techniques (OT\_nn, OT\_bn, OT\_nk, OT\_bk)
- *descriptive variables the outcome of the combat*: winn(PJ) and loss(PZ).

### Methods of data analysis

The data are based on DVD recording and analyzing video camera records of 274 combats performed on 19<sup>th</sup> World Karate Championship 2008<sup>th</sup>. Registration data was performed by trained and experienced measurer from Department for Combat Sports, Faculty of Kinesiology, University of Zagreb. From the original data frequency observed 12 techniques collected to determine the significance of individual indicators of technical-tactical activities, were calculated an indicators of situational efficiency techniques and overall situational efficiency in the fight. Thus derived data to estimate the impact of situational efficiency of karate athletes are based on the initial data matrix. Such methods of computation have been given the numerical values of the ratio scale for each of the 2-stage sports fight (attack and counter), which were later used as data for statistical analysis.

For evaluation of a method for objective assessment of situational effects of karate athletes through technical and tactical situational efficiency indicators, for each group, winners and the defeated candidates, was calculated by Spearman's rank correlation coefficient between variables PJ-PZ (*win-loss*) and UK\_SE (*total situational efficiency in the fight*).

For each group, winners and the defeated candidates, were calculated basic statistical parameters: arithmetic mean, standard deviation, minimum and maximum results and measures of asymmetry and curvature distribution. Normality of distribution of variables was tested by Kolmogorov-Smirnov test for the results obtained in the basic variables of situational efficiency. Register of situational indicators was carried out with the help of specialized software package DARTFISH 4.5.2.0. These data were checked and entered into a program for statistical data Statistics 7 (StatSoft, Inc., Tulsa, USA).

## Results and discussion

Table 1. Descriptive parameters and results of Kolmogorov-Smirnov test normality distribution of basic situational indicators

variable	$\bar{x}$	s	min	max	$R_{tot}$	$a_3$	$a_4$	MaxD
POINT	2,19	2,26	0	11	11	1,43	1,93	0,2
PENALTY	0,27	0,53	0	3	3	2	3,88	0,46
FREKTEH	15,24	6,03	3	37	34	0,58	0,12	0,11
FREKBOD	1,58	1,54	0	7	7	1,12	1,16	0,2

Legend:  $\bar{x}$  – arithmetic mean, s – standard deviation, min – minimum, max – maximum,  $R_{tot}$  – total range of scores,  $a_3$  – skewness,  $a_4$  – kurtosis, MaxD – maximum difference between cumulative frequency and cumulative frequency variable for the expected normal distribution, POINT – point, PENALTY – penalty, FREKTEH – frequency of technique, FREKBOD – frequency of point

From the matrix of descriptive parameters (Table 1) it is clear that almost all the variables significantly deviate from normal distribution ( $maxD > TEST$ ), except FREKTEH variable (frequency techniques). For most variables reveals a small positive asymmetry ( $a_3$ ). At variables PENALTY (penalty), POINT (point) and FREKBOD (frequency of point) positive asymmetry is more accentuated, while the variable FREKTEH (frequency of technique) hasn't got expressed asymmetry. On the basis of measures of dispersion (Table 1) reveals a relatively large variability of individual situational variables.

The highest variability was apparent for variable FREKTEH (frequency of technique) with the range of scores 3-37 with moderate arithmetic mean of 15.24. This distribution indicates a high frequency derived non-scored techniques that largely characterized the activities of karate fights. The variability of the variable POINT (point) from 0 to 11 and FREKBOD (frequency points) 0-7 indicates a considerable impact valued techniques NIHON (2) and SANBON (3) the totality of the variability of scored techniques POINT (point). Less variation from 0 and 3 with small arithmetic mean 0.27 shows a variable PENALTY (penalty) because its infrequency in karate fight. Based on the results of the arithmetic mean of the basic variables of situational indicators, it is possible to conclude that the karate fighters on average by 0.27 points battle achieved through a penalty point and 2.19 points was achieved successfully, and 15.24 fail, which means that if we add the frequency of failed techniques to the average frequency of scored techniques which is 1.58, coefficient of utilization averages 13.02%. Finally, with regard to these descriptive parameters, it is possible to notice that the method for estimating total and partial indicators of karate athletes situational efficiency and its variables FREKTEH (frequency of technique) and POINT (point), will have the largest share in determining the position of individual indicators (technique) in the variables of total and partial situational efficiency.

*The overall situational efficiency in the fight* includes all factors of situational efficiency of fighters in a competition that are estimate by experts, and analyzed situational efficiency of karate athletes including only those factors that are monitored through statistical records fight, through technical and tactical situational efficiency indicators. Therefore, analyzed situational efficiency of karate athletes covers only one part of the overall efficiency of the fight that is objectively measured by means of "statistical" records of combat and thus represents a partial efficacy in the fight of karate athletes.

In accordance with the above, assessment of the situational efficiency of an individual karate athletes can be accessed in three ways:

- *objective* assessment of situational effects of karate athletes through technical and tactical situational efficiency indicators (statistical record of the fight).
- *subjective* assessment of success in the fight by of karate athletes by karate experts (as some fighter performs the default technical-tactical tasks in the fight).
- *synthesis* (combination) of both approaches to get the optimal number of sufficient information to assess situational effectiveness of each fighter.



As in the field of scientific and professional knowledge of the Karate sport, until now, has not been used no similar methodologies available, the aim of this work is an empirical evaluation of a method for objective assessment of situational effects of karate athletes through technical and tactical situational efficiency indicators (statistical record of the struggle). For these purposes have been derived data to estimate the impact of situational karate athletes obtained on the basis of the initial data matrix (274 fights in 48 variables = 4642 data) in which the events in each of the variables (48 technical and tactical indicators) are defined as the frequency in which each fighter performed scored, non-scored technique of attack and counterattack. Such methods of computation have been given the numerical values of the score scale for each of the 2-stage sports fight (attack and counter), which were used as indicators of situational efficiency data for statistical analysis.

Data matrix consisted variables of overall situational efficiency achieved in the individual fight (UK\_SE) and variables of situational efficacy of individual techniques realized scored-attack (SE\_TEH-bn) and counterattack (SE\_TEH-bk).

These data have been defined as the ratio between the sum of scored techniques (**bbj**) + penalty point (**kbj**) and sum frequency non-scored techniques (**fnbtj**) + frequency scored techniques (**fbtj**).

Sum of scored techniques (bbj) was derived from the frequency of scored technique with the point value 1 (*ipon*), 2 (*nihon*), 3 (*sanbon*).

$$UK\_SE_j = \frac{bb_j + kb_j}{fnbt_j + fbt_j} \times 100$$

Situational efficiency techniques (SE\_TEH-bn and SE\_TEH-bk) is defined as the ratio between the amount of realized-scored (bbj) and the sum frequency of non-scored techniques (**fnbtj**) + frequency scored techniques (**fbtj**) for attack and counterattack. Sum of scored techniques (**bbj**) was derived from the frequency of scored technique with the point value 1 (*ipon*), 2 (*nihon*), 3 (*sanbon*).

$$SE\_TEH_j = \frac{bb_j}{fnbt_j + fbt_j} \times 100/3$$

This kind of calculation gives a numerical values on score scale for each of the 2-stage sports fight (attack and counter), which are used as data for further statistical analysis. To determine the pragmatic validity of such a way of measuring the situational efficiency of fighters, it is performed Spearman's rank correlation between variables PJ-PZ (*win-loss*) and UK\_SE (*total situational efficiency in the fight*).

Table 2. Spearman's rank correlation coefficients between variables PJ-PZ (*win-loss*) and UK\_SE (*total situational efficiency in the fight*)

n = 274

	UK_SE
PJ_PZ	0,60*

\* Correlation is significant at the level  $p = 0.05$

Table 2 shows statistically significant correlation of 0.60 between the variables PJ\_PZ (*win-loss*) and UK\_SE (*total situational efficiency in the fight*). If we use this correlation coefficient and calculate coefficient of determination, it can be concluded that using the derived variables UK\_SE (*total situational efficiency in the fight*) can successfully explain 36.00% of the variance variables PJ\_PZ (*win-loss*).

In this way, with some certainty ( $r = 0.60$ ) is confirmed the validity of pragmatic variables UK\_SE (*total situational efficiency in the fight*) for predicting success in karate fight. The rest of the unexplained variance, probably belongs to movements, technical and tactical and other indicators, which are excluded from this research. Specifically, this research covered all scored techniques the technical combination, in two basic tactical phases of attack and counterattack. In addition to these indicators karate fight is also made of the complex relations of spatial-temporal modes of movement in combat. Using monitoring this complex indicator and monitoring of certain differentiated tactical sub-phases of combat, it would certainly be significantly explained the variance that can be used for the successful prediction of success in karate fight. For now, with this calculation of the total situational efficiency in a fight, using variable UK\_SE, it could be more precisely define and determine the space which predicts the success in battle and distinguishes the winners from defeated fighters (Table 2).

## Conclusion

Analysis and comparison in variables structure of technical indicators, derived scored and non-scored variables and variables structure of tactical indicators presented in the attack or counterattack on situational performance, provide useful information to the coach about the level and structure of karate athlete resources and also about utilization of this potential and affirmation (manifestation) in fighting and even the possibilities for his development. It is possible to notice that the assessment of situational efficiency of karate athletes (total and partial), has direct use value in guiding and selection karate athletes, and their structure and also model characteristics that determine the combat situational effectiveness karate athletes (total and partial) have an important role for the rational management of training process. Application of these methods would find itself justified in order to establish an effective, purposeful and systematic approach to orientation, selection and training of karate fighters, choosing effective and safe technology simulator, as well as technical and tactical selection of ideas to bring the expected result.

## References

1. Beneke, R., Beyer, T., Jachner, C.; Erasmus, J.; Hutler, M. (2004). Energetics of karate kumite. *European Journal of Applied Physiology*, 92(4-5), 518-523.
2. Dežman, B., S. Trninić, D. Dizdar (2001). Ekspert Model of Decision-Making System for Efficient Orientation of Basketball Players to Positions and Roles in Game – Empirical Verification. *Collegium Antropologicum*, 24(1), 141-152.
3. Dizdar, D., S. Trninić, D. Milanović (1997). Determining basketball player types according to standard indicators of situation-related efficiency. *Kinesiology*, 29 (2):47-53.
4. Dizdar, D. (1997). Evaluation of a model for the final score prediction in several sport games. In: Croatian. Master Thesis. Zagreb: Faculty of Physical Education, University of Zagreb.
5. Dizdar, D. (2001). Evaluation of a set methods for the assessment of actual Quality of basketball players. In: Croatian. Dissertation. Zagreb: Faculty of Physical Education, University of Zagreb.
6. Iide, K. et al. (2008). Physiological responses of simulated karate 250 sparring matches in young men and boys. *Journal of Strength and Conditioning Research*, 22(3), 839-844.
7. Imamura, H., et al. (2002). Physiological responses during and following karate training in women. *Journal of Sports Medicine and Physical Fitness*, 42(4), 431-437.
8. Koropanovski, N., Jovanović, S. Dopsaj, M. (2008). Characteristics of pointing actions of top level female competitors in karate. In: *Proceedings of World Congress of Performance Analysis of Sport VIII*, Magdeburg, 2008 (pp. 386-392). Magdeburg: Otto von Guericke University.
9. Koropanovski, N., Jovanović, S. Dopsaj, M. (2008). Characteristics of pointing actions of top male competitors in karate at world and european level. *Brazilian Journal of Biomechanics*. 2(4), 241-251.
10. Oliva, A.S., Torres, F.B., Navarro, J.M. (2002). Este libro se termino de imprimir en Diseno Grafico Am 2000, Combate Supremo.
11. Vidranski, T. (2010). Structural analysis of situational efficiency indicators in karate fights. (Doctoral thesis, University of Zagreb). Zagreb: University of Zagreb, Faculty of Kinesiology.
12. WKF Rules regulations and commissions (2011): [http://www.wkf.net/images/stories/downloads/wkf\\_rules\\_regulations\\_and\\_commissions\\_eng.pdf](http://www.wkf.net/images/stories/downloads/wkf_rules_regulations_and_commissions_eng.pdf)

## REPEATABILITY OF ELECTROMYOGRAPHIC PARAMETERS USED IN THE ASSESSMENT OF TRUNK STABILITY FUNCTIONS

Nejc Šarabon

*University of Primorska, Science and Research Centre, Institute for Kinesiology Research, Koper, Slovenia  
S2P Ltd. Laboratory for Motor Control and Motor Behaviour, Bled, Slovenia*

### Abstract

The aim of this study was to test intra-session repeatability of automatic neuromuscular responses of three muscles which are involved in lumbo-pelvic stability (LPSM). Sixteen young healthy volunteers participated in the study. Three different tests of trunk stability functions were carried out in each of them: (1) a test of self initiated quick shoulder flexion to test the anticipatory pre-activation patterns of the LPSM, (2) a test of neuromuscular reaction of LPSM on unexpected loading, and (3) a test of neuromuscular reaction of LPSM on unexpected unloading of upper extremities. Forty consecutive trials of each task were carried out. The latency of the neuromuscular responses (LAT) and the rate of LPSM increase in activation (RMS50) were analysed in all of the responses. The dependence of parameters' repeatability on the number of trials averaged was analysed using intra-class correlation coefficient, typical error of measurement and coefficient of variation. For all the three observed muscles and all the motor tasks ICCa values of the RMS50 was generally higher than that of LAT. Eighteen or more trials of the same task are needed to achieve acceptable ICCa values. Results of TE and CV showed progressive decrease with the increasing number of the trials being averaged. The most reduction in TE and CV took place with averaging the first 10 consecutive trials. Based on our results we can conclude that averaging of 20 or more trials of the same lumbo-pelvic stability test will bring us a repeatable measure. However, in order to work with less trials also other methodological approaches such as signal averaging should be considered.

**Key words:** *reliability, equilibrium, balance, low back pain*

### Introduction

Central lumbo-pelvic stability plays an important role in postural, locomotion and manipulation activities of all kinds. Muscles which assure functional stability of this body region (e.i. lumbo-pelvic stabilizing muscles (LPSM)) span from a pelvic girdle up to the thorax and spinal column as well as down to the bone prominences of the lower extremities. However, muscles as dynamic stabilizing components are only the effectors controlled by the conduction and processing functions of the peripheral, spinal and supraspinal nervous system. Neuromuscular control of the lumbo-pelvic region is predominantly aimed at postural requirements and is therefore controlled subconsciously. The automatic actions of the LPSM are embedded in the movement patterns of every dynamic action of the distal body part. Additionally, they stabilize the central body region in case of unpredicted mechanical perturbations of the posture.

In order to evaluate neuromuscular functions of the LPSM two types of tests (i.e. motor tasks) are commonly used. The first group of the tests are quick voluntary arm movements performed by the subject and accompanied measurements of the muscle activation timing (Ramprasad, Shenoy, Singh, Sankara, & Joseley, 2010). It is known that activation of the prime mover (deltoideus in case of shoulder flexion task) is preceded by the anticipatory pre-contraction of the LPSM. In the second group of the tests sudden unexpected mechanical perturbations are used in order to evoke automatic stabilizing reactions of the LPSM (Pedersen, Randers, Skotte, & Krstrup, 2009). In all these tests electromyographic (EMG) signals are acquired and analysed together with the signals from mechanical sensors with which we detect the moment of the perturbation or the start of the voluntary movement, depending on the test we are performing.

The described assessment procedures are often used in research regarding low back pain problems, which is one of the most common musculo-skeletal problems of the current World population (Kuwashima, Aizawa, Nakamura, Taniguchi, & Watanabe, 1997). The EMG responses which are measured with this approach could be classified as neurophysiological evoked responses, and as such, they are characterized by complex underlying neural mechanisms which are known to be continuously fluctuating, unsteady and adaptable. It is therefore a practically relevant issue how to achieve an acceptable level of repeatability in these kinds of neuromuscular tests.

The aim of this study was to test intra-session repeatability of automatic neuromuscular responses of three LPSM. Automatic activation patterns of the muscles were tested using three motor tasks that are often used to test lumbo-pelvic stability functions. Repeatability was analysed in relation to the number of consecutive repetitions of the same test/motor task.

## Methods

**Subjects** – Sixteen healthy volunteers (age  $24.7 \pm 4.4$  years; body height  $175.3 \pm 8.1$  cm; body weight  $73.0 \pm 9.9$  kg) participated in the study. The following criteria were used for exclusion: any acute pain, diagnosed disc hernia, and surgical treatment or pain in the lower back during the last six months. The study was carried out consistently with the Helsinki Declaration and Ovied Convention. The participants signed the informed consent after they had been given a detailed explanation of the experimental procedure.

**Measurement Protocol** – In order to assess trunk stability functions three tests were carried out in each of the subjects. The first test was aimed to test the anticipatory pre-activation of the LPSM. A subject was standing in an upright position with the feet positioned at the hips width and performed trials of quick self-initiated shoulder flexions (from  $0^\circ$  to  $90^\circ$ ). A subject was holding a wooden stick in his hands. The second test involved unexpected loading of the arms in the position of  $70^\circ$  shoulder flexion and  $20^\circ$  elbow flexion. A subject was standing in the same position as in the previous task, his vision was restricted by a non-transparent band and he was holding a light wooden plate in his hands. The mechanical perturbation was done by dropping a 2 kg sandy bag from a 25 cm height. In the third test a subject was placed the same position as in the second one but holding a wooden stick in his hands and sustained a standardized (90 N) isometric shoulder flexion when asked to prepare for an individual measurement trial. Then a quick release was performed, using a special mechanical mechanism placed between the wooden stick and the loading module. Also in this case vision was restricted to minimize possibility of anticipation. Forty trials (divided in 3 sets, with 3-minute breaks) of each test were carried out in each individual. Consecutive trials were repeated in an acyclic manner with pauses ranging between 3 s and 10 s.

Pairs of EMG electrodes (inter-electrode distance of 2 cm) were glued transcutaneously above the following muscles of the right side of the body: m. multifidus (MF), m. erector spine (ES) and long head of m. biceps femoris (BF). Skin preparation and EMG Ag-AgCl electrode placement were done according to the international standards (SENIAM). All the electrodes were additionally fixed by an elastic net to minimize mechanical artefacts. An electronic accelerometer was placed either on the wooden stick or on a plate depending on the test being performed. All the signals detected by the sensors were amplified (Biovision, Wehrheim, Germany), acquired at 10 kHz sampling frequency (NI USB-6343 DAQ card, National Instruments; Austin, Texas, USA) and stored on a personal computer for off-line analyses. A custom built software (LabView, National Instruments; Austin, Texas, USA) was used.

**Data Analysis** – EMG signals were zero aligned, band-pass filtered (10 Hz / 1 kHz, 2<sup>nd</sup> order Butterworth), rectified and smoothed (flow arithmetic mean 50 ms). For each trial two parameters were calculated: (1) latency of the neuromuscular response (LAT) defined as the time between the mechanical event detected by the accelerometer and onset of the muscle's action and (2) rate of change in EMG activity in the first 50 ms after the onset of the muscle's activation expressed as the root mean square of the signal in this time window (RMS<sub>50</sub>). The accelerometer signal was used for the identification of the start of the mechanical event in each of the three measurement tasks. The moment of a sudden rise of the accelerometer signal was defined as the time 0. Thus, if a certain EMG event happened before this, its latency was marked with a negative value (for example anticipatory activation of a muscle). The opposite was the case for a delayed muscle reactions taking place after the mechanical perturbation. Similar analogy holds true for the RMS<sub>50</sub> – positive values expressing rise in activity and negative values deactivation of a pre-contracted muscle.

The pre-processed signals were analysed by the quantification of LAT and RMS<sub>50</sub> of a single neuromuscular response and later calculation of intra-subject average values. Statistical analyses were made with SPSS PASW Statistics 18 software (Chicago, Illinois, USA). Intra-session repeatability was evaluated in the context of the number of consecutive trials used for calculation of an average neuromuscular response. Based on the *n*-consecutive trials of each of the tasks the following statistical calculations were carried out: mean and standard deviation, typical error (TE), coefficient of variation (CV), and average intra-class correlation coefficients (ICCa). In case of TE and CV we divided the 40-trial set of data into two halves which enabled us to perform a test-retest analysis on the averages composed of up to 20 consecutive trials.

## Results

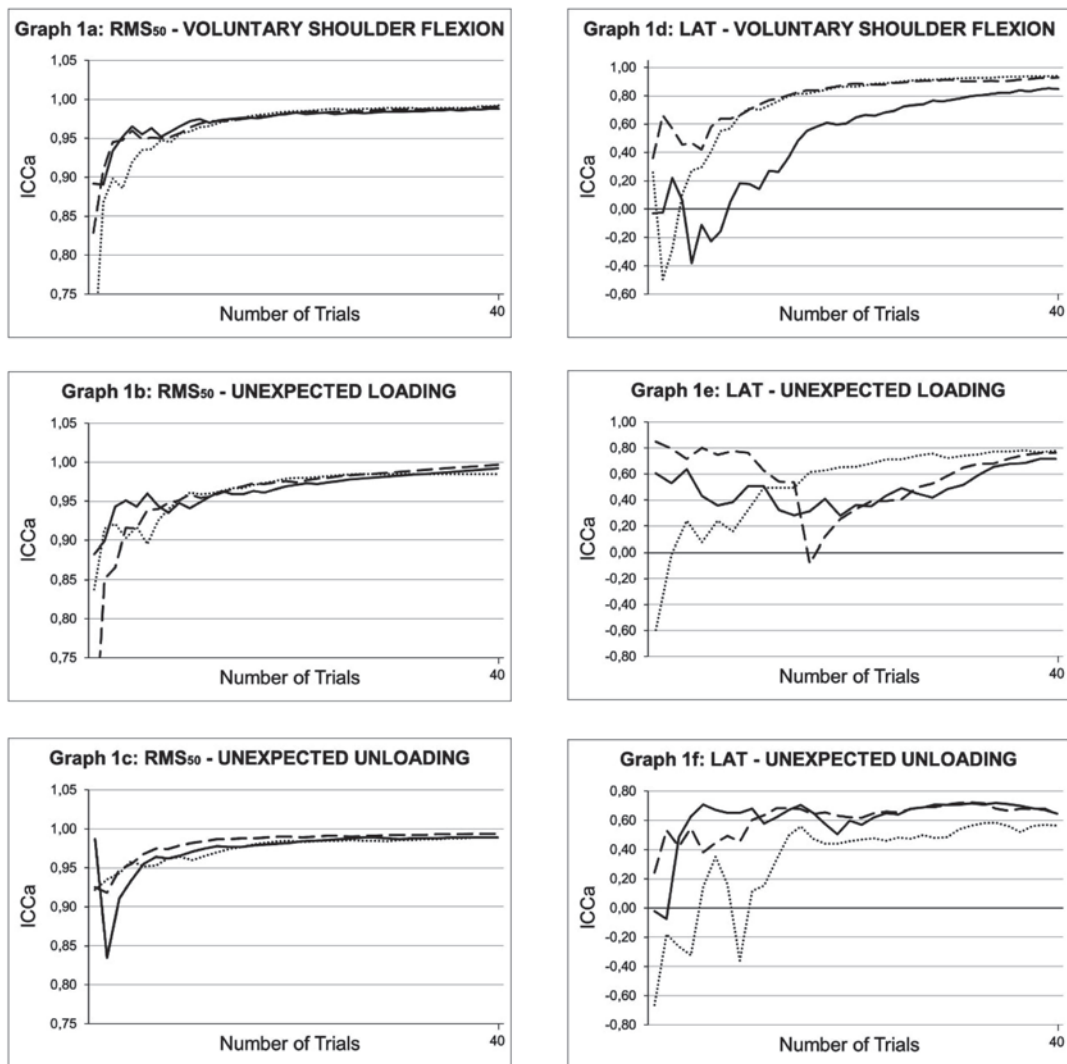
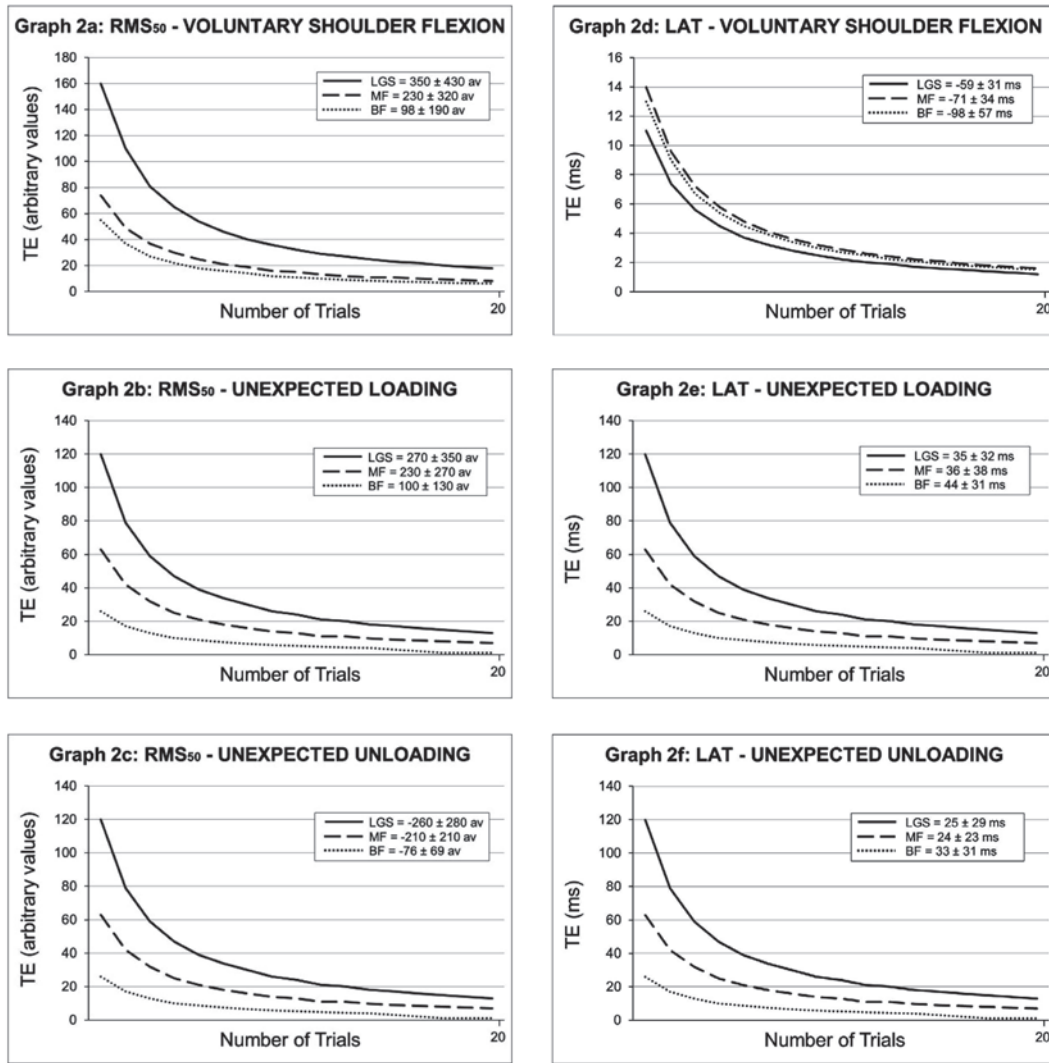

Figure 1. Results for intra-class-correlation (ICCa) for RMS<sub>50</sub> (left) and LAT (right) as a function of the number of trials. Each graph depicts the data for BF (dotted line), ES (dashed line) and MF (solid line).

All results of repeatability analysis are presented in Figures 1, 2, and 3. For all the three observed muscles and all the motor tasks ICCa values of the RMS<sub>50</sub> was generally higher than that of LAT. Some dynamic fluctuations in ICCa were present at lower numbers of consecutive repetitions, however, with larger arrays of consecutive trials an obvious increasing trend in ICCa was observed. For RMS<sub>50</sub> very high ICCa values (> 0,95) were achieved in all three tasks and for all three muscle when the analysis was done on 18 to 21 consecutive trials. ICCa values for LAT were the highest for the voluntary shoulder flexion task (expl. > 0,80 for MF and BF at > 15 trials), while in the other two tasks much less consistency was observed.



Average ± SD values are included for all of the parameters/tasks/muscles.

Figure 2. Results for typical error of measurement (TE) for RMS<sub>50</sub> (left) and LAT (right) as a function of the number of consecutive trials. Each graph depicts the data for BF (dotted line), ES (dashed line) and MF (solid line).

Results of TE and CV showed progressive decrease with the increasing number of the trials being averaged. This decrease was present in all the tasks and muscles; both, in RMS<sub>50</sub> as well as in LAT. The most improvement in TE and CV took place with averaging the first 10 consecutive trials.

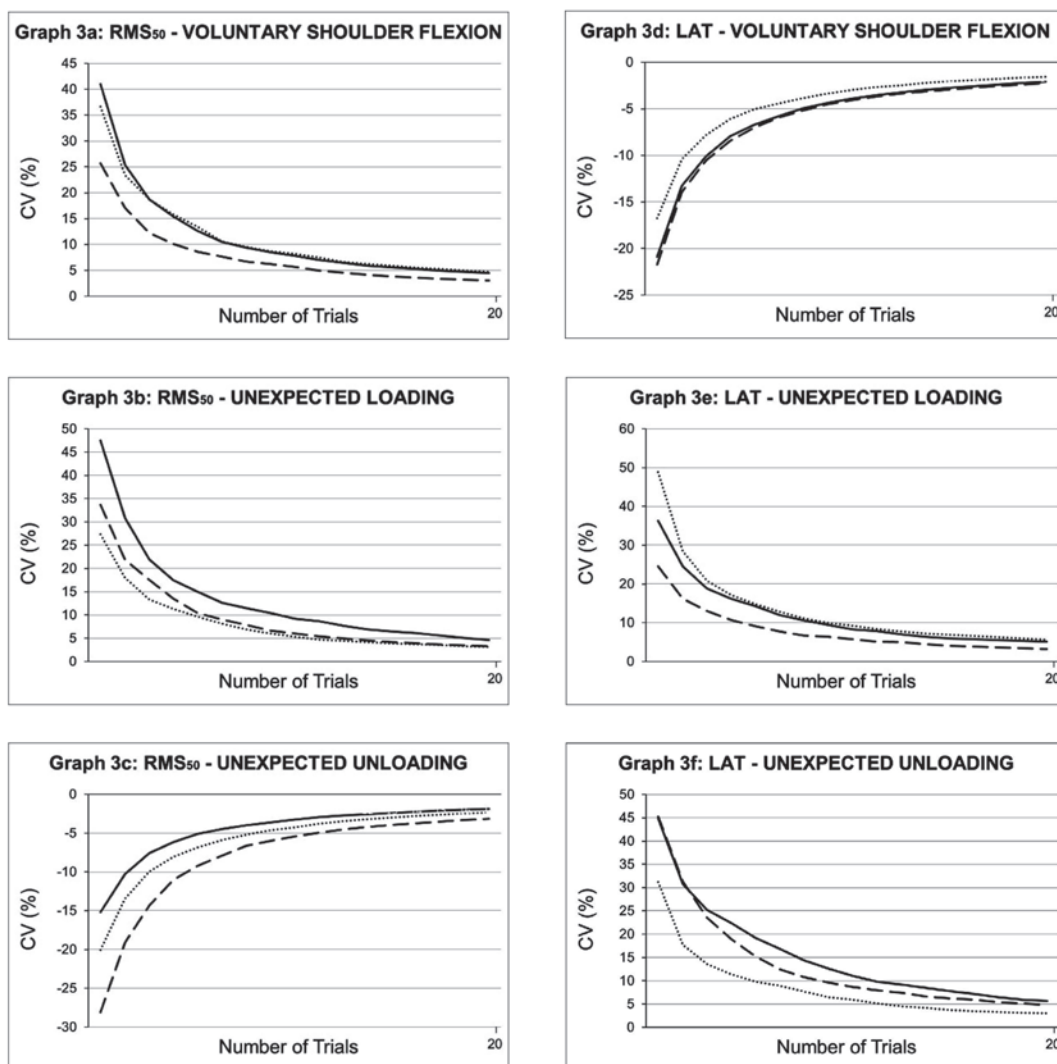

Figure 3. Results for coefficient of variation (CV) for RMS<sub>50</sub> (left) and LAT (right) as a function of the number of consecutive trials. Each graph depicts the data for BF (dotted line), ES (dashed line) and MF (solid line).

## Discussion and conclusions

Regarding the lumbo-pelvic stability, two main automatic neuromuscular phenomena have been studied: (1) anticipatory pre-activation of trunk muscles that precede quick arm movements (Jacobs, Henry, & Nagle, 2009) and (2) activation of trunk muscles as delayed reactions to unexpected mechanical perturbations (Pedersen *idr.*, 2009). Among the latter, the most commonly used mechanical manipulations are sudden loading or unloading of the trunk directly or over the extremities. Several studies reported about the delayed and diminished neuromuscular stability responses of the deep abdominal and back muscles as a result of lower back pain and/or a result of a specific work load. However, a definite clinical relevance of these data and cause-result relationships still remain unclear.

Results of this study showed that the repeatability of the selected time- and amplitude EMG parameters of the selected trunk stability tests depend very much on the number of consecutive trials that are averaged. Additionally, it can be seen that using less than ten or even less than five repetitions of a certain automatic response, can easily lead us to misleading conclusions because of the very low levels of repeatability. Based on the results we could conclude that for RMS<sub>50</sub> an average calculated from ~20 consecutive trials will result in the highest levels of repeatability measures. However, the results of this preliminary study suggests that for the highest levels of repeatability in LAT more than 30 trials should be analysed or another methodological approach should be tested. In this context we are planning to further analyse our signals and to test the repeatability of another method in which the EMG signals of a muscle are first averaged (trial-by-trial) and quantified than after as the averaged “stores”. This results in an averaged signal with subtracted unsystematic parts and pronounced systematic parts of an EMG response.

The above mentioned tests of automatic reactions of LPSM are typical measurements of motor evoked responses. Quantification of responses is normally done through time/amplitude analysis of the EMG responses relative to the onset

of a specific mechanical event (movement initiation). A standard procedure is averaging of an observed parameter's value which is needed because of the trial-to-trial variability of the neuromuscular responses. However, another approach could be averaging of the signal itself and later quantification of this signal, which is a standard way of processing the signals in electro-neurophysiology. This approach results in subtraction of the non-systematic part of the signal while the systematic part (i.e. muscle response) builds up.

However, as we struggle for the methodological optimisations that will give us highest possible repeatability of the observed parameters, we should not forget the informative value of the variability measures. Fluctuation in the neuromuscular responses itself may namely also reveal important aspects of the trunk stability underlying mechanisms. Flexibility of the neural processing is namely an important functional component too, which we would like to address in our future research.

## References

1. Jacobs, J. V., Henry, S. M., & Nagle, K. J. (2009). People with chronic low back pain exhibit decreased variability in the timing of their anticipatory postural adjustments. *Behavioral Neuroscience*, 123(2), 455-458.
2. Kuwashima, A., Aizawa, Y., Nakamura, K., Taniguchi, S., & Watanabe, M. (1997). National survey on accidental low back pain in workplace. *Industrial Health*, 35(2), 187-193.
3. Pedersen, M. T., Randers, M. B., Skotte, J. H., & Krstrup, P. (2009). Recreational soccer can improve the reflex response to sudden trunk loading among untrained women. *Journal of Strength and Conditioning Research / National Strength & Conditioning Association*, 23(9), 2621-2626.
4. Ramprasad, M., Shenoy, D. S., Singh, S. J., Sankara, N., & Joseley, S. R. P. (2010). The magnitude of pre-programmed reaction dysfunction in back pain patients: experimental pilot electromyography study. *Journal of Back and Musculoskeletal Rehabilitation*, 23(2), 77-86.



## RELATIONSHIP BETWEEN ANTHROPOMETRIC DIMENSIONS AND MOTOR ABILITIES IN SOCCER PLAYERS

**Mario Jovanović**

*Faculty of Kinesiology, University of Zagreb, Croatia*

### Abstract

The aim of this study was to investigate the relationship between anthropometric profile and motor abilities in soccer. Study comprised 152 first division soccer players. The anthropometric status was determined by measuring eleven anthropometric variables whereas the motor abilities' were assessed by tests that evaluate flexibility, agility, sprinting and jumping performance. Separate factor analysis was conducted on motor and anthropometric data. Results of this study suggest that longitudinal along with transversal dimensionality of the body are the most important aspects of players anthropometric selection. Motor data show that jumping performance has largest single impact on soccer. Findings of this study indicate that body dimensionality of soccer players has a positive impact on specific soccer flexibility ( $r = .25$ ,  $p = .002$ ), and that the body fat has a negative impact ( $r = -.18$ ,  $p = .026$ ) on jumping performance which is significantly correlated with overall power performance. This paper supports concept of specific morphological optimization that may lead to better performance.

**Key words:** *physical status, anthropometric profile, factor analysis, performance*

### Introduction

It can be presumed that success in a game of soccer is influenced by numerous intrinsic and extrinsic factors such as physiological, biomechanical, tactical and mental ones. Thus sport and medicine scientists have a hard task of collecting data to build the necessary knowledge for successful sporting performance enhancement, as well as for the overall human well-being. Fitness profiles of soccer players provide sufficient information for coaches and fitness experts, but when it comes to verify the actual influence of those parameters on top end result, that level of understanding has limitations.

In recent studies there have been efforts to view the anthropometric profile of soccer players, and give an insight of preferable attributes for each player's position and reference values for soccer as such (Reilly et al., 2000, Sutton et al., 2009, Shephard, 1999). Due to small differences between elite athletes, the selection process is of paramount importance. Norton and Olds (2001) identified this phenomenon as sport-morphological optimization, where body shape and composition are one of the identification tags. Moreover, information on players' physiological demands during match play and training are also needed in order to produce adequate development programs (Strøyer et al., 2004), which in turn increases the performance level of soccer players. The trend of sport-morphological optimization brings us towards to conclusion that anthropometric profile plays a significant role in determining success in a given sport. Confirmation has been found in the paper from Gil et al. (2007) where body size is identified as important criterion in talent selection.

A soccer player's profile demands high level of power performance that includes sprinting and jumping along with agility parameters (Gil et al., 2007, Mujika et al., 2009). Moreover, the specific flexibility of athletes is often unattended, but it presents a tool which can also aid in soccer-specific injury prevention (Soderman et al., 2001).

The intention of this study was to identify and interpret which of the following anthropometric measures has the most eminent impact in soccer players as well as which physical capabilities has the highest influence on soccer. It is hypothesized that the factors obtained would give useful information on motor abilities and anthropometric attributes that are of measurable value to soccer player's performance.

### Methods

One hundred and fifty-two elite, young male soccer players (Mean  $\pm$  SD; age  $19 \pm 0.6$  years, body height  $177.3 \pm 6.3$  cm, body mass  $71.2 \pm 5.7$  kg,  $VO_{2max}$   $60.9 \pm 4.0$  ml $\cdot$ kg $\cdot$ min $^{-1}$ , body fat  $8.7 \pm 2.1$  %, years of training  $9.4 \pm 1.2$  ), all members of Croatian first division, volunteered to participate in this study. In order for field players to be included in this study the following requirements were set: minimal number of games played during the past season was set at 20 (friendly or championship games), minimal attendance of 75% of training sessions in the past season, minimal of 7 years of soccer experience. The goalkeepers were excluded from the study design following their motor and morphological difference from field players (Taskin, 2008). The study was approved by the Ethics Committee of the Faculty of Kinesiology, University

of Zagreb. In order to be included in the investigation, each subject provided a written informed consent in accordance with the Declaration of Helsinki. The subjects were also aware that they could drop out from the study at any time.

## Experimental approach to the problem

All subjects that participated in the study started pre-season period healthy and uninjured. The testing took place three days after the beginning of the pre-season period. Testing took place in the following order: day one - anthropometric measures, flexibility tests and sprint test. Day two started with agility tests and finished with the jump test. Also, before power performance and agility tests the subjects performed a standard warm-up. All sprint tests were performed in a grass sports field and the players wore soccer shoes in order to replicate the playing conditions. Also a 10 minute individual standard warm-up was carried out before flexibility tests.

The anthropometric measure test battery was aimed at measuring skinfold thickness at three sites – triceps, thigh and lower leg (using the John Bull caliper). The averages of three skinfold thickness measurements – triceps (**TS**), lower leg (**CS**) and thigh (**FS**) – were used together with the measures of body height (**BH**), body mass (**BM**), length of the left leg (**LL**), length of the left foot (**LF**), knee breadth (**KB**), forearm girth (**FG**), arm girth (**AG**) and chest girth (**CG**). Anthropometric measurements were obtained following the standardized techniques adopted by the International Society for the Advancement of Kinanthropometry (Marfell-Jones et al., 2006).

The sprints over 5, 10 and 20 meters (**SP5**, **SP10**, and **SP20**) were performed from a standing start and were measured by means of infrared photocells using a telemetric system (RS Sport, Zagreb, Croatia). Time was recorded in hundredths of a second, and the average value from three sprinting attempts was taken into consideration in the final result.

Bosco Jump tests were used to assess muscle power of leg extensor muscles (Kistler, Quattro Jump force platform, Switzerland). The players had two preparatory measurements. The average of three measurements was used to represent the final result in the squat jump (**SJ**), countermovement jump (**CMJ**) and maximal countermovement jump (**MAX**).

To assess the players' agility, three tests were applied (Sporis et al., 2010) – sprint with 90° turns (**S90°**), 9·3·6·3·9m sprint with 180° turns (**S180°**) and 9·3·6·3·9m sprint with backward and forward running (**SBF**). Flexibility was assessed by the sit-and-reach (**SAR**) test, the V-seat reach test (**VT**), the left leg raise (**LRL**) and the right leg raise test (**LRR**) (Sporis et al., 2011).

## Statistical analysis

Means and standard deviations were calculated for all experimental data. To reduce the number of manifest variables, the principal components factor analysis (PCA) was used (Nunnally and Bernstein, 1994). The data was analyzed using a procedure called *factor in the SPSS* (v13.0, SPSS Inc., Chicago, IL) *software package*. The number of significant principal components in the factor pattern matrix extracted by the PCA was determined by the Kaiser-Guttman criterion which retains principal components with eigenvalues greater than 1. The non-orthogonal Promax rotation with Kaiser normalization was used to improve the simple structure of the matrix. As a result of each PCA's communality, the factor loadings for every manifest variable as well as the eigenvalues and the percentages of explained variance were calculated. Relationships were tested by inter-correlations among the extracted principal components. Statistical significance was set at  $p < 0.05$ .

## Results

### Anthropometric data

The three factors, explaining 77% of the variance, were significant according to the Guttman-Kaiser criterion. The longitudinal and the transversal measures of the body (BH, BM, LL, LF, and KB) produced the most prominent groups of loadings on the first factor. The second factor was defined as the factor of body fat, as the loadings grouped around the skinfold measure (TS, CS, and FS) (Table 1). Last factor showed the highest loadings on girths (FG, AG, and CG), thus this factor can be interpreted as the voluminosity factor.

Table 1. The results of the PCA for the anthropometric variables, showing communalities and factor loadings for each manifest variable as well as the eigenvalues, percentage of variance explained, and factor inter-correlation of each Promax-rotated principal component

	Factor loadings			Communalities
	1	2	3	
Leg length	<b>.98</b>	.11	-.27	.87
Body height	<b>.97</b>	.00	-.10	.89
Foot length	<b>.79</b>	-.12	.14	.72
Body mass	<b>.63</b>	.08	.35	.69
Knee breadth	<b>.61</b>	-.06	.24	.51
Lower leg skinfold	.03	<b>.92</b>	-.10	.80
Triceps skinfold	.04	<b>.91</b>	.00	.82
Thigh skinfold	-.06	<b>.90</b>	.12	.89
Forearm girth	-.04	-.12	<b>.93</b>	.80
Arm girth	-.11	.23	<b>.81</b>	.77
Chest girth	.15	-.04	<b>.79</b>	.71
Eigenvalue	4.25	2.69	1.52	
% of variance	38.67	24.48	13.80	
Factor inter-correlation	1	.05	<b>.33**</b>	
		1	<b>.29**</b>	
			1	

\*\* Correlation is significant at the .01 level (2-tailed)

### Motor abilities data

The extracted principal components of motor tests appear to be quite parsimonious. The four obtained factors explained 72.28% of the variance (Table 2.). The loadings on the first factor indicated strong loadings of all three jump tests (SJ, CMJ, and MAX). Flexibility tests (SAR, VT, LRL, and LRR) showed the highest loadings on the second factor. The sprinting tests (SP5, SP10, and SP20) loaded the highest on the third factor and the agility tests (S90°, S180°, and SBF) on the fourth.

Table 2. The results of the PCA for the motor variables, showing communalities and factor loadings for each manifest variable as well as the eigenvalues, percentage of variance explained, and factor inter-correlation of each Promax-rotated principal component

	Factor loadings				Comunalities
	1	2	3	4	
CMJ	<b>.94</b>	.24	-.29	-.37	.89
MAX	<b>.91</b>	.21	-.30	-.25	.84
SJ	<b>.91</b>	.27	-.21	-.35	.83
LRL	.22	<b>.82</b>	-.15	.03	.74
LRR	.22	<b>.80</b>	-.09	-.02	.67
VT	.18	<b>.77</b>	-.11	-.39	.66
SAR	.19	<b>.71</b>	.04	-.41	.61
SP10	-.22	-.09	<b>.91</b>	.26	.83
SP5	-.20	-.12	<b>.87</b>	.16	.77
SP20	-.45	-.07	<b>.82</b>	.43	.75
SBF	-.27	-.13	.22	<b>.84</b>	.71
S180	-.43	-.02	.19	.74	.62
S90	-.11	-.28	.30	<b>.63</b>	.47
Eigenvalue	4.24	2.15	1.64	1.37	
% of variance explained	32.63	16.51	12.64	10.51	
Factor inter-correlation	1	<b>.22**</b>	<b>.29**</b>	<b>.34**</b>	
		1	-.10	<b>-.19*</b>	
			1	<b>.26**</b>	
				1	

\* Correlation is significant at the .05 level (2-tailed); \*\* Correlation is significant at the .01 level (2-tailed)

Table 3. Cross-correlation values of anthropometric and motor factors

		Jump performance	Flexibility	Sprint performance	Agility performance
Body dimensionality	Pearson Correlation	0,09	<b>,254**</b>	0,05	0,00
	Sig. (2-tailed)	0,261	0,002	0,563	0,967
Body fat	Pearson Correlation	<b>-,181*</b>	-0,08	0,01	0,06
	Sig. (2-tailed)	0,026	0,305	0,865	0,477
Body voluminosity	Pearson Correlation	0,06	0,06	-0,16	0,00
	Sig. (2-tailed)	0,446	0,433	0,053	0,954

\* Correlation is significant at the 0.05 level (2-tailed); \*\* Correlation is significant at the 0.01 level (2-tailed)

## Discussion

The main objective of this study was to identify the elements of anthropometrical components and motor capabilities that hypothetically determine the influence on soccer performance. Three components were extracted from the anthropometric data set using the Guttman-Kaiser criterion (Table 1). Results indicate that the body dimensionality (longitudinal and transversal) – explains 38.7% of the variance. Although presented results indicate that this factor is the most significant in anthropometric domain, it has to be also stated that soccer-specific anthropometric selection has high variability. Thus, extreme values of body dimensionality can often be seen in soccer.

Body fat factor has lower variability than body dimensionality in soccer and also accounts for 24.5% of the PCA variance within the sample. Skin folds were very low compared to normative values of young Croatian males (Matkovic et al., 2003). Moreover, lower coefficients of variation were obtained, confirming that low body fat indirectly gained by skin folds measures discriminates elite level soccer players. Research from Reilly et al. (2000) confirms that body composition is a key discriminant for identifying English Premier players matched for age, height and body mass. Body voluminosity that was assessed by girths (FG, AG, and CG) indicates that when it comes to soccer this anthropometric dimension, that we called voluminosity factor, also plays its role in soccer (13.8% of the explained variance). Sutton et al. (2009) also support the hypothesis that the anthropometric profile of soccer players is an important predictor of soccer player talent. Furthermore, evidence is obtained in the study conducted by Le Gall et al. (2010) where taller and heavier players discriminated the elite players from the ones that did not proceed to higher level of achievement. The major purpose of selection process is to identify characteristics common to specific competition level. The practical usefulness of these findings can relate to identifying soccer anthropometric models that can lead to positive changes in developing future prospects.

The factor analysis of the data regarding the motor abilities of players produced a relatively parsimonious situation. As hypothesized, four principal components were extracted from thirteen manifest variables (Table 2). This model explained 72.3% of the variance, thus leaving 27.7% of motor domain unexplained. Findings of this study support the hypothesis that jump performance of soccer players is the most important single motor factor. Although findings were surprising, explanation lies in correlation between motor factors. It can be seen (Table 2.) that first factor has highest inter-correlations with other three factors. Reasons for such findings are that this trait of soccer players are interconnected with many abilities that requires, to some degree, jump-type power performance. Soccer is random, intermittent, dynamic type sport that has numerous explosive actions, so it is logical to demand from players such physical abilities that manifest power performing. Similar evidence can be found in study where authors found that jumping performance has been correlated with other abilities such as sprinting performance (Cronin and Hansen, 2005). Also, study in which leg extensor strength qualities have been associated as agility predictors (Markovic et al., 2007, Young et al., 2002), but it has to be noticed, as was done in those studies, that the correlation is not strong. Following previously said it is possible to say that the motor abilities investigated in this study are significant factors of success in soccer.

The participants were a relatively homogeneous group of athletes with similar physical profile and age. Their body fat percentage was low thus reducing the possible effect of body composition on test performance (Wilmore, 1983). This fact emphasizes the importance of weak but statistically significant correlation result ( $r = .25, p = .002$ ) between body dimensionality and soccer players' flexibility. The connection indicates that flexibility is better in terms of specific range of motion if players are taller. The specific soccer flexibility that involves adductor muscles and hamstrings can be one of the solutions in preventing soccer players' specific injuries (Henderson et al., 2010, Shrier, 2004). Therefore, this segment of soccer needs more attention to help soccer players in their attempt to stay fit for games throughout the entire season.

Furthermore, author found significant negative influence ( $r = -.18, p = .026$ ) of fat tissue on jumping performance. This finding leads to a logical conclusion of negative influence in jumping actions that significantly involve lean muscle mass and where body fat, or sometimes called "dead weight", has undesirable impact. Thus, emphasizing the importance of optimal fat tissue that field players need to maintain in order to perform at their best. Additionally, the practical findings

of this study were also confirmed by Arnason et al. (2004), they suggested that coaches and medical teams should pay more attention to jump and power training as a preventive measure that can increase team success.

This study confirmed important markers of soccer players' anthropometric and motor status. Although inter-correlation results are not practically significant they give important insight, which leads toward conclusion that jump power performance is important factor that manifests into sprint and agility performance of soccer players. Soccer players' selection trend points toward favoring body dimensionality and also adjusting anthropometric characteristics, such as low body fat, that could give improvements in some abilities without interfering effects.

## References

1. Arnason, A., Sigurdsson, S. B., Gudmundsson, A., Holme, I., Engebretsen, L. & Bahr, R. (2004). Physical fitness, injuries, and team performance in soccer. *Medicine and Science in Sports and Exercise*, 36, 278-85.
2. Cronin, J. & Hansen, K. (2005). Strength and power predictors of sports speed. *Journal of Strength and Conditioning Research*, 19, 349-57.
3. Gil, S., Gil, J., Ruiz, F., Irazusta, A. & Irazusta, J. (2007). Physiological and anthropometric characteristics of young soccer players according to their playing position: relevance for the selection process. *Journal of Strength and Conditioning Research*, 21, 438-45.
4. Henderson, G., Barnes, C. & Portas, M. (2010). Factors associated with increased propensity for hamstring injury in English Premier League soccer players. *Journal of Science and Medicine in Sport*, 13, 397-402.
5. Le Gall, F., Carling, C., Williams, M. & Reilly, T. (2010). Anthropometric and fitness characteristics of international, professional and amateur male graduate soccer players from an elite youth academy. *Journal of Science and Medicine in Sport*, 13, 90-95.
6. Marfell-Jones, M., Olds, T., Stewart, A. & Carter, L. (2006). *International standards for anthropometric assessment*, Potchefstroom, South Africa, ISAK.
7. Markovic, G., Sekulic, D. & Markovic, M. (2007). Is agility related to strength qualities? - Analysis in latent space. *Collegium Antropologicum*, 31, 787-793.
8. Matkovic, B. R., Misigoj-Durakovic, M., Matkovic, B., Jankovic, S., Ruzic, L., Leko, G. & Kondric, M. (2003). Morphological Differences of Elite Croatian Soccer Players According to the Team Position. *Collegium Antropologicum*, 27, 167-174.
9. Mujika, I., Santisteban, J. & Castagna, C. (2009). In-season effect of short-term sprint and power training programs on elite junior soccer players. *Journal of Strength and Conditioning Research*, 23, 2581-2587.
10. Norton, K. & Olds, T. (2001). Morphological evolution of athletes over the 20th century: causes and consequences. *Sports Medicine*, 31, 763-83.
11. Nunnally, J. C. & Bernstein, I. H. (1994). *Psychometric theory*, New York, McGraw-Hill.
12. Reilly, T., Bangsbo, J. & Franks, A. (2000). Anthropometric and physiological predispositions for elite soccer. *Journal of Sports Sciences*, 18, 669-683.
13. Shephard, R. (1999). Biology and medicine of soccer: An update. *Journal of Sports Sciences*, 17, 757-786.
14. Shrier, I. (2004). Does stretching improve performance? A systematic and critical review of the literature. *Clinical Journal of Sport Medicine*, 14, 267-273.
15. Soderman, K., Alfredson, H., Pietila, T. & Werner, S. (2001). Risk factors for leg injuries in female soccer players: a prospective investigation during one out-door season. *Knee Surgery Sports Traumatology Arthroscopy*, 9, 313-321.
16. Sporis, G., Jukic, I., Milanovic, L. & Vucetic, V. (2010). Reliability and Factorial Validity of Agility Tests for Soccer Players. *Journal of Strength and Conditioning Research*, 24, 679-686.
17. Sporis, G., Vucetic, V., Jovanovic, M., Jukic, I. & Omrcen, D. (2011). Reliability and Factorial Validity of Flexibility Tests for Soccer Players: Method Paper. *Journal of Strength and Conditioning Research*, 25, 1168-1176.
18. Strøyer, J., Hansen, L. & Klausen, K. (2004). Physiological profile and activity pattern of young soccer players during match play. *Medicine and Science in Sports and Exercise*, 36, 168-74.
19. Sutton, L., Scott, M., Wallace, J. & Reilly, T. (2009). Body composition of English Premier League soccer players: influence of playing position, international status, and ethnicity. *Journal of Sports Sciences*, 27, 1019-1026.
20. Taskin, H. (2008). Evaluating sprinting ability, density of acceleration, and speed dribbling ability of professional soccer players with respect to their positions. *Journal of Strength and Conditioning Research*, 22, 1481-6.
21. Wilmore, J. H. (1983). Body composition in sport and exercise: directions for future research. *Medicine and Science in Sports and Exercise*, 15, 21-31.
22. Young, W., James, R. & Montgomery, I. (2002). Is muscle power related to running speed with changes of direction? *Journal of Sports Medicine and Physical Fitness*, 42, 282-8.

## COMPARISON VENTILATION THRESHOLD AND HEART RATE DEFLECTION POINT IN FAST AND STANDARD TREADMILL TEST PROTOCOL

Goran Sporiš, Vlatko Vučetić and Davor Šentija

Faculty of Kinesiology, University of Zagreb, Croatia

### Abstract

The purpose of the study was to compare two methods for determination anaerobic threshold from two different treadmill protocols. Forty-eight Croatian runners of national rank participated in the study (10 sprinters, 15 400m runners, 10 middle distance runners and 13 long distance runners) with a mean age of  $21.7 \pm 5.1$  years performed two graded maximal exercise test on a treadmill, *Standard ramp treadmill test protocol* ( $T_{SR}$  - speed increments of 1 km/h every 30 seconds) and *Fast ramp treadmill test protocol* ( $T_{FR}$  - speed increments of 1 km/h every 60 seconds) to determine and compare parameters at peak values and at  $HR_{DP}$  and VT. There were no significant differences between peak values at mean  $VO_2$  (4.48 vs 4.44 L/min), weight related  $VO_2$  ( $RVO_2$  - 62.52 vs 62.04 mL/kg/min), pulmonary ventilation (VE - 163.09 vs 161.29 L/min) and heart rate (192.35 vs 194.44 beats/min), that were measured in both protocol ( $T_{FR}$  and  $T_{SR}$ ). Significant differences were found between running speed at anaerobic thresholds ( $v_{AnT}$ ) achieved in two different protocols, independent which methods for determination AnT were used ( $v_{AnT}$  - 16.01 vs 14.94 km/h in VT methods and  $v_{AnT}$  - 16.46 vs 14.95 km/h in  $HR_{DP}$  methods, respectively). Linear regression analysis revealed a correlation of 0.86 ( $p < 0.01$ ) in  $T_{FR}$  and 0.77 in  $T_{SR}$  ( $p < 0.01$ ) protocols between  $RVO_2$  measured at VT and  $RVO_2$  measured at  $HR_{DP}$ , so the present study indicates that the point of deflection from linearity of heart rate ( $HR_{DP}$ ) may be an accurate predictor of VT for  $VO_2$  and HR in runners with predominantly aerobic or anaerobic energy contribution independently of used protocol. In the same time, we conclude that  $RQ_{max}$ , achieved running speed and running speed at anaerobic thresholds are protocol dependent values.

**Key words:** ventilation anaerobic threshold, heart rate deflection point, treadmill test, ramp exercise protocol, exercise capacity, runners

### Introduction

All athletes can benefit from the knowledge of the assessment of the ‘anaerobic threshold’ (AnT) expressed as either lactate threshold (LD) or ventilatory threshold (VT). The VT, or ventilation breakpoint, is the point when pulmonary ventilation begins to increase in a disproportionate manner with respect to the increase in  $VO_2$  during incremental exercise. Whenever exercise intensity increases, oxygen delivery to the muscles no longer supports the oxygen requirements of oxidation, and to compensate, more energy is derived from anaerobic glycolysis. This increases lactic acid production and accumulation. Therefore, the onset of anaerobic metabolism (the anaerobic threshold) was determined invasively from the point at which blood lactate concentration begins to accumulate above resting level during exercise of incremental intensity (Wasserman et al., 1973).

In sports science and clinical exercise laboratories incremental exercise tests, popularized as the ‘Conconi test’, are performed to assess the heart rate deflection point ( $HR_{DP}$ ).  $HR_{DP}$ , as a marker of exercise intensity related to the AnT, is used to evaluate aerobic endurance, prescribe and monitor exercise intensity of healthy subjects and patients (Conconi et al., 1982; Droghetti et al., 1985; Cellini et al., 1986; Droghetti, 1986; Ballarin et al., 1989; Petit et al., 1997; Pokan et al., 1998). It is performed either as a field or as a laboratory test, with numerous modifications for different exercise modalities (field running, treadmill running, cycling, swimming, etc.), and it is based on the assumption that during progressive incremental exercise a deflection in the linear heart rate/work relationship occurs; heart rate (HR) increases linearly with running speed up to the so-called deflection heart rate ( $HR_{DP}$ ) and corresponding speed ( $v_{DP}$ ) (Fig.1). Conconi et al. (1982, 1996) and other researchers (Bunc & Heller, 1992; Hofmann et al., 1994a; Hofmann et al., 1994b; Bunce et al., 1995) report a high correlation between  $v_{DP}$  and the lactate and ventilatory anaerobic thresholds, and recommend its use to evaluate endurance capacity and to assess training programmes.

Measurement of the ventilatory threshold or lactate threshold simply by assessing heart rate during graded exercise has considerable importance in the way that sophisticated laboratory instruments are not necessary. Although the heart rate deflection and ventilation threshold may be assessed by different type of protocol (Weston et al., 2002), to our knowledge, relationship between  $HR_{DP}$  and related ventilation and metabolic parameters measured with two treadmill protocols have not been investigated yet.

The aim of this study was to investigate the relationship between two methods for determination anaerobic thresholds, one based on the ventilation and metabolic parameters and second one based on the heart rate parameters, measured in two incremental treadmill protocols ( $T_{FR}$ , speed increase 1 km/h every 30 s, HR increase >8 bpm each minute;  $T_{SR}$ , speed increase 1 km/h every 60 s, HR increase <8 bpm each minute) in trained runners.

## Methods

**Subjects.** Forty-eight Croatian runners of national rank participated in the study (10 sprinters, 15 400m runners, 10 middle distance runners and 13 long distance runners). The measurement procedures and potential risks were verbally explained to each subject prior to obtaining a written informed consent according to the Helsinki Declaration. The study was approved by the Ethics Committee of the Faculty of Kinesiology, University of Zagreb. Subjects were admitted in the study if they had a minimum training age of 3yr, engaged in strenuous training at least 10 h per week and were currently active in competition. Subject characteristics are presented in Table 1.

Table 1. Physical characteristics of the subjects

	Mean $\pm$ SD
Age (years)	21.7 $\pm$ 5.1
Weight (kg)	71.9 $\pm$ 6.9
Height (cm)	181.1 $\pm$ 5.7

Values are means  $\pm$  SD – standard deviation

**Procedures.** Laboratory assessments were undertaken at the Faculty of Kinesiology, University of Zagreb, Croatia. Each athlete was measured by two experienced anthropometrists prior to the measurement of  $VO_{2max}$ . Body mass was assessed to the nearest 0.1 kg using beam balance scale with the athletes wearing minimal clothing. Body height was assessed to the nearest 0.1 cm using portable stadiometer. The stadiometer and scale were calibrated periodically during the study.

**Experimental protocols.** Subjects were asked to refrain from strenuous exercise for 24 h prior to each exercise test. Each runner had previous experience of treadmill running and testing. After warm-up and stretching, based upon the subject's habits, one of incremental protocols on a calibrated treadmill (Run Race 900, Tehnogym, Italy) with 1.5% inclination was applied. The order of ramp protocols was randomized and tests were separated by at least 3 days. Each subject had previous experience of treadmill running and testing.

**Standard ramp treadmill test protocol ( $T_{SR}$ ).** The starting speed was 3 km/h, with speed increments of 1 km/h every 30 seconds. The subjects walked the first three steps (up to 7 km/h), and continued running from 8 km/h, until volitional exhaustion.

**Fast ramp treadmill test protocol ( $T_{FR}$ ).** All subjects performed the other incremental treadmill test using the same procedures as in  $T_{SR}$ , with the exception of a faster speed acceleration - the running speed was increased 1 km/h every 30 seconds. During recovery after each test protocol, the subjects walked at 5 km/h for 5 minutes. The last half or full stage the subject could sustain (for either 30 or 60 s) was defined as the subject's maximal speed.

**Expired gas analysis.** Expired gas was sampled continuously and  $O_2$  and  $CO_2$  concentration in expired gas were determined using stable and fast Zirconium Oxygen and NDIR Carbon Dioxide analyzers (breath-by-breath gas exchange system Quark b<sup>2</sup>, COSMED, Italy) which were calibrated prior to and following each test using precision reference gases. The system was calibrated before each test using gases of known concentrations. Heart rate (HR) was collected continuously during the tests using telemetric heart rate monitor (Polar Electro, Kempele, Finland), and stored in PC memory. The testing was performed in morning hours (between 9 a.m. and 11 a.m.) in thermo-neutral conditions. Expired airflow was measured with digital turbine flow meter (COSMED, Italy), which was calibrated prior to and following each test using a 3 l syringe at flow rate and volumes in the expected physiological range. Temperature and humidity of expired gas were measured using a rapidly-responding sensor (Quark b<sup>2</sup>, COSMED, Italy).

**The variables of the test are:**  $VO_{2max}$ , maximal oxygen uptake (mL/kg/min and L/min);  $VO_{2VT}$ , oxygen uptake at the anaerobic ventilation threshold (mL/kg/min and L/min);  $\%VO_2$ , % of maximal oxygen uptake at the anaerobic ventilation threshold (%);  $HR_{max}$ , maximal heart rate achieved in the test (beat/min);  $HR_{VT}$ , heart rate at the anaerobic ventilation threshold (beat/min);  $HR_{DP}$ , heart rate at the deflection point (beat/min);  $HR_{an}$ , anaerobic heart rate range (beat/min) =  $HR_{max} - HR_{DP}$ ;  $v_{max}$ , maximal running speed (km/h);  $v_{VT}$ , running speed at the anaerobic ventilation threshold (km/h);  $v_{DP}$ , running speed at the heart rate deflection point (km/h);  $v_{an}$ , anaerobic speed range (km/h) =  $v_{max} - v_{DP}$ . \*at subscript, index SR was add for values from TSR protocol, and FR for values from TFR protocol.

## Statistical analysis

The collected data were stored and analyzed for windows statistical software (Statistica for Windows 7.0). The significance of differences between variables of  $T_{SR}$  and  $T_{FR}$  and two methods for determination of anaerobic threshold (VT and DP) were determined by the two-sided paired Student's *t*-test. The strength of the relationships between variables of the two tests, were analyzed with the Pearson product moment correlation. The level of significance was  $p < 0.05$ .

Table 2. Peak cardiopulmonary response, *t*-test (*t*) and correlation coefficients (*r*) in two different treadmill protocol of the subjects ( $n=48$ )

Variables / Treadmill protokol	$T_{FR}$	$T_{SR}$	$t^{\Omega}$	<i>r</i>
$VO_{2max}$ (L/min)	4.48 ± 0.43	4.44 ± 0.45	ns	0.91†
$VO_{2max}$ (mL/kg/min)	62.52 ± 6.17	62.04 ± 6.03	ns	0.94†
$HR_{max}$ (beat/min)	192.35 ± 8.46	194.44 ± 8.66	ns	0.84†
$VE_{max}$ (L/min)	163.09 ± 18.69	161.29 ± 19.92	ns	0.86†
$RQ_{max}$	1.25 ± 0.08	1.18 ± 0.04	&	0.56†
$v_{max}$	22.15 ± 1.98	19.99 ± 2.05	&	0.94†

Values are means ± SD – standard deviation;  $T_{FR}$  – fast ramp protocol;  $T_{SR}$  – standard ramp protocol; &-significant  $T_{FR}:T_{SR}$   $p < 0.01$ ;  $\Omega$  – tailed, paired t-test, † $p < 0.01$ , ns – not significant

Table 3. Cardiopulmonary response, *t*-test (*t*) and correlation coefficients (*r*) at VT and HRDP in two different treadmill protocol of the subjects ( $n=48$ )

Variables / protokol	Ventilation threshold		HR deflection point		$t^{\Omega}$	$r_1$	$r_2$
	TFR	TSR	TFR	TSR			
$VO_2$ (l/min)	3.88 ± 0.36	3.83 ± 0.42	3.91 ± 0.43	3.81 ± 0.40	ns	0.80†	0.8†
$RVO_2$ (ml/kg/min)	54.2 ± 5.7	54.49 ± 5.82	54.23 ± 5.53	53.15 ± 5.68	ns	0.84†	0.8†
% $VO_2$ (%)	86.7 ± 3.4	86.18 ± 3.51	86.87 ± 5.32	85.89 ± 5.60	ns	0.33π	0.5†
HR (bpm)	174.8 ± 9.9	176.23 ± 10.15	177.81 ± 9.16	177.52 ± 9.88	ns	0.78†	0.8†
HRan (bpm)	17.6 ± 4.7	17.98 ± 4.61	14.54 ± 3.63	16.96 ± 3.96	* $\alpha$	0.47†	0.4†
%HR (%)	90.8 ± 2.5	90.62 ± 2.71	92.43 ± 1.93	91.32 ± 2.13	*	0.47†	0.4†
<i>v</i> (km/h)	16.0 ± 2.2	14.94 ± 2.22	16.46 ± 1.92	14.95 ± 1.99	&	0.88†	0.8†
van (km/h)	6.1 ± 1.2	5.04 ± 0.80	5.69 ± 0.98	5.04 ± 0.91	&	0.51†	0.5†

Values are means ± SD – standard deviation;  $T_{FR}$  – fast ramp protocol;  $T_{SR}$  – standard ramp protocol; ns – not significant; \* – significant VT:DP in  $T_{FR}$   $p < 0.01$ ; &-significant  $T_{FR}:T_{SR}$  in both methods  $p < 0.01$ ;  $\alpha$  – significant  $T_{FR}:T_{SR}$  in DP method  $p < 0.01$ ;  $r_1$  – correlation coefficients for the  $T_{SR}$  and  $T_{FR}$  test at the VT;  $r_2$  – correlation coefficients for the  $T_{SR}$  and  $T_{FR}$  test at the  $HR_{DP}$ ;  $\Omega$  – tailed, paired t-test, † $p < 0.01$ ; \* $p < 0.05$

## Results

The values of the variables for all subjects are reported in Table 2. The  $HR_{DP}$  values was about 177 bpm and achieved at 91.3% and 92.4% of  $HR_{max}$ , during  $HR_{VT}$  was in range of 174.8 to 176.2 bpm and achieved at 90.6% and 90.8% of maximal heart rate in  $T_{SR}$  and  $T_{FR}$ , respectively, without any significant differences. There was no evidence of any significant differences in metabolic parameter such a  $VO_{2max}$ ,  $VO_{2VT}$ ,  $VO_{2DP}$  or  $VE_{max}$  measured in  $T_{FR}$  and  $T_{SR}$ . Significant bigger values in  $T_{FR}$  than in  $T_{SR}$ , were found in all speed variables ( $v_{Anp}$ ,  $v_{an}$  and  $v_{max}$ ), independently of methods for determination anaerobic thresholds (DP and VT), and in  $RQ_{max}$  (Table 2). There was no evidence of any significant bias or lack of agreement for  $HR_{DP}$  between the two tests. In contrast, the 95% confidence interval for  $v_{DP}$  shows completely positive ( $1.51 \pm 0.92$  km/h) population mean bias, indicating the mean  $v_{DP}$  in the  $T_{FR}$  test were likely to be between 0.60 km/h to 2.43 km/h higher than the corresponding  $v_{DP}$  determined in the standard test ( $T_{SR}$ ).



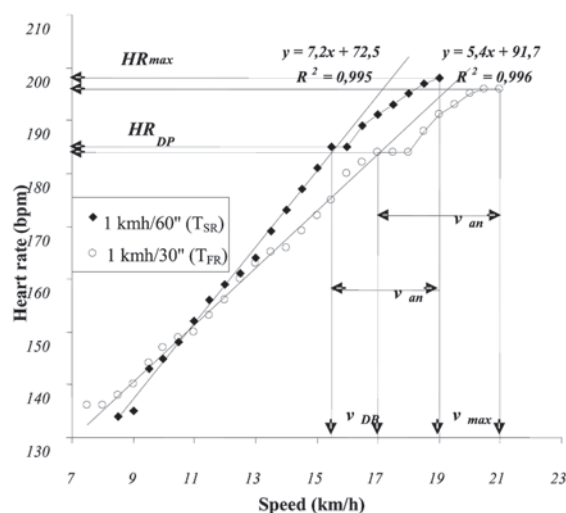

Fig. 1. HR/speed relationship and the variables of the standard ( $T_{SR}$ ) and fast ( $T_{FR}$ ) test for one subject. Abbreviations:  $HR_{DP}$ : heart rate deflection point,  $HR_{max}$ : maximal heart rate,  $v_{DP}$ : running speed at  $HR_{DP}$ ,  $v_{max}$ : maximal running speed,  $v_{an}$ : speed range from  $v_{anT}$  to  $v_{max}$ .

## Discussion and conclusion

From a practical point of view,  $HR_{DP}$  is an attractive method to assess LT or VT because it is noninvasive, methodology is relatively simple to implement and can be conducted in field and laboratory settings. The continuous and uniform increase in exercise intensity in  $T_{FR}$  and  $T_{SR}$  is preserved up to the maximal running speed, enabling also an estimation of the anaerobic endurance. The range of running speed from deflection point to maximal velocity ( $v_{an}$ ) depends primarily on anaerobic capacity of the subjects, and the short duration of  $T_{FR}$  increases the significance of the anaerobic capacity for success in the test. In the only published study with fast power output acceleration (HR increments more than 10 bpm each minute) in elite cyclists, Conconi et al. (1996) report that the fast protocol moves the HR/v regression line to the right, with significantly higher values of  $HR_{DP}$ ,  $v_{DP}$ ,  $HR_{max}$  and  $v_{max}$ . The mean  $HR_{DP}$  achieved in  $T_{SR}$  and  $T_{FR}$  in this study, however, have the same value and are highly correlated.

$HR_{VT}$  ( $174.8 \pm 9.9$  bpm in  $T_{FR}$  and  $176.5 \pm 9.9$  bpm in  $T_{SR}$ ) was highly related to  $HR_{DP}$  ( $177.8 \pm 9.2$  bpm in  $T_{FR}$  and  $177.5 \pm 9.8$  bpm in  $T_{SR}$ ) in both test protocols ( $r = 0.88$  in  $T_{FR}$  and  $r = 0.83$  in  $T_{SR}$ ;  $p < 0.01$ ).  $HR_{DP}$  was greater than  $HR_{VT}$  by 3.0 bpm in  $T_{FR}$  and by 1.0 bpm in  $T_{SR}$ , but these values were not significantly different ( $p > 0.05$ ). In the same time, the high correlation were assess for  $HR_{max}$  ( $r = 0.84$ ,  $p < 0.01$ ),  $HR_{DP}$  ( $r = 0.88$ ,  $p < 0.01$ ) and for  $HR_{VT}$  ( $r = 0.79$ ,  $p < 0.01$ ) obtained in the two tests. Brisswalter and Legros (1994) reported daily heart rate variations of 1-3% (1-5 bpm) in trained runners, for continuous treadmill running at 70%  $VO_{2max}$  ( $r \geq 0.85$ ). The high correlation for  $HR_{DP}$  between  $T_{SR}$  and  $T_{FR}$  in this study, even higher than in some reliability studies, may be related to the fitness status of subjects tested, as fitter individuals produce more reproducible results (Grant et al., 2002).

The present study demonstrated that oxygen uptake values at  $HR_{DP}$  and VT in both test protocol were significantly related ( $r = 0.86$  for  $T_{SR}$  and  $r = 0.77$  for  $T_{FR}$ ), without any significant differences (Table 3). This finding is in line with other  $HR_{DP}$  studies. The literature reports correlations between  $VO_{2HRDP}$  and  $VO_{2VT}$  ranging from 0.71-0.95 (Bunc & Heller, 1992; Bunc et al., 1995). In our study the  $VO_2$  values in  $T_{FR}$  at  $HR_{DP}$  and VT were 54.2 mL/kg/min, during the  $VO_2$  values in  $T_{SR}$  at  $HR_{DP}$  was 53.2 mL/kg/min and 53.6 mL/kg/min at VT. All  $VO_2$  values at  $HR_{DP}$  or VT in both protocols were achieved at about 86% (range 85.9-86.9%) of  $VO_{2max}$ , without any significant differences (Table 3).

The results of this investigation show that, in trained runners, there is good agreement for  $HR_{DP}$  between incremental treadmill tests with fast (1 km/h every 30s, HR increase  $>8$  bpm each minute) and slow (1 km/h every 60s, HR increase  $<8$  bpm each minute) speed acceleration. In contrast, there was a significant effect of ramp slope on all the other variables of the test. The running speed at  $HR_{DP}$  was on average 9% higher during fast ramp compared to the slow ramp protocol, and caution is warranted regarding practical applicability of  $v_{DP}$ , as it is protocol dependent, and there may be considerable random error for some individual measurements. From a practical viewpoint, caution should be exercised when standard and fast protocols are used interchangeably, as there may be considerable random error for some individual measurements. It is a major challenge of future researchers to examine the sources of this rightward drift in threshold intensity, and the underlying physiological mechanisms. Recent work by Lepretre et al. (2005) shows that the occurrence of  $HR_{DP}$ , when present, may be related by the attainment of maximal stroke volume.

## References

1. Ballarin, E., Borsetto, C., Cellini, M., Patracchini, M., Vitiello, P., Ziglio, P., & Conconi, F. (1989). Adaptation of the "Conconi test" to children and adolescents. *International Journal of Sports Medicine*, 10, 334-8.
2. Brisswalter, J., & Legros, P. (1994). Daily stability in energy cost of running, respiratory parameters and stride rate among well-trained middle distance runners. *International Journal of Sports Medicine*, 15, 238-4.
3. Bunc, V., Hofmann, P., Leitner, H., & Gaisl, G. (1995). Verification of the heart rate threshold. *European Journal of Applied Physiology*, 70, 263-9.
4. Bunc, V.J., & Heller, J. (1992). Comparison of two methods of noninvasive anaerobic threshold determination in middle-aged men. *Sports Medicine, Training and Rehabilitation*, 3, 87-94.
5. Cellini, M., Vitiello, P., Nagliati, A., Ziglio, P.G., Martinelli, S., Ballarin, E., & Conconi, F. (1986). Noninvasive determination of the anaerobic threshold in swimming. *International Journal of Sports Medicine*, 7, 347-51.
6. Conconi, F., Ferrar, i M., Ziglio, P.G., Droghetti, P., & Codeca, L. (1982). Determination of the anaerobic threshold by a field test in runners. *Journal of Applied Physiology*, 52, 869-873.
7. Conconi, F., Grazzi, G., Casoni, I., Guglielmini, C., Borsetto, C., Ballarin, E., Mazzoni, G., Patracchini, M., & Manfredini, F. (1996). The Conconi test, methodology after 12 years of application. *International Journal of Sports Medicine*, 17, 509-19.
8. Droghetti, P., Borsetto, C., Casoni, I., Cellini, M., Ferrari, M., & Paolini, A.R. (1985). Noninvasive determination of the anaerobic threshold in canoeing, cross-country skiing, cycling, roller and ice-skating, rowing, and walking. *European Journal of Applied Physiology*, 53, 299-303.
9. Droghetti, P. (1986). Determination of the anaerobic threshold on a rowing ergometer by the relationship between work output and heart rate. *Scandinavian Journal of Medicine and Science in Sports*, 8, 59-62.
10. Grant, S., McMillan, K., Newell, J., Wood, L., Keatley, S., & Simpson, D., et al. (2002). Reproducibility of the blood lactate threshold, 4 mmol.l(-1) marker, heart rate and ratings of perceived exertion during incremental treadmill exercise in humans. *European Journal of Applied Physiology*, 87, 159-66.
11. Hoffman, P., Bunc, V., Leitner, H., Pokan, R., & Gaisl, G. (1994a). Heart rate threshold related to lactate turn point and steady-state exercise on a cycle ergometer. *European Journal of Applied Physiology*, 69, 132-9.
12. Hofmann, P., Pokan, R., Preidler, K., Leitner, H., Szolar, D., Eber, B., & Schaberg, G. (1994b). Relationship between heart rate threshold, lactate turn point and myocardial function. *International Journal of Sports Medicine*, 15, 232-7.
13. Lepretre, P.M., Foster, C., Koralsztein, J.P., & Billat, V.L. (2005). Heart rate deflection point as a strategy to defend stroke volume during incremental exercise. *Journal of Applied Physiology*, 98, 1660-5.
14. Petit, M.A., Nelson, C.M., & Rhodes, E.C. (1997). Comparison of a mathematical model to predict 10km performance from the Conconi test and ventilatory threshold. *Canadian Journal of Applied Physiology*, 22, 562-72.
15. Pokan, R., Hofmann, P., Von Duvillard, S.P., Beaufort, F., Smekal, G., Gasser, R., Klein, W., Eber, B., Bachl, N., & Schmid, P. (1998). The heart rate performance curve and left ventricular function during exercise in patients after myocardial infarction. *Medicine and Science in Sports and Exercise*, 30, 1475-80.
16. Wassermann, K., Whipp, B.J., Koyal, S.N., & Beaver, W.L. (1973). Anaerobic threshold and respiratory exchange during exercise. *Journal of Applied Physiology*, 35, 236-243.
17. Weston, S.B., Gray, A.B., Schneider, D.A., & Gass, G.C. (2002). Effect of ramp slope on ventilation thresholds and VO<sub>2</sub>peak in male cyclists. *International Journal of Sports Medicine*, 23, 22-7.

## THE INFLUENCE OF CHANGE IN KINESIOMETRIC CONDITIONS ON THE RESULTS OF HAND PLATE TAPING TEST WITH PRESCHOOL CHILDREN

Zvonimir Tomac<sup>1</sup>, Željko Hraski<sup>2</sup> and Goran Sporiš<sup>2</sup>

<sup>1</sup>Faculty of Teacher Education, University of Osijek, Croatia

<sup>2</sup>Faculty of Kinesiology, University of Zagreb, Croatia

### Abstract

The aim of the research was to establish whether the results of speed test of single limb repeated movement are improved after familiarization with the test protocol. The sample consisted of 50 preschool children (27 in the experimental and 23 in the control group) whose mean age was 71,5 months. The results indicated that when compared to the control group, the experimental group significantly improved their results in speed test “hand plate tapping” after 3 treatments with 5 test trials (25,37/21,58 taps, ANOVA test;  $F=20,69$ ,  $p=0,00$ ). The results were also better in comparison to the initial test (25,37/15,58 taps, t-test;  $-15,58$ ,  $p=0,00$ ). The research determined that if children are given adequate instructions and test trials with sufficient feedback on their test performance, then they achieve statistically significant better results in speed tests.

**Key words:** preschool children, assessment of motor skills, familiarization

### Introduction

Motion has a significant role in the process of growth and development, and the need to move is especially emphasized at preschool age when children are in motion most of the day. This is the period of great changes in anthropological status, and a child learns new motor skills which are essential for life. Exactly at this age we can influence the development of motor skills. However, in order to adequately monitor motor development and to create a well-planned kinesiology curriculum, it is necessary to be familiar with the current child's motor status. In order to efficiently evaluate motor status, it is important to have appropriate measuring instruments and measuring protocols. Burton and Miller (1998) state five most important reasons for measuring: identification and categorization, planning treatments or activities; evaluating changes over time; giving feedback to performers and predicting progress. The question is whether one can be familiar with such status if good assessment protocols are not determined. When studying children's motor abilities, researchers apply the same protocols which are used for measuring adults' motor skills and they usually encounter problems and suggest new methods and standards as well as new tests which could better assess children's motor status. So Rajtmajer et al. (1989) proposed a group of 46 measuring instruments suitable for evaluation of motor skills of four- to seven- year old children. Živčić and Hraski (1995) suggested standards for monitoring motor efficacy of preschool children. They determined that this was a useful diagnostic system in diagnosing flaws of children's psychomotor status, monitoring motor development and evaluating sports programs effects. The same authors (1996) on a sample of 151 children standardized 6 tests for motor skill assessment – agility, flexibility and some forms of strength also proposing standards for each test. Pišot and Planinšec (2005) conducted a research on children's (age 6,5) motor abilities using 28 test for motor skill assessment and 21 tests for anthropometric characteristics assessment. Videmšek (1996) studied the motor structure of three-year olds using 23 motor tests, which were supposed to cover 7 hypothetical factors of motor dimension. Bala (1999) researched the possibilities of direct application of tests for adults in testing children. He proposed necessary modifications of tests and measuring techniques and recommended measuring each test with more items since children have to create a situation for understanding a task and warm up for measuring. The author concluded that children should be given adequate instructions, trials for each test and their motivation has to be increased.

### The aim of the paper

The main aim of the paper is to determine the role of motor knowledge and multiple trials of motor test “hand plate tapping” for assessing speed of a single limb repeated movement of preschool children.

### Methods

The research was conducted on a sample of 50 children who underwent all measurements. At the end of the research all data was collected from 50 children (32 boys and 18 girls) whose mean age was 71,5 months ( $SD=3,91$ ;  $min=63$ ;  $max=79$ ), mean height 119,8 cm ( $SD=6,00$ ,  $min=107cm$ ;  $max 135cm$ ) and mean weight 23,68 kg ( $SD=4,93$ ;  $min=17,51$ ;

max=37,8). The experimental group consisted of 27 children whose mean age was 71,51 months (SD= 3,58; min= 65; max= 79 months), mean height 119, 81cm (SD= 6,03; min=109cm ;max=135cm) and mean weight 23,92 kg (SD= 5,48 ;min=17,6kg ; max= 37,8). The control group consisted of 23 children whose mean age was 71,52 months (SD= 4,34; min=63; max=78 months), mean height 119,95cm (SD= 6,10; min= 107 cm; max= 133cm) and mean weight 22,71kg (SD= 4,23; min= 17,51kg; max= 34kg). Data collection consisted of speed of a single limb repeated movement assessment in “tapping” test for the experimental and control group in the initial and final testing and in transitive assessment only for the experimental group, which then performed a task with previously defined settings. After the initial testing the experimental group had an experimental treatment which lasted for three weeks and included giving a lot of feedback in order to stimulate motor learning and the formation of quality motor program which could influence results improvement in test. Every three days the examinees performed five trials of selected tasks. After each trial they were given feedback on the movement quality and the scores which achieve the highest result. After four trials, during the fifth, the achieved score was recorded. So, the experimental treatment was assessed three times during which each examinee had 15 trials of each task. When performing “hand plate tapping” (HT) task, the examinees were given feedback on the proper position and sitting as well as their body stillness during performance, on hand motion amplitude (correcting unnecessary vertical hand motion, decreasing hand motion length).

The results were processed by using *Statistica 8.0* software, the basic descriptive parameters were calculated (arithmetic mean and standard deviation), normality of data distribution was tested by Kolmogorov-Smirnov test, reliability by Cronbach  $\alpha$  and homogeneity by average correlation between AVR items. The analysis of differences was tested by ANOVA test and the differences between each treatment session (transitive assessment) for the experimental group were tested by t-test for dependent samples. All methods were used with significance level of  $p = 0,05$ .

## Results

Kolmogorov-Smirnov test indicated normality of variable distribution. It was also determined that “tapping” test in the initial testing had a satisfactory reliability and homogeneity, Cronbach  $\alpha = 0,84$ , AVR=0,84.

Table 1. Descriptive statistics of the control and experimental group and differences between groups in the initial testing (ANOVA)

TEST	Group	N	Mean	Minimum	Maximum	Std.Dev.	Skewness	Kurtosis	F	p
IHT	C	23	18,81	14,00	25,67	3,00	0,30	-0,15	0,10	0,76
IHT	E	27	18,58	14,67	23,33	2,27	0,42	-0,32		

The results indicate that there was no statistically significant difference in the initial testing between the two tested groups (ANOVA test;  $F=0,10$ ,  $p=0,76$ ).

Table 2. Descriptive statistics of the control and experimental group and differences between groups in the final testing (ANOVA)

TEST	Group	N	Mean	Minimum	Maximum	Std.Dev.	Skewness	Kurtosis	F	P
FHT	C	23	21,58	15,67	27,67	3,42	0,04	-0,84	20,69	0,00*
FHT	E	27	25,37	20,33	30,33	2,45	-0,08	-0,46		

\* $p=0,05$

The results of the final testing indicate statistically significant improvement of results for the experimental group due to the treatment (ANOVA test;  $F=0,10$ ,  $p=0,00$ ). Besides recorded differences it was evident that the improvement of value and homogeneity of results was not significant for the experimental group (Cronbach  $\alpha=0,96$ , AVR=0,90).

When considering the results obtained by t-test for dependent samples between the initial and transitive testing, it is evident that statistically significant differences can be recorded already after the first treatment, i.e. after practicing the task in only 5 trials. Each of the next treatments increases scores until the final measurement in which the scores remained on the same level as in the third transitive testing. The results are shown in table 3.

Table 3. Differences between the initial, transitive and final status of the experimental group in HT task

	Mean	Std.Dv.	t	p
IHT	18,58	2,27	-9,85	0,00*
HT5	22,59	2,71		
HT5	22,59	2,71	-3,06	0,01*
HT10	23,33	2,66		
HT10	23,33	2,66	-9,18	0,00*
HT15	25,41	2,72		
HT15	25,41	2,72	0,11	0,91
FHT	25,37	2,45		
IHT	18,58	2,27	-15,58	0,00*
FHT	25,37	2,45		

\*p=0,05

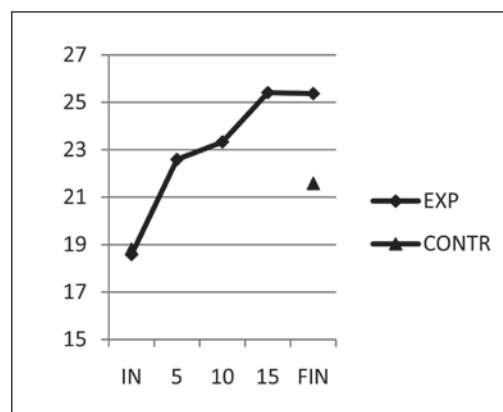

Graph 1. Curve of score improvement in HT test.

## Discussion and conclusions

The research results indicated that preparation (additional practice) for motor test performance significantly improved test scores in which feedback given to the examinees during performance played a crucial role. The analysis of results established that two groups, who in the initial testing were homogenous in the observed motor dimension, significantly differed in the final testing. It was also recorded that the experimental group significantly improved its results during the experimental treatment. These results correspond to Kosinac's (2005) hypotheses stating that motion performance can only be improved by practicing under maximum level of performance ability, hence only quality and precise repetition improves motor program. Besides the recorded differences between the groups during the treatment, the importance of giving feedback and the influence of motivation on test scores were also evident from the differences between the third transitive testing (recorded after 15 trials) and the final testing in which the scores were the same or smaller than those in the treatment. This can be explained by the fact that the children during the treatment performed tasks in groups of three in separate rooms where attention was paid to performance quality and motivation, while the final testing was performed in a traditional way with all the children at the same time in one room. High impact of motivation was also noticed by Valentini and Rudisill (2004). Therefore it can be concluded that when children are deprived of feedback, and when the surroundings influence their concentration during testing, they achieve weaker results. These conclusions correspond to Tsigilis and Theodosiou's research (2008) establishing that not even five preparatory sessions were enough to stabilize the scores. Bala (1999) concluded that children should be given appropriate instructions, test trials for each task their motivation should be increased. Since the experimental program draft in this research was organized in such way to avoid the influence of biological growth, development and transformation of motor skills, the main role in motor task performance was attributed to familiarization with the situation in which motor task and learning were performed. This is supported by Winstein (1991) who stated that in the process of motor learning inner feedback includes kinesthetic, visual, skin, vestibular and auditory signals, whereas external feedback comes from the surroundings and builds upon inner. Moreover, inner feedback motivates them for performance and external informs them about errors. Wolpert (2001) emphasized that inner sensory feedback from one action is not necessary only for evaluation of this action, but it is also the initiator of the following action. These results support the theory proposed by Sullivan et al. (2008) indicating that children use acquired motor knowledge differently than adults. Sekulić and Metikoš (2007) stated that based on the previous motor knowledge acquired in this way, a person creates new, rough motor programs. So, if children are provided with sufficient amount of feedback on their performance quality, they will be able to achieve their maximum efficacy. Kotke (1978) emphasized that the most important aspect of exercising is the creation of inhibition control, which inhibits musculature that does not participate in a movement. Therefore it can be concluded that during motor knowledge acquisition, preschool children create a motor program which uses specific structures responsible for performance efficacy of a certain motor skill.

## Conclusion

In this research load volume (short time and a small number of repetitions) was not sufficient to influence the development of motor ability therefore the obtained results indicate that by acquiring higher level of motor knowledge children significantly improve their scores in speed of a single limb repeated movement motor tests no matter which motor skill is being tested. This approach to motor skill testing with preschool children signifies that it is not justified to use protocols and standards for testing adults when assessing children. An important task for improving performance quality is understanding the set task, so a movement can only be learned if performance and results are recognized as

successful. Therefore in order to avoid making mistakes when assessing motor status, a child should be prepared for motor task performance as well as for the situation in which the task is performed. During the performance a child should be given enough feedback on the task and scores so that it can become familiar with the test and in that way reach the maximum of its motor abilities.

## References

1. Bala, G. (1999). Some problems and suggestions in measuring motor behavior of pre-school children. *Kinesiologia Slovenica*, 5,(2), 5-10.
2. Burton, A.W. and Miller, D.E. (1998). *Movement Skill Assessment*. Champaign, IL: Human Kinetics.
3. Kottke, F.J., Halpern, D., Easton, J.K.M., Ozel, A.T., Burrill, C.A. (1978). The training of coordination. *Archives of Physical Medicine and Rehabilitation*, 59 (12), 567-572.
4. Pišot, R., Planinšec, J. (2005). Struktura motorike v zgodnjem otroštvu. Motoricne sposobnosti v zgodnjem otroštvu v interakciji z ostalimi dimenzijami psihomatičnega statusa otroka. Založba Annales, Znanstveno raziskovalno središče Koper, Inštitut za kineziološke raziskave.
5. Rajtmajer D, Proje, S., Vute, R. (1989). Informacijski sistem za speljanje in vrednotenje motoričkoj sposobnosti predškolskih otrok. *Tjelesna kultura*, 37, 9-12.
6. Sekulić, D., Metikoš, D. (2007). Osnove transformacijskih postupaka u kineziologiji. Fakultet prirodoslovno – matematičkih znanosti i kineziologije Sveučilišta u Splitu. Split.
7. Sullivan, K.J., Katak, S.S., Burtner, P.A. (2008). Motor Learning in Children: Feedback Effects on Skill Acquisition. *Physical Therapy*, 88 (6), 720-732.
8. Tsigilis, N., Theodosiou, A. (2008). The influence of multiple administration of a psychomotor test on performance and learning. *Journal of Strength and Conditioning Research*, 22 (6), 1964 -1968.
9. Valentini, N., Rudisill, M. (2004). Motivational climate, motor-skill development, and perceived competence: Two studies of developmentally delayed kindergarten children. *Journal of teaching in physical education*, 23 (3), 216-234.
10. Živčić, K., Hraski Ž. (1996). Standardizacija nekih testova motorike za predškolsku dob. U: Zbornik radova - *Međunarodno savjetovanje o fitnessu*, Zagrebački sajam sporta. Fakultet za fizičku kulturu, II-12-15.
11. Živčić, K., Hraski Ž. (1995) Efekti eksperimentalnog polugodišnjeg športskog programa za predškolce /In Croatian/. In: *Zbornik radova 4. ljetne škole pedagoga fizičke kulture Republike Hrvatske*, Rovinj, 153-154.
12. Wolpert, D.M., Ghahramani, Z., Flanagan, J.R. (2001). Perspectives and problems in motor learning. *Trends in cognitive sciences*, 5 (11), 487-493.
13. Winstein, C.J. (1991). Knowledge of results and motor learning – implication for physical therapy. *Physical therapy*, 71 (2) 65-73.

## EFFECTS OF GLYCEROL-INDUCED HYPERHYDRATION ON TOTAL BODY WATER AND CORE TEMPERATURE IN ENDURANCE ATHLETES DURING THE COURSE OF TREADMILL EXERCISE PERFORMED AT 30 °C FOR 90 MIN

Pense, M.<sup>1</sup> and Turnagöl, H.<sup>2</sup>

<sup>1</sup>SÜ, Konya, Turkey

<sup>2</sup>HÜ, Ankara, Turkey

### Abstract

The purpose of this study was to determine the effects of glycerol-induced hyperhydration on total body water and core temperature in endurance athletes during the course of treadmill exercise performed at 30 °C for 90 min. 9 elite level male long-distance runners participated in this study (age:  $\bar{x} = 18,7 \pm 1,3$  years, height:  $\bar{x} = 170,7 \pm 5,2$  cm, body weight:  $\bar{x} = 58,8 \pm 6,6$  kg,  $VO_{2max}$ :  $63,94 \pm 3,04$  ml·kg<sup>-1</sup>). First,  $VO_{2max}$  of the subjects were determined with an incremental treadmill running protocol. In a randomized, double-blind cross over experimental design subjects were tested three times with 3 days intervals (wash out) following ingestion of 20 ml·kg<sup>-1</sup>BW of three different mixture of solutions: 1) diluted sports drink with 1.2 gr·kg<sup>-1</sup>BW glycerol (GS) 2) diluted sports drink (SP) and 3) aspartame flavored distilled water (SS). Exercise trials were conducted at an exercise intensity of 65% maximal oxygen consumption ( $VO_{2max}$ ) for 90 min at  $30 \pm 1.8$  °C and 25-35 % relative humidity. Total Body Water (TBW) was collected pre and post fluid ingestion, at the 30<sup>th</sup>, 60<sup>th</sup> and 90<sup>th</sup> min of exercise trials to determine TBW. Core temperatures (CT) were measured pre and post fluid ingestion, and at every ten minute of exercise trials. Data were analyzed using two-way analyses of variance (ANOVA). Significance level was defined as  $p < 0.05$ . There was no significant difference in CT among the three trials ( $F = 1.737$ ;  $p > 0.05$ ). Highest CT values (SDG:  $38.34 \pm 0.53$ , SD:  $38.20 \pm 0.46$ , W:  $38.49 \pm 0.47$  °C) were measured at 90<sup>th</sup> min of exercise trials. No significant difference was found among the three solutions ingested with respect to their effects on TBW and core temperature ( $p > 0.05$ ). In conclusion, glycerol-induced hyperhydration has no advantage compared to the other solutions ingested on TBW and CT in endurance athletes during 90 min of treadmill run.

**Key words:** glycerol, hyperhydration, core temperature, thermoregulation

## EFFECTS OF THREE DIFFERENT FLUID HYPERHYDRATION ON CARDIOVASCULAR FUNCTIONS AND ENDURANCE PERFORMANCE IN ATHLETES DURING EXERCISE AT HIGH TEMPERATURES

Yaman Lesinger, F.<sup>1</sup>, Turnagöl, H.<sup>2</sup>, Koşar, N.<sup>2</sup> and Pense, M.<sup>2</sup>

<sup>1</sup>SU, Konya, Turkey

<sup>2</sup>HU, Ankara, Turkey

<sup>3</sup>YDU, Nicosia, KKTC

### Abstract

The purpose of this study was to compare the effects of three different fluid-induced hyperhydration on Cardiovascular Functions and Endurance Performance in endurance athletes during long-term exercise at High Temperatures. In a randomized, double-blind cross over experimental design 9 male elite long distance runners were tested three times with 3 days intervals (wash out) following ingestion of 20 ml.kg-1BW of three different mixture of solutions: 1) 20 gr.kg-1BW water with 1.2 gr.kg-1BW glycerol (SDG) 2) diluted sports drink (SD) and 3) aspartame flavored distilled water (W). Exercise trials were conducted at an exercise intensity of 65% maximal oxygen consumption (VO<sub>2</sub>max) for 90 min at 30 ± 1.8 °C and 25-35 % relative humidity. Blood parameters, perceived rate of exertion (RPE), perceived thirst levels (PTL) and abdominal discomfort (AD) were measured pre and post fluid ingestion, at the 30., 60. and 90. min of exercise trial and VO<sub>2</sub>, VCO<sub>2</sub>, RER and HR values measured at every 3 minutes during the exercise test. Data were analyzed using two-way (treatment x time) analyses of variance (ANOVA). Significance was defined as p<0.05. HR, RER, VO<sub>2</sub>, VCO<sub>2</sub>, RPE, PTL and AD values didn't differ among trials. In conclusion, glycerol-induced hyperhydration has no advantage compared to the other solutions ingested on Cardiovascular Functions and Endurance Performance in endurance athletes during 90 min of treadmill run.

**Key words:** *Glycerol, hyperhydration, cardiovascular, endurance performance*



## EFFECTS OF POWER PERFORMANCE ON KICKING VELOCITY IN YOUNG SOCCER PLAYERS

Zlatko Šafarić<sup>1</sup>, Zoran Milanović<sup>2</sup>, Nebojša Trajković<sup>2</sup>, Aleksandar Joksimović<sup>2</sup>,  
Valentin Barišić<sup>1</sup> and Munir Talović<sup>3</sup>

<sup>1</sup>Faculty of Kinesiology, University of Zagreb, Croatia

<sup>2</sup>Faculty of Sport and Physical Education, Niš, Serbia

<sup>3</sup>Faculty of physical Education and sport, University of Sarajevo, Bosnia and Herzegovina

### Abstract

The purpose of this study was to determine the effects of power performance on kicking velocity in young soccer player. Research was performed on a sample of 25 elite soccer players from Serbian U-17 national team, (aged 15.19±0.32; height 176.04±6.00 cm; body mass 65.19±9.41 kg). Players were tested for kicking velocity, countermovement jump without (CMJ) and with arm swing (CMJZ), squat jump (SJ) and seven repetition jump (RJ7) during the assemble of the national team between two seasons. In all the parameters of explosive strength, midfield players (SJ=33.27±4.77, CMJ=36.25±3.78, CMJZ=44.67±4.60, RJ7=35.23±3.89) show better average values of goalkeepers, defenders and attackers. The correlation between the power performance and maximum speed shot with dominant leg was not statistically significant ( $R = 0.371$ ), as well as the impact that amounts  $R^2 = 0.138$ . As for the nondominant leg, these values are even less. Influence of SJ, CMJ, CMJZ and RJ7 on maximal speed shot is  $R^2=0.026$  and is statistically insignificant. For this reason the coaches should use different exercises and drills during the training process to create a variety of movement and better coordination of agonists and antagonists which have a key role during the shot. Different training methods and particularly the specific exercises can be aimed at improving not only muscle strength but also coordination and kicking and as well many skills parameters.

**Key words:** countermovement jump, kicking performance, shooting, goal efficiency, skilled

### Introduction

Players in competitive soccer require high levels of power, speed, and agility to perform explosive movements such as heading, shooting, sprinting, and dribbling (Stolen, Chamari, Castagna & Wisloff, 2005). Shots on goal are a particularly important feature because the final result of a match depends directly of their effectiveness. Training of this skill begins from the earliest period and her improvement lasts throughout the whole career.

The very essence of efficiency and kicking capacity has not been yet clearly defined because there are studies which confirm the direct correlation between quadriceps strength and a measure of maximum kick performance (Cabri, De Proft, Defour & Clarys, 1988; Kellis & Katis, 2007; NARIC Poor & Mognonin, 1988), as well as those that show no significant correlation and clear connection between these skills (Cometti, Maffiuletti, Pousson, & Maffulli, 2001; Masuda, Kikuhara, Demura, Katsuta, & Yamanaka, 2005; Saliba & Hrysonmalis, 2001).

The question is how much technical training and players training level can affect the kicking velocity. One study (Anthrakidis, Skoufas, Lazaridis, & Zaggelidis, 2008) shows that there is higher correlation between explosive strength and speed of the ball in a maximum soccer kick in unskilled group than for highly trained players. This suggests that at higher levels of skill, other factors besides muscle function (e.g., skill) may become more influential to kicking performance (Young & Rath, 2011). This is particularly important in young players because despite the increasing strenght in this period, we should strive for the maintaining of technical skills of players because of their efficiency.

Many research studies on soccer kick emphasized the importance of maximum power of the lower limb muscles and the coordination between the agonist muscles (vastus lateralis and medialis, rectus femoris, tibialis anterior and m. iliopsoas) and the antagonists (gluteus maximus, biceps femoris and semitendinosus) during the kick (Isokawa & Lees, 1988; Lees & Nolan, 1998; Dorge et al., 1999).

Based on the above mentioned facts, causal connection between explosive strength and kicking performance could not be certainly determined. Therefore, the purpose of this study was to determine the effects of power performance on kicking velocity in young soccer player. Iz svega navedenog nije moguće utvrditi uzročno posledicne veze između, stoga

## Methods

Research was performed on a sample of 25 elite soccer players from Serbian U-17 national team, (aged  $15.19 \pm 0.32$ ; height  $176.04 \pm 6.00$  cm; body mass  $65.19 \pm 9.41$  kg.). The majority of players (more precisely 15) were part of Serbian team in the recent European Championship U-17 players (Serbia 2011). All players and their parents or guardians were fully informed and they signed a consent form. The study protocol was held for every subject. Beside the results, the basic anthropometric parameters (body height-TV and body weight-MT) and the age of the players were registered in the study protocol. Measurements for the explosive power and kicking performance were carried out in the same day, during the morning. The protocol of the study was approved by the Ethical Committee of the Faculty of Sport and Physical Education, University of Nis, according to the revised Declaration of Helsinki.

Before each testing the subjects performed a standard 25 minute warm-up. During the test air temperature ranged from  $22^{\circ}\text{C}$  to  $25^{\circ}\text{C}$ . It began at 10 am and finished by 1 pm. The testing was conducted during a representative gathering of the season 2009/2010.

Table 1. Descriptive statistical parameters of soccer player (Mean $\pm$ SD)

	Total (n=25)	Goalkeepers (n=3)	Defenders (n=8)	Midfielders (n=10)	Attackers (n=4)
Age (years)	15.2 $\pm$ 0.3	15.3 $\pm$ 0.2	15.1 $\pm$ 0.4	15.2 $\pm$ 0.3	15.2 $\pm$ 0.2
Body weight (kg)	65.2 $\pm$ 9.4	76.4 $\pm$ 1.7	66.2 $\pm$ 8.1	61.3 $\pm$ 9.8	64.5 $\pm$ 9.4
Body height (cm)	176 $\pm$ 6.0	181.7 $\pm$ 2.5	176.3 $\pm$ 6.0	173.7 $\pm$ 6.5	177.3 $\pm$ 4.5
Body mass index	20.9 $\pm$ 2.0	23.2 $\pm$ 1.1	21.3 $\pm$ 2.1	20.2 $\pm$ 1.8	20.4 $\pm$ 2.0
Body fat (%)	12.4 $\pm$ 2.4	15.1 $\pm$ 1.3	12.8 $\pm$ 2.5	11.5 $\pm$ 2.2	11.8 $\pm$ 2.4
SJ	31.70 $\pm$ 4.08	30.33 $\pm$ 1.51	31.34 $\pm$ 3.51	33.27 $\pm$ 4.77	29.55 $\pm$ 4.27
CMJ	35.45 $\pm$ 3.70	35.36 $\pm$ 1.00	34.92 $\pm$ 4.38	36.25 $\pm$ 3.78	34.60 $\pm$ 4.16
CMJZ	42.44 $\pm$ 4.27	40.36 $\pm$ 2.49	40.63 $\pm$ 4.10	44.67 $\pm$ 4.60	42.02 $\pm$ 3.02
RJ7	33.64 $\pm$ 3.47	33.43 $\pm$ 2.11	32.01 $\pm$ 2.77	35.23 $\pm$ 3.89	33.07 $\pm$ 3.72
VmaxD	103.85 $\pm$ 8.53	99.66 $\pm$ 8.50	104.55 $\pm$ 4.33	106.00 $\pm$ 8.85	100.25 $\pm$ 14.26
VmaxN	88.55 $\pm$ 11.15	72.93 $\pm$ 4.61	90.90 $\pm$ 10.92	88.49 $\pm$ 10.26	95.75 $\pm$ 7.61

SJ - Squat jump, CMJ - Countermovement jump, CMJZ - Countermovement jump with arm swing, RJ7 - Seven repeat jump, VmaxD- Shot using the dominant leg, VmaxN- Shot using the non-dominant leg

## Testing procedure

Body height and body weight were measured according to the instructions of the International Biological Program-IBP. The body height was measured with a GPM anthropometer (Siber & Hegner. Zurich. Switzerland ) to the nearest 0.1cm. Body weight was obtained by TANITA BC 540 (TANITA Corp., Arlington Heights. IL) to the nearest 0.1kg. Percentage of body fat (Bfat%) was calculated by formula: Adult body fat % =  $(1.20 \times \text{BMI}) + (0.23 \times \text{Age}) - (10.8 \times \text{gender}) - 5.4$  (Deurenberg. Weststrate. & Seidell. 1991).

For the estimation of the strength of lower extremities four tests have been used: Squat jump (SJ), counter movement jump (CMJ), counter movement jump with arm swing (CMJZ) for power and the 7 jump test (RJ7) for repetitive strength of the lower extremities. Ergotester jump system (Globus. Italy) was used to estimate vertical jump height in SJ, CMJ, CMJZ and the 7RJ. The tests on the contact platform were done twice with adequate rest between attempts and for further analyses better result was taken.

**Kicking Tests.** Kicking performance was determined from maximal ball speed during shots. The speed, was measured with 44 Check Speed Radars (Tibar Industries. Downview. Ontario. Canada). Check Speed Radars operate with 10.25-GHz frequency, and the frame of the signal is approximately 600 vertical by 400 horizontal. Radars were positioned in both upper and lower corners behind the goal. This goal was materialized on a net by means of an adhesive strip (3 m wide and 2 m high). The soccer ball was placed at a distance of 9 m. For speed values, we retained speed from the radar nearest the ball impact. The ball characteristics were in accordance with Fédération Internationale de Football Association approval (size: 5, weight: 440 g, circumference: 69 cm, and pressure: 1.000 gcm<sup>22</sup>) and the pressure was verified before each testing session. The best of 3 trials was analyzed for each subject.

## Statistical analysis

The statistical Package for Social Studies SPSS (v17.0., SPSS Inc., Chicago, IL) was used for statistical analysis. Descriptive statistics were reported as mean  $\pm$  SD for all measures with special analysis for positions in team. In addition, all data were examined by the test of normal distribution (Kolmogorov-Smirnov) before any further analysis. Linear regression analysis was used to determine the effects among the tested variables. The statistical significance was set at  $p < 0.05$ .

## Results

The Kolmogorov-Smirnov test showed that data were normally distributed. Descriptive statistics showed that goalkeepers are the tallest and also the heaviest players in the team ( $181.7 \pm 2.5$ cm) and the midfielders are the shortest with the high of  $173.7 \pm 6.5$ cm (Table 1). Thus, midfielders had the lowest fat percentage ( $11.5 \pm 2.2\%$ ), and goalkeepers had the highest ( $15.1 \pm 1.3\%$ ). In all the parameters of explosive strength, midfield players (SJ= $33.27 \pm 4.77$ , CMJ= $36.25 \pm 3.78$ , CMJZ= $44.67 \pm 4.60$ , RJ7= $35.23 \pm 3.89$ ) show better average values of goalkeepers, defenders and attackers. The correlation between the power performance and maximum speed shot with dominant leg was not statistically significant ( $R = 0.371$ ), as well as the impact that amounts  $R^2 = 0.138$ . (Table 2). As for the nondominant leg, these values are even less. Influence of SJ, CMJ, CMJZ and RJ7 on maximal speed shot is  $R^2 = 0.026$  and is statistically insignificant.

Table 2. Effects of power performance on kicking velocity

Variables	R	R <sup>2</sup>	Adjusted R Square	Std. Error of the Estimate
VmaxD	.371 <sup>a</sup>	.138	-.035	8.67996
VmaxN	.161 <sup>a</sup>	.026	-.169	12.05458

a. Predictors: (Constant), RJ7, CMJ, CMJZ, SJ, VmaxD - Shot using the dominant leg, VmaxN - Shot using the non-dominant leg

## Discussion and conclusion

Descriptive statistics showed that goalkeepers are the tallest and the heaviest players in the team ( $181.7 \pm 2.5$ cm;  $76.4 \pm 1.7$ kg) and that the midfielders are the shortest and with the smallest amount of body fat as compared with the other positional roles, which is in agreement with some previous results (Salgado et al., 2009; Vaeyens, et al., 2006; Wong, Chamari, Dellal, & Wisløff, 2009).

The results of this study differ from some previous studies (Cabri et al., 1988; Kellis & Katis, 2007; Naric et al., 1988), which showed correlation between quadriceps strength and maximum speed shot. Objasnjenej can be found in the fact that it is a highly trained players, members of national teams, which have a high level of technical training. Anthrakaidis et al. (2008) showed that with good players utreneranih there is no association between kicking velocity and power performance, but the strength of the shot is realized on the basis of other parameters.

This study did not include the influence of power performance at maximum speed shot of the dominant and non-dominant leg in precise strokes. Further research should focus on this type of reason that precision shots to the goal or to a teammate during a game (in the form of dogs) are a key component of the efficiency of a team which influences the final result.

It is assumed that professional players should have a high level of lower body strength and electromyographic activation in order to perform a strong and accurate shot (Anthrakaidis et al., 2008). This statement must not lead us to the conclusion that only muscle strength contributes to the strong and accurate shot, because it represents a complex structure. The results of this fact is confirmed by our research which shows that lower body muscle strength does not affect and was not correlated with the speed of the shot with both, dominant and non-dominant leg. For this reason the coaches should use different exercises and drills during the training process to create a variety of movement and better coordination of agonists and antagonists which have a key role during the shot. Different training methods and particularly the specific exercises can be aimed at improving not only muscle strength but also coordination and kicking and as well many technical parameters (Anthrakaidis et al., 2008). Specificity can be achieved by implementing a ball with larger weight than the usual, which would affect both, the muscle strength and the accuracy and strength of shot, but in specific conditions.

## References

1. Anthrakidis, N., Skoufas, D., Lazaridis, S., & Zaggelidis, G. (2008). Relationship between muscular strength and kicking performance. *Physical Training*, 10, 2.
2. Cabri, J., De Proft, E., Defour, W., & Clarys, J.P. (1988). The relation between muscular strength and kick performance, In T. Reilly, A. Lees, K. Davids and W.J. Murphy. (Eds.), *Science and Football* (pp. 186-193), London: E & F N Spon.
3. Cometti, G., Maffiuletti, N.A., Pousson, M., & Maffulli, N. (2001). Isokinetic strength and anaerobic power of elite, subelite and amateur French soccer players. *International Journal of Sports Medicine*, 22, 45-51.
4. Deurenberg, P., Weststrate, J.A., & Seidell, J.C. (1991). Body mass index as a measure of body fatness: Age - and sex-specific prediction formulas. *British Journal of Nutrition*, 65, 105-114.
5. Dorge, H., Bull-Andersen, T., Sorensen, H., Simonsen, E., Aagaard, H., Dyhre Poulsen, P., & Klausen, K. (1999). EMG activity of the iliopsoas muscle and leg kinetics during the soccer place kick. *Scandinavian Journal of Medicine and Science in Sports*, 9, 155-200.
6. Isokawa, M., & Lees, A. (1988). A biomechanical analysis of the instep kick motion in soccer. In T. Reilly, A. Lees, K. Davids and W.J. Murphy. (Eds.), *Science and Football* (pp. 449-455), London: E & F N Spon.
7. Kellis, E., & Katis, A. (2007). The relationship between isokinetic knee extension and flexion strength with soccer kick kinematics: an electromyographic evaluation. *Journal of Sports Medicine and Physical Fitness*, 47, 385-394.
8. Lees, A., & Nolan, L. (1998). The biomechanics of soccer: a review. *Journal of Sports Sciences*, 16, 211-234.
9. Masuda, K., Kikuhara, N., Demura, S., Katsuta, S., & Yamanaka, K. (2005). Relationship between muscle strength in various isokinetic movements and kick performance among soccer players. *Journal of Sports Medicine and Physical Fitness*, 45, 44-52.
10. Narici, M.V., Sirtoti, M.D., & Mogroni, P. (1988). Maximal ball velocity and peak torques of hip flexor and knee extensor muscles. In T. Reilly, A. Lees, K. Davids and W.J. Murphy, (Eds.), *Science and Football* (pp. 429-433), London: E & F N Spon.
11. Salgado, B., Vidal, S., Silva, S., Miranda, R., Deus, R., Garganta, R., Maia, J., Rebelo, A., & Seabra, A. (2009). Somatotype and body composition in Portuguese youth soccer players. In B. Drust, T. Reilly & A.M. Williams (Eds.), *International Research in Science and Soccer* (pp. 141-145). London: Routledge.
12. Saliba, L., & Hrysomalis, C. (2001). Isokinetic strength related to jumping but not kicking performance of Australian footballers. *Journal of Science and Medicine in Sport*, 4, 336-347.
13. Stolen, T., Chamari, K., Castagna, C., & Wisloff, U. (2005). Physiology of soccer: an update. *Sports Medicine*, 35, 501-536.
14. Vaeyens, R., Malina, R., Janssens, M., Renterghem, B., Bourgois, J., Vrijens, J., & Philippaerts, R. (2006). A multidisciplinary selection model for youth soccer: the Ghent Youth Soccer Project. *British Journal of Sports Medicine*, 40, 928-934.
15. Wong, P.L., Chamari, K., Dellal, A., & Wisløff, U. (2009). Relationship between anthropometric and physiological characteristics in youth soccer players. *Journal of Strength and Conditioning Research*, 23(4): 1204-1210.
16. Young, W.B., & Rath, D.A. (2011). Enhancing foot velocity in football kicking: the role of strength training. *Journal of Strength and Conditioning Research*, 25, 561-566.

## DIFFERENCES IN THE EXPLOSIVE JUMPING STRENGTH OF DIFFERENT GENERATIONS OF FEMALE STUDENTS AT THE FACULTY OF KINESIOLOGY\*

**Maja Horvatin-Fučkar<sup>1</sup>, Ivana Hečimović<sup>2</sup> and Ozren Radenović<sup>3</sup>**

<sup>1</sup>*Faculty of Kinesiology, University of Zagreb, Croatia*

<sup>2</sup>*Hay school Petra Preradovića Virovitica, Croatia*

<sup>3</sup>*University of Applied Health Studies in Zagreb, Croatia*

### Abstract

Assessment of differences in explosive jumping strength was carried out in the form of the standing long jump test (SLJ) on a sample of 416 first-year students enrolled in regular studies at the Faculty of Kinesiology of the University of Zagreb. Measuring was carried out as part of regular classes in the subject Basic Kinesiological Transformations for female students with the aim of establishing differences of various generations, and differences between students who studied according to the “old” curriculum and those studying according to the Bologna curriculum. The results were processed by descriptive analysis, the t-test for equality of means and ANOVA. The results show that in all parameters observed there are statistically significant differences in favour of those generations of students who studied according to the “old” curriculum in comparison to those studying according to the Bologna curriculum.

**Key words:** *female students, study programmes, explosive strength, standing long jump*

### Introduction

Explosive jumping strength is one of the key biomotor abilities in almost all conventional kinesiological activities, and one of the determinants of success in activities requiring the ability to produce maximum muscle force in the shortest possible period (Newton and Kreamer, 1994). The amount of explosive strength is determined by the ability of the summary utilisation of a large number of muscle groups that are involved in the movement, the criterion of complete inter- and intra-muscular coordination and the most favourable ratio between the components of speed and power. The aim of this research was to establish whether there are any statistically significant differences between students of various generations in the first year of study at the Faculty of Kinesiology in the initial and final jumps in the standing long jump test (SLJ) (Metikoš et al., 1989), and whether there are any statistically significant differences between the generations of students who studied according to the “old” curriculum and the generations of students studying according to the Bologna curriculum.

Students who studied according to the “old” curriculum had up to 20% more classes in certain theoretical-practical subjects during their regular studies, which is one of the presumptions for the expected greater level of motor skills, in this case explosive jumping strength. With work in smaller groups, the Bologna curriculum leads to more efficient work in classes, and with the continuous monitoring and testing of the level of skills and knowledge acquired by means of intra-term exams, the better engagement of students is ensured during the semester/year.

Explosive jumping strength is a frequent subject of research and study. Most authors in their research establish differences and the mutual impact of explosive strength and other motor skills in various activities, sports and sport disciplines (Jared et al., 2010, Erčulj et al., 2009, Vuleta et al., 2010, Ručević et al., 2010). There is a considerably smaller number of authors who have carried out research on a population of students by examining factors that influence the standing long jump test and the connectedness of muscles important for improving explosive jumping strength (Radoš et al., 2010, Ivančević, 1998).

### Methods

This research included six generations in total, that is, 416 students in the first year of regular studies at the Faculty of Kinesiology, University of Zagreb, where the chronological age of the examinees was 19±1 years. Some 207 students (average body height, ATV = 168.93±1.16 cm; body mass, ATT = 60.51±0.52 kg) studied according to the “old” curriculum, and 209 (ATV = 168.45±1.5 cm; ATT = 60.57±0.51 kg) are studying according to the new Bologna curriculum.

---

\* This research was supported, in part, by grant no. 034-0342610-2609 (Programming of transformational procedures for physical conditioning) from Croatian Ministry of science, education and sport.

An assessment of explosive jumping strength was carried out by the standing long jump test (SLJ) on two occasions, at the initial measurement in October, at the beginning of the academic year (which is a reflection of the level of skills and work prior to enrolment), and the final measurement (expected progress as a result of work during the first year of studies in practical subjects and as a result of preparations for intra-term and final exams) in May, at the end of the current academic year.

Data were processed by the statistical software package Statistica 7.0.61.v. Using the Kolmogorov-Smirnov test, it was established that the results of the initial and final measurements of the individual generations do not deviate significantly from the normal distribution, and further processing of the results proceeded by descriptive analysis.

With the t-test for dependent samples, it was determined if there were statistically significant differences in the initial and final measurements between individual generations: arithmetic mean (AM), standard deviation (SD), number of students (N), difference (DIFF), standard deviation of differences (SD. DIFF), t-value (t), error (p), degrees of freedom (df).

The difference between the generations in the initial and final measurements of the standing long jump test was tested by the univariate analysis of variance – ANOVA.

## Results

Table 1. Descriptive parameters of initial (SDM-I) and final (SDM-F) measurement of “old generations” female students

“old” generations		N	Mean	MIN	MAX	SD
2002-03	SDM-I	69	198,18	152,67	237,67	16,06
	SDM-F	69	209,90	173,33	241,67	12,5
2003-04	SDM-I	58	201,11	177,67	236	14,02
	SDM-F	58	211,82	187	251,67	14,54
2004-05	SDM-I	80	203,08	180	240	14,00
	SDM-F	80	214,30	188,33	267,33	13,71

Table 2. Descriptive parameters of initial (SDM-I) and final (SDM-F) measurement of Bologna generations female students

generations “Bolonje”		N	Mean	MIN	MAX	SD
2005-06	SDM-I	74	194,39	158	235	16,51
	SDM-F	74	206,30	171,67	250	15,11
2006-07	SDM-I	74	195,05	151,67	231,67	13,93
	SDM-F	74	208,76	180	241,67	13,30
2007-08	SDM-I	61	194,19	165,33	232,33	12,46
	SDM-F	61	207,30	144,67	248	15,41

Basic statistical parameters of the initial and final measurements indicate that the values of Means in all generations have tendency of improvement of the results (the lowest in the generation of 2003/04 to 10.71 cm and the highest in the generation of 2006/07 to 13.71 cm). The values of standard deviations of the dispersion of the results vary more in the initial probation while in the final measurement results are more uniform, indicating the attainment of the proper techniques of performance in the observed motor task. Progress between the initial and final verifications is by 1.65 cm higher in favour of the “Bologna” students (12.9 cm) than the “old program” students (11.25 cm).

Table 3. T – test for dependent samples of individual generations

	variables	T-test for Dependent Samples Marked differences are significant at p < ,05000							
		Mean	Std.Dv.	N	Diff.	Std.Dv.Diff.	t	df	p
<b>2002-03</b>	MEAN SDM-I	198,18	16,05989						
	MEAN SDM-F	209,90	12,4974	69	-11,7246	6,9712	-13,9706	68	0,0000
<b>2003-04</b>	MEAN SDM-I	201,11	14,0247						
	MEAN SDM-F	211,82	14,5374	58	-10,7069	8,2064	-9,9363	57	0,0000
<b>2004-05</b>	MEAN SDM-I	203,08	13,9948						
	MEAN SDM-F	214,30	13,7129	80	-11,7246	6,9712	-13,9706	68	0,0000
<b>2005-06</b>	MEAN SDM-I	194,39	16,5106						
	MEAN SDM-F	206,30	15,1051	74	-11,9099	9,8411	-10,4107	73	0,0000
<b>2006-07</b>	MEAN SDM-I	195,05	13,9330						
	MEAN SDM-F	208,76	13,2992	74	-13,7117	8,1626	-14,4504	73	0,0000
<b>2007-08</b>	MEAN SDM-I	194,19	12,4696						
	MEAN SDM-F	207,30	15,4147	61	-13,1202	13,3236	-7,6910	60	0,0000

Table 4. T – test of difference between generations of different study programs

	variables	T-test for Dependent Samples Marked differences are significant at p < ,05000							
		Mean	Std.Dv.	N	Diff.	Std.Dv.Diff.	t	df	p
<b>“old” program</b>	MEAN SDM-I	200,89	14,7990						
	MEAN SDM-F	212,14	13,6259	207	-11,2448	7,7391	-20,9048	206	0,0000
<b>Bologna</b>	MEAN SDM-I	194,56	14,4497						
	MEAN SDM-F	207,46	14,5528	209	-12,9011	10,4488	-17,8498	208	0,0000

T-test between the initial and final measurements at a significance level  $p < 0.001$  showed significant differences in the generation of the “old program” of study, as well as between generations of the “Bologna” study program.

Table 5. Simple analysis of variance between different generations

Variable	Analysis of Variance Marked effects are significant at p < ,05000							
	SS Effect	Df Effect	MS Effect	SS Error	df Error	MS Error	F	p
<b>MEAN SDM-I</b>	4168,019	1	4168,019	88545,08	414	213,8770	19,48792	0,000013
<b>MEAN SDM-F</b>	2272,321	1	2272,321	82297,79	414	198,7869	11,43094	0,000791

Table 6. Post Hoc Scheffe test for the initial measurement results

	Scheffe test; variable MEAN SDM – I Probabilities for Post Hoc Tests Error: between MS = 213,72, df = 410,00					
	{1} 198.18	{2} 201.11	{3} 203.08	{4} 194.39	{5} 195.05	{6} 194.19
<b>2002-03</b>		0.9381	0.5271	0.7909	0.8965	0.7889
<b>2003-04</b>	0.9381		0.9874	0.2326	0.3504	0.2489
<b>2004-05</b>	0.5271	0.9874		0.0198	0.0427	0.0268
<b>2005-06</b>	0.7909	0.2326	0.0198		0.9999	1.0000
<b>2006-07</b>	0.8965	0.3504	0.0427	0.9999		0.9997
<b>2007-08</b>	0.7889	0.2489	0.0268	1.0000	0.9997	

Post Hoc Scheffe test confirmed a statistically significant difference between the third generation of “old” program and all of the “Bologna” program generations in the results of initial measurements.

Table 7. Post Hoc Scheffe test for the final measurement results

	Scheffe test; variable MEAN SDM – F Probabilities for Post Hoc Tests Error: between MS = 198.41, df = 410,00					
	{1} 198.18	{2} 201.11	{3} 203.08	{4} 194.39	{5} 195.05	{6} 194.19
<b>2002-03</b>		0.9888	0.6073	0.8000	0.9987	0.9538
<b>2003-04</b>	0.9888		0.9586	0.4184	0.9093	0.6926
<b>2004-05</b>	0.6073	0.9586		<b>0.0313</b>	0.3138	0.1319
<b>2005-06</b>	0.8000	0.4184	<b>0.0313</b>		0.9509	0.9994
<b>2006-07</b>	0.9987	0.9093	0.3138	0.9509		0.9964
<b>2007-08</b>	0.9538	0.6926	0.1319	0.9994	0.9964	

In addition, in the final results of the measurements, Post Hoc Scheffe test showed a statistically significant difference between the third generation of “old” program and the first generation of Bologna students.

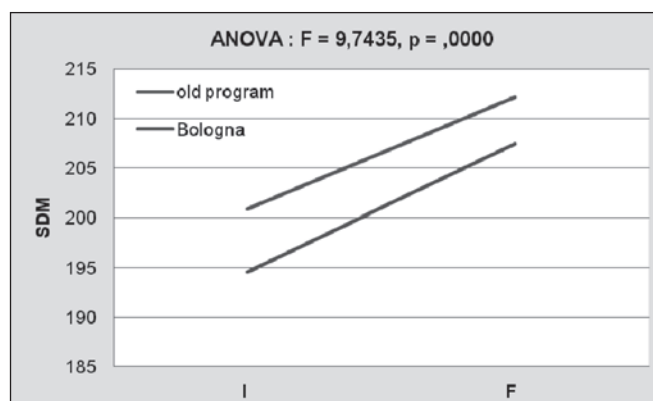

Graf 1. Differences in the progress of students within “old program” and the Bologna program

The obtained results of analysis of variance in initial and final measurement are statistically significant at significance level  $p < 0.01$  in favour of the student generation of “old program”, which is confirmed by the diagram.

## Discussion and conclusions

With the aim of determining differences in the explosive jumping strength of female students who studied according to the “old” curriculum and female students studying according to the Bologna curriculum using the standing long jump test, 416 students (6 generations) in the first year of study at the Faculty of Kinesiology of the University of Zagreb were taken as sample examinees for this research.

An analysis of the basic morphological variables (the average body height ATV of the “old” generation =  $168.93 \pm 1.16$  cm and the body mass ATT of the “old” generation =  $60.51 \pm 0.52$  kg; ATV of the Bologna generation =  $168.45 \pm 1.5$  cm; ATT of the Bologna generation =  $60.57 \pm 0.51$  kg) showed no significant differences between the generations concerned, so we may conclude that they have no impact on the results achieved.

Descriptive processing of the basic statistical indicators based on arithmetic means shows that the results of the initial and final measurements have a tendency to raise the results, indicating progress in all generations. Based on the gathered values of standard deviations, the dispersion of results varies mostly in the initial measuring, while the results are more uniform in the final measurement, which shows that the proper technique of performing the motor task was learned.

The t – test for equality of means confirmed the statistical significance of the difference in the initial and final jumps of all generations examined, and between the three generations according to the “old” curriculum and the Bologna curriculum. The analysis of variance showed that there was a statistically significant difference between the generations



of students examined in favour of those students who studied according to the “old” curriculum. There is a significant difference in results of the initial measurement of the last generation of female students under the “old” curriculum and of new generations, which can be attributed to changes in the valorisation of results in the classification procedure at the time of enrolment at the Faculty of Kinesiology.

There is a whole series of factors which have an impact on success in carrying out a particular task. This research aimed to establish whether the different curricula at the Faculty of Kinesiology have any influence on the difference in the results of the standing long jump test in the initial and final measurements. The students who studied according to the “old” curriculum had up to 20% more practical classes in certain theoretical-practical subjects, and thus as expected better motor skills. Work in smaller groups according to the Bologna curriculum leads to more efficient work in classes, and systematic exercising which is subject to continued monitoring and testing of the level of motor skills and knowledge acquired in the form of intra-term exams throughout the year, leads to the somewhat greater progress of 1.65 cm in favour of the generations concerned.

Research showed that the level of explosive jumping strength of the female students of the Faculty of Kinesiology depends significantly on the curriculum, but a large number of other factors has a significant impact on the total level of their skills, such as the level of motor skills and knowledge of the students at the time of enrolment (it is worrying that the results of the Bologna students in the initial measurement are deteriorating), and the declining number of female students actively involved in various sporting activities, either in professional sports and/or recreation, etc., resulting in the increasingly poor motor skills of new generations of students.

## References

1. Anteković, Lj. (1999). *Ergo-jump – jednostavna procedura za testiranje skočnosti*. Zagreb: Fakultet za fizičku kulturu Sveučilišta u Zagrebu.
2. Bosco, C. (1997). *Evaluation and planning condition training for alpine skiers*. Science and skiing / editors U E. Muller, H. Schwameder, E. Kornexl, C. Raschner. London: E&FN Spon.
3. Bompa, T.O. (1993). *Periodization of strenght the new wave in strenght training*. Toronto: Veritas Publishing Company.
4. Dizdar, D. (2006). *Kvantitativne metode*. Zagreb: Kineziološki fakultet Sveučilišta u Zagrebu.
5. Erčulja, F., Blas, M., Čoh, M., Bračić, M. (2009). *Differences in motor abilities of various types of European young elite female basketball players*. *Kineziologija*, 41(2/2009): 203-211.
6. Hećimović, I. (2010). *Analiza rezultata testa skok u dalj s mjesta studentica Kineziološkog fakulteta*. Diplomski rad – Kineziološki fakultet Sveučilišta u Zagrebu.
7. Ivančević, K. (1988). *Relacije morfoloških karakteristika i eksplozivne snage kod žena*. *Kineziologija* 20(1/1988) 17-22.
8. Marković, G. (2005) *Utjecaj skakačkog i sprinterskog treninga na kvantitativne i kvalitativne promjene u nekim motoričkim i morfološkim obilježjima*: doktorska disertacija. Zagreb: Kineziološki fakultet Sveučilišta u Zagrebu.
9. Metikoš, Hofman, E., Prot, F., Pintar, Ž., Orseb, G. (1989). *Mjerenje bazičnih motoričkih dimenzija sportaša*. Zagreb: Fakultet za fizičku kulturu Sveučilišta u Zagrebu.
10. Mišigoj – Duraković, M. i suradnici (1995). *Morfološka antropometrija u sportu*. Zagreb: Kineziološki fakultet Sveučilišta u Zagrebu.
11. Newton, R. U., Kreamer, W. J. (1994). *Developing explosive muscular power: Implications for a mixed methods training rategy*. *Strenght and Conditioning Journal* 16(5/1994) 20-31.
12. Pintaro, H.C. (2010). *Assessing muscular strenght in youth: Usefulness of standing long jump as a general indeks of muscular fitness*. *Journal of strength and conditioning resarch*. 24 (7/2010) 1810-1817.
13. Radoš, J., Kolarec, M., Furijan-Mandić, G. (2010). *Povezanost nekih motoričkih sposobnosti studentica Kineziološkog fakulteta s učinkovitošću izvođenja tjelesnih elemenata u ritmičkoj gimnastici*. L. Milanović, I. Jukić (ur.) *Zbornik radova Međunarodnog znanstveno – stručnog skupa „Kondicijska priprema sportaša“ trening brzine, agilnosti i eksplozivnosti*. Kineziološki fakultet Sveučilišta u Zagrebu, Zagreb 26. – 27. 03 2010., str. 626.
14. Ručević, M., Vučetić, V., Jukić, I. (2010). *Razlike u eksplozivnoj snazi kod mladih hrvatskih nogometaša s obzirom na igračku poziciju*. L. Milanović, I. Jukić (ur.) *Zbornik radova Međunarodnog znanstveno – stručnog skupa “Kondicijska priprema sportaša”*. trening brzine, agilnosti i eksplozivnosti. Kineziološki fakultet Sveučilišta u Zagrebu, Zagreb 26.- 27. 03. 2010., str. 266-270.
15. Vuleta, D., Gruić, I., Ohnjec, K. (2010). *Razlike u eksplozivnosti, brzinskim i agilnosnim svojstvima kadetskih i seniorskih hrvatskih rukometnih reprezentativki*. L. Milanović, I. Jukić (ur.) *Zbornik radova Međunarodnog znanstveno – stručnog skupa “Kondicijska priprema sportaša”*, trening brzine, agilnosti i eksplozivnosti. Kineziološki fakultet Sveučilišta u Zagrebu, Zagreb 26. – 27. 03. 2010., str. 263-266.

## STUDENTS' COMPETITION ACHIEVEMENTS ANALYSIS AT THE CITY OF ZAGREB UNIVERSITY SPORTS CHAMPIONSHIPS 2006 – 2010

Boris Metikoš<sup>1</sup>, Siniša Kovač<sup>2</sup>, Marko Milanović<sup>1</sup> and Željko Lukenda<sup>3</sup>

<sup>1</sup>Technical Polytechnic Zagreb, Croatia

<sup>2</sup>Faculty of Sport and Physical Education, University of Sarajevo, Bosnia and Herzegovina

<sup>3</sup>Faculty of Mechanical Engineering and Naval Architecture University of Zagreb, Croatia

### Abstract

The results of male and female students from 37 faculties and high schools are analysed in this paper, achieved at the Zagreb University Sport Championship during four academic years, from 2006/2007 till 2009/2010. The differences in students' competition activities are tested with Kruskal-Wallis analysis of variance and there has been calculated the Spearman range of connection coefficient between male and female contestants. The results of performed analysis showed that male students more often participate in student sports competitions in Zagreb than female students and that complete competitive activity depends on favourable conditions for performance of sports activities, independently of students' gender.

**Key words:** student sport, competition activities, Zagreb University Sports Championship

### Introduction

Sports activity of female and male students at Zagreb University and polytechnic institutions becomes most obvious during their sports competitions, which are, as a rule, held each academic year. These competition activities of all interested participants are held in more than twenty team and individual sports events. Female and male students participate almost in all the offered competitions equally, with two exceptions: men do not participate in aerobics and women do not take part in wrestling competitions.

Students' achievements accomplished either in a team or individually, are expressed in points according to the "Rules of the organization and conduction of the City of Zagreb University Sports Championships" (Hrvatski sveučilišni športski savez, 2008). Each participant (either a team or an individual) is given a certain number of positive points for its appearance in the competition. Those ranked last are given one point; the number of points rises as the achievements (ranking) progress. On the other hand, the teams and individuals who register for the competition but do not appear and do not participate in the competition, get negative points, whereas those higher education institutions the students of which do not participate at all get zero in any university sports competition event. All the negative and positive points are summed up from every competition sport event in which female and male students take part during one academic year. In that way a kind of sports achievements' volume and quality measure is obtained. The evidence about sports achievements of female and male students with 37 faculties and high schools accomplished at the City of Zagreb University Sports Championships has being kept for the last 5 academic years. The accomplished results for four academic years in the period 2006/2007 – 2009/2010, were summed up for female and male students separately of each higher education institution. These data were then treated as indicators of the development and successful implementation of complete physical exercise and sports activities at a particular higher education institution.

The collected "condensed" information about the students' organized competition activity of individual faculties and higher schools during the last four academic years (the total sum of the points won during the four years) is a good indicator of volume and intensity of students' sports competition participation in the activities organized particularly for this population.

That is why we can say that the subject of the current research is the total volume and quality of sports participation of female and male students at individual higher education institutions as observed in the sports competitions organized and conducted within the City of Zagreb University Sports Championships (Hrvatski sveučilišni športski savez, 2008). The collected data did not contain information about total individual sports-recreational or sports competitive participation of female and male students, therefore, it was not feasible to conclude that the students with the higher education institutions which did not participate in the collegiate sports competitions (and hence got 0 point) were less physically active and participated less in sporting activities than their peers who participated regularly and won many points for their higher education institutions. The data on the total sum of points speak in fact about all the hidden factors that build optimal preconditions and environmental circumstances at particular faculties or high schools underpinning students' participation

in the competitions at the level of students' university sports championship. The collected data enable the following issues to be investigated:

- 1) Are there any gender differences in volume and intensity of sports competition participation of Zagreb university and polytechnic students?
- 2) Are there any differences in volume and intensity of sports competition participation between male students enrolled into either social-humanistic, technical or biomedical-biotechnical faculties?
- 3) Are there any differences in volume and intensity of sports competition participation between female students enrolled into either social-humanistic, technical or biomedical-biotechnical faculties?
- 4) Are there any similarities in volume and intensity of sports competition participation between male and female students in the space of the analysed higher education institutions?

## Aims and hypotheses

As most issues in this paper are related with the determination of differences in volume and intensity of sports competition participation between male and female students, several goals have been set:

- 1) To determine differences between male and female students according to the total number of points won in the space of all 37 higher education institutions. In order to accomplish this goal the following hypothesis was set:
  - There is no statistically significant difference between female (W) and male (M) students in the sum of ranks (T) obtained on the variable total sum of points.

$$H_{01}: T_m = T_w$$

- 2) To determine differences in the points achieved by the male students at the institutions pertaining to social-humanistic (DH), technical (T) and biomedical-biotechnical (BMB) scientific areas. In order to accomplish this goal the following hypothesis was set:
  - There is no statistically significant difference in the sum of ranks (T) between the groups of male (M) students pertaining to the social-humanistic (DH), technical (T) and biomedical-biotechnical (BMB) institutions of higher education.

$$H_{02}: T_{DH(M)} = T_{T(M)} = T_{BMB(M)}$$

- 3) To determine differences in the points achieved by the female students at the institutions pertaining to social-humanistic (DH), technical (T) and biomedical-biotechnical (BMB) scientific areas. In order to accomplish this goal the following hypothesis was set:
  - There is no statistically significant difference in the sum of ranks (T) between the groups of female (W) students pertaining to the social-humanistic (DH), technical (T) and biomedical-biotechnical (BMB) institutions of higher education.

$$H_{03}: T_{DH(W)} = T_{T(W)} = T_{BMB(W)}$$

- 4) To determine level of relations in volume and intensity of sports competition participation between male and female students of all 37 higher education institutions. In order to accomplish this goal the following hypothesis was set:
  - There is no statistically significant relation of volume and intensity of sports activities at university sports competitions between male (M) and female (W) students in the space of all 37 analyzed higher education institutions.

$$H_{04}: R_{(MW)} = 0.0$$

## Methods

### Sample of entities

The sample of entities consists of individual university and polytechnic institutions of Zagreb with the right to participate in competitions within the City of Zagreb University Sports Championships. Other Croatian university and polytechnic institutions, faculties and high schools from Osijek, Rijeka, Split, Zadar, etc. have not been included in the analysis. That indicates the sample of entities is not representative for the population of higher education institutions in the Republic of Croatia.

The entire here analysed sample of higher institutions, 37 faculties and high schools, was classified into three subgroups by the primary scientific areas taught in them. The SOCIAL-HUMANISTIC group consisted of 15 higher education institutions, the TECHNICAL group of 13 institutions, and the BIOMEDICA-BIOTECHNICAL GROUP consisted of 9 higher education institutions.

Table 1. Groups of higher education institutions

	Social-humanistic high education institutions	Total of points during 4 academic years in all sports events			Technical high education institutions	Total of points during 4 academic years in all sports events			Biomedical-biotechnical high education institutions	Total of points during 4 academic years in all sports events	
		Men (M)	Women (W)			Men (M)	Women (W)			Men (M)	Women (W)
1	Kineziološki fakultet (KF)	639	356	1	Fakultet elektrotehnike i računarstva (FER)	701	133	1	Prirodoslovno-matematički fakultet (PMF)	428	282
2	Ekonomski fakultet (EF)	613	338	2	Građevinski fakultet (GF)	256	109	2	Prehrambeno-biotehniološki fakultet (PBF)	132	96
3	Filozofski fakultet (FF)	247	281	3	Fakultet kemijskog inženjerstva i tehnologije (FKIT)	98	54	3	Medicinski fakultet (MF)	209	94
4	Pravni fakultet (PF)	243	139	4	Tehničko veleučilište u zagrebu (TVZ)	270	46	4	Agronomski fakultet (AGF)	165	75
5	Fakultet političkih znanosti (FPZ)	114	72	5	Fakultet strojarstva i brodogradnje (FSB)	376	23	5	Stomatološki fakultet (SF)	137	54
6	Veleučilište VERN	293	46	6	Grafički fakultet (GRAF)	30	29	6	Farmaceutsko-biokemijski fakultet (FBF)	8	50
7	Katoličko bogoslovni fakultet (KBF)	64	26	7	Fakultet prometnih znanosti (FPRZ)	144	20	7	Šumarski fakultet (ŠUF)	87	16
8	Edukacijsko-rehabilitacijski fakultet (ERF)	2	22	8	Arhitektonski fakultet (AF)	62	20	8	Veterinarski fakultet (VF)	52	7
9	Hrvatski studij (HS)	153	13	9	Tekstilno-tehnološki fakultet (TTF)	7	7	9	Zdravstveno veleučilište (ZV)	31	5
10	Zg. škola ekonomije i managementa (ZŠEM)	194	14	10	Geodetski fakultet (GEF)	145	1				
11	Visoka poslovna škola Libertas (LIB)	66	6	11	Rudarsko-geološko-naftni fakultet (RGNF)	147	0				
12	Zagrebačka škola za menagement (ZŠM)	9	0	12	Visoka škola za primijenjeno računarstvo (VŠPR)	2	0				
13	Učiteljski fakultet (UF)	12	0	13	Metaluški fakultet Sisak (MFS)	0	0				
14	Visoka policijska škola (VPŠ)	1	0								
15	Visoka škola tržišnih komunikacija (AGORA)	0	0								

## Variables

Analyses will be performed on one variable representing the sum of points achieved for the student participation in a variety of sports events during four academic years, from 2006/2007 to 2009/2010, for every higher education institution separately for female and male students. Due to the nature of data about student sports activity performance, which do not meet all the necessary kinesiometric requirements thus causing the eventual deviation of data distribution from the normal one, the original raw data were transformed into ranks in order to allow the application of appropriate non-parametric data analysis method for the set hypotheses testing.

## Data processing methods

The hypotheses about the differences between the groups were tested by means of Kruskal-Wallis univariate analysis of variance. This method was used in the following three cases:

- 1) To establish the differences between male and female students according to the total number of points won in the space of all 37 higher education institutions;
- 2) To establish the differences in the points achieved by the male students pertaining to the social-humanistic, technical and biomedical-biotechnical institutions of higher education;
- 3) To establish the differences in the points achieved by the female students pertaining to the social-humanistic, technical and biomedical-biotechnical institutions of higher education.

Also, besides the mentioned analyses, Spearman rank order correlation analysis between the variables representing the total sum of points of female and male students from all 37 institutions was performed.

## Results and discussion

Table 2. Results of Kruskal-Wallis test computed between men (M) and women (W) on the ranks obtained from the sum of points

Kruskal-Wallis ANOVA by Ranks; (Gender)			
Kruskal-Wallis test: $H(1, N=74) = 8,663329$ $p = ,0032$			
	Code	Valid	Sum of
M	101	37	1659.500
W	102	37	1115.500

The statistically significant difference between women and men was obtained ( $p=.0032$ ) indicating male students competed more frequently in the City of Zagreb University Sports Championships than their female colleagues who due to that fact won considerably fewer points in all the offered sports events, consequently lower ranks sum.

Table 3. Results of Kruskal-Wallis univariate analysis of variance between male students pertaining to the social-humanistic, technical and biomedical-biotechnical scientific areas

Kruskal-Wallis ANOVA by Ranks; <b>(Men)</b> Kruskal-Wallis test: $H(2, N=37) = .0049032$ $p = .9976$			
	Code	Valid	Sum of
1	1	15	283.0000
2	2	13	249.0000
3	3	9	171.0000

It is quite evident that student pertaining to different groups of higher education institutions did not differ significantly among themselves ( $p=.9976$ ), therefore, the consideration is viable that the intergroup differences were higher than the intergroup differences. This in short means that the variability of students' sports participation in collegiate sports competitions is very similar across the three scientific area groups of institutions (faculties and high schools) students were affiliated to. Namely, within each group there are higher education institutions male students of which do not compete at all, then certain institutions with students who compete from time to time, and those faculties and high schools with male students who compete on a regular basis thus winning a big number of points, that is, high ranks, for their institutions.

Table 4. Results of Kruskal-Wallis univariate analysis of variance between female students pertaining to the social-humanistic, technical and biomedical-biotechnical scientific areas

Kruskal-Wallis ANOVA by Ranks; <b>(Women)</b> Kruskal-Wallis test: $H(2, N=37) = 1.905532$ $p = .3857$			
	Code	Valid	Sum of
1	1	15	280.5000
2	2	13	215.5000
3	3	9	207.0000

Although the obtained value of  $p=.3857$  is considerably smaller than the identical indicator with the male students, it is feasible to state that the intragroup differences are significantly greater than the intergroup ones with regard to the variability of the ranks obtained from the sum of points. Therefore, within the groups of the social-humanistic, technical and biomedical-biotechnical institutions similar variations among individual faculties and high schools are noticeable with regard to the participation of female students in collegiate sports competitions.

Table 5. Magnitude of relations between the ranks of male (M) and female (W) student competitors of all 37 higher education institutions

Spearman Rank Order Correlations Marked correlations are significant at $p < .01000$				
	Valid	Spearman	t(N-2)	p-level
M & W	37	0.720052	6.138867	0.000001

The obtained correlation is statistically significant at the level of  $p=.01$ , clearly indicating perennial intensity and volume of female and male students' sports competition participation at the City of Zagreb University Sports Championships have been very similar, that is, there were no significant gender differences in student sports participation. It is evident there is a regularity in that female students with particular higher education institutions follow their male colleagues in their regular and high sports competition participation, and vice versa. In fact, students of both genders with the faculties and high schools at which physical education and sports activity participation work conditions are optimal and well maintained are equally highly motivated to engage in physical activities and various sports, whereas at the institutions which do not have optimal PE and sports working conditions neither men nor women engage in sports competitions.

## Conclusion

The sports results were analysed accomplished by female and male students with 37 faculties and high schools at the City of Zagreb University Sports Championships during four academic years, commencing from the 2006/2007 academic year till the 2009/2010 academic year. Every higher education institution was represented with the total sum of points won during the four competition seasons by their female and male students (both teams and individuals) who participated in a variety of sports events. The obtained results were transformed into ranks in order to enable application of adequate statistical analyses.

The Kruskal-Wallis analysis of variance was used to verify the differences in students' sports competition activities in relation to:

- 1) Gender of the competitors coming from different higher education institutions;
- 2) Affiliation of the male competitors to the social-humanistic, technical and biomedical-biotechnical groups;
- 3) Affiliation of the female competitors to the social-humanistic, technical and biomedical-biotechnical groups;
- 4) Apart from the mentioned analyses on the results of all the 37 institutions, the Spearman rank order correlation coefficient was calculated between the female and male competitors.

The results of the performed analyses showed the following:

1. Male students compete on average more than their female colleagues at students' sports competitions in Zagreb.
2. Male students pertaining to the social-humanistic, technical and biomedical-biotechnical scientific areas, consequently groups of higher education institutions do not differ significantly among themselves in amount of competition activity at student championships.
3. Female students pertaining to the social-humanistic, technical and biomedical-biotechnical scientific areas, consequently groups of higher education institutions do not differ significantly among themselves in amount of competition activity at student championships.
4. Variability of competition activity of both female and male students with the Zagreb higher education institutions varies similarly ( $R_{(MW)}=0.720052$ ,  $p=0.000001$ ). This finding means that competition activity depends primarily upon favourable working conditions for sports activity implementation at a particular higher education institution and not upon gender.

This research demonstrates there are very interesting research issues related to sports participation of female and male students. It is our opinion that further research studies should be primarily directed to the determination of all the relevant factors responsible for physical education optimal working conditions provision at the higher education institutions, consequently for collegiate sports competitions organization and implementation.

## References

1. Andrijašević, M., Paušić, J., Bavčević, T., Ciliga, D. (2005). Participation in leisure activities and self-perception of health the students of the University of Split. *Kinesiology*, 37(1), 21-31.
2. Marković, G., Žugić, Z. (2000). Bavljenje sportom studenata Zagrebačkog sveučilišta smještenih u studentskim domovima. U V. Findak (ur.), *Zbornik radova 9. Ljetne škole pedagoga fizičke kulture Republike Hrvatske "Primjena novih tehničkih i tehnoloških dostignuća u edukaciji, sportu, sportskoj rekreaciji i kineziterapiji"*, Poreč, 24.-28. Lipnja, 2000. (str.165-166). Zagreb: Hrvatski savez pedagoga fizičke kulture.
3. Markuš, D., Andrijašević, M., Prskalo, I. (2008). Tjelesna aktivnost maturanata. *Odgojne znanosti*, 10(2), 349-367.
4. Perasović, B., Bartoluci, S. (2008). Slobodno vrijeme i kvaliteta života mladih. U M. Andrijašević (ur.), *Zbornik radova međunarodne znanstveno-stručne konferencije "Kineziološka rekreacija i kvaliteta života"*, Zagreb, veljača, 2008. (str. 15-24). Zagreb: Kineziološki fakultet
5. Hrvatski sveučilišni športski savez (2008). Pravila za organiziranje i provođenje sveučilišnih športskih prvenstava Republike Hrvatske/ on line/. S mreže skinuto u ožujku 2011. s adrese <http://www.zsss.hr/dokumenti/Pravila%20za%20organiziranje%20i%20provođenje%20Sveucilisnih%20sportskih%20prvenstava%20Republike%20Hrvatske.pdf>

## DIFFERENCES IN EXPLOSIVE POWER OF FOOTBALL PLAYERS OF DIFFERENT AGE CATEGORIES

**Marko Sukreški, Ivan Krakán and Jozo Tomić**

*Faculty of Kinesiology, University of Zagreb, Croatia*

### Abstract

The aim of this study was to investigate differences in explosive power performance of football players of different age categories. 128 soccer players participated in this study. They were assigned to their respected age groups (U-15, U-17, U-19 and O-19). Explosive power performance was determined by measuring 4 jump test (SJ, CMJ, MAX and RS). One-way ANOVA was used to determine whether differences between specific tests in different age groups exist. Tukey post hoc test was used to establish group differences.

Results indicate that groups U-15 and U-17 significantly ( $p < 0,05$ ) differ from the group O-19 in tests SJ, CMJ and MAX that indirectly measure explosive power. Also difference in test RS was found between groups U-15 and O-19. Results found do not discriminate players of different age groups participating in youth soccer development in explosive power. Results from explosive performance tests should be used, as selection criteria, only in U-19 group and beyond.

**Key words:** *power performance, soccer, youth soccer, testing, selection*

### Introduction

Constant improvement of the football game is causing constant changes in the characteristics of the players. From the very beginning of their football career, players need to invest a lot of hard work and training, as well as a lot of sacrifice, in order to become top professional football players. Top players are those who have developed all the anthropological characteristics that are vital for success in football.

During a match that lasts a little more than 60 minutes, a young soccer player covers 6,175 m at various speeds (Castagna, D'Ottavio & Grant.; 2003.). The typical distance covered by a top-class outfield player during a match is 10 – 13 km (Bangsbo, Mohr & Krstrup). Within this endurance context, numerous explosive bursts of activity are required, including jumping, kicking, tackling, turning, sprinting, changing pace, and sustaining forceful contractions to maintain balance and control of the ball against defensive pressure. During a soccer game, a sprint bout occurs approximately every 90 seconds, each lasting an average of 2-4 seconds (Bangsbo, Nørregaard & Thorsøe). In the endurance context of the game of the game, each player performs 1000-1400 mainly short activities (Bangsbo, Nørregaard & Thorsøe). Activities performed are: 10–20 sprints; high-intensity running approximately every 70 seconds; about 15 tackles; 10 headings; 50 involvements with the ball; about 30 passes as well as exchanging pace and sustaining forceful contractions to maintain balance and control of the ball against defensive pressure (Stolen et al., 2005) .The number of tackles and jumps depends on the individual playing style and position in the team. These reports show that besides the functional abilities, the explosive power of sprint and jumping is one of the vital factors in the structure of the game.

Soccer is a sport which requires an optimal combination of various motor abilities and decision making in various in-game situations in order to achieve success. Players, regardless their ages have different motor abilities, and they play on different technical and tactical levels. The existence of various in-game situations triggers the need for different physical and physiological profiles of players playing at different positions (Sporis et al., 2009).

Aim of this research was whether the players differ in explosive power of jumping within the particular age categories, as well as whether the explosive power of jumping can help in the selection process of football players.

### Methodology

The participants in this study were 80 elite male football players. Football players in this research were taken from the National team and the first Croatian football league 1.HNL. They were divided in four age category; under 15 (**U-15**), under 17 (**U-17**), under 19 (**U-19**) and over 19 (**O-19**). Age category is defined by UEFA standards.

Table 1. Morphological characteristics of participants

	U-15	U-17	U-19	O-19
<b>Number</b>	25	20	29	54
<b>Age</b>	14,52±0,26	15,64±0,32	18,31±0,49	22,96±2,23
<b>Height</b>	173,36±4,57	177,95±7,92	181,53±6,36	181,53±6,31
<b>Weight</b>	60,58±6,58	67,38±8,61	76,48±7,00	77,5±9,89

Values are means ±SD

To ensure standardization of test all tests were scheduled at the same time of day and carried out in the same order and using the same apparatus. All procedures were undertaken by the same person who specialized in Human performance laboratory at Faculty of kinesiology. Each test was preceded by a standardized warm up session. Measurements for each participant in each age category were undertaken according to two main categories: anthropometric and fitness performance. Group of basic morphological characteristic (body height and body weight) and group of variables for explosive power jump type. All variables are shown in table 2.

Table 2. List of variables used

Variables	Measurement unit	Name
Body height	cm	<b>ALVT</b>
Body weight	kg	<b>AVMT</b>
Squat jump	cm	<b>SJ</b>
Counter movement jump	cm	<b>CMJ</b>
Counter movement max. jump	cm	<b>MAX</b>
Counter movement jumps-straight legs	cm	<b>RS</b>

The measurements of morphological characteristic were collected following the International Biological Program (IBP, Weiner & Lourie, 1969; Mišigoj-Duraković et al., 1995). For explosive power jump type test (SJ, CMJ, MAX i RS) tensiometric platform was used (Kistler, Quattro Jump). Each variable was measured three times. All of the participants provided written consent after being informed of the test protocol, but not of the aim of the study.

The standard procedure was used to calculate the basic descriptive statistics: mean and standard deviation. Kolmogorov-Smirnov procedure was used to test distribution normality. One-way ANOVA ( $p < 0,05$ ) was used to assess the differences between specific test in different age groups. Tukey post hoc test was used to establish differences between groups.

## Results

Table 3. ANOVA results of lower extremities explosive power test and between group's differences

Variable	Group	Valid N	Mean	STD	Min	Max	F	p
SJ	U-15*	20	42,05	4,56	39,00	53,50	5,015	,003
	U-17#	20	43,14	3,72	39,20	51,17		
	U-19	20	44,74	4,05	40,27	54,60		
	O-19	20	46,75	3,96	40,00	56,97		
CMJ	U-15*	20	45,31	4,35	39,00	56,97	4,178	,009
	U-17#	20	46,28	3,38	39,20	51,17		
	U-19	20	46,99	3,71	40,27	54,60		
	O-19	20	49,64	4,66	40,00	56,97		
MAX	U-15*	20	53,24	4,89	42,63	62,57	4,422	,006
	U-17#	20	54,01	3,48	48,07	62,77		
	U-19	20	54,36	3,92	47,23	61,37		
	O-19	20	57,95	5,29	47,17	68,83		
RS	U-15*	20	38,78	2,51	33,70	43,80	3,784	,014
	U-17	20	40,22	3,22	33,20	46,20		
	U-19	20	40,21	3,73	33,40	47,40		
	O-19	20	42,79	5,32	28,40	53,70		

Tukey Post Hoc results: \*Significant difference between U-15 and O-19 group ( $p < 0,05$ ); #Significant difference between U-17 and O-19 group ( $p < 0,05$ )



The results obtained from ANOVA (Table 3.) show that in each variable there were statistically significant differences between groups. Furthermore, post hoc procedure determined differences among different age groups.

Results from post hoc procedure indicate that in SJ, CMJ and MAX test there is statistically significant difference found between U-15 and O-19 group, and also between U-17 and O-19 group. While RS test shows only U-15 group different from O-19 group.

## Discussion

Authors hypothesized that there should be significant difference found between all age groups that were involved in this study. Reason for such assumption lies in morphological difference, following chronological and biological development. The results obtained indicate statistically significant difference of groups U-15 and U-17 with O-19 group. These results are quite logical due chronological and biological maturation of organism. Explosive and plyometric strength of the muscles that we tested with these tests depends heavily on the biological age of the organism, i.e. the development of bone, muscle, and ligament, neural and hormonal systems. At the age of 14.52 years (U-15) most of the entities are at their puberty, thus mentioned systems are not yet fully developed and therefore cannot manifest exploitation of potential. Another reason might be that the entities in the group U-15 have not been subjected to specific fitness training that could produce enhanced power output, while the entities in the group of seniors undergo specific fitness training for many years and therefore have better results. It is interesting how the group U-17, U-19 and seniors do not differ statistically significant, although there is a difference in chronological age. When we look at the results of each of these groups we see that the results of the group U-17 and U-19 are almost identical and the results of a group of seniors slightly higher but not statistically significant. One of the reasons for these results may be that the groups U-17 and U-19 are at the end of their puberty or during post-pubertal period and their biological age is almost the same as in seniors, but they still train in youth training regime, while seniors are subjected to different training regimes that are more intense and specialized. Based on the data we can say that today players with the 15 years we can start with specific explosive strength training in soccer. Success in sport is the result of planned and hard work. All successful athletes are trained individuals who excel in particular activities, and follow a well-designed long-term training program over several years and during which they were subjected to selection. The selection criteria we used in a certain period of sports career distinguish superior from average players. The results that we obtained in this study tell us that there is room for improvement in all youth players because authors did not find difference between age groups in youth soccer. Based on the morphological knowledge those differences in explosive performance should exist.

## Conclusion

To become the best each player must satisfy two conditions. One must have a satisfactory set of genetic factors, and that this set of factors is developing with a systematic and controlled training throughout player's career. In this paper we tested explosive performance of lower extremities in different age groups of soccer players. Based on data analyzed, we found that there is still room for improvement in mentioned ability in youth soccer. Also we recommend that the tests of explosive jump power can be used as selective criteria in the selection of players only at the age U-19 and beyond.

## References

1. Bangsbo, J., Krustup, P. i Mohr, M. (2003). Physical Capacity of High-level Soccer Players in Relation to Playing Position. U Book of Abstracts "World Congress on Science and Football – 5", Lisabon, 2003 (str. 76). Madrid: Gymnos Editorial Deportiva.
2. Bangsbo, J., Mohr, M. and Krustup, P. Physical and metabolic demands of training and match-play in the elite football player. *Journal of Sposts Science*; 2006. 24(7): 665-674.
3. Bompa, T. (1999). *Periodization: Theory and methodology of training*. Champaign, IL: Human Kinetics.
4. Bompa, T. (2005). *Cjelokupan trening za mlade pobjednike*. Gopal, Zagreb.
5. Castagna, C., D Ottavio, S. and Abt, G. (2003). Activity profile of young Soccer players during actual match play. *Journal of Strength and Conditionings Research*. 2003. 17 (4). 775-780.
6. Gil, S. at al. (2007). Physiological and anthropometric characteristic of young soccer players according to their playing position: Relevance for the selection proces. *Journal of Strength and Conditionings Research*. 2007. 21(2). 438-445.
7. Malacko, J., Rado, I. (2004). *Tehnologija sporta i sportskog treninga*. Fakultet sporta i tjelesnog odgoja, Sarajevo.
8. Marković, G., Bradić A., *Nogomet-integralni kondicijski trening*. Udruga "Tjelesno vježbanje i zdravlje", Zagreb.
9. Pearson, A. (2001). *Speed, agility and quickness for soccer*. London: A & C Black.
10. Stolen, T., Chamari, K., Castagna, C., & Wisloff, U. (2005) *Physiology of Soccer – An Update*. *Sports Medicine* 35(6), 501-536.
11. Viru, A. (1995). *Adaptation in sport training*. Boca Raton, FL: CRC Press Inc.
12. Wasserman, K., J.E. Hansen, D.Y. Sue, R. Casaburi & B.J. Whipp (1999). *Principles of exercise testing and interpretation* (III ed.). Baltimore: Lippincott Williams & Wilkins.

## EFFECTS OF THE PROGRAMME OF ISOKINETIK EXERCISING ON THE STRENGTH OF KNEE EXTENSORS

**Elvir Kazazović, Mensur Vrcić, Edin Jelešković and Haris Alić**

*Faculty of Sport and Physical Education, University of Sarajevo, Bosnia and Herzegovina*

### Abstract

The aim of this research was to examine peak tork, total work as well as the average strength of extensors of dynamic knee stabilizers. The examinees who took part in this research were 108 students of Faculty of Sport and Physical Education from Sarajevo. The examinees were divided into two groups: control and experimental one. The peak torque of dynamic knee stabilizers was tested on isokinetic equipment (Biodex 3) at angle velocities of 60°/s and 180 °/s. Apart from the trainings at Faculty of Sport and Physical Education, the experimental group also had an additional programme on Biodex 3, which was performed three times a week and lasted for 7 weeks. The results indicate that the additional programme of isokinetic exercises performed on isokinetic equipment improves the strenght of knee extensors.

**Key words:** *knee muscles, isokinetic training, effects*

### Introduction

More than ever, there is a demand of modern trainings to get better effects for as shorter period of time as possible, and to apply training methods which improve the developments that are basic for success in different sport disciplines.

Having analyzed older researches, it is obvious that there was no isokinetic training in the training process of active sportsmen/sportswomen. This research is focused on the programme of isokinetic training which will strenghten knee extensors (Kazazović et al., 2008)

Isokinetic diagnosis represents a technological development for evaluataing the relevant parameters of skeletal muscle system (Schlumberger et al., 2006) (Zakas, 2006). Even though there are many kinds of different equipment and protocols for knee exercising, none of them proved to be ideal for fast improvement of this group of muscles as well as for ideal estimation of the ratio between extensors and flexors. Combination of eccentric and concentric muscle contraction during the training on isokinetic equipment results in greater strength comparing with the training process performed on some other kinds of fitness equipment.

This research tries to determine the influence of the isokinetic programme of exercises on the strength of knee extensors. Analysing the examinees in two time points (t-test), some differences in the results of variables were determined in these two groups, which represents an objective view on the programme.

### Methods

*Isokinetic testing.* The research was performed on 108 students of Faculty of Sport and Physical Education in Sarajevo (aged 21.1 ±3.6), who were divided into a control group, which consisted of 68 students, and an experimental group, which consisted of 40 students. Beside the trainings that the experimental group had at faculty, they also had an additional training on Biodex 3.

The research was done on the Institute of Sport (Faculty of Sport and Physical Education). Protocol of isokinetik testing of the strength of knee extensors was performed at 60°/s and 180°/s, with 5 repetitions at both velocities and a pause of 30s between the repetitions. The same procedure was performed on both legs (Madsen et al., 1996; Gleeson et al., 1996). These angle velocities were used by many researchers in order to measure the strength of dynamic knee stabilizers (Kellis, Gerodimos, Kellis, Manou, 2001; Ergun, Islegen, Taskiran, 2004; Kazazović et al., 2007). Knee movements were limited between 0° to 90°. For further statistic process, automatically estimated values of peak torque, total work and average strength of extensors at both velocities were recorded. Both groups were tested again after 12 weeks of training period, using the procedures of isokinetic testing.

By isokinetic measurement of knee muscles, we got the following variables:

*Maximum strength of knee extensors at velocity of 60 °/s:*

EXTLEF60 (Nm) – peak torque of knee extensor of the left leg

EXTRIG60 (Nm) – peak torque of knee extensor of the right leg

EXLFTW60 (J) – total work of knee extensor of the left leg  
 EXRGTW60 (J) – total work of knee extensor of the right leg  
 AVGEXLF60 (W) – average strength of knee extensor of the left leg  
 AVGEXRG60 (W) – average strength of knee extensor of the right leg

*Maximum strength of the knee extensors at the velocity of 180 °/s:*

EXTLEF180 (Nm) - peak torque of knee extensors of the left leg  
 EXTRIG180 (Nm) – peak torque of knee extensors of the right leg  
 EXLFTW180 (J) – total work of knee extensors of the left leg  
 EXRGTW180 (J) – total work of knee extensors of the right leg  
 AVGEXLF180 (W) – average strength of knee extensors of the left leg  
 AVGEXRG180 (W) – average strength of knee extensors of the right leg

*Isokinetik programme of exercising:* The experimental group of examinees was tested using the isokinetic programme of exercises which was performed 3 times a week during the period of 12 weeks.

The programme was based on the following steps:

1. Warm up on cyclometre and leg stretching (15 min).
2. 3 series of 4-6 repetitions with the left leg at angle velocity of 60°/s and pauses of 30 to 60s between the series.
3. Pauses between exercises of different velocities (3 min)
4. 5 series of 4 to 6 repetitions with the right leg at angle velocity of 180°/s, with pauses of 30 to 60s between the series.
5. 3 series of 4 to 6 repetitions with the right leg at the angle velocity of 60°/s, with the pauses from 30 to 60s between the series.
6. Pause between the exercises at different velocities (3 min).
7. 5 series of 4 to 6 repetitions with the right leg at the angle velocity of 180°, with pauses from 30 to 60s between the series.

Protocol of the training was identical to the protocol of the testing, considering the instructions which were given to the students about their position at Biodex system. During this training period, the control and experimental group performed activities which were connected to the faculty programme of compulsory trainings in different subjects (athletics, handball and basics of mobility)

*Methods of data processing.* Considering the inicial testing at univariant level of data processing for defining the differences between the groups, T-test for independent samples was used. The same analysis was used to define the differences between the groups in final measurement. We found out that there were no differences between the groups of examinees on the initial test using T-test for independant samples. In the end, we defined the real effects of the programme of differently treated groups of examinees on the final testing.

## Results

In the tables there are statistical analyses of the results of the control and experimental group measured in two time points (initial and final measurement).

Analysing the results of variables of dynamic knee stabilizers in control and experimental group in the initial measurement (at the velocity of 60 °/s), we can conclude that the examinees do not differ in the initial state. Table 1 shows the results of T-test of the control and experimental group. From the results shown in the table, it is obvious that that there are no differences between the control and experimental group (at the velocity of 60°/s). Statistically important differences were not present in any of the variables.

Table 1. Values of T-test of the strength of dynamic knee stabilizers in control and experimental group in initial measurement (at the velocity of 60 °/s)

	F	Sig.	T	df	Sig. (2-tailed)	Mean Difference	Std. Error Difference	95% Confidence Interval of the Difference	
								Lower	Upper
EXTLEF60	,428	,515	1,165	106	,246	9,517	8,166	-6,673	25,707
			1,094	67,069	,278	9,517	8,698	-7,844	26,878
EXTRIG60	,073	,787	,193	106	,847	1,572	8,144	-14,575	17,719
			,179	65,011	,858	1,572	8,762	-15,927	19,071
EXLFTW60	,340	,561	1,585	106	,116	53,938	34,025	-13,520	121,396
			1,489	67,217	,141	53,938	36,217	-18,347	126,223
EXRGTW60	1,174	,281	,480	106	,632	17,919	37,300	-56,032	91,870
			,445	64,212	,658	17,919	40,289	-62,563	98,401
AVGEXLF60	2,667	,105	,301	106	,764	1,764	5,863	-9,860	13,388
			,282	66,880	,779	1,764	6,251	-10,713	14,241
AVGEXRG60	,586	,446	,045	106	,964	,257	5,673	-10,990	11,504
			,043	68,688	,966	,257	5,997	-11,707	12,221

From the Table 2 we can see the results of the T-test analysis and it is indicative that there are no statistically important differences in the strength variables at the velocity of 180°/s in this initial measurement. Also, there are no obvious statistically important differences in any of the variables.

Table 2. Values of T-test of dynamic knee stabilizer strength in control and experimental group in initial measurement (at the velocity of 180 °/s)

	F	Sig.	t	Df	Sig. (2-tailed)	Mean Difference	Std. Error Difference	95% Confidence Interval of the Difference	
								Lower	Upper
EXTLEF180	1,821	,180	,451	106	,653	2,586	5,732	-8,777	13,950
			,413	61,806	,681	2,586	6,269	-9,945	15,118
EXTRIG180	2,964	,088	,339	106	,735	1,964	5,790	-9,516	13,444
			,302	57,308	,763	1,964	6,495	-11,040	14,968
EXLFTW180	2,551	,113	,836	106	,405	22,859	27,331	-31,326	77,045
			,760	60,679	,450	22,859	30,072	-37,280	82,999
EXRGTW180	2,921	,090	1,145	106	,255	32,347	28,243	-23,647	88,341
			1,042	60,911	,301	32,347	31,037	-29,717	94,411
AVGEXLF180	1,612	,207	-,154	106	,878	-1,624	10,542	-22,524	19,276
			-,143	64,202	,887	-1,624	11,387	-24,371	21,123
AVGEXRG180	,252	,616	,498	106	,620	5,076	10,203	-15,152	25,305
			,477	71,546	,635	5,076	10,648	-16,153	26,306

After the programme performed within 3 months, the differences between the variables of dynamic knee stabilizers in the control and experimental group in the final measurement (at the velocity of 60 °/s) are statistically important. In Table 3 we can see that the experimental group had better results in arithmetic mean in all variables. It means that the additional programme on Biodex which lasted for 3 months has statistically important influence on the increase of arithmetic means in all variables.

Table 3. Values of T-test of the strength of dynamic knee stabilizers in control and experimental group in final measurement (at the velocity of 60 °/s)

	F	Sig.	t	df	Sig. (2-tailed)	Mean Difference	Std. Error Difference	95% Confidence Interval of the Difference	
								Lower	Upper
<b>EXTLEF60</b>	,297	,587	-5,975	106	,000	-47,41	7,94	-63,15	-31,68
			-5,879	77,857	,000	-47,41	8,06	-63,47	-31,36
<b>EXTRIG60</b>	,541	,463	-5,467	106	,000	-41,41	7,57	-56,42	-26,39
			-5,237	71,461	,000	-41,41	7,91	-57,17	-25,64
<b>EXLFTW60</b>	1,575	,212	-5,478	106	,000	-210,30	38,39	-286,41	-134,1
			-5,319	74,610	,000	-210,30	39,54	-289,07	-131,5
<b>EXRGTW60</b>	1,153	,285	-5,189	106	,000	-204,17	39,35	-282,17	-126,1
			-4,996	72,628	,000	-204,17	40,87	-285,63	-122,7
<b>AVGEXLF60</b>	7,932	,006	-5,070	106	,000	-34,15	6,74	-47,51	-20,80
			-4,644	62,129	,000	-34,15	7,35	-48,85	-19,45
<b>AVGEXRG60</b>	11,493	,001	-4,530	106	,000	-30,69	6,78	-44,12	-17,26
			-3,980	54,937	,000	-30,69	7,71	-46,14	-15,24

After the 3 months programme, the differences in the control and experimental group at the velocity of 180 °/s are really statistically important. In the Table 4 we can see that the experimental group had better results in arithmetic means in all variables. It means that the additional programme significantly increased the arithmetic mean in all variables.

Table 4. Values of T-test on dynamic knee stabilizers in control and experimental group in final measurement (at the velocity of 180 °/s)

	F	Sig.	T	df	Sig. (2-tailed)	Mean Difference	Std. Error Difference	95% Confidence Interval of the Difference	
								Lower	Upper
<b>EXTLEF180</b>	12,985	,000	-5,326	106	,000	-34,91	6,55	-47,90	-21,92
			-4,702	55,700	,000	-34,91	7,42	-49,78	-20,04
<b>EXTRIG180</b>	20,907	,000	-5,128	106	,000	-34,24	6,68	-47,48	-21,00
			-4,370	50,508	,000	-34,24	7,84	-49,98	-18,51
<b>EXLFTW180</b>	17,236	,000	-5,208	106	,000	-185,10	35,54	-255,57	-114,6
			-4,479	51,755	,000	-185,10	41,32	-268,04	-102,1
<b>EXRGTW180</b>	16,185	,000	-4,827	106	,000	-177,18	36,70	-249,95	-104,4
			-4,126	50,897	,000	-177,18	42,94	-263,39	-90,96
<b>AVGEXLF180</b>	12,921	,000	-4,369	106	,000	-56,05	12,83	-81,48	-30,61
			-3,821	54,254	,000	-56,05	14,67	-85,45	-26,65
<b>AVGEXRG180</b>	15,907	,000	-4,267	106	,000	-59,03	13,84	-86,47	-31,60
			-3,617	49,787	,001	-59,03	16,32	-91,82	-26,25

To reach conclusions, we should pay attention to differences in the results in final measurement. The results of T-test in final measurement indicate that there are statistically important differences in all variables beginning with the .00 level. The conclusion is that in the final measurement there are differences in the result level of measurement which was not the case in the initial measurement. This fact confirms the usefulness of practical effects of this experimental programme.

## Discussion

Analyses of the results of the initial and final measurement show significant differences in all tested parameters between the control and experimental group. 10 week programme of additional training on Biodex 3 significantly increased the strength of knee extensors in the experimental group. The technique of isokinetic training helped us to realise this process. The biggest increase of tested variables had the variable of average strength of extensors in left leg at the velocity of

60°, which indicates that the training had a positive effect on this less powerful limb and represents a better indicator of muscle function than the peak torque.

Values of the peak torque and total work of the extensors of both legs at the velocity of 180° also indicate significant increase, which confirms all the results of the recent researches.

This research shows that the unique training protocol of additional training on isokinetic equipment Biodex 3 causes significant increase of the strength of knee extensors and total work at both angle velocities (60 and 180°/s). Considering both angle velocities, additional analyses confirm the significant changes of the strength of knee extensors. The most important change is the significant increase of the total work of knee extensors in both legs.

This research indicates that, within 10 weeks, the examinees who had the additional training on Biodex 3, improved the strength of their knee extensors. This research also confirms that exercises of continuous resistance due to isokinetic dynamometer significantly improve the strength of knee extensors. (Kazazović, Rađo, Dervišević, Kovač 2007; Kazazović E., Tabaković M., 2008; Kazazović, E., Hadžikadunić A., Kozić V. 2008)

The results of the research confirm not only that the training protocol results in increased peak torque in the scope of angles but also in total work as well as in the strength in a certain moment. The results indicate that the strength increases in all three segments at both tested angle velocities.

## Conclusion

Applying statistical analyses on the results of the performance of the examinees divided into a control and experimental group, we evaluated the training protocol of isokinetic exercises and concluded it had positive effects in increasing the strength of knee extensors.

The additional programme of exercises on the isokinetic equipment enables continuous resistance at all angles which other training equipment do not possess (like fitness equipment and others) This possibility is important not only for significant increase of muscle strength but also for balancing the relation between extensors and flexors on dynamic knee stabilizers. The results of the research confirm the results of all other researches of isokinetic training so we propose further researches in designing the protocol of isokinetic exercising in order to give characteristics of the utility of isokinetic equipment in strengthening and protection of the strength of knee extensors.

## References

1. Ergun M, et al. (2004). *A cross-sectional analysis of sagittal knee laxity and isokinetic muscle strength in soccer players*. International Journal of Sports Medicine 25(8): 594-598.
2. Gleeson, N.P., Mercer, T.H. (1996). *The utility of isokinetic dynamometry in the assessment of human muscle function*. Sports Medicine, 21(1), 18-34.
3. Kellis S, et al. (2001). *Bilateral isokinetic concentric and eccentric strength profiles of the knee extensors and flexors in young soccer players*. Isokinetic and Exercise Science 9(1): 31-39.
4. Kazazović E, et al. (2007). *Influence of the training programme on the increase of maximum strength of dynamic knee stabilizers in active sportsmen/sportswomen*, New technologies in sports, Sarajevo.
5. Kazazović E., Tabaković M. (2008). *Influence of the maximum strength of dynamic knee stabilizers on the field of movable balance*, 5 International scientific conference on kinesiology, Faculty of Kinesiology, Zagreb, Croatia. September 10-14.
6. Kazazović, E., Hadžikadunić A., Kozić V. (2008). *Effects of additional exercise programme performed with Biodex apparatus at the maximal strength of the dynamic stabilization of knee muscles in active handball players*. Youth sport, 4<sup>th</sup> International Symposium, Ljubljana.
7. Kazazović, E., Kozić, V., Hadžikadunić, A. (2008). *Differences in dynamic knee stabilizers strength between football and handball players aged 18 to 22*, International scientific conference Theoretic, methodological and methodic aspects of physical education, Belgrade.
8. Madsen, O.R. (1996). *Torque, total work, power, torque acceleration energy and acceleration time assessed on a dynamometer: reliability of knee and elbow extensor and flexor strength measurements*. European Journal of Applied Physiology, 74, 206-210.
9. Schlumberger, A, et al. (2006). *Muscle imbalances – fact or fiction?* Isokinetics & Exercise Science, 1(14), 3-11.
10. Zakas, A. (2006). *Bilateral isokinetic peak torque of quadriceps and hamstring muscles in professional soccer players with dominance on one or both two sides*. The Journal of Sports Medicine and Physical Fitness, 46 (1), 28-35.

## METRIC PROPERTIES OF DISPOSITIONAL FLOW SCALE-2 ON CROATIAN SAMPLE

**Boris Balent<sup>1</sup>, Ivan Kepcija<sup>2</sup> and Ksenija Bosnar<sup>3</sup>**

<sup>1</sup>*Elementary school Davorin Trstenjak, Zagreb, Croatia*

<sup>2</sup>*Holy Names University in Oakland, CA, USA*

<sup>3</sup>*Faculty of Kinesiology, University of Zagreb, Croatia*

Assessment of optimal experience in sport can be done by self-report instruments Flow State Scale-2 and Dispositional Flow Scale-2 by Jackson and Eklund (2004). To enable the research of flow experience in Croatian sport population, Dispositional Flow Scale-2 (DFS-2, Jackson, Eklund & Martin, 2010.) was translated. The translation was first done independently by two sport psychologist, and then settled into final version. DFS-2 scale was given to the sample of 217 kinesiology students with instruction to evoke subjective experiences during sport training. The results show excellent metric properties of the whole set of 36 items and total summative score. All items have substantial values on the first principle component and medium to high correlations with total score. Average correlation between items is  $r=0.31$ . Internal consistency of the DFS-2 scale determined by Cronbah's alpha is  $\alpha=0.94$ . Dimensionality of scale is estimated by spectral decomposition of standardized data matrix. The results show seven eigenvalues greater than 1. Nevertheless, the first eigenvalue explains 33% of common variance, 4 times more than second eigenvalue does (8%), and it can be concluded that scale has one principal subject of measurement. The distribution of total summative result does not significantly differ from normal, tested by Kolmogoroff-Smirnoff test ( $d=.03$ ,  $p>0.20$ ). Reliability analysis show that scale can be shortened by third, and still have Cronbah's alpha exceeding 0.9. The first application of translated DFS-2 scale proved good metric characteristics of items and total score. The next step in evaluation should be validity analysis of translated scale.

## CHANGES IN HEART RATE DIVING BEGINNERS HEART RATE FREQUENCY AS A RESPONSE TO THE PATTERN OF THE LOAD AND SIZE OF THE HYDROSTATIC PRESSURE

**Igor Baran**

*Faculty of Physical Education and Sport, Comenius University, Bratislava, Slovakia*

### **Abstract**

The paper deals with assessment of heart rate response in various modes of load through a simulated dives for the diagnosis of cardiovascular disorders.

### **Methods**

Changes in heart rate diving bradycardia and duration of apnea was recorded by the software for the tip scanning device (POLAR T 610). In analyzing the data we used the program Powerlap and MS EXCEL, WORD. Basic data of studied subjects in the application of the experimental agent (apnea, aquabike) were recorded in tables and evaluated by methods of mathematical statistics.

### **Results**

Changes in heart rate for beginners in the pool diving conditions in static apnea, suggest that observed in our subjects was recorded SF reduction in average by 30.4% compared with baseline SF.

In case of Heart rhythm changes in divers beginners in dynamic apnea in 25 m pool, we documented an average increase in SF of 22 beats / min. The values of maximum and minimum SF ranged from 106 to 179 beats / min

Heart rhythm changes in long-term apnea load within 1 hour team competition in apnea divers diving for beginners showed that the maximum SF subjects ranged from 170 to 176 beats / min. The maximum value of SF was registered in the value of 181 beats / min ..

### **Conclusions**

This dynamic apnea significantly different when compared with the static apnea in all indicators .. This basically confirms expectations that in static apnea, the more apparent diving reflex fall in SF values and vice versa apnea occurs when the dynamic rise of the SF impact load.

**Key words:** *scuba diving, aqualung, training, aerobic zones*



## THE BASICS OF QUALITATIVE RESEARCH

**Donald N. Roberson, Jr.**

*Palacky University, Faculty of Physical Culture, Olomouc, Czech Republic*

### **Purpose**

The purpose of this time is to discuss the overall basics of qualitative research. Qualitative Research (QR) has a variety of methods from basic surveys to creative films. This is an attempt to summarize these. The essence or beginning of all research is a knowledge of the literature in the field. A concise summary of this literature shows not only your knowledge of the field, but you are also becoming aware of what is missing. One of the defining aspects of qualitative research is to know what is missing. After a discussion of the main topics of research in your area, you must show how qualitative research can “fill the gap”. The basis of your sample is crucial in this research. You must show the reasons for the selection of your sample. This should be based on other studies. This is the teneacious process of actually going into the field and choosing the participants of the study. This shows how you went about choosing your sample. Included in this data are details of what worked and what did not work. Similar to above, this audit trail will show us how you went about the interviews, as well as the actual words of the interviews, what did you observe, and what documents do you have. How do you make sense out of the data? Essentially you will return to the purpose of your study and research questions. You will analyze the data based on answering these questions.

### **Method**

The researcher will discuss various research projects which has incorporated qualitative research.

### **Results**

Qualitative research helps to drive new knowledge and information by providing for information rich sources.

### **Conclusion**

It is time for sports, recreation, and kinesiology to begin to incorporate qualitative research in its field. This is especially important in central Europe which is somewhat behind western countries in this area.

## RELATIONSHIP BETWEEN INTELLIGENCE AND THE LEVEL OF MOTOR LEARNING

Pavol Horička

Constantine the Philosopher University, Nitra, Slovakia

### Abstract

The topic of the poster is to compare the level of motor learning and intelligence in boys and girls of various age categories. The aim is to get acquainted with the newest theoretical knowledge from the sphere of intelligence and motor learning, to compare the level of motor learning in boys and girls at elementary and secondary schools, as well as to find out, whether intelligence has any relationship with motor learning. We draw from the information from various sources. Results have shown that there is only a slight dependence between the level of motor learning and intelligence. No relationship was also proved between these two phenomena as to the sex of the tested individuals. We presumed that no differences will be found in the level of motor learning in boys and girls. This hypothesis was not proved, since girls performed better than boys in the level of motor learning in all age categories. Based on the results we assume that the level of motor learning can be improved by means of increasing the number of lessons of physical education in schools. This would help the prevention of modern diseases and overall level of physical fitness of inhabitants.

**Key words:** motor learning, intelligence, school age, intelligence test

### Introduction

Under the influence of philosophy also the view of human thinking has been gradually forming and philosophers begin to ask questions, whether it is possible to define in any way human potential represented by cognitive abilities. Nowadays, the operational definition of intelligence is relatively simple: “*Intelligence is the factor, by which people differ one from another, and which is connected with the overall level of abilities manifested in performances in a wide range of various tasks*” (Serebriakoff, 2000, p. 18). Ruisel in his book *Basics of psychology of intelligence* (2000) votes that there exist several kinds of intelligence and defines each one separately: practical, social, emotional, moral intelligence and others.

According to Ruisel (2000), however, the concepts of intelligence can be divided into 5 categories: *factor, cognitive, biologic-physiologic, system and developmental ones*. Mainly cognitive theories play currently a significant role in the theoretical research of intelligence. They are based on the presumption that intelligence has a close relationship with the psychic depiction of information and processes, which can be under way within these depictions. Generally it can be expected that more intelligent individuals reflect information more effectively and clearly, and they can process them more effectively and faster. The essence of biologic-physiologic theories is that the role of brain and central nervous system is studied. Azzopardi (2005) suspects that the activity of intellect depends to a great degree on the activity of brain. Gardner’s (1999) theory of multiple intelligence is based on the fact that people are able to accommodate by means of individual potentials or competences in at least seven rather independent spheres. According to Gardner these are: *linguistic, music, logical-mathematic, spatial, bodily-kinesthetic, interpersonal* (socialne), *intrapersonal* (personal) ones and each of them develops rather independently.

Mesurement of intelligence or IQ (intelligence quotient) belongs among controversial activities. For our work, the most important are complex tests of intelligence. Results of intelligence tests should be interpreted very carefully. Besides validity and reliability, we have to take into account also sociocultural factors, which can markedly influence the reached score. Currently, tests with logical constructs, symbols, shapes and models, which should simulate reality, are preferred (Azzopardi, 2005).

*Motor learning* is an intentional process, in which players acquire, learn, and improve first of all specific skills (Velenský, 1999). We speak of a *motor skill* when a pupil (sportsman) is able to perform a habit in changing conditions without decreasing the quality of movement, thus transferring his habits onto other activities (Šimonek, 2005). Velenský (1999) presents 4 basic features characteristic for motor learning:

1. Motor learning is under way inside the organism of an individual, where it causes short-term or more persistent changes, first of all in central nervous system. The process of motor learning is thus difficult to be observable, but its products – *skills* – can be observable.
2. Motor learning is, from the point of view of its course and results, an individual process.
3. The course of motor learning is not straightforward and can mean both positive and negative shifts.
4. For the initial phases of motor learning the most suitable period lies between 6 and 10 years. Children at this motor stage feel joy of movement and, with some exceptions, conform to the requirements of a teacher.

## Aims and tasks

The aim of this paper is to get acquainted with the newest theoretical knowledge from the sphere of intelligence and motor learning, compare the level of motor learning in boys and girls, and find out whether intelligence has any impact on the level of motor learning.

The level of motor learning will be assessed using gymnastic elements – front roll (6<sup>th</sup> form), backward roll (7<sup>th</sup> form), headstand (1<sup>st</sup> form of secondary school), cartwheel (2<sup>nd</sup> form of secondary school). In order to find out intelligence we shall use intelligence test by means of which we will determine the size of intelligence quotient (IQ).

## Methods

The observed group of pupils from 6<sup>th</sup> form, 7<sup>th</sup> form, 1<sup>st</sup> form of SS, and 2<sup>nd</sup> form of SS in Nitra, who have not learned the specified gymnastic elements before. The number of lessons for the acquisition of gymnastic skills was 3 times 45 minutes.

During each lesson we recorded the level of motor learning in boys and girls upon performing the acquired gymnastic elements using marks 1 through 5. After each lesson, acquisition of individual phases being acquired, was assessed.

We focused on the testing of general (academic) intelligence. In order to measure it we used Azzopardi's (2005) intelligence test. Generally, the test consisted of 2 intelligence tests, while each of them consisted of 20 questions. The time limit was 20 min.

In our work we tested dependance of quantitative signs. For the calculation of the correlation coefficient was used parametric coefficient of correlation – *Pearson's correlation coefficient*. Correlation (in absolute value) under 0.1 is trivial, 0.1–0.3 low, 0.3–0.5 moderate and above 0.5 close.

Table 1. Average data of pupils (Basic School)

Sex	Average height [cm]	Average weight [kg]	Number	Academic Year
Boys	151	41.8	15	6 <sup>th</sup>
Girls	154.3	44.2	15	6 <sup>th</sup>
Boys	160.2	47.8	15	7 <sup>th</sup>
Girls	1156.6	46.3	15	7 <sup>th</sup>

Table 2. Average data of pupils (High School)

Sex	Average height [cm]	Average weight [kg]	Number	Academic Year
Boys	173.1	628	15	1 <sup>st</sup> SS
Girls	165.8	54.04	15	1 <sup>st</sup> SS
Boys	176.4	70.9	15	2 <sup>nd</sup> SS
Girls	168.68	55.3	15	2 <sup>nd</sup> SS

## Results

Table 3. Level of motor learning and intelligence in boys and girls of 6<sup>th</sup> form

Boys	Level of ML Boys	IQ	Level of ML Girls	IQ
Average	2.3	107	1.9	108
Suma	34.3	1606	29.2	623
Minimum	1	98	1.3	98
Maximum	3.3	115	2.7	116

Table 4. Level of motor learning and intelligence in boys and girls of 7<sup>th</sup> form

Boys	Level of ML Boys	IQ	Level of ML Girls	IQ
Average	1.9	108	1.9	112
Sum	29.2	1623	28.3	682
Minimum	1.3	100	1	105
Maximum	2.7	116	1.3	119

Table 5. Level of motor learning and intelligence in boys and girls of 1<sup>st</sup> form of secondary school

Boys	Level of ML Boys	IQ	Level of ML Girls	IQ
Average	2.3	115	2.1	114
Sum	9.3	1723	8.3	1709
Minimum	2.2	103	1.9	105
Maximum	2.5	127	2.4	125

Table 6. Level of motor learning and intelligence in boys and girls of 2<sup>nd</sup> form of secondary school

Boys	Level of ML Boys	IQ	Level of ML Girls	IQ
Average	2.5	117	2.4	117
Sum	37.5	17511	36.3	1750
Minimum	1	105	1.7	105
Maximum	3.7	128	3.3	127

Table 7. Level of motor learning and IQ in all forms

Class	Boys		Girls	
	ML	IQ	ML	IQ
6.	2.3	107	1.9	108
7.	2.2	109	1.9	112
1. HS	2.3	115	2.1	114
2. HS	2.5	117	2.4	117
Average	2.3	112	2.1	112.75

From graph 1 it accrues that the highest level of motor learning was recorded in 7<sup>th</sup> form, while the lowest one in 2<sup>nd</sup> form of secondary school. However, it is necessary to state that the gymnastic element – cartwheel - in 2<sup>nd</sup> form of SS was probably the most demanding of all gymnastic elements performed by pupils. The overall level of motor learning of boys of all selected forms was on average 2.3, girls reached the average 2.1 and outmatched boys on average by 0.2, which is manifested in the following graph:

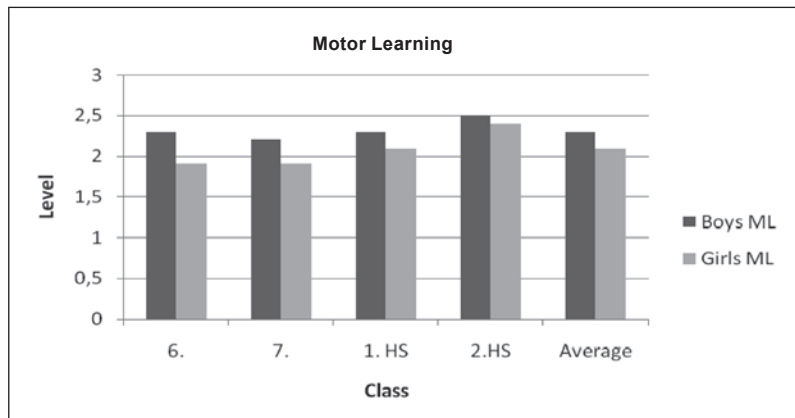

Graph 1. Comparison of the level of motor learning among individual forms

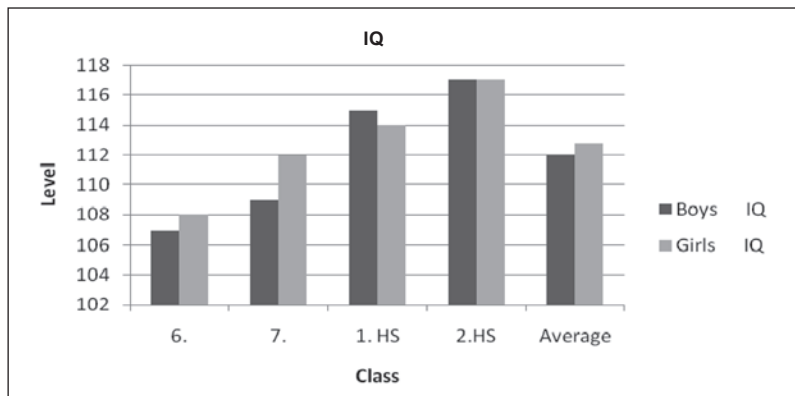

Graph 2. Comparison of the level of IQ among individual forms

The height of IQ was lowest on average in 6<sup>th</sup> form, reaching the value 108. The highest value of IQ was reached in 2<sup>nd</sup> form of SS - 117. It is possible to see in graph that the level of IQ changes with the growing age, which is confirmed also by psychologists. By measuring IQ in younger school age we found only the momentary level, which could, however, show an increasing tendency with the growing age. Intelligence in both sexes was almost equal on average: in boys reaching IQ 112, in girls 113. This finding confirms the presumption that intelligence does not depend on the sex.

For the assessment of the relationship Pearson's parametric coefficient of correlation was used. We inserted average marks of all years of study as well as the level of intelligence coefficient of both sexes in the equation. Correlation coefficient reached the value  $r = -0.29$ . According to Cohen's (1988) interpretation of correlation coefficients between the level of motor learning and IQ is only a slight relation, since the absolute level of measured coefficient ranges between 0.1 and 0.3. We expected that the relationship between the level of motor learning and IQ will be proved, however, the relationship was proved only in a minor degree.

We then presumed that no relationship between motor learning and IQ will be proved between sexes. The dependence between these two indicators was found using Pearson's coefficient of correlation – we compared the relationship of quantitative signs between sexes. In our case these were the tested level of motor learning and IQ.

In boys, correlation coefficient reached the value  $r = -0.34$ , which means that the relationship between the level of motor learning and intelligence is according to Cohen's interval 0.3–0.5 - moderate. Graph shows that the degree of dependence between the variables is low. From the following graph it is accruing that the degree of dependence between the variables is low.

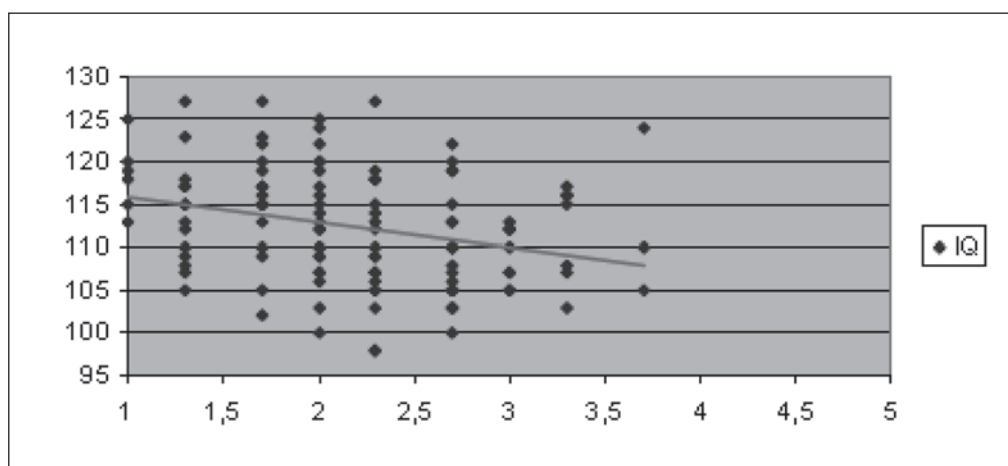

Graph 3. The degree of dependence between the level of motor learning and intelligence in both sexes

## Level of motor learning

The sum of averages expressing the level of motor learning in younger school ages was 8.3, in older pupils – 9.3. Pupils of younger school ages reached higher level of motor learning on average by 1. In girls a rather lower degree of dependence was found between the level of motor learning and IQ. The measured correlation coefficient reached the value  $r = -0.21$  and according to Cohen's interval 0.1–0.3 the dependence between the variables is low, which is supported by the graph.

## Discussion and conclusions

- In hypothesis 1 (H1) we presumed that there will be a positive relationship between the level of motor learning and intelligence. Based on the correlation analysis we found out that the level of correlation coefficient reached the level  $r = -0.29$ . This proves that between the level of motor learning and intelligence is only a minor dependence.
- In hypothesis 2 (H2) we presumed that the relationship between the level of motor learning and intelligence among sexes will not be proved. In boys we measured correlation coefficient  $r = -0.34$ , in girls  $r = -0.21$ . Between the level of motor learning and intelligence between both sexes was low degree of dependence, which supports our hypothesis.
- In hypothesis 3 (H3) we presumed that no differences in the level of motor learning will be found among boys and girls. This hypothesis was not proved, since girls outmatched boys on average in the level of motor learning in all years of study.
- In hypothesis 4 (H4) we assumed that pupils of younger school ages will have higher level of motor learning than the older pupils. This hypothesis was proved, since the level of motor learning in younger pupils was higher reaching the value 8.3, while the one in older pupils was 9.3.

## References

1. Azzopardi, G. 2005. *Řešíme úspěšně testy inteligence*. Praha : Portál, 2005. 215 s. ISBN 80-7178-951-8.
2. Belej, M. 1994. *Motorické učenie*. Prešov : Pedagogická fakulta UPJŠ, 1994. 197 s. ISBN 80-8068041-8
3. Gardner, H. 1999. *Dimenze myšlení : Teorie rozmanitých inteligencí*. Praha : Portál, 1999. 398 s. ISBN 80-7178-279-3.
4. Kršjaková, S. 1995. *Gymnastika hrou : (Materiály na semináře a cvičenia)*. Bratislava : Univerzita Komenského, 1995. 63 s.
5. Ruisel, I. 2000. *Základy psychologie inteligence*. Praha : Portál, 2000. 183 s. ISBN 80-7178-425-7.
6. Serebriakoff, V. 2000. *Ako ste na tom s inteligenciou?* Bratislava : Ikar, 2000. 156 s. ISBN 80-7118-815-8
7. Šimonek, J. 2005. *Didaktika telesnej výchovy*. Nitra : PF UKF, 2005. 112 s. ISBN 80-8050-873-9
8. Velenský, M. 1999. *Basketbal*. Praha: Grada Publishing, 1999. 107 s. ISBN 80-7169834-2

## EVALUATION OF THE DYNAMIC BALANCE TRACKING TEST

**Andrej Panjan**

*Wise Technologies, Ltd., Laboratory for Advanced Measurement Technologies, Ljubljana, Slovenia*

*University of Primorska, Faculty of Mathematics, Natural Sciences and Information Technologies, Koper, Slovenia*

### Abstract

The aim of this study was to evaluate two basic metric characteristics (repeatability and sensitivity) of the presented dynamic balance tracking test. The test is based on shifting the centre of pressure in medio-lateral direction while tracing predefined reference trajectory as precisely as possible. A group of twelve trained and a group of twelve non-trained subjects in dynamic balance participated in the study. Repeatability of all quantification parameters was assessed using results of both groups. Two types of sensitivity were tested: sensitivity between the two groups of subjects and sensitivity among different levels of difficulty using additional loads. Most of the parameters were highly repeatable, while results of sensitivity analysis varied among parameters. Results proved usefulness of the test for the evaluation of dynamic balance.

**Key words:** *equilibrium, repeatability, sensitivity, testing, assessment*

### Introduction

Balance is fundamental for human movement. Maintaining balance during anti-gravitational activities represent a ground-stone for the execution of any functional movements. Dynamic body balance is required for normal daily activities, such as walking, running or stair climbing, as well as for different sports activities. During dynamic balance tasks the equilibrium is maintained in three different situations: on a stable surface while body is moving (Munn, Sullivan, & Schneiders, 2010), on a moving surface (Allum & Shepard, 1999; Sarabon, Mlaker, & Markovic, 2010) or while the body is moving (Rao, Gillman, & Louis, 2011). All commonly used tests of dynamic balance are more or less simple (e.g. Star excursion balance test and functional reach test), except tests on specially designed machines.

In this experiment, we assess two basic metric characteristic of the test: repeatability and sensitivity. It is very important to evaluate basic metric characteristics of every new test, otherwise, we may give false or non-replicable conclusions (Panjan & Sarabon, 2010). Repeatability represents the variation of measures obtained by a balance measuring protocol, while sensitivity is a factor that is able to detect small, but important changes in performance of a subject.

The main aim of this study was to evaluate the newly developed dynamic balance tracing test which involves active centre of pressure (COP) tracking task. We evaluated intra-session repeatability and two types of sensitivity, in order to detect differences: (1) between two different groups of subjects (trained and not trained in dynamic balance) and (2) among different levels of difficulty, which was simulated by additional weight bearing on subject's shoulders.

### Methods

The experiment was divided into two sessions. Twelve healthy male professional Slovene skiers (trained in dynamic balance) (age  $19.8 \pm 2.7$  yrs, height  $181.5 \pm 5.1$  cm, weight  $83.9 \pm 8.1$  kg) participated in the first session. Twelve normal population subjects (not trained in dynamic balance) (age  $22.3 \pm 3.7$  yrs, height  $169.7 \pm 11.2$  cm, weight  $66.4 \pm 13.6$  kg) participated in the second session. Participants gave their written consent to participate in the study. All procedures conformed to the Declaration of Helsinki and were approved by the National Medical Ethics Committee (Slovenia). Before performing tests the whole procedure was presented in details to each subject separately.

In the first session, each subject (alpine skier) underwent a set of three tests with different levels of difficulty regarding loading with additional weights put on his/her shoulders. All three tests were carried out using the same body position of the tested subject: parallel stance (PS) with active position in knees ( $\sim 30^\circ$  flexion), arms on a bar, which was placed on the shoulders, and watching at the projection pane in front of the subject. Before the measurements began, the subject was exposed to a standard accommodation protocol (3 times 15 s) to become familiar with the movement task. First test was carried out with no additional weights but imitating the hand position using a wooden stick (NAW). The second test was performed with additional weight equal to half body weight (HAW), while during the third test the subject was holding additional weight equal to full body weight (FAW). Each subject performed three repetitions of each test (nine repetitions altogether) in random order to eliminate the effect of influence between tests. Each repetition took 30 s with at least 120 s rest intervals between trials. Subjects were asked to track reference trajectory as precisely as possible. Subjects in the second session performed only the NAW test by the same protocol as subjects in the first session.

The experiment was based on the newly developed dynamic balance test. The test was based on tracking of predefined dynamics with shifting COP in the medio-lateral direction. The predefined dynamics was defined by pseudorandom trajectory (reference trajectory). The reference trajectory was scaled to 70% of the maximum amplitude in medio-lateral direction for each subject separately which was assessed beforehand. The reference trajectory and COP of the examinee's body in medio-lateral direction were projected in real-time (time window 10 s, update rate 10 Hz) on a wall in front of the subject (Figure 1).

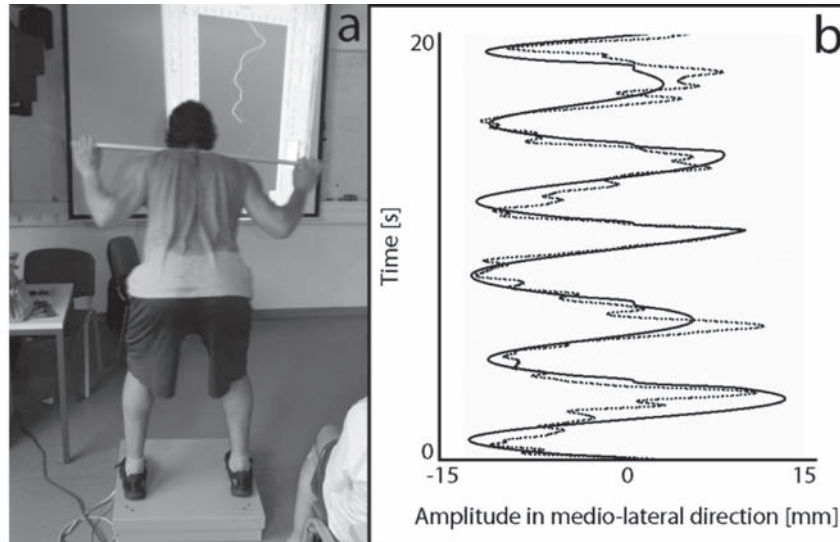

Figure 1. (a) A subject during the measurement. (b) Projection of the reference trajectory and real-time COP in medio-lateral direction.

The experiment was carried out with an AMTI force plate that can provide the information about the projection of COP. Signals were acquired with a standard personal computer at sampling rate of 1000 Hz. Pre-processing of signals consisted of filtering the signals with the band-pass Butterworth filter (low cut-off frequency was 0.1 Hz, high cut-off frequency was 20 Hz and order was 2). Custom made software used for the acquisition of the signals from force plate, making reference trajectory, projection on the wall and the analysis was developed in LabVIEW 2010. Statistical analyses were made with SPSS PASW Statistics 18 software. Reliability was assessed for the first test (NAW) with both groups of subjects. Calculated statistics were mean values (MV) and standard deviations (SD) of all trials together, minimum value, maximal value, typical error (TE), coefficient of variation (CV%), single (ICCs) and average (ICCa) intra-class correlation coefficients (two-way random model and absolute agreement type). Statistically significant differences across all three tests of the first session (additional load differences) were tested with one-way repeated measures ANOVA (RANOVA), while between tests differences were tested with t-test for dependent samples. Statistically significant differences between both groups of subjects were tested with t-test for independent samples.

Precision of tracking the reference trajectory was quantified with the following fourteen parameters: mean absolute error (MAE), standard deviation of absolute error (SDAE), root mean squared error (RMSE), area between trajectories (A), normalized error (NE), mean frequency (MF), median frequency (MEF), peak frequency (PF), number of zero crossings (NOZC), time driven on left side (TDL), time driven on right side (TDR), normalized error on left side (NEL), normalized error on right side (NER) and cross correlation (CC). Normalized error was calculated as  $\sqrt{\frac{\sum((R-M)^2/M_{amp}^2)}{T}}$ , where R is the real-time COP trajectory in medio-lateral direction, M is the reference trajectory,  $M_{amp}$  is the maximal amplitude of reference trajectory and T is the duration.

## Results

All results of repeatability analysis are presented in Table 1. Most of the observed parameters were highly repeatable (ICCa > 0.8), while only three (MEF, PF, NOC) were below this threshold. The highest ICCa and ICCs were observed for TDL and TDR parameters (0.93 and 0.82 respectively), followed closely by NEL, NE, CC and MF. CV% was the lowest for TDL and the highest for PF.



Table 1. Results of repeatability analysis. Mean score fields contain mean value  $\pm$  standard deviation; Range field contains minimum – maximum values; CV%, ICCs, ICCa fields contain value (confidence interval)

Parameter	Mean score	Range	TE	CV%	ICCs	ICCa
MAE	0.041 $\pm$ 0.012	0.024 - 0.088	0.0052	12.79 (10.40 - 16.62)	0.677 (0.461 - 0.833)	0.863 (0.719 - 0.937)
SDAE	0.030 $\pm$ 0.0090	0.018 - 0.076	0.0042	14.17 (11.52 - 18.40)	0.639 (0.423 - 0.807)	0.842 (0.687 - 0.926)
RMSE	0.050 $\pm$ 0.014	0.030 - 0.12	0.0064	12.59 (10.24 - 16.35)	0.672 (0.457 - 0.829)	0.860 (0.716 - 0.936)
A	1.21 $\pm$ 0.35	0.72 - 2.64	0.16	12.79 (10.40 - 16.62)	0.677 (0.461 - 0.833)	0.863 (0.719 - 0.937)
NE	6.57 $\pm$ 2.14	3.63 - 12.96	0.78	11.89 (9.67 - 15.44)	0.772 (0.588 - 0.888)	0.910 (0.811 - 0.960)
MF	0.34 $\pm$ 0.11	0.080 - 0.65	0.052	14.96 (12.16 - 19.43)	0.766 (0.600 - 0.881)	0.908 (0.818 - 0.957)
MEF	0.24 $\pm$ 0.11	0.033 - 0.60	0.084	34.42 (27.99 - 44.72)	0.536 (0.295 - 0.742)	0.776 (0.557 - 0.896)
PF	0.19 $\pm$ 0.11	0.00 - 0.60	0.11	55.13 (44.83 - 71.61)	0.251 (-0.001 - 0.528)	0.501 (-0.002 - 0.770)
NOZC	49.00 $\pm$ 23.32	10.00 - 125.00	17.05	34.80 (28.30 - 45.20)	0.484 (0.236 - 0.707)	0.738 (0.481 - 0.879)
TDL	0.57 $\pm$ 0.10	0.40 - 0.92	0.04	7.11 (5.78 - 9.24)	0.823 (0.688 - 0.912)	0.933 (0.869 - 0.969)
TDR	0.43 $\pm$ 0.10	0.075 - 0.60	0.04	9.34 (7.59 - 12.13)	0.823 (0.688 - 0.912)	0.933 (0.869 - 0.969)
NEL	5.01 $\pm$ 1.96	2.18 - 9.71	0.75	14.87 (12.09 - 19.32)	0.772 (0.594 - 0.887)	0.911 (0.814 - 0.959)
NER	4.08 $\pm$ 1.46	1.30 - 8.82	0.67	16.43 (13.36 - 21.35)	0.736 (0.545 - 0.867)	0.893 (0.782 - 0.951)
CC	0.69 $\pm$ 0.19	0.19 - 0.91	0.076	11.08 (9.01 - 14.40)	0.768 (0.576 - 0.887)	0.909 (0.803 - 0.959)

Table 2. Additional load differences and differences between the groups. NS – not significant, \* –  $p < 0.05$ , \*\* –  $p < 0.01$  and \*\*\* –  $p < 0.001$ .

Parameter	Additional load differences				Differences between the groups
	RANOVA	t-test for dependent samples			t-test for independent samples
		NAW-HAW	NAW-FAW	HAW-FAW	
MAE	***	***	**	***	NS
SDAE	***	*	**	**	NS
RMSE	***	***	***	**	NS
A	***	***	***	**	NS
NE	***	***	***	**	**
MF	***	***	***	*	NS
MEF	NS	NS	NS	*	NS
PF	NS	NS	NS	NS	NS
NOZC	**	NS	**	**	**
TDL	NS	NS	NS	NS	NS
TDR	NS	NS	NS	NS	NS
NEL	**	**	**	NS	***
NER	**	*	**	NS	NS
CC	**	**	**	NS	**

Statistically significant differences ( $p < 0.05$ ) across all three levels of difficulty for the first group of subjects were observed for MAE, SDAE, RMSE, A, NE, MF, NOZC, NEL, NER and CC; while MEF, PF, TDL and TDR were not statistically significantly different. Statistically significant differences between NAW-to-HAW and NAW-to-FAW were detected for the same parameters, except for NOZC between NAW-to-HAW. Statistically significant differences between HAW-to-FAW and more detailed results are shown in Table 2.

Statistically significant differences between groups of skiers and normal subjects were observed only for NE, NOZC, NEL and CC.

## Discussion and conclusions

Different quantification parameters describe different behaviours of the test, therefore, we cannot use only one parameter to evaluate one's performance. Parameters were classified into four groups, based on the type of evaluation of tracing performance.

The first group covers parameters that evaluate performance based on absolute deviations. MAE provides information about how close was the COP trajectory to the reference trajectory on average and SDAE is the variation of the performance. RMSE is similar to MAE, but it is more sensitive to larger deviations. For example, if two subjects have the same MAE and different RMSE, this means that they were equally good regarding their average performance, but the subject with greater RMSE had occasionally larger deviations from reference trajectory. The repeatability of the parameters in this group was high ( $0.84 \leq ICCa \leq 0.86$ ), but not among the highest. Based on sensitivity analysis, they are useful for detection of different levels of difficulty, however, they were not able to distinguish between subjects of different dynamic balance skills.

The second group consists of parameters that evaluate performance based on relative or normalized deviations. NE is deviation between the two trajectories normalized with reference trajectory amplitude and duration of the test. The second parameter (CC) in this group is well known and often used measure of similarity of two waveforms. Normalized CC with time-lag equal to 0 was used, since other time-lag values are not useful for the problem in this experiment. Both parameters had very high repeatability and successfully distinguished between well trained and non-trained subjects as well as between different levels of difficulty (except CC for HAW-to-FAW).

The third group includes parameters of frequency spectre. ME, MEF and PF were calculated from power spectrum of trajectory that was calculated as the difference between the reference and COP trajectory. This approach eliminates all frequencies that are present in the COP trajectory as a result of reference trajectory tracking. Only ME had very high repeatability and was able to distinguish different levels of difficulty, but not differences between the two groups of subjects. A reasonable explanation of the ability to distinguish different levels of difficulty could be that by bearing additional weight, subject's ability to shift COP changes significantly.

The fourth group consists of parameters that examine performance based on the side (left or right) of reference trajectory (NOZC, TDL, TDR, NEL and NER). NOZC had moderate repeatability and therefore, is not suitable for future analysis. Other parameters should not be used for sensitivity analysis, but due to their very high repeatability can be used to describe some subject's behaviours during the test. TDL and TDR could be used to describe if the subject has problems shifting COP from one side of the reference trajectory to the other side, while NEL and NER could evaluate the ability of tracking with subject's weight mainly on the left and right leg respectively.

In conclusion, we can say that the presented dynamic balance test quantified with described parameters is suitable for the evaluation of dynamic balance. All highly repeatable parameters are appropriate for the interpretation of results, but one has to be very careful to use them for the right purpose. CC and NE seem to be the most suitable for practical use. In our future studies, we will address inter-session repeatability and the influence of fatigue on tracking ability.

## References

1. Allum, J. H., & Shepard, N. T. (1999). An overview of the clinical use of dynamic posturography in the differential diagnosis of balance disorders. *Journal of Vestibular Research: Equilibrium & Orientation*, 9(4), 223-252.
2. Munn, J., Sullivan, S. J., & Schneiders, A. G. (2010). Evidence of sensorimotor deficits in functional ankle instability: a systematic review with meta-analysis. *Journal of Science and Medicine in Sport / Sports Medicine Australia*, 13(1), 2-12.
3. Panjan, A., & Sarabon, N. (2010). Review of Methods for the Evaluation of Human Body Balance. *Sport Science Review*, 19(5-6).
4. Rao, A. K., Gillman, A., & Louis, E. D. (2011). Quantitative gait analysis in essential tremor reveals impairments that are maintained into advanced age. *Gait & Posture*.
5. Sarabon, Nejc, Mlaker, B., & Markovic, G. (2010). A novel tool for the assessment of dynamic balance in healthy individuals. *Gait & Posture*, 31(2), 261-264.

## Acknowledgements

The operation is being partly financed by the European Social Fund of the European Union. The operation is implemented in the framework of the Operational Programme for Human Resources Development for the Period 2007-2013, Priority axis 1: Promoting entrepreneurship and adaptability, Main type of activity 1.1.: Experts and researchers for competitive enterprises.

## DIFFERENCES IN SAQ PERFORMANCE BETWEEN FUTSAL AND VOLLEYBALL PLAYERS

**Valentin Barišić<sup>1</sup>, Nebojša Trajković<sup>2</sup>, Zoran Milanović<sup>2</sup>, Aleksandar Joksimović<sup>2</sup>,  
Fredri Fiorentini<sup>3</sup>, Zlatko Šafarić<sup>1</sup> and Munir Talović<sup>4</sup>**

<sup>1</sup>*Faculty of Kinesiology, University of Zagreb, Croatia*

<sup>2</sup>*Faculty of Sport and Physical Education, Niš, Serbia*

<sup>3</sup>*Split, Croatia*

<sup>4</sup>*Faculty of physical Education and sport, University of Sarajevo, Bosnia and Herzegovina*

### Abstract

The aim of this study was to determine the differences in SAQ (speed, agility and quickness) performance between futsal and volleyball players. The research was conducted on a sample of 35 subjects divided in two groups: 20 futsal players (body weight 70.93±4.89 kg; body height 177.13±6.75 cm) and 15 volleyball players (body weight 79.13±6.83; body height 189.06±4.75). Sprinting performance was assessed using a 5m sprint, a 10m sprint and a 20m sprint. For the assessment of agility performance, T-test, Sprint 9-3-6-3-9 m with 180° Turns and Sprint 9-3-6-3-9 m with Backward and Forward Running were used. For the agility performance of players, in the T-test there was no statistically significant difference between futsal and soccer players ( $p = 0.522$ ). The other two tests (SBF and SBF180°) have showed statistically significant difference between futsal and soccer players. The values for the test S5M are very similar for volleyball and futsal players and without statistically significant difference ( $p=0.133$ ). On the other hand, there were statistically significant differences between futsal and soccer players for other two sprint tests (S10M and S20M). Based on our results, we can conclude that the futsal and volleyball players differ in the SAQ performance. Speed and agility methods should be included in a training program according to the needs of each sport. Because the straight sprinting speed has limited transfer to agility, coaches in volleyball are advised to implement specific agility drills to develop this component.

**Key words:** *team sport, sprinting, agility, training*

### Introduction

What the volleyball and futsal have in common is that they represent an intermittent high-intensity activity which is based not only of aerobic but also of anaerobic capacity of players. Dragomaci and Watsford (2006) has pointed out that futsal players spend 26% of time during the match in high intensity level, which is direct consequence of futsal rules that allow players more frequent changes. High-speed actions in futsal and volleyball can be categorized into actions requiring acceleration, maximal speed, or agility (Gambetta, 1996). It is believed that to improve their volleyball performance, players must arrange specific volleyball conditioning with some additional resistance and sprint and agility training (Scates and Linn, 2003).

The ability of athletes to make a quick movement of the entire body with a change of direction and speed of movement, known as agility (Sheppard and Young, 2006) may represent a basic component in team sports such as futsal and volleyball. Nowadays, elite volleyball players are quicker, stronger and in better physical condition than before which could be a result of year-round training and developing skills that add strength, power and fitness specific to their sport (Scates and Linn, 2003).

On the other side, SAQ method (Pearson, 2001) become very familiar for both, futsal and soccer players, and more often represented in training methodology. By implementing the use of SAQ, functional, and plyometric training principles, the low-skilled athlete may be better prepared for high-level play. The SAQ method brought a lot of advantages and innovations in the modern training system of the soccer and futsal players. The players have become familiar with the movement in which is present not only the acceleration but also the deceleration in combination with the quick change of direction and body control (Pearson, 2001).

There are few studies related to futsal with the objectives mostly based on physiological response of players (Castagna et al., 2007, Barbero-Alvarez, Soto, Barbero-Alvarez and Granda-Vera, 2008) or aerobic fitness (Barbero-Alvarez, D'Otavio, Granda-Vera and Castagna, 2009). Also, to our knowledge, there are no studies that compare men's futsal and volleyball players in speed, agility and quickness (SAQ) performance.

Therefore, the aim of this study was to determine the differences in SAQ performance between futsal and volleyball players.

## Methods

### Subjects

The research was conducted on a sample of 35 subjects divided in two groups: 20 futsal players (body weight  $70.93 \pm 4.89$  kg; body height  $177.13 \pm 6.75$  cm) and 15 volleyball players (body weight  $79.13 \pm 6.83$ ; body height  $189.06 \pm 4.75$ ). Futsal players in this research were taken from the first Croatian futsal league. Volleyball players are participating in the Second Division league in Serbia. All players were fully informed and they signed a consent form. The study protocol was held for every subject. Beside the results, the basic anthropometric parameters (body height and body weight) were registered in the study protocol. The tests were performed on the same day in the morning for all the subjects. The study was approved by the Ethics Committee of the Faculty of Kinesiology, University of Zagreb. Subjects were admitted in the study if they had a minimum training age of 3yr, engaged in strenuous training at least 10 h per week and were currently active in competition.

### Procedures

Body height and body weight were measured according to the instructions of the International Biological Program–IBP (Weiner & Lourie 1969). The body height was measured with a GPM anthropometer (Siber & Hegner, Zurich, Switzerland) to the nearest 0.1 cm. Body weight was obtained by Tanita BC 540 (Tanita Corp., Arlington Heights, IL) to the nearest 0.1 kg.

Sprinting performance was assessed using a **5m sprint** (S5M), a **10m sprint** (S1M0) and a **20m sprint** (S20M). The test was performed from a standing start and measured by means of infrared photocells (RS Sport, Zagreb, Croatia). Initially the subject stood with his rear (swing) leg on a contact mat. He was instructed to accelerate as quickly as possible through the timing gate positioned 20 metres from the starting line. The movement of the rear leg from the contact mat initiated a digital timer (resolution .001 sec). All tests used in this study were reliable and had good metric characteristics (Sporis, Jukic, Milanovic and Vucetic, 2010).

### T-test

Four cones are placed on the support as follows: first cone marks the start; second cone is placed 10 m ahead of the first one; third cone is placed 5 m right from the second cone, and fourth cone 5 m left from the second cone. On the examiner's signal, the subject runs forward from the first to the second cone, then side steps right to the third cone, then side steps left to the fourth cone, then side steps right to the second cone and run backwards to the first cone, thereby touching each cone with his/her hand. The test is discontinued when the subject touches the first cone;

Sprint 9-3-6-3-9 m with 180° Turns (SBF180°)

The players started after the signal and ran 9 m from starting line A to line B (the lines were white, 3 m long, and 5 cm wide). Having touched line B with one foot, they made either an 180° left or right turn. All the following turns had to be made in the same direction. The players then ran 3 m to line C, made another 180° turn, and ran 6 m forward. Then, they made another 180° turn (line D) and ran another 3 m forward (line E), before making the final turn and running the final 9 m to the finish line (line F).

Sprint 9-3-6-3-9 m with Backward and Forward Running (SBF)

The distance that the players had to cover was the same as in the previous test (SBF180°). The only difference was that instead of making a turn, the players shifted from forward to backward running. After the starting signal, they ran 9 m from starting line A to line B (the lines were white, 3 m long, and 5 cm wide). Having touched line B with one foot, the players shifted from running forward to running backward. Then, they ran 3 m to line C and changed from backward running to forward running. After 6 m, the players made another change (line D) and ran another 3 m backward (line E) and then made the final change and ran the final 9 m forward to the finish line (line F). The tests were performed from a standing start and measured by means of infrared photocells (RS Sport, Zagreb, Croatia).

### Statistical analysis

The statistical Package for Social Sciences SPSS (v11.5, SPSS Inc., Chicago, IL) was used for the statistical analysis. Descriptive statistics were calculated for all experimental data. Kolmogorov-Smirnov test was used to test if data are normally distributed. The significance of differences between volleyball and futsal players were determined by the Independent-Samples T test.

## Results

The Kolmogorov-Smirnov test showed that data was normally distributed. Basic statistical parameters has shown that volleyball players have greater values of body height and body mass (Table 1). The average body height of volleyball players was  $189.06 \pm 4.75$  cm and of futsal players  $177.13 \pm 6.75$  cm. The average body mass among volleyball players was  $79.13 \pm 6.83$  kg, while among futsal players  $70.93 \pm 4.89$  kg. Other descriptive parameters have shown that the futsal players achieved better results in tested variables for agility except for the T-test, where the average values for futsal player was  $9.08 \pm 0.27$  seconds and for volleyball players  $9.01 \pm 0.30$  seconds. Volleyball players have also showed better results for 5m sprint (S5M), where average values were  $1.31 \pm 0.12$  compared to futsal players ( $1.38 \pm 0.14$ ).

Table 1. Descriptive characteristics of Futsal and Volleyball players

	Volleyball players (N=15)		Futsal players (N=20)		Total (N=35)	
	Mean	Std. Deviation	Mean	Std. Deviation	Mean	Std. Deviation
<b>Body height</b>	189.06	4.75	177.13	6.75	182.24	8.40
<b>Body weight</b>	79.13	6.83	70.93	4.89	74.45	7.03
<b>S5M</b>	1.31	0.12	1.38	0.14	1.35	0.13
<b>S10M</b>	2.44	0.18	2.09	0.16	2.24	0.24
<b>S20M</b>	4.05	0.22	3.35	0.14	3.65	0.39
<b>SBF</b>	8.49	0.48	7.96	0.43	8.19	0.52
<b>SBF180°</b>	8.02	0.32	7.47	0.52	7.71	0.51
<b>T-test</b>	9.01	0.30	9.08	0.27	9.05	0.28

S5M - 5m sprint, S10M - 10m sprint, SP20 - 20m sprint, SBF - Sprint 9-3-6-3-9 m with Backward and Forward Running, Sprint 9-3-6-3-9 m with 180° Turns (S180°), T-test – Agility T test

For the agility performance of players, in the T-test there was no statistically significant difference between futsal and soccer players ( $p = 0.522$ ). The other two tests (SBF and SBF180°) have showed statistically significant difference between futsal and soccer players (Table 2). The values for the test S5M are very similar for volleyball and futsal players and without statistically significant difference ( $p=0.133$ ). On the other hand, there were statistically significant differences between futsal and soccer players for other two sprint tests (S10M and S20M).

Table 2. Deferences between Futsal and Volleyball players

	Sum of Squares	Mean Square	F	Sig.
<b>Body height</b>	1221.292	1221.292	34.069	.000
<b>Body weight</b>	575.476	575.476	17.130	.000
<b>S5M</b>	.044	.044	2.376	.133
<b>S10M</b>	1.042	1.042	33.019	.000
<b>S20M</b>	4.164	4.164	120.036	.000
<b>SBF</b>	2.355	2.355	11.288	.002
<b>SBF180°</b>	2.529	2.529	12.608	.001
<b>T-test</b>	.035	.035	.418	.522

S5M - 5m sprint, S10M - 10m sprint, SP20 - 20m sprint, SBF - Sprint 9-3-6-3-9 m with Backward and Forward Running, Sprint 9-3-6-3-9 m with 180° Turns (S180°), T-test – Agility T test

## Discussion and conclusion

Average values of players' body height and body mass in volleyball are slightly lower than the values of elite volleyball players, members of the national teams. Body height of futsal players is similar to the one found in the study conducted among Spanish professional futsal players. The study has also shown that Spanish players were slightly heavier (76.9 kg) (Esteban et al., 2009).

There was no statistically significant difference in the test S5M, where quick reaction of the players is essential for better results. Volleyball players are more often involved in situations where quick reaction and good anticipation skills are needed. Therefore, the results could be sustainable. Compared to volleyball players, futsal players have achieved better results in the S10M and S20M tests, and it was statistically significant ( $\leq 0.01$ ). Such results could be explained by the

differences in the playing field in futsal and volleyball. Futsal players are involved in sprints more often than volleyball players. On the other hand, situations where a volleyball player needs to run over 10 meters are rare. Both, futsal and volleyball players have similar motor characteristics of agility type. However, our results showed that futsal players have achieved better results in the tests SBF and SBF180°, while there were no statistical differences for the T-test. The explanation could be found in the structure of the t-test, where the lateral movement is more common for the actions in volleyball (block movement, defense, serve receive) than in futsal.

On the other hand, SAQ method (Pearson, 2001) become very familiar for soccer and futsal players, and more often represented in training methodology. The players have become familiar with the movement in which is present not only the acceleration but also the deceleration in combination with the quick change of direction and body control (Pearson, 2001). The SAQ method is still not fully accepted in volleyball training. It could be explained by the fact that its effects in volleyball are not represented by scientific researches.

Based on our results, we can conclude that the futsal and volleyball players differ in the SAQ performance. Although agility is one of the motor skills that is still unexplored, the possession of good agility performance reduces the injury risk and enhance sports performance (Foran, 2001). According to Young, McDowell and Scarlett (2001), exercises that are typically performed to enhance straight sprinting speed can be expected to be of limited value for the agility component of many sports. Therefore, coaches in volleyball are advised to implement specific agility drills to develop this component. Speed and agility methods should be included in a training program according to the needs of each sport. Limitation of this study was the fact that volleyball players were not familiar with SAQ training method. Therefore, it would be interesting to determine if there are differences between players of these two sports after the SAQ training program.

## References

1. Barbero-Alvarez, J.C., D'Otavio, S., Granda-Vera, J. and Castagna C. (2009) Aerobic fitness in futsal players of different competitive level. *Journal of Strength and Conditioning Research*, 23(7), 2163-2166.
2. Barbero-Alvarez, J.C., Soto, V.M., Barbero-Alvarez, V., & Granda-Vera, J. (2008). Match analysis and heart rate of futsal players during competition. *Journal of Sports Sciences*, 26, 63-73.
3. Castagna, C., Belardinelli, R., Impellizzeri, F.M., Abt, G.A., Coutts, A.J. and D'Ottavio, S. (2007) Cardiovascular responses during recreational 5-a-side indoor-soccer. *Journal of Science and Medicine in Sport*, 10, 89-95.
4. Dogramaci, S.N., & Watsford, M.L. (2006). A comparison of two different methods for time-motion analysis in team sports. *International Journal of Performance Analysis in Sport*, 6(1), 73-83.
5. Foran B. (2001). *High-Performance Sports Conditioning*. Champaign, IL: Human Kinetics.
6. Gorostiaga, E.M., Llodio, I., Ibáñez, J., Granados, C., Navarro, I., Ruesta, M., Bonnabau, H., & Izquierdo, M. (2009). Differences in physical fitness among indoor and outdoor elite male soccer players. *European Journal of Applied Physiology*, 106(4), 483-91.
7. Little, T., & Williams, A.G. (2005). Specificity of acceleration, maximum speed, and agility in professional soccer players. *Journal of Strength and Conditioning Research*, 19, 76-78.
8. Pearson, A. (2001). *Speed, Agility and Quickness for Soccer*. London: A & C Black.
9. Scates, A., & Linn, M. (2003). *Complete conditioning for volleyball*. Champaign, IL: Human Kinetics.
10. Sheppard, J.M. and Young, W.B. (2006) Agility literature review: classifications, training and testing. *Journal of Sports Sciences*, 24, 919-32.
11. Sporis, G., Jukic, I., Milanovic, L., & Vucetic V. (2010) Reliability and factorial validity of agility tests for soccer players. *Journal of Strength and Conditioning Research*, 24(3), 679-686.
12. Sporiš, G., Milanović, L., Jukić, I., Omrčen, D., & Molinuevo J.S. (2010). The effect of agility training on athletic power performance, *Kinesiology*, 42(1), 65-72.
13. Young, W.B., McDowell, M.H., & Scarlett, B.J. (2001). Specificity of sprint and agility training methods. *Journal of Strength and Conditioning Research*, 15(3), 315-319.

## SOME SPECIFICITIES DURING CONSTRUCTION AND VALIDATION OF A NEW INSTRUMENT FOR ASSESSMENT OF IMPORTANCE OF TECHNIQUES IN POLYSTRUCTURAL SPORT JUDO

Ivan Segedi, Hrvoje Sertić and Tihomir Vidranski

*Faculty of Kinesiology, University of Zagreb, Croatia*

### Abstract

The main problem of this paper is reduced to analyzing the peculiarities in validation of a diagnostic instrument for assessing the structure of the importance of throws in judo bout. In this new measuring device the eight judo experts assessed the importance of 60 judo throws within the 26 variables divided to a group of attacking variables and a group of defending variables. In the paper one discusses about the problem of determining reliability of obtained results and gives some suggestions how to increase it.

**Key words:** *reliability, validation, sport analysis*

### Introduction

The goal of any analysis of sport activity is detail assessment of importance of all characteristics, abilities and knowledge that are important for success in one sport. This analysis must help coaches and competitors in perfection of their training process and sport efficiency. Structural analyses is one of basic analyses of sport activities and it's complexity regards on type of sport activity. Scientific based assessment is one important step in determining the structure (technique and tactics) of one sport. As the complexity of sport increases, the importance of scientific based assessment increases also. Judo as the polystructural acyclic sport, that is conducted in variable conditions, belongs to sports of great technical and tactical complexity. In eight groups of technical elements of judo one can count over two hundred independent elements (Kuleš, 1991) and if one tries to combine them this number is multiply increases.

This paper analyse the group of most important and most used techniques in judo bout – techniques of throws (Sertić et al., 2007; Sertić et al., 2009).

The main goal of this paper is to identify and give scientific correct solutions to some problems that could occur during the construction and validation of a measuring device (questionnaire) that would give one a insight of an importance of judo throwing techniques in men judo bout.

### Methods

#### A) Procedure in determining sample of entities

For the purpose of assessing the actual position of each judo throwing technique one must choose throws that can be applied in judo bout. All throws must be in accordance with judo bout rules, and must be used for the purpose of achieving positive scores. Sample of entities for this research consisted of 60 judo throwing techniques that were in accordance with above mentioned rules. All other throws that exist in judo but are not in accordance to actual judo bout rules or are used to pull the opponent down in ground position without a chance of scoring a positive score were not a part of this research.

#### B) Procedure in determining sample of variables

For this kind of research variables are actually characteristics or specific situations of judo bout. How to identify main characteristics of judo bout and turn them into variables can be a very difficult manner. One must take into account only that situations that are constant and unchangeable. Of course that in complex sports exist many other situations but because they are not constant one can not take them into account. For this research sample of variables consisted of 26 variables (situations in judo bout) that were divided to variables of attack:

weight classes (up to 60kg, up to 66kg, up to 73 kg, up to 81kg, up to 90kg, up to 100kg over 100kg), age groups (juniors – JUN, seniors – SEN) and the opponent's mobility on the mat (opponent is moving forward – NAP, opponent is moving backward – NAT, opponent is moving diagonally forward – KNAP, opponent is moving diagonally backward – KNAT, opponent is moving to the side – STR, opponent is not moving – MJE). Second set of variables were called variables of defence against throws: defence by moving in a circle step back from the the opponent – TAI, defence by moving in

the direction of opponent's throw entry - KRE, defence by moving in other direction of opponent's throw entry - PRE, defence by stepping over the opponent's leg - PREK, defence by lowering one's center of body mass - SPUS, defence by pulling back the attacked leg - POV, defence by catching the opponent's hip - OB, defence by fixing the opponent's leg - UKLJE, defence by catching the opponent's leg - ON, defence by blocking with one's hands - BLOR, defence by bending down and moving one's hips behind - SPUS.

### C) Procedure in collecting data

This type of research is based on expert assessment of techniques in given variables. Experts in this case present items of the test. Unlike tests for assessment motor abilities one must have more than three items to ensure good reliability. In this research eight judo experts from Japan, Poland, Brazil, Italy and Croatia assessed the importance of 60 judo throws within the given variables giving the grades 1 (not important) to 5 (very important).

The data were processed with program Statistica for Windows 7.0 giving the descriptive parameters and K-S test for assessment of normality of distribution. For the assessment of reliability the analysis of *internal consistency was used and was expressed in the form of Cronbach alpha*.

## Results and discussion

Table 1. Descriptive parameters and K-S test of normality of distribution for variables of attack

VARIABLES	Mean	Minimum	Maximum	Std.Dev.	max D	K-S p
60KG	2,961	1,285	4,857	0,891	0,092	p > .20
66KG	2,995	1,285	4,857	0,896	0,086	p > .20
73KG	3,038	1,428	4,857	0,824	0,085	p > .20
81KG	2,978	1,285	4,571	0,780	0,089	p > .20
90KG	3,226	1,428	4,714	0,799	0,088	p > .20
100KG	3,157	1,142	4,857	0,856	0,093	p > .20
PLUS	2,933	1,400	4,800	1,016	0,152	p < .15
JUN	2,872	1,166	5,000	1,034	0,075	p > .20
SEN	3,428	1,571	5,000	0,919	0,078	p > .20
NAP	3,798	1,400	5,000	1,299	0,231	p < .01*
NAT	2,911	1,333	4,833	0,991	0,114	p > .20
KNAP	3,543	1,400	4,833	1,041	0,219	p < .01*
KNAT	3,002	1,400	4,800	0,943	0,185	p < .05*
STR	2,817	1,285	5,000	0,715	0,084	p > .20
MJE	3,297	1,333	4,500	0,744	0,163	p < .10

\*variables in which results aren't normally distributed

Table 2. Descriptive parameters and K-S test of normality of distribution for variables of defence

VARIABLES	Mean	Minimum	Maximum	Std.Dev.	max D	K-S p
TAI	2,614	1,714	4,571	0,793	0,193	p < .05*
PRE	2,090	1,400	4,400	0,768	0,263	p < .01*
KRE	1,963	1,000	4,400	1,021	0,309	p < .01*
PREK	2,606	1,000	4,800	0,939	0,097	p > .20
SPUS	2,869	1,000	4,833	1,222	0,150	p < .15
POV	2,892	1,428	5,000	1,156	0,179	p < .05*
OB	1,938	1,000	3,857	0,972	0,246	p < .01*
UKLJE	1,377	1,040	3,680	0,456	0,295	p < .01*
ON	1,740	1,000	4,400	0,703	0,212	p < .01*
BLOR	2,740	1,400	4,000	0,739	0,091	p > .20
SAV	2,576	1,200	3,600	0,643	0,152	p < .15

\*variables in which results aren't normally distributed



Table 3. Reliability coefficients (Crombach's alpha) for the attacking variables and for defence variables

ATTACKING VARIABLES	Crombach's alpha	DEFENCE VARIABLES	Crombach's alpha
60KG	.872	TAI	.826
66KG	.869	PRE	.796
73KG	.863	KRE	.891
81KG	.855	PREK	.714
90KG	.849	SPUS	.895
100KG	.849	POV	.891
PLUS	.855	OB	.925
JUN	.879	UKLJE	.850
SEN	.883	ON	.785
NAP	.902	BLOR	.686
NAT	.846	SAV	.633
KNAP	.877		
KNAT	.793		
STR	.738		
MJE	.762		
Mean reliability for attacking variables	.852	Mean reliability for defence variables	.808

Values of the coefficient of reliability for the attacking variables are between 0.738 to 0.903, and for the variables of defence between 0.633 to 0.925 (table 3). One can see that the mean score of reliability of the attacking variables is a little bit higher than in the defence variables.

There are few questions that one can ask about these results: 1. What is the lowest score that reliability can have to find the results statistically correct and 2. Why the defence variables have lower reliability score?

As the answer to the first question one must say that the lower limit of reliability for this kind of research has never been established. On the other hand one can compare these results with the methodologically similar researches. Although the obtained values of coefficient of reliability for the one part of variables are somewhat lower in comparison with other researches in which the data were collected in a similar way (Vuleta, 1997; Barišić, 2007) one must take in consideration that these researches analysed team games - soccer and handball, which are very different from the group of polystructural acyclic sports where judo belongs. Also, one must emphasize the role of selections of experts. All experts must have wide knowledge and experience in the analysed field. One must set the objective set of criteria for selection of experts. For this research all experts were from the different age group which is important because of different fighting experience they have. Objective assessment of importance or application of certain technique in a certain situation of judo bout is partially the result of individual experience. One can assume that if one have better fighting experience than the assessment can be better. Because during the time judo bout has changed (different time of bout, different categories, different judo clothes, different scores etc.) all of them have different fighting experience so their perception can be partially different.

All experts had their own way of fight and did use different techniques so this can be a reason for a decreased correlation between them.

Experts were from all around the world and they have learned judo in a way that is taught in their countries. All these countries (Poland, Japan, Italy, Brazil and Croatia) have their own way in consideration of specific judo situations and solutions. One can say that this was their country fighting style.

From all these reasons one can conclude that the level of correlation between the experts and, also consequently, the reliability of the results were still very high.

Answer to the second question probably lies in the complexity of the situation of defence.

To successfully apply any defence one must anticipate the opponent's attack, analyse possible reactions and in a part of a second react in the most optimal way. If the technique of defence is applied on time one can increase the chance of its success while the chance of success is reduced when the overall time of reaction (anticipation, analysis and application) increased. Also, one must take into account that every defence has its own characteristic moment of application. Consideration of the best moment of application of each defence from the angle of each expert can be different as well as consideration on applicability of each defence of technique of throw. Because, except one mentioned, there are many other factors that one must accept to give objective assessment of defences of techniques of throws (characteristics of throws, anthropological characteristics of competitors etc.) one can conclude that the lower reliability scores in defence variables are expected.

## Conclusion

Results of every sport analysis must serve sport experts for rational planning of the training process. Results of structural analysis must serve for selecting the most rational elements of technical and tactical preparation and for forming a new methodical procedures and approaches to the training process. One must seek for the optimal instruments for assessment sport activity and the reliability of the obtained results is one of the most important issues of that instrument. This paper had its goal to present some peculiarities in validation of a new diagnostic instrument for structural analysis in polystructural sport judo. Authors are hoping that this suggestions will help other researchers in their effort to find better solutions for the structural analysis of any sport activity.

## References

1. Barišić, V. (2007). Kineziološka analiza taktičkih sredstava u nogometnoj igri. (Doktorska disertacija, Sveučilište u Zagrebu). Zagreb: Kineziološki fakultet, Sveučilišta u Zagrebu.
2. Kuleš, B. (1991). Judo. Tribina, Zagreb.
3. Sertić, H., Segedi, I., Vučak, T. (2009). Technical efficiency of men judokas during the european championships (u 23) in Zagreb 2008. In Scardone D. (ed) Annals for the 6<sup>th</sup> International Science of Judo Symposium. Rotterdam, 20.
4. Sertić, H., Segedi, I., Žvan, M. (2007). Relations of certain anthropometric variables with the performance quality of throwing techniques in judo. Kinesiologia Slovenica, 13 (1), 48-60.
5. Vuleta, D. (1997). Kineziološka analiza tehničko-taktičkih sadržaja rukometne igre. (Doktorska disertacija, Sveučilište u Zagrebu). Zagreb: Fakultet za fizičku kulturu, Sveučilišta u Zagrebu.

## STRUCTURAL CHANGES OF TRANSFORMATION OF MORPHOLOGICAL AND MOTOR ABILITIES OF STUDENTS IN ADDITIONAL CLASSES

Muhedin Hodžić, Zrna Agačević and Naid Kadušić

*Faculty of Sport and Physical Education, University of Sarajevo, Bosnia and Herzegovina*

### Abstract

The subjects of this research are morphological characteristics and motor abilities of the chosen students, age between 14 and 16, included into the additional (after school) program and the boy-scout organization of Bosnia and Herzegovina too; and fortifying of the levels of morphological characteristics and motor abilities in their mutual correlation resulting from the accurately organized activity plan.

**Key words:** *changes, extracurricular activities, transformation*

### Introduction and problem

The foundation of almost every research concerning kinetics is the anthropological area, which above all is the segment that refers to defining structures and development of its integrated state as well as their correlation (Rađo and co., 2000.). Throughout its existence human being is subject to many internal and external factors, such as genetics, which determinate all biological properties. The complexity of human being is one of a kind experiment of nature so it is clearly logical that we are all very different from each others (Mekić and co., 1998.). We are individually diverse in physiological, biological and genetic terms.

The creation of class unit as a fourth segment of theme planning has basic condition to secure regular working degree and one must take care of utilities especially if results of initial state are taken in consideration. If transformational process is better and faster conducted and class unit well made then the impact of physical exercise is has more influence on the student's organism (Malacko and co., 1997.).

Our modern age has begun with the revolutionary development of informatics science, characterized by fast and enormous information current that, although having positive effects for informational exchange has a negative effect on human health since or care for our health and physical exercise has decreased. Physical activity can be very helpful when it comes to affecting student's anthropological state which ought to be primary in our work. One major characteristic of physical exercise as an educational process is that by using our nearest devices we can influence on morphological characteristics, motor abilities, functional abilities, cognitive functions, which implies influence on student's anthropological status (Hodžić, 1989).

In this research we will check **the subject** of research and that is morphological characteristics and motor abilities of students attending school of engineering in Zenica who are in additional classes (after school activities), and with specially established working plan to comprehend the relation of the two anthropological systems:

1. Set of morphological variables and
2. Set of motor abilities.

**The subject** of this research is morphological characteristics and motor abilities of students (age group is from 14 to 16 years old) attending school of engineering in Zenica who attend additional classes (after school activities) and are members of Scouts Union of Bosnia and Herzegovina, and the establishment of level of motor abilities and morphological characteristics that are interconnected by specially established working plan.

**The primary** problem of this research is development of morphological characteristics and motor abilities through physical education classes (after school activities), by increasing the number of weekly classes, precisely by two extra classes per week.

**The secondary** problem is establishment of significance, efficiency and the impact of influence made by the offered weekly model of work based on four school classes over the current weekly model based on two classes per week.

## Working methods

### Examinees

The research was conducted on 260 male examinees, aged 14 to 16, all students of Zenica' school of engineering, who were not selected by any special means and were divided into two groups: experimental and controlled group. All students are citizens of Bosnia and Herzegovina who are physically and mentally healthy without any impairment. The examinees are members of Scouts division "GREEN VALLEY" The number of the examinees is not based on any specific criteria and not related to any of motor or morphological abilities displayed by the students.

**The controlled group** is formed from 1<sub>2</sub>, 1<sub>3</sub>, 1<sub>5</sub>, 2<sub>1</sub>, 2<sub>3</sub> i 2<sub>5</sub> class students. This group worked according to two- hour model with their physical and health education teachers.

**The experimental group** is formed from 1<sub>1</sub>, 1<sub>4</sub>, 1<sub>6</sub>, 2<sub>2</sub>, 2<sub>4</sub> i 2<sub>6</sub> class students. This group worked according to four-hour model which means that they had **two additional** classes per week and were monitored by their physical and health education teachers. This group realized its working plan according to sports section curriculum (athletics, volleyball, basketball, handball and football) and thus had additional set of body tone exercises divided into three groups having 18 exercises repeated ten times. This group had monthly excursion to Smetovi on foot which is 16 kilometers in total.

### Variables

The tests have been selected based on up to date researches since they are suitable for this developmental level of the examinees (Bala and co. 1986). The choice of variables has been selected on the basis of their measuring characteristics; reliability, certainty, adjustability, economy and suitability of the age group of the examinees. Measuring was conducted at the beginning as well as at the end of the transformational treatment. **The eleven variables** for evaluation of **morphological characteristics** were used: three variables for longitude dimensionality of skeleton, three variables for circular dimensionality of skeleton and five variables for fatty issue.

**The fifteen variables** for evaluation of **motor abilities** were used: three speed variables, three coordination variables, three flexibility variables, three strength variables and three precision variables.

### Analysis methods

Structural changes were analyzed according to LSDIF, KRZANOWSKI and SCHONEMAN model of multiple structural changes in two states (Bonacin, 2004).

## Results and discussion

The choice of the examinees is the fundamental problem of every researcher in kinetics (Momirovic and co 1975). We should take care of developmental processes that can have very different effects in structural analysis of different anthropological entities. When it comes to establishment of latent structure of any extent, given the possibility of maximizing generalization of received results, the research is conducted with entities in stationary developmental phase. If we take a group of entities in stationary developmental phase and include only one criterion, it will not present particular problem to deal with for any researcher. It is more difficult to define population from which a representative entity sample should be taken that treats two or more anthropological entities in stationary developmental phase.

## Primary statistics indicators

Table 1. Primary statistics indicators

*E1.2 = Arithmetic middle (the experimental group) in initial and final measuring, K1.2 = Arithmetic middle (the controlled group) in initial and final measuring, E2-E1 = the difference of the experimental group's arithmetic middle, K2-K1 = the difference of the controlled group's arithmetic middle, D = total difference between groups, P = probability of variant analysis in initial measuring*

	E1	E2	K1	K2	E2-E1	K2-K1	D	P
AVIST	177.63	184.51	170.30	177.08	6.88	6.78	0.10	0.00
ADUR	73.37	76.19	70.07	72.84	2.82	2.77	0.05	0.00
ADUN	99.53	103.61	94.64	98.03	4.08	3.39	0.69	0.00
ATEZT	66.44	70.68	65.82	68.63	4.24	2.81	1.43	0.67
ASOGK	82.25	89.32	80.65	84.68	7.07	4.04	3.03	0.02
AONADK	47.30	52.18	48.58	49.95	4.88	1.38	3.50	0.00
AKNNL	12.17	9.00	16.12	15.95	-3.17	-0.17	-3.00	0.00
AKNLE	10.16	7.73	14.40	14.15	-2.43	-0.25	-2.18	0.00
AKNTR	13.90	9.77	17.83	17.30	-4.13	-0.53	-3.60	0.00
AKNNK	7.01	5.04	10.47	9.85	-1.97	-0.62	-1.35	0.00
AKNPK	14.73	10.40	15.89	15.63	-4.33	-0.26	-4.07	0.12
MBRTAP	42.68	48.01	40.46	42.56	5.32	2.10	3.22	0.00
MBRTAN	33.80	39.61	32.05	33.88	5.81	1.83	3.98	0.00
MBRTAZ	17.72	22.52	16.21	18.08	4.79	1.88	2.92	0.00
MKOKOP	15.31	11.56	15.36	13.58	-3.75	-1.78	-1.97	0.88
MKOONT	18.07	14.41	19.33	17.51	-3.67	-1.82	-1.85	0.00
MKOOUZ	5.15	3.92	5.36	4.89	-1.24	-0.47	-0.76	0.00
MFLISK	97.77	67.35	90.58	82.80	-30.42	-7.78	-22.64	0.00
MFLPRK	8.61	15.65	7.08	10.13	7.05	3.05	4.00	0.02
MFLSPA	164.00	175.71	168.25	175.28	11.71	7.03	4.67	0.03
MESSVM	256.15	278.28	240.93	248.49	22.12	7.56	14.56	0.00
MESSDM	194.72	220.12	204.32	215.98	25.39	11.65	13.74	0.00
MES20V	4.17	3.54	4.25	4.03	-0.63	-0.22	-0.41	0.20
MPPIK	25.90	34.74	24.78	25.66	8.84	0.88	7.95	0.13
MPGHCR	16.50	23.75	15.88	16.43	7.25	0.55	6.70	0.24
MPGVCN	17.18	23.35	16.38	16.92	6.17	0.54	5.63	0.05

Motor abilities are defined by the influence of those anthropological factors that determine the position of subject in extent. Positive position in these extents has very strong influence of the development of complex motor abilities while those motor abilities that take weak cortical processes intervention can develop under the influence of subject's physical exercise. Difference analysis of larger number of entities in multiple extents is always a sensitive issue because of complex system of examinees' abilities. The situation gets more complicated when it comes to professional sports since the number of examinees is smaller and they may not be described with the same parameter system. The basic methodology conditions are thus more difficult to choose and require special attention in order to make basic assumptions for serious multiple methodology that will provide results, conclusions and assumptions.

When we compare the primary statistics indicators from table 1 with the primary data we can see that the experimental group has better results with small similarities in six different states: body mass, bat coordination, 20 meters running, darts and aiming at the horizontal target wit ball. Later analysis showed that this group was mostly made of students from architecture department, chemistry department and electricity department. This means that the examinees from this group are from urban areas where they had a better physical and health education.

The two groups are not initially differentiated in above mentioned six states out of 26 variables. This kind of result would usually require rejection of data but luckily there was a solution: under the assumption that all data can be put into borders of the same scale and bring the entities in the same extent, it is possible to transform the results without any loss of information. This was done by rescaling the results in each group into universal range (Bonacin 2004), which gave us new referential system with irrelevant primary data because tit was transformed into a form which allows direct comparison according to all variables.

## Basic statistics indicators

### Initial measurement

Table 2 shows that initial differences between groups are reduced to maximum, the only differences clearly seen were: tapping, ground coordination, air coordination, the long jump and 20 meters running). The rest of the variables do not show any important differences so we can determine that the usage of universal range has enabled normal starting point for all statistics and mathematics procedures.

Table 2. Arithmetic middles of variables (XA), standard deviations (DEV) and variant analysis (ANOVA) with the F-test (F) and probability (P) for the experimental (E) and controlled (K) group, T = total

	XA				DEV				ANOVA	
	E	K	T		E	K	T		F	P
AVIST	2.97	2.93	2.95		0.74	0.80	0.77		0.18	0.68
ADUR	3.27	3.01	3.14		0.70	0.77	0.75		8.07	0.06
ADUN	3.23	2.96	3.09		0.70	0.85	0.79		8.13	0.06
ATEZT	2.57	2.47	2.52		0.76	0.79	0.78		1.13	0.29
ASOGK	3.76	3.72	3.74		0.76	0.52	0.65		0.23	0.64
AONADK	3.25	3.14	3.20		0.85	0.77	0.82		1.01	0.32
AKNNL	1.93	2.21	2.07		0.78	0.76	0.78		9.07	0.06
AKNLE	1.83	1.84	1.83		0.71	0.69	0.70		0.01	0.91
AKNTR	1.83	2.25	2.04		0.72	0.77	0.78		20.72	0.00
AKNNK	1.84	2.00	1.92		0.86	0.76	0.81		2.27	0.13
AKNPK	2.22	2.24	2.23		0.73	0.79	0.76		0.05	0.83
MBRTAP	3.24	3.47	3.36		0.74	0.70	0.73		6.78	0.01
MBRTAN	3.73	3.77	3.75		0.53	0.75	0.65		0.24	0.63
MBRTAZ	2.93	2.77	2.85		0.67	0.84	0.76		2.77	0.09
MKOKOP	3.61	3.51	3.56		0.72	0.69	0.71		1.19	0.28
MKOONT	2.85	3.31	3.08		0.87	0.78	0.86		19.98	0.00
MKOOUZ	3.18	3.49	3.34		0.77	0.88	0.84		9.11	0.00
MFLISK	2.97	3.09	3.03		0.94	0.92	0.93		1.16	0.28
MFLPRK	2.28	2.77	2.52		0.90	1.22	1.10		13.66	0.05
MFLSPA	3.34	2.27	2.80		0.62	0.59	0.81		19.43	0.06
MESSVM	3.35	2.61	2.98		0.75	0.65	0.79		71.18	0.06
MESSDM	2.73	3.54	3.13		0.80	0.74	0.87		71.68	0.00
MES20V	2.94	3.37	3.16		0.81	0.88	0.87		16.80	0.00
MPPIK	3.06	2.76	2.91		0.96	0.82	0.91		7.32	0.07
MPGHCR	3.33	3.06	3.20		0.93	0.67	0.82		7.31	0.07
MPGVCN	3.32	3.06	3.19		0.72	0.54	0.65		10.46	0.07
DF1,2									1	258

### Final measurement

Table 3 shows us that all the variables are very different and statistically they separate the two groups. The body mass, the long jump and the tow-rope do not show difference. It was determined that the usage of universal range was justified and the differences between the two states can be clearly seen, although at this level of analysis it is not possible to determine the various kinds of differences.

Table 3. Arithmetic middles of variables (XA), standard deviations (DEV) and variant analysis (ANOVA) with the F-test (F) and probability (P) for the experimental (E) and controlled (K) group, T = total

	XA				DEV				ANOVA	
	E	K	T		E	K	T		F	P
AVIST	3.24	2.65	2.94		0.65	0.63	0.70		53.43	0.00
ADUR	3.58	2.97	3.28		0.64	0.73	0.75		50.86	0.00
ADUN	3.51	3.00	3.26		0.62	0.60	0.66		44.50	0.00
ATEZT	2.79	2.65	2.72		0.76	0.73	0.75		2.03	0.15
ASOGK	4.21	3.83	4.02		0.37	0.51	0.48		46.70	0.00
AONADK	2.94	2.56	2.75		0.52	0.55	0.57		33.46	0.00
AKNNL	1.49	2.17	1.83		0.38	0.75	0.69		83.65	0.00
AKNLE	1.38	1.89	1.64		0.23	0.63	0.54		74.44	0.00
AKNTR	1.58	2.22	1.90		0.40	0.70	0.65		81.35	0.00
AKNNK	1.37	1.95	1.66		0.28	0.69	0.61		78.26	0.00
AKNPK	1.88	2.43	2.16		0.43	0.68	0.63		61.01	0.00
MBRTAP	2.94	2.23	2.59		0.62	0.53	0.68		94.65	0.00
MBRTAN	3.43	2.48	2.96		0.61	0.66	0.80		145.66	0.00
MBRTAZ	3.28	2.47	2.87		0.63	0.59	0.73		113.74	0.00
MKOKOP	3.64	2.88	3.26		0.66	0.85	0.85		63.75	0.00
MKOONT	4.36	2.88	3.62		0.32	0.70	0.92		479.12	0.00
MKOOUZ	4.54	3.13	3.84		0.25	0.74	0.90		422.26	0.00
MFLISK	3.67	2.94	3.30		0.78	0.88	0.91		49.23	0.00
MFLPRK	2.79	2.16	2.47		0.64	0.56	0.68		70.92	0.00
MFLSPA	2.73	2.72	2.73		0.47	0.58	0.53		0.05	0.82
MESSVM	3.79	2.57	3.18		0.62	0.64	0.88		239.35	0.00
MESSDM	3.77	3.67	3.72		0.52	0.63	0.58		2.02	0.15
MES20V	4.26	3.55	3.91		0.55	0.79	0.77		69.67	0.00
MPPIK	3.50	2.29	2.89		0.71	0.80	0.97		165.03	0.00
MPGHCR	4.23	2.90	3.56		0.67	0.77	0.98		219.07	0.00
MPGVCN	4.22	3.15	3.69		0.47	0.66	0.78		227.72	0.00
DF1,2									1	258

## Analysis of global structural (quality) changes

### LSDIF Analysis

Table 4. LSDIF analysis results

Stvarni trag matrice kvadrata razlika	=	50.043
Hi-kvadrat (funkcija traga)	=	6505.560
Stupnjevi slobode	=	26
Probabilitet	=	0.0000

It is well known that structural (quality) changes describe differences occurred as a result of influence of process on entity properties which is the main reason for different manifestations of variables in initial state.

LSDIF analysis (table 4) tests the hypothesis that in two different time points a process affected on relationship change as in this case did correlation on variables. As can be seen, the difference exists surely since the trace function is enormous (6505.56) so the probability is out of question (0.0000).

### Changes according to Krzanowski model

The results in table 5 show that similarities in two states are very small and that quality effects can be registered over the whole set of variables. The treatment brought many effects, but those structural are the most important ones because they are responsible for different correlation configuration.

Table 5. Structural changes according to Krzanowski model, *S* = similarities, *R* = differences

	<b>S</b>	<b>R</b>
AVIST	0.09	0.11
ADUR	0.07	0.73
ADUN	0.11	0.67
ATEZT	0.16	0.10
ASOGK	-0.23	0.52
AONADK	0.11	0.66
AKNNL	-0.01	0.91
AKNLE	0.09	0.71
AKNTR	0.03	0.82
AKNNK	-0.08	0.71
AKNPK	0.14	0.63
MBRTAP	-0.01	0.93
MBRTAN	0.15	0.61
MBRTAZ	0.01	0.88
MKOKOP	-0.05	0.78
MKOONT	0.19	0.56
MKOOUZ	0.26	0.49
MFLISK	0.08	0.72
MFLPRK	0.04	0.80
MFLSPA	-0.06	0.75
MESSVM	0.34	0.42
MESSDM	0.03	0.84
MES20V	-0.02	0.86
MPPIK	0.07	0.73
MPGHCR	0.02	0.86
MPGVCN	0.08	0.72

It seems that the variables for the evaluation of fatty tissue have undergone the serious changes, which is not surprising since any serious treatment is reflected on reduction of fatty tissue. The change of frequency variable is integrated in morphological-motor system and affects positively the efficiency of flexibility of body movement. Morphological variables that describe longitude less affect described changes probably because their character could not be changed.



### Changes according to Schoneman model

Table 6. Structural changes according to Schoneman model, *C* = structural coefficients, *S* = similarities, *R* = differences

	<b>C</b>	<b>S</b>	<b>R</b>
AVIST	5.94	0.50	0.50
ADUR	0.11	0.02	0.86
ADUN	-0.10	-0.02	0.87
ATEZT	4.60	0.77	0.12
ASOGK	1.09	0.18	0.57
AONADK	-0.05	-0.01	0.90
AKNNL	0.26	0.04	0.79
AKNLE	0.00	0.00	0.98
AKNTR	-0.02	0.00	0.95
AKNNK	0.44	0.07	0.73
AKNPK	-0.04	-0.01	0.92
MBRTAP	0.01	0.00	0.95
MBRTAN	0.20	0.03	0.82
MBRTAZ	-1.05	-0.18	0.58
MKOKOP	-0.65	-0.11	0.67
MKOONT	1.73	0.29	0.46
MKOOUZ	-0.34	-0.06	0.76
MFLISK	-1.20	-0.20	0.55
MFLPRK	-0.18	-0.03	0.83
MFLSPA	-0.39	-0.07	0.74
MESSVM	-0.82	-0.14	0.63
MESSDM	0.14	0.02	0.85
MES20V	-1.46	-0.25	0.50
MPPIK	0.09	0.02	0.88
MPGHCR	-0.59	-0.10	0.68
MPGVCN	0.58	0.10	0.69

Structural changes according to Schoneman model actually confirm everything that is said in Krzanowski model, except they put more stress on loss of the fatty tissue. The relationship between certain variables in definition of structural changes is stable and reliable and shows that changes in question are those concerning structure, and that quantity changes are the result of structural changes.

### Other Changes

#### Correlation of the same variables during two measurements

Table 7. Same variables correlations

AVIST	0.87
ADUR	0.92
ADUN	0.91
ATEZT	0.97
ASOGK	0.72
AONADK	0.73
AKNNL	0.88
AKNLE	0.77
AKNTR	0.93
AKNNK	0.80
AKNPK	0.86
MBRTAP	0.50
MBRTAN	0.61
MBRTAZ	0.67
MKOKOP	0.61
MKOONT	0.02
MKOOUZ	0.21
MFLISK	0.53
MFLPRK	0.56
MFLSPA	0.65
MESSVM	0.76
MESSDM	0.65
MES20V	0.55
MPPIK	0.50
MPGHCR	0.49
MPGVCN	0.32

There are many changes that are possible to detect, but in this case we have chosen few simple but illustrative indicators. One of them is correlation of the same variables during two different measurements (table 7). It can be seen that correlations are different across the whole set of variables used and at the same time differences are much greater in motor variables than in morphological variables.

## Structural changes

### Experimental group

Table 8. Differential structural changes in experimental group, KR = Krzanowski's model, SC = Schoneman's model, C = structural coefficient, S = similarities, R = differences, G = structural changes global measurings

	KR			SC		
	S	R		C	S	R
AVIST	0.12	0.88	AVIST	0.76	0.12	0.88
ADUR	-0.14	0.86	ADUR	1.05	0.17	0.83
ADUN	0.12	0.88	ADUN	0.47	0.08	0.92
ATEZT	-0.05	0.95	ATEZT	6.25	0.10	0.90
ASOGK	0.07	0.93	ASOGK	1.74	0.28	0.72
AONADK	0.07	0.93	AONADK	-0.02	0.00	1.00
AKNNL	0.00	1.00	AKNNL	0.00	0.00	1.00
AKNLE	0.01	0.99	AKNLE	0.87	0.14	0.86
AKNTR	-0.10	0.90	AKNTR	-0.12	-0.02	0.98
AKNNK	0.08	0.92	AKNNK	0.18	0.03	0.97
AKNPK	0.11	0.89	AKNPK	-1.24	-0.20	0.80
MBRTAP	0.22	0.78	MBRTAP	-0.08	-0.01	0.99
MBRTAN	-0.06	0.94	MBRTAN	2.20	0.35	0.65
MBRTAZ	-0.04	0.96	MBRTAZ	0.00	0.00	1.00
MKOKOP	0.08	0.92	MKOKOP	0.30	0.05	0.95
MKOONT	0.43	0.57	MKOONT	2.99	0.48	0.52
MKOOUZ	0.10	0.90	MKOOUZ	1.39	0.22	0.78
MFLISK	-0.01	0.99	MFLISK	0.35	0.06	0.94
MFLPRK	-0.03	0.97	MFLPRK	-0.03	-0.01	0.99
MFLSPA	0.02	0.98	MFLSPA	-0.30	-0.05	0.95
MESSVM	0.11	0.89	MESSVM	0.98	0.16	0.84
MESSDM	0.02	0.98	MESSDM	0.01	0.00	1.00
MES20V	-0.01	0.99	MES20V	-0.64	-0.10	0.90
MPPIK	0.02	0.98	MPPIK	-2.03	-0.32	0.68
MPGHCR	-0.06	0.94	MPGHCR	-0.84	-0.13	0.87
MPGVCN	0.14	0.86	MPGVCN	0.83	0.13	0.87
G		21.93	G			20.37

Based on the results in table 8 we can conclude that structural changes have come across all other variables, so the similarities after the two measurings are very small.

This is confirmed by LSDIF analysis in table 9 and it can be seen that serious changes have occurred.

Table 9. LSDIF analysis results for the experimental group

Stvarni trag matrice kvadrata razlika	=	9.48
Hi-kvadrat (funkcija traga)	=	616.48
Stupnjevi slobode	=	26
Probabilitet	=	0.0000

## Controlled group

Table 10. Differential structural changes in experimental group, KR = Krzanowski's model, SC = Schoneman's model, C = structural coefficient, S = similarities, R = differences, G = structural changes global measurings

	KR	
	S	R
AVIST	0.18	0.82
ADUR	0.18	0.82
ADUN	0.12	0.88
ATEZT	0.14	0.86
ASOGK	0.08	0.92
AONADK	0.20	0.80
AKNNL	0.10	0.90
AKNLE	-0.03	0.97
AKNTR	-0.02	0.98
AKNNK	0.06	0.94
AKNPK	0.09	0.91
MBRTAP	0.07	0.93
MBRTAN	-0.04	0.96
MBRTAZ	0.06	0.94
MKOKOP	0.02	0.98
MKOONT	0.22	0.78
MKOOUZ	0.17	0.83
MFLISK	0.03	0.97
MFLPRK	-0.08	0.92
MFLSPA	0.06	0.94
MESSVM	0.09	0.91
MESSDM	0.17	0.83
MES20V	0.04	0.96
MPPIK	0.08	0.92
MPGHCR	0.14	0.86
MPGVCN	0.08	0.92
G		21.25

	SC		
	C	S	R
AVIST	4.37	0.10	0.90
ADUR	0.08	0.02	0.98
ADUN	0.01	0.00	1.00
ATEZT	0.83	0.19	0.81
ASOGK	0.38	0.09	0.91
AONADK	0.45	0.10	0.90
AKNNL	0.02	0.00	1.00
AKNLE	-0.84	-0.19	0.81
AKNTR	0.01	0.00	1.00
AKNNK	-0.61	-0.14	0.86
AKNPK	-0.66	-0.15	0.85
MBRTAP	-0.82	-0.19	0.81
MBRTAN	1.02	0.23	0.77
MBRTAZ	0.65	0.15	0.85
MKOKOP	1.10	0.25	0.75
MKOONT	-0.78	-0.18	0.82
MKOOUZ	-0.10	-0.02	0.98
MFLISK	0.16	0.04	0.96
MFLPRK	0.22	0.05	0.95
MFLSPA	-0.81	-0.19	0.81
MESSVM	0.41	0.09	0.91
MESSDM	-0.13	-0.03	0.97
MES20V	0.18	0.04	0.96
MPPIK	-1.55	-0.36	0.64
MPGHCR	0.30	0.07	0.93
MPGVCN	-0.23	-0.05	0.95
G			20.68

Structural changes indicators in controlled group clearly identify the whole range of variables as potentially significant in understanding structural changes, so the similarities after the two measurings are minor. This situation is confirmed by LSDIF analysis in table 11. It can be seen that serious changes have occurred.

Table 11. LSDIF analysis results for the controlled group

Stvarni trag matrice kvadrata razlika	=	5.08
Hi-kvadrat (funkcija traga)	=	330.41
Stupnjevi slobode	=	26
Probabilitet	=	0.0000

**Correlation of the same variables**

The indicator of similarity in experimental and controlled group can be analyzed on basis of the correlation of same variables at the beginning and at the end of the treatment. Those data are shown in table 11. The correlations of experimental group are significantly smaller than those in controlled group, so it can be concluded that partial effects of transformational process are of greater intensity. It can be noticed that in experimental group kept 54.12 % of relation variables. The controlled group had a higher percentage of relation variables- 72.29% compared to initial state. This confirms that experimental group had significantly more changes.

Table 12. Correlations of the same variables, E = the experimental group K = the controlled group, G = global similarities measurement and percentage -%, D = group differences

	E		K		D
AVIST	0.94	AVIST	0.95		0.01
ADUR	0.95	ADUR	0.95		0.00
ADUN	0.90	ADUN	0.96		0.06
ATEZT	0.97	ATEZT	0.98		0.02
ASOGK	0.71	ASOGK	0.92		0.22
AONADK	0.61	AONADK	0.92		0.31
AKNNL	0.96	AKNNL	0.99		0.03
AKNLE	0.94	AKNLE	0.99		0.05
AKNTR	0.96	AKNTR	0.99		0.04
AKNNK	0.93	AKNNK	0.99		0.05
AKNPK	0.92	AKNPK	0.99		0.08
MBRTAP	0.64	MBRTAP	0.77		0.14
MBRTAN	0.77	MBRTAN	0.80		0.03
MBRTAZ	0.72	MBRTAZ	0.77		0.06
MKOKOP	0.55	MKOKOP	0.75		0.20
MKOONT	0.43	MKOONT	0.45		0.02
MKOOUZ	0.62	MKOOUZ	0.65		0.03
MFLISK	0.46	MFLISK	0.75		0.30
MFLPRK	0.78	MFLPRK	0.80		0.02
MFLSPA	0.83	MFLSPA	0.89		0.06
MESSVM	0.50	MESSVM	0.91		0.40
MESSDM	0.66	MESSDM	0.91		0.25
MES20V	0.57	MES20V	0.92		0.35
MPPIK	0.36	MPPIK	0.68		0.32
MPGHCR	0.42	MPGHCR	0.66		0.24
MPGVCN	0.20	MPGVCN	0.33		0.13
G	14.07	G	18.80		4.72
%	54.12	%	72.29		18.17

**Conclusion**

When it comes to establishment of latent structure of any extent, given the possibility of maximizing generalization of received results, the research is conducted with entities in stationary developmental phase. If we take a group of entities in stationary developmental phase and include only one criterion, it will not present particular problem to deal with for any researcher. It is more difficult to define population from which a representative entity sample should be taken that treats two or more anthropological entities in stationary developmental phase. Motor abilities are defined by the influence of those anthropological factors that determine the position of subject in extent. Positive position in these extents has very strong influence of the development of complex motor abilities while those motor abilities that take weak cortical processes intervention can develop under the influence of subject's physical exercise.

The **structure** of analyzed extent is important for understanding of transformational treatment effects since the changes reflect position and structure of latent dimensions. In this case the latent dimensions are main components rotated into varimax and promax position. During the initial measuring the five latent dimensions were easily differentiated:

- The **first** one represents mainly the growth of bones in length,
- The **second** one describes the fatty tissue,
- The **third** one describes the frequency and excitability,
- The **fourth** latent dimension represents the complex composition of coordination, precision and flexibility,
- The **fifth** one is unusual combination of flexibility, frequency and precision.

Based on factor correlations it can be noticed that connections between the latent dimensions are very weak and relatively low which means that morph-motor set in initial measuring is not connected very well. In final measuring evident changes occurred which can be registered at two levels: the first level refers to **latent dimensions configuration** where we register first factor as that is identical to second factor situation in initial measuring. There is no change in the second factor as well- the growth of bones in length. The second level is represented by simpler structure which has two types of motor governing: First type is described by one third of factors and has coordination as a dominating projection but contains other projections as well.

Structural-quality changes describe differences that are the result of affecting the entity's properties. When we analyze changes according to Krzanowski model we can see that under the treatment influence many changes have occurred. The structural changes are the most important ones because they are responsible for various correlations of variables. The fatty tissue evaluation variables have undergone a serious change as well as the frequency changes that are responsible for flexibility of body movement.

Analysis according to Schoneman model has confirmed everything described in Krzanowski model. Further analysis is possible and it shows a serious of changes between the initial and final states. The greater changes occurred in the motor abilities, which is normal and expected.

**The experimental** group show positive changes and had **positive results**. The most important characteristic of the treatment is the improvement of the flexibility of the body movement which is confirmed by the results in previous analysis. The additional classes of physical and health education had a great impact on the efficient body movement.

## References

1. Bala, G., Malacko J., Momirović K. (1986). Metodološke osnove istraživanja u fizičkoj kulturi, Novi Sad: Fakultet fizičke kulture.
2. Bonacin, D. (2004). Uvod u kvantitativne metode, Kaštela: Vlastito izdanje.
3. Hodžić, M. (1989). Ličnost se ogleda i u držanju tijela. /diplomski rad - studentski naučni rad, Nagrada Univerziteta u Sarajevu-fond „Hasan Kikić“. Sarajevo: Fakultet za fizičku kulturu.
4. Malacko, J., Popović, D. (1997). Metodologija kineziološko-antropoloških istraživanja, Priština: Fakultet za fizičku kulturu.
5. Mekić, M., Kazazović, B. (1998). Osnove naučnoistraživačkog rada u kineziologiji, Sarajevo: Fakultet za fizičku kulturu.
6. Momirović, K., Kurelić, N., Stojanović, M., Sturm, J., Radojević, D., Viskić-Štalec, N. (1975). Struktura i razvoj morfoloških i motoričkih dimenzija omladine, Beograd: Institut za naučna istraživanja Fakulteta za fizičko vaspitanje.
7. Rađo I., i sar. (2000). Antropomotorika - priručnik. Mostar: Univerzitet "Džemal Bijedić".

## INFLUENCE OF ANTHROPOLOGICAL FEATURES ON SPECIFIC BASKETBALL TESTS

Zulfo Aruković, Salko Huskić and Midhat Mekić

*Faculty of Sport and Physical Education, University of Sarajevo, Bosnia and Herzegovina*

### Abstract

The purpose of this study was to determine relationship between motor abilities, morphological characteristics and conative abilities with specific basketball tests.

Methods: for the purpose of this study 163 basketball players were tested. Morphological characteristics were tested with three tests: arm range (AR), leg length (LL), biacristial range (BR). Motor abilities were tested with five tests: 20m sprint (SP20), sit-ups (ST), pushups (PU), sting (ST), seat and reach (SR). Morphological characteristics and motor abilities were used as predictor variables and two specific basketball tests: direction changes with dribbling (DCD) and slalom dribbling (SD).

Results: to determine results in criterion variable DCD statistically significant were all morphological and motor variables tested (N=8). To determine results in criterion variable SD statistically significant were three tests.

Conclusion: For success in specific basketball test DCD important are power (SP20), strength endurance (ST, PU) and flexibility (ST, SR). For success in specific basketball test SD according to regression analysis important is only flexibility.

**Key words:** *basketball, regression analysis, anthropological features*

### Introduction

Basketball is one of the dynamic sports games. From the player requires the ability to oppose, gain better speed, explosive strength, agility, balance, vertical jump, good movement with the ball and without, the precision throwing the ball into the basket, the performance of technical and tactical tasks, and above all intelligence. According Gabrijelic 1977<sup>th</sup>, basketball is a complex sport that consists complex and simple motions in terms of cooperation, collaboration, performed by members of the team in the game. The main goal of the game of basketball is throw the ball in the opponent's basket, and prevent the opposing player to win or throw the ball in the basket. In their essence and structure of the game favored by players of certain anthropological characteristics and motor abilities, especially situational motoric (Tocić, 1998) (Naglić et al., 2010)

The purpose of this study was to determine relationship between motor abilities, morphological characteristics and conative abilities with specific basketball tests.

### Methods

Sample size: for the purpose of these study 163 basketball players aged 14 – 16 years were tested.

Sample of variables: Morphological characteristics were tested with three tests: arm range (AR), leg length (LL), biacristial range (BR). Motor abilities were tested with five tests: 20m sprint (SP20), sit-ups (ST), pushups (PU), sting (ST), seat and reach (SR). Morphological characteristics and motor abilities were used as predictor variables and two specific basketball tests: direction changes with dribbling (DCD) and slalom dribbling (SD).

Statistical analysis: Correlation is calculated using the Regression analysis and were tested for statistical significance at  $p < 0.05$ .

### Results and discussion

Regression analysis of the criterion variable direction changes in dribbling (DCD) provides information on the impact of treated anthropological variables on the success of results in a specific basketball test.

The predictor variables explained 42% (R-square = .418) shared variance with the criterion, and the measure of relationship of anthropological space as predictors with the criterion variable was coefficient of multiple correlation (R = 0.65), and the level of significance was  $p = 0.05$ .

Analyzing the impact of individual variables can be seen that the area of anthropology has 8 (eight) of the predictor variables of the system that shows a significant impact on the criteria by all variables tested: arm range (AR), leg length (LL), biacristial range (BR), 20m sprint (SP20), sit-ups (ST), pushups (PU), sting (ST), seat and reach (SR).

Regression analysis of the criterion variable SD-slalom dribbling provides information on the impact of treated anthropological variables on the success specific basketball test.

The predictor variables explains 47% (R-square = .464) shared variance with the criterion, and the measure of relationship of anthropological predictors with the criterion variable was coefficient of multiple correlation (R =0.68), and the level of significance was  $p = 0.05$ .

## Conclusion

For success in specific basketball test DCD important are power (SP20), strength endurance (ST, PU) and flexibility (ST, SR). For success in specific basketball test SD according to regression analysis important is only flexibility.

## References

1. Aruković, Z. (2008). Influence of morphological characteristics and basic motor-skills to success of the basketball game of basketball players aged 12-14 years, M.Sc.Work, Faculty of Sport and Physical Education, University of Sarajevo, Sarajevo.
2. Biberović, A. (2002). Static and explosive power of boys aged 7-9 years interms of types of proportionality body size, Tuzla, PhD thesis, Faculty of Physical Education and Sport.
3. Bukvic, O. (2003). The relations between the basic and specific motor-motor-basketball skills and their impact on the success in basketball. *Homo sporticus*, Vol 6, No. 1. Sarajevo.
4. Mekic, M. (2001). Effect of basic motor skills in precision injection ball into the basket in basketball, *Homo sporticus*, Vol 3, No. 1, Sarajevo,
5. Mekic, M. (2002). Effect of basic motor skills in adding precision in basketball, *Proceedings of, International Scientific Symposium*, Skopje.
6. Mikic, B., Nožinović, F., Mulabegovic, Š. (1997). The methodology of scientific research in physical culture-kinesiological Sciences, Tuzla, Philosophy Faculty.
7. Mikic, B. (1998). Basis of psycho-motor man, Tuzla, Faculty of Arts.
8. Sporiš, G. Naglić, V., Milanović, L., Talović, M. and Jelešković, E. (2010). Fitness Profile Of Young Elite Basketball Players (Cadets). *Acta Kinesiologica*, 4 (2), 62-68.
9. Separovic, V. (2001). The effect of the programmed level of acquisition of elements tehike basketball boys aged 11-13 years, Tuzla, Magistaski work faculty.



**6<sup>th</sup> INTERNATIONAL  
SCIENTIFIC  
CONFERENCE ON  
KINESIOLOGY**

**“INTEGRATIVE POWER OF  
KINESIOLOGY”**

# **Health Enhancing Physical Activity**





## **THE NATIONAL HEPA NETWORK IN SWITZERLAND – STEERING COMMITTEE, PLANS AND PROGRAMS, COOPERATION AMONG INSTITUTIONS, BODIES AND PERSONS**

**Eva Martin-Diener**

*Institute of Social and Preventive Medicine, University of Zurich, Switzerland*

### **Abstract**

#### **Introduction**

In Switzerland, activities in the field of physical activity and health started in 1995 with a national symposium at the Federal Office of Sports in Magglingen. Inspired by the Dutch example, the network “Health and Physical Activity Switzerland - hepa.ch”, the national network for the promotion of health-enhancing physical activity, was founded in 1999. The overall aims of the network are to improve health, well-being and quality of life of the population through the promotion of physical activity and sports. Approaches are to increase knowledge on physical activity and health, to promote communication and networking between network members and to integrate the promotion of health enhancing physical activity into other relevant policies.

#### **Organization of the network**

The heart of the network is the secretariat located at the Federal Office of Sports. The secretariat coordinates the network, is in charge of information exchange, organizes meetings and is responsible for the development of products. A steering board decides about strategic developments of the network. Members of the steering committee are the Federal Offices of Sports and Public Health, the foundation Health Promotion Switzerland and bfu - the Swiss Council for Accident Prevention. These four institutions finance the network (secretariat, products, meetings). Furthermore, there are three representatives of the member institutions in the steering board.

#### **Members of the network**

Currently, the network has some 110 members. A wide variety of institutions have become member over the years: administrative units from the federal, regional or local level, NGOs, foundations, associations, research and pedagogical institutions, the private industry or other networks.

#### **Program and products**

The most important elements for information exchange and networking are the two annual meetings, the website of the network and a newsletter. These basic services for the members are operated continuously. A key product of the network is the Swiss Base Document on Physical Activity and Health. Its first version was launched in 1999 inspired by the Dutch “Manifesto” and the document is revised periodically. The purpose of the base document is to increase knowledge and understanding of physical activity and health, to support consistent communication and to align members of the network towards the same overall ideas in HEPA promotion.

#### **Developments over a decade**

During the first years, increasing knowledge and understanding on HEPA promotion was the core activity of the network. In later stages also other topics such as nutrition or obesity came onto the agenda. Keeping members interested, developing new ideas and involving members to be active and not just consumers became the major challenges after the initial years.

Conclusions and outlook: Since 1995 there are HEPA promotion activities in Switzerland and as a constant over the years the network hepa.ch is still alive and currently in its thirteenth year. The base document on Physical Activity and Health has always been a key product. Challenges in the future will be to maintain the commitment of key organizations (steering committee) to support the network and to move from exchange to action.

Website of the network: [www.hepa.ch](http://www.hepa.ch) (available in German, French and Italian)

Swiss Base Document on Physical Activity Promotion and Health: [www.hepa.ch/internet/hepa/de/home/dokumentation/grundlagendokumente.parsys.25455.downloadList.57671.DownloadFile.tmp/hepaescreen.pdf](http://www.hepa.ch/internet/hepa/de/home/dokumentation/grundlagendokumente.parsys.25455.downloadList.57671.DownloadFile.tmp/hepaescreen.pdf)

## BASIC HEPA IMPLEMENTATION GUIDELINES

**Charlie Foster**

*Oxford, UK*

The prevalence and impact of physical inactivity is emerging as one of the largest public health problems throughout Europe. Increasingly the cost of treating chronic diseases and conditions will grow as health problems such as cardiovascular disease, diabetes, obesity and the premature decline of functional capacity continue to develop. The health, social and economic costs of a less active population across all ages are likely to rise as changes in occupation, transport, leisure time and the environment encourage the majority of the population to remain sedentary.

The lack of physical activity cannot be attributed solely to personal motivation and, considering the public health importance of this complex issue, many countries are aiming to increase the uptake of overall physical activity within the general population. Countries have initiated physical activity interventions at national, state, and the community level using single or multi-component approaches (that is informational, behavioural, and environmental).

Constructing a HEPA promotion system requires the cooperation of many different sectors of society and state. Once a HEPA strategy and plan is constructed the next phase of implementation can begin. The aim of this stage is to translate the plans for the HEPA programme into action. The key points relate to examples of good practice, found in addition to basic project management and monitoring. All the programmes shared common operational programme management procedures, including monitoring of the progress toward meeting objectives with specific indicators.

Typically actions could include (i) developing the organisational structure of the HEPA programme, (ii) establishing programme ownership with all participants, (iii) cultivating and tend the HEPA network, (iv) co-ordinate national and local activity, and (v) monitoring responsiveness to the national programme within different geographical and cultural groups.

## DEVELOPMENT OF PHYSICAL ACTIVITY RECOMMENDATIONS FOR HEALTHY CITIES IN THE CZECH REPUBLIC

**Zdenek Hamrik<sup>1</sup>, Michal Kalman<sup>2</sup> and Katerina Ivanova<sup>3</sup>**

<sup>1</sup>*Department of Recreationology, Faculty of Physical Culture, Palacký University, Olomouc, Czech Republic*

<sup>2</sup>*Institute of Active Living, Faculty of Physical Culture, Palacký University, Olomouc, Czech Republic*

<sup>3</sup>*Department of Social Medicine and Health Care Policy, Faculty of Medicine and Dentistry, Palacký University, Olomouc, Czech Republic*

### Abstract (1000 characters max)

The paper deals with the issues of developing public policy in the area of physical activity of municipalities involved in the National Healthy Cities Network in the Czech Republic based on the WHO Healthy Cities Project. The paper describes methodological aspects and the process of developing physical activity recommendations for the Healthy Cities in the Czech Republic. The authors use policy analysis approach, while the primary principles and methods are based on qualitative research. The results include descriptions of the methods used for developing recommendations (expert interviews, focus groups, etc.) and puts forward recommended approaches for public policy makers in the field of physical activity promotion.

**Key words:** *physical activity, health, public policy, guideline*

### Introduction

Currently, both advanced and developing countries of the world including the Czech Republic are facing a significant increase in overweight and obesity, cardiovascular diseases, type 2 diabetes mellitus, cancer, chronic respiratory diseases, etc. These diseases are collectively referred to as mass non-communicable diseases and their increased occurrence within the population closely correlates with changed lifestyle in the last hundred years, particularly with low physical activity levels, unhealthy diet, excess energy intake and increased use of tobacco products (WHO, 2004). According to OECD (2010)

71 % of adult population suffer excess weight, out of which 54 % are overweight and 17 % are obese. Obesity prevalence in children is 20 % and is still rising (OECD, 2010).

Cardiovascular diseases, cancer, diabetes and chronic respiratory diseases are the main cause of mortality and morbidity in the Czech Republic. In 2009, 54.1 thousand people died of cardiovascular diseases, which represented 50.4 % of all deaths (Institute of Health Information and Statistics, Ústav zdravotnických informací a statistiky – ÚZIS, 2009). Heart attack is the most common cause of death and disability in productive age men (Czech Society of Cardiology, Česká kardiologická společnost, 2000). Similarly, prevalence of diabetes mellitus in the Czech Republic is rapidly increasing. In 2009, of the total Czech population of 10.5 million, this disease was suffered by more than 783 thousand people, out of which 717,365 people suffered type II diabetes mellitus and 55,414 suffered type I diabetes mellitus. This represents an increase in the number of registered diabetics by approximately 10 thousand people compared with the previous year. Compared with 2000, the number is larger by 130 thousand diabetics (ÚZIS, 2009).

The level of physical activity (PA) in the Czech Republic is insufficient and decreases in the long term. Frömmel, Bauman et al. (2006) state that only 45.58 % of men and 26.93 % of women meet the requirements specified in “Healthy people 2010” for vigorous PA (i.e. at least 3 times a week and at least for 20 minutes), for moderate PA (at least 5 times a week for at least 30 minutes) the requirements are met by 31.32 % of men and 23.76 % of women; 24.62 % of men and 23.01 % of women in the Czech Republic do not pursue any vigorous PA; 19.19 % of men and 23.01 % of women do not pursue any moderate PA. Devotion to physical activity decreases with age, particularly in men. However, men are more active than women in overall terms. An HBSC study carried out in the Czech Republic by the Research Consortium of the Faculty of Physical Culture and the Faculty of Health Sciences of Palacký University, Olomouc and the National Institute of Public Health of the Czech Republic focussed on physical activity in children and shows that 28.4 % of boys and 23.4 % of girls of eleven year old schoolchildren spend at least an hour PA a day; 29.5 % of boys and 18.9 % of girls of thirteen year old schoolchildren and 24.4 % of boys and 13.9 % of girls of fifteen year old schoolchildren (Kalman, Hamřík et al., 2011).

According to WHO (2006) local governments play a key role in creating environment promoting PA opportunities for the citizens and active lifestyle. Leading representatives of cities and other competent officers can provide leadership, legitimacy and conditions for the development and implementation of policies promoting active lifestyle of all citizens. In the area of planning strategies focussed on active lifestyle and physical activity promotion in municipalities, local key

people and responsible departments must play a role; however, collaboration of private sector bodies and civil sector is required (Edwards & Tsouros 2008).

In the Czech Republic so far, there has been no guideline or document produced for municipality representatives, local authority officers or policy makers that would include recommendations to follow in the area of physical activity promotion.

The issues of health and healthy lifestyle promotion is actively addressed only by the National Healthy Cities Network in the Czech Republic, which tries to solve these issues through promotion of local health plans. The National Healthy Cities Network in the Czech Republic is an association of local governments who acknowledge the principles of sustainable development, engage the public in decision making and support healthy lifestyle of their citizens. The programme is based on the WHO Healthy Cities Project. Some municipalities involved in the Healthy City in the Czech Republic Project have presently local health plans made. These are generally aimed at improving health of the citizens and their methods are linked with a strategy of the Ministry of Health of the Czech Republic – a long term programme for improving health of the citizens of the Czech Republic – Health for All in the 21<sup>st</sup> Century (Health 21). According to Health 21, health plans are divided into the following areas – youth health, healthy ageing, decreased occurrence of non-communicable diseases, healthy and safe environment, healthier lifestyle, decreased alcohol, tobacco and drug related damage, and healthy local living conditions.

The aim of the paper is to introduce methodological aspects of developing PA recommendations for the Healthy Cities of the Czech Republic and thus introduce one of possible concepts for public policy making in this area.

## Methods

The methods of analysing and developing public policy can be divided into objective methods (non-normative) and evaluation methods (normative). Non-normative methods are based on positivist research methodology and their aim is a description and analysis of a problem or situation (Vesely & Nekola, 2007, 143). A normative approach, in addition, formulates desirable targets of a problem or situation as well as ways to reach those targets. “This target setting is value dependent by accepted norms and solution methods (paradigm).” (Vesely & Nekola, 2007, 144).

The research methods applied to development of recommendations were chosen with respect to the aim of the research and the fundamental research question: “What physical activity recommendations are suitable for municipalities in the Czech Republic?”

Objective methods within public policy perform data collection particularly through analysis of existing formal documents. “Content analysis is a quantitative research method for systematic and inter-subjectively verifiable description of communication contents based on scientific based questioning” (Schulz et al., 1998, 31). The core of the method is establishment and evaluation of the communication in terms of its form, author as well as recipient (Disman, 2002, 168). The establishment part is performed by unambiguous and clearly defined categories. The units established must be clearly measurable, constituting ‘record units’. The units can also be categorizable in a wider context, i.e. contextual units. In this way, units relating to words, sentences, the whole article, sources, authors, subjects a topics.

The following is required for content analysis:

- Determine a selection set,
- Identify a research unit, within which precisely and clearly determined criteria will be established,
- Determine and precisely describe monitored criteria,
- Determine the type of a recordable unit for each criterion (variable) – numerical or word entry. (Disman, 2002; Krippendorff, 2004).

The content analysis method was used during the first stage of recommendation development, which provided for objective bases for the second and third research stages.

Evaluation methods primarily use qualitative methodology, particularly free – non-standardized (or semi-structured) individual interviews with experts or non-standardized group interviews (so-called focus groups). A non-standardized interview allows familiarisation with a specific area of public policy among all involved (often expert) parties. A non-standardized interview is also a basic technique of the anchored theory method, which creates a novel view of the research issue in question by processing human responses. The focus group method, on the other hand, is a scientifically captured discussion technique around a given topic in groups. Using this technique requires knowledge around creating groups for a particular reason, selecting research environment, capturing what has been said, processing this type of research, results to be concluded and how (Disman, 2002; Ivanová, 2004). Semi-structured interviews with experts were used in the second research stage. Objective outcomes of the content analysis and evaluation outcomes of the expert interviews formed the basis for creating a discussion scenario for the third stage – focus group.

## Results

PA promotion guidelines will be used for creating 'local health plans', in which physical activity will be one of the priority topics. In terms of specific activities health plans include "soft" projects with no investment requirements (campaigns, interventions and programmes focussed on PA promotion, educational talks, events, etc.) as well as infrastructure investments. Such health plans are under way for example in the towns of Hodonín, Chrudim, Litoměřice or Vsetín. A very positive factor is towns interlacing health plans directly with local budgets; individual measures thus have financial allocations from the town budget and can be prioritized in the long run.

The purpose of developing the recommendations was to provide competent municipal representatives with sources for political decision making in the area of physical activity promotion and health plans development. The aim was also to enforce increased implementation of the issues of physical activity promotion into local health plans.

## Guideline creation process

**Stage 1 – Data content analysis:** existing secondary data (strategies, public policies, documents, public administration records, etc.) are considered key in developing public policy and have played a crucial role in developing physical activity recommendations. The documents were selected on the basis of the following preset criteria: documents written in Czech or English, documents dealing with the issues of PA promotion, policy documents of governmental or non-governmental profiled organisations. Available Czech as well as foreign literature in this area was used – dealing with the local level, development and implementation of strategies and recommendations around physical activity, administration of the public sector, towns and municipalities, and increasing the quality of services in the public sector. Special attention was paid to the documents of the World Health Organization – WHO, HEPA Europe, CDC and other organisations, National Healthy Cities Network, Local Agenda 21, Ministry of Education, Youth and Sport of the Czech Republic, Ministry of Health of the Czech Republic, National Institute of Public Health of the Czech Republic, etc. A valuable source for data analysis was an internal database of the World Health Organization – International inventory of documents on PA promotion. A total of 67 documents (42 foreign and 25 Czech) were analysed. The outcome of the content analysis was a discussion framework including specific topics for subsequent interviews with key participants (Stage 2).

**Stage 2 – Individual interviews with experts:** The outcome of the content analysis was a discussion framework, not consisting of a set of precisely defined questions but rather broader topics. The purpose was to maintain the interview unlimited and leave space for the key participants to talk about selected aspect of the topic in a wider sense considering various viewpoints. The more the researchers know and the better they are prepared before the interviews, the more we can gain from the interviews.

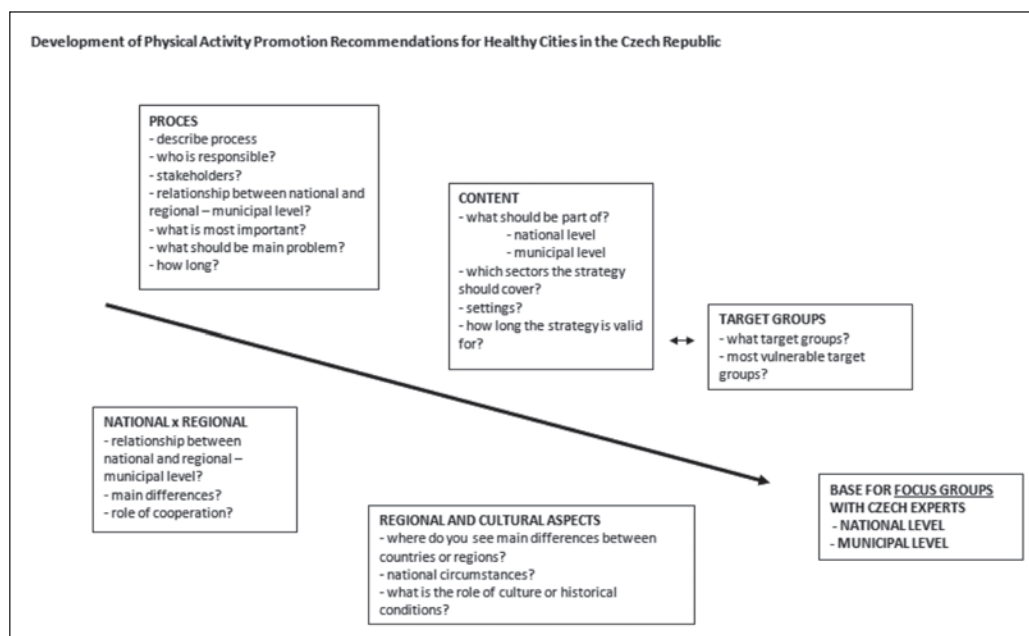

Figure 1. Expert interview discussion framework

Respondent selection was limited to persons – key participants – experienced in physical activity promotion and capable of producing an interview in English, Polish or Czech. A key participant means 1) significant representative of the public sector who is active or has been active in physical activity promotion at national or local level; 2) person who has coordinated or produced or significantly participated in developing a physical activity strategy, programme or intervention; 3) significant researcher with clearly registered articles in impacted periodicals or scientific books, certified methods and procedures or active participation at significant conferences. A total of 10 interviews ranging from 60 – 90 minutes were carried out with top experts on physical activity promotion from the following countries: Canada, Australia, Finland, USA, Switzerland, Great Britain, Germany, and Poland.

**Stage 3 – Group interviews with experts – stakeholders at local level:** Group interviews (focus groups) represented a more organized type of group discussion and were used for verification of suggested recommendations in practice at local level. A total of 3 focus groups were carried out, each time with 11 – 12 participants. Group interviews were attended by municipal officers significantly influencing the life of their municipality and development of physical activity policies – elected representatives, mayors, vice-mayors, members of committees, heads of departments (education, health, transport, etc.), representatives of sports clubs, professional and interest associations and NGOs, private sector representatives and others. They were experts active at the lowest levels of public administration, i.e. people with the closest contact with practice. The aim of group discussions was also to include the highest possible number of key participants influencing PA promotion at local level.

All performed individual and group interviews were recorded through digital voice recorders and all of them were transcribed verbatim. The interviews were analysed using Atlas.ti, which is a software programme specially designed for qualitative data coding and interpretation.

**M2:** Or any connection or relationship between, for example, national or Ontario health promoting strategy or physical activity promoting strategy? Any links or any...

**FC:** I'm not a public health expert. So I may defer to some of the... Monica Campbell or people who you met in public health. We have like ParticipACTION.

**M2:** Yeah.

**FC:** But it's kind of come and gone. But there's not a walking strategy.

**M1:** And do you cooperate with other cities?

**FC:** I would say, it's very interesting actually, Montreal has a better active transportation strategy. They've spent a lot of time and effort on their bike strategy. And are quite far ahead in some aspects. Particularly the development of pedestrian only zones. Vancouver...have you been to Vancouver?

**M2:** No.

**FC:** It's a beautiful city. It's a glorious city. And it's in a very lovely setting. So its whole culture is very focused on outdoors. So people their all hike and kayak. So it has a more of a physical activity culture...it's much like active transportation but more of a physical activity culture. But people still do commute quite long distances there. But they have been better at dense development than we have in the last ten years. You know, we're getting there, but we're still not great. So

Figure 2. Extract from a transcription with one of the respondents

## Discussion and conclusions

In the area of PA promotion public policy there has been no guideline in the Czech Republic advising on any measures to take at local level. The article states methods and procedures that can be applied to develop public policies at local level and, using the example of Development of PA Recommendations for Healthy Cities in the Czech Republic, tries to show a possible way of developing public policy in the area of PA promotion, which rests upon data content analysis, individual interviews with experts and group interviews with experts (focus groups). The procedure specified can serve as an example of possible way of dealing with these issues.

The results further imply that in public policy development the highest possible number of actors – key participants – must be involved. They must be analysed in line with their interests and involvement possibilities. In this way, possible rejection of a future strategy by subjects involved in target fulfilment will be prevented. A key success factor is to establish good relationships with these key participants. It is always necessary to analyse existing strategies, policies, regulations, decrees, standards, etc. – some might be of significant importance for physical activity promotion, although primarily focussed on a different sector. Any development of a strategy must be evidence based, supported by monitoring and interim evaluation of set goals (a good example for the youth is the HBSC study). The local level should, to a certain extent, copy what is going on at the national level, however, during strategy development, characteristic cultural and historical features of a specific locality must be taken into consideration.

We believe that this paper will become a good source for developing physical activity recommendations for municipalities in the Czech Republic and that the issues of physical activity promotion will be of higher priority within political agenda and public policy as a result of current society-wide trends. The authors try to provide relevant materials that will serve the process of public policy development and respective decision making. Based on the authors' experience, the methods and procedures specified above can be successfully used for developing policies aimed at PA promotion. The paper is included in the dissertation of both principal authors.

## References

1. Česká kardiologická společnost. (2000). *Národní kardiovaskulární program*. Praha: Česká kardiologická společnost.
2. Disman, M. (2002). *Jak se vyrábí sociologická znalost*. Praha: Karolinum.
3. Edwards, P., & Tsouros, A. (2006). *Promoting physical activity and active living in urban environments: The role of local governments*. Copenhagen: World Health Organization.
4. Frömel, K., Bauman, A. et al. (2006). Intenzita a objem pohybové aktivity 15 až 69 leté populace České republiky. *Česká kinantropologie*, 10(1), 13-29.
5. Ivanová, K. (2004). *Metody a techniky*. Ostravská univerzita, e-learningový text.
6. Kalman, M., Hamřík, Z. et al. (2011). Zdraví a životní styl českých školáků. Národní zpráva – mezinárodní výzkumný projekt Health Behaviour in School Aged Children 2010/11. *In press*.
7. Organisation for Economic Co-operation and Development. (2010). *Obesity and the Economics of Prevention: Fit not Fat*. Paris: Organisation for Economic Co-operation and Development.
8. Schultz, W., Hagen, L., Scherer, H., Reifová, I. (1998). Praha: Karolinum.
9. Ústav zdravotnických informací a statistiky ČR. (2009). *Zdravotnická ročenka České republiky*. Praha: Ústav zdravotnických informací a statistiky ČR.
10. Veselý, A., & Nekola, M. (2007). *Analýza a tvorba veřejných politik; přístupy, metody a praxe*. Praha: Sociologické nakladatelství.
11. World Health Organization. (2004). *WHO Global strategy on diet, physical activity and health*. Geneva, World Health Organization.
12. World Health Organisation. (2006). *Promoting Physical Activity and Active Living in Urban Environments*. Geneva: World Health Organisation.

## HEPA AND SRM COOPERATION – A WIN-WIN APPROACH

**Stjepan Heimer**

*Faculty of Kinesiology, University of Zagreb, Croatia*

Appropriate regular daily physical activity is a major component in preventing chronic disease, along with a healthy diet and not smoking. For individuals, it is a powerful means of preventing chronic diseases; for nations, it can provide a cost-effective way of improving public health across the population. Available experience and scientific evidence show that regular physical activity provides people, both male and female, of all ages and conditions - including disabilities - with a wide range of physical, social and mental health benefits. Physical activity interacts positively with strategies to improve diet, discourage the use of tobacco, alcohol and drugs, helps reduce violence, enhances functional capacity and promotes social interaction and integration.

### WHO statements are:

- Physical activity is a fundamental means of improving people's physical and mental health. It reduces the risks of many non-communicable diseases and benefits society by increasing social interaction and community engagement. Physical activity is not just a public health issue; it also promotes the well-being of communities and the protection of the environment, and comprises an investment in future generations.
- Appropriate regular physical activity is a major component in preventing the growing global burden of chronic disease.
- At least 60% of the global population fails to achieve the minimum recommendation of 30 minutes moderate intensity physical activity daily
- The risk of getting a Cardiovascular disease increases by 1.5 times in people who do not follow minimum physical activity recommendations.
- Inactivity greatly contributes to medical costs - by an estimated \$75 billion in the USA in 2000 alone.
- Increasing physical activity is a societal, not just an individual problem, and demands a population-based, multi-sectoral, multi-disciplinary, and culturally relevant approach.

### Key facts on physical activity in the WHO Europe Region

- Every year, physical inactivity is responsible for 600 000 deaths in the European Region (about 6% of the total), and overweight and obesity cause over 1 million more.
- Physical inactivity accounts for 5.3 million disability-adjusted life-years (DALYs - about 3.5% of the total) in the European Region.
- More than half of the European Region's population is not active enough to meet health recommendations.
- In particular, two thirds of the adult population (people aged over 15 years) in the European Union (EU) do not reach recommended levels of activity (30 minutes/day on most week days). On average, only 31% of respondents in a European survey reported sufficient physical activity.
- The trend in the European Region is towards less activity, not more.
- Only 34% of European young people aged 11, 13 and 15 years reported enough physical activity to meet current guidelines. In most countries, boys were more active than girls and activity declined with age in both sexes.
- Proportions of active young people vary widely between countries, ranging from 11% of girls and 25% of boys in France to 51% of girls and 61% of boys in Ireland among 11-year-olds. Similar variations existed among the other groups; for example, the proportion of active 15-year-old boys was 49% in the Czech Republic and 25% in Portugal.
- Inequalities between countries are rising, with those in the eastern part of the European Region bearing the heaviest burden.
- Different socioeconomic groups also show inequalities: poorer people have less free time and poorer access to leisure facilities, or live in environments that do not support physical activity.
- Emerging estimates of the direct (health care) and indirect costs of physical inactivity (loss of economic output due to illness, disease-related work disabilities or premature death) are alarming. On the basis of two studies, in Switzerland and the United Kingdom, physical inactivity can be estimated to cost each of the European Region's countries about €150-300 per citizen per year.
- On the basis of two studies, in Switzerland and the United Kingdom, physical inactivity can be estimated to cost each of the European Region's countries about €150-300 per citizen per year.



## HEPA - Health Enhancing Physical Activity

In 2005 the European Network for the Promotion of Health-Enhancing Physical Activity (HEPA Europe) was founded. The aim was to respond to the noticeable lack of a platform for sharing the development and implementation of evidence-based policies and strategies in the field of physical activity and health.

Activities of the network support cooperation, partnerships and collaboration with other related sectorals, activities and approaches.

The term “health-enhancing physical activity” is frequently used across the European Region. It emphasizes the connection with health by focusing on “any form of physical activity that benefits health and functional capacity with undue harm of risk.

### HEPA – Objectives:

1. to promote a better understanding of health enhancing physical activity and to give a stronger voice to physical activity promotion in health policy and in other relevant sectorals in Europe, including support for workforce development
2. to develop, support, and disseminate effective strategies and multi-sectoral approaches in the promotion of health-enhancing physical activity
3. to foster the preservation and creation of social and physical environments as well as values and lifestyles supportive of health-enhancing physical activity
4. together with other relevant institutions and organizations, to improve coordination in physical activity promotion across sectorals and administrative structures.

### HEPA and SRM cooperation

Here we come to the complementary area of HEPA and sport-recreation medicine and to the need of indispensable cooperation in very broad area:

- in scientific research;
- in routine;
- in common education system from volunteer up to the university level;
- in common policy and activity planning;
- in common activity towards politicians, GO and NGO;

#### In scientific research:

- common scientific projects in HEPA
- common laboratory research and field surveys
- common development of research methodology
- common presentation of scientific evidences

#### In routine:

- health and physical ability checking and determining of possible health contraindications of SR entering middle age and older persons;
- joint work in SR counsel units - health, functional and motor diagnostics, counseling and directing to the most appropriate program or club;
- counseling in specific health states:
- PA in pregnancy
- PA of elderly
- PA of persons with special needs
- PA of mentally retarded persons
- persuade or dissuade the physical-medicine preventive procedures:
- showers
- massage,
- sauna,
- Turkish bath,
- ultra-sound,
- aero-ionization.
- solarium,
- others

**In common education system from volunteer up to the university level:**

- basic courses for volunteers in Sport for all;
- advanced and specialized courses for experienced volunteers and professionals;
- curriculum development of professional study
- curriculum development of university study
- curriculum development of doctoral study.

**In common policy and activity planning:**

- intervention activities in micro- (individual and family), middle- (schools, factories, companies, settlements, community) and macro- levels (county, national);
- quality managing activity in Sport for all and in sport-recreation units;

**In common activity towards politicians, GO and NGO:**

- lobbying for political and social support;
- lobbying for official public-health service support;
- lobbying for laws and regulations;
- struggle for the favor in public information media;
- struggle for stakeholders and sponsorships.

**Conditions of HEPA and health service cooperation**

The basic condition of HEPA and health service cooperation is mutual recognition of professional competence and quality level. As the health service in all developed countries has the given quality frames, it is just to make a short insight into the essential quality characteristics of HEPA centers and programs.

**Essential HEPA quality criteria**

1. *Holistic approach to health* based at the main aims of health sport.
2. *Specification of program planning* according to target groups, health effects, contents, method of teaching; a manual or at least a framework-plan should be available.
3. *High qualification requirements of instructors*: the instructors have to go through a special education that focuses on “prevention” or “rehabilitation”. They also have to take part in further education every two years.
4. *Organizational requirements*: each program has to be carried out at least once a week with a minimum unit-length of 60 minutes; the number of participants is limited to 20; the rooms and gymnastic halls as well as the teaching aids have to be appropriate.
5. *Imparting / conveying of know-ledge* on health and regular feedback to the participants.
6. *Controlling of effects* of the program via physiological testing and questionnaires to the participants.

**Conclusion**

1. For such cooperation the certain quality criteria have to be fulfilled.
2. There are many public health, professional, economical, social and other reasons for joint work of HEPA and SRM on different organizational levels.
3. In some European countries good examples of such cooperation already exist.
4. This cooperation approved as a win-win approach.

<b>HEPA AND SRM PARALLEL OPERATIVE COOPERATION LEVELS</b>	
<b>HEPA SYSTEM</b>	<b>HEALTH SYSTEM</b>
SPECIAL COMPLEMENTARY HEALING PA PROGRAMS	CLINICAL CONDITIONS AND INDICATIONS
SPORT CLUBS FOR HEALTH PROGRAMS (TARGETED PRIMARY AND SECONDARY PREVENTION) SPORT CLUBS FOR HEALTH PROGRAMS (TARGETED PRIMARY AND SECONDARY PREVENTION)	HEPA MEDICAL COUNSEL (MEDICAL EXAMINATION, FUNCTIONAL AND MOTOR TESTING)
SELF-ELECTED INDIVIDUAL NON ORGANIZED PHYSICAL ACTIVITY; SPORT FOR ALL CLUBS WITH GENERAL EXERCISE PROGRAMS	PRIMARY CARE PHYSICIANS (GENERAL SUGGESTIONS AND RECOMMENDATIONS FOR PA)

<b>HEPA NAD SRM PARALLEL AND VERTICAL COOPERATION IN HEPA PROMOTION</b>	
<b>HEPA</b>	<b>HEALTH SYSTEM</b>
NATIONAL SPORT FOR ALL AND HEPA ASSOCIATIONS (COMMON NATIONAL POLICY PLANING WITH HEALTH SYSTEM)	DEPTS IN MINISTRIES OF HEALTH AND SPORT AND NATIONAL PUBLIC HEALTH INSTITUTE (COOPERATION WITH SCIENTIFIC INSTITUTES AND NATIONAL LEVEL STAKEHOLDERS; PERSONNEL EDUCATION SYSTEM)
EUROPEAN REGIONAL (COUNTY) SFA AND HEPA ASSOCIATIONS (COMMON EUROPEAN REGIONAL POLICY PLANING WITH HEALTH SYSTEM)	HEPA OFFICERS IN COUNTY HEALTH ADMINISTRATION AND PUBLIC HEALTH INSTITUTES (COORDINATION WITH SFA, OTHER SECTORALS AND STAKEHOLDERS)
LOCAL SPORT FOR ALL (SFA) AND HEPA ASSOCIATIONS AND CLUBS (APPROPRIATE HEPA POLICY AND PROGRAMS OFFER)	HEPA OFFICER IN LOCAL HEALTH ADMINISTRATION (COORDINATION WITH SFA, OTHER SECTORALS AND STAKEHOLDERS)

## References

1. European Commission White Paper on Sport; (2009). 2. The societal role of sport; 2.1 Sport, physical activity and public health
2. EU Working Group "Sport & Health", (2011). EU Physical Activity Guidelines. Recommended Policy Actions in Support of Health-Enhancing Physical Activity.
3. Hartmann, H. (2006). Quality Criteria And Quality Control In HEPA Programs. Lecture in Zagreb
4. Heimer, S. i M. Rakovac (2005). Sport-recreation medicine supports Sport for all. Lecture at the Sport for all conference of SEE countries. Belgrade.
5. Physical activity and health in Europe: evidence for action (2006). Edited by: Nick Cavill, Sonja Kahlmeier and Francesca Racioppi WHO Europe.
6. World Health Organization. (2003). Global strategy on diet, physical activity and health.

## LIFESTYLE PHYSICAL ACTIVITY AND HEALTH

**Ilkka Vuori**

*UKK Institute for Health Promotion Research in Tampere, Finland*

This presentation aims to answer the following questions: What is lifestyle physical activity (LSPA)? What are the differences between, sports, exercise, and LSPA? Why to consider LSPA in connection with HEPA? Can LSPA's benefit health? Do LSPA's benefit health in real life conditions? Is lifestyle physical activity more feasible, i.e. easier to adopt and maintain than exercise in HEPA promotion?

Lifestyle is defined as a bundle of conventional behaviors that make sense to both oneself and others. A lifestyle typically reflects an individual's attitudes, values or worldview.

Lifestyle physical activities can be defined as physical activities that a person chooses or is obliged to do conventionally in his/her life. If chosen voluntarily, these physical activities may and often do reflect one's attitudes and values towards physical activity itself (e.g. non-motorized, non-polluting) as well/or its effects (e.g. pleasure, health, self-image or image among others). LSPA's are often means to achieve something in the course of daily life, and done mainly or partly for reasons other than physical activity itself. Examples of voluntarily chosen LSPA's are walking for pleasure, dog walking (for men!), stair climbing, walking or bicycling to work or errands, domestic chores (repair and maintenance, cleaning, gardening, especially without motorized tools), hiking, fishing, picking berries, golf, geocaching. Examples of partly voluntarily chosen LSPA's are walking or bicycling to work or errands, domestic chores, dog walking, stair climbing. Examples of non-voluntary LSPA's are walking or bicycling to work or errands, domestic chores, dog walking (for women!), stair climbing. Thus, a LSPA can be practiced for many reasons on different basis.

What are the differences between sports, exercise, and lifestyle physical activity? Sport is organized, usually competitive, entertaining, and skillful activity. Sports are governed by a set of rules or customs, and winner and loser can be defined by objective means. Exercise is planned, structured, repetitive and purposive with the objective to improve or maintain physical fitness, functional capacity, or health. Lifestyle physical activity is usually non-organized, non-structured and non-competitive, often done for other purposes than physical activity itself, often done habitually as part of daily life. However, exercise and even sport can be lifestyle activities.

Characteristics of LSPA's include the following: type, intensity, duration, and energy expenditure are highly variable; frequency and regularity can be highly variable (in Finland 25 % of adults participate in dog walking, in average on 248 days/year, and in berry picking 7.6 times/year); often fluctuating intensity of variable duration, but mean intensity is typically low or moderate; total energy expenditure accumulated in LSPA's may be substantial; many LSPA's include aerobic and resistance – even stretching – components. Due to these characteristics assessment of LSPA's requires special methodology and instruments, and until now LSPA's have not been assessed reliably and comprehensively in observational studies or described in details in clinical trials.

Why to consider LSPA's as part of HEPA? Some of the reasons are that LSPA's may cause substantial energy expenditure thus contributing to prevention of obesity, LSPA's may influence health in comparable ways to exercise, they may be especially beneficial to mental wellbeing, be easier to adopt and adhere to than exercise, be a realistic option to be physically active for people who do not have motivation, abilities or opportunities for exercise, and they may contribute to better environment (less use of fuels, less pollution, less need of special sites etc.).

Can Lifestyle Physical Activities Benefit Health? If LSPA's meet the requirements of the current physical activity recommendation regarding intensity (at least moderate), regularity and frequency (continuously several times a week), and duration (at least half an hour a day in one continuous or several at least 10 minute bouts), LSPA's alone can be sufficient to produce health enhancing effects. Regular brisk walking or cycling on errands or to work are examples of those LSPA's. Many, if not most LSPA's do not meet all of the mentioned requirements. An example is stair climbing. The intensity and frequency can be sufficient, but the total duration and the duration of separate bouts of the activity remain short. In clinical trials stair climbing has induced health-enhancing biological changes, but there are no studies testing whether these changes translate to clinical health outcomes. Thus, the health enhancing potential of most LSPA's practiced alone remains uncertain. However, all of them counteract the deleterious effects of physical inactivity and contribute to energy expenditure. If the intensity is at least moderate and the duration of the bouts at least 10 minutes, the activity can be counted as part of the recommended physical activity. Thus, being active in various, at least partly moderate intensity LSPA's during the course of the day one can accumulate sufficient daily dose of physical activity for health.

Do LSPA's benefit health in the real life conditions? The evidence based on prospective epidemiological studies shows significantly lower risk of e.g. cardiovascular disease mortality associated with the volume or pace of walking. The rather

few studies on the association between cycling and cardiovascular disease morbidity and mortality show mixed results, but suggest that regular cycling may decrease the risk of these diseases. The results of the few studies regarding domestic chores are mixed, possibly due to inclusion of low intensity activities in part of the studies. On the basis of evidence from experimental studies, clinical trials and prospective observational studies it is logical to conclude that LSPA's even alone, without e.g. structured exercise regimen, do benefit health if they meet the established criteria of health-enhancing physical activity. Furthermore, recently published evidence suggests that even smaller amount than the recommended amount 150 min/week of at least of moderate intensity physical activity decreases the risk of e.g. cardiovascular disease,.

Is LSPA more feasible, i.e. easier to adopt and maintain, than structured exercise? This is a common assumption, and it was one of the reasons to include short bouts of physical activity in the public health recommendations on physical activity in 1995. In this way a broader array of physical activities would qualify as part of the recommended activity. The few studies comparing lifestyle and structured physical activity do not show any significant differences in the adoption of and adherence to physical activity, and their effects on cardio-respiratory fitness and selected cardiovascular risk factors were comparable. This evidence is not sufficient to make firm conclusions on the feasibility of LSPA's in terms of adoption and adherence as compared to structured exercise programs. The numerous attempts to increase the use of stairs and escalators have demonstrated the difficulty to change permanently even easily adaptable habits. However, all evidence taken together on the health enhancing efficacy and effectiveness, feasibility and social desirability related to LSPA's warrant their promotion for individual and community health. Furthermore, LSPA's and structured exercise programs are often not options, but LSPA's are the only practical alternative. This is especially true in underprivileged populations, in which there are various barriers to engage in structured exercise and in which lack of sufficient physical activity for health is often prevalent.

In conclusion, lifestyle physical activities are an important domain of physical activity, because they offer a wide array of activities that can be incorporated in daily life of large numbers of people and practiced continuously. These activities include a substantial potential to benefit physical and mental health as well as the physical and social environment. This potential has to be taken in wider use, if the lack of physical activity in most populations and population groups will be decreased in large scale and permanently, because structured exercise and sports are only parts of the solution. However, lifestyle activities should not be seen as one entity, because they include a large array of activities with very different characteristics regarding the type, intensity, duration, frequency, regularity, motivation, reasons, and conditions in which they are practiced. Consequently, their effects on individual, community, and environmental health as well as the conditions in which they can be practiced vary greatly. Much more research is needed to gain detailed knowledge related to various LSPA's to be used in promoting them at individual level and to develop and implement policies to increase opportunities to engage in them.



# Late Submissions

**6<sup>th</sup> INTERNATIONAL  
SCIENTIFIC  
CONFERENCE ON  
KINESIOLOGY**

**“INTEGRATIVE POWER OF  
KINESIOLOGY”**



## RELATION BETWEEN MUSIC AND PHYSICAL TRAINING

Željko Kovač

University of Mostar, Bosnia and Herzegovina

### Abstract

The purpose of this paper is to research the relation between music and physical training. This research gives a review of recent research on: influence, change, effect and promotion of music in: sport, physical training and health. What is important is to give answers to many questions on mechanism of music and movements. Music can help us to feel exercises more like recreation, and less like work. The four main hypotheses that describe in what way music makes exercises easier include the following: reducing the feeling of tiredness, enlarging the level of psychological excitement, physiological relaxing response and music as the way of improving of body movements and coordinations. Recent research tries to confirm the psychotherapeutic benefit of music: the influence of music on breathing and heartbeat, influences of various kinds of music on physical strength, influences of music and rhythmic stimuli in rehabilitation of walking disorder, influence of music on endurance of performance, influences of music on learning basic motoric abilities, and influence of music on aerobics.

The research has shown that music as a therapy can be useful for: reducing stress and anxiety, help people to sleep better, reduce pain, expressing feelings, improving memory, improving communication, and promoting physical rehabilitation. Different studies have also shown that music therapy can have a positive impact on people with chronic diseases, f.e.: music therapy can reduce the number of heartbeat and blood pressure, reduce stress as one of the main factors of risk for heart diseases and Diabetes. Music can creatively influence on autistic people, it can prevent social isolation of people diagnosed with Parkinson disease, it can also have a therapeutic influence on people diagnosed with depression. It can help in improving memory and speaking with people diagnosed with Alzheimer disease.

Music therapy is widely used in: hospitals, nursing homes and schools. Music provides the use of a particular programme as calming and stimulating. This research has also shown that music is effectively used in practice with working with different groups of people who use it for physical training to professional sportsmen.

**Key words:** music, physical training, sport, health, research review

### Introduction

In the last 20 years there has been a rising number of research on relation between music and physical training. The qualitative analysis of review of the original research on relation between music and physical training has shown a multifunctional impact and function of music on participants, such as enjoying of participants. The analysis presents a review of relation between music and physical training which contains a series of new and modern research. Music has a potential to improve the quality of public health. Some answers should be given on influence of music on fitness industry.

### Methods

The research analysis is aimed at promotion, implementation, use, influence, and function of music in: sport, physical training and health. The review of original research on relation between music and physical training in the period from 1990 till 2010 includes more than 50 scientific papers and 79 scientists, as well as 2 scientific papers from 1980s and a few papers from earlier period. The data have been collected via many secondary sources and online papers by the year 2010 have been used as well.

### Results

One of the first studies researching the influence of music on physical training was published by Copeland i Franaka (1991), who concluded that slow music could give useful results in reducing physiological and psychological excitement during training, which could improve endurance at training. Mertesdorf (1994) claimed that the majority of examiners tended to listen to optimistic kind of music, because it made training easier. He also claimed that music improved mood, self-confidence, as well as personal effectiveness for training.

Kravitz (1994) claimed that music reduced tiredness while training. It is thought that that mechanism is more effective at lower level of training. At higher level of training, music can not reduce internal signs of tiredness. It is suggested

that bass in music can improve normal walking allowing individuals to find out the desired speed of walking. Rhythm and percussion as auditive signs can have a positive influence on co-ordinated walking.

Macnay (1995) suggested a few successful intervention programmes for helping in reducing the risk for people suffering from heart diseases and cardiovascular system diseases. Such programmes included some form of aerobics. One of the interventions studied by the researches was the impact of music on improving effort during training, but it also improved positive feeling.

Dwyer (1995) examined participants selected at random and they were told to choose the desired type of music. The evaluation showed that those participants had got a better grade in comparison with those who had not chosen the desired type of music. The participants who thought that they had improved aerobics by choosing the desired type of music had shown more positive feeling while training.

Brownley, Murray, and Hackney (1995) concluded that listening to the music while training could be useful for untrained runners, because of lack of desire for moving in comparison with those who were trained.

Karageorghis, Drew and Terry (1996) concluded that simple task, such as motoric strength of making a fist gave a sensitive measure of psycho-physical effects of music.

Karageorghis and Terry (1997) claimed that music enlarged the level of excitement, which resulted in enlarging the number of exercises. It was concluded that some types of rhythmic music improved and spread bruto-motoric tasks, which resulted in improving the efficiency of exercises.

Chen (1985), Jernberg (1981) claimed that music could improve gaining motoric abilities and could create better surroundings for studying. There is some evidence in Gymnastics and Swimming that can confirm that.

Karageorghis, Terry, and Lane (1997) claimed that rhythmic response and musicality were internal factors for music content, while culture influence and joining were external factors for music in personal interpretation of music.

Our research has shown that internal factors are more important in explaining a person's reaction to music content.

Karageorghis and Terry (1997) said that music also gave an ideal escort for training.

Scientific research has found out 5 most important ways in which music can influence on preparations and competition performances: disociation, excitement regulation, sincronisation, gaining motoric abilities and training results. During submaximal training, music can reduce attention, and redirect the mind from feeling of tiredness. Recently, Szmedra i Bacharach (1998) conducted a study to examine the effects of music on personal perception of effort during ergometer running with well-trained runners. They found out that listening to the music had resulted in relaxation of tension in the muscles. That reduction of muscle tention allowed enlargement in bloodflow, which resulted in positive influence on endurance of performance. They also found out that higher level of training caused acidosis and enlargement of the hormone level, which resulted in enlarged feeling of tiredness.

Copeland et. al. (1991), claimed that music had psycho-biological influence on training, offered more chances for improving endurance. So, they claimed, a well-trained runner could also feel positive effects of music, but in a different way in comparison to some inexperienced runner.

Pfister, Berrol and Caplan (1998) examined the influence of music on people who suffered from cronic-opstructive lung disease while walking on moving strip. More than a half participants enjoyed listening to the music while exercising.

Pujol and Lengenfeld (1999) concluded that synchronic music could be used in endurance while exercising among participants who were not professional sportsmen.

Thaut et. al. (1999) claimed that music offered external auditive stimulus which could enlarge some motoric processes. They claimed that interaction between auditorus rhytm and physical response could have effective therapeutic impacts in rehabilitation of people with moving disorder.

Brown (1979) and Karageorghis (1999) claimed that listening to different tempo of music could influence on physiological excitement of a person That suggested that there could be more tendency for faster tempo of music during physical activity.

Szabo, Leigh (1999) claimed that changing from slow to fast tempo of music could enlarge motivation of participants and their activity, especially when we worked on the level of plato, or in later phases of intensive exercising.

Zilonka, E. (1999) studied the influence of music on programming of pace walking. He claimed that there was more possibility that music would influence on frequency than on lenght of steps.

Karageorghis and Terry (1999) studied effective and psychophysical influence of reaction to music. They claimed that music could be more useful for some people while exercising. The program of aerobics dancing was among the first they included as a means for enlarging the effects and positive mood.

Hayakaw, Takada, Miki and Tanaka, (2000) claimed that with music of aerobics dancing the best grades were included for personal report in perception of efforts. They also found out that there was a difference in the number of haeartbeat of participants during aerobics while listening to the music, and among those who exercised without listening to the music.



Dancing music kept level of heartbeat on higher level in comparison with the level of heartbeat when there was no music. It was concluded that music had served as fun for people with problems while exercising.

Potteiger, Schroeder and Goff (2000) showed that music served as a distraction from problems while exercising. They also found out positive effects of music on mood and self-confidence, and that research was used in many other research fields, such as among people with cardiovascular system diseases and overweighted people.

Matthews, Kosloski (2001) studied the influence of rhythmic music with older patients with dementia while exercising. They found out that using music as intervention enlarged total participation of older people in exercising, especially with those people needing constant exercising because of health problems.

Sjeverne and Hargreaves (2000) suggested that choice of music should provide enough amount of stimulus to be able to maintain and optimise the state of mental and physical excitement.

Karageorghis and Terry (2001) mentioned the main advantages that a sportsman could gain from listening to the music: a) enlarged positive feelings and reduced negative feelings, b) relaxing, c) distancing from unpleasant feelings such as pain and tiredness, d) reduced evaluation grade of perceptive effort, especially during exercising, e) prolonged working ability with synchronisation between music and movement, f) gaining improvement of motoric abilities when rhythm is synchronised with the needed form of movement, g) enlargement of functional ability with sportsmen, h) improving performances via given mechanisms.

Tenenbaum et al. (2001) claimed that 30% of runners showed that music helped them at the beginning of the track. The participants said that their attention had been directed to music that motivated them to continue despite enlarged efforts. Many participants accepted running while listening to the music as a useful thing.

Karageorghis and Lee (2001) evaluated effects of motivation music and pictures on isometric muscle endurance. Similarly, Lanzillo, Burke, Joyner, Hardy (2001) showed that music improved perception and self-confidence. They claimed that the type of music should be the thing of personal choice, and that we should not tell sportsmen which music they should listen to. However, they said that it was important to take context into consideration, f.e. what was the type of the activity that the sportsmen performed, what the desired aim of music was, etc. They said that sportsmen should first study carefully, before they chose the type of music.

However, it was claimed that sportsmen, or participants in training, should be included in selecting songs, because in that way they would enlarge the power of effects of music.

Karageorghis and Lee (2001) studied interactive effects of music on the task of isometric endurance, which asked the participants to weight-lift. The main goal of that study was to put pictures at the back of music, which could be useful for improving performances. They concluded that that strategy could be used before, or after the training. Research showed that continuous synchronisation between music and repeating of exercises was connected with enlarged level of activity. That included activities such as: rowing, cycling, ski running and running. They also concluded that music tempo could regulate movement and in that it could also prolonge exercising. They claimed that synchronisation between music and movement made sportsmen able to perform more efficient tasks, and therefore it resulted in better endurance.

In one recent study they found out that 7% less oxygen was needed to perform the same task in comparison with unsynchronised music in the background.

Murrock (2002) studied the influence of music on mood during exercising with patients after some surgery. They found out that the group that had listened to the music had been in much better mood in comparison with the group that had not listened to the music.

De Bourdeaudhuij et al. (2002) studied the influence of music on overweighted children. They found out that children had exercised more while listening to the music and felt less problems during exercising in comparison with exercising without music.

Schuaer and Mauritz (2003) showed that patients improved their walking while listening to the music in comparison with conventional therapy without music.

Molinari et al. (2003) claimed that improving of motoric control from auditive stimulus by rhythmic stimuli probably affected motorics of effectors in the brain, or in the spinal level.

Bernatsky et al. (2004) claimed that that new knowledge could lead to new approaches in rehabilitation of patients with brain-motoric damages, f.e., when the patients diagnosed with Parkinson disease were exposed to music and later asked to perform motoric tests, the results showed a great improvement in the desired direction, which showed a good motoric improvement in coordination between fists and arms.

Karageorghis, Fryer and Maynard (2003) concluded that intervention which included personal choice of music and pictures could improve sports performance, stimulate emotions and cognitions related to exercising.

Schwartzmiller (2003) studied influence of music tempo on random cycling performances. They found out that the rhythm and power of the pedals changed simultaneously with the dominant auditive frequency from background music. They said that faster tempo of music caused bigger outcome power.

Johnson (2004) studied influence of music style on spontaneous exercise performance. It was found out that the examiners responded to music tempo, even if they listened to the genre of music they did not like.

Atkinson et.al. (2004) showed that the average speed and strength of heartbeat were much bigger while listening to the music in comparison with the group who did not listen to the music. It was shown that music had a strong rhythmic component, even for the participants who chose the type of music by themselves.

Priest, Karageorghis, and Sharp (2004) emphasized the need for standardisation of theory based on the method of music selection. So far there have been 2 attempts in developing the domain in order to evaluate motivational characteristics of music.

Atkinson, Wilson, and Eubank (2004) showed that research results supported predictions that rhythmic components of music could contribute even more with their motivational qualities in comparison with melodic, or harmonic components. A large number of research confirmed the efficiency of background music as strategy for improving mood, f.e. Hewston, Lane, Karageorghis, and Nevill, (2005).

Terry, Dinsdale, Karageorghis, and Lane studied physiological processes based on advantage of music. The music was seen as pre-task or stimulus or sedative.

Terry and Karageorghis (2006) studied psycho-physical effects of music in sport and exercising.

Karageorghis et.al. (2006) suggested that the basic characteristics of motivational music, such as: fast tempo (120 beats in a minute), strong rhythm enlarged energy and stimulated body movement.

Karageorghis (2006) conducted a qualitative analysis which showed 4 main advantages of the use of music: improved mood, enlarged activation, visual and auditive pictures and revocation of connected movies and music videos.

Karageorghis, Jones, and Low (2006) studied the relation between exercising and heartbeat. An important main effect for music was revealed tempo. It was found out that there was a great tendency for fast and medium tempo of music via slow music. There was a strong tendency for fast tempo during exercises of high intensity.

Karageorghis and Loizou (2007) claimed that the effect of reducing tiredness was related to less intensive and moderate exercising. They claimed that at high-intensity exercising, perception of tiredness overpowered the influence of music, because the physiological feedback information of breathing dominated in the process of perception.

It is said that music changes emotional and physiological excitement and therefore it can be used before competition or training as a stimulus, sedative or for reducing feelings of anxiety.

Bishop et.al. (2007) claimed that texts of songs often influenced emotions, while physiological processes had a tendency to react on rhythmic components.

Gordon (2007) studied the influence of tempo of music on spontaneous intensity of exercising. He claimed that if music was used in clinical surroundings, caution was needed.

Peter, Terry and Karageorghis (2008) gave a review of new theories, research and programmes related to psycho-physical influence of music on sport and exercising. The conceptual frame that was shown emphasized that the main advantages of music were the following: improved mood, excitement control, reduction in perception of efforts, improved working exit, improved skill gaining, improved functional abilities and distancing from feeling of pain and tiredness. The 4 main factors were defined: response rhythm, musicality, culture impact and extra-musical communities. One simple example included peoples' tendency to respond on rhythmic qualities of synchronised music by using the form of rhythmic movements. It has been confirmed that synchronised music has an energetic impact.

Therefore, if sportsmen or people who exercise train while listening to the music, they will probably do it longer, and responses to unsynchronised music in the background are less predictable. Positive effects are less reliable, although there is still a great potential if we follow certain principles. A fast rhythm of music is stimulative, while slow rhythm with slow music has a sedative impact. A few examples showed the effective use of music in our work with different groups, ranging from people who participate in exercising to professional sportsmen. Four hierarchical factor showed that rhythm was the most important, while extra-music groups were less important.

Bacon, Myers and Karageorghis, (2008) concluded that music provided potential for a sportsman in order to use the energy more effective, in comparison with control without music.

Prieboy (2009) studied the effects of auditive input on perception of efforts during cycling.

Kreitiger (2010) found out that there were few differences in the pace of running, which suggested that synchronised impact of music on the intensity of exercising was less important while running in comparison with cycling.

Kapingst (2010) studied the influence of music components on exercising on bicycle-ergometer. The strength and frequency of pedals was the same in all three songs including rhythmic components. The most important thing was the presence of synchronised sound, which stimulated the tempo of exercising.

## Conclusion

Participants who listened to the music enjoyed more in exercising and felt better during exercising. It was shown that music helped in realisation of many ideas and programmes in the fitness industry. The music changes emotional and physiological excitement and therefore, it can be used as a stimulus before competition or training, but it can also be used as a sedative for reducing feelings of anxiety. Music reduces tiredness related to less intensive, or moderate exercising. At high-intensity exercising, perception of tiredness overpowers the influence of music, because physiological feedback information of breathing dominates in the process of perception.

Participants who chose music for dancing aerobics showed positive mood during exercising and they exercised much better. Different kinds of music influence on: physical strength, walking, endurance in performing exercises, and gaining the motoric abilities.

A great number of research has confirmed the efficiency of background music as: strategy for improving mood, in research of physiological processes based on advantages of music, in research of music as pre-task or stimulus or sedative. The programme including some kind of regular aerobics with music reduces the risk for people suffering from heart or cardiovascular system diseases, as well as for people suffering from chronic-obstructive lung disease. Such was also the use of music with overweighted patients. Music serves as distraction from problems while exercising. Exercising with music enlarges the level of mental excitements and exercise performances. Some kinds of rhythmic exercises improve bruto-motoric tasks, which improves the efficiency of exercising. The desired music offers acute stimuli for people who exercise no matter of the age, abilities, or sex. When there is a sufficient amount of perception directed to selecting of music escort for exercising, there could be positive effects. The use of motivational music improves the intensity of exercising. Synchronised music provides more intensive exercising.

## References

1. American Health Association. Retrieved on March 31, 2003, from <http://www.AmericanHealthAssociation>
2. American Heart Association. Retrieved on October 26, 2003, from <http://www.AmericanHeartAssociation>;
3. Bishop, D.T., Karageorghis, C. I., & Loizou, G. (2007): *A grounded theory of young tennis players' use of music to manipulate emotional state*. Journal of Sport & Exercise Psychology, 29, 584-607.
4. Copeland, B.L., & Franks, D.D. (1991): *Effects of types and intensities of background music on treadmill endurance*. Journal of Sports Medicine and Physical Fitness, 15, 100-103.
5. Myers, T., & Karageorghis, C. I. (2008): *Effect of movement-music synchrony and tempo on exercise oxygen consumption*. Manuscript submitted for publication.
6. Nicole, M. Harmon and Len Kravitz, Ph.D., *The Effects of Music on Exercise*
7. Peter, C. Terry, Costas I. Karageorghis, (2008): *Music in Sport and Exercise : An Update on Research and Application*.
8. Spilthoorn, D. (1986): *The effect of music on motor learning*. Bulletin de la Federation Internationale de l'Education Physique, 56, 21-29.
9. Szmedra, L., & Bacharach, D. W. (1998): *Effect of music on perceived exertion, plasma lactate, norepinephrine and cardiovascular hemodynamics during treadmill running*. International Journal of Sports Medicine, 19, 32-37.

## A STUDY TO DETERMIN THE STATUS, IMPORTANCE, AND VALUE OF TAKING-A-CHARGE IN BASKETBALL BY COACHES IN THE UNITED STATES AND SELECTED EUROPEAN COUNTRIES

**Kenneth Swalgin<sup>1</sup>, Damir Knjaz<sup>2</sup>, Lubor Tomanek<sup>3</sup> and Ola Fosnes<sup>4</sup>**

<sup>1</sup>*Penn State University, Dept. of Kinesiology, USA*

<sup>2</sup>*Faculty of Kinesiology, University of Zagreb, Croatia*

<sup>3</sup>*Comenius University, Physical Education and Sports, Slovakia*

<sup>4</sup>*The Norwegian University of Sport and Physical Education, Oslo, Norway*

### Abstract

An analysis of primary statistics is one of the ways that coaches and scholars can better understand the game of basketball for individual players and for the team. Unfortunately an important primary statistic has been left-out of that analysis, that primary statistic is taking-charges. The purpose of this study was to survey coaches to see if they believe that it is an important statistic for the game and should be included in the official record. Coaches from the United States, Croatia, and Slovakia were surveyed. The results indicated that in the U.S. that .757 percent recorded the statistic, .772 percent planned practice-time to teach the skill/tactic, .839 percent emphasized or strongly emphasized the tactic for their defense, and .654 percent agreed or strongly agreed that Taking-Charges should be part of the official record of the game. For Croatia and Slovakia, .553 percent recorded the statistic, .690 percent used practice-time to teach the skill/tactic, .494 percent emphasized or highly emphasized the tactic in their defensive structure, and .512 percent believed that the statistic should be recorded in the official record of basketball. It is clear that a majority of U.S., Croatian, and Slovakian coaches viewed Taking-Charges as an important statistic for the game of basketball.

**Key words:** *taking-charges, basketball, little emphasis, highly emphasize, disagree, strongly agree*

### Introduction

The game of basketball can be defined by its structure, the rules that govern play and the value of the performance factors established for the sport. As the structure, rules, and quality of play have evolved, so have the primary statistical performance factor that quantify the quality of play that defines the game. Unfortunately, one of these defining performance categories has been left-out of the official “box score” or record of basketball by FIBA and the National Collegiate Athletic Association (NCAA). The category is *taking-a-charge* (TC). The purpose of this study was to determine the status, importance and value of *taking-charges* in the game of basketball from a United States and European perspective. A secondary purpose was to establish a foundation for *Taking-Charges* to be viewed as an important performance category that should be mandated in the official record of the game.

### Method

Basketball coaches from the United States, Croatia, and Slovakia were surveyed to determine the status, importance, and value of *taking-charges* in the sport of basketball. Basketball coaches were surveyed on the following four questions: 1) if they recorded *taking-charges* in their game statistics, 2) if they planned practice-time to properly teach *taking-a-charge*, 3) how much they emphasized *taking-charges* as a tactic for their team defense, and 4) how strongly they felt to include taking-charges as a primary statistical category for the game.

For the U.S., the total population (n = 342) of the Division I coaches were surveyed, 102 returned completed surveys representing 30% of the coaches. Surveys were also distributed to selected European coaches’ association’s members in Croatia and Slovakia. The results were combined under the assumption both countries methods for developing, training, and selecting club coaches were similar and all member team played under the structure and rules of FIBA Europe. The combined population of coaches for both Croatia and Slovakia was (N=150), 85 coaches returned completed surveys representing (56 %) of the coaches. For the purpose of this study, it was not useful to combine the results of U.S. and European coaches, or to compare U.S. and the European coaches under the assumption that the structures and rules of FIBA Europe and the NCAA may present too great a variance to produce a valid comparison. However, it may be useful to look at both groups and by determining the status, importance, and value of *Taking-Charges* to create a better understanding and value for this performance factor and the need for its inclusion into to the official record of basketball.

## Results

U.S. results for Question 1, do you record *TC's* as a game statistic, and .757 percent indicated they did. Question 2; do you plan practice-time to teach *TC's* as a tactic, and .772 percent indicated they did. Question 3, how much emphasis do you put on *TC's*? The results of a Likert scale ranging from 1-*little emphasis*, to 5-*highly emphasize* indicated; 1=.009%, 2=.047%, 3=.104%, 4=.358%, and 5=.481%. Question 4, do you feel *TC's* should be recorded as a primary statistical category? The Likert scale results ranging from 1-*disagree* to 5-*strongly agree* indicated; 1=.099%, 2=.079%, 3=.168%, 4=.208%, and 5=.446%.

For the selected European coaches (n = 85), on Question 1, do you record *taking-charges* as a game statistic, and .553% indicated they did record the statistic. For Question 2, do you plan practice-time to teach *taking-charges* as a tactic, and .690% indicated that they did teach the skill as a defensive tactic. For Question 3, how much emphasis do you put on *taking-charges* as part of your team defense? The results of the Likert scale ranging from 1-*little emphasis* to 5-*highly emphasize* are as follows; 1=.129%, 2=.271%, 3=.294%, 4=.200%, and 5=.102%. For Question 4, do you feel *taking-charges* should be recorded as a primary statistical category for the game? The results of a Likert scale here ranging from 1-*disagree* to 5-*strongly agree* are as follows: 1=.190%, 2=.107%. 3=.190%, 4=.167%, and 5=.345%

## Discussion

Division I coaches in the U.S. are professional coaches. The status and importance of *TC's* is illustrated from the results of Q1 and Q2 that indicate 75.7% record *TC's* as a statistic not required by the NCAA, and 77.2% planned practice-time to teach the skill and tactic. The results of Q3 indicate 83.9% of coaches' *emphasized* or *strongly emphasize* *TC's* as part of their team defense. When asked if *TC's* should be established as a required primary statistic, 65.4% *agreed* or *strongly agreed* and 16.8% were *undecided*.

Coaches from Croatia and Slovakia are also professional; however they viewed the status and importance of *taking-charges* somewhat differently from their U.S. counterparts. Question 1 indicates that only .553% keep the statistic. This may lead to the assumption that they do not feel it is important enough to keep, or it could mean that because FIBA does not require the statistic, they may not be willing to commit the resources needed to collect the data. Despite the results of Question 1, Question 2, indicating that .690% of the coaches' take-time to teach the tactic. This shows a strong majority view the tactic as valuable. The results of Question 4 indicate that only .494% *emphasize* or *highly emphasize* the tactic and .400% of coaches put little or no emphasis on the tactic in developing their team defense. For Question 4, do you feel *taking-charges* should be kept as a primary statistical category for the game, .512% *agreed* or *strongly agreed* that it should be a required statistic by FIBA, .297% *disagreed* or *strongly disagreed* and .190% were *undecided*. From the results of Questions 3 and 4, it appears that the sample of coaches in the study is not ready to add this statistical category. Naturally, 85 coaches is not a representative sample of all the coaches in Europe.

For coaches in the U.S., *Tacking-charges* as indicated from the results of the survey of coaches are an important statistical performance category leading to successful play. *Taking-a-charge* is an objective measurable performance factor that has an established value for the game; it creates a change-in-possession leading to a scoring opportunity, and as well, takes a scoring opportunity away from the opponent. *Taking-a-charge* also adds to *team foul* totals leading to the *Bonus Free Throw* situation sooner, and results in a *personal foul* that may lead to a player's disqualification and/or reduced playing time to protect against disqualification. It is apparent from the results of the survey that U.S. coaches view *taking-charges* as a valued performance factor for the game and support its inclusion to the official statistical record of basketball.

It was not the intent of this study to compare directly the views of coaches from the U.S. and the combined coaches of Croatia and Slovakia, but it does appear that the groups are not in strong agreement in the value and need for inclusion of *taking-charges* to the official record of basketball. However, hopefully the ground-work to determine the status, importance, and value of *taking-a-charge* as a primary statistic has been established. Also, a much stronger sample of coaches throughout Europe will be needed to establish the validity the data related to *taking-charges*.

## References

1. Buson, J.F. (1973) Developing a systematic procedure for basketball film analysis and utilization. (Unpublished doctoral dissertation) The Ohio State University.
2. Elbell, R.R. and Allen, F. (1941). Evaluating team and individual performance in basketball. *Research Quarterly*, 12(3):538-557.
3. Swalgin, K.L. (2008) Building a better "box" score, how division I coaches define and value field goal shooting and *taking-charges*. Published on the NABC Website, [http://www.nabc.org\\_programs/anbc.html](http://www.nabc.org_programs/anbc.html)
4. Swalgin, K., Knjaz, D. (2007) The Euro-basketball evaluation system, a computerized seamless model to grade player performance. 6<sup>th</sup> International Symposium on Computer Science in Sport. Calgary, Alberta, Canada, pp: 292-299.

## EVALUATION AND ANALYSIS OF INJURIES IN KICKBOXING

Tatjana Trivić<sup>1</sup>, Patrik Drid<sup>1</sup>, Radovan Kalanj<sup>2</sup>, Miodrag Drapšin<sup>2</sup> and Milan Stanković<sup>2</sup>

<sup>1</sup>Faculty of Sport and Physical Education, University of Novi Sad, Serbia

<sup>2</sup>Faculty of Medicine, University of Novi Sad, Serbia

### Abstract

#### Purpose

Kickboxing is western sport – a unique response to many martial arts coming from the Far East. In this sport the use of punching, kicking and, under some rules, kneeing and elbowing are permitted. As the sport and the combat fighting art of kickboxing grew, kickboxing improved tremendously and their techniques became stronger and powerful. Also, the injuries are happening during the competition and training. The majority of injuries are contusions, distortions and dislocation.

The aim of this study was to analyze the injuries caused by kick box training and competition.

#### Methods

193 male and female kick boxers from Serbia have filled in the questionnaire. Aside the questionnaire we had a previous medical history of each athlete.

#### Results

Incidence of injury is in correlation with the number of matches played ( $\chi^2 = 33,775$ ;  $df = 9$ ;  $p=0,000$ ), years of training ( $\chi^2 = 29,075$ ;  $df = 9$ ;  $p=0,001$ ), age ( $\chi^2 = 20,023$ ;  $df = 9$ ;  $p=0,018$ ), body mass ( $\chi^2 = 23,437$ ;  $df = 9$ ;  $p=0,005$ ) and body height ( $\chi^2 = 18,587$ ;  $df = 9$ ;  $p=0,029$ ). In male kickboxers the number of injuries is highly related with number of matches, years of training and age. In female kickboxers the number of injuries is correlated with age and number of training hours. Most common injuries in both groups are injuries of hand then knee and lower leg. The largest number of athletes are treating the injuries on their own.

#### Conclusion

Lack of protecting gear, specific movement patterns and contact of the sport increase the injury rate. Results has shown that the number of injuries increases with the number of matches, and that age increases does not increase the number of injuries in male kickboxers, which is opposed in the same phenomenon in female kickboxers. Repeated violations are common due to inadequate treatment, ie. self care. On the basic of obtained results it can be concluded that the number of injuries in kickboxing is equal to the number of injuries in karate and taekwondo.

## EXTROVERSION OF YOUNG SWIMMERS AND THEIR SPORT SUCCESS

Jugoslav Vojinović<sup>2</sup>, Jan Babiak<sup>1</sup>, Branislav Strajnić<sup>1</sup> and Žika Kalentić<sup>1</sup>

<sup>1</sup>Provincial institute for sport, Novi Sad, Serbia

<sup>2</sup>Sportska akademija Beograd, Serbia

### Abstract

Reaching top results can no longer be imagined without recognition of psychological dispositions of athletes. The research aim is to determine relationship between extroversion and sports performance of young swimmers. The research included 135 swimmers, from 9 to 16 years old. This research used Eysenck personality test and a questionnaire for evaluation of athletes success. The results indicate that extroverted children swimmers do better than introverted children. From the total sample in relation to sports success criteria extraverts have 42.1% and they belong to a group of successful swimmers, while introverts are 27.7%. Keeping in mind many dimensions of these traits, and if we consider social character of sport involvement, it is logical to expect that the sport is dominated by people who have expressed extravert orientation. Results showed that extroverted children swimmers have better results than introverted children.

**Key words:** correlations, personality traits, sport performance

### Introduction

Success in sports and achieving superior results can no longer be imagined without the recognition of psychological dispositions of athletes and the practical application of psychological principles, which often play a decisive role. (3, 4, 5, 9). Based on the Eysenck Personality test typical Extravert person could be described as a person who is social, fun loving, has many friends, need contacts with many people, do not like to work alone, read or learn without company. Person who seeks thrills and showing off, and active under instant inspiration. Prone to optimism, not controlling its feelings best. Typical introvert is a quiet person, prefers hanging out with books rather than with people. In contact with others is more reserved, except with the most intimate friends. He does not like excitement, and loves tidy life. Reliable and prone to pessimism.

Extravert athletes are facing outside, toward the objective world of things and phenomena around them. Primarily interested in social activities and practical issues. Open, communicative and enterprising, easy including into group and making friends. Introvert athletes are facing inside, toward the inner subjective world of experience, ideas, imagination etc. Sweet-natured, sensitive and does not like jokes, inhibited in the communication and is cautious in creating friendships (1,2).

Aim of the research is determining interaction of extraversion and sports performance, whether the extravert swimmers get better sports results from swimmers who are more introvert.

### Methods

The research involved 135 young swimmers, aged 9 to 16. Questionnaire was conducted anonymously and independently. Applying the relevant procedures of data processing, relationship between the observed variables will be determined and influence of extraversion on sports results of young swimmers. In this research, for data collection, were used following instruments: Eysenck 's personality test modified - EPI (Table 1), to examine the dimensions of extraversion (Table 1) and a questionnaire to assess the performance of athletes.

Sports performance was measured using a questionnaire (five-scale) to assess children's sports success-swimmers from coaches angle (Table 2). In processing datas, we calculated frequencies, percentage, arithmetic mean, standard deviation, correlation and significance testing with hi-square test.

### Results and discussion

The results show (Table 1) that majority of children fall into category of introverted than extroverted category of children in relation to the overall sample (6). This is particularly pronounced in the sphere of social relations: about two-thirds of young swimmers (63.7%) would rather read than say when they have something to say in front of a group of people, only 9.6% of them happy and having fun spending time in company, 80% of them like to have only a few close friends.

Only one in ten respondents think that others perceive him as cheerful person, four-fifths of them would rather see a book than they will talk with someone if they want something to learn, more than half are hateful to be in a society

where each on others make jokes; Slightly more than half of sample would be unfortunate if they no longer would have contact with many people (8).

Table 1. Distribution of extravertness

QUESTIONS		YES	NO	SI	SKV
1. Do you often wish excitements?	f	66	69	267	1.98
	%	48.9	51.1		
2. Are you often carefree?	f	43	92	221	1.63
	%	31.9	68.1		
3. Do you stop during working something and think about next steps?	f	91	44	135	1
	%	67.2	32.8		
4. Do you work and speak fast and dont stop to think?	f	97	38	329	2.44
	%	71.9	28.1		
5. Do you make risky and dangerous moves?	f	86	49	307	2.27
	%	63.7	36.3		
6. Do you deal with things often in speed?	f	79	56	293	2.17
	%	58.5	41.5		
7. When you need to say something in front of group, do you like to read it or speak?	f	86	49	135	1
	%	63.7	36.3		
8. Do you like company?	f	11	124	157	1.16
	%	8.1	91.9		
9. Do you prefer small number of close friends?	f	108	27	135	1
	%	80	20		
10. When they yell at you, do you answer the same way?	f	82	53	299	2.21
	%	60.7	39.3		
11. Do you like entertaining in friendly company?	f	13	122	161	1.2
	%	9.6	90.4		
12. Does people think you are cheerful person?	f	16	119	167	1.24
	%	9.6	88.1		
13. Are you mostly silent in group of people?	f	30	105	135	1
	%	22.2	77.8		
14. When you are curious, you rather look into a book or speak with someone?	f	44	91	135	1
	%	79.3	20.7		
15. Do you like working on things which require bigger attention?	f	53	82	241	1.78
	%	39.3	60.7		
16. Do you find it odiously sharing company with person which tell jokes on each others expense?	f	74	61	135	1
	%	54.8	45.2		
17. Do you like work which requires speed?	f	68	67	271	2
	%	50.4	49.6		
18. Are you so slow as we can see by your moves?	f	11	124	135	1
	%	8.1	91.9		
19. Do you like so much to speak with people that sometimes you dont see you are speaking with complete strangers?	f	88	47	311	2.3
	%	65.2	34.8		
20. Are you unhappy if you are not in touch with a lot of people for longer time?	f	78	57	291	2.15
	%	57.8	42.2		
21. Are you self-confident?	f	37	98	209	1.55
	%	27.4	72.6		
22. Are you gettier harder cheerful in more cheerful company?	f	12	123	135	1
	%	8.9	91.1		
23. Are you easily cheerful in boring company?	f	75	60	285	2.1
	%	55.6	44.4		
24. Do you make jokes on others expense?	f	94	41	323	2.4
	%	69.6	30.4		

Legend: SI=syntetic index, SKV=scalar amount



Table 2. Evaluation of some characteristics of young swimmers according to

Characteristics		Totally significant	significant	middle	Not significant	Totally not significant	SI	SKV
Wish for top results	f	66	34	23	10	2	557	412
	%	48.89	25.18	17.03	7.40	1.48		
Workoholic on trainings	f	51	40	24	11	9	518	3.83
	%	37.37	29.62	17.77	8.14	6.66		
Tehcnical and tactical abilities	f	38	49	28	13	7	503	3.72
	%	28.10	36.30	20.75	9.62	5.18		
Training quality	f	48	39	21	16	11	502	3.71
	%	35.55	28.88	15.55	11.85	8.14		
Physical condition	f	50	31	26	18	5	493	3.65
	%	37.03	22.95	19.25	13.33	3.70		
Fair play	f	35	46	27	11	17	479	3.54
	%	25.92	34.07	20.00	8.14	12.59		
Cooperative	f	35	44	27	10	19	471	3.48
	%	25.92	32.60	20.00	7.40	14.06		
Persistant and good bearing of hard trainings	f	20	24	31	41	19	390	2.88
	%	14.8	17.17	22.96	30.37	14.07		
Answer	f	18	29	17	34	37	362	2.68
	%	13.33	21.48	12.59	25.18	27.40		
Emotional stability	f	20	22	18	48	27	365	2.70
	%	14.81	16.29	13.33	35.55	20.00		

Using data from Table 2 we can see that the observed characteristics, as indicators of sporting success, are present in young swimmers in a very different levels.

In the first place is desire for top results. Significant and totally significant are present in three-quarters of respondents, while only 8.88% not significant. It is followed by workoholic in training (significant 67.3% and 14.8% not significant respondents). Technical and tactical ability is significant in 64.40% and not significant in 14.80% cases. In the middle are following characteristics: the quality of swimming, physical fitness, fair play orientation, cooperativity.

On the other end, as the least significant characteristics present in young swimmers are emotional stability and persistence and a willingness for serious efforts. These three features are hardly present in one third of respondents, while the responsibilities and especially emotional stability in more or less not significant in even more than half of respondents.

Table 3. Extroversion and sport performance

Xtroversion		Sport performance		Total
		Less successful	More successful	
Low extroversion	f	34	13	47
	%	72.3	27.7	100.0
Moderate extroversion	f	24	26	50
	%	48.0	52.0	100.0
High extroversion	f	16	2	38
	%	42.1	57.9	100.0
Total	f	74	61	135
	%	54.8	45.2	

$X^2 = 5.986$  df = 2 Sig. = .05

Evidently, the extravert children (Table 3) swimmers have better results than introvert children. Extraversion is a significant factor in sports performance, regarding that introverts are less successful than extraverts. Among the athletes that are characterized by higher extraversion 42.1% of them belongs to a group of successful swimmers, while among young swimmers that are characterized by more introvert 27.7% of all successful swimmers (6).

## Conclusions

The results showed that a hypothesis is confirmed. Extrovert children are far more better than introvert children. Extraversion is a significant factor in sports performance, regarding that introverts are less successful than extraverts.

Among the athletes that are characterized by higher extraversion 42.1% of them belongs to a group of successful swimmers, while among young swimmers that are characterized by more introvert 27.7% of all successful swimmers (6).

Indicators of sporting success are present in young swimmers, in a very different levels. In the first place is desire for top results. Significant and totally significant are present in three-quarters of respondents, while only 8.88% not significant.

We should keep in mind that our respondents mostly belong to the full period of childhood and adolescence.

## References

1. Eysenck, H.J., Nias, D.K.B., Cox, D.N. (1982). Sport and personality. *Adv Behav Res Ther*; 1-56.
2. Katel, R.B. (1978). *Scientific personality analysis*. BIGZ, Belgrade.
3. Malacko, J., Doder, D. (2008). *Technology of sport training and recovery*. Novi Sad.
4. Paranosic, V. (1982). *Psihology of sport*. Belgrade.
5. Havelka, N., Lazarevic, Lj. (1976). *Motivation for practicing sport*. Research project, Physical culture Institute, Belgrade.
6. Vojinovic, J., Doder, D. (2006). Extravertness and intravertness as success factor of young karate athletes. *Collection book of the second international scientific and professional symposia, "The effects and influences of different models of training process on the anthropological status of athletes in combat sports"* (90-97). Novi Sad: Provincial sport Institute
7. Vojinovic, J., Doder, D., Doder, R. (2007). Personality traits of parents and their children as a factor for success in karate sport. *Collection book of the XVI International Symposium "Sport and physical activity of young people and youth health"* (157-163). Novi Sad: Novi Sad University and Novi Sad marathon.
8. Vojinović, J., Doder, D., Babiak, J., Doder, R., Savić, B. (2009). *Social experiential features of children swimmers and their success in sport*. *Sport Mont*; 6 (18, 19, 20):557-560.
9. Malacko, J. Doder, D., Vujanović, S. (2010). *The differences in the movement structures of kata, fights and mental potentials between boys and girls who train karate*. *Acta Kinesiologica*; 4(2): 28-32.

## THE THEORY OF PSYCHOLOGICAL ATTITUDES (PREDISPOSITIONS), THEIR TYPES AND EFFECTS IN LIFE AND SPORT

Włodzimierz Starosta

*International Association of Sport Kinetics,  
University School of Physical Education and Tourism in Białystok, Poland*

*“If I had to choose between the best physical conditions  
or good mental attitude, I would certainly choose the latter”*

*Andre Agassi- world's leading tennis player*

Modern sport is characterized by permanent equalization of the level of representatives from different countries. Winning a high place in the international arena, and particularly winning medals is getting harder and harder and takes place in the fight for centimeters, and even hundredths of seconds. Participation in champion rivalry needs manifesting of not only high levels of technical and tactical preparation, but mainly of the psychological preparation. It is this that increasingly determines the achievement of record results. In this preparation the various ways of the mental stimulation of the athletes is applied. Relatively little popular, especially in the West, is the theory of attitudes (predispositions) by the Georgian psychologist and psychiatrist D. Uznadze [1923]. Its elements were used earlier in the everyday life of societies around the world. D. Uznadze generalized them thus **creating an original theory valid for different types of human activity**. This theory has been enriched by scientists of various disciplines, including specialists of physical education and sport. **The theory of attitudes (predispositions) proved to be particularly helpful in professional sport, where difficult and rapidly changing situations occur.** The concept of attitude (predisposition) may be associated with the setting of an alarm clock at a certain time. A well-organized person in order to wake up at a certain time, adjusts his/her *“own biological alarm clock”*, which works as precisely as the mechanical one. The attitude (predisposition) is related to the achievement of a specific aim within a specified time. The essence of this theory is accurately defined by a short statement: *“A man achieves what he has set for.”* According to D. Uznadze attitude is a certain: *“overall effect”*, *“holistic orientation”*, *“central modification of personality”* [1945, 9]. In order to understand the physiological mechanism of attitude (predisposition), the theory of A. A. Uchtomski [1952] has proved to be helpful. The theory is about the dominant defined as the **permanent stimulation of any nervous center, which at a certain time become a relevant factor prevailing in the work of other centers**. In his theory he revealed: *“... the reaction of the nervous center to the stimulant is defined not only by the size of the stimulation itself, but also by the state of other centers.”* [Golikov, 1950, 45]. This idea makes the key to understanding **why the athlete, thanks to the existence of attitude (predisposition) to the competition, has the ability to perform exercises with the highest physical tension**. A.A. Uchtomski showed that the dominant determines the working attitude (predisposition) of the body. As an example he gave the speech, which he considered to be the *“prevailing attitude (predisposition)”*. The location of the dominant is determined by stimuli, which at the given moment are the most important for the body and stimulate the appropriate nervous centers of the cerebral cortex. For example, **for the performance of physical exercise the dominant center is formed around the motor analyzer**. Strengthening of the dominant, indispensable for the execution of movements with high physical tension, is achieved through the action of verbal stimuli: thinking about the aim, its importance and necessity of its achievements, etc. As A.C. Puni defined: *“Fluctuations of the dominant, depending on conditions, the direction of its strengthening or weakening correspond to what we experience, and to how strong or weak is the desire (will) to achieve the aim. That is exactly the attitude (predisposition)”*. Externally, it is reflected in the execution of exercises with the properties of activities and movements, which make up the exercise. One should assume that the physiological predisposition is something else than the representation of aim. It is connected with creation of the dominant stimulus center in the cortex.” [1955, 211-212]. **In short, this theory consists of attitudes (predispositions) set on achieving a specific goal, occurring prior to the given activity itself**. Studies have shown that such a concretized mental attitude of man causes functional mobilization of the whole body, which promotes the achievement of the aim. However, the aim must be adequate to the possibilities of man. This theory works well in sport activities. It turned out that : *“the attitude toward success creates success”*. **Because: “either the success or failure first arises in the mind of the competitor, and only later it is executed in reality”**. **Attitude (predisposition) can be positive or negative**. The former has been written about most often, whereas the latter was mentioned less frequently, nevertheless, they make two halves of the same whole, between which there is a strong correlation, **because any weakness of the will can be combined with a negative attitude**. This theory was extended by adapting it to sport and by creating various types of attitudes: *“start”* [Puni, 1955], *“movement attitude”* [Diaczkow, 1975], *“tactical attitude”* [Jegupow, 1955], *“conditional and categorical attitude”* [Jegorov, 1955], *“attitudes set for the correct execution of exercises”* [Puni, Starosta, 1979], *“attitudes for symmetrization of movements”* [Starosta,

1975, 2008], “*long-term attitude*” and others. **Negative attitudes** generate negative thinking mostly about what we fear, or what we want to avoid. An interesting concept of **optimism – pessimism**, and at the same time a valuable principle for athletes was formulated by M.E.P Seligan: “*Optimism portends success in sport. Pessimism in sport is a prelude to failure.*” [1993]. The kind of thinking clearly affects the well-being and effectiveness. If it is negative – it poisons a man’s life and reduces his chances of success. The subject of a toxic role of negative thinking is often mentioned. However, this negative sometimes is quite easily transformed into a positive, even in difficult conditions encountered during the competition. **The aim of this study was to develop a first classification of types of attitudes and their determinants, as well as to give a more comprehensive justification of scientific theories of D. Uznadze.**

## THE STABILITY OF KYNEMATIC STRUCTURE OF SKIJUMPING TECHNIQUE OF FLYING

Bojan Jošt and Janez Vodičar

University of Ljubljana, Faculty of Sport, Slovenia

### Purpose

The purpose of the study was to determine stability of kinematic structure of ski jumping technique of flying.

### Methods

The research project was realised on a sample of elite Slovene ski jumpers (N=29) who participated in the experiment on the Hinterzarten (HS95m) jumping hill on 20 August 2008. Ten kinematics variables of ski jumping flying technique were formed. Seven jumps were done in the experiment, with duration time of 90 minutes. Three cameras were filming the flight position at 15 m, 32 m and 60 m after the take off bridge operating at 50 fps in perpendicular direction in sagittal plane. Image space was calibrated by using calibration rounds along the observer's area. The 2-D model of a jumper's body and skis consisted of 6 segments. Statistical analysis was performed to determine Cronbach Alpha coefficients of reliability ( $CaR_{TT}$ ).

### Results

Results are presented in table 1.

Table 1. Reliability of kinematics variables of flying technique in ski jumping

Name of Variable	$CaR_{TT}$ position 15 m	$CaR_{TT}$ position 32 m	$CaR_{TT}$ position 60 m
Angle of knee extension	0.88	0.91	0.86
Angle between left skis and leg	0.96	0.95	0.95
Angle between left leg and horizontal plane	0.98	0.98	0.97
Angle between upper body and horizontal plane	0.96	0.95	0.90
Angle of hip extension	0.94	0.93	0.91
Angle between body chord and horizontal axis	0.98	0.98	0.97
Angle between left skis and horizontal plane	0.93	0.93	0.94
Angle between upper body and left arm	0.95	0.91	0.85
Height of the flying curve	0.90	0.96	0.96
The angle of tangent of flying curve	0.76	0.80	0.78

### Discussion and conclusions

The highest and significant reliability was found in most kinematics variables, most exceptionally at variables angle of knee extension and the angle of tangent of flying curve. On the basis of these results the hypothesis of high stability of ski flying technique could be formed.

**Key words:** ski jumping, kinematics analyse, flying phase

# DIFFERENCES IN THE EFFECTS OF THREE – MONTH LONG TRAINING OF EXPLOSIVE STRENGTH AND REGULAR PRACTICAL CLASS ON SPECIFIC THROWING ABILITIES, AND THE SCORING EFFICIENCY IN SHOT PUT OF FRESHMEN OF THE UNIVERSITY OF SPORTS AND PHYSICAL EDUCATION

**Mensur Vrcić**

*Faculty of Sport and Physical Education, University of Sarajevo, Bosnia and Herzegovina*

## Abstract

The experimental students (n:60) were subjected, in addition to their practical class of physical education, to an experimental modulated program of explosive strength for three months with a frequency of twice a week, lasting 45 minutes per training. The control group (n:60) was obligated to perform only the practical class (Judo, Anthropomototics, and Athletics), based on the University Curriculum. An initial measurement was performed at the beginning, as well as a final one at the end of the experiment. Based on the T test, the transformational capacities of the experimental program of the experimental group could be determined. The conducted program of explosive strength caused different effects in relation to the control group which only performed regular class lasting two hours per class of previously mentioned subjects.

**Key words:** *explosive strength, shot put, experimental program, regular class*

## Introduction

It has been scientifically proven that positive, and wanted effects of transformational procedures can only be expected under the circumstance of establishing optimal relations between the relevant skills, and attributes, and motoric skills (Malacko, 2002). For a specific training of development of explosive strength, in theory, the term “Plyometric training” is used, and for the training method “Plyometric method” is used. The basic principle of plyometric method is the rate of change of eccentric and concentric muscle contractions. The time a muscle needs to change from the state of flexibility (extension) in the state of shortage (returning to its original position) is the base foundation of this idea. This point indicates on the basic principle of plyometric training: that rate and size (degree) of stretching determines the usefulness of elastic energy and the transmission of chemical energy into mechanical work. The characteristics of muscle elasticity and myotatic reflex (stretching reflex) play a significant role in the plyometric method. The muscle stretching reflex is included in the SSC (stretch shortening cycle). For a quality eccentric-concentric contraction, three significant conditions must be fulfilled (according to Komi and Gollhofer, 1997):

- Timeliness of muscle activation just before the eccentric contractions,
- A short-lasting eccentric contraction,
- Actual changes between phases of stretching and shortening,

Research of examinees who belong to the experimental group for the efficiency of training methods for the development of explosive strength was completed in the time period of thirteen weeks. It was completed despite the regular classes of six hours per week based on the curriculum for the students who attend undergraduates (Judo, Athletics, and Anthropomototics; two hours of exercises per week). In addition, there were two more hours, within the 26 training classes for freshman of the University of Sports and Physical Education in Sarajevo.

The examinees of the control group attended only the regular class with six hours per week, which was realized based on the determined curriculum of practical exercises (Athletics, Judo, and Anthropomototics).

An initial (before the treatment started) and final measurement (upon completion of the treatment) of specific motoric abilities was made at the same time while both groups performed the shot put - back technique. In addition, groups' results were measured at the same time as their motoric abilities.

The experimental program was designed so that it contained the most different types of jumps, elements of sprint and throwing techniques of medicine balls.

## Examinees and methods

### Sample subject

*Sample* in this particular research consists of 120 student examinees of the first year of the University of Sports in Sarajevo, male, which were tested before and after the experimental treatment. The examinees were divided into two subsample, which were: subsample of 60 examinees which in addition to the University's regular practical class, had an organized training work with two addition hours per week for development of explosive strength (*the experimental group*), and subsample of 60 examinees who performed only motoric exercises, which were mandatory during the realization of practical exercises class, based on the determined University Curriculum (*the control group*). All the examinees passed the test of shot put - back technique before the experiment had begun. In total, eight variables were applied. In detail, for the estimation of the state of entities in the area of specific throwing abilities seven variables were used, and the criterion variable of result efficiency was used in shot put - back technique. In the area of specific throwing abilities seven tests were applied, and the test of shot put- back technique was used as a criterion variable. Sample of measuring instruments

1. Test of specific motoric abilities,
2. Result efficiency in athletic discipline of shot put - back technique.

#### *Measuring instruments used for estimating specific motoric abilities*

- |  |        |
|--|--------|
| 1. Chest shot put – half squat               | SMPP   |
| 2. Overhead backwards shot put – half squat  | SMKUN  |
| 3. Forward shot put – half squat             | SMKUI  |
| 4. Medicine ball throw from sitting position | SMMES  |
| 5. Clap pushups in 10 seconds                | SMSKL  |
| 6. Long jump from half squat                 | SMDOS  |
| 7. Long jump after the first jump            | SMDOSS |

#### *Measuring instruments for estimating results in shot put – back technique*

- |                              |      |
|------------------------------|------|
| 1. Shot put – back technique | REZK |
|------------------------------|------|

## Results and discussion

**Analysis of the quantitative differences in the univariant level between initial and final measurements of subjects examined by t-test for dependent samples**

### *Differences between initial and final measurements for the control group*

### *Differences between initial and final measurements of specific throwing abilities for the control group*

Table 1. The importance of differences between arithmetic means of specific throwing abilities in the control group

	Mean	Std.Dv.	N	Diff.	Std.Dv. Diff.	t	df	p
SMPP	741,90	92,23						
SMPPF	778,18	88,98	60	-36,28	58,85	-4,77	59	,000
SMKUNI	840,56	146,45						
SMKUNF	891,35	141,22	60	-50,78	63,54	-6,19	59	,000
SMKUI	956,70	148,69						
SMKUIF	1030,76	123,50	60	-74,06	96,41	-6,34	59	,000
SMMESI	569,56	65,17						
SMMESF	571,30	58,14	60	-1,733	31,02	-,43	59	,666
SMSKLI	10,75	2,90						
SMSKLF	11,71	3,00	60	-,966	1,52	-4,89	59	,000
SMDOSI	46,25	7,01						
SMDOSF	48,13	6,98	60	-1,88	4,85	-3,00	59	,003
SMDOSI	45,56	7,69						
SMDOSSF	46,98	7,32	60	-1,41	5,51	-1,98	59	,051

The results of the T-tests performed for each of the seven variables of specific throwing techniques (table 1), between the initial and final measure, from the subject of the control group shows that with the analysis of the T-value coefficient and its significance (p) it can be concluded that there is a statistically significant difference on point  $p=.005$ , in five tests of specific throwing abilities of chest shot put – half squat (.000 SMPP), overhead backward shot put – half squat (.000 SMKUN), forward shot put – half squat (.000 SMKUI), clap pushups in 10 seconds (.000 SMSKL), and in long jump – half squat (.003 SMDOS) in the final measurement in regard to the initial state.

*Differences in result between the initial and final measurement in shot put in the control group*

Table 2. The importance of differences between arithmetic means in shot put – back technique in the control group

	Mean	Std.Dv.	N	Diff.	Std.Dv. Diff.	t	df	p
REZKI	738,03	119,38						
REZKF	767,50	118,71	60	-29,46	50,77	-4,49	59	,000

In Table 2. the results of T-tests in shot put – back technique between the initial and final measurement on the subject indicates that by analyzing the coefficient T – value (-4.49) and its importance ( $p=.000$ ), it can be concluded that there is a statistically significant difference ( $p=.005$ ) in the test of shot put in the final measurement in regard to the initial state. Based on the negative sign in front of the value (t), values of the results in the final measurements received some bigger value (to be precise), and that is proven by a higher value result of arithmetic means of the final in regard of the initial measurement, which was 29 cm.

*Differences between initial and final measurements for subjects of the experimental group, questioned by the T-test*

*Differences between initial and final measurements of specific throwing abilities for the experimental group*

Table 3. The importance of differences between arithmetic means of specific throwing abilities in the experimental group

	Mean	Std.Dv.	N	Diff.	Std.Dv. Diff.	t	df	p
SMPP	791,00	95,33						
SMPPF	842,70	93,06	60	-51,70	58,33	-6,86	59	,000
SMKUNI	909,27	149,33						
SMKUNF	1014,28	141,56	60	-105,06	96,07	-8,47	59	,000
SMKUUI	956,70	148,69						
SMKUUF	1030,76	123,50	60	-74,06	90,41	-6,34	59	,000
SMMESI	581,61	88,52						
SMMESF	604,35	81,10	60	-22,73	37,30	-4,72	59	,000
SMSKLI	11,83	2,74						
SMSKLF	12,49	2,58	60	-,65	1,42	-3,58	59	,000
SMDOSI	49,40	8,35						
SMDOSF	52,61	8,16	60	-3,21	4,28	-5,81	59	,000
SMDOSI	48,31	8,34						
SMDOSF	52,73	8,70	60	-4,41	5,25	-6,50	59	,000

The results of the T-tests performed for each of the seven variables of specific throwing techniques (table 1), between the initial and final measure, from the subject of the experimental group shows that with the analysis of the T-value coefficient and its significance (p) it can be concluded that there is a statistically significant difference on point  $p=.001$ , in all seven tests of specific throwing abilities: chest shot put – half squat (.000 SMPP), (.000 SMKUN), (.000 SMKUI), (.000 SMSKL), (.003 SMDOS), and long jump after the first jump (.005 SMDOSS) in the final measurement in regard to the initial state. All variables of the specific throwing abilities have a negative sign in front of the value of the T-test (t), which may lead to a conclusion that the examinees had statistically, and significantly better results in the second measure. That can also be concluded by the arithmetic means of the variables in the initial and final measuring. Such radical changes between initial and final measurements of specific throwing skills in the experimental group with the highest statistical



significance ( $P = .000$ ), in all tests, are the result of the effects of plyometric training. Planned and programmed contents of the program led to positive transformations in the space of specific throwing abilities.

*Differences in results between the initial and final measuring in shot put in the control group*

Table 4. The importance of differences between arithmetic means in shot put – back technique in the experimental group

	Mean	Std.Dv.	N	Diff.	Std.Dv. Diff.	t	df	p
REZKI	791,03	97,36						
REZKF	837,28	103,06	60	-46,25	49,60	-7,22	59	,000

In Table 4. the results of T-tests in shot put – back technique between the initial and final measurement on the subject indicates that by analyzing the coefficient T – value (-7.22) and its importance ( $p=.000$ ), it can be concluded that there is a statistically significant difference ( $p=.005$ ) in the test of shot put in the final measurement in regard to the initial state. Based on the negative sign in front of the value (t), values of the results in the final measurements improved, which is evident by the improvement of the results of arithmetic means of the final in regard of the initial measurement, which was 46 cm. The difference in arithmetic means between the initial and final measuring in the test of put shot in the control group (Table 2) shows an improvement of 29 cm ( $P=.000$ ), while that difference is 46 cm (Table 4) in the experimental group. The bigger difference of improvement in the results, in put shot, of 17 cm in favor of the experimental group in regard to the control group between two time checkpoints, can be attributed to the effects of plyometric training subscribed on subsample of examinees, which in addition to regular class had an extra program of 26 trainings of explosive strength in a three – month experimental period. The common conclusion for the control and the experimental group is: that by the results of the T tests, a more statistically significant difference can be determined in variables of the experimental, in relation to the control group at the univariate level. Therefore, it can be concluded that the experimental program produced higher levels of quantitative changes, as compared to the control group that was subjected to a standard program of instruction.

## Conclusion

On a sample of 120 students of the Faculty of Sports and Physical Education, which is divided into two subsamples of 60 students, an efficiency research, uniformly programmed, of explosive strength in a period of three months, was made. Research was performed in addition to regular classes (n: 60 of the experimental group), and only regular class continued with two hours of physical education in academic subjects such as Judo, Athletics and Anthropometrics (n: 60) control group. Based on the results of the T tests for dependent samples, a conclusion was made that the students who were subjected to the experimental program of explosive strength, had radical changes in terms of results improvement, in every variable of specific throwing abilities. In the training of the put shot athlete, accentuation (strength is trained the most in moves which are dominant in the competing structure), has a significant role in planning and programming of the training (Zaciorski and 2009). In addition to determining the effects of copyright and its adaptive potential in the development of specific throwing ability, its effect on the success of results in the shot put discipline was determined. It should be clear that a higher level of achievement was not the primary goal. Range of improvement only measures the efficiency of the offered program content. The score improvement in the shot put of 46 cm, which was statistically more significant in the experimental group than within the control group that received a results shift from 29 cm, which is a 17 cm difference, could only be underestimated by people who do not understand this type of experiment. For those who understand this program, the improvement of 46 cm is a very important jump, especially taking into account that the experiment lasted only three months and with trainings of two hours a week. Continued use of the content of this program throughout the one - year macro – cycle, with higher frequency, would certainly give results with even more significant effects.

## References

1. Komi, P. W. i Gollhofer, A. (1997). Stretch reflex can have an important role in force enhancement during SSC exercise. *Journal of Applied Biomechanics*, 13, (451-460).
2. Malacko, J. (2000). *Fundamentals Of Sports Training*. Fourth revised and updated edition. Beograd: Academy of Sports Beograd. (162-172).
3. Vrcic, M. (2010). The effects of a strength training model on certain antropologic characteristics and result efficiency in shot put – back technique. Doctoral dissertations. Sarajevo. University of Sports and Physical Education.
4. Zatziorsky, V.M. (2009). *Science and practice in strength training*. Second edition. Beograd: Datastatustus

## INDEX OF AUTHORS

- Agačević Zrna 720  
 Ajman Hrvoje 194  
 Akpınar Selcuk 612  
 Alić Haris 695  
 Alkier-Radnić Romina 635  
 Andrijašević Mirna 334  
 Anguera Maria T. 546  
 Antala Branislav 24  
 Antekolović Ljubomir 194, 203  
 Antić Nebojša S. 128  
 Arapović Marijana 198  
 Aruin Alexander S. 163  
 Aruković Zulfo 731  
 Ati Abdessatar 601  
 Atiković Almir 219  
 Babajić Fuad 82  
 Babiak Jan 138  
 Babić Vesna 146  
 Baca Arnold 134  
 Bagat Mario 94  
 Baić Mario 111, 496  
 Baković Marijo 194, 203  
 Bala Gustav 570  
 Balent Boris 555, 700  
 Baran Igor 701  
 Barbaros-Tudor Petar 102  
 Barić Renata 230, 375  
 Barišić Valentin 678, 712  
 Barna Tibor 613  
 Barter Phil 495, 575  
 Bartoluci Mato 597, 622  
 Bartoluci Sunčica 379, 403  
 Baščevan Saša 158, 203  
 Bašić Dario 115  
 Bazzo Marina 524  
 Baždarević Dženan 465  
 Bednarik Jakob 580  
 Belčić Ivan 427  
 Beldarrain Maialen 125  
 Béné Raphael 93  
 Benić Jure 207  
 Berčić Herman 31  
 Bianchi Elisa 151  
 Bishop David 23  
 Bjelica Duško 141, 612  
 Blaser Peter 124  
 Blažević Iva 146  
 Bok Daniel 419, 472  
 Boranić-Živoder Snježana 626  
 Bosnar Ksenija 700  
 Božanić Ana 207, 537  
 Bradić Asim 77, 565  
 Bradić Josipa 77, 82  
 Bratinčević Teo 609  
 Breslauer Nevenka 211, 234  
 Bučar Kristina 631  
 Caimmi Gianluca 551  
 Calleja-González Julio 125  
 Campaniço Jorge M. 546  
 Capranica Laura 37  
 Caput-Jogunica Romana 334  
 Ceci Erpić Saša 488  
 Cepková Alena 338, 576  
 Cernaianu Sorina 358  
 Cerović Zdenko 639  
 Ciacci Simone 151, 168  
 Cigrovski Vjekoslav 106, 129  
 Cikatić Branko 573  
 Ciliga Dubravka 62, 67  
 Coakley Jay 38  
 Čavar Ines 326  
 Čeklić Urška 215  
 Čerenšek Igor 375  
 Čižmek Andrea 238  
 Čoh Milan 146  
 Čolakhodžić Ekrem 461  
 Čorak Neven 430  
 Čular Dražen 396  
 Čustonja Zrinko 383, 389  
 Ćurković Sanja 334  
 Delaš Kalinski Sunčica 219, 537  
 Demarin Vida 93  
 Despot Tamara 419, 472  
 Di Michele Rocco 168  
 Dimitriou Lygeri 577  
 Dizdar Dražan 472, 565  
 Dokman Tomislav 451  
 Doll-Tepper Gudrun 39  
 Doupona Topič Mojca 362  
 Drapšin Miodrag 570  
 Dremelj Saša 131  
 Drid Patrik 570  
 Duvač Igor 422  
 Đorđević-Šaranović Slavica A. 128  
 Đukić Branko 408  
 Đurković Tomislav 500  
 Erauzkin Julen 125  
 Erceg Marko 446, 505  
 Eskiler Ersin 407, 410  
 Fantozzi Silvia 168  
 Farina Dario 40  
 Findak Vladimir 223  
 Fiorentini Fredi 115, 712  
 Fjortoft Ingunn 98, 123  
 Fonda Borut 510  
 Foster Charlie 735  
 Fratrić Franja 408, 457  
 Fučkar-Reichel Ksenija 226  
 Furjan-Mandić Gordana 465, 514  
 Gárate Ramón 125  
 Gavrilović Tamara D. 128  
 Georgiev Georgi 141, 612  
 Geržević Mitja 188, 519  
 Glad Tamara 555  
 Golik-Perić Dragana 408, 457  
 Gostović Mladen 130  
 Gošnik Jelka 226  
 Gračan Daniela 614, 618  
 Grant Ian 495, 575  
 Greblo Zrinka 230, 364

- Gregov Cvita 435, 439  
Grgantov Zoran 386, 396  
Grgić Zrinko 389  
Grubišić Frane 94  
Grudić Kvasić Sanda 639  
Gruić Igor 524, 541  
Gutović Dušan 457  
Hamar Dušan 412  
Hamrik Zdenek 736  
Hanin Juri L. 368  
Harasin Dražen 475, 480  
Hečimović Ivana 682  
Heimer Stjepan 741  
Heimer Željko 155  
Heinrichs Kristinn 124  
Hendija Zvezdana 626  
Hoćevar Marija 130  
Hodak Marina 588  
Hodak Zlatko 588  
Hodžić Muhedin 720  
Hoffman R. Jay 41  
Hökermann Anita 124  
Horička Pavol 703  
Horvat Iva 235  
Horvat Vatroslav 234, 235  
Horvatin-Fučkar Maja 682  
Hraski Marijana 235, 260  
Hraski Željko 172, 672  
Husanović Meris 461  
Huskić Salko 731  
Ivančić Ivana 614  
Ivanova Katerina 736  
Ivanović Slobodan 635  
Jakšić Damjan 408  
James Nic 495, 577  
Janković Gordan 102  
Jelaska Igor 446, 505  
Jelešković Edin 695  
Jembrek-Gostović Mirjana 130  
Jenko-Miholić Srna 238, 284  
Jerak Tonči 635  
Jerkunica Alen 605  
Joksimović Aleksandar 678, 712  
Jorge Lorenzo 305  
Jovančević Vojin 408  
Jovanović Mario 480, 662  
Jukić Igor 419  
Jurak Gregor 131, 580  
Jurakić Danijel 364  
Juras Grzegorz 154  
Kadušić Naid 720  
Kafedžić Erduan 573  
Kajmović Husnija 470, 572  
Kalentić Žika 138  
Kalina Roman M. 365  
Kalman Michal 736  
Kapo Safet 573  
Kapur Adis 470  
Kasović Mario 129, 155  
Katica Nađa 470  
Kazazović Besalet 244  
Kazazović Elvir 695  
Kepcija Ivan 700  
Kjoenniksen Lise 123  
Klous Miriam 163  
Knjaz Damir 314  
Kokol Peter 650  
Kolar Edvard 580  
Koprivova Jitka 90  
Koren Katja 245  
Košar N. 677  
Kosor Denis 605  
Kostanić Danijela 276  
Kovač Marjeta 131, 580  
Kovač Petra 131  
Kovač Siniša 687  
Kovačević Erol 77, 82  
Kovačević Josip 94  
Krakan Ivan 267, 692  
Králová Dagmar 95  
Kraml Oto 86  
Krishnan Vennila 163  
Krističević Tomislav 158  
Krstulović Saša 330  
Kudlacek Michal 363  
Kuna Danijela 330  
Kyselovičová Ol'ga 250  
Labudová Jana 250  
Lanza Massimo 259  
Latash Mark L. 163  
Lebed Felix 409  
Lehmann Wolfgang 124  
Leibar Xabier 125  
Leitão José C. 533, 546  
Leko Goran 529  
Lekue Josean 125  
Lesinger Yaman F. 677  
Leščić Stjepka 321  
Likić Slavenko 309  
Loland Sigmund 22, 494  
Lorenzo Jorge 571  
Lorger Marija 260  
Lukenda Željko 687  
Macan Jelena 111  
Mahmutović Ifet 574  
Majstorović Nebojša 570  
Malacko Julijan 251, 279  
Maleček Josef 422  
Maleš Boris 446, 505  
Malkhasyan Eduard 578  
Mandić-Jelaska Petra 115, 219  
Manojlović Vladimir 480  
Marelić Nenad 500  
Marinšek Miha 164  
Markaryan Vartanush 578  
Marković Goran 126  
Marošević Alen 427  
Martin-Diener Eva 734  
Martins Nuno M. 533  
Matejek Črtomir 392  
Matešić Jelena 386, 396  
Matković Andro 120  
Matković Bojan 129  
Matković Branka 106  
Mazić Sanja 128  
McCormick Bryan P. 73  
Medved Vladimir 155  
Mejovšek Mladen 158  
Mejuto Gaizka 125  
Mekić Amel 470, 572  
Mekić Midhat 731  
Merni Franco 168

- Meštrov Marko 127  
 Metikoš Boris 687  
 Michalík Tomáš 416  
 Mikalacki Milena 570  
 Mikulić Pavle 126, 163  
 Milanović Dragan 439, 565  
 Milanović Luka 419  
 Milanović Marko 687  
 Milanović Zoran 678, 712  
 Milenkoski Joško 574  
 Miletić Đurđica 399, 537  
 Mirvić Edin 244, 256  
 Mišigoj-Duraković Marjeta 130, 131  
 Moisiso Valentina 259  
 Mraković Snježana 260  
 Mudronja Lucija 343  
 Muhić Miran 264  
 Müller Erich 42  
 Mumanović Damir 207, 290  
 Musa Ivana 399  
 Mustapić Marko 403  
 Nabršnigg Katarina 120  
 Naglič Vedran 483, 485  
 Naouali Hajer 601  
 Naumovski Angel 62  
 Nedić Antonela 127  
 Neljak Boris 267, 353  
 Nevill Allan M. 126  
 Novak Dario 272, 353  
 Novak Ivan 592  
 Ohnjec Katarina 524, 541  
 Oja Pekka 43  
 Omrčen Darija 597  
 Oreb Goran 276, 321  
 Osmankač Nedžad 574  
 Panjan Andrej 510, 708  
 Pecikoza Jelena 86  
 Pedišić Željko 343, 364  
 Pejčić Aleksandra 251, 279  
 Pense M. 676, 677  
 Perasović Benjamin 403  
 Perić Marko 644  
 Perić Mia 386  
 Peršun Josipa 238, 284  
 Petračić Tin 343  
 Petrić Vilko 353  
 Petrinović Zekan Lidija 67  
 Pezelj Luka 290  
 Pisačić Tomislav 483, 485  
 Pišot Rado 215, 245, 650  
 Pišot Saša 294  
 Planinšec Jurij 392  
 Plavšić Jadranka N. 128  
 Pletenac Ksenija 234  
 Plevnik Matej 215, 297  
 Podnar Hrvoje 267, 272  
 Pokvić Almir 461  
 Popo Almir 244, 461  
 Popov Grigory 578  
 Popović Stevo 141, 612  
 Poturović Admir 461  
 Prlenda Nikola 276  
 Prot Franjo 650  
 Prskalo Ivan 223  
 Psalman Vladimir 422  
 Querin Laura 168  
 Radaš Josipa 514  
 Radman Ivan 102, 106  
 Radošević Ivan 318  
 Radulović Damjan 94  
 Rađenović Ozren 682  
 Rađo Izet 572, 573  
 Rašidagić Faris 300  
 Rauter Samo 362  
 Rebula Andrej 577  
 Rees Gethin 495, 575  
 Rendulić Slivar Senka 86  
 Rešetar Tomica 500  
 Rexhepi Fadil 172  
 Rivilla Jesus 305, 571  
 Roberson, Jr. Donald N. 363, 702  
 Rodić Saša 427, 541  
 Romić Goran 111  
 Rudančić-Lugarić Andreja 618  
 Rupčić Tomislav 120, 127  
 Ružić Lana 129  
 Sampedro Javier 305, 571  
 Sari İhsan 407, 410  
 Sarmiento Hugo M. 533, 546  
 Sattler Tine 574  
 Sebera Martin 422  
 Segedi Ivan 651, 716  
 Semprini Gabriele 551  
 Sertić Hrvoje 651, 716  
 Shaao Mirela 176  
 Sila Boris 31  
 Slomka Kajetan 153, 181  
 Smajlović Nusret 309  
 Smith Rachel L. 73  
 Smoljanović Stipe 605, 609  
 Snethen Gretchen 73  
 Sobry Claude 50, 358, 631  
 Sorić Maroje 130, 131  
 Sovina Leonard 435  
 Soyer Fikret 407, 410  
 Sporiš Goran 667, 672  
 Starc Gregor 131  
 Starosta Włodzimierz 496  
 Strajnić Branislav 138  
 Strel Janko 131  
 Strojnik Vojko 188  
 Sudarov Nenad 138, 408, 457  
 Sukreški Marko 692  
 Šafarić Zlatko 678, 712  
 Šalaj Sanja 435, 439  
 Šarabon Nejc 510, 656  
 Šašek Hrvoje 555  
 Šebić Lejla 198, 465, 514  
 Šentija Davor 667  
 Šiljeg Klara 529  
 Šimonek Jaromir 347  
 Šimunić Boštajn 245, 560  
 Škegro Dario 383, 565  
 Škorić Sanela 584, 622  
 Šopar Josip 475, 484  
 Špehar Natalija 226  
 Štemberger Vesna 314  
 Talović Munir 678, 712  
 Taylor Joe 495, 575  
 Terrados Nicolás 125  
 Tirpáková Veronika 250  
 Tomac Zvonimir 672

Tomanek Lubor 314	Umer Romina 188	Vuori Ilkka 745
Tomić Diana 379	Uvaček Marian 576	Wium Nora 123
Tomić Jozo 692	Vanderka Marián 416	Zadel Zrinka 618
Tomljenović Braco 318	Verunica Zlatko 614	Zagorc Meta 577
Tomljenović Frane 318	Vidranski Tihomir 651, 716	Zaletel Petra 577
Tomljenović-Borer Katarina 55	Vlašić Jadranka 321	Zavoreo Iris 93
Trajković Nebojša 678, 712	Vojinović Jugoslav 138	Zemková Erika 412
Trajkovski Višić Biljana 251, 279	Vrbik Ivan 284	Zhu Weimo 59
Travnikova Dagmar 90	Vrcić Mensur 695	Zoretić Dajana 529
Trivić Tatjana 132	Vučetić Vlatko 451, 667	Zupčić Ivan 272
Trkulja-Petković Drena 67	Vučković Goran 577	Zvonar Martin 422
Trošt Bobić Tatjana 62, 182	Vujanović Snežana 408	Zvonarek Nenad 334
Tudor Anton 129	Vuk Saša 430	Živčić Marković Kamenka 211, 326
Turnagöl H. 676, 677	Vuleta Dinko 524	Žuvela Frane 290, 330





SPONSORS:

***lenovo***



Special thanks to:

**Ivica Olić,**

Croatian national soccer team member

and

**Mirko Cro Cop Filipović,**

ultimate fighting champion (PRIDE tournaments)

for sponsoring

**the Miloš Mraković Young Investigators Award.**



INTEGRATIVE POWER OF KINESIOLOGY IN



9 789533 170138